



# HAC RF TEST REPORT

No. I22Z61533-SEM06

For

**Wingtech Group (Hong Kong) Limited**

**5G Mobile Phone**

**Model Name: Celero5G+**

With

**Hardware Version: V1.0**

**Software Version: Celero5GPlus\_0.01.03**

**FCC ID: 2APXW-CELERO5GPLUS**

**Results Summary: M Category = M3**

**Issued Date: 2022-11-4**

**Note:**

The test results in this test report relate only to the devices specified in this report. This report shall not be reproduced except in full without the written approval of CTTL.

**Test Laboratory:**

**CTTL, Telecommunication Technology Labs, CAICT**

No. 51, Xueyuan Road, Haidian District, Beijing, P. R. China 100191.

Tel:+86(0)10-62304633-2512, Fax:+86(0)10-62304633-2504

Email: [ctl\\_terminals@caict.ac.cn](mailto:ctl_terminals@caict.ac.cn), website: [www.caict.ac.cn](http://www.caict.ac.cn)



No.I22Z61533-SEM06

## **REPORT HISTORY**

<b>Report Number</b>	<b>Revision</b>	<b>Issue Date</b>	<b>Description</b>
I22Z61533-SEM06	Rev.0	2022-11-4	Initial creation of test report



## TABLE OF CONTENT

<b>1 TEST LABORATORY .....</b>	<b>5</b>
1.1 TESTING LOCATION .....	5
1.2 TESTING ENVIRONMENT.....	5
1.3 PROJECT DATA .....	5
1.4 SIGNATURE.....	5
<b>2 CLIENT INFORMATION .....</b>	<b>6</b>
2.1 APPLICANT INFORMATION .....	6
2.2 MANUFACTURER INFORMATION .....	6
<b>3 EQUIPMENT UNDER TEST (EUT) AND ANCILLARY EQUIPMENT (AE) .....</b>	<b>7</b>
3.1 ABOUT EUT .....	7
3.2 INTERNAL IDENTIFICATION OF EUT USED DURING THE TEST .....	7
3.3 INTERNAL IDENTIFICATION OF AE USED DURING THE TEST .....	7
3.4 AIR INTERFACES / BANDS INDICATING OPERATING MODES .....	8
<b>4 MAXIMUM OUTPUT POWER. ....</b>	<b>9</b>
<b>5 REFERENCE DOCUMENTS.....</b>	<b>12</b>
5.1 REFERENCE DOCUMENTS FOR TESTING .....	12
<b>6 OPERATIONAL CONDITIONS DURING TEST .....</b>	<b>13</b>
6.1 HAC MEASUREMENT SET-UP.....	13
6.2 PROBE SPECIFICATION .....	14
6.3 TEST ARCH PHANTOM &PHONE POSITIONER .....	15
6.4 ROBOTIC SYSTEM SPECIFICATIONS .....	15
<b>7 EUT ARRANGEMENT .....</b>	<b>16</b>
7.1 WD RF EMISSION MEASUREMENTS REFERENCE AND PLANE .....	16
<b>8 SYSTEM VALIDATION .....</b>	<b>17</b>
8.1 VALIDATION PROCEDURE .....	17
8.2 VALIDATION RESULT .....	17
<b>9 EVALUATION OF MIF .....</b>	<b>18</b>
9.1 INTRODUCTION.....	18
9.2 MIF MEASUREMENT WITH THE AIA .....	19
9.3 TEST EQUIPMENT FOR THE MIF MEASUREMENT .....	19
9.4 DUT MIF RESULTS.....	19
<b>10 EVALUATION FOR LOW-POWER EXEMPTION .....</b>	<b>21</b>
10.1 PRODUCT TESTING THRESHOLD .....	21
10.2 CONDUCTED POWER.....	21
10.3 CONCLUSION .....	22
<b>11 RF TEST PROCEDURES.....</b>	<b>23</b>



12 MEASUREMENT RESULTS (E-FIELD)..... 24

13 ANSIC 63.19-2011 LIMITS ..... 25

14 MEASUREMENT UNCERTAINTY ..... 26

15 MAIN TEST INSTRUMENTS..... 27

16 CONCLUSION ..... 27

ANNEX A TEST LAYOUT ..... 28

ANNEX B TEST PLOTS ..... 29

ANNEX C SYSTEM VALIDATION RESULT..... 41

ANNEX D PROBE CALIBRATION CERTIFICATE ..... 46

ANNEX E DIPOLE CALIBRATION CERTIFICATE..... 69

## 1 Test Laboratory

### 1.1 Testing Location

CompanyName:	CTTL(Shouxiang)
Address:	No. 51 Shouxiang Science Building, Xueyuan Road, Haidian District, Beijing, P. R. China100191

### 1.2 Testing Environment

Temperature:	18°C~25°C,
Relative humidity:	30%~ 70%
Ground system resistance:	< 0.5 Ω
Ambient noise is checked and found very low and in compliance with requirement of standards. Reflection of surrounding objects is minimized and in compliance with requirement of standards.	

### 1.3 Project Data

Project Leader:	Qi Dianyuan
Test Engineer:	Lin Xiaojun
Testing Start Date:	September 29, 2022
Testing End Date:	October 20, 2022

### 1.4 Signature



Lin Xiaojun  
(Prepared this test report)

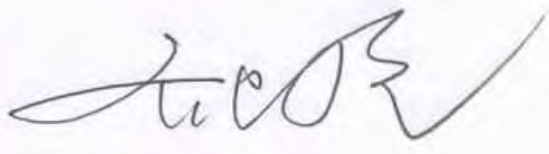

Qi Dianyuan  
(Reviewed this test report)



Lu Bingsong  
Deputy Director of the laboratory  
(Approved this test report)



## 2 Client Information

### 2.1 Applicant Information

HMD Global Oy	Wingtech Group (Hong Kong) Limited
Address/Post:	Flat/RM 1802 18/F, Podium Plaza, 5 Hanoi Road, Tsim Sha Tsui, KL, HK
Contact Person:	sharui
Contact Email:	sharui@wingtech.com
Telephone:	+86-21-53529900
Fax	\

### 2.2 Manufacturer Information

Company Name:	Wingtech Group (Hong Kong) Limited
Address/Post:	Flat/RM 1802 18/F, Podium Plaza, 5 Hanoi Road, Tsim Sha Tsui, KL, HK
Contact Person:	sharui
Contact Email:	sharui@wingtech.com
Telephone:	+86-21-53529900
Fax	\

### 3 Equipment Under Test (EUT) and Ancillary Equipment (AE)

#### 3.1 About EUT

Description:	5G Mobile Phone
Model name:	Celero5G+
Operating mode(s):	GSM850/GSM900/GSM1800/GSM1900 WCDMAB2/B4/B5, 5G NR n2/n5/n25/n26/n29/n30/n41/n48/n66/n70/n71/n77, BT, Wi-Fi, LTE Band 2/4/5/12/14/25/26/29/30/41/48/66/71

#### 3.2 Internal Identification of EUT used during the test

EUT ID*	IMEI	HW Version	SW Version
EUT	869183060031766	V1.0	Celero5GPlus_0.01.03
EUT	869183060031691	V1.0	Celero5GPlus_0.01.03

\*EUT ID: is used to identify the test sample in the lab internally.

#### 3.3 Internal Identification of AE used during the test

AE ID*	Description	Model	SN	Manufacturer
AE1	Battery	TM001	\	Dongguan Veken Battery Co., Ltd.

\*AE ID: is used to identify the test sample in the lab internally.

### 3.4 Air Interfaces / Bands Indicating Operating Modes

Air-interface	Band(MHz)	Type	C63.19/tested	Simultaneous Transmissions	Name of Voice Service
GSM	850	VO	Yes	BT, WLAN	CMRS Voice
	1900				
GPRS/EDGE	850	DT	Yes		Google duo
	1900				
WCDMA (UMTS)	850	VO	NO <sup>(1)</sup>	BT, WLAN	CMRS Voice
	1700				
	1900	DT	NO <sup>(1)</sup>		Google duo
LTE TDD	Band41/48	V/D	Yes	BT, WLAN	VoLTE, Google duo
LTE FDD	Band2/4/5/12/14/25/26/30/66/71	V/D	NO <sup>(1)</sup>	BT, WLAN	VoLTE, Google duo
NR	n2/n5/n25/n26/n30/n41/n48/n66/n70/n71/n77	V/D	NO <sup>(1)</sup>	BT, WLAN	VoNR, Google duo
BT	2450	DT	NA	GSM,WCDMA ,LTE,NR	NA
WLAN	2450	V/D	Yes	GSM,WCDMA ,LTE,NR	VoWiFi, Google duo
WLAN	5G	V/D	NO <sup>(1)</sup>	GSM,WCDMA ,LTE,NR	VoWiFi, Google duo

NA: Not Applicable VO: Voice Only V/D: CMRS and IP Voice Service over Digital Transport  
DT: Digital Transport

\* HAC Rating was not based on concurrent voice and data modes, Non current mode was found to represent worst case rating for both M and T rating

Note1 = The air interface is exempted from testing by low power exemption that its average antenna input power plus its MIF is  $\leq 17$  dBm, and is rated as M4.



#### 4 Maximum Output Power.

<b>GSM 850MHz</b>	<b>Conducted Power (dBm)</b>		
	<b>Channel 251(848.8MHz)</b>	<b>Channel 190(836.6MHz)</b>	<b>Channel 128(824.2MHz)</b>
Voice	33.5	33.5	33.5
EDGE	26.5	26.5	26.5
<b>GSM 1900MHz</b>	<b>Conducted Power(dBm)</b>		
	<b>Channel 810(1909.8MHz)</b>	<b>Channel 661(1880MHz)</b>	<b>Channel 512(1850.2MHz)</b>
Voice	30.5	30.5	30.5
EDGE	25.5	25.5	25.5
<b>WCDMA 850MHz</b>	<b>Conducted Power (dBm)</b>		
	<b>Channel 4233(846.6MHz)</b>	<b>Channel 4182(836.4MHz)</b>	<b>Channel 4132(826.4MHz)</b>
RMC	25	25	25
HSPA	23	23	23
<b>WCDMA 1700MHz</b>	<b>Conducted Power (dBm)</b>		
	<b>Channel1513(1752.6MHz)</b>	<b>Channel1412(1732.4MHz)</b>	<b>Channel1312(1712.4MHz)</b>
RMC	25	25	25
HSPA	23	23	23
<b>WCDMA 1900MHz</b>	<b>Conducted Power (dBm)</b>		
	<b>Channel 9538(1907.6MHz)</b>	<b>Channel 9400(1880MHz)</b>	<b>Channel 9262(1852.4MHz)</b>
RMC	25	25	25
HSPA	23	23	23
<b>LTE Band2 QPSK</b>	<b>Conducted Power (dBm)</b>		
	<b>Channel 19100(1900MHz)</b>	<b>Channel 18900(1880MHz)</b>	<b>Channel18700(1860MHz)</b>
	25.5	25.5	25.5
<b>LTE Band4 QPSK</b>	<b>Conducted Power (dBm)</b>		
	<b>Channel 20300(1745MHz)</b>	<b>Channel 20175(1732.5MHz)</b>	<b>Channel20050(1720MHz)</b>
	25.5	25.5	25.5
<b>LTE Band5 QPSK</b>	<b>Conducted Power (dBm)</b>		
	<b>Channel 20600(844MHz)</b>	<b>Channel 20525(836.5MHz)</b>	<b>Channel20450(829MHz)</b>
	25.5	25.5	25.5
<b>LTE Band12 QPSK</b>	<b>Conducted Power (dBm)</b>		
	<b>Channel 23130(711MHz)</b>	<b>Channel 23095(707.5MHz)</b>	<b>Channel23060(704MHz)</b>
	25.5	25.5	25.5
<b>LTE Band14 QPSK</b>	<b>Conducted Power (dBm)</b>		
	<b>Channel 23330(793MHz)</b>		
	25.5		
<b>LTE Band25 QPSK</b>	<b>Conducted Power (dBm)</b>		
	<b>Channel 26590(1905MHz)</b>	<b>Channel 26365(1882.5MHz)</b>	<b>Channel 26140(1860MHz)</b>
	25.5	25.5	25.5
<b>LTE Band26 QPSK</b>	<b>Conducted Power (dBm)</b>		
	<b>Channel 26965(841.5MHz)</b>	<b>Channel 26865(831.5MHz)</b>	<b>Channel 26775(822.5MHz)</b>

	25.5	25.5	25.5
LTE Band30 QPSK	Conducted Power (dBm)		
	Channel 27710(2310MHz)		
	25.5		
LTE Band41 QPSK PC2	Conducted Power (dBm)		
	Channel 41490(2680MHz)	Channel 40620(2593MHz)	Channel 39750(2506MHz)
	27.5	27.5	27.5
LTE Band41 QPSK PC3	Conducted Power (dBm)		
	Channel 41490(2680MHz)	Channel 40620(2593MHz)	Channel 39750(2506MHz)
	24.5	24.5	24.5
LTE Band48 QPSK	Conducted Power (dBm)		
	Channel 56640	Channel 55990	Channel 55340
	24	24	24
LTE Band66 QPSK	Conducted Power (dBm)		
	Channel 132572(1770MHz)	Channel 132322(1745MHz)	Channel 132072(1720MHz)
	25.5	25.5	25.5
LTE Band71 QPSK	Conducted Power (dBm)		
	Channel 133372(688MHz)	Channel 133322(683MHz)	Channel 133222(673MHz)
	25.5	25.5	25.5
2.4GHz 802.11b	Conducted Power (dBm)		
	Channel 11 (2462MHz)	Channel 6 (2437MHz)	Channel 1 (2412MHz)
	22.5	22.5	22.5
5GHz 802.11a	Tune up (dBm)		
	Channel 60 (5300MHz)	Channel 124 (5620MHz)	Channel 157 (5785MHz)
	20.5	20.5	20.5
5G NR N2	Conducted Power (dBm)		
	Channel381500 (1907.5MHz)	Channel376000 (1880MHz)	Channel370500 (1852.5MHz)
	25	25	25
5G NR N5	Conducted Power (dBm)		
	Channel169300 (846.5MHz)	Channel167300(836.5MHz)	Channel165300(826.5MHz)
	25	25	25
5G NR N25	Conducted Power (dBm)		
	Channel382500 (1912.5MHz)	Channel376500(1882.5MHz)	Channel370500(1852.5MHz)
	25	25	25
5G NR N26	Conducted Power (dBm)		
	Channel169300(846.5MHz)	Channel166300(831.5MHz)	Channel163300(816.5MHz)
	25	25	25
5G NR N30	Conducted Power (dBm)		
	Channel462000(2310MHz)		
	25		
5G NR	Conducted Power (dBm)		

<b>N41 PC2</b>	<b>Channel 528000(2640MHz)</b>	<b>Channel518598(2593MHz)</b>	<b>Channel 509202(2546MHz)</b>
	27.5	27.5	27.5
<b>5G NR N66</b>	<b>Conducted Power (dBm)</b>		
	<b>Channel354000 (1770MHz)</b>	<b>Channel 136100 (680.5MHz)</b>	<b>Channel354000 (1770MHz)</b>
	25	25	25
<b>5G NR N70</b>	<b>Conducted Power (dBm)</b>		
	<b>Channel341500 (1707.5MHz)</b>	<b>Channel 340500 (1702.5MHz)</b>	<b>Channel339500 (1697.5MHz)</b>
	25	25	25
<b>5G NR N71</b>	<b>Conducted Power (dBm)</b>		
	<b>Channel139100 (695.5MHz)</b>	<b>Channel 136100 (680.5MHz)</b>	<b>Channel133100 (665.5MHz)</b>
	25	25	25
<b>5G NR N77 PC2</b>	<b>Conducted Power (dBm)</b>		
	<b>Channel676666 (4149.99MHz)</b>	<b>Channel 650000 (3750MHz)</b>	<b>Channel623334 (3350.01MHz)</b>
	28	28	28

## 5 Reference Documents

### 5.1 Reference Documents for testing

The following document listed in this section is referred for testing.

Reference	Title	Version
ANSI C63.19-2011	American National Standard for Methods of Measurement of Compatibility between Wireless Communication Devices and Hearing Aids	2011 Edition
FCC 47 CFR §20.19	Hearing Aid Compatible Mobile Headsets	2015 Edition
KDB 285076 D01	Equipment Authorization Guidance for Hearing Aid Compatibility	v06

## 6 OPERATIONAL CONDITIONS DURING TEST

### 6.1 HAC MEASUREMENT SET-UP

These measurements are performed using the DASY5 NEO automated dosimetric assessment system. It is made by Schmid & Partner Engineering AG (SPEAG) in Zurich, Switzerland. It consists of high precision robotics system (Stäubli), robot controller, Intel Core2 computer, near-field probe, probe alignment sensor. The robot is a six-axis industrial robot performing precise movements. A cell controller system contains the power supply, robot controller, teach pendant (Joystick), and remote control, is used to drive the robot motors. The PC consists of the HP Intel Core2 1.86 GHz computer with Windows XP system and HAC Measurement Software DASY5 NEO, A/D interface card, monitor, mouse, and keyboard. The Stäubli Robot is connected to the cell controller to allow software manipulation of the robot. A data acquisition electronic (DAE) circuit performs the signal amplification, signal multiplexing, AD-conversion, offset measurements, mechanical surface detection, collision detection, etc. is connected to the Electro-optical coupler (EOC). The EOC performs the conversion from the optical into digital electric signal of the DAE and transfers data to the PC plug-in card.

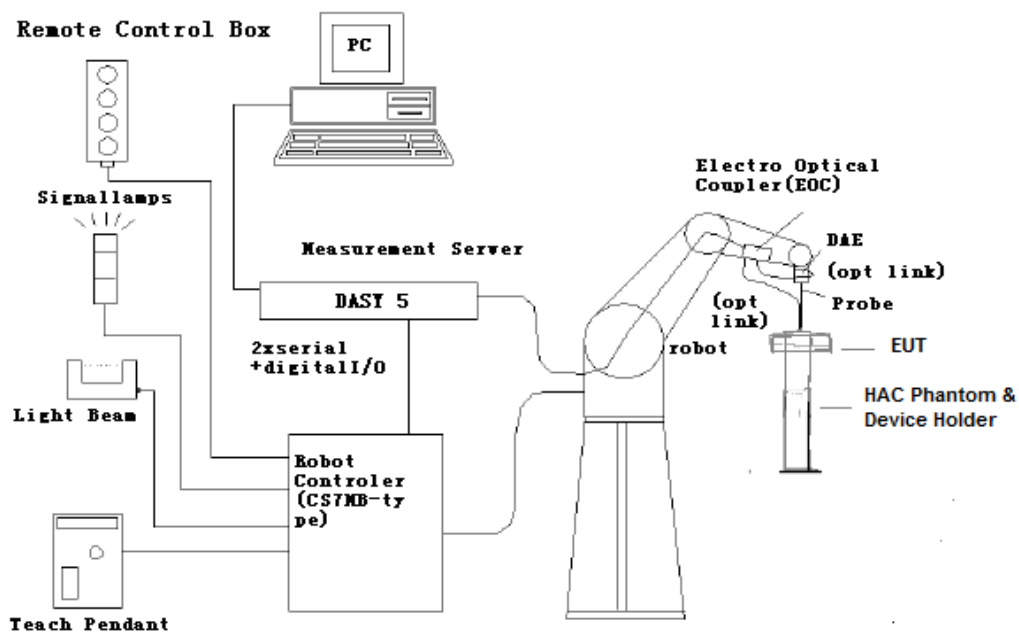

**Fig. 1 HAC Test Measurement Set-up**

The DAE4 consists of a highly sensitive electrometer-grade preamplifier with auto-zeroing, a channel and gain-switching multiplexer, a fast 16 bit AD-converter and a command decoder and control logic unit. Transmission to the PC-card is accomplished through an optical downlink for data and status information and an optical uplink for commands and clock lines. The mechanical probe mounting device includes two different sensor systems for frontal and sidewise probe contacts. They are also used for mechanical surface detection and probe collision detection. The robot uses its own controller with a built in VME-bus computer.

## 6.2 Probe Specification

### E-Field Probe Description

Construction	One dipole parallel, two dipoles normal to probe axis Built-in shielding against static charges PEEK enclosure material
Calibration	In air from 100 MHz to 3.0 GHz (absolute accuracy $\pm 6.0\%$ , $k=2$ )
Frequency	40 MHz to > 6 GHz (can be extended to < 20 MHz) Linearity: $\pm 0.2$ dB (100 MHz to 3 GHz)
Directivity	$\pm 0.2$ dB in air (rotation around probe axis) $\pm 0.4$ dB in air (rotation normal to probe axis)
Dynamic Range	2 V/m to > 1000 V/m; Linearity: $\pm 0.2$ dB
Dimensions	Overall length: 330 mm (Tip: 16 mm) Tip diameter: 8 mm (Body: 12 mm) Distance from probe tip to dipole centers: 2.5 mm
Application	General near-field measurements up to 6 GHz Field component measurements Fast automatic scanning in phantoms



**[ER3DV6]**

### 6.3 Test Arch Phantom & Phone Positioner

The Test Arch phantom should be positioned horizontally on a stable surface. Reference markings on the Phantom allow the complete setup of all predefined phantom positions and measurement grids by manually teaching three points in the robot. It enables easy and well defined positioning of the phone and validation dipoles as well as simple teaching of the robot (Dimensions: 370 x 370 x 370 mm).

The Phone Positioner supports accurate and reliable positioning of any phone with effect on near field  $< \pm 0.5$  dB.

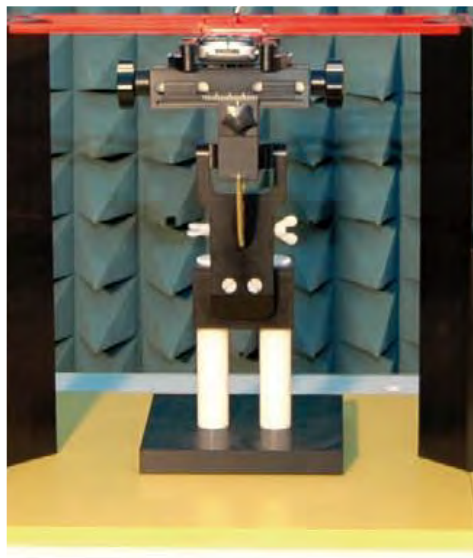

Fig. 2 HAC Phantom & Device Holder

### 6.4 Robotic System Specifications

#### Specifications

**Positioner:** Stäubli Unimation Corp. Robot Model: RX160L

**Repeatability:**  $\pm 0.02$  mm

**No. of Axis:** 6

#### Data Acquisition Electronic (DAE) System

##### Cell Controller

**Processor:** Intel Core2

**Clock Speed:** 1.86GHz

**Operating System:** Windows XP

##### Data Converter

**Features:** Signal Amplifier, multiplexer, A/D converter, and control logic

**Software:** DASY5 software

**Connecting Lines:** Optical downlink for data and status info.

Optical uplink for commands and clock

## 7 EUT ARRANGEMENT

### 7.1 WD RF Emission Measurements Reference and Plane

Figure 4 illustrates the references and reference plane that shall be used in the WD emissions measurement.

- The grid is 5 cm by 5 cm area that is divided into 9 evenly sized blocks or sub-grids.
- The grid is centered on the audio frequency output transducer of the WD (speaker or T-coil).
- The grid is located by reference to a reference plane. This reference plane is the planar area that contains the highest point in the area of the WD that normally rests against the user's ear
- The measurement plane is located parallel to the reference plane and 15 mm from it, out from the phone. The grid is located in the measurement plane.

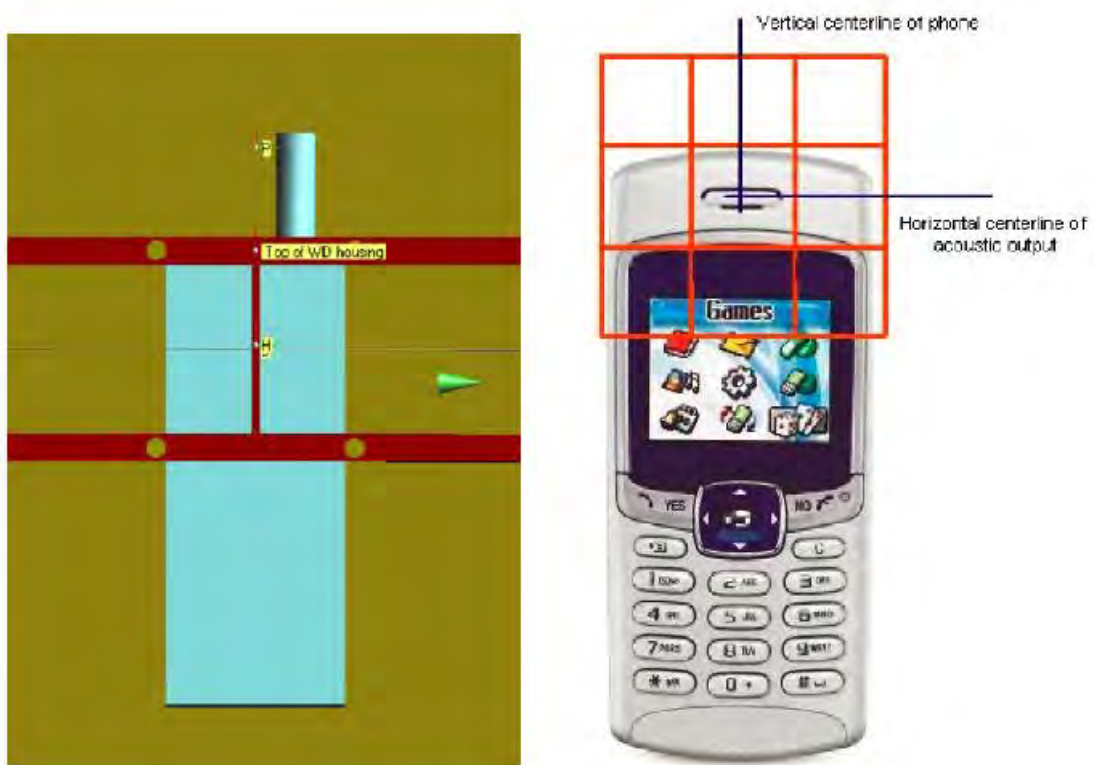

**Fig. 3 WD reference and plane for RF emission measurements**



## 8 SYSTEM VALIDATION

### 8.1 Validation Procedure

Place a dipole antenna meeting the requirements given in ANSI C63.19 in the position normally occupied by the WD. The dipole antenna serves as a known source for an electrical output. Position the E-field probes so that:

- The probes and their cables are parallel to the coaxial feed of the dipole antenna
- The probe cables and the coaxial feed of the dipole antenna approach the measurement area from opposite directions
- The center point of the probe element(s) are 15 mm from the closest surface of the dipole elements.

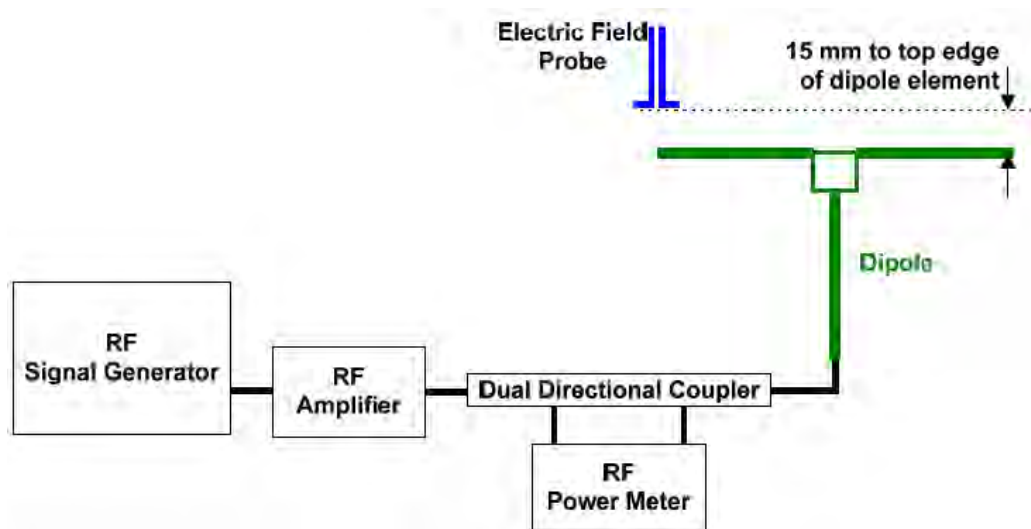

Fig. 4 Dipole Validation Setup

### 8.2 Validation Result

E-Field Scan						
Mode	Frequency (MHz)	Input Power (mW)	Measured <sup>1</sup> Value(dBV/m)	Target <sup>2</sup> Value(dBV/m)	Deviation <sup>3</sup> (%)	Limit <sup>4</sup> (%)
CW	835	100	41.19	41	2.21	± 25
CW	1880	100	38.92	38.78	1.62	± 25
CW	2450	100	38.19	38.69	-5.59	± 25
CW	2600	100	38.23	38.69	-5.16	± 25
CW	3500	100	38.43	38.59	-1.83	± 25

Notes:

1. Please refer to the attachment for detailed measurement data and plot.
2. Target value is provided by SPEAD in the calibration certificate of specific dipoles.
3. Deviation (%) =  $100 * (\text{Measured value minus Target value}) / \text{Target value}$ .
4. ANSI C63.19 requires values within  $\pm 25\%$  are acceptable, of which 12% is deviation and 13% is measurement uncertainty. Values independently validated for the dipole actually used in the measurements should be used, when available.

## 9 Evaluation of MIF

### 9.1 Introduction

The MIF (Modulation Interference Factor) is used to classify E-field emission to determine Hearing Aid Compatibility (HAC). It scales the power-averaged signal to the RF audio interference level and is characteristic to a modulation scheme. The HAC standard preferred "indirect" measurement method is based on average field measurement with separate scaling by the MIF. With an Audio Interference Analyzer (AIA) designed by SPEAG specifically for the MIF measurement, these values have been verified by practical measurements on an RF signal modulated with each of the waveforms. The resulting deviations from the simulated values are within the requirements of the HAC standard.

The AIA (Audio Interference Analyzer) is an USB powered electronic sensor to evaluate signals in the frequency range 698MHz - 6 GHz. It contains RMS detector and audio frequency circuits for sampling of the RF envelope.

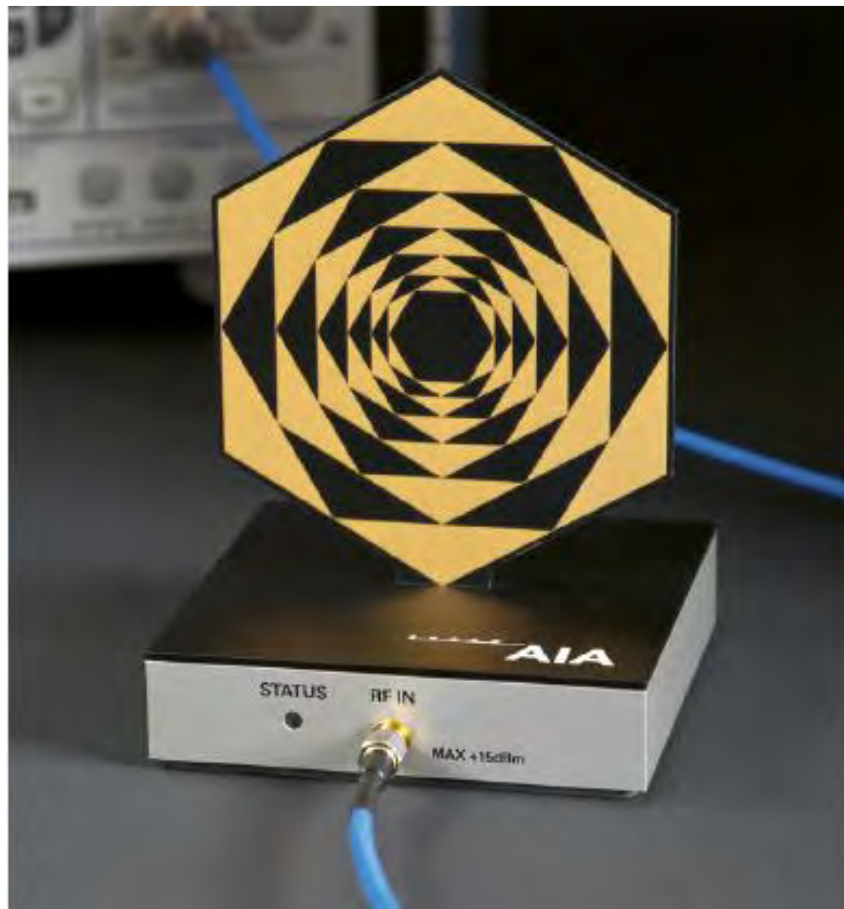

Fig. 5 AIA Front View

## 9.2 MIF measurement with the AIA

The MIF is measured with the AIA as follows:

1. Connect the AIA via USB to the DASY5 PC and verify the configuration settings.
2. Couple the RF signal to be evaluated to an AIA via cable or antenna.
3. Generate a MIF measurement job for the unknown signal and select the measurement port and timing settings.
4. Document the results via the post processor in a report.

## 9.3 Test equipment for the MIF measurement

No.	Name	Type	Serial Number	Manufacturer
01	Signal Generator	E4438C	MY49071430	Agilent
02	AIA	SE UMS 170 CB	1029	SPEAG
03	BTS	CMW500	166370	R&S

## 9.4 DUT MIF results

Based on the KDB285076D01v05, the handset can also use the MIF values predetermined by the test equipment manufacturer. MIF values applied in this test report were provided by the HAC equipment provider of SPEAG, and the worst values for all air interface are listed below to be determine the Low-power Exemption.

Typical MIF levels in ANSI C63.19-2011	
Transmission protocol	Modulation interference factor
GSM-FDD (TDMA, GMSK)	+3.63 dB
EDGE-FDD (TDMA, 8PSK, TN 0-1)	+1.23dB
EDGE-FDD (TDMA, 8PSK, TN 0-1-2)	-0.52dB
EDGE-FDD (TDMA, 8PSK, TN 0-1-2-3)	-1.82dB
UMTS-FDD(WCDMA, AMR)	-25.43dB
UMTS-FDD (HSPA)	-20.75dB
LTE-FDD (SC-FDMA, 1RB, 20MHz, QPSK)	-15.63 dB
LTE-FDD (SC-FDMA, 1RB, 20MHz, 16QAM)	-9.76 dB
LTE-FDD (SC-FDMA, 1RB, 20MHz, 64QAM)	-9.93 dB
LTE-TDD (SC-FDMA, 1RB, 20MHz, QPSK)	-1.62 dB
LTE-TDD (SC-FDMA, 1RB, 20MHz, 16QAM)	-1.44 dB
LTE-TDD (SC-FDMA, 1RB, 20MHz, 64QAM)	-1.54 dB
LTE-TDD(SC-FDMA,1RB,20MHz,QPSK,UL Subframe=2,3,4,7,8,9)	-3.41 dB
LTE-TDD(SC-FDMA,1RB,20MHz,16QAM,UL Subframe=2,3,4,7,8,9)	-3.17 dB
LTE-TDD(SC-FDMA,1RB,20MHz,64QAM,UL Subframe=2,3,4,7,8,9)	-3.31 dB
IEEE 802.11b WiFi 2.4 GHz (DSSS, 1 Mbps)	-5.90 dB
IEEE 802.11b WiFi 2.4 GHz (DSSS, 2 Mbps)	-5.17 dB

IEEE 802.11b WiFi 2.4 GHz (DSSS, 5.5 Mbps)	-3.37 dB
IEEE 802.11b WiFi 2.4 GHz (DSSS, 11 Mbps)	-2.02 dB
IEEE 802.11g WiFi 2.4 GHz (DSSS-OFDM, 6 Mbps)	-0.36dB
IEEE 802.11n (HT Greenfield, 6.5 Mbps, BPSK)	-15.80 dB
IEEE 802.11a/h WiFi 5 GHz (OFDM, 6 Mbps)	-5.82 dB
IEEE 802.11ac WiFi (20MHz, MCS0, 99pc duty cycle)	-12.23dB
5G NR (DFT-s-OFDM, 1 RB, 20 MHz, QPSK, 15 kHz)	-15.06dB
5G NR (CP-OFDM, 1 RB, 5 MHz, QPSK, 15 kHz)	-12.18dB
5G NR (CP-OFDM, 1 RB, 10 MHz, QPSK, 15 kHz)	-12.26dB
5G NR (CP-OFDM, 1 RB, 15 MHz, QPSK, 15 kHz)	-12.08dB
5G NR (CP-OFDM, 1 RB, 20 MHz, QPSK, 15 kHz)	-12.20dB
5G NR (CP-OFDM, 1 RB, 5 MHz, QPSK, 30 kHz)	-14.39dB
5G NR (CP-OFDM, 1 RB, 10 MHz, QPSK, 30 kHz)	-14.47dB
5G NR (CP-OFDM, 1 RB, 15 MHz, QPSK, 30 kHz)	-14.33dB
5G NR (CP-OFDM, 1 RB, 20 MHz, QPSK, 30 kHz)	-14.46dB
5G NR (CP-OFDM, 1 RB, 25 MHz, QPSK, 30 kHz)	-14.35dB
5G NR (CP-OFDM, 1 RB, 30 MHz, QPSK, 30 kHz)	-14.32dB
5G NR (CP-OFDM, 1 RB, 40 MHz, QPSK, 30 kHz)	-14.32dB
5G NR (CP-OFDM, 1 RB, 50 MHz, QPSK, 30 kHz)	-14.55dB
5G NR (CP-OFDM, 1 RB, 60 MHz, QPSK, 30 kHz)	-14.45dB
5G NR (CP-OFDM, 1 RB, 80 MHz, QPSK, 30 kHz)	-14.47dB
5G NR (CP-OFDM, 1 RB, 90 MHz, QPSK, 30 kHz)	-14.43dB
5G NR (CP-OFDM, 1 RB, 100 MHz, QPSK, 30 kHz)	-14.38dB
5G NR (DFT-s-OFDM, 1 RB, 5 MHz, QPSK, 15 kHz)	-15.06dB
5G NR (DFT-s-OFDM, 1 RB, 10 MHz, QPSK, 15 kHz)	-15.06dB
5G NR (DFT-s-OFDM, 1 RB, 15 MHz, QPSK, 15 kHz)	-15.06dB
5G NR (DFT-s-OFDM, 1 RB, 20 MHz, QPSK, 15 kHz)	-15.06dB

## 10 Evaluation for low-power exemption

### 10.1 Product testing threshold

There are two methods for exempting an RF air interface technology from testing. The first method requires evaluation of the MIF for the worst-case operating mode. An RF air interface technology of a device is exempt from testing when its average antenna input power plus its MIF is  $\leq 17$  dBm for any of its operating modes. The second method does not require determination of the MIF. The RF emissions testing exemption shall be applied to an RF air interface technology in a device whose peak antenna input power, averaged over intervals  $\leq 50 \mu s$ , is  $\leq 23$  dBm. An RF air interface technology that is exempted from testing by either method shall be rated as M4.

The first method is used to be exempt from testing for the RF air interface technology in this report.

### 10.2 Conducted power

Band	Average power (dBm)	MIF (dB)	Sum (dBm)	C63.19 Tested
GSM 850 - Voice	33.5	3.63	37.13	Yes
GSM 850 - EDGE	26.5	-1.82	24.68	Yes*
GSM 1900 - Voice	30.5	3.63	34.13	Yes
GSM 1900 - EDGE	25.5	-1.82	23.68	Yes*
WCDMA 850 - RMC	25	-25.43	-0.43	No
WCDMA 850 - HSPA	23	-20.75	2.25	No
WCDMA 1700 - RMC	25	-25.43	-0.43	No
WCDMA 1700 - HSPA	23	-20.75	2.25	No
WCDMA 1900 - RMC	25	-25.43	-0.43	No
WCDMA 1900 - HSPA	23	-20.75	2.25	No
LTE Band 2 QPSK	25.5	-15.63	9.87	No
LTE Band 4 QPSK	25.5	-15.63	9.87	No
LTE Band 5 QPSK	25.5	-15.63	9.87	No
LTE Band 12 QPSK	25.5	-15.63	9.87	No
LTE Band 14 QPSK	25.5	-15.63	9.87	No
LTE Band 25 QPSK	25.5	-15.63	9.87	No
LTE Band 26 QPSK	25.5	-15.63	9.87	No
LTE Band 30 QPSK	25.5	-15.63	9.87	No
LTE Band 66 QPSK	25.5	-15.63	9.87	No
LTE Band 71 QPSK	25.5	-15.63	9.87	No
LTE Band 41 QPSK PC2	27.5	-3.41	24.09	Yes
LTE Band 41 QPSK PC3	24.5	-3.41	21.09	Yes
LTE Band 48 QPSK	24	-3.41	20.59	Yes
NR n2	25	-12.08	12.92	No
NR n5	25	-12.08	12.92	No

NR n25	25	-12.08	12.92	No
NR n26	25	-12.08	12.92	No
NR n30	25	-12.08	12.92	No
NR n41 PC2	27.5	-12.08	15.42	No
NR n66	25	-12.08	12.92	No
NR n70	25	-12.08	12.92	No
NR n71	25	-12.08	12.92	No
NR n77 PC2	28	-12.08	15.92	No
WiFi-2.4G	22.5	-2.02	20.48	Yes
WiFi-5G	20.5	-5.82	14.68	No

### 10.3 Conclusion

According to the above table, the sums of average power and MIF for WCDMA, LTE FDD WIFI 5G and NR are less than 17dBm. So it is measured for GSM and LTE TDD bands and WIFI2.4G. The WCDMA, LTE FDD WiFi 5G and NR are exempt from testing and rated as M4.

## 11 RF TEST PROCEDURES

**The evaluation was performed with the following procedure:**

- 1) Confirm proper operation of the field probe, probe measurement system and other instrumentation and the positioning system.
- 2) Position the WD in its intended test position. The gauge block can simplify this positioning.
- 3) Configure the WD normal operation for maximum rated RF output power, at the desired channel and other operating parameters (e.g., test mode), as intended for the test.
- 4) The center sub-grid shall be centered on the center of the T-Coil mode axial measurement point or the acoustic output, as appropriate. Locate the field probe at the initial test position in the 50 mm by 50 mm grid, which is contained in the measurement plane. If the field alignment method is used, align the probe for maximum field reception.
- 5) Record the reading.
- 6) Scan the entire 50 mm by 50 mm region in equally spaced increments and record the reading at each measurement point. The distance between measurement points shall be sufficient to assure the identification of the maximum reading.
- 7) Identify the five contiguous sub-grids around the center sub-grid whose maximum reading is the lowest of all available choices. This eliminates the three sub-grids with the maximum readings. Thus, the six areas to be used to determine the WD's highest emissions are identified.
- 8) Identify the maximum field reading within the non-excluded sub-grids identified in Step 7)
- 9) Evaluate the MIF and add to the maximum steady-state rms field-strength reading to obtain the RF audio interference level..
- 10) Compare this RF audio interference level with the categories and record the resulting WD category rating.

## 12 Measurement Results (E-Field)

Frequency		Measured Value(dBV/m)	Power Drift (dB)	Category
MHz	Channel			
<b>GSM 850</b>				
848.8	251	35.68	-0.00	<b>M4</b> (see Fig B.1)
836.6	190	34.77	-0.02	<b>M4</b>
824.2	128	33.97	0.01	<b>M4</b>
<b>GSM 1900</b>				
1909.8	810	26.83	-0.04	<b>M4</b>
1880	661	26.98	0.17	<b>M4</b>
1850.2	512	27.14	-0.11	<b>M4</b> (see Fig B.2)
<b>LTE Band 41 PC2 QPSK</b>				
2680	41490	30.23	-0.12	<b>M3</b>
2636.5	41055	31.54	-0.04	<b>M3</b>
2593	40620	32.03	0.10	<b>M3</b> (see Fig B.3)
2549.5	40185	31.07	0.06	<b>M3</b>
2506	39750	31.22	0.03	<b>M3</b>
<b>LTE Band 41 PC2 16QAM</b>				
2680	41490	29.64	-0.01	<b>M4</b>
2636.5	41055	30.69	-0.02	<b>M3</b>
2593	40620	30.72	0.03	<b>M3</b>
2549.5	40185	30.37	0.01	<b>M3</b>
2506	39750	30.54	0.02	<b>M3</b>
<b>LTE Band 41 PC2 64QAM</b>				
2680	41490	31.03	0.14	<b>M3</b>
2636.5	41055	30.92	0.09	<b>M3</b>
2593	40620	30.96	0.05	<b>M3</b>
2549.5	40185	29.35	0.04	<b>M4</b>
2506	39750	29.50	0.03	<b>M4</b>
<b>LTE Band 41 PC3 QPSK</b>				
2680	41490	30.43	0.09	<b>M3</b>
2636.5	41055	31.08	0.07	<b>M3</b>
2593	40620	31.11	0.04	<b>M3</b> (see Fig B.4)
2549.5	40185	30.53	0.03	<b>M3</b>
2506	39750	30.80	0.15	<b>M3</b>
<b>LTE Band 41 PC3 16QAM</b>				
2680	41490	30.12	0.04	<b>M3</b>
2636.5	41055	30.41	0.16	<b>M3</b>
2593	40620	30.49	0.15	<b>M3</b>
2549.5	40185	30.17	0.13	<b>M3</b>
2506	39750	30.14	0.16	<b>M3</b>
<b>LTE Band 41 PC3 64QAM</b>				



2680	41490	29.66	0.14	<b>M4</b>
2636.5	41055	29.67	0.05	<b>M4</b>
2593	40620	29.47	0.07	<b>M4</b>
2549.5	40185	29.16	-0.01	<b>M4</b>
2506	39750	29.37	0.04	<b>M4</b>
<b>LTE Band 48 QPSK</b>				
3690	56640	28.83	-0.03	<b>M4</b>
3625	55990	28.83	-0.02	<b>M4</b>
3560	55340	28.70	-0.00	<b>M4</b>
<b>LTE Band 48 16QAM</b>				
3690	56640	28.72	-0.02	<b>M4</b>
3625	55990	28.90	0.08	<b>M4</b> (see Fig B.5)
3560	55340	27.80	0.06	<b>M4</b>
<b>LTE Band 48 64QAM</b>				
3690	56640	27.61	0.03	<b>M4</b>
3625	55990	27.38	0.02	<b>M4</b>
3560	55340	26.54	-0.00	<b>M4</b>
<b>WiFi2.4G 11b</b>				
2462	11	22.98	0.02	<b>M4</b>
2437	6	22.30	-0.03	<b>M4</b>
2412	1	23.34	0.03	<b>M4</b> (see Fig B.6)

Note: For LTE Band 41, UL-DL Configuration 1 was used to evaluate Power Class 2 and UL-DL Configuration 1 was used to evaluate Power Class 3.

## 13 ANSIC 63.19-2011 LIMITS

### WD RF audio interference level categories in logarithmic units

Emission categories	< 960 MHz	E-field emissions
Category M1	50 to 55	dB (V/m)
Category M2	45 to 50	dB (V/m)
Category M3	40 to 45	dB (V/m)
Category M4	< 40	dB (V/m)
Emission categories	> 960 MHz	E-field emissions
Category M1	40 to 45	dB (V/m)
Category M2	35 to 40	dB (V/m)
Category M3	30 to 35	dB (V/m)
Category M4	< 30	dB (V/m)

## 14 MEASUREMENT UNCERTAINTY

No.	Error source	Type	Uncertainty Value(%)	Prob. Dist.	k	c <sub>i</sub> E	Standard Uncertainty (%) $u_i$ ; (%)E	Degree of freedom $V_{eff}$ or $\nu_i$
<b>Measurement System</b>								
1	Probe Calibration	B	5.	N	1	1	5.1	$\infty$
2	Axial Isotropy	B	4.7	R	$\sqrt{3}$	1	2.7	$\infty$
3	Sensor Displacement	B	16.5	R	$\sqrt{3}$	1	9.5	$\infty$
4	Boundary Effects	B	2.4	R	$\sqrt{3}$	1	1.4	$\infty$
5	Linearity	B	4.7	R	$\sqrt{3}$	1	2.7	$\infty$
6	Scaling to Peak Envelope Power	B	2.0	R	$\sqrt{3}$	1	1.2	$\infty$
7	System Detection Limit	B	1.0	R	$\sqrt{3}$	1	0.6	$\infty$
8	Readout Electronics	B	0.3	N	1	1	0.3	$\infty$
9	Response Time	B	0.8	R	$\sqrt{3}$	1	0.5	$\infty$
10	Integration Time	B	2.6	R	$\sqrt{3}$	1	1.5	$\infty$
11	RF Ambient Conditions	B	3.0	R	$\sqrt{3}$	1	1.7	$\infty$
12	RF Reflections	B	12.0	R	$\sqrt{3}$	1	6.9	$\infty$
13	Probe Positioner	B	1.2	R	$\sqrt{3}$	1	0.7	$\infty$
14	Probe Positioning	A	4.7	R	$\sqrt{3}$	1	2.7	$\infty$
15	Extra. And Interpolation	B	1.0	R	$\sqrt{3}$	1	0.6	$\infty$
<b>Test Sample Related</b>								
16	Device Positioning Vertical	B	4.7	R	$\sqrt{3}$	1	2.7	$\infty$
17	Device Positioning Lateral	B	1.0	R	$\sqrt{3}$	1	0.6	$\infty$
18	Device Holder and Phantom	B	2.4	R	$\sqrt{3}$	1	1.4	$\infty$
19	Power Drift	B	5.0	R	$\sqrt{3}$	1	2.9	$\infty$

20	AIA measurement	B	12	R	$\sqrt{3}$	1	6.9	$\infty$
<b>Phantom and Setup related</b>								
21	Phantom Thickness	B	2.4	R	$\sqrt{3}$	1	1.4	$\infty$
Combined standard uncertainty(%)							16.2	
Expanded uncertainty (confidence interval of 95 %)		$u_e = 2u_c$		N	k=2		32.4	

## 15 MAIN TEST INSTRUMENTS

**Table 1: List of Main Instruments**

No.	Name	Type	Serial Number	Calibration Date	Valid Period
01	Signal Generator	E4483C	MY49071430	January 13, 2022	One Year
02	Power meter	NRP2	106276	May 10, 2022	One year
03	Power sensor	NRP6A	101369		
04	Amplifier	60S1G4	0331848	No Calibration Requested	
05	E-Field Probe	EF3DV3	4060	May 13, 2022	One year
06	DAE	SPEAG DAE4	1524	October 08, 2021	One year
07	HAC Dipole	CD835V3	1023	August 25, 2022	One year
08	HAC Dipole	CD1880V3	1018	August 25, 2022	One year
09	HAC Dipole	CD2450V3	1021	August 25, 2022	One year
10	HAC Dipole	CD2600V3	1017	August 25, 2022	One year
11	HAC Dipole	CD3500V3	1008	August 25, 2022	One year
12	BTS	CMW500	166370	June 28,2022	One year
13	AIA	SE UMS 170 CB	1029	No Calibration Requested	

## 16 CONCLUSION

The HAC measurement indicates that the EUT complies with the HAC limits of the ANSIC63.19-2011. The total M-rating is **M3**.

\*\*\*END OF REPORT BODY\*\*\*

## ANNEX A TEST LAYOUT

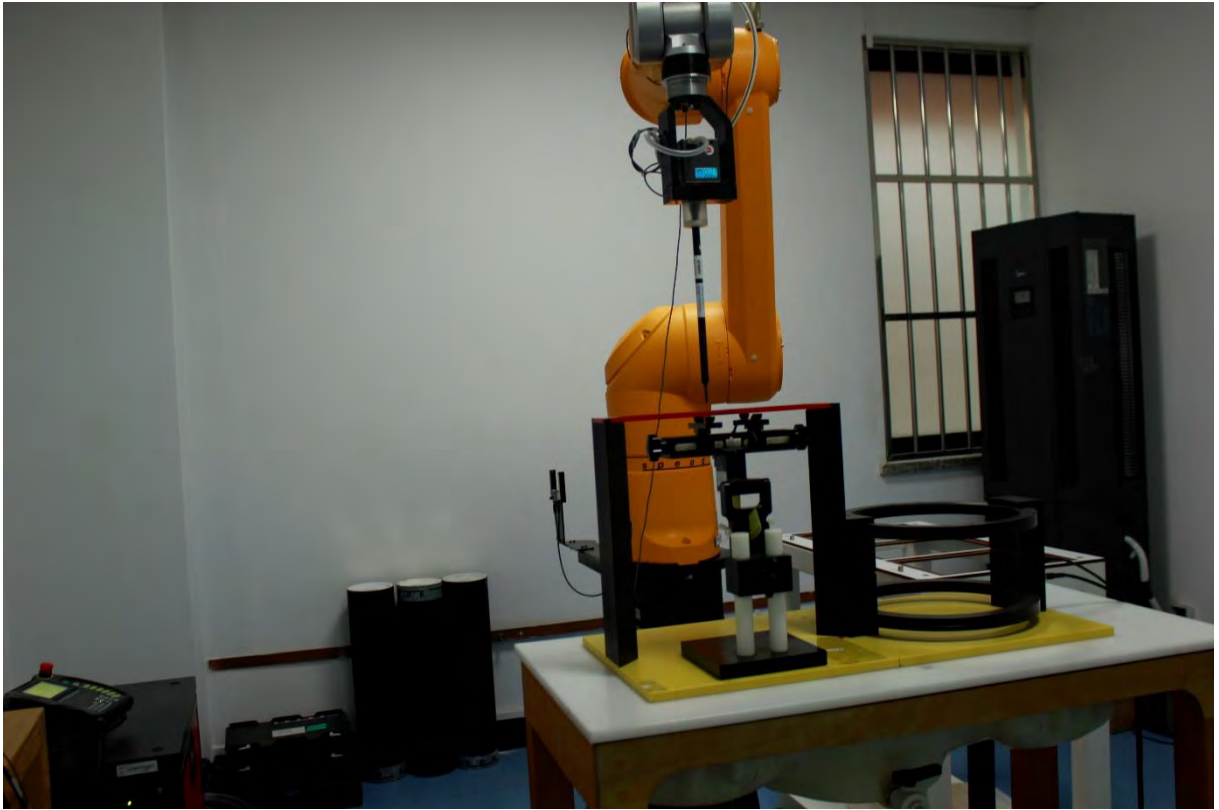

Picture A1:HAC RF System Layout

## ANNEX B TEST PLOTS

### HAC RF E-Field GSM 850

Date/Time: 2022-09-29

Electronics: DAE4 Sn1524

Medium: Air

Medium parameters used:  $\sigma = 0$  S/m,  $\epsilon_r = 1$ ;  $\rho = 1000$  kg/m<sup>3</sup>

Ambient Temperature: 23.3°C      Liquid Temperature: 22.5°C

Communication System: UID 0, 1GSM 850 (0) Frequency: 848.8 MHz Duty Cycle: 1:8.3

Probe: EF3DV3 - SN4060

E Scan - ER3DV6 - 2011: 15 mm from Probe Center to the Device

3/Hearing Aid Compatibility Test (101x101x1): Interpolated grid:

dx=0.5000 mm, dy=0.5000 mm

Device Reference Point: 0, 0, -6.3 mm

Reference Value = 50.74 V/m; Power Drift = -0.00 dB

Applied MIF = 3.43 dB

RF audio interference level = 35.68 dBV/m

Emission category: **M4**

MIF scaled E-field

Grid 1 <b>M4</b> 35.42 dBV/m	Grid 2 <b>M4</b> 35.62 dBV/m	Grid 3 <b>M4</b> 34.81 dBV/m
Grid 4 <b>M4</b> 35.44 dBV/m	Grid 5 <b>M4</b> 35.68 dBV/m	Grid 6 <b>M4</b> 34.9 dBV/m
Grid 7 <b>M4</b> 35.43 dBV/m	Grid 8 <b>M4</b> 35.65 dBV/m	Grid 9 <b>M4</b> 34.92 dBV/m

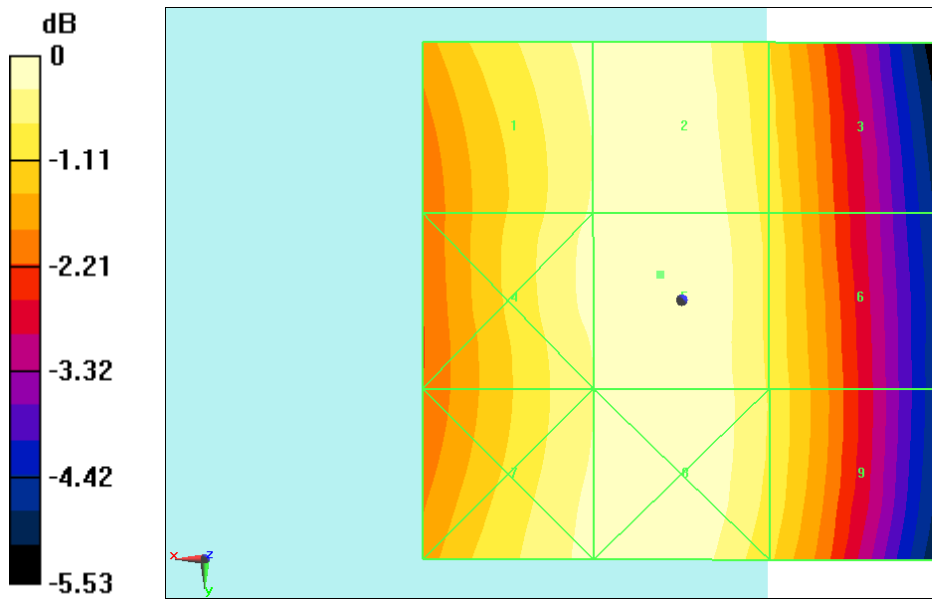

0 dB = 60.80 V/m = 35.68 dBV/m

**Fig B.1 HAC RF E-Field GSM 850**

**HAC RF E-Field GSM 1900**

Date: 2022-09-29

Electronics: DAE4 Sn1524

Medium: Air

Medium parameters used:  $\sigma = 0$  mho/m,  $\epsilon_r = 1$ ;  $\rho = 1000$  kg/m<sup>3</sup>

Ambient Temperature: 22.0°C

Communication System:GSM1900; Frequency: 1850.2 MHz; Duty Cycle: 1:8.3

Probe: EF3DV3 - SN4060;ConvF(1, 1, 1)

E Scan - ER3DV6 - 2011: 15 mm from Probe Center to the Device 2 2

2 2/Hearing Aid Compatibility Test (101x101x1): Interpolated grid:

dx=0.5000 mm, dy=0.5000 mm

Device Reference Point: 0, 0, -6.3 mm

Reference Value = 10.02 V/m; Power Drift = -0.11 dB

Applied MIF = 3.49 dB

RF audio interference level = 27.14 dBV/m

Emission category: **M4**

MIF scaled E-field

Grid 1 <b>M4</b> 27.45 dBV/m	Grid 2 <b>M4</b> 27.87 dBV/m	Grid 3 <b>M4</b> 27.36 dBV/m
Grid 4 <b>M4</b> 22.55 dBV/m	Grid 5 <b>M4</b> 24.32 dBV/m	Grid 6 <b>M4</b> 24.17 dBV/m
Grid 7 <b>M4</b> 26.45 dBV/m	Grid 8 <b>M4</b> 27.14 dBV/m	Grid 9 <b>M4</b> 26.5 dBV/m

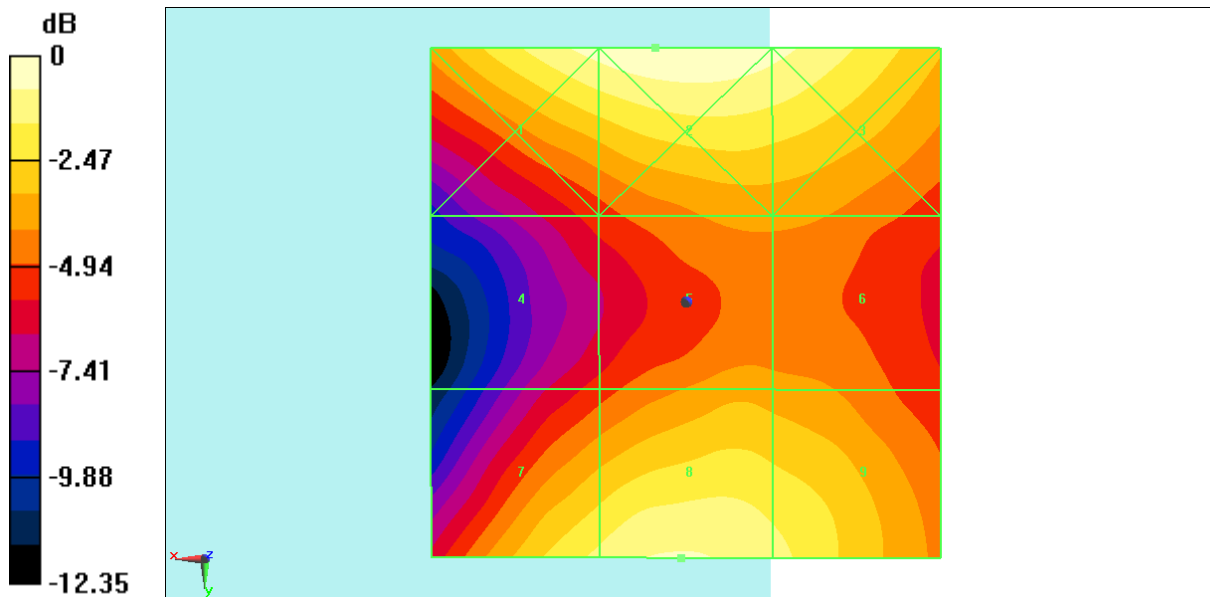

0 dB = 24.75 V/m = 27.87 dBV/m

**Fig B.2 HAC RF E-Field GSM1900**



**HAC RF E-Field LTE Band41 PC2 QPSK**

Date: 2022-10-03

Electronics: DAE4 Sn1524

Medium: Air

Medium parameters used:  $\sigma = 0$  mho/m,  $\epsilon_r = 1$ ;  $\rho = 1000$  kg/m<sup>3</sup>

Ambient Temperature: 22.0°C

Communication System: LTE Band41; Frequency: 2593MHz; Duty Cycle: 1:1.58

Probe: EF3DV3 - SN4060;ConvF(1, 1, 1)

E Scan - ER3DV6 - 2011: 15 mm from Probe Center to the Device

**3/Hearing Aid Compatibility Test (101x101x1):** Interpolated grid:

dx=0.5000 mm, dy=0.5000 mm

Device Reference Point: 0, 0, -6.3 mm

Reference Value = 44.58 V/m; Power Drift = 0.10 dB

Applied MIF = -1.74 dB

RF audio interference level = 32.03 dBV/m

**Emission category: M3**

MIF scaled E-field

Grid 1 <b>M3</b> 34.1 dBV/m	Grid 2 <b>M3</b> 34.39 dBV/m	Grid 3 <b>M3</b> 33.6 dBV/m
Grid 4 <b>M3</b> 31.28 dBV/m	Grid 5 <b>M3</b> 32.03 dBV/m	Grid 6 <b>M3</b> 31.91 dBV/m
Grid 7 <b>M4</b> 25.26 dBV/m	Grid 8 <b>M4</b> 26.05 dBV/m	Grid 9 <b>M4</b> 26.03 dBV/m

**Cursor:**

Total = 34.39 dBV/m

E Category: M3

Location: 1, -25, 7.7 mm

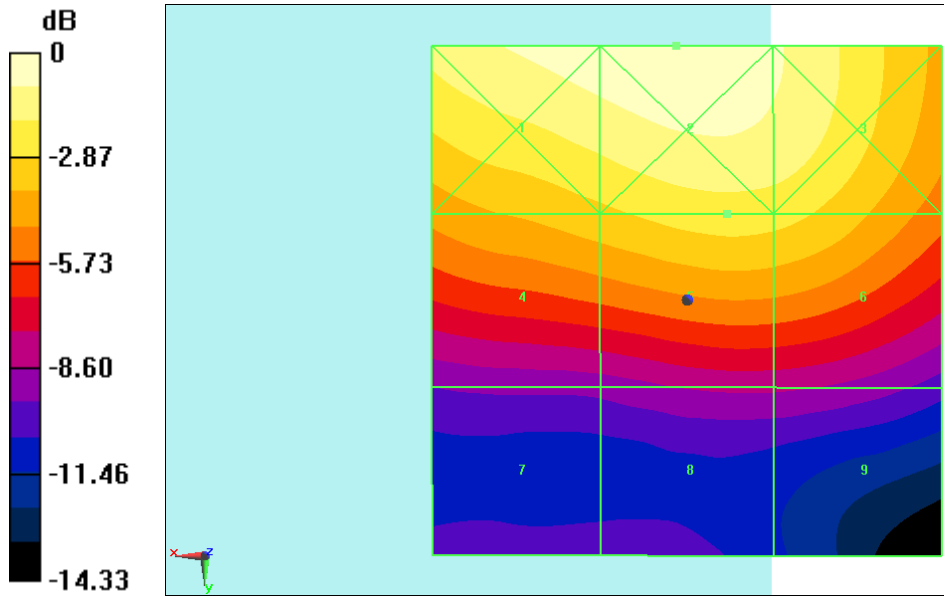

0 dB = 52.44 V/m = 34.39 dBV/m

**Fig B.3 HAC RF E-Field LTE Band41 PC2 QPSK**

**HAC RF E-Field LTE Band41 PC3 QPSK**

Date: 2022-10-03

Electronics: DAE4 Sn1524

Medium: Air

Medium parameters used:  $\sigma = 0$  mho/m,  $\epsilon_r = 1$ ;  $\rho = 1000$  kg/m<sup>3</sup>

Ambient Temperature: 22.0°C

Communication System: LTE Band41; Frequency: 2593 MHz; Duty Cycle: 1:1.58

Probe: EF3DV3 - SN4060;ConvF(1, 1, 1)

E Scan - ER3DV6 - 2011: 15 mm from Probe Center to the Device

3/Hearing Aid Compatibility Test (101x101x1): Interpolated grid:

dx=0.5000 mm, dy=0.5000 mm

Device Reference Point: 0, 0, -6.3 mm

Reference Value = 51.18 V/m; Power Drift = 0.04 dB

Applied MIF = -3.26 dB

RF audio interference level = 31.11 dBV/m

Emission category: **M3**

MIF scaled E-field

Grid 1 <b>M3</b> 32.92 dBV/m	Grid 2 <b>M3</b> 33.16 dBV/m	Grid 3 <b>M3</b> 32.17 dBV/m
Grid 4 <b>M3</b> 30.63 dBV/m	Grid 5 <b>M3</b> 31.11 dBV/m	Grid 6 <b>M3</b> 30.37 dBV/m
Grid 7 <b>M4</b> 26.78 dBV/m	Grid 8 <b>M4</b> 26.59 dBV/m	Grid 9 <b>M4</b> 26.21 dBV/m

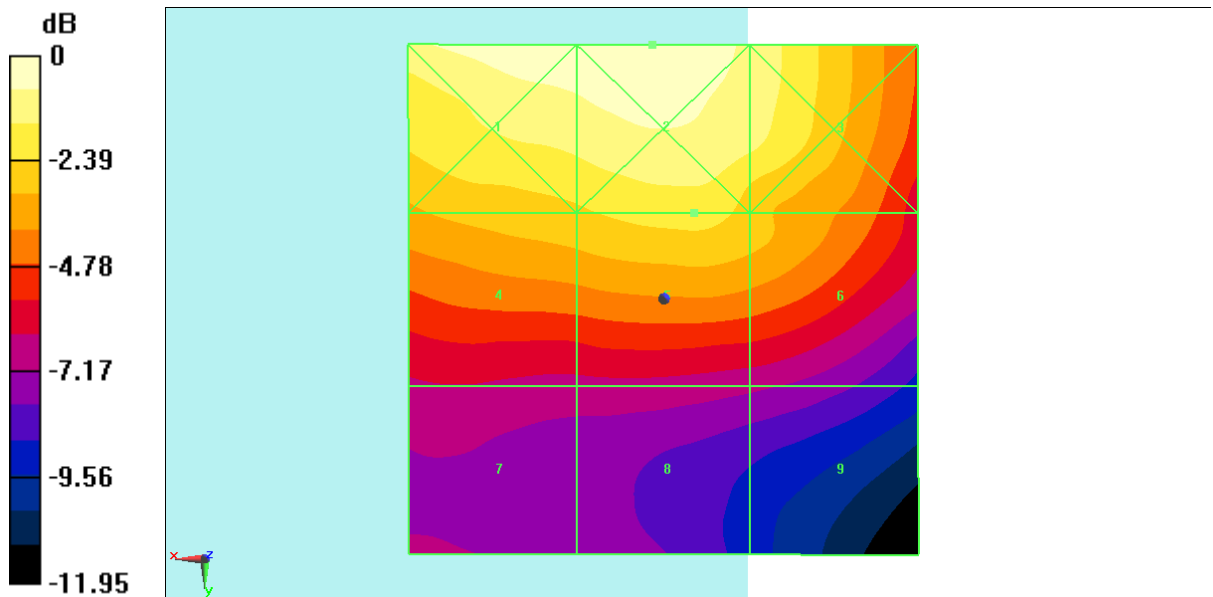

0 dB = 45.49 V/m = 33.16 dBV/m

**Fig B.4 HAC RF E-Field LTE Band41 PC3 QPSK**

**HAC RF E-Field LTE Band48 QPSK**

Date: 2022-10-05

Electronics: DAE4 Sn1524

Medium: Air

Medium parameters used:  $\sigma = 0$  mho/m,  $\epsilon_r = 1$ ;  $\rho = 1000$  kg/m<sup>3</sup>

Ambient Temperature: 22.0°C

Communication System: LTE Band48; Frequency: 3625 MHz; Duty Cycle: 1:1.58

Probe: EF3DV3 - SN4060;ConvF(1, 1, 1)

E Scan - ER3DV6 - 2011: 15 mm from Probe Center to the Device

2/Hearing Aid Compatibility Test (101x101x1): Interpolated grid:

dx=0.5000 mm, dy=0.5000 mm

Device Reference Point: 0, 0, -6.3 mm

Reference Value = 57.40 V/m; Power Drift = 0.08 dB

Applied MIF = -3.58 dB

RF audio interference level = 28.90 dBV/m

Emission category: **M4**

MIF scaled E-field

Grid 1 M4 27.71 dBV/m	Grid 2 M4 28.73 dBV/m	Grid 3 M4 28.13 dBV/m
Grid 4 M4 27.91 dBV/m	Grid 5 M4 28.9 dBV/m	Grid 6 M4 28.32 dBV/m
Grid 7 M4 25 dBV/m	Grid 8 M4 26.6 dBV/m	Grid 9 M4 26.12 dBV/m

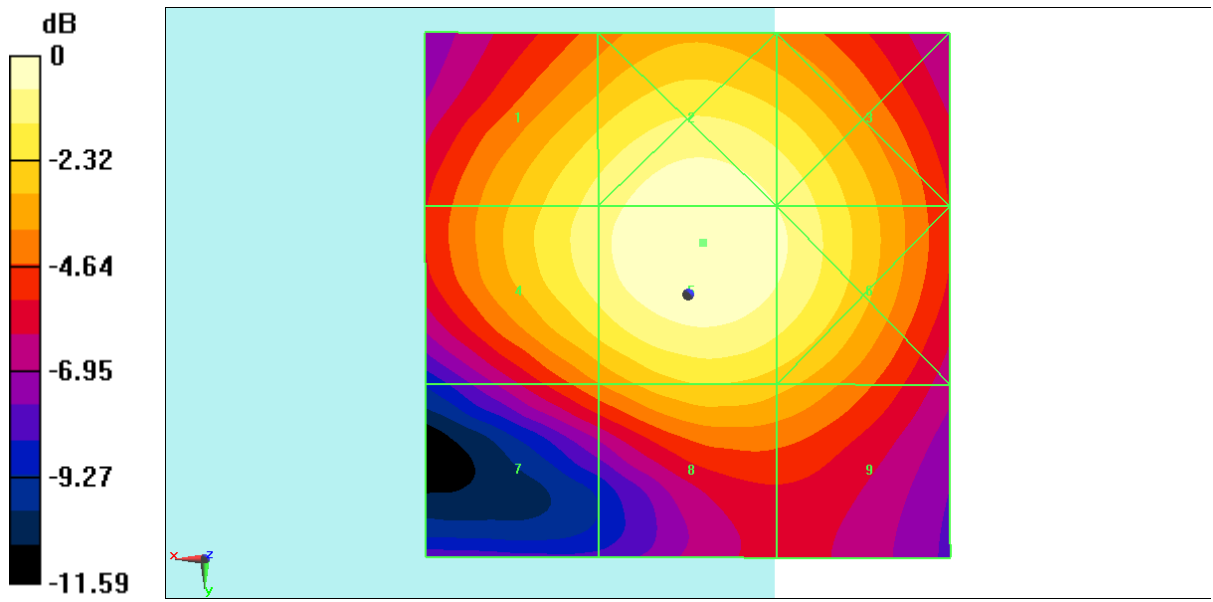

0 dB = 27.86 V/m = 28.90 dBV/m

**Fig B.5 HAC RF E-Field LTE Band48 QPSK**

**HAC RF E-Field WIFI2.4G**

Date: 2022-10-06

Electronics: DAE4 Sn1524

Medium: Air

Medium parameters used:  $\sigma = 0$  mho/m,  $\epsilon_r = 1$ ;  $\rho = 1000$  kg/m<sup>3</sup>

Ambient Temperature: 22.0°C

Communication System: WIFI2.4G; Frequency: 2412 MHz; Duty Cycle: 1:1

Probe: EF3DV3 - SN4060

E Scan - ER3DV6 - 2011: 15 mm from Probe Center to the Device

2/Hearing Aid Compatibility Test (101x101x1): Interpolated grid:

$dx=0.5000$  mm,  $dy=0.5000$  mm

Device Reference Point: 0, 0, -6.3 mm

Reference Value = 38.55 V/m; Power Drift = 0.03 dB

Applied MIF = -7.70 dB

RF audio interference level = 23.34 dBV/m

Emission category: **M4**

MIF scaled E-field

Grid 1 <b>M4</b> 19.81 dBV/m	Grid 2 <b>M4</b> 20.23 dBV/m	Grid 3 <b>M4</b> 19.83 dBV/m
Grid 4 <b>M4</b> 22.85 dBV/m	Grid 5 <b>M4</b> 23.34 dBV/m	Grid 6 <b>M4</b> 22.99 dBV/m
Grid 7 <b>M4</b> 25.72 dBV/m	Grid 8 <b>M4</b> 25.84 dBV/m	Grid 9 <b>M4</b> 24.54 dBV/m

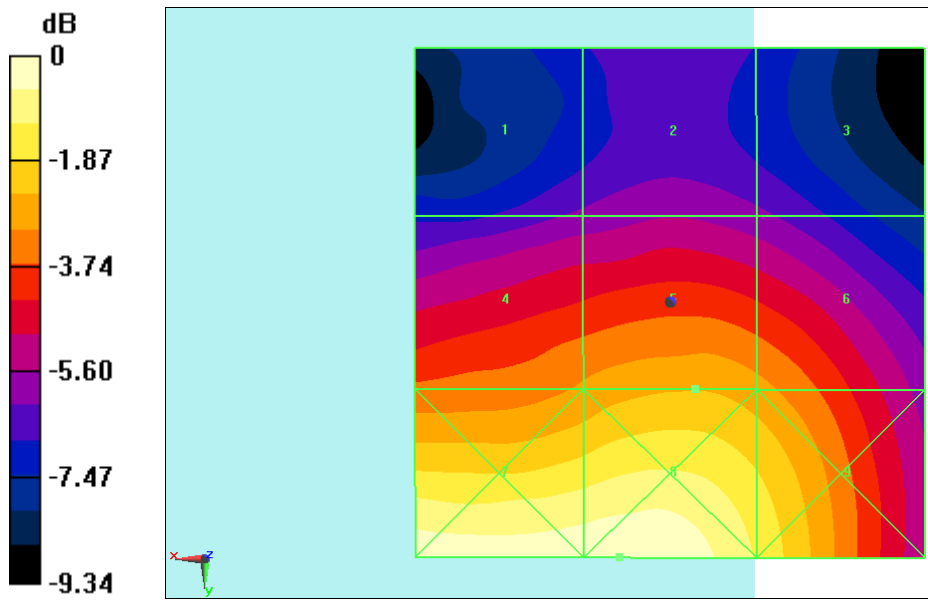

0 dB = 19.60 V/m = 25.85 dBV/m

**Fig B.6 HAC RF E-Field WIFI2.4G**



## ANNEX C SYSTEM VALIDATION RESULT

### E SCAN of Dipole 835 MHz

Date: 2022-09-29

Electronics: DAE4 Sn1524

Medium: Air

Medium parameters used:  $\sigma = 0$  mho/m,  $\epsilon_r = 1$ ;  $\rho = 1000$  kg/m<sup>3</sup>

Communication System: CW; Frequency: 835 MHz; Duty Cycle: 1:1

Probe: EF3DV3 - SN4060

**E Scan - measurement distance from the probe sensor center to CD835 = 15mm/Hearing Aid Compatibility Test at 15mm distance (41x361x1):** Interpolated

grid: dx=0.5000 mm, dy=0.5000 mm

Device Reference Point: 0, 0, -6.3 mm

Reference Value = 143.3 V/m; Power Drift = -0.01 dB

Applied MIF = 0.00 dB

RF audio interference level = 41.19 dBV/m

Emission category: **M3**

MIF scaled E-field

Grid 1 <b>M3</b> <b>41.13 dBV/m</b>	Grid 2 <b>M3</b> <b>41.19 dBV/m</b>	Grid 3 <b>M3</b> <b>40.93 dBV/m</b>
Grid 4 <b>M4</b> <b>36.91 dBV/m</b>	Grid 5 <b>M4</b> <b>36.96 dBV/m</b>	Grid 6 <b>M4</b> <b>36.72 dBV/m</b>
Grid 7 <b>M3</b> <b>41.51 dBV/m</b>	Grid 8 <b>M3</b> <b>41.57 dBV/m</b>	Grid 9 <b>M3</b> <b>41.3 dBV/m</b>

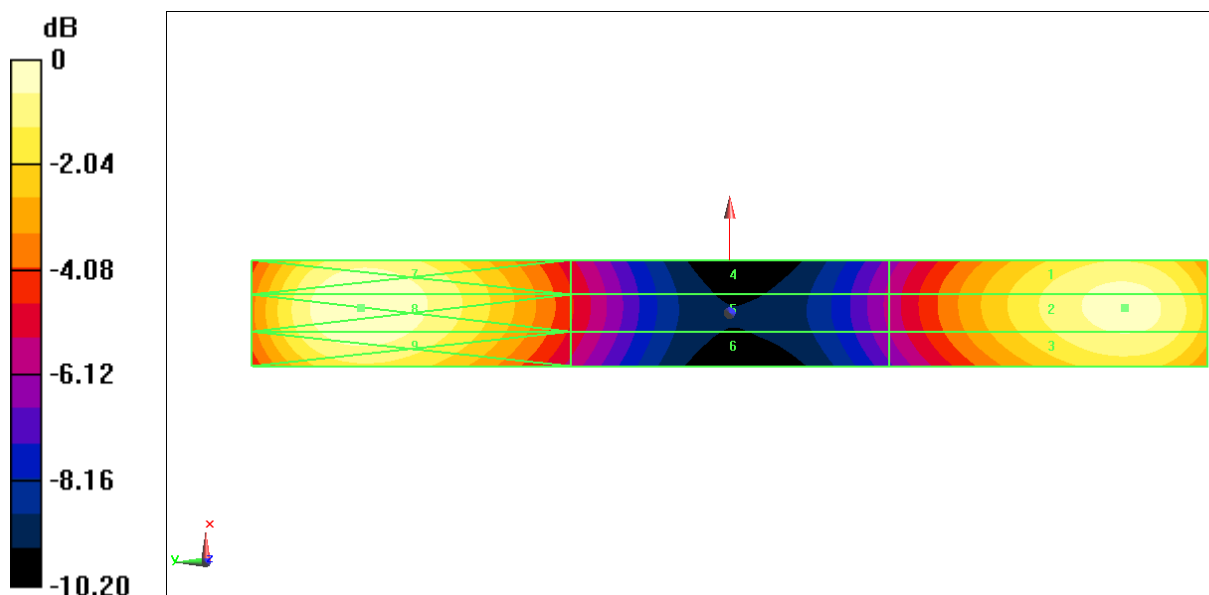

0 dB = 119.8 V/m = 41.57 dBV/m

**E SCAN of Dipole 1800 MHz**

**Date: 2022-09-29**

Electronics: DAE4 Sn1524

Medium: Air

Medium parameters used:  $\sigma = 0$  mho/m,  $\epsilon_r = 1$ ;  $\rho = 1000$  kg/m<sup>3</sup>

Communication System: CW; Frequency: 1880 MHz; Duty Cycle: 1:1

Probe: EF3DV3 - SN4060

**E Scan - measurement distance from the probe sensor center to CD1880 = 15mm**  
**2/Hearing Aid Compatibility Test at 15mm distance (41x181x1):** Interpolated grid:  
 dx=0.5000 mm, dy=0.5000 mm

Device Reference Point: 0, 0, -6.3 mm

Reference Value = 129.6 V/m; Power Drift = 0.02 dB

Applied MIF = 0.00 dB

RF audio interference level = 38.92 dBV/m

**Emission category: M2**

MIF scaled E-field

Grid 1 <b>M2</b> <b>39.36 dBV/m</b>	Grid 2 <b>M2</b> <b>39.38 dBV/m</b>	Grid 3 <b>M2</b> <b>39.02 dBV/m</b>
Grid 4 <b>M2</b> <b>37.01 dBV/m</b>	Grid 5 <b>M2</b> <b>37.05 dBV/m</b>	Grid 6 <b>M2</b> <b>36.96 dBV/m</b>
Grid 7 <b>M2</b> <b>38.77 dBV/m</b>	Grid 8 <b>M2</b> <b>38.92 dBV/m</b>	Grid 9 <b>M2</b> <b>38.77 dBV/m</b>

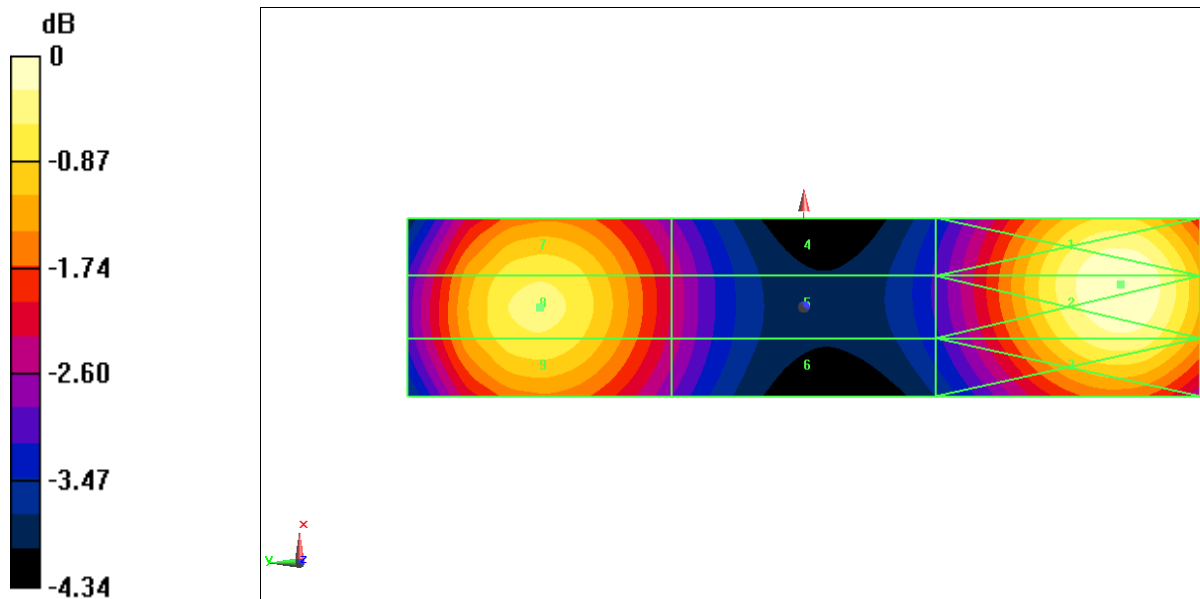

0 dB = 93.09 V/m = 39.38 dBV/m

**E SCAN of Dipole 2450 MHz**
**Date: 2022-10-06**

Electronics: DAE4 Sn1524

Medium: Air

 Medium parameters used:  $\sigma = 0$  mho/m,  $\epsilon_r = 1$ ;  $\rho = 1000$  kg/m<sup>3</sup>

Communication System: CW; Frequency: 2450 MHz; Duty Cycle: 1:1

Probe: EF3DV3 - SN4060

**E Scan - measurement distance from the probe sensor center to CD2450 = 15mm/Hearing Aid Compatibility Test at 15mm distance (41x181x1):** Interpolated grid: dx=0.5000 mm, dy=0.5000 mm

Device Reference Point: 0, 0, -6.3 mm

Reference Value = 66.03 V/m; Power Drift = -0.03 dB

Applied MIF = 0.00 dB

RF audio interference level = 38.19 dBV/m

**Emission category: M2**

MIF scaled E-field

Grid 1 <b>M2</b> <b>38.41 dBV/m</b>	Grid 2 <b>M2</b> <b>38.48 dBV/m</b>	Grid 3 <b>M2</b> <b>38.27 dBV/m</b>
Grid 4 <b>M2</b> <b>37.69 dBV/m</b>	Grid 5 <b>M2</b> <b>37.77 dBV/m</b>	Grid 6 <b>M2</b> <b>37.64 dBV/m</b>
Grid 7 <b>M2</b> <b>38.09 dBV/m</b>	Grid 8 <b>M2</b> <b>38.19 dBV/m</b>	Grid 9 <b>M2</b> <b>38.03 dBV/m</b>

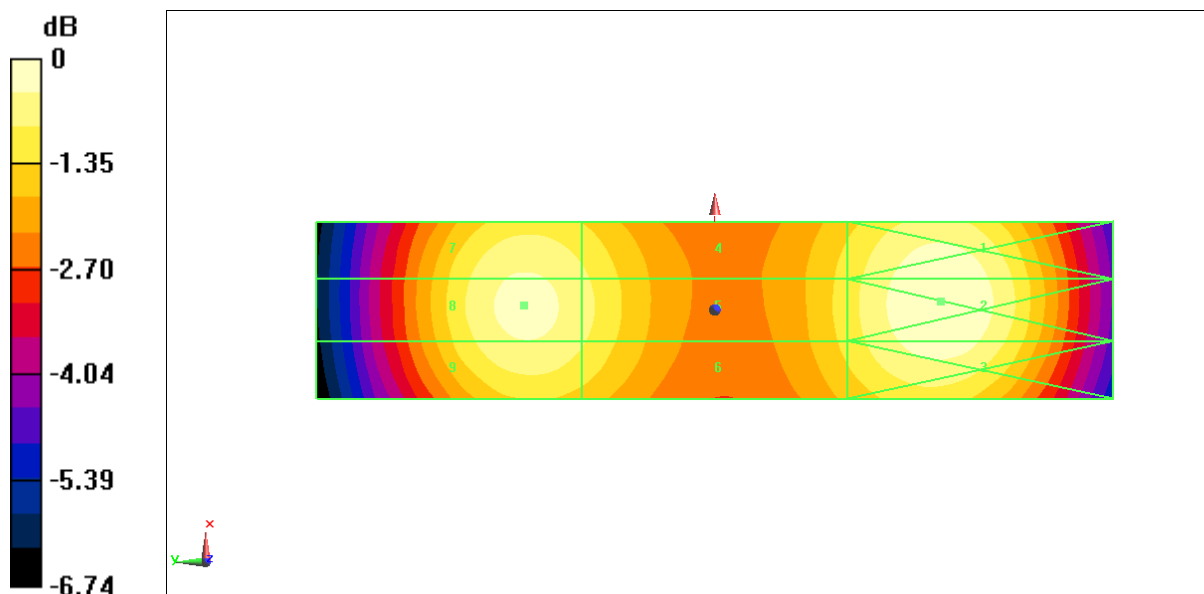

$$0 \text{ dB} = 83.97 \text{ V/m} = 38.48 \text{ dBV/m}$$

**E SCAN of Dipole 2600 MHz**

**Date: 2022-10-03**

Electronics: DAE4 Sn1524

Medium: Air

Medium parameters used:  $\sigma = 0$  mho/m,  $\epsilon_r = 1$ ;  $\rho = 1000$  kg/m<sup>3</sup>

Communication System: CW; Frequency: 2600 MHz; Duty Cycle: 1:1

Probe: EF3DV3 - SN4060

**E Scan - measurement distance from the probe sensor center to CD2600 = 15mm/Hearing Aid Compatibility Test at 15mm distance (41x141x1):** Interpolated grid: dx=0.5000 mm, dy=0.5000 mm

Device Reference Point: 0, 0, -6.3 mm

Reference Value = 59.78 V/m; Power Drift = -0.12 dB

Applied MIF = 0.00 dB

RF audio interference level = 38.23 dBV/m

**Emission category: M2**

MIF scaled E-field

Grid 1 <b>M2</b> <b>38.39 dBV/m</b>	Grid 2 <b>M2</b> <b>38.45 dBV/m</b>	Grid 3 <b>M2</b> <b>38.23 dBV/m</b>
Grid 4 <b>M2</b> <b>37.64 dBV/m</b>	Grid 5 <b>M2</b> <b>37.68 dBV/m</b>	Grid 6 <b>M2</b> <b>37.5 dBV/m</b>
Grid 7 <b>M2</b> <b>38.19 dBV/m</b>	Grid 8 <b>M2</b> <b>38.23 dBV/m</b>	Grid 9 <b>M2</b> <b>38 dBV/m</b>

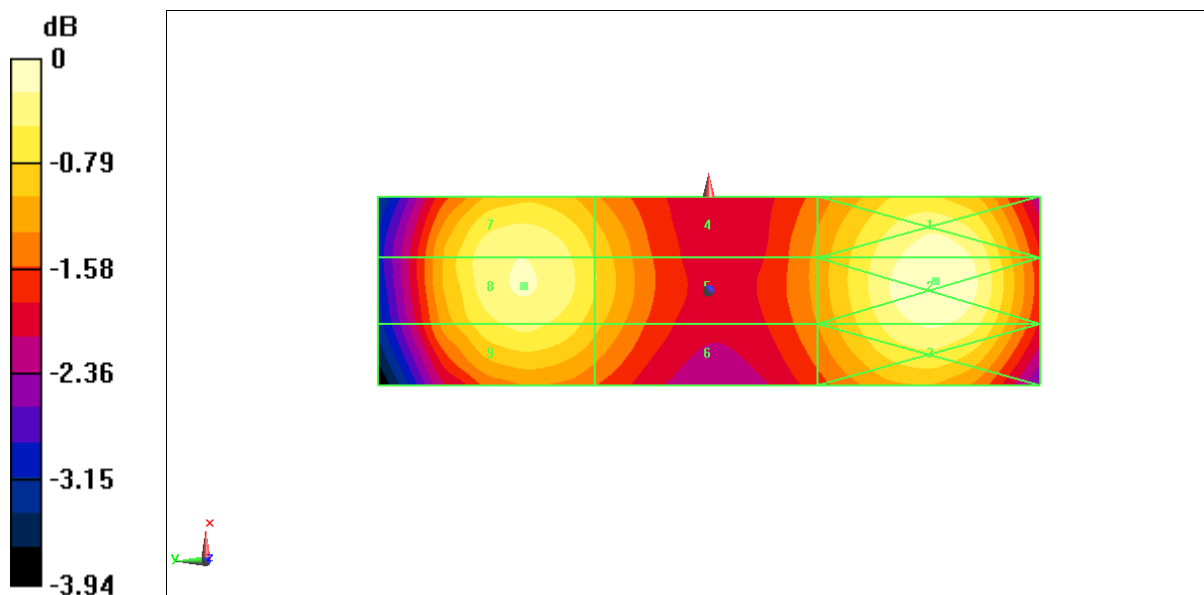

0 dB = 83.69 V/m = 38.45 dBV/m

**E SCAN of Dipole 3500 MHz**
**Date: 2022-10-05**

Electronics: DAE4 Sn1524

Medium: Air

 Medium parameters used:  $\sigma = 0$  mho/m,  $\epsilon_r = 1$ ;  $\rho = 1000$  kg/m<sup>3</sup>

Communication System: CW; Frequency: 3500 MHz; Duty Cycle: 1:1

Probe: EF3DV3 - SN4060

**E Scan - measurement distance from the probe sensor center to CD3500 = 15mm/Hearing Aid Compatibility Test at 15mm distance (41x101x1):** Interpolated grid: dx=0.5000 mm, dy=0.5000 mm

Device Reference Point: 0, 0, -6.3 mm

Reference Value = 35.70 V/m; Power Drift = -0.00 dB

Applied MIF = 0.00 dB

RF audio interference level = 38.43 dBV/m

**Emission category: M2**

MIF scaled E-field

Grid 1 <b>M2</b> <b>38.43 dBV/m</b>	Grid 2 <b>M2</b> <b>38.47 dBV/m</b>	Grid 3 <b>M2</b> <b>38.37 dBV/m</b>
Grid 4 <b>M2</b> <b>38.31 dBV/m</b>	Grid 5 <b>M2</b> <b>38.38 dBV/m</b>	Grid 6 <b>M2</b> <b>38.25 dBV/m</b>
Grid 7 <b>M2</b> <b>38.34 dBV/m</b>	Grid 8 <b>M2</b> <b>38.43 dBV/m</b>	Grid 9 <b>M2</b> <b>38.29 dBV/m</b>

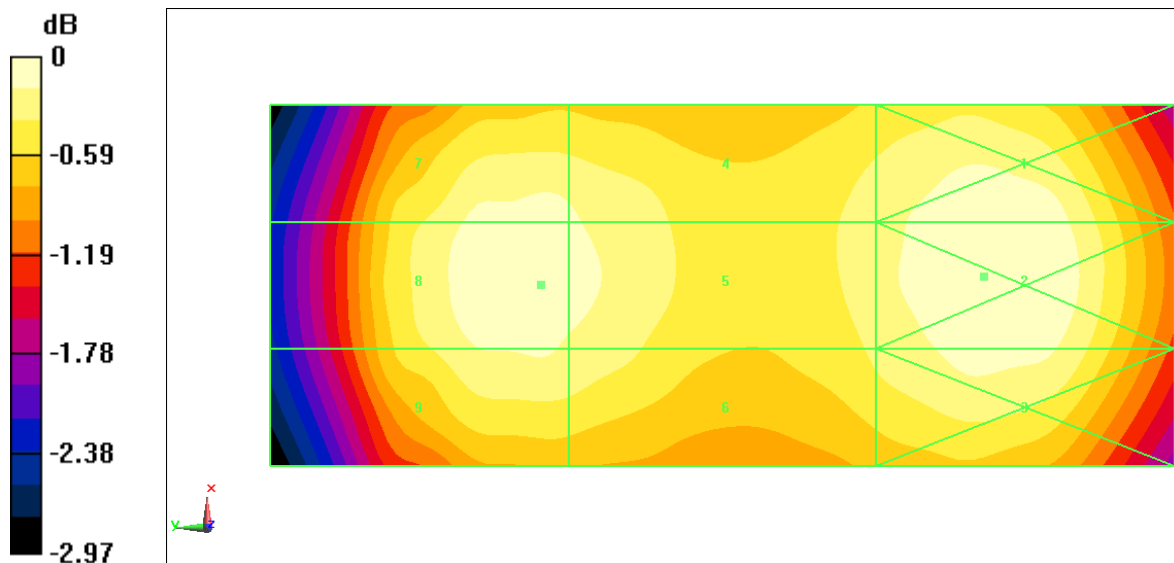
 $0 \text{ dB} = 83.88 \text{ V/m} = 38.47 \text{ dBV/m}$

# ANNEX D PROBE CALIBRATION CERTIFICATE

**Calibration Laboratory of**  
**Schmid & Partner**  
**Engineering AG**  
 Zeughausstrasse 43, 8004 Zurich, Switzerland



**S** Schweizerischer Kalibrierdienst  
**C** Service suisse d'étalonnage  
**S** Servizio svizzero di taratura  
 Swiss Calibration Service

Accredited by the Swiss Accreditation Service (SAS)  
 The Swiss Accreditation Service is one of the signatories to the EA  
 Multilateral Agreement for the recognition of calibration certificates

Accreditation No.: SCS 0108

Client **CTTL (Auden)**

Certificate No: **EF3-4060\_May22**

## CALIBRATION CERTIFICATE

Object: **EF3DV3- SN:4060**

Calibration procedure(s): **QA CAL-02.v9, QA CAL-25.v7**  
 Calibration procedure for E-field probes optimized for close near field evaluations in air

Calibration date: **May 13, 2022**

This calibration certificate documents the traceability to national standards, which realize the physical units of measurements (SI).  
 The measurements and the uncertainties with confidence probability are given on the following pages and are part of the certificate.

All calibrations have been conducted in the closed laboratory facility: environment temperature (22 ± 3)°C and humidity < 70%.

Calibration Equipment used (M&TE critical for calibration)

Primary Standards	ID	Cal Date (Certificate No.)	Scheduled Calibration
Power meter NRP	SN: 104778	04-Apr-22 (No. 217-03525/03524)	Apr-23
Power sensor NRP-Z91	SN: 103244	04-Apr-22 (No. 217-03524)	Apr-23
Power sensor NRP-Z91	SN: 103245	04-Apr-22 (No. 217-03525)	Apr-23
Reference 20 dB Attenuator	SN: CC2552 (20x)	04-Apr-22 (No. 217-03527)	Apr-23
DAE4	SN: 789	24-Dec-21 (No. DAE4-789_Dec21)	Dec-22
Reference Probe ER3DV6	SN: 2328	08-Oct-21 (No. ER3-2328_Oct21)	Oct-22
Secondary Standards	ID	Check Date (in house)	Scheduled Check
Power meter E4419B	SN: GB41293874	06-Apr-16 (in house check Jun-20)	In house check: Jun-22
Power sensor E4412A	SN: MY41498087	06-Apr-16 (in house check Jun-20)	In house check: Jun-22
Power sensor E4412A	SN: 000110210	06-Apr-16 (in house check Jun-20)	In house check: Jun-22
RF generator HP 8648C	SN: US3642U01700	04-Aug-99 (in house check Jun-20)	In house check: Jun-22
Network Analyzer E8358A	SN: US41080477	31-Mar-14 (in house check Oct-20)	In house check: Oct-22

Calibrated by: **Jeffrey Katzman** (Name), **Laboratory Technician** (Function), *[Signature]* (Signature)

Approved by: **Sven Kühn** (Name), **Technical Manager** (Function), *[Signature]* (Signature)

Issued: May 13, 2022

This calibration certificate shall not be reproduced except in full without written approval of the laboratory.

**Calibration Laboratory of**  
**Schmid & Partner**  
**Engineering AG**  
 Zeughausstrasse 43, 8004 Zurich, Switzerland



**S** Schweizerischer Kalibrierdienst  
**C** Service suisse d'étalonnage  
**S** Servizio svizzero di taratura  
**S** Swiss Calibration Service

Accredited by the Swiss Accreditation Service (SAS)

Accreditation No.: **SCS 0108**

The Swiss Accreditation Service is one of the signatories to the EA  
 Multilateral Agreement for the recognition of calibration certificates

#### Glossary:

NORM <sub>x,y,z</sub>	sensitivity in free space
DCP	diode compression point
CF	crest factor (1/duty_cycle) of the RF signal
A, B, C, D	modulation dependent linearization parameters
En	incident E-field orientation normal to probe axis
Ep	incident E-field orientation parallel to probe axis
Polarization $\varphi$	$\varphi$ rotation around probe axis
Polarization $\vartheta$	$\vartheta$ rotation around an axis that is in the plane normal to probe axis (at measurement center), i.e., $\vartheta = 0$ is normal to probe axis
Connector Angle	information used in DASY system to align probe sensor X to the robot coordinate system

#### Calibration is Performed According to the Following Standards:

- a) IEEE Std 1309-2005, "IEEE Standard for calibration of electromagnetic field sensors and probes, excluding antennas, from 9 kHz to 40 GHz", December 2005
- b) CTIA Test Plan for Hearing Aid Compatibility, Rev 3.1.1, May 2017

#### Methods Applied and Interpretation of Parameters:

- **NORM<sub>x,y,z</sub>**: Assessed for E-field polarization  $\vartheta = 0$  for XY sensors and  $\vartheta = 90$  for Z sensor ( $f \leq 900$  MHz in TEM-cell;  $f > 1800$  MHz: R22 waveguide).
- **NORM(f)<sub>x,y,z</sub>** = NORM<sub>x,y,z</sub> \* frequency\_response (see Frequency Response Chart).
- **DCP<sub>x,y,z</sub>**: DCP are numerical linearization parameters assessed based on the data of power sweep with CW signal (no uncertainty required). DCP does not depend on frequency nor media.
- **PAR**: PAR is the Peak to Average Ratio that is not calibrated but determined based on the signal characteristics
- **A<sub>x,y,z</sub>; B<sub>x,y,z</sub>; C<sub>x,y,z</sub>; D<sub>x,y,z</sub>; VR<sub>x,y,z</sub>**: A, B, C, D are numerical linearization parameters assessed based on the data of power sweep for specific modulation signal. The parameters do not depend on frequency nor media. VR is the maximum calibration range expressed in RMS voltage across the diode.
- **Spherical isotropy (3D deviation from isotropy)**: in a locally homogeneous field realized using an open waveguide setup.
- **Sensor Offset**: The sensor offset corresponds to the offset of virtual measurement center from the probe tip (on probe axis). No tolerance required.
- **Connector Angle**: The angle is assessed using the information gained by determining the NORM<sub>x</sub> (no uncertainty required).

EF3DV3 – SN:4060

May 13, 2022

## DASY/EASY - Parameters of Probe: EF3DV3 - SN:4060

### Basic Calibration Parameters

	Sensor X	Sensor Y	Sensor Z	Unc (k=2)
Norm ( $\mu\text{V}/(\text{V/m})^2$ )	0.80	0.74	1.29	$\pm 10.1\%$
DCP (mV) <sup>B</sup>	94.7	96.7	93.6	

### Calibration results for Frequency Response (30 MHz – 6 GHz)

Frequency MHz	Target E-Field V/m	Measured E-field (E <sub>n</sub> ) V/m	Deviation E-normal in %	Measured E-field (E <sub>p</sub> ) V/m	Deviation E-normal in %	Unc (k=2) %
30	77.1	77.3	0.2%	76.9	-0.3%	$\pm 5.1\%$
100	77.0	78.0	1.2%	77.9	1.1%	$\pm 5.1\%$
450	77.1	78.0	1.1%	78.0	1.2%	$\pm 5.1\%$
600	77.2	77.6	0.5%	77.6	0.6%	$\pm 5.1\%$
750	77.2	77.3	0.1%	77.2	0.1%	$\pm 5.1\%$
1800	143.1	139.7	-2.4%	139.7	-2.4%	$\pm 5.1\%$
2000	134.9	129.1	-4.3%	129.3	-4.1%	$\pm 5.1\%$
2200	127.7	124.4	-2.5%	125.4	-1.8%	$\pm 5.1\%$
2500	125.4	119.9	-4.4%	121.0	-3.5%	$\pm 5.1\%$
3000	79.0	75.6	-4.3%	76.7	-2.9%	$\pm 5.1\%$
3500	256.1	256.6	0.2%	253.2	-1.1%	$\pm 5.1\%$
3700	249.6	246.9	-1.1%	245.0	-1.8%	$\pm 5.1\%$
5200	50.8	50.7	-0.1%	51.0	0.4%	$\pm 5.1\%$
5500	49.6	48.7	-1.7%	47.4	-4.4%	$\pm 5.1\%$
5800	48.9	47.9	-2.0%	49.0	0.3%	$\pm 5.1\%$

The reported uncertainty of measurement is stated as the standard uncertainty of measurement multiplied by the coverage factor k=2, which for a normal distribution corresponds to a coverage probability of approximately 95%.

<sup>B</sup> Numerical linearization parameter: uncertainty not required.

<sup>E</sup> Uncertainty is determined using the max. deviation from linear response applying rectangular distribution and is expressed for the square of the field value.



EF3DV3 – SN:4060

May 13, 2022

**DASY/EASY - Parameters of Probe: EF3DV3 - SN:4060**
**Calibration Results for Modulation Response**

UID	Communication System Name		A dB	B dB $\sqrt{\mu}$ V	C	D dB	VR mV	Max dev.	Max Unc <sup>E</sup> (k=2)
0	CW	X	0.00	0.00	1.00	0.00	128.5	$\pm 2.5\%$	$\pm 4.7\%$
		Y	0.00	0.00	1.00		161.6		
		Z	0.00	0.00	1.00		126.0		
10352-AAA	Pulse Waveform (200Hz, 10%)	X	2.86	66.73	10.11	10.00	60.0	$\pm 2.7\%$	$\pm 9.6\%$
		Y	3.19	67.88	10.96		60.0		
		Z	2.92	66.86	10.24		60.0		
10353-AAA	Pulse Waveform (200Hz, 20%)	X	1.64	64.88	8.36	6.99	80.0	$\pm 1.1\%$	$\pm 9.6\%$
		Y	1.94	66.74	9.54		80.0		
		Z	1.54	64.64	8.24		80.0		
10354-AAA	Pulse Waveform (200Hz, 40%)	X	0.95	64.46	7.35	3.98	95.0	$\pm 0.9\%$	$\pm 9.6\%$
		Y	1.89	70.07	9.92		95.0		
		Z	0.67	62.65	6.36		95.0		
10355-AAA	Pulse Waveform (200Hz, 60%)	X	20.00	83.48	12.24	2.22	120.0	$\pm 0.9\%$	$\pm 9.6\%$
		Y	20.00	88.16	14.35		120.0		
		Z	0.51	63.43	5.89		120.0		
10387-AAA	QPSK Waveform, 1 MHz	X	2.22	73.26	18.56	1.00	150.0	$\pm 2.2\%$	$\pm 9.6\%$
		Y	1.80	69.14	16.22		150.0		
		Z	1.87	70.42	16.69		150.0		
10388-AAA	QPSK Waveform, 10 MHz	X	2.71	72.48	18.53	0.00	150.0	$\pm 1.0\%$	$\pm 9.6\%$
		Y	2.34	69.47	16.72		150.0		
		Z	2.39	70.19	17.11		150.0		
10396-AAA	64-QAM Waveform, 100 kHz	X	2.23	68.63	18.88	3.01	150.0	$\pm 2.2\%$	$\pm 9.6\%$
		Y	1.81	65.44	17.77		150.0		
		Z	2.18	68.07	18.09		150.0		
10399-AAA	64-QAM Waveform, 40 MHz	X	3.72	68.50	16.96	0.00	150.0	$\pm 1.1\%$	$\pm 9.6\%$
		Y	3.49	67.25	16.05		150.0		
		Z	3.54	67.62	16.30		150.0		
10414-AAA	WLAN CCDF, 64-QAM, 40MHz	X	4.78	65.89	16.06	0.00	150.0	$\pm 2.5\%$	$\pm 9.6\%$
		Y	4.77	65.81	15.78		150.0		
		Z	4.63	65.46	15.68		150.0		

Note: For details on UID parameters see Appendix

The reported uncertainty of measurement is stated as the standard uncertainty of measurement multiplied by the coverage factor  $k=2$ , which for a normal distribution corresponds to a coverage probability of approximately 95%.

<sup>B</sup> Numerical linearization parameter: uncertainty not required.

<sup>E</sup> Uncertainty is determined using the max. deviation from linear response applying rectangular distribution and is expressed for the square of the field value.



EF3DV3 – SN:4060

May 13, 2022

**DASY/EASY - Parameters of Probe: EF3DV3 - SN:4060****Sensor Frequency Model Parameters**

	Sensor X	Sensor Y	Sensor Z
Frequency Corr. (LF)	0.11	0.19	4.60
Frequency Corr. (HF)	2.82	2.82	2.82

**Sensor Model Parameters**

	C1 fF	C2 fF	$\alpha$ V <sup>-1</sup>	T1 ms.V <sup>-2</sup>	T2 ms.V <sup>-1</sup>	T3 ms	T4 V <sup>-2</sup>	T5 V <sup>-1</sup>	T6
X	38.6	259.37	38.06	6.78	0.04	4.96	0.19	0.13	1.00
Y	38.1	250.89	36.65	4.87	0.03	4.98	0.00	0.00	1.01
Z	35.7	239.69	37.83	4.44	0.04	4.97	0.47	0.08	1.00

**Other Probe Parameters**

Sensor Arrangement	Rectangular
Connector Angle (°)	145.7
Mechanical Surface Detection Mode	enabled
Optical Surface Detection Mode	disabled
Probe Overall Length	337 mm
Probe Body Diameter	12 mm
Tip Length	25 mm
Tip Diameter	4 mm
Probe Tip to Sensor X Calibration Point	1.5 mm
Probe Tip to Sensor Y Calibration Point	1.5 mm
Probe Tip to Sensor Z Calibration Point	1.5 mm

### Receiving Pattern ( $\phi$ ), $\vartheta = 0^\circ$

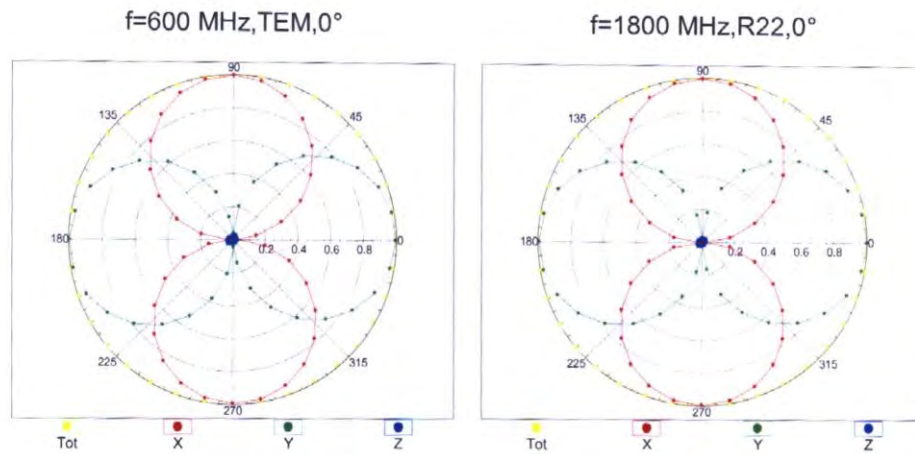

### Receiving Pattern ( $\phi$ ), $\vartheta = 90^\circ$

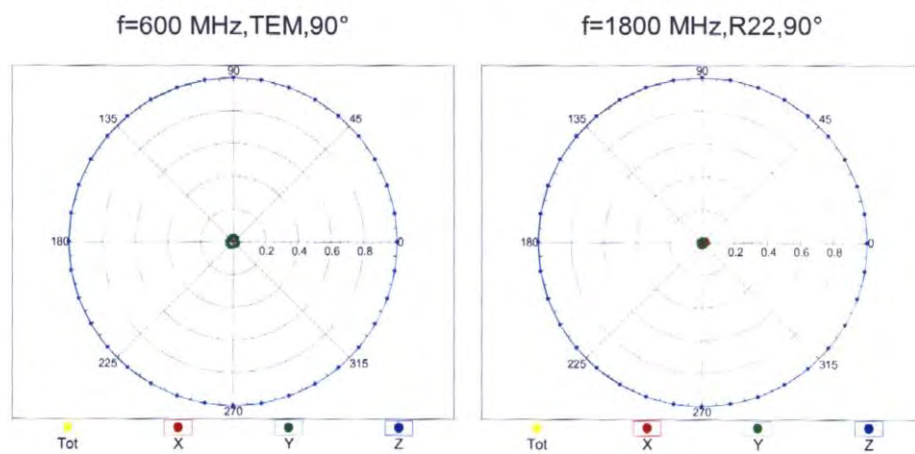

EF3DV3 – SN:4060

May 13, 2022

### Receiving Pattern ( $\phi$ ), $\vartheta = 0^\circ$

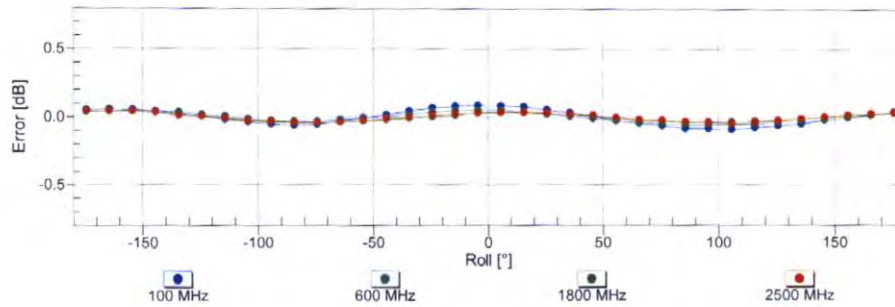
Uncertainty of Axial Isotropy Assessment:  $\pm 0.5\%$  ( $k=2$ )

### Receiving Pattern ( $\phi$ ), $\vartheta = 90^\circ$

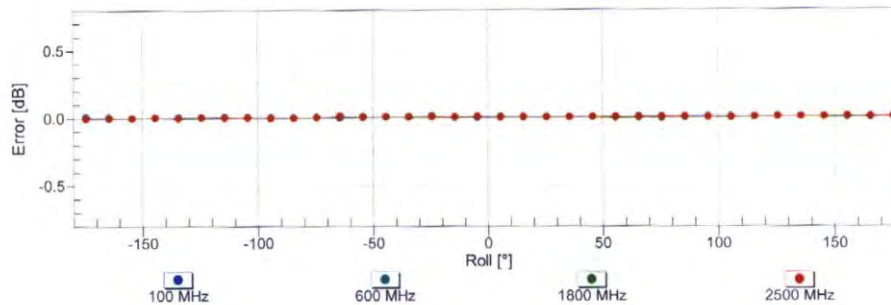
Uncertainty of Axial Isotropy Assessment:  $\pm 0.5\%$  ( $k=2$ )

### Dynamic Range f(E-field) (TEM cell, f = 900 MHz)

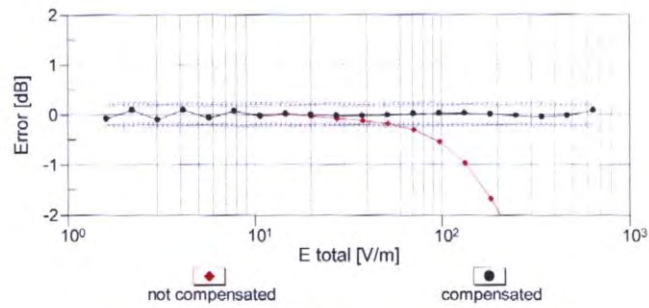
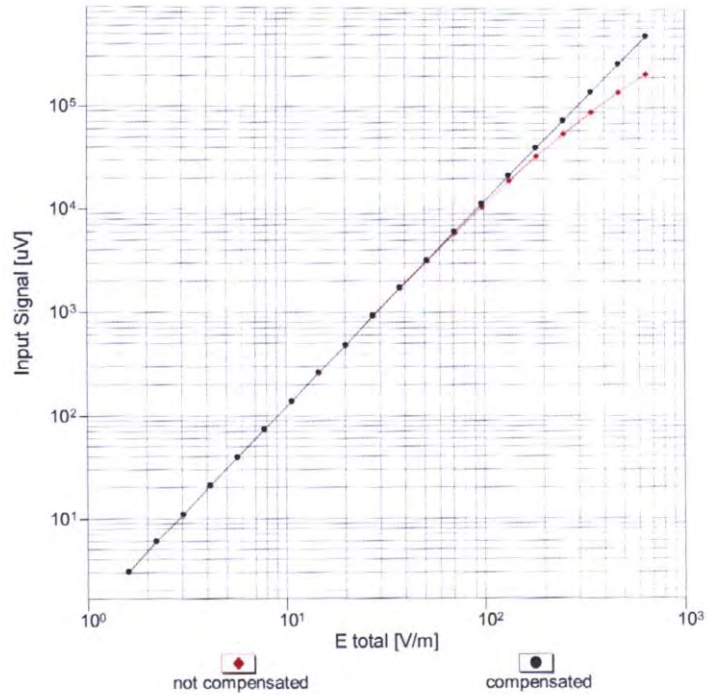

Uncertainty of Linearity Assessment:  $\pm 0.6\%$  (k=2)

### Deviation from Isotropy in Air Error ( $\phi$ , $\theta$ ), $f = 900$ MHz

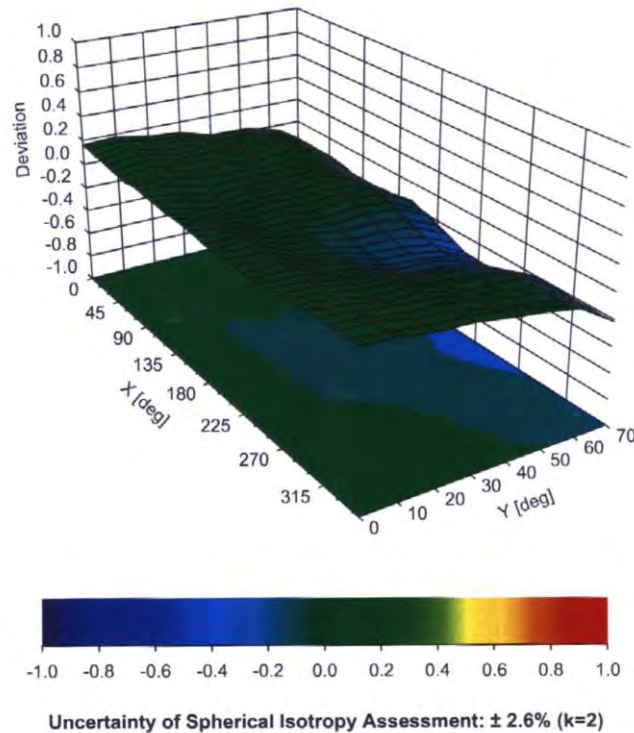

EF3DV3 – SN:4060

May 13, 2022

**Appendix: Modulation Calibration Parameters**

UID	Rev	Communication System Name	Group	PAR (dB)	Unc <sup>±</sup> (k=2)
0	-	CW	CW	0.00	± 4.7 %
10010	CAA	SAR Validation (Square, 100ms, 10ms)	Test	10.00	± 9.6 %
10011	CAB	UMTS-FDD (WCDMA)	WCDMA	2.91	± 9.6 %
10012	CAB	IEEE 802.11b WiFi 2.4 GHz (DSSS, 1 Mbps)	WLAN	1.87	± 9.6 %
10013	CAB	IEEE 802.11g WiFi 2.4 GHz (DSSS-OFDM, 6 Mbps)	WLAN	9.46	± 9.6 %
10021	DAC	GSM-FDD (TDMA, GMSK)	GSM	9.39	± 9.6 %
10023	DAC	GPRS-FDD (TDMA, GMSK, TN 0)	GSM	9.57	± 9.6 %
10024	DAC	GPRS-FDD (TDMA, GMSK, TN 0-1)	GSM	6.56	± 9.6 %
10025	DAC	EDGE-FDD (TDMA, 8PSK, TN 0)	GSM	12.62	± 9.6 %
10026	DAC	EDGE-FDD (TDMA, 8PSK, TN 0-1)	GSM	9.55	± 9.6 %
10027	DAC	GPRS-FDD (TDMA, GMSK, TN 0-1-2)	GSM	4.80	± 9.6 %
10028	DAC	GPRS-FDD (TDMA, GMSK, TN 0-1-2-3)	GSM	3.55	± 9.6 %
10029	DAC	EDGE-FDD (TDMA, 8PSK, TN 0-1-2)	GSM	7.78	± 9.6 %
10030	CAA	IEEE 802.15.1 Bluetooth (GFSK, DH1)	Bluetooth	5.30	± 9.6 %
10031	CAA	IEEE 802.15.1 Bluetooth (GFSK, DH3)	Bluetooth	1.87	± 9.6 %
10032	CAA	IEEE 802.15.1 Bluetooth (GFSK, DH5)	Bluetooth	1.16	± 9.6 %
10033	CAA	IEEE 802.15.1 Bluetooth (PI/4-DQPSK, DH1)	Bluetooth	7.74	± 9.6 %
10034	CAA	IEEE 802.15.1 Bluetooth (PI/4-DQPSK, DH3)	Bluetooth	4.53	± 9.6 %
10035	CAA	IEEE 802.15.1 Bluetooth (PI/4-DQPSK, DH5)	Bluetooth	3.83	± 9.6 %
10036	CAA	IEEE 802.15.1 Bluetooth (8-DPSK, DH1)	Bluetooth	8.01	± 9.6 %
10037	CAA	IEEE 802.15.1 Bluetooth (8-DPSK, DH3)	Bluetooth	4.77	± 9.6 %
10038	CAA	IEEE 802.15.1 Bluetooth (8-DPSK, DH5)	Bluetooth	4.10	± 9.6 %
10039	CAB	CDMA2000 (1xRTT, RC1)	CDMA2000	4.57	± 9.6 %
10042	CAB	IS-54 / IS-136 FDD (TDMA/FDM, PI/4-DQPSK, Halfrate)	AMPS	7.78	± 9.6 %
10044	CAA	IS-91/EIA/TIA-553 FDD (FDMA, FM)	AMPS	0.00	± 9.6 %
10048	CAA	DECT (TDD, TDMA/FDM, GFSK, Full Slot, 24)	DECT	13.80	± 9.6 %
10049	CAA	DECT (TDD, TDMA/FDM, GFSK, Double Slot, 12)	DECT	10.79	± 9.6 %
10056	CAA	UMTS-TDD (TD-SCDMA, 1.28 Mcps)	TD-SCDMA	11.01	± 9.6 %
10058	DAC	EDGE-FDD (TDMA, 8PSK, TN 0-1-2-3)	GSM	6.52	± 9.6 %
10059	CAB	IEEE 802.11b WiFi 2.4 GHz (DSSS, 2 Mbps)	WLAN	2.12	± 9.6 %
10060	CAB	IEEE 802.11b WiFi 2.4 GHz (DSSS, 5.5 Mbps)	WLAN	2.83	± 9.6 %
10061	CAB	IEEE 802.11b WiFi 2.4 GHz (DSSS, 11 Mbps)	WLAN	3.60	± 9.6 %
10062	CAD	IEEE 802.11a/h WiFi 5 GHz (OFDM, 6 Mbps)	WLAN	8.68	± 9.6 %
10063	CAD	IEEE 802.11a/h WiFi 5 GHz (OFDM, 9 Mbps)	WLAN	8.63	± 9.6 %
10064	CAD	IEEE 802.11a/h WiFi 5 GHz (OFDM, 12 Mbps)	WLAN	9.09	± 9.6 %
10065	CAD	IEEE 802.11a/h WiFi 5 GHz (OFDM, 18 Mbps)	WLAN	9.00	± 9.6 %
10066	CAD	IEEE 802.11a/h WiFi 5 GHz (OFDM, 24 Mbps)	WLAN	9.38	± 9.6 %
10067	CAD	IEEE 802.11a/h WiFi 5 GHz (OFDM, 36 Mbps)	WLAN	10.12	± 9.6 %
10068	CAD	IEEE 802.11a/h WiFi 5 GHz (OFDM, 48 Mbps)	WLAN	10.24	± 9.6 %
10069	CAD	IEEE 802.11a/h WiFi 5 GHz (OFDM, 54 Mbps)	WLAN	10.56	± 9.6 %
10071	CAB	IEEE 802.11g WiFi 2.4 GHz (DSSS/OFDM, 9 Mbps)	WLAN	9.83	± 9.6 %
10072	CAB	IEEE 802.11g WiFi 2.4 GHz (DSSS/OFDM, 12 Mbps)	WLAN	9.62	± 9.6 %
10073	CAB	IEEE 802.11g WiFi 2.4 GHz (DSSS/OFDM, 18 Mbps)	WLAN	9.94	± 9.6 %
10074	CAB	IEEE 802.11g WiFi 2.4 GHz (DSSS/OFDM, 24 Mbps)	WLAN	10.30	± 9.6 %
10075	CAB	IEEE 802.11g WiFi 2.4 GHz (DSSS/OFDM, 36 Mbps)	WLAN	10.77	± 9.6 %
10076	CAB	IEEE 802.11g WiFi 2.4 GHz (DSSS/OFDM, 48 Mbps)	WLAN	10.94	± 9.6 %
10077	CAB	IEEE 802.11g WiFi 2.4 GHz (DSSS/OFDM, 54 Mbps)	WLAN	11.00	± 9.6 %
10081	CAB	CDMA2000 (1xRTT, RC3)	CDMA2000	3.97	± 9.6 %
10082	CAB	IS-54 / IS-136 FDD (TDMA/FDM, PI/4-DQPSK, Fullrate)	AMPS	4.77	± 9.6 %
10090	DAC	GPRS-FDD (TDMA, GMSK, TN 0-4)	GSM	6.56	± 9.6 %
10097	CAB	UMTS-FDD (HSDPA)	WCDMA	3.98	± 9.6 %
10098	CAB	UMTS-FDD (HSUPA, Subtest 2)	WCDMA	3.98	± 9.6 %
10099	DAC	EDGE-FDD (TDMA, 8PSK, TN 0-4)	GSM	9.55	± 9.6 %

EF3DV3 – SN:4060

May 13, 2022

10100	CAE	LTE-FDD (SC-FDMA, 100% RB, 20 MHz, QPSK)	LTE-FDD	5.67	± 9.6 %
10101	CAE	LTE-FDD (SC-FDMA, 100% RB, 20 MHz, 16-QAM)	LTE-FDD	6.42	± 9.6 %
10102	CAE	LTE-FDD (SC-FDMA, 100% RB, 20 MHz, 64-QAM)	LTE-FDD	6.60	± 9.6 %
10103	CAG	LTE-TDD (SC-FDMA, 100% RB, 20 MHz, QPSK)	LTE-TDD	9.29	± 9.6 %
10104	CAG	LTE-TDD (SC-FDMA, 100% RB, 20 MHz, 16-QAM)	LTE-TDD	9.97	± 9.6 %
10105	CAG	LTE-TDD (SC-FDMA, 100% RB, 20 MHz, 64-QAM)	LTE-TDD	10.01	± 9.6 %
10108	CAG	LTE-FDD (SC-FDMA, 100% RB, 10 MHz, QPSK)	LTE-FDD	5.80	± 9.6 %
10109	CAG	LTE-FDD (SC-FDMA, 100% RB, 10 MHz, 16-QAM)	LTE-FDD	6.43	± 9.6 %
10110	CAG	LTE-FDD (SC-FDMA, 100% RB, 5 MHz, QPSK)	LTE-FDD	5.75	± 9.6 %
10111	CAG	LTE-FDD (SC-FDMA, 100% RB, 5 MHz, 16-QAM)	LTE-FDD	6.44	± 9.6 %
10112	CAG	LTE-FDD (SC-FDMA, 100% RB, 10 MHz, 64-QAM)	LTE-FDD	6.59	± 9.6 %
10113	CAG	LTE-FDD (SC-FDMA, 100% RB, 5 MHz, 64-QAM)	LTE-FDD	6.62	± 9.6 %
10114	CAD	IEEE 802.11n (HT Greenfield, 13.5 Mbps, BPSK)	WLAN	8.10	± 9.6 %
10115	CAD	IEEE 802.11n (HT Greenfield, 81 Mbps, 16-QAM)	WLAN	8.46	± 9.6 %
10116	CAD	IEEE 802.11n (HT Greenfield, 135 Mbps, 64-QAM)	WLAN	8.15	± 9.6 %
10117	CAD	IEEE 802.11n (HT Mixed, 13.5 Mbps, BPSK)	WLAN	8.07	± 9.6 %
10118	CAD	IEEE 802.11n (HT Mixed, 81 Mbps, 16-QAM)	WLAN	8.59	± 9.6 %
10119	CAD	IEEE 802.11n (HT Mixed, 135 Mbps, 64-QAM)	WLAN	8.13	± 9.6 %
10140	CAE	LTE-FDD (SC-FDMA, 100% RB, 15 MHz, 16-QAM)	LTE-FDD	6.49	± 9.6 %
10141	CAE	LTE-FDD (SC-FDMA, 100% RB, 15 MHz, 64-QAM)	LTE-FDD	6.53	± 9.6 %
10142	CAE	LTE-FDD (SC-FDMA, 100% RB, 3 MHz, QPSK)	LTE-FDD	5.73	± 9.6 %
10143	CAE	LTE-FDD (SC-FDMA, 100% RB, 3 MHz, 16-QAM)	LTE-FDD	6.35	± 9.6 %
10144	CAE	LTE-FDD (SC-FDMA, 100% RB, 3 MHz, 64-QAM)	LTE-FDD	6.65	± 9.6 %
10145	CAF	LTE-FDD (SC-FDMA, 100% RB, 1.4 MHz, QPSK)	LTE-FDD	5.76	± 9.6 %
10146	CAF	LTE-FDD (SC-FDMA, 100% RB, 1.4 MHz, 16-QAM)	LTE-FDD	6.41	± 9.6 %
10147	CAF	LTE-FDD (SC-FDMA, 100% RB, 1.4 MHz, 64-QAM)	LTE-FDD	6.72	± 9.6 %
10149	CAE	LTE-FDD (SC-FDMA, 50% RB, 20 MHz, 16-QAM)	LTE-FDD	6.42	± 9.6 %
10150	CAE	LTE-FDD (SC-FDMA, 50% RB, 20 MHz, 64-QAM)	LTE-FDD	6.60	± 9.6 %
10151	CAG	LTE-TDD (SC-FDMA, 50% RB, 20 MHz, QPSK)	LTE-TDD	9.28	± 9.6 %
10152	CAG	LTE-TDD (SC-FDMA, 50% RB, 20 MHz, 16-QAM)	LTE-TDD	9.92	± 9.6 %
10153	CAG	LTE-TDD (SC-FDMA, 50% RB, 20 MHz, 64-QAM)	LTE-TDD	10.05	± 9.6 %
10154	CAG	LTE-FDD (SC-FDMA, 50% RB, 10 MHz, QPSK)	LTE-FDD	5.75	± 9.6 %
10155	CAG	LTE-FDD (SC-FDMA, 50% RB, 10 MHz, 16-QAM)	LTE-FDD	6.43	± 9.6 %
10156	CAG	LTE-FDD (SC-FDMA, 50% RB, 5 MHz, QPSK)	LTE-FDD	5.79	± 9.6 %
10157	CAG	LTE-FDD (SC-FDMA, 50% RB, 5 MHz, 16-QAM)	LTE-FDD	6.49	± 9.6 %
10158	CAG	LTE-FDD (SC-FDMA, 50% RB, 10 MHz, 64-QAM)	LTE-FDD	6.62	± 9.6 %
10159	CAG	LTE-FDD (SC-FDMA, 50% RB, 5 MHz, 64-QAM)	LTE-FDD	6.56	± 9.6 %
10160	CAE	LTE-FDD (SC-FDMA, 50% RB, 15 MHz, QPSK)	LTE-FDD	5.82	± 9.6 %
10161	CAE	LTE-FDD (SC-FDMA, 50% RB, 15 MHz, 16-QAM)	LTE-FDD	6.43	± 9.6 %
10162	CAE	LTE-FDD (SC-FDMA, 50% RB, 15 MHz, 64-QAM)	LTE-FDD	6.58	± 9.6 %
10166	CAF	LTE-FDD (SC-FDMA, 50% RB, 1.4 MHz, QPSK)	LTE-FDD	5.46	± 9.6 %
10167	CAF	LTE-FDD (SC-FDMA, 50% RB, 1.4 MHz, 16-QAM)	LTE-FDD	6.21	± 9.6 %
10168	CAF	LTE-FDD (SC-FDMA, 50% RB, 1.4 MHz, 64-QAM)	LTE-FDD	6.79	± 9.6 %
10169	CAE	LTE-FDD (SC-FDMA, 1 RB, 20 MHz, QPSK)	LTE-FDD	5.73	± 9.6 %
10170	CAE	LTE-FDD (SC-FDMA, 1 RB, 20 MHz, 16-QAM)	LTE-FDD	6.52	± 9.6 %
10171	AAE	LTE-FDD (SC-FDMA, 1 RB, 20 MHz, 64-QAM)	LTE-FDD	6.49	± 9.6 %
10172	CAG	LTE-TDD (SC-FDMA, 1 RB, 20 MHz, QPSK)	LTE-TDD	9.21	± 9.6 %
10173	CAG	LTE-TDD (SC-FDMA, 1 RB, 20 MHz, 16-QAM)	LTE-TDD	9.48	± 9.6 %
10174	CAG	LTE-TDD (SC-FDMA, 1 RB, 20 MHz, 64-QAM)	LTE-TDD	10.25	± 9.6 %
10175	CAG	LTE-FDD (SC-FDMA, 1 RB, 10 MHz, QPSK)	LTE-FDD	5.72	± 9.6 %
10176	CAG	LTE-FDD (SC-FDMA, 1 RB, 10 MHz, 16-QAM)	LTE-FDD	6.52	± 9.6 %
10177	CAI	LTE-FDD (SC-FDMA, 1 RB, 5 MHz, QPSK)	LTE-FDD	5.73	± 9.6 %
10178	CAG	LTE-FDD (SC-FDMA, 1 RB, 5 MHz, 16-QAM)	LTE-FDD	6.52	± 9.6 %
10179	CAG	LTE-FDD (SC-FDMA, 1 RB, 10 MHz, 64-QAM)	LTE-FDD	6.50	± 9.6 %
10180	CAG	LTE-FDD (SC-FDMA, 1 RB, 5 MHz, 64-QAM)	LTE-FDD	6.50	± 9.6 %
10181	CAE	LTE-FDD (SC-FDMA, 1 RB, 15 MHz, QPSK)	LTE-FDD	5.73	± 9.6 %



EF3DV3 – SN:4060

May 13, 2022

10182	CAE	LTE-FDD (SC-FDMA, 1 RB, 15 MHz, 16-QAM)	LTE-FDD	6.52	± 9.6 %
10183	AAD	LTE-FDD (SC-FDMA, 1 RB, 15 MHz, 64-QAM)	LTE-FDD	6.50	± 9.6 %
10184	CAE	LTE-FDD (SC-FDMA, 1 RB, 3 MHz, QPSK)	LTE-FDD	5.73	± 9.6 %
10185	CAE	LTE-FDD (SC-FDMA, 1 RB, 3 MHz, 16-QAM)	LTE-FDD	6.51	± 9.6 %
10186	AAE	LTE-FDD (SC-FDMA, 1 RB, 3 MHz, 64-QAM)	LTE-FDD	6.50	± 9.6 %
10187	CAF	LTE-FDD (SC-FDMA, 1 RB, 1.4 MHz, QPSK)	LTE-FDD	5.73	± 9.6 %
10188	CAF	LTE-FDD (SC-FDMA, 1 RB, 1.4 MHz, 16-QAM)	LTE-FDD	6.52	± 9.6 %
10189	AAF	LTE-FDD (SC-FDMA, 1 RB, 1.4 MHz, 64-QAM)	LTE-FDD	6.50	± 9.6 %
10193	CAD	IEEE 802.11n (HT Greenfield, 6.5 Mbps, BPSK)	WLAN	8.09	± 9.6 %
10194	CAD	IEEE 802.11n (HT Greenfield, 39 Mbps, 16-QAM)	WLAN	8.12	± 9.6 %
10195	CAD	IEEE 802.11n (HT Greenfield, 65 Mbps, 64-QAM)	WLAN	8.21	± 9.6 %
10196	CAD	IEEE 802.11n (HT Mixed, 6.5 Mbps, BPSK)	WLAN	8.10	± 9.6 %
10197	CAD	IEEE 802.11n (HT Mixed, 39 Mbps, 16-QAM)	WLAN	8.13	± 9.6 %
10198	CAD	IEEE 802.11n (HT Mixed, 65 Mbps, 64-QAM)	WLAN	8.27	± 9.6 %
10219	CAD	IEEE 802.11n (HT Mixed, 7.2 Mbps, BPSK)	WLAN	8.03	± 9.6 %
10220	CAD	IEEE 802.11n (HT Mixed, 43.3 Mbps, 16-QAM)	WLAN	8.13	± 9.6 %
10221	CAD	IEEE 802.11n (HT Mixed, 72.2 Mbps, 64-QAM)	WLAN	8.27	± 9.6 %
10222	CAD	IEEE 802.11n (HT Mixed, 15 Mbps, BPSK)	WLAN	8.06	± 9.6 %
10223	CAD	IEEE 802.11n (HT Mixed, 90 Mbps, 16-QAM)	WLAN	8.48	± 9.6 %
10224	CAD	IEEE 802.11n (HT Mixed, 150 Mbps, 64-QAM)	WLAN	8.08	± 9.6 %
10225	CAB	UMTS-FDD (HSPA+)	WCDMA	5.97	± 9.6 %
10226	CAB	LTE-TDD (SC-FDMA, 1 RB, 1.4 MHz, 16-QAM)	LTE-TDD	9.49	± 9.6 %
10227	CAB	LTE-TDD (SC-FDMA, 1 RB, 1.4 MHz, 64-QAM)	LTE-TDD	10.26	± 9.6 %
10228	CAB	LTE-TDD (SC-FDMA, 1 RB, 1.4 MHz, QPSK)	LTE-TDD	9.22	± 9.6 %
10229	CAD	LTE-TDD (SC-FDMA, 1 RB, 3 MHz, 16-QAM)	LTE-TDD	9.48	± 9.6 %
10230	CAD	LTE-TDD (SC-FDMA, 1 RB, 3 MHz, 64-QAM)	LTE-TDD	10.25	± 9.6 %
10231	CAD	LTE-TDD (SC-FDMA, 1 RB, 3 MHz, QPSK)	LTE-TDD	9.19	± 9.6 %
10232	CAG	LTE-TDD (SC-FDMA, 1 RB, 5 MHz, 16-QAM)	LTE-TDD	9.48	± 9.6 %
10233	CAG	LTE-TDD (SC-FDMA, 1 RB, 1.4 MHz, QPSK)	LTE-TDD	10.25	± 9.6 %
10234	CAG	LTE-TDD (SC-FDMA, 1 RB, 5 MHz, QPSK)	LTE-TDD	9.21	± 9.6 %
10235	CAG	LTE-TDD (SC-FDMA, 1 RB, 10 MHz, 16-QAM)	LTE-TDD	9.48	± 9.6 %
10236	CAG	LTE-TDD (SC-FDMA, 1 RB, 10 MHz, 64-QAM)	LTE-TDD	10.25	± 9.6 %
10237	CAG	LTE-TDD (SC-FDMA, 1 RB, 10 MHz, QPSK)	LTE-TDD	9.21	± 9.6 %
10238	CAF	LTE-TDD (SC-FDMA, 1 RB, 15 MHz, 16-QAM)	LTE-TDD	9.48	± 9.6 %
10239	CAF	LTE-TDD (SC-FDMA, 1 RB, 15 MHz, 64-QAM)	LTE-TDD	10.25	± 9.6 %
10240	CAF	LTE-TDD (SC-FDMA, 1 RB, 15 MHz, QPSK)	LTE-TDD	9.21	± 9.6 %
10241	CAB	LTE-TDD (SC-FDMA, 50% RB, 1.4 MHz, 16-QAM)	LTE-TDD	9.82	± 9.6 %
10242	CAB	LTE-TDD (SC-FDMA, 50% RB, 1.4 MHz, 64-QAM)	LTE-TDD	9.86	± 9.6 %
10243	CAB	LTE-TDD (SC-FDMA, 50% RB, 1.4 MHz, QPSK)	LTE-TDD	9.46	± 9.6 %
10244	CAD	LTE-TDD (SC-FDMA, 50% RB, 3 MHz, 16-QAM)	LTE-TDD	10.06	± 9.6 %
10245	CAD	LTE-TDD (SC-FDMA, 50% RB, 3 MHz, 64-QAM)	LTE-TDD	10.06	± 9.6 %
10246	CAD	LTE-TDD (SC-FDMA, 50% RB, 3 MHz, QPSK)	LTE-TDD	9.30	± 9.6 %
10247	CAG	LTE-TDD (SC-FDMA, 50% RB, 5 MHz, 16-QAM)	LTE-TDD	9.91	± 9.6 %
10248	CAG	LTE-TDD (SC-FDMA, 50% RB, 5 MHz, 64-QAM)	LTE-TDD	10.09	± 9.6 %
10249	CAG	LTE-TDD (SC-FDMA, 50% RB, 5 MHz, QPSK)	LTE-TDD	9.29	± 9.6 %
10250	CAG	LTE-TDD (SC-FDMA, 50% RB, 10 MHz, 16-QAM)	LTE-TDD	9.81	± 9.6 %
10251	CAG	LTE-TDD (SC-FDMA, 50% RB, 10 MHz, 64-QAM)	LTE-TDD	10.17	± 9.6 %
10252	CAG	LTE-TDD (SC-FDMA, 50% RB, 10 MHz, QPSK)	LTE-TDD	9.24	± 9.6 %
10253	CAF	LTE-TDD (SC-FDMA, 50% RB, 15 MHz, 16-QAM)	LTE-TDD	9.90	± 9.6 %
10254	CAF	LTE-TDD (SC-FDMA, 50% RB, 15 MHz, 64-QAM)	LTE-TDD	10.14	± 9.6 %
10255	CAF	LTE-TDD (SC-FDMA, 50% RB, 15 MHz, QPSK)	LTE-TDD	9.20	± 9.6 %
10256	CAB	LTE-TDD (SC-FDMA, 100% RB, 1.4 MHz, 16-QAM)	LTE-TDD	9.96	± 9.6 %
10257	CAB	LTE-TDD (SC-FDMA, 100% RB, 1.4 MHz, 64-QAM)	LTE-TDD	10.08	± 9.6 %
10258	CAB	LTE-TDD (SC-FDMA, 100% RB, 1.4 MHz, QPSK)	LTE-TDD	9.34	± 9.6 %
10259	CAD	LTE-TDD (SC-FDMA, 100% RB, 3 MHz, 16-QAM)	LTE-TDD	9.98	± 9.6 %
10260	CAD	LTE-TDD (SC-FDMA, 100% RB, 3 MHz, 64-QAM)	LTE-TDD	9.97	± 9.6 %

EF3DV3 – SN:4060

May 13, 2022

10261	CAD	LTE-TDD (SC-FDMA, 100% RB, 3 MHz, QPSK)	LTE-TDD	9.24	± 9.6 %
10262	CAG	LTE-TDD (SC-FDMA, 100% RB, 5 MHz, 16-QAM)	LTE-TDD	9.83	± 9.6 %
10263	CAG	LTE-TDD (SC-FDMA, 100% RB, 5 MHz, 64-QAM)	LTE-TDD	10.16	± 9.6 %
10264	CAG	LTE-TDD (SC-FDMA, 100% RB, 5 MHz, QPSK)	LTE-TDD	9.23	± 9.6 %
10265	CAG	LTE-TDD (SC-FDMA, 100% RB, 10 MHz, 16-QAM)	LTE-TDD	9.92	± 9.6 %
10266	CAG	LTE-TDD (SC-FDMA, 100% RB, 10 MHz, 64-QAM)	LTE-TDD	10.07	± 9.6 %
10267	CAG	LTE-TDD (SC-FDMA, 100% RB, 10 MHz, QPSK)	LTE-TDD	9.30	± 9.6 %
10268	CAF	LTE-TDD (SC-FDMA, 100% RB, 15 MHz, 16-QAM)	LTE-TDD	10.06	± 9.6 %
10269	CAF	LTE-TDD (SC-FDMA, 100% RB, 15 MHz, 64-QAM)	LTE-TDD	10.13	± 9.6 %
10270	CAF	LTE-TDD (SC-FDMA, 100% RB, 15 MHz, QPSK)	LTE-TDD	9.58	± 9.6 %
10274	CAB	UMTS-FDD (HSUPA, Subtest 5, 3GPP Rel8.10)	WCDMA	4.87	± 9.6 %
10275	CAB	UMTS-FDD (HSUPA, Subtest 5, 3GPP Rel8.4)	WCDMA	3.96	± 9.6 %
10277	CAA	PHS (QPSK)	PHS	11.81	± 9.6 %
10278	CAA	PHS (QPSK, BW 884MHz, Rolloff 0.5)	PHS	11.81	± 9.6 %
10279	CAA	PHS (QPSK, BW 884MHz, Rolloff 0.38)	PHS	12.18	± 9.6 %
10290	AAB	CDMA2000, RC1, SO55, Full Rate	CDMA2000	3.91	± 9.6 %
10291	AAB	CDMA2000, RC3, SO55, Full Rate	CDMA2000	3.46	± 9.6 %
10292	AAB	CDMA2000, RC3, SO32, Full Rate	CDMA2000	3.39	± 9.6 %
10293	AAB	CDMA2000, RC3, SO3, Full Rate	CDMA2000	3.50	± 9.6 %
10295	AAB	CDMA2000, RC1, SO3, 1/8th Rate 25 fr.	CDMA2000	12.49	± 9.6 %
10297	AAD	LTE-FDD (SC-FDMA, 50% RB, 20 MHz, QPSK)	LTE-FDD	5.81	± 9.6 %
10298	AAD	LTE-FDD (SC-FDMA, 50% RB, 3 MHz, QPSK)	LTE-FDD	5.72	± 9.6 %
10299	AAD	LTE-FDD (SC-FDMA, 50% RB, 3 MHz, 16-QAM)	LTE-FDD	6.39	± 9.6 %
10300	AAD	LTE-FDD (SC-FDMA, 50% RB, 3 MHz, 64-QAM)	LTE-FDD	6.60	± 9.6 %
10301	AAA	IEEE 802.16e WiMAX (29:18, 5ms, 10MHz, QPSK, PUSC)	WiMAX	12.03	± 9.6 %
10302	AAA	IEEE 802.16e WiMAX (29:18, 5ms, 10MHz, QPSK, PUSC, 3CTRL)	WiMAX	12.57	± 9.6 %
10303	AAA	IEEE 802.16e WiMAX (31:15, 5ms, 10MHz, 64QAM, PUSC)	WiMAX	12.52	± 9.6 %
10304	AAA	IEEE 802.16e WiMAX (29:18, 5ms, 10MHz, 64QAM, PUSC)	WiMAX	11.86	± 9.6 %
10305	AAA	IEEE 802.16e WiMAX (31:15, 10ms, 10MHz, 64QAM, PUSC)	WiMAX	15.24	± 9.6 %
10306	AAA	IEEE 802.16e WiMAX (29:18, 10ms, 10MHz, 64QAM, PUSC)	WiMAX	14.67	± 9.6 %
10307	AAA	IEEE 802.16e WiMAX (29:18, 10ms, 10MHz, QPSK, PUSC)	WiMAX	14.49	± 9.6 %
10308	AAA	IEEE 802.16e WiMAX (29:18, 10ms, 10MHz, 16QAM, PUSC)	WiMAX	14.46	± 9.6 %
10309	AAA	IEEE 802.16e WiMAX (29:18, 10ms, 10MHz, 16QAM, AMC 2x3)	WiMAX	14.58	± 9.6 %
10310	AAA	IEEE 802.16e WiMAX (29:18, 10ms, 10MHz, QPSK, AMC 2x3)	WiMAX	14.57	± 9.6 %
10311	AAD	LTE-FDD (SC-FDMA, 100% RB, 15 MHz, QPSK)	LTE-FDD	6.06	± 9.6 %
10313	AAA	iDEN 1:3	iDEN	10.51	± 9.6 %
10314	AAA	iDEN 1:6	iDEN	13.48	± 9.6 %
10315	AAB	IEEE 802.11b WiFi 2.4 GHz (DSSS, 1 Mbps, 96pc dc)	WLAN	1.71	± 9.6 %
10316	AAB	IEEE 802.11g WiFi 2.4 GHz (ERP-OFDM, 6 Mbps, 96pc dc)	WLAN	8.36	± 9.6 %
10317	AAD	IEEE 802.11a WiFi 5 GHz (OFDM, 6 Mbps, 96pc dc)	WLAN	8.36	± 9.6 %
10352	AAA	Pulse Waveform (200Hz, 10%)	Generic	10.00	± 9.6 %
10353	AAA	Pulse Waveform (200Hz, 20%)	Generic	6.99	± 9.6 %
10354	AAA	Pulse Waveform (200Hz, 40%)	Generic	3.98	± 9.6 %
10355	AAA	Pulse Waveform (200Hz, 60%)	Generic	2.22	± 9.6 %
10356	AAA	Pulse Waveform (200Hz, 80%)	Generic	0.97	± 9.6 %
10387	AAA	QPSK Waveform, 1 MHz	Generic	5.10	± 9.6 %
10388	AAA	QPSK Waveform, 10 MHz	Generic	5.22	± 9.6 %
10396	AAA	64-QAM Waveform, 100 kHz	Generic	6.27	± 9.6 %
10399	AAA	64-QAM Waveform, 40 MHz	Generic	6.27	± 9.6 %
10400	AAE	IEEE 802.11ac WiFi (20MHz, 64-QAM, 99pc dc)	WLAN	8.37	± 9.6 %
10401	AAE	IEEE 802.11ac WiFi (40MHz, 64-QAM, 99pc dc)	WLAN	8.60	± 9.6 %
10402	AAE	IEEE 802.11ac WiFi (80MHz, 64-QAM, 99pc dc)	WLAN	8.53	± 9.6 %
10403	AAB	CDMA2000 (1xEV-DO, Rev. 0)	CDMA2000	3.76	± 9.6 %
10404	AAB	CDMA2000 (1xEV-DO, Rev. A)	CDMA2000	3.77	± 9.6 %
10406	AAB	CDMA2000, RC3, SO32, SCH0, Full Rate	CDMA2000	5.22	± 9.6 %
10410	AAG	LTE-TDD (SC-FDMA, 1 RB, 10 MHz, QPSK, UL Sub=2,3,4,7,8,9)	LTE-TDD	7.82	± 9.6 %

EF3DV3 – SN:4060

May 13, 2022

10414	AAA	WLAN CCDF, 64-QAM, 40MHz	Generic	8.54	± 9.6 %
10415	AAA	IEEE 802.11b WiFi 2.4 GHz (DSSS, 1 Mbps, 99pc dc)	WLAN	1.54	± 9.6 %
10416	AAA	IEEE 802.11g WiFi 2.4 GHz (ERP-OFDM, 6 Mbps, 99pc dc)	WLAN	8.23	± 9.6 %
10417	AAC	IEEE 802.11a/h WiFi 5 GHz (OFDM, 6 Mbps, 99pc dc)	WLAN	8.23	± 9.6 %
10418	AAA	IEEE 802.11g WiFi 2.4 GHz (DSSS-OFDM, 6 Mbps, 99pc, Long)	WLAN	8.14	± 9.6 %
10419	AAA	IEEE 802.11g WiFi 2.4 GHz (DSSS-OFDM, 6 Mbps, 99pc, Short)	WLAN	8.19	± 9.6 %
10422	AAC	IEEE 802.11n (HT Greenfield, 7.2 Mbps, BPSK)	WLAN	8.32	± 9.6 %
10423	AAC	IEEE 802.11n (HT Greenfield, 43.3 Mbps, 16-QAM)	WLAN	8.47	± 9.6 %
10424	AAC	IEEE 802.11n (HT Greenfield, 72.2 Mbps, 64-QAM)	WLAN	8.40	± 9.6 %
10425	AAC	IEEE 802.11n (HT Greenfield, 15 Mbps, BPSK)	WLAN	8.41	± 9.6 %
10426	AAC	IEEE 802.11n (HT Greenfield, 90 Mbps, 16-QAM)	WLAN	8.45	± 9.6 %
10427	AAC	IEEE 802.11n (HT Greenfield, 150 Mbps, 64-QAM)	WLAN	8.41	± 9.6 %
10430	AAD	LTE-FDD (OFDMA, 5 MHz, E-TM 3.1)	LTE-FDD	8.28	± 9.6 %
10431	AAD	LTE-FDD (OFDMA, 10 MHz, E-TM 3.1)	LTE-FDD	8.38	± 9.6 %
10432	AAC	LTE-FDD (OFDMA, 15 MHz, E-TM 3.1)	LTE-FDD	8.34	± 9.6 %
10433	AAC	LTE-FDD (OFDMA, 20 MHz, E-TM 3.1)	LTE-FDD	8.34	± 9.6 %
10434	AAA	W-CDMA (BS Test Model 1, 64 DPCH)	WCDMA	8.60	± 9.6 %
10435	AAF	LTE-TDD (SC-FDMA, 1 RB, 20 MHz, QPSK, UL Sub)	LTE-TDD	7.82	± 9.6 %
10447	AAD	LTE-FDD (OFDMA, 5 MHz, E-TM 3.1, Clipping 44%)	LTE-FDD	7.56	± 9.6 %
10448	AAD	LTE-FDD (OFDMA, 10 MHz, E-TM 3.1, Clipping 44%)	LTE-FDD	7.53	± 9.6 %
10449	AAC	LTE-FDD (OFDMA, 15 MHz, E-TM 3.1, Clipping 44%)	LTE-FDD	7.51	± 9.6 %
10450	AAC	LTE-FDD (OFDMA, 20 MHz, E-TM 3.1, Clipping 44%)	LTE-FDD	7.48	± 9.6 %
10451	AAA	W-CDMA (BS Test Model 1, 64 DPCH, Clipping 44%)	WCDMA	7.59	± 9.6 %
10453	AAD	Validation (Square, 10ms, 1ms)	Test	10.00	± 9.6 %
10456	AAC	IEEE 802.11ac WiFi (160MHz, 64-QAM, 99pc dc)	WLAN	8.63	± 9.6 %
10457	AAA	UMTS-FDD (DC-HSDPA)	WCDMA	6.62	± 9.6 %
10458	AAA	CDMA2000 (1xEV-DO, Rev. B, 2 carriers)	CDMA2000	6.55	± 9.6 %
10459	AAA	CDMA2000 (1xEV-DO, Rev. B, 3 carriers)	CDMA2000	8.25	± 9.6 %
10460	AAA	UMTS-FDD (WCDMA, AMR)	WCDMA	2.39	± 9.6 %
10461	AAB	LTE-TDD (SC-FDMA, 1 RB, 1.4 MHz, QPSK, UL Sub)	LTE-TDD	7.82	± 9.6 %
10462	AAB	LTE-TDD (SC-FDMA, 1 RB, 1.4 MHz, 16-QAM, UL Sub)	LTE-TDD	8.30	± 9.6 %
10463	AAB	LTE-TDD (SC-FDMA, 1 RB, 1.4 MHz, 64-QAM, UL Sub)	LTE-TDD	8.56	± 9.6 %
10464	AAC	LTE-TDD (SC-FDMA, 1 RB, 3 MHz, QPSK, UL Sub)	LTE-TDD	7.82	± 9.6 %
10465	AAC	LTE-TDD (SC-FDMA, 1 RB, 3 MHz, 16-QAM, UL Sub)	LTE-TDD	8.32	± 9.6 %
10466	AAC	LTE-TDD (SC-FDMA, 1 RB, 3 MHz, 64-QAM, UL Sub)	LTE-TDD	8.57	± 9.6 %
10467	AAF	LTE-TDD (SC-FDMA, 1 RB, 5 MHz, QPSK, UL Sub)	LTE-TDD	7.82	± 9.6 %
10468	AAF	LTE-TDD (SC-FDMA, 1 RB, 5 MHz, 16-QAM, UL Sub)	LTE-TDD	8.32	± 9.6 %
10469	AAF	LTE-TDD (SC-FDMA, 1 RB, 5 MHz, 64-QAM, UL Sub)	LTE-TDD	8.56	± 9.6 %
10470	AAF	LTE-TDD (SC-FDMA, 1 RB, 10 MHz, QPSK, UL Sub)	LTE-TDD	7.82	± 9.6 %
10471	AAF	LTE-TDD (SC-FDMA, 1 RB, 10 MHz, 16-QAM, UL Sub)	LTE-TDD	8.32	± 9.6 %
10472	AAF	LTE-TDD (SC-FDMA, 1 RB, 10 MHz, 64-QAM, UL Sub)	LTE-TDD	8.57	± 9.6 %
10473	AAE	LTE-TDD (SC-FDMA, 1 RB, 15 MHz, QPSK, UL Sub)	LTE-TDD	7.82	± 9.6 %
10474	AAE	LTE-TDD (SC-FDMA, 1 RB, 15 MHz, 16-QAM, UL Sub)	LTE-TDD	8.32	± 9.6 %
10475	AAE	LTE-TDD (SC-FDMA, 1 RB, 15 MHz, 64-QAM, UL Sub)	LTE-TDD	8.57	± 9.6 %
10477	AAF	LTE-TDD (SC-FDMA, 1 RB, 20 MHz, 16-QAM, UL Sub)	LTE-TDD	8.32	± 9.6 %
10478	AAF	LTE-TDD (SC-FDMA, 1 RB, 20 MHz, 64-QAM, UL Sub)	LTE-TDD	8.57	± 9.6 %
10479	AAB	LTE-TDD (SC-FDMA, 50% RB, 1.4 MHz, QPSK, UL Sub)	LTE-TDD	7.74	± 9.6 %
10480	AAB	LTE-TDD (SC-FDMA, 50% RB, 1.4 MHz, 16-QAM, UL Sub)	LTE-TDD	8.18	± 9.6 %
10481	AAB	LTE-TDD (SC-FDMA, 50% RB, 1.4 MHz, 64-QAM, UL Sub)	LTE-TDD	8.45	± 9.6 %
10482	AAC	LTE-TDD (SC-FDMA, 50% RB, 3 MHz, QPSK, UL Sub)	LTE-TDD	7.71	± 9.6 %
10483	AAC	LTE-TDD (SC-FDMA, 50% RB, 3 MHz, 16-QAM, Sub)	LTE-TDD	8.39	± 9.6 %
10484	AAC	LTE-TDD (SC-FDMA, 50% RB, 3 MHz, 64-QAM, UL Sub)	LTE-TDD	8.47	± 9.6 %
10485	AAF	LTE-TDD (SC-FDMA, 50% RB, 5 MHz, QPSK, UL Sub)	LTE-TDD	7.59	± 9.6 %
10486	AAF	LTE-TDD (SC-FDMA, 50% RB, 5 MHz, 16-QAM, UL Sub)	LTE-TDD	8.38	± 9.6 %
10487	AAF	LTE-TDD (SC-FDMA, 50% RB, 5 MHz, 64-QAM, UL Sub)	LTE-TDD	8.60	± 9.6 %
10488	AAF	LTE-TDD (SC-FDMA, 50% RB, 10 MHz, QPSK, UL Sub)	LTE-TDD	7.70	± 9.6 %

EF3DV3 – SN-4060

May 13, 2022

10489	AAF	LTE-TDD (SC-FDMA, 50% RB, 10 MHz, 16-QAM, UL Sub)	LTE-TDD	8.31	± 9.6 %
10490	AAF	LTE-TDD (SC-FDMA, 50% RB, 10 MHz, 64-QAM, UL Sub)	LTE-TDD	8.54	± 9.6 %
10491	AAE	LTE-TDD (SC-FDMA, 50% RB, 15 MHz, QPSK, UL Sub)	LTE-TDD	7.74	± 9.6 %
10492	AAE	LTE-TDD (SC-FDMA, 50% RB, 15 MHz, 16-QAM, UL Sub)	LTE-TDD	8.41	± 9.6 %
10493	AAE	LTE-TDD (SC-FDMA, 50% RB, 15 MHz, 64-QAM, UL Sub)	LTE-TDD	8.55	± 9.6 %
10494	AAF	LTE-TDD (SC-FDMA, 50% RB, 20 MHz, QPSK, UL Sub)	LTE-TDD	7.74	± 9.6 %
10495	AAF	LTE-TDD (SC-FDMA, 50% RB, 20 MHz, 16-QAM, UL Sub)	LTE-TDD	8.37	± 9.6 %
10496	AAF	LTE-TDD (SC-FDMA, 50% RB, 20 MHz, 64-QAM, UL Sub)	LTE-TDD	8.54	± 9.6 %
10497	AAB	LTE-TDD (SC-FDMA, 100% RB, 1.4 MHz, QPSK, UL Sub)	LTE-TDD	7.67	± 9.6 %
10498	AAB	LTE-TDD (SC-FDMA, 100% RB, 1.4 MHz, 16-QAM, UL Sub)	LTE-TDD	8.40	± 9.6 %
10499	AAB	LTE-TDD (SC-FDMA, 100% RB, 1.4 MHz, 64-QAM, UL Sub)	LTE-TDD	8.68	± 9.6 %
10500	AAC	LTE-TDD (SC-FDMA, 100% RB, 3 MHz, QPSK, UL Sub)	LTE-TDD	7.67	± 9.6 %
10501	AAC	LTE-TDD (SC-FDMA, 100% RB, 3 MHz, 16-QAM, UL Sub)	LTE-TDD	8.44	± 9.6 %
10502	AAC	LTE-TDD (SC-FDMA, 100% RB, 3 MHz, 64-QAM, UL Sub)	LTE-TDD	8.52	± 9.6 %
10503	AAF	LTE-TDD (SC-FDMA, 100% RB, 5 MHz, QPSK, UL Sub)	LTE-TDD	7.72	± 9.6 %
10504	AAF	LTE-TDD (SC-FDMA, 100% RB, 5 MHz, 16-QAM, UL Sub)	LTE-TDD	8.31	± 9.6 %
10505	AAF	LTE-TDD (SC-FDMA, 100% RB, 5 MHz, 64-QAM, UL Sub)	LTE-TDD	8.54	± 9.6 %
10506	AAF	LTE-TDD (SC-FDMA, 100% RB, 10 MHz, QPSK, UL Sub)	LTE-TDD	7.74	± 9.6 %
10507	AAF	LTE-TDD (SC-FDMA, 100% RB, 10 MHz, 16-QAM, UL Sub)	LTE-TDD	8.36	± 9.6 %
10508	AAF	LTE-TDD (SC-FDMA, 100% RB, 10 MHz, 64-QAM, UL Sub)	LTE-TDD	8.55	± 9.6 %
10509	AAE	LTE-TDD (SC-FDMA, 100% RB, 15 MHz, QPSK, UL Sub)	LTE-TDD	7.99	± 9.6 %
10510	AAE	LTE-TDD (SC-FDMA, 100% RB, 15 MHz, 16-QAM, UL Sub)	LTE-TDD	8.49	± 9.6 %
10511	AAE	LTE-TDD (SC-FDMA, 100% RB, 15 MHz, 64-QAM, UL Sub)	LTE-TDD	8.51	± 9.6 %
10512	AAF	LTE-TDD (SC-FDMA, 100% RB, 20 MHz, QPSK, UL Sub)	LTE-TDD	7.74	± 9.6 %
10513	AAF	LTE-TDD (SC-FDMA, 100% RB, 20 MHz, 16-QAM, UL Sub)	LTE-TDD	8.42	± 9.6 %
10514	AAF	LTE-TDD (SC-FDMA, 100% RB, 20 MHz, 64-QAM, UL Sub)	LTE-TDD	8.45	± 9.6 %
10515	AAA	IEEE 802.11b WiFi 2.4 GHz (DSSS, 2 Mbps, 99pc dc)	WLAN	1.58	± 9.6 %
10516	AAA	IEEE 802.11b WiFi 2.4 GHz (DSSS, 5.5 Mbps, 99pc dc)	WLAN	1.57	± 9.6 %
10517	AAA	IEEE 802.11b WiFi 2.4 GHz (DSSS, 11 Mbps, 99pc dc)	WLAN	1.58	± 9.6 %
10518	AAC	IEEE 802.11a/h WiFi 5 GHz (OFDM, 9 Mbps, 99pc dc)	WLAN	8.23	± 9.6 %
10519	AAC	IEEE 802.11a/h WiFi 5 GHz (OFDM, 12 Mbps, 99pc dc)	WLAN	8.39	± 9.6 %
10520	AAC	IEEE 802.11a/h WiFi 5 GHz (OFDM, 18 Mbps, 99pc dc)	WLAN	8.12	± 9.6 %
10521	AAC	IEEE 802.11a/h WiFi 5 GHz (OFDM, 24 Mbps, 99pc dc)	WLAN	7.97	± 9.6 %
10522	AAC	IEEE 802.11a/h WiFi 5 GHz (OFDM, 36 Mbps, 99pc dc)	WLAN	8.45	± 9.6 %
10523	AAC	IEEE 802.11a/h WiFi 5 GHz (OFDM, 48 Mbps, 99pc dc)	WLAN	8.08	± 9.6 %
10524	AAC	IEEE 802.11a/h WiFi 5 GHz (OFDM, 54 Mbps, 99pc dc)	WLAN	8.27	± 9.6 %
10525	AAC	IEEE 802.11ac WiFi (20MHz, MCS0, 99pc dc)	WLAN	8.36	± 9.6 %
10526	AAC	IEEE 802.11ac WiFi (20MHz, MCS1, 99pc dc)	WLAN	8.42	± 9.6 %
10527	AAC	IEEE 802.11ac WiFi (20MHz, MCS2, 99pc dc)	WLAN	8.21	± 9.6 %
10528	AAC	IEEE 802.11ac WiFi (20MHz, MCS3, 99pc dc)	WLAN	8.36	± 9.6 %
10529	AAC	IEEE 802.11ac WiFi (20MHz, MCS4, 99pc dc)	WLAN	8.36	± 9.6 %
10531	AAC	IEEE 802.11ac WiFi (20MHz, MCS6, 99pc dc)	WLAN	8.43	± 9.6 %
10532	AAC	IEEE 802.11ac WiFi (20MHz, MCS7, 99pc dc)	WLAN	8.29	± 9.6 %
10533	AAC	IEEE 802.11ac WiFi (20MHz, MCS8, 99pc dc)	WLAN	8.38	± 9.6 %
10534	AAC	IEEE 802.11ac WiFi (40MHz, MCS0, 99pc dc)	WLAN	8.45	± 9.6 %
10535	AAC	IEEE 802.11ac WiFi (40MHz, MCS1, 99pc dc)	WLAN	8.45	± 9.6 %
10536	AAC	IEEE 802.11ac WiFi (40MHz, MCS2, 99pc dc)	WLAN	8.32	± 9.6 %
10537	AAC	IEEE 802.11ac WiFi (40MHz, MCS3, 99pc dc)	WLAN	8.44	± 9.6 %
10538	AAC	IEEE 802.11ac WiFi (40MHz, MCS4, 99pc dc)	WLAN	8.54	± 9.6 %
10540	AAC	IEEE 802.11ac WiFi (40MHz, MCS6, 99pc dc)	WLAN	8.39	± 9.6 %
10541	AAC	IEEE 802.11ac WiFi (40MHz, MCS7, 99pc dc)	WLAN	8.46	± 9.6 %
10542	AAC	IEEE 802.11ac WiFi (40MHz, MCS8, 99pc dc)	WLAN	8.65	± 9.6 %
10543	AAC	IEEE 802.11ac WiFi (40MHz, MCS9, 99pc dc)	WLAN	8.65	± 9.6 %
10544	AAC	IEEE 802.11ac WiFi (80MHz, MCS0, 99pc dc)	WLAN	8.47	± 9.6 %
10545	AAC	IEEE 802.11ac WiFi (80MHz, MCS1, 99pc dc)	WLAN	8.55	± 9.6 %
10546	AAC	IEEE 802.11ac WiFi (80MHz, MCS2, 99pc dc)	WLAN	8.35	± 9.6 %

EF3DV3 – SN-4060

May 13, 2022

10547	AAC	IEEE 802.11ac WiFi (80MHz, MCS3, 99pc dc)	WLAN	8.49	± 9.6 %
10548	AAC	IEEE 802.11ac WiFi (80MHz, MCS4, 99pc dc)	WLAN	8.37	± 9.6 %
10550	AAC	IEEE 802.11ac WiFi (80MHz, MCS6, 99pc dc)	WLAN	8.39	± 9.6 %
10551	AAC	IEEE 802.11ac WiFi (80MHz, MCS7, 99pc dc)	WLAN	8.50	± 9.6 %
10552	AAC	IEEE 802.11ac WiFi (80MHz, MCS8, 99pc dc)	WLAN	8.42	± 9.6 %
10553	AAC	IEEE 802.11ac WiFi (80MHz, MCS9, 99pc dc)	WLAN	8.45	± 9.6 %
10554	AAD	IEEE 802.11ac WiFi (160MHz, MCS0, 99pc dc)	WLAN	8.48	± 9.6 %
10555	AAD	IEEE 802.11ac WiFi (160MHz, MCS1, 99pc dc)	WLAN	8.47	± 9.6 %
10556	AAD	IEEE 802.11ac WiFi (160MHz, MCS2, 99pc dc)	WLAN	8.50	± 9.6 %
10557	AAD	IEEE 802.11ac WiFi (160MHz, MCS3, 99pc dc)	WLAN	8.52	± 9.6 %
10558	AAD	IEEE 802.11ac WiFi (160MHz, MCS4, 99pc dc)	WLAN	8.61	± 9.6 %
10560	AAD	IEEE 802.11ac WiFi (160MHz, MCS6, 99pc dc)	WLAN	8.73	± 9.6 %
10561	AAD	IEEE 802.11ac WiFi (160MHz, MCS7, 99pc dc)	WLAN	8.56	± 9.6 %
10562	AAD	IEEE 802.11ac WiFi (160MHz, MCS8, 99pc dc)	WLAN	8.69	± 9.6 %
10563	AAD	IEEE 802.11ac WiFi (160MHz, MCS9, 99pc dc)	WLAN	8.77	± 9.6 %
10564	AAA	IEEE 802.11g WiFi 2.4 GHz (DSSS-OFDM, 9 Mbps, 99pc dc)	WLAN	8.25	± 9.6 %
10565	AAA	IEEE 802.11g WiFi 2.4 GHz (DSSS-OFDM, 12 Mbps, 99pc dc)	WLAN	8.45	± 9.6 %
10566	AAA	IEEE 802.11g WiFi 2.4 GHz (DSSS-OFDM, 18 Mbps, 99pc dc)	WLAN	8.13	± 9.6 %
10567	AAA	IEEE 802.11g WiFi 2.4 GHz (DSSS-OFDM, 24 Mbps, 99pc dc)	WLAN	8.00	± 9.6 %
10568	AAA	IEEE 802.11g WiFi 2.4 GHz (DSSS-OFDM, 36 Mbps, 99pc dc)	WLAN	8.37	± 9.6 %
10569	AAA	IEEE 802.11g WiFi 2.4 GHz (DSSS-OFDM, 48 Mbps, 99pc dc)	WLAN	8.10	± 9.6 %
10570	AAA	IEEE 802.11g WiFi 2.4 GHz (DSSS-OFDM, 54 Mbps, 99pc dc)	WLAN	8.30	± 9.6 %
10571	AAA	IEEE 802.11b WiFi 2.4 GHz (DSSS, 1 Mbps, 90pc dc)	WLAN	1.99	± 9.6 %
10572	AAA	IEEE 802.11b WiFi 2.4 GHz (DSSS, 2 Mbps, 90pc dc)	WLAN	1.99	± 9.6 %
10573	AAA	IEEE 802.11b WiFi 2.4 GHz (DSSS, 5.5 Mbps, 90pc dc)	WLAN	1.98	± 9.6 %
10574	AAA	IEEE 802.11b WiFi 2.4 GHz (DSSS, 11 Mbps, 90pc dc)	WLAN	1.98	± 9.6 %
10575	AAA	IEEE 802.11g WiFi 2.4 GHz (DSSS-OFDM, 6 Mbps, 90pc dc)	WLAN	8.59	± 9.6 %
10576	AAA	IEEE 802.11g WiFi 2.4 GHz (DSSS-OFDM, 9 Mbps, 90pc dc)	WLAN	8.60	± 9.6 %
10577	AAA	IEEE 802.11g WiFi 2.4 GHz (DSSS-OFDM, 12 Mbps, 90pc dc)	WLAN	8.70	± 9.6 %
10578	AAA	IEEE 802.11g WiFi 2.4 GHz (DSSS-OFDM, 18 Mbps, 90pc dc)	WLAN	8.49	± 9.6 %
10579	AAA	IEEE 802.11g WiFi 2.4 GHz (DSSS-OFDM, 24 Mbps, 90pc dc)	WLAN	8.36	± 9.6 %
10580	AAA	IEEE 802.11g WiFi 2.4 GHz (DSSS-OFDM, 36 Mbps, 90pc dc)	WLAN	8.76	± 9.6 %
10581	AAA	IEEE 802.11g WiFi 2.4 GHz (DSSS-OFDM, 48 Mbps, 90pc dc)	WLAN	8.35	± 9.6 %
10582	AAA	IEEE 802.11g WiFi 2.4 GHz (DSSS-OFDM, 54 Mbps, 90pc dc)	WLAN	8.67	± 9.6 %
10583	AAC	IEEE 802.11a/h WiFi 5 GHz (OFDM, 6 Mbps, 90pc dc)	WLAN	8.59	± 9.6 %
10584	AAC	IEEE 802.11a/h WiFi 5 GHz (OFDM, 9 Mbps, 90pc dc)	WLAN	8.60	± 9.6 %
10585	AAC	IEEE 802.11a/h WiFi 5 GHz (OFDM, 12 Mbps, 90pc dc)	WLAN	8.70	± 9.6 %
10586	AAC	IEEE 802.11a/h WiFi 5 GHz (OFDM, 18 Mbps, 90pc dc)	WLAN	8.49	± 9.6 %
10587	AAC	IEEE 802.11a/h WiFi 5 GHz (OFDM, 24 Mbps, 90pc dc)	WLAN	8.36	± 9.6 %
10588	AAC	IEEE 802.11a/h WiFi 5 GHz (OFDM, 36 Mbps, 90pc dc)	WLAN	8.76	± 9.6 %
10589	AAC	IEEE 802.11a/h WiFi 5 GHz (OFDM, 48 Mbps, 90pc dc)	WLAN	8.35	± 9.6 %
10590	AAC	IEEE 802.11a/h WiFi 5 GHz (OFDM, 54 Mbps, 90pc dc)	WLAN	8.67	± 9.6 %
10591	AAC	IEEE 802.11n (HT Mixed, 20MHz, MCS0, 90pc dc)	WLAN	8.63	± 9.6 %
10592	AAC	IEEE 802.11n (HT Mixed, 20MHz, MCS1, 90pc dc)	WLAN	8.79	± 9.6 %
10593	AAC	IEEE 802.11n (HT Mixed, 20MHz, MCS2, 90pc dc)	WLAN	8.64	± 9.6 %
10594	AAC	IEEE 802.11n (HT Mixed, 20MHz, MCS3, 90pc dc)	WLAN	8.74	± 9.6 %
10595	AAC	IEEE 802.11n (HT Mixed, 20MHz, MCS4, 90pc dc)	WLAN	8.74	± 9.6 %
10596	AAC	IEEE 802.11n (HT Mixed, 20MHz, MCS5, 90pc dc)	WLAN	8.71	± 9.6 %
10597	AAC	IEEE 802.11n (HT Mixed, 20MHz, MCS6, 90pc dc)	WLAN	8.72	± 9.6 %
10598	AAC	IEEE 802.11n (HT Mixed, 20MHz, MCS7, 90pc dc)	WLAN	8.50	± 9.6 %
10599	AAC	IEEE 802.11n (HT Mixed, 40MHz, MCS0, 90pc dc)	WLAN	8.79	± 9.6 %
10600	AAC	IEEE 802.11n (HT Mixed, 40MHz, MCS1, 90pc dc)	WLAN	8.88	± 9.6 %
10601	AAC	IEEE 802.11n (HT Mixed, 40MHz, MCS2, 90pc dc)	WLAN	8.82	± 9.6 %
10602	AAC	IEEE 802.11n (HT Mixed, 40MHz, MCS3, 90pc dc)	WLAN	8.94	± 9.6 %
10603	AAC	IEEE 802.11n (HT Mixed, 40MHz, MCS4, 90pc dc)	WLAN	9.03	± 9.6 %
10604	AAC	IEEE 802.11n (HT Mixed, 40MHz, MCS5, 90pc dc)	WLAN	8.76	± 9.6 %



EF3DV3 – SN:4060

May 13, 2022

10605	AAC	IEEE 802.11n (HT Mixed, 40MHz, MCS6, 90pc dc)	WLAN	8.97	± 9.6 %
10606	AAC	IEEE 802.11n (HT Mixed, 40MHz, MCS7, 90pc dc)	WLAN	8.82	± 9.6 %
10607	AAC	IEEE 802.11ac WiFi (20MHz, MCS0, 90pc dc)	WLAN	8.64	± 9.6 %
10608	AAC	IEEE 802.11ac WiFi (20MHz, MCS1, 90pc dc)	WLAN	8.77	± 9.6 %
10609	AAC	IEEE 802.11ac WiFi (20MHz, MCS2, 90pc dc)	WLAN	8.57	± 9.6 %
10610	AAC	IEEE 802.11ac WiFi (20MHz, MCS3, 90pc dc)	WLAN	8.78	± 9.6 %
10611	AAC	IEEE 802.11ac WiFi (20MHz, MCS4, 90pc dc)	WLAN	8.70	± 9.6 %
10612	AAC	IEEE 802.11ac WiFi (20MHz, MCS5, 90pc dc)	WLAN	8.77	± 9.6 %
10613	AAC	IEEE 802.11ac WiFi (20MHz, MCS6, 90pc dc)	WLAN	8.94	± 9.6 %
10614	AAC	IEEE 802.11ac WiFi (20MHz, MCS7, 90pc dc)	WLAN	8.59	± 9.6 %
10615	AAC	IEEE 802.11ac WiFi (20MHz, MCS8, 90pc dc)	WLAN	8.82	± 9.6 %
10616	AAC	IEEE 802.11ac WiFi (40MHz, MCS0, 90pc dc)	WLAN	8.82	± 9.6 %
10617	AAC	IEEE 802.11ac WiFi (40MHz, MCS1, 90pc dc)	WLAN	8.81	± 9.6 %
10618	AAC	IEEE 802.11ac WiFi (40MHz, MCS2, 90pc dc)	WLAN	8.58	± 9.6 %
10619	AAC	IEEE 802.11ac WiFi (40MHz, MCS3, 90pc dc)	WLAN	8.86	± 9.6 %
10620	AAC	IEEE 802.11ac WiFi (40MHz, MCS4, 90pc dc)	WLAN	8.87	± 9.6 %
10621	AAC	IEEE 802.11ac WiFi (40MHz, MCS5, 90pc dc)	WLAN	8.77	± 9.6 %
10622	AAC	IEEE 802.11ac WiFi (40MHz, MCS6, 90pc dc)	WLAN	8.68	± 9.6 %
10623	AAC	IEEE 802.11ac WiFi (40MHz, MCS7, 90pc dc)	WLAN	8.82	± 9.6 %
10624	AAC	IEEE 802.11ac WiFi (40MHz, MCS8, 90pc dc)	WLAN	8.96	± 9.6 %
10625	AAC	IEEE 802.11ac WiFi (40MHz, MCS9, 90pc dc)	WLAN	8.96	± 9.6 %
10626	AAC	IEEE 802.11ac WiFi (80MHz, MCS0, 90pc dc)	WLAN	8.83	± 9.6 %
10627	AAC	IEEE 802.11ac WiFi (80MHz, MCS1, 90pc dc)	WLAN	8.88	± 9.6 %
10628	AAC	IEEE 802.11ac WiFi (80MHz, MCS2, 90pc dc)	WLAN	8.71	± 9.6 %
10629	AAC	IEEE 802.11ac WiFi (80MHz, MCS3, 90pc dc)	WLAN	8.85	± 9.6 %
10630	AAC	IEEE 802.11ac WiFi (80MHz, MCS4, 90pc dc)	WLAN	8.72	± 9.6 %
10631	AAC	IEEE 802.11ac WiFi (80MHz, MCS5, 90pc dc)	WLAN	8.81	± 9.6 %
10632	AAC	IEEE 802.11ac WiFi (80MHz, MCS6, 90pc dc)	WLAN	8.74	± 9.6 %
10633	AAC	IEEE 802.11ac WiFi (80MHz, MCS7, 90pc dc)	WLAN	8.83	± 9.6 %
10634	AAC	IEEE 802.11ac WiFi (80MHz, MCS8, 90pc dc)	WLAN	8.80	± 9.6 %
10635	AAC	IEEE 802.11ac WiFi (80MHz, MCS9, 90pc dc)	WLAN	8.81	± 9.6 %
10636	AAD	IEEE 802.11ac WiFi (160MHz, MCS0, 90pc dc)	WLAN	8.83	± 9.6 %
10637	AAD	IEEE 802.11ac WiFi (160MHz, MCS1, 90pc dc)	WLAN	8.79	± 9.6 %
10638	AAD	IEEE 802.11ac WiFi (160MHz, MCS2, 90pc dc)	WLAN	8.86	± 9.6 %
10639	AAD	IEEE 802.11ac WiFi (160MHz, MCS3, 90pc dc)	WLAN	8.85	± 9.6 %
10640	AAD	IEEE 802.11ac WiFi (160MHz, MCS4, 90pc dc)	WLAN	8.98	± 9.6 %
10641	AAD	IEEE 802.11ac WiFi (160MHz, MCS5, 90pc dc)	WLAN	9.06	± 9.6 %
10642	AAD	IEEE 802.11ac WiFi (160MHz, MCS6, 90pc dc)	WLAN	9.06	± 9.6 %
10643	AAD	IEEE 802.11ac WiFi (160MHz, MCS7, 90pc dc)	WLAN	8.89	± 9.6 %
10644	AAD	IEEE 802.11ac WiFi (160MHz, MCS8, 90pc dc)	WLAN	9.05	± 9.6 %
10645	AAD	IEEE 802.11ac WiFi (160MHz, MCS9, 90pc dc)	WLAN	9.11	± 9.6 %
10646	AAG	LTE-TDD (SC-FDMA, 1 RB, 5 MHz, QPSK, UL Sub=2,7)	LTE-TDD	11.96	± 9.6 %
10647	AAF	LTE-TDD (SC-FDMA, 1 RB, 20 MHz, QPSK, UL Sub=2,7)	LTE-TDD	11.96	± 9.6 %
10648	AAA	CDMA2000 (1x Advanced)	CDMA2000	3.45	± 9.6 %
10652	AAE	LTE-TDD (OFDMA, 5 MHz, E-TM 3.1, Clipping 44%)	LTE-TDD	6.91	± 9.6 %
10653	AAE	LTE-TDD (OFDMA, 10 MHz, E-TM 3.1, Clipping 44%)	LTE-TDD	7.42	± 9.6 %
10654	AAD	LTE-TDD (OFDMA, 15 MHz, E-TM 3.1, Clipping 44%)	LTE-TDD	6.96	± 9.6 %
10655	AAE	LTE-TDD (OFDMA, 20 MHz, E-TM 3.1, Clipping 44%)	LTE-TDD	7.21	± 9.6 %
10658	AAA	Pulse Waveform (200Hz, 10%)	Test	10.00	± 9.6 %
10659	AAA	Pulse Waveform (200Hz, 20%)	Test	6.99	± 9.6 %
10660	AAA	Pulse Waveform (200Hz, 40%)	Test	3.98	± 9.6 %
10661	AAA	Pulse Waveform (200Hz, 60%)	Test	2.22	± 9.6 %
10662	AAA	Pulse Waveform (200Hz, 80%)	Test	0.97	± 9.6 %
10670	AAA	Bluetooth Low Energy	Bluetooth	2.19	± 9.6 %
10671	AAC	IEEE 802.11ax (20MHz, MCS0, 90pc dc)	WLAN	9.09	± 9.6 %
10672	AAC	IEEE 802.11ax (20MHz, MCS1, 90pc dc)	WLAN	8.57	± 9.6 %

Certificate No: EF3-4060\_May22

Page 17 of 23



EF3DV3 – SN:4060

May 13, 2022

10673	AAC	IEEE 802.11ax (20MHz, MCS2, 90pc dc)	WLAN	8.78	± 9.6 %
10674	AAC	IEEE 802.11ax (20MHz, MCS3, 90pc dc)	WLAN	8.74	± 9.6 %
10675	AAC	IEEE 802.11ax (20MHz, MCS4, 90pc dc)	WLAN	8.90	± 9.6 %
10676	AAC	IEEE 802.11ax (20MHz, MCS5, 90pc dc)	WLAN	8.77	± 9.6 %
10677	AAC	IEEE 802.11ax (20MHz, MCS6, 90pc dc)	WLAN	8.73	± 9.6 %
10678	AAC	IEEE 802.11ax (20MHz, MCS7, 90pc dc)	WLAN	8.78	± 9.6 %
10679	AAC	IEEE 802.11ax (20MHz, MCS8, 90pc dc)	WLAN	8.89	± 9.6 %
10680	AAC	IEEE 802.11ax (20MHz, MCS9, 90pc dc)	WLAN	8.80	± 9.6 %
10681	AAC	IEEE 802.11ax (20MHz, MCS10, 90pc dc)	WLAN	8.62	± 9.6 %
10682	AAC	IEEE 802.11ax (20MHz, MCS11, 90pc dc)	WLAN	8.83	± 9.6 %
10683	AAC	IEEE 802.11ax (20MHz, MCS0, 99pc dc)	WLAN	8.42	± 9.6 %
10684	AAC	IEEE 802.11ax (20MHz, MCS1, 99pc dc)	WLAN	8.26	± 9.6 %
10685	AAC	IEEE 802.11ax (20MHz, MCS2, 99pc dc)	WLAN	8.33	± 9.6 %
10686	AAC	IEEE 802.11ax (20MHz, MCS3, 99pc dc)	WLAN	8.28	± 9.6 %
10687	AAC	IEEE 802.11ax (20MHz, MCS4, 99pc dc)	WLAN	8.45	± 9.6 %
10688	AAC	IEEE 802.11ax (20MHz, MCS5, 99pc dc)	WLAN	8.29	± 9.6 %
10689	AAC	IEEE 802.11ax (20MHz, MCS6, 99pc dc)	WLAN	8.55	± 9.6 %
10690	AAC	IEEE 802.11ax (20MHz, MCS7, 99pc dc)	WLAN	8.29	± 9.6 %
10691	AAC	IEEE 802.11ax (20MHz, MCS8, 99pc dc)	WLAN	8.25	± 9.6 %
10692	AAC	IEEE 802.11ax (20MHz, MCS9, 99pc dc)	WLAN	8.29	± 9.6 %
10693	AAC	IEEE 802.11ax (20MHz, MCS10, 99pc dc)	WLAN	8.25	± 9.6 %
10694	AAC	IEEE 802.11ax (20MHz, MCS11, 99pc dc)	WLAN	8.57	± 9.6 %
10695	AAC	IEEE 802.11ax (40MHz, MCS0, 90pc dc)	WLAN	8.78	± 9.6 %
10696	AAC	IEEE 802.11ax (40MHz, MCS1, 90pc dc)	WLAN	8.91	± 9.6 %
10697	AAC	IEEE 802.11ax (40MHz, MCS2, 90pc dc)	WLAN	8.61	± 9.6 %
10698	AAC	IEEE 802.11ax (40MHz, MCS3, 90pc dc)	WLAN	8.89	± 9.6 %
10699	AAC	IEEE 802.11ax (40MHz, MCS4, 90pc dc)	WLAN	8.82	± 9.6 %
10700	AAC	IEEE 802.11ax (40MHz, MCS5, 90pc dc)	WLAN	8.73	± 9.6 %
10701	AAC	IEEE 802.11ax (40MHz, MCS6, 90pc dc)	WLAN	8.86	± 9.6 %
10702	AAC	IEEE 802.11ax (40MHz, MCS7, 90pc dc)	WLAN	8.70	± 9.6 %
10703	AAC	IEEE 802.11ax (40MHz, MCS8, 90pc dc)	WLAN	8.82	± 9.6 %
10704	AAC	IEEE 802.11ax (40MHz, MCS9, 90pc dc)	WLAN	8.56	± 9.6 %
10705	AAC	IEEE 802.11ax (40MHz, MCS10, 90pc dc)	WLAN	8.69	± 9.6 %
10706	AAC	IEEE 802.11ax (40MHz, MCS11, 90pc dc)	WLAN	8.66	± 9.6 %
10707	AAC	IEEE 802.11ax (40MHz, MCS0, 99pc dc)	WLAN	8.32	± 9.6 %
10708	AAC	IEEE 802.11ax (40MHz, MCS1, 99pc dc)	WLAN	8.55	± 9.6 %
10709	AAC	IEEE 802.11ax (40MHz, MCS2, 99pc dc)	WLAN	8.33	± 9.6 %
10710	AAC	IEEE 802.11ax (40MHz, MCS3, 99pc dc)	WLAN	8.29	± 9.6 %
10711	AAC	IEEE 802.11ax (40MHz, MCS4, 99pc dc)	WLAN	8.39	± 9.6 %
10712	AAC	IEEE 802.11ax (40MHz, MCS5, 99pc dc)	WLAN	8.67	± 9.6 %
10713	AAC	IEEE 802.11ax (40MHz, MCS6, 99pc dc)	WLAN	8.33	± 9.6 %
10714	AAC	IEEE 802.11ax (40MHz, MCS7, 99pc dc)	WLAN	8.26	± 9.6 %
10715	AAC	IEEE 802.11ax (40MHz, MCS8, 99pc dc)	WLAN	8.45	± 9.6 %
10716	AAC	IEEE 802.11ax (40MHz, MCS9, 99pc dc)	WLAN	8.30	± 9.6 %
10717	AAC	IEEE 802.11ax (40MHz, MCS10, 99pc dc)	WLAN	8.48	± 9.6 %
10718	AAC	IEEE 802.11ax (40MHz, MCS11, 99pc dc)	WLAN	8.24	± 9.6 %
10719	AAC	IEEE 802.11ax (80MHz, MCS0, 90pc dc)	WLAN	8.81	± 9.6 %
10720	AAC	IEEE 802.11ax (80MHz, MCS1, 90pc dc)	WLAN	8.87	± 9.6 %
10721	AAC	IEEE 802.11ax (80MHz, MCS2, 90pc dc)	WLAN	8.76	± 9.6 %
10722	AAC	IEEE 802.11ax (80MHz, MCS3, 90pc dc)	WLAN	8.55	± 9.6 %
10723	AAC	IEEE 802.11ax (80MHz, MCS4, 90pc dc)	WLAN	8.70	± 9.6 %
10724	AAC	IEEE 802.11ax (80MHz, MCS5, 90pc dc)	WLAN	8.90	± 9.6 %
10725	AAC	IEEE 802.11ax (80MHz, MCS6, 90pc dc)	WLAN	8.74	± 9.6 %
10726	AAC	IEEE 802.11ax (80MHz, MCS7, 90pc dc)	WLAN	8.72	± 9.6 %
10727	AAC	IEEE 802.11ax (80MHz, MCS8, 90pc dc)	WLAN	8.66	± 9.6 %
10728	AAC	IEEE 802.11ax (80MHz, MCS9, 90pc dc)	WLAN	8.65	± 9.6 %

Certificate No: EF3-4060\_May22

Page 18 of 23

EF3DV3 – SN:4060

May 13, 2022

10729	AAC	IEEE 802.11ax (80MHz, MCS10, 90pc dc)	WLAN	8.64	± 9.6 %
10730	AAC	IEEE 802.11ax (80MHz, MCS11, 90pc dc)	WLAN	8.67	± 9.6 %
10731	AAC	IEEE 802.11ax (80MHz, MCS0, 99pc dc)	WLAN	8.42	± 9.6 %
10732	AAC	IEEE 802.11ax (80MHz, MCS1, 99pc dc)	WLAN	8.46	± 9.6 %
10733	AAC	IEEE 802.11ax (80MHz, MCS2, 99pc dc)	WLAN	8.40	± 9.6 %
10734	AAC	IEEE 802.11ax (80MHz, MCS3, 99pc dc)	WLAN	8.25	± 9.6 %
10735	AAC	IEEE 802.11ax (80MHz, MCS4, 99pc dc)	WLAN	8.33	± 9.6 %
10736	AAC	IEEE 802.11ax (80MHz, MCS5, 99pc dc)	WLAN	8.27	± 9.6 %
10737	AAC	IEEE 802.11ax (80MHz, MCS6, 99pc dc)	WLAN	8.36	± 9.6 %
10738	AAC	IEEE 802.11ax (80MHz, MCS7, 99pc dc)	WLAN	8.42	± 9.6 %
10739	AAC	IEEE 802.11ax (80MHz, MCS8, 99pc dc)	WLAN	8.29	± 9.6 %
10740	AAC	IEEE 802.11ax (80MHz, MCS9, 99pc dc)	WLAN	8.48	± 9.6 %
10741	AAC	IEEE 802.11ax (80MHz, MCS10, 99pc dc)	WLAN	8.40	± 9.6 %
10742	AAC	IEEE 802.11ax (80MHz, MCS11, 99pc dc)	WLAN	8.43	± 9.6 %
10743	AAC	IEEE 802.11ax (160MHz, MCS0, 90pc dc)	WLAN	8.94	± 9.6 %
10744	AAC	IEEE 802.11ax (160MHz, MCS1, 90pc dc)	WLAN	9.16	± 9.6 %
10745	AAC	IEEE 802.11ax (160MHz, MCS2, 90pc dc)	WLAN	8.93	± 9.6 %
10746	AAC	IEEE 802.11ax (160MHz, MCS3, 90pc dc)	WLAN	9.11	± 9.6 %
10747	AAC	IEEE 802.11ax (160MHz, MCS4, 90pc dc)	WLAN	9.04	± 9.6 %
10748	AAC	IEEE 802.11ax (160MHz, MCS5, 90pc dc)	WLAN	8.93	± 9.6 %
10749	AAC	IEEE 802.11ax (160MHz, MCS6, 90pc dc)	WLAN	8.90	± 9.6 %
10750	AAC	IEEE 802.11ax (160MHz, MCS7, 90pc dc)	WLAN	8.79	± 9.6 %
10751	AAC	IEEE 802.11ax (160MHz, MCS8, 90pc dc)	WLAN	8.82	± 9.6 %
10752	AAC	IEEE 802.11ax (160MHz, MCS9, 90pc dc)	WLAN	8.81	± 9.6 %
10753	AAC	IEEE 802.11ax (160MHz, MCS10, 90pc dc)	WLAN	9.00	± 9.6 %
10754	AAC	IEEE 802.11ax (160MHz, MCS11, 90pc dc)	WLAN	8.94	± 9.6 %
10755	AAC	IEEE 802.11ax (160MHz, MCS0, 99pc dc)	WLAN	8.64	± 9.6 %
10756	AAC	IEEE 802.11ax (160MHz, MCS1, 99pc dc)	WLAN	8.77	± 9.6 %
10757	AAC	IEEE 802.11ax (160MHz, MCS2, 99pc dc)	WLAN	8.77	± 9.6 %
10758	AAC	IEEE 802.11ax (160MHz, MCS3, 99pc dc)	WLAN	8.69	± 9.6 %
10759	AAC	IEEE 802.11ax (160MHz, MCS4, 99pc dc)	WLAN	8.58	± 9.6 %
10760	AAC	IEEE 802.11ax (160MHz, MCS5, 99pc dc)	WLAN	8.49	± 9.6 %
10761	AAC	IEEE 802.11ax (160MHz, MCS6, 99pc dc)	WLAN	8.58	± 9.6 %
10762	AAC	IEEE 802.11ax (160MHz, MCS7, 99pc dc)	WLAN	8.49	± 9.6 %
10763	AAC	IEEE 802.11ax (160MHz, MCS8, 99pc dc)	WLAN	8.53	± 9.6 %
10764	AAC	IEEE 802.11ax (160MHz, MCS9, 99pc dc)	WLAN	8.54	± 9.6 %
10765	AAC	IEEE 802.11ax (160MHz, MCS10, 99pc dc)	WLAN	8.54	± 9.6 %
10766	AAC	IEEE 802.11ax (160MHz, MCS11, 99pc dc)	WLAN	8.51	± 9.6 %
10767	AAE	5G NR (CP-OFDM, 1 RB, 5 MHz, QPSK, 15 kHz)	5G NR FR1 TDD	7.99	± 9.6 %
10768	AAD	5G NR (CP-OFDM, 1 RB, 10 MHz, QPSK, 15 kHz)	5G NR FR1 TDD	8.01	± 9.6 %
10769	AAD	5G NR (CP-OFDM, 1 RB, 15 MHz, QPSK, 15 kHz)	5G NR FR1 TDD	8.01	± 9.6 %
10770	AAD	5G NR (CP-OFDM, 1 RB, 20 MHz, QPSK, 15 kHz)	5G NR FR1 TDD	8.02	± 9.6 %
10771	AAD	5G NR (CP-OFDM, 1 RB, 25 MHz, QPSK, 15 kHz)	5G NR FR1 TDD	8.02	± 9.6 %
10772	AAD	5G NR (CP-OFDM, 1 RB, 30 MHz, QPSK, 15 kHz)	5G NR FR1 TDD	8.23	± 9.6 %
10773	AAD	5G NR (CP-OFDM, 1 RB, 40 MHz, QPSK, 15 kHz)	5G NR FR1 TDD	8.03	± 9.6 %
10774	AAD	5G NR (CP-OFDM, 1 RB, 50 MHz, QPSK, 15 kHz)	5G NR FR1 TDD	8.02	± 9.6 %
10775	AAD	5G NR (CP-OFDM, 50% RB, 5 MHz, QPSK, 15 kHz)	5G NR FR1 TDD	8.31	± 9.6 %
10776	AAD	5G NR (CP-OFDM, 50% RB, 10 MHz, QPSK, 15 kHz)	5G NR FR1 TDD	8.30	± 9.6 %
10777	AAC	5G NR (CP-OFDM, 50% RB, 15 MHz, QPSK, 15 kHz)	5G NR FR1 TDD	8.30	± 9.6 %
10778	AAD	5G NR (CP-OFDM, 50% RB, 20 MHz, QPSK, 15 kHz)	5G NR FR1 TDD	8.34	± 9.6 %
10779	AAC	5G NR (CP-OFDM, 50% RB, 25 MHz, QPSK, 15 kHz)	5G NR FR1 TDD	8.42	± 9.6 %
10780	AAD	5G NR (CP-OFDM, 50% RB, 30 MHz, QPSK, 15 kHz)	5G NR FR1 TDD	8.38	± 9.6 %
10781	AAD	5G NR (CP-OFDM, 50% RB, 40 MHz, QPSK, 15 kHz)	5G NR FR1 TDD	8.38	± 9.6 %
10782	AAD	5G NR (CP-OFDM, 50% RB, 50 MHz, QPSK, 15 kHz)	5G NR FR1 TDD	8.43	± 9.6 %
10783	AAE	5G NR (CP-OFDM, 100% RB, 5 MHz, QPSK, 15 kHz)	5G NR FR1 TDD	8.31	± 9.6 %
10784	AAD	5G NR (CP-OFDM, 100% RB, 10 MHz, QPSK, 15 kHz)	5G NR FR1 TDD	8.29	± 9.6 %





EF3DV3 – SN:4060

May 13, 2022

10785	AAD	5G NR (CP-OFDM, 100% RB, 15 MHz, QPSK, 15 kHz)	5G NR FR1 TDD	8.40	± 9.6 %
10786	AAD	5G NR (CP-OFDM, 100% RB, 20 MHz, QPSK, 15 kHz)	5G NR FR1 TDD	8.35	± 9.6 %
10787	AAD	5G NR (CP-OFDM, 100% RB, 25 MHz, QPSK, 15 kHz)	5G NR FR1 TDD	8.44	± 9.6 %
10788	AAD	5G NR (CP-OFDM, 100% RB, 30 MHz, QPSK, 15 kHz)	5G NR FR1 TDD	8.39	± 9.6 %
10789	AAD	5G NR (CP-OFDM, 100% RB, 40 MHz, QPSK, 15 kHz)	5G NR FR1 TDD	8.37	± 9.6 %
10790	AAD	5G NR (CP-OFDM, 100% RB, 50 MHz, QPSK, 15 kHz)	5G NR FR1 TDD	8.39	± 9.6 %
10791	AAE	5G NR (CP-OFDM, 1 RB, 5 MHz, QPSK, 30 kHz)	5G NR FR1 TDD	7.83	± 9.6 %
10792	AAD	5G NR (CP-OFDM, 1 RB, 10 MHz, QPSK, 30 kHz)	5G NR FR1 TDD	7.92	± 9.6 %
10793	AAD	5G NR (CP-OFDM, 1 RB, 15 MHz, QPSK, 30 kHz)	5G NR FR1 TDD	7.95	± 9.6 %
10794	AAD	5G NR (CP-OFDM, 1 RB, 20 MHz, QPSK, 30 kHz)	5G NR FR1 TDD	7.82	± 9.6 %
10795	AAD	5G NR (CP-OFDM, 1 RB, 25 MHz, QPSK, 30 kHz)	5G NR FR1 TDD	7.84	± 9.6 %
10796	AAD	5G NR (CP-OFDM, 1 RB, 30 MHz, QPSK, 30 kHz)	5G NR FR1 TDD	7.82	± 9.6 %
10797	AAD	5G NR (CP-OFDM, 1 RB, 40 MHz, QPSK, 30 kHz)	5G NR FR1 TDD	8.01	± 9.6 %
10798	AAD	5G NR (CP-OFDM, 1 RB, 50 MHz, QPSK, 30 kHz)	5G NR FR1 TDD	7.89	± 9.6 %
10799	AAD	5G NR (CP-OFDM, 1 RB, 60 MHz, QPSK, 30 kHz)	5G NR FR1 TDD	7.93	± 9.6 %
10801	AAD	5G NR (CP-OFDM, 1 RB, 80 MHz, QPSK, 30 kHz)	5G NR FR1 TDD	7.89	± 9.6 %
10802	AAD	5G NR (CP-OFDM, 1 RB, 90 MHz, QPSK, 30 kHz)	5G NR FR1 TDD	7.87	± 9.6 %
10803	AAD	5G NR (CP-OFDM, 1 RB, 100 MHz, QPSK, 30 kHz)	5G NR FR1 TDD	7.93	± 9.6 %
10805	AAD	5G NR (CP-OFDM, 50% RB, 10 MHz, QPSK, 30 kHz)	5G NR FR1 TDD	8.34	± 9.6 %
10806	AAD	5G NR (CP-OFDM, 50% RB, 15 MHz, QPSK, 30 kHz)	5G NR FR1 TDD	8.37	± 9.6 %
10809	AAD	5G NR (CP-OFDM, 50% RB, 30 MHz, QPSK, 30 kHz)	5G NR FR1 TDD	8.34	± 9.6 %
10810	AAD	5G NR (CP-OFDM, 50% RB, 40 MHz, QPSK, 30 kHz)	5G NR FR1 TDD	8.34	± 9.6 %
10812	AAD	5G NR (CP-OFDM, 50% RB, 60 MHz, QPSK, 30 kHz)	5G NR FR1 TDD	8.35	± 9.6 %
10817	AAE	5G NR (CP-OFDM, 100% RB, 5 MHz, QPSK, 30 kHz)	5G NR FR1 TDD	8.35	± 9.6 %
10818	AAD	5G NR (CP-OFDM, 100% RB, 10 MHz, QPSK, 30 kHz)	5G NR FR1 TDD	8.34	± 9.6 %
10819	AAD	5G NR (CP-OFDM, 100% RB, 15 MHz, QPSK, 30 kHz)	5G NR FR1 TDD	8.33	± 9.6 %
10820	AAD	5G NR (CP-OFDM, 100% RB, 20 MHz, QPSK, 30 kHz)	5G NR FR1 TDD	8.30	± 9.6 %
10821	AAD	5G NR (CP-OFDM, 100% RB, 25 MHz, QPSK, 30 kHz)	5G NR FR1 TDD	8.41	± 9.6 %
10822	AAD	5G NR (CP-OFDM, 100% RB, 30 MHz, QPSK, 30 kHz)	5G NR FR1 TDD	8.41	± 9.6 %
10823	AAD	5G NR (CP-OFDM, 100% RB, 40 MHz, QPSK, 30 kHz)	5G NR FR1 TDD	8.36	± 9.6 %
10824	AAD	5G NR (CP-OFDM, 100% RB, 50 MHz, QPSK, 30 kHz)	5G NR FR1 TDD	8.39	± 9.6 %
10825	AAD	5G NR (CP-OFDM, 100% RB, 60 MHz, QPSK, 30 kHz)	5G NR FR1 TDD	8.41	± 9.6 %
10827	AAD	5G NR (CP-OFDM, 100% RB, 80 MHz, QPSK, 30 kHz)	5G NR FR1 TDD	8.42	± 9.6 %
10828	AAD	5G NR (CP-OFDM, 100% RB, 90 MHz, QPSK, 30 kHz)	5G NR FR1 TDD	8.43	± 9.6 %
10829	AAD	5G NR (CP-OFDM, 100% RB, 100 MHz, QPSK, 30 kHz)	5G NR FR1 TDD	8.40	± 9.6 %
10830	AAD	5G NR (CP-OFDM, 1 RB, 10 MHz, QPSK, 60 kHz)	5G NR FR1 TDD	7.63	± 9.6 %
10831	AAD	5G NR (CP-OFDM, 1 RB, 15 MHz, QPSK, 60 kHz)	5G NR FR1 TDD	7.73	± 9.6 %
10832	AAD	5G NR (CP-OFDM, 1 RB, 20 MHz, QPSK, 60 kHz)	5G NR FR1 TDD	7.74	± 9.6 %
10833	AAD	5G NR (CP-OFDM, 1 RB, 25 MHz, QPSK, 60 kHz)	5G NR FR1 TDD	7.70	± 9.6 %
10834	AAD	5G NR (CP-OFDM, 1 RB, 30 MHz, QPSK, 60 kHz)	5G NR FR1 TDD	7.75	± 9.6 %
10835	AAD	5G NR (CP-OFDM, 1 RB, 40 MHz, QPSK, 60 kHz)	5G NR FR1 TDD	7.70	± 9.6 %
10836	AAD	5G NR (CP-OFDM, 1 RB, 50 MHz, QPSK, 60 kHz)	5G NR FR1 TDD	7.66	± 9.6 %
10837	AAD	5G NR (CP-OFDM, 1 RB, 60 MHz, QPSK, 60 kHz)	5G NR FR1 TDD	7.68	± 9.6 %
10839	AAD	5G NR (CP-OFDM, 1 RB, 80 MHz, QPSK, 60 kHz)	5G NR FR1 TDD	7.70	± 9.6 %
10840	AAD	5G NR (CP-OFDM, 1 RB, 90 MHz, QPSK, 60 kHz)	5G NR FR1 TDD	7.67	± 9.6 %
10841	AAD	5G NR (CP-OFDM, 1 RB, 100 MHz, QPSK, 60 kHz)	5G NR FR1 TDD	7.71	± 9.6 %
10843	AAD	5G NR (CP-OFDM, 50% RB, 15 MHz, QPSK, 60 kHz)	5G NR FR1 TDD	8.49	± 9.6 %
10844	AAD	5G NR (CP-OFDM, 50% RB, 20 MHz, QPSK, 60 kHz)	5G NR FR1 TDD	8.34	± 9.6 %
10846	AAD	5G NR (CP-OFDM, 50% RB, 30 MHz, QPSK, 60 kHz)	5G NR FR1 TDD	8.41	± 9.6 %
10854	AAD	5G NR (CP-OFDM, 100% RB, 10 MHz, QPSK, 60 kHz)	5G NR FR1 TDD	8.34	± 9.6 %
10855	AAD	5G NR (CP-OFDM, 100% RB, 15 MHz, QPSK, 60 kHz)	5G NR FR1 TDD	8.36	± 9.6 %
10856	AAD	5G NR (CP-OFDM, 100% RB, 20 MHz, QPSK, 60 kHz)	5G NR FR1 TDD	8.37	± 9.6 %
10857	AAD	5G NR (CP-OFDM, 100% RB, 25 MHz, QPSK, 60 kHz)	5G NR FR1 TDD	8.35	± 9.6 %
10858	AAD	5G NR (CP-OFDM, 100% RB, 30 MHz, QPSK, 60 kHz)	5G NR FR1 TDD	8.36	± 9.6 %
10859	AAD	5G NR (CP-OFDM, 100% RB, 40 MHz, QPSK, 60 kHz)	5G NR FR1 TDD	8.34	± 9.6 %
10860	AAD	5G NR (CP-OFDM, 100% RB, 50 MHz, QPSK, 60 kHz)	5G NR FR1 TDD	8.41	± 9.6 %

EF3DV3 – SN.4060

May 13, 2022

10861	AAD	5G NR (CP-OFDM, 100% RB, 60 MHz, QPSK, 60 kHz)	5G NR FR1 TDD	8.40	± 9.6 %
10863	AAD	5G NR (CP-OFDM, 100% RB, 80 MHz, QPSK, 60 kHz)	5G NR FR1 TDD	8.41	± 9.6 %
10864	AAD	5G NR (CP-OFDM, 100% RB, 90 MHz, QPSK, 60 kHz)	5G NR FR1 TDD	8.37	± 9.6 %
10865	AAD	5G NR (CP-OFDM, 100% RB, 100 MHz, QPSK, 60 kHz)	5G NR FR1 TDD	8.41	± 9.6 %
10866	AAD	5G NR (DFT-s-OFDM, 1 RB, 100 MHz, QPSK, 30 kHz)	5G NR FR1 TDD	5.68	± 9.6 %
10868	AAD	5G NR (DFT-s-OFDM, 100% RB, 100 MHz, QPSK, 30 kHz)	5G NR FR1 TDD	5.89	± 9.6 %
10869	AAD	5G NR (DFT-s-OFDM, 1 RB, 100 MHz, QPSK, 120 kHz)	5G NR FR2 TDD	5.75	± 9.6 %
10870	AAD	5G NR (DFT-s-OFDM, 100% RB, 100 MHz, QPSK, 120 kHz)	5G NR FR2 TDD	5.86	± 9.6 %
10871	AAD	5G NR (DFT-s-OFDM, 1 RB, 100 MHz, 16QAM, 120 kHz)	5G NR FR2 TDD	5.75	± 9.6 %
10872	AAD	5G NR (DFT-s-OFDM, 100% RB, 100 MHz, 16QAM, 120 kHz)	5G NR FR2 TDD	6.52	± 9.6 %
10873	AAD	5G NR (DFT-s-OFDM, 1 RB, 100 MHz, 64QAM, 120 kHz)	5G NR FR2 TDD	6.61	± 9.6 %
10874	AAD	5G NR (DFT-s-OFDM, 100% RB, 100 MHz, 64QAM, 120 kHz)	5G NR FR2 TDD	6.65	± 9.6 %
10875	AAD	5G NR (CP-OFDM, 1 RB, 100 MHz, QPSK, 120 kHz)	5G NR FR2 TDD	7.78	± 9.6 %
10876	AAD	5G NR (CP-OFDM, 100% RB, 100 MHz, QPSK, 120 kHz)	5G NR FR2 TDD	8.39	± 9.6 %
10877	AAD	5G NR (CP-OFDM, 1 RB, 100 MHz, 16QAM, 120 kHz)	5G NR FR2 TDD	7.95	± 9.6 %
10878	AAD	5G NR (CP-OFDM, 100% RB, 100 MHz, 16QAM, 120 kHz)	5G NR FR2 TDD	8.41	± 9.6 %
10879	AAD	5G NR (CP-OFDM, 1 RB, 100 MHz, 64QAM, 120 kHz)	5G NR FR2 TDD	8.12	± 9.6 %
10880	AAD	5G NR (CP-OFDM, 100% RB, 100 MHz, 64QAM, 120 kHz)	5G NR FR2 TDD	8.38	± 9.6 %
10881	AAD	5G NR (DFT-s-OFDM, 1 RB, 50 MHz, QPSK, 120 kHz)	5G NR FR2 TDD	5.75	± 9.6 %
10882	AAD	5G NR (DFT-s-OFDM, 100% RB, 50 MHz, QPSK, 120 kHz)	5G NR FR2 TDD	5.96	± 9.6 %
10883	AAD	5G NR (DFT-s-OFDM, 1 RB, 50 MHz, 16QAM, 120 kHz)	5G NR FR2 TDD	6.57	± 9.6 %
10884	AAD	5G NR (DFT-s-OFDM, 100% RB, 50 MHz, 16QAM, 120 kHz)	5G NR FR2 TDD	6.53	± 9.6 %
10885	AAD	5G NR (DFT-s-OFDM, 1 RB, 50 MHz, 64QAM, 120 kHz)	5G NR FR2 TDD	6.61	± 9.6 %
10886	AAD	5G NR (DFT-s-OFDM, 100% RB, 50 MHz, 64QAM, 120 kHz)	5G NR FR2 TDD	6.65	± 9.6 %
10887	AAD	5G NR (CP-OFDM, 1 RB, 50 MHz, QPSK, 120 kHz)	5G NR FR2 TDD	7.78	± 9.6 %
10888	AAD	5G NR (CP-OFDM, 100% RB, 50 MHz, QPSK, 120 kHz)	5G NR FR2 TDD	8.35	± 9.6 %
10889	AAD	5G NR (CP-OFDM, 1 RB, 50 MHz, 16QAM, 120 kHz)	5G NR FR2 TDD	8.02	± 9.6 %
10890	AAD	5G NR (CP-OFDM, 100% RB, 50 MHz, 16QAM, 120 kHz)	5G NR FR2 TDD	8.40	± 9.6 %
10891	AAD	5G NR (CP-OFDM, 1 RB, 50 MHz, 64QAM, 120 kHz)	5G NR FR2 TDD	8.13	± 9.6 %
10892	AAD	5G NR (CP-OFDM, 100% RB, 50 MHz, 64QAM, 120 kHz)	5G NR FR2 TDD	8.41	± 9.6 %
10897	AAC	5G NR (DFT-s-OFDM, 1 RB, 5 MHz, QPSK, 30 kHz)	5G NR FR1 TDD	5.66	± 9.6 %
10898	AAB	5G NR (DFT-s-OFDM, 1 RB, 10 MHz, QPSK, 30 kHz)	5G NR FR1 TDD	5.67	± 9.6 %
10899	AAB	5G NR (DFT-s-OFDM, 1 RB, 15 MHz, QPSK, 30 kHz)	5G NR FR1 TDD	5.67	± 9.6 %
10900	AAB	5G NR (DFT-s-OFDM, 1 RB, 20 MHz, QPSK, 30 kHz)	5G NR FR1 TDD	5.68	± 9.6 %
10901	AAB	5G NR (DFT-s-OFDM, 1 RB, 25 MHz, QPSK, 30 kHz)	5G NR FR1 TDD	5.68	± 9.6 %
10902	AAB	5G NR (DFT-s-OFDM, 1 RB, 30 MHz, QPSK, 30 kHz)	5G NR FR1 TDD	5.68	± 9.6 %
10903	AAB	5G NR (DFT-s-OFDM, 1 RB, 40 MHz, QPSK, 30 kHz)	5G NR FR1 TDD	5.68	± 9.6 %
10904	AAB	5G NR (DFT-s-OFDM, 1 RB, 50 MHz, QPSK, 30 kHz)	5G NR FR1 TDD	5.68	± 9.6 %
10905	AAB	5G NR (DFT-s-OFDM, 1 RB, 60 MHz, QPSK, 30 kHz)	5G NR FR1 TDD	5.68	± 9.6 %
10906	AAB	5G NR (DFT-s-OFDM, 1 RB, 80 MHz, QPSK, 30 kHz)	5G NR FR1 TDD	5.68	± 9.6 %
10907	AAC	5G NR (DFT-s-OFDM, 50% RB, 5 MHz, QPSK, 30 kHz)	5G NR FR1 TDD	5.78	± 9.6 %
10908	AAB	5G NR (DFT-s-OFDM, 50% RB, 10 MHz, QPSK, 30 kHz)	5G NR FR1 TDD	5.93	± 9.6 %
10909	AAB	5G NR (DFT-s-OFDM, 50% RB, 15 MHz, QPSK, 30 kHz)	5G NR FR1 TDD	5.96	± 9.6 %
10910	AAB	5G NR (DFT-s-OFDM, 50% RB, 20 MHz, QPSK, 30 kHz)	5G NR FR1 TDD	5.83	± 9.6 %
10911	AAB	5G NR (DFT-s-OFDM, 50% RB, 25 MHz, QPSK, 30 kHz)	5G NR FR1 TDD	5.93	± 9.6 %
10912	AAB	5G NR (DFT-s-OFDM, 50% RB, 30 MHz, QPSK, 30 kHz)	5G NR FR1 TDD	5.84	± 9.6 %
10913	AAB	5G NR (DFT-s-OFDM, 50% RB, 40 MHz, QPSK, 30 kHz)	5G NR FR1 TDD	5.84	± 9.6 %
10914	AAB	5G NR (DFT-s-OFDM, 50% RB, 50 MHz, QPSK, 30 kHz)	5G NR FR1 TDD	5.85	± 9.6 %
10915	AAB	5G NR (DFT-s-OFDM, 50% RB, 60 MHz, QPSK, 30 kHz)	5G NR FR1 TDD	5.83	± 9.6 %
10916	AAB	5G NR (DFT-s-OFDM, 50% RB, 80 MHz, QPSK, 30 kHz)	5G NR FR1 TDD	5.87	± 9.6 %
10917	AAB	5G NR (DFT-s-OFDM, 50% RB, 100 MHz, QPSK, 30 kHz)	5G NR FR1 TDD	5.94	± 9.6 %
10918	AAC	5G NR (DFT-s-OFDM, 100% RB, 5 MHz, QPSK, 30 kHz)	5G NR FR1 TDD	5.86	± 9.6 %
10919	AAB	5G NR (DFT-s-OFDM, 100% RB, 10 MHz, QPSK, 30 kHz)	5G NR FR1 TDD	5.86	± 9.6 %
10920	AAB	5G NR (DFT-s-OFDM, 100% RB, 15 MHz, QPSK, 30 kHz)	5G NR FR1 TDD	5.87	± 9.6 %
10921	AAB	5G NR (DFT-s-OFDM, 100% RB, 20 MHz, QPSK, 30 kHz)	5G NR FR1 TDD	5.84	± 9.6 %
10922	AAB	5G NR (DFT-s-OFDM, 100% RB, 25 MHz, QPSK, 30 kHz)	5G NR FR1 TDD	5.82	± 9.6 %

EF3DV3 – SN:4060

May 13, 2022

10923	AAB	5G NR (DFT-s-OFDM, 100% RB, 30 MHz, QPSK, 30 kHz)	5G NR FR1 TDD	5.84	± 9.6 %
10924	AAB	5G NR (DFT-s-OFDM, 100% RB, 40 MHz, QPSK, 30 kHz)	5G NR FR1 TDD	5.84	± 9.6 %
10925	AAB	5G NR (DFT-s-OFDM, 100% RB, 50 MHz, QPSK, 30 kHz)	5G NR FR1 TDD	5.95	± 9.6 %
10926	AAB	5G NR (DFT-s-OFDM, 100% RB, 60 MHz, QPSK, 30 kHz)	5G NR FR1 TDD	5.84	± 9.6 %
10927	AAB	5G NR (DFT-s-OFDM, 100% RB, 80 MHz, QPSK, 30 kHz)	5G NR FR1 TDD	5.94	± 9.6 %
10928	AAC	5G NR (DFT-s-OFDM, 1 RB, 5 MHz, QPSK, 15 kHz)	5G NR FR1 FDD	5.52	± 9.6 %
10929	AAC	5G NR (DFT-s-OFDM, 1 RB, 10 MHz, QPSK, 15 kHz)	5G NR FR1 FDD	5.52	± 9.6 %
10930	AAC	5G NR (DFT-s-OFDM, 1 RB, 15 MHz, QPSK, 15 kHz)	5G NR FR1 FDD	5.52	± 9.6 %
10931	AAC	5G NR (DFT-s-OFDM, 1 RB, 20 MHz, QPSK, 15 kHz)	5G NR FR1 FDD	5.51	± 9.6 %
10932	AAC	5G NR (DFT-s-OFDM, 1 RB, 25 MHz, QPSK, 15 kHz)	5G NR FR1 FDD	5.51	± 9.6 %
10933	AAC	5G NR (DFT-s-OFDM, 1 RB, 30 MHz, QPSK, 15 kHz)	5G NR FR1 FDD	5.51	± 9.6 %
10934	AAC	5G NR (DFT-s-OFDM, 1 RB, 40 MHz, QPSK, 15 kHz)	5G NR FR1 FDD	5.51	± 9.6 %
10935	AAD	5G NR (DFT-s-OFDM, 1 RB, 50 MHz, QPSK, 15 kHz)	5G NR FR1 FDD	5.51	± 9.6 %
10936	AAC	5G NR (DFT-s-OFDM, 50% RB, 5 MHz, QPSK, 15 kHz)	5G NR FR1 FDD	5.90	± 9.6 %
10937	AAC	5G NR (DFT-s-OFDM, 50% RB, 10 MHz, QPSK, 15 kHz)	5G NR FR1 FDD	5.77	± 9.6 %
10938	AAC	5G NR (DFT-s-OFDM, 50% RB, 15 MHz, QPSK, 15 kHz)	5G NR FR1 FDD	5.90	± 9.6 %
10939	AAC	5G NR (DFT-s-OFDM, 50% RB, 20 MHz, QPSK, 15 kHz)	5G NR FR1 FDD	5.82	± 9.6 %
10940	AAC	5G NR (DFT-s-OFDM, 50% RB, 25 MHz, QPSK, 15 kHz)	5G NR FR1 FDD	5.89	± 9.6 %
10941	AAC	5G NR (DFT-s-OFDM, 50% RB, 30 MHz, QPSK, 15 kHz)	5G NR FR1 FDD	5.83	± 9.6 %
10942	AAC	5G NR (DFT-s-OFDM, 50% RB, 40 MHz, QPSK, 15 kHz)	5G NR FR1 FDD	5.85	± 9.6 %
10943	AAD	5G NR (DFT-s-OFDM, 50% RB, 50 MHz, QPSK, 15 kHz)	5G NR FR1 FDD	5.95	± 9.6 %
10944	AAC	5G NR (DFT-s-OFDM, 100% RB, 5 MHz, QPSK, 15 kHz)	5G NR FR1 FDD	5.81	± 9.6 %
10945	AAC	5G NR (DFT-s-OFDM, 100% RB, 10 MHz, QPSK, 15 kHz)	5G NR FR1 FDD	5.85	± 9.6 %
10946	AAC	5G NR (DFT-s-OFDM, 100% RB, 15 MHz, QPSK, 15 kHz)	5G NR FR1 FDD	5.83	± 9.6 %
10947	AAC	5G NR (DFT-s-OFDM, 100% RB, 20 MHz, QPSK, 15 kHz)	5G NR FR1 FDD	5.87	± 9.6 %
10948	AAC	5G NR (DFT-s-OFDM, 100% RB, 25 MHz, QPSK, 15 kHz)	5G NR FR1 FDD	5.94	± 9.6 %
10949	AAC	5G NR (DFT-s-OFDM, 100% RB, 30 MHz, QPSK, 15 kHz)	5G NR FR1 FDD	5.87	± 9.6 %
10950	AAC	5G NR (DFT-s-OFDM, 100% RB, 40 MHz, QPSK, 15 kHz)	5G NR FR1 FDD	5.94	± 9.6 %
10951	AAD	5G NR (DFT-s-OFDM, 100% RB, 50 MHz, QPSK, 15 kHz)	5G NR FR1 FDD	5.92	± 9.6 %
10952	AAA	5G NR DL (CP-OFDM, TM 3.1, 5 MHz, 64-QAM, 15 kHz)	5G NR FR1 FDD	8.25	± 9.6 %
10953	AAA	5G NR DL (CP-OFDM, TM 3.1, 10 MHz, 64-QAM, 15 kHz)	5G NR FR1 FDD	8.15	± 9.6 %
10954	AAA	5G NR DL (CP-OFDM, TM 3.1, 15 MHz, 64-QAM, 15 kHz)	5G NR FR1 FDD	8.23	± 9.6 %
10955	AAA	5G NR DL (CP-OFDM, TM 3.1, 20 MHz, 64-QAM, 15 kHz)	5G NR FR1 FDD	8.42	± 9.6 %
10956	AAA	5G NR DL (CP-OFDM, TM 3.1, 5 MHz, 64-QAM, 30 kHz)	5G NR FR1 FDD	8.14	± 9.6 %
10957	AAA	5G NR DL (CP-OFDM, TM 3.1, 10 MHz, 64-QAM, 30 kHz)	5G NR FR1 FDD	8.31	± 9.6 %
10958	AAA	5G NR DL (CP-OFDM, TM 3.1, 15 MHz, 64-QAM, 30 kHz)	5G NR FR1 FDD	8.61	± 9.6 %
10959	AAA	5G NR DL (CP-OFDM, TM 3.1, 20 MHz, 64-QAM, 30 kHz)	5G NR FR1 FDD	8.33	± 9.6 %
10960	AAC	5G NR DL (CP-OFDM, TM 3.1, 5 MHz, 64-QAM, 15 kHz)	5G NR FR1 TDD	9.32	± 9.6 %
10961	AAB	5G NR DL (CP-OFDM, TM 3.1, 10 MHz, 64-QAM, 15 kHz)	5G NR FR1 TDD	9.36	± 9.6 %
10962	AAB	5G NR DL (CP-OFDM, TM 3.1, 15 MHz, 64-QAM, 15 kHz)	5G NR FR1 TDD	9.40	± 9.6 %
10963	AAB	5G NR DL (CP-OFDM, TM 3.1, 20 MHz, 64-QAM, 15 kHz)	5G NR FR1 TDD	9.55	± 9.6 %
10964	AAC	5G NR DL (CP-OFDM, TM 3.1, 5 MHz, 64-QAM, 30 kHz)	5G NR FR1 TDD	9.29	± 9.6 %
10965	AAB	5G NR DL (CP-OFDM, TM 3.1, 10 MHz, 64-QAM, 30 kHz)	5G NR FR1 TDD	9.37	± 9.6 %
10966	AAB	5G NR DL (CP-OFDM, TM 3.1, 15 MHz, 64-QAM, 30 kHz)	5G NR FR1 TDD	9.55	± 9.6 %
10967	AAB	5G NR DL (CP-OFDM, TM 3.1, 20 MHz, 64-QAM, 30 kHz)	5G NR FR1 TDD	9.42	± 9.6 %
10968	AAB	5G NR DL (CP-OFDM, TM 3.1, 100 MHz, 64-QAM, 30 kHz)	5G NR FR1 TDD	9.49	± 9.6 %
10972	AAB	5G NR (CP-OFDM, 1 RB, 20 MHz, QPSK, 15 kHz)	5G NR FR1 TDD	11.59	± 9.6 %
10973	AAB	5G NR (DFT-s-OFDM, 1 RB, 100 MHz, QPSK, 30 kHz)	5G NR FR1 TDD	9.06	± 9.6 %
10974	AAB	5G NR (CP-OFDM, 100% RB, 100 MHz, 256-QAM, 30 kHz)	5G NR FR1 TDD	10.28	± 9.6 %
10978	AAA	ULLA BDR	ULLA	2.23	± 9.6 %
10979	AAA	ULLA HDR4	ULLA	7.02	± 9.6 %
10980	AAA	ULLA HDR8	ULLA	8.82	± 9.6 %
10981	AAA	ULLA HDRp4	ULLA	1.50	± 9.6 %
10982	AAA	ULLA HDRp8	ULLA	1.44	± 9.6 %
10983	AAA	5G NR DL (CP-OFDM, TM 3.1, 40 MHz, 64-QAM, 15 kHz)	5G NR FR1 TDD	9.31	± 9.6 %
10984	AAA	5G NR DL (CP-OFDM, TM 3.1, 50 MHz, 64-QAM, 15 kHz)	5G NR FR1 TDD	9.42	± 9.6 %

EF3DV3 – SN:4060

May 13, 2022

10985	AAA	5G NR DL (CP-OFDM, TM 3.1, 40 MHz, 64-QAM, 30 kHz)	5G NR FR1 TDD	9.54	± 9.6 %
10986	AAA	5G NR DL (CP-OFDM, TM 3.1, 50 MHz, 64-QAM, 30 kHz)	5G NR FR1 TDD	9.50	± 9.6 %
10987	AAA	5G NR DL (CP-OFDM, TM 3.1, 60 MHz, 64-QAM, 30 kHz)	5G NR FR1 TDD	9.53	± 9.6 %
10988	AAA	5G NR DL (CP-OFDM, TM 3.1, 70 MHz, 64-QAM, 30 kHz)	5G NR FR1 TDD	9.38	± 9.6 %
10989	AAA	5G NR DL (CP-OFDM, TM 3.1, 80 MHz, 64-QAM, 30 kHz)	5G NR FR1 TDD	9.33	± 9.6 %
10990	AAA	5G NR DL (CP-OFDM, TM 3.1, 90 MHz, 64-QAM, 30 kHz)	5G NR FR1 TDD	9.52	± 9.6 %

<sup>E</sup> Uncertainty is determined using the max. deviation from linear response applying rectangular distribution and is expressed for the square of the field value.

# ANNEX E DIPOLE CALIBRATION CERTIFICATE

Dipole 835 MHz

**Calibration Laboratory of  
Schmid & Partner  
Engineering AG**  
Zeughausstrasse 43, 8004 Zurich, Switzerland



**S** Schweizerischer Kalibrierdienst  
**C** Service suisse d'étalonnage  
**S** Servizio svizzero di taratura  
**S** Swiss Calibration Service

Accredited by the Swiss Accreditation Service (SAS)  
The Swiss Accreditation Service is one of the signatories to the EA  
Multilateral Agreement for the recognition of calibration certificates

Accreditation No.: SCS 0108

Client **CTTL (Auden)**

Certificate No: **CD835V3-1023\_Aug22**

## CALIBRATION CERTIFICATE

Object **CD835V3 - SN: 1023**

Calibration procedure(s) **QA CAL-20.v7  
Calibration Procedure for Validation Sources in air**

Calibration date: **August 25, 2022**

This calibration certificate documents the traceability to national standards, which realize the physical units of measurements (SI).  
The measurements and the uncertainties with confidence probability are given on the following pages and are part of the certificate.

All calibrations have been conducted in the closed laboratory facility: environment temperature (22 ± 3)°C and humidity < 70%.

Calibration Equipment used (M&TE critical for calibration)

Primary Standards	ID #	Cal Date (Certificate No.)	Scheduled Calibration
Power meter NRP	SN: 104778	04-Apr-22 (No. 217-03525/03524)	Apr-23
Power sensor NRP-Z91	SN: 103244	04-Apr-22 (No. 217-03524)	Apr-23
Power sensor NRP-Z91	SN: 103245	04-Apr-22 (No. 217-03525)	Apr-23
Reference 20 dB Attenuator	SN: BH9394 (20k)	04-Apr-22 (No. 217-03527)	Apr-23
Type-N mismatch combination	SN: 310982 / 06327	04-Apr-22 (No. 217-03528)	Apr-23
Probe EF3DV3	SN: 4013	28-Dec-21 (No. EF3-4013_Dec21)	Dec-22
DAE4	SN: 781	22-Dec-21 (No. DAE4-781_Dec21)	Dec-22

Secondary Standards	ID #	Check Date (in house)	Scheduled Check
Power meter Agilent 4419B	SN: GB42420191	09-Oct-09 (in house check Oct-20)	In house check: Oct-23
Power sensor HP E4412A	SN: US38485102	05-Jan-10 (in house check Oct-20)	In house check: Oct-23
Power sensor HP 8482A	SN: US37295597	09-Oct-09 (in house check Oct-20)	In house check: Oct-23
RF generator R&S SMT-06	SN: 837633/005	10-Jan-19 (in house check Oct-20)	In house check: Oct-23
Network Analyzer Agilent E8358A	SN: US41080477	31-Mar-14 (in house check Oct-20)	In house check: Oct-22

Calibrated by:	Name <b>Leif Klysner</b>	Function <b>Laboratory Technician</b>	Signature 
Approved by:	Name <b>Sven Kühn</b>	Function <b>Technical Manager</b>	Signature 

Issued: August 25, 2022

This calibration certificate shall not be reproduced except in full without written approval of the laboratory.

**Calibration Laboratory of  
Schmid & Partner  
Engineering AG**  
Zeughausstrasse 43, 8004 Zurich, Switzerland



**S** Schweizerischer Kalibrierdienst  
**C** Service suisse d'étalonnage  
**S** Servizio svizzero di taratura  
**S** Swiss Calibration Service

Accredited by the Swiss Accreditation Service (SAS)  
The Swiss Accreditation Service is one of the signatories to the EA  
Multilateral Agreement for the recognition of calibration certificates

Accreditation No.: **SCS 0108**

#### References

- [1] ANSI-C63.19-2019 (ANSI-C63.19-2011)  
American National Standard, Methods of Measurement of Compatibility between Wireless Communications  
Devices and Hearing Aids.

#### Methods Applied and Interpretation of Parameters:

- **Coordinate System:** y-axis is in the direction of the dipole arms. z-axis is from the basis of the antenna (mounted on the table) towards its feed point between the two dipole arms. x-axis is normal to the other axes. In coincidence with the standards [1], the measurement planes (probe sensor center) are selected to be at a distance of 15 mm above the top metal edge of the dipole arms.
- **Measurement Conditions:** Further details are available from the hardcopies at the end of the certificate. All figures stated in the certificate are valid at the frequency indicated. The forward power to the dipole connector is set with a calibrated power meter connected and monitored with an auxiliary power meter connected to a directional coupler. While the dipole under test is connected, the forward power is adjusted to the same level.
- **Antenna Positioning:** The dipole is mounted on a HAC Test Arch phantom using the matching dipole positioner with the arms horizontal and the feeding cable coming from the floor. The measurements are performed in a shielded room with absorbers around the setup to reduce the reflections. It is verified before the mounting of the dipole under the Test Arch phantom, that its arms are perfectly in a line. It is installed on the HAC dipole positioner with its arms parallel below the dielectric reference wire and able to move elastically in vertical direction without changing its relative position to the top center of the Test Arch phantom. The vertical distance to the probe is adjusted after dipole mounting with a DASY5 Surface Check job. Before the measurement, the distance between phantom surface and probe tip is verified. The proper measurement distance is selected by choosing the matching section of the HAC Test Arch phantom with the proper device reference point (upper surface of the dipole) and the matching grid reference point (tip of the probe) considering the probe sensor offset. The vertical distance to the probe is essential for the accuracy.
- **Feed Point Impedance and Return Loss:** These parameters are measured using a Vector Network Analyzer. The impedance is specified at the SMA connector of the dipole. The influence of reflections was eliminated by applying the averaging function while moving the dipole in the air, at least 70cm away from any obstacles.
- **E-field distribution:** E field is measured in the x-y-plane with an isotropic E-field probe with 100 mW forward power to the antenna feed point. In accordance with [1], the scan area is 20mm wide, its length exceeds the dipole arm length (180 or 90mm). The sensor center is 15 mm (in z) above the metal top of the dipole arms. Two 3D maxima are available near the end of the dipole arms. Assuming the dipole arms are perfectly in one line, the average of these two maxima (in subgrid 2 and subgrid 8) is determined to compensate for any non-parallelity to the measurement plane as well as the sensor displacement. The E-field value stated as calibration value represents the maximum of the interpolated 3D-E-field, in the plane above the dipole surface.

The reported uncertainty of measurement is stated as the standard uncertainty of measurement multiplied by the coverage factor  $k=2$ , which for a normal distribution corresponds to a coverage probability of approximately 95%.

### Measurement Conditions

DASY system configuration, as far as not given on page 1.

DASY Version	DASY5	V52.10.4
Phantom	HAC Test Arch	
Distance Dipole Top - Probe Center	15 mm	
Scan resolution	dx, dy = 5 mm	
Frequency	835 MHz $\pm$ 1 MHz	
Input power drift	< 0.05 dB	

### Maximum Field values at 835 MHz

E-field 15 mm above dipole surface	condition	Interpolated maximum
Maximum measured above high end	100 mW input power	112.2 V/m = 41.00 dBV/m
Maximum measured above low end	100 mW input power	108.6 V/m = 40.72 dBV/m
Averaged maximum above arm	100 mW input power	110.4 V/m $\pm$ 12.8 % (k=2)

### Appendix (Additional assessments outside the scope of SCS 0108)

#### Antenna Parameters

Frequency	Return Loss	Impedance
800 MHz	17.4 dB	41.1 $\Omega$ - 8.5 j $\Omega$
835 MHz	25.5 dB	53.8 $\Omega$ + 4.0 j $\Omega$
880 MHz	16.5 dB	63.3 $\Omega$ - 10.7 j $\Omega$
900 MHz	16.3 dB	51.0 $\Omega$ - 15.6 j $\Omega$
945 MHz	26.8 dB	46.5 $\Omega$ + 2.8 j $\Omega$

#### 3.2 Antenna Design and Handling

The calibration dipole has a symmetric geometry with a built-in two stub matching network, which leads to the enhanced bandwidth.

The dipole is built of standard semirigid coaxial cable. The internal matching line is open ended. The antenna is therefore open for DC signals.

Do not apply force to dipole arms, as they are liable to bend. The soldered connections near the feedpoint may be damaged. After excessive mechanical stress or overheating, check the impedance characteristics to ensure that the internal matching network is not affected.

After long term use with 40W radiated power, only a slight warming of the dipole near the feedpoint can be measured.

Impedance Measurement Plot

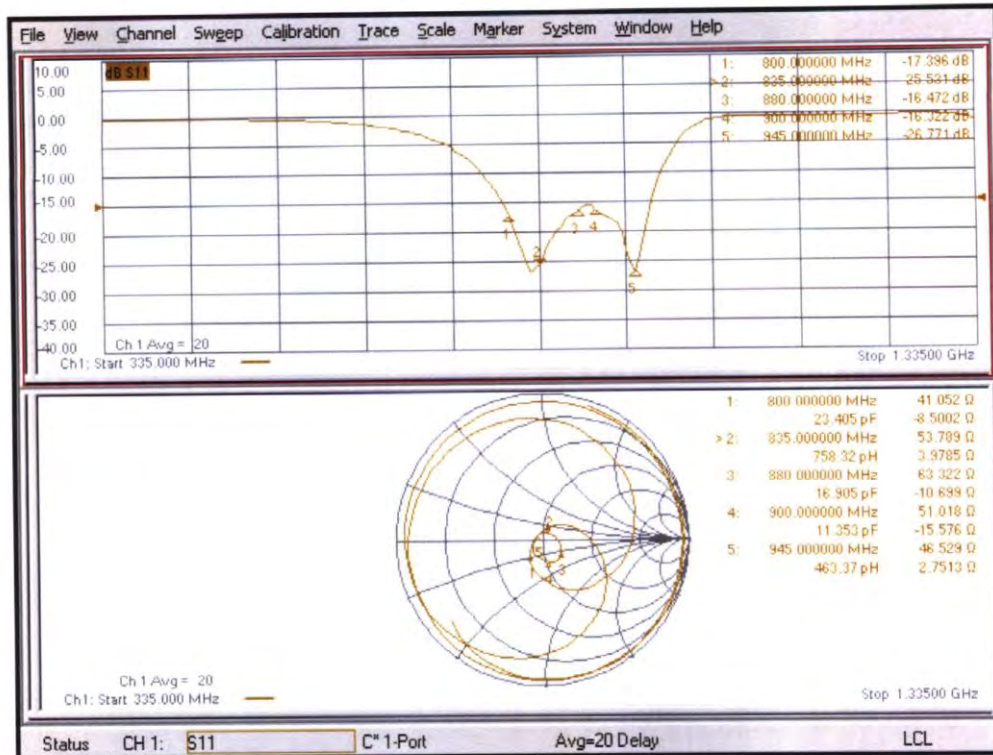



**DASY5 E-field Result**

Date: 25.08.2022

Test Laboratory: SPEAG Lab2

**DUT: HAC-Dipole 835 MHz; Type: CD835V3; Serial: CD835V3 - SN: 1023**

Communication System: UID 0 - CW ; Frequency: 835 MHz  
 Medium parameters used:  $\sigma = 0$  S/m,  $\epsilon_r = 1$ ;  $\rho = 0$  kg/m<sup>3</sup>  
 Phantom section: RF Section  
 Measurement Standard: DASY5 (IEEE/IEC/ANSI C63.19-2011)

DASY52 Configuration:

- Probe: EF3DV3 - SN4013; ConvF(1, 1, 1) @ 835 MHz; Calibrated: 28.12.2021
- Sensor-Surface: (Fix Surface)
- Electronics: DAE4 Sn781; Calibrated: 22.12.2021
- Phantom: HAC Test Arch with AMCC; Type: SD HAC P01 BA; Serial: 1070
- DASY52 52.10.4(1535); SEMCAD X 14.6.14(7501)

**Dipole E-Field measurement @ 835MHz/E-Scan - 835MHz d=15mm/Hearing Aid Compatibility Test (41x361x1):**

Interpolated grid: dx=0.5000 mm, dy=0.5000 mm  
 Device Reference Point: 0, 0, -6.3 mm  
 Reference Value = 132.6 V/m; Power Drift = 0.02 dB  
 Applied MIF = 0.00 dB  
 RF audio interference level = 41.00 dBV/m  
**Emission category: M3**

MIF scaled E-field

Grid 1 M3 40.66 dBV/m	Grid 2 M3 40.72 dBV/m	Grid 3 M3 40.44 dBV/m
Grid 4 M4 35.87 dBV/m	Grid 5 M4 35.88 dBV/m	Grid 6 M4 35.61 dBV/m
Grid 7 M3 40.95 dBV/m	Grid 8 M3 41 dBV/m	Grid 9 M3 40.62 dBV/m

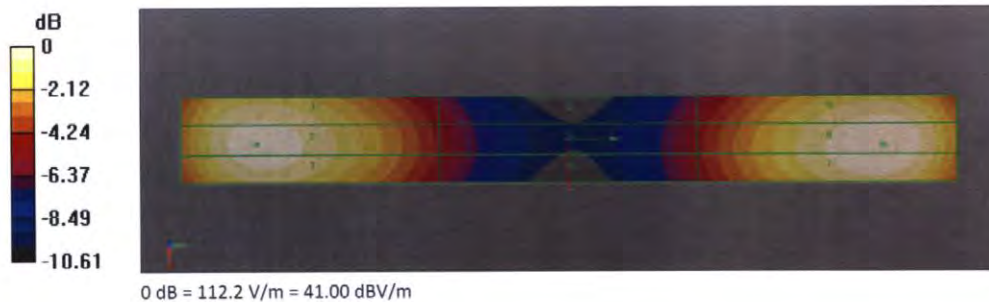



Dipole 1880 MHz

Calibration Laboratory of Schmid & Partner Engineering AG



S Schweizerischer Kalibrierdienst
S Service suisse d'etalonnage
S Servizio svizzero di taratura
S Swiss Calibration Service

Accredited by the Swiss Accreditation Service (SAS)
The Swiss Accreditation Service is one of the signatories to the EA Multilateral Agreement for the recognition of calibration certificates

Accreditation No.: SCS 0108

Client CTTL (Auden)

Certificate No: CD1880V3-1018\_Aug22

CALIBRATION CERTIFICATE

Object CD1880V3 - SN: 1018
Calibration procedure(s) QA CAL-20.v7
Calibration Procedure for Validation Sources in air
Calibration date: August 25, 2022

This calibration certificate documents the traceability to national standards, which realize the physical units of measurements (SI). The measurements and the uncertainties with confidence probability are given on the following pages and are part of the certificate.

All calibrations have been conducted in the closed laboratory facility: environment temperature (22 ± 3)°C and humidity < 70%.

Calibration Equipment used (M&TE critical for calibration)

Table with 4 columns: Primary Standards, ID #, Cal Date (Certificate No.), Scheduled Calibration. Lists equipment like Power meter NRP, Power sensor NRP-Z91, Reference 20 dB Attenuator, etc.

Table with 4 columns: Secondary Standards, ID #, Check Date (in house), Scheduled Check. Lists equipment like Power meter Agilent 4419B, Power sensor HP E4412A, etc.

Calibrated by: Leif Klysner, Laboratory Technician
Approved by: Sven Kühn, Technical Manager

Issued: August 25, 2022

This calibration certificate shall not be reproduced except in full without written approval of the laboratory.

**Calibration Laboratory of  
Schmid & Partner  
Engineering AG**  
Zeughausstrasse 43, 8004 Zurich, Switzerland



**S** Schweizerischer Kalibrierdienst  
**C** Service suisse d'étalonnage  
**S** Servizio svizzero di taratura  
Swiss Calibration Service

Accredited by the Swiss Accreditation Service (SAS)  
The Swiss Accreditation Service is one of the signatories to the EA  
Multilateral Agreement for the recognition of calibration certificates

Accreditation No.: **SCS 0108**

#### References

- [1] ANSI-C63.19-2019 (ANSI-C63.19-2011)  
American National Standard, Methods of Measurement of Compatibility between Wireless Communications  
Devices and Hearing Aids.

#### Methods Applied and Interpretation of Parameters:

- **Coordinate System:** y-axis is in the direction of the dipole arms. z-axis is from the basis of the antenna (mounted on the table) towards its feed point between the two dipole arms. x-axis is normal to the other axes. In coincidence with the standards [1], the measurement planes (probe sensor center) are selected to be at a distance of 15 mm above the top metal edge of the dipole arms.
- **Measurement Conditions:** Further details are available from the hardcopies at the end of the certificate. All figures stated in the certificate are valid at the frequency indicated. The forward power to the dipole connector is set with a calibrated power meter connected with an auxiliary power meter connected to a directional coupler. While the dipole under test is connected, the forward power is adjusted to the same level.
- **Antenna Positioning:** The dipole is mounted on a HAC Test Arch phantom using the matching dipole positioner with the arms horizontal and the feeding cable coming from the floor. The measurements are performed in a shielded room with absorbers around the setup to reduce the reflections. It is verified before the mounting of the dipole under the Test Arch phantom, that its arms are perfectly in a line. It is installed on the HAC dipole positioner with its arms parallel below the dielectric reference wire and able to move elastically in vertical direction without changing its relative position to the top center of the Test Arch phantom. The vertical distance to the probe is adjusted after dipole mounting with a DASY5 Surface Check job. Before the measurement, the distance between phantom surface and probe tip is verified. The proper measurement distance is selected by choosing the matching section of the HAC Test Arch phantom with the proper device reference point (upper surface of the dipole) and the matching grid reference point (tip of the probe) considering the probe sensor offset. The vertical distance to the probe is essential for the accuracy.
- **Feed Point Impedance and Return Loss:** These parameters are measured using a Vector Network Analyzer. The impedance is specified at the SMA connector of the dipole. The influence of reflections was eliminated by applying the averaging function while moving the dipole in the air, at least 70cm away from any obstacles.
- **E-field distribution:** E field is measured in the x-y-plane with an isotropic E-field probe with 100 mW forward power to the antenna feed point. In accordance with [1], the scan area is 20mm wide, its length exceeds the dipole arm length (180 or 90mm). The sensor center is 15 mm (in z) above the metal top of the dipole arms. Two 3D maxima are available near the end of the dipole arms. Assuming the dipole arms are perfectly in one line, the average of these two maxima (in subgrid 2 and subgrid 8) is determined to compensate for any non-parallelity to the measurement plane as well as the sensor displacement. The E-field value stated as calibration value represents the maximum of the interpolated 3D-E-field, in the plane above the dipole surface.

The reported uncertainty of measurement is stated as the standard uncertainty of measurement multiplied by the coverage factor  $k=2$ , which for a normal distribution corresponds to a coverage probability of approximately 95%.

### Measurement Conditions

DASY system configuration, as far as not given on page 1.

DASY Version	DASY5	V52.10.4
Phantom	HAC Test Arch	
Distance Dipole Top - Probe Center	15 mm	
Scan resolution	dx, dy = 5 mm	
Frequency	1880 MHz $\pm$ 1 MHz	
Input power drift	< 0.05 dB	

### Maximum Field values at 1880 MHz

E-field 15 mm above dipole surface	condition	Interpolated maximum
Maximum measured above high end	100 mW input power	86.9 V/m = 38.78 dBV/m
Maximum measured above low end	100 mW input power	86.5 V/m = 38.74 dBV/m
Averaged maximum above arm	100 mW input power	<b>86.7 V/m <math>\pm</math> 12.8 % (k=2)</b>

### Appendix (Additional assessments outside the scope of SCS 0108)

#### Antenna Parameters

Frequency	Return Loss	Impedance
1730 MHz	27.8 dB	54.2 $\Omega$ + 0.7 j $\Omega$
1880 MHz	22.1 dB	54.7 $\Omega$ + 6.7 j $\Omega$
1900 MHz	23.0 dB	55.8 $\Omega$ + 4.8 j $\Omega$
1950 MHz	32.4 dB	52.4 $\Omega$ + 0.1 j $\Omega$
2000 MHz	19.5 dB	47.5 $\Omega$ + 10.0 j $\Omega$

#### 3.2 Antenna Design and Handling

The calibration dipole has a symmetric geometry with a built-in two stub matching network, which leads to the enhanced bandwidth.

The dipole is built of standard semirigid coaxial cable. The internal matching line is open ended. The antenna is therefore open for DC signals.

Do not apply force to dipole arms, as they are liable to bend. The soldered connections near the feedpoint may be damaged. After excessive mechanical stress or overheating, check the impedance characteristics to ensure that the internal matching network is not affected.

After long term use with 40W radiated power, only a slight warming of the dipole near the feedpoint can be measured.

Impedance Measurement Plot

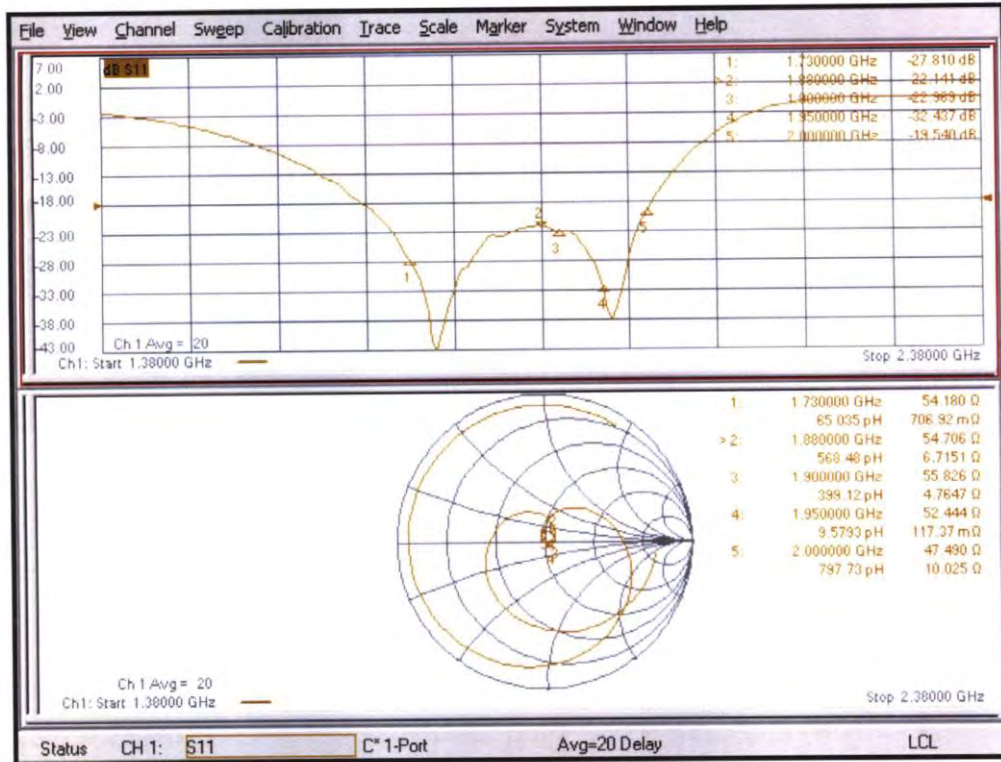

**DASY5 E-field Result**

Date: 25.08.2022

Test Laboratory: SPEAG Lab2

**DUT: HAC Dipole 1880 MHz; Type: CD1880V3; Serial: CD1880V3 - SN: 1018**

Communication System: UID 0 - CW ; Frequency: 1880 MHz  
 Medium parameters used:  $\sigma = 0$  S/m,  $\epsilon_r = 1$ ;  $\rho = 0$  kg/m<sup>3</sup>  
 Phantom section: RF Section  
 Measurement Standard: DASY5 (IEEE/IEC/ANSI C63.19-2011)

DASY52 Configuration:

- Probe: EF3DV3 - SN4013; ConvF(1, 1, 1) @ 1880 MHz; Calibrated: 28.12.2021
- Sensor-Surface: (Fix Surface)
- Electronics: DAE4 Sn781; Calibrated: 22.12.2021
- Phantom: HAC Test Arch with AMCC; Type: SD HAC P01 BA; Serial: 1070
- DASY52 52.10.4(1535); SEMCAD X 14.6.14(7501)

**Dipole E-Field measurement @ 1880MHz/E-Scan - 1880MHz d=15mm/Hearing Aid Compatibility Test (41x181x1):**

Interpolated grid: dx=0.5000 mm, dy=0.5000 mm  
 Device Reference Point: 0, 0, -6.3 mm  
 Reference Value = 157.1 V/m; Power Drift = 0.01 dB  
 Applied MIF = 0.00 dB  
 RF audio interference level = 38.78 dBV/m  
**Emission category: M2**

MIF scaled E-field

Grid 1 M2	Grid 2 M2	Grid 3 M2
38.66 dBV/m	38.74 dBV/m	38.45 dBV/m
Grid 4 M2	Grid 5 M2	Grid 6 M2
36.05 dBV/m	36.06 dBV/m	35.87 dBV/m
Grid 7 M2	Grid 8 M2	Grid 9 M2
38.7 dBV/m	38.78 dBV/m	38.49 dBV/m

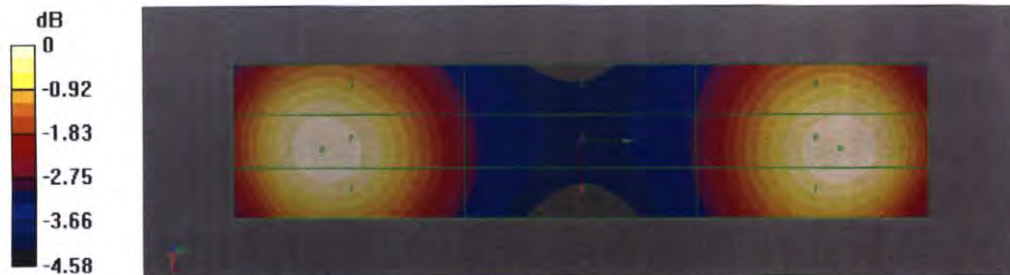

0 dB = 86.94 V/m = 38.78 dBV/m