

DASY5 Validation Report for Head TSL

Date: 27.01.2022

Test Laboratory: SPEAG, Zurich, Switzerland

DUT: Dipole D5GHzV2; Type: D5GHzV2; Serial: D5GHzV2 - SN:1262Communication System: UID 0 - CW; Frequency: 5250 MHz, Frequency: 5600 MHz,
Frequency: 5750 MHzMedium parameters used: $f = 5250$ MHz; $\sigma = 4.52$ S/m; $\epsilon_r = 34.9$; $\rho = 1000$ kg/m³,Medium parameters used: $f = 5600$ MHz; $\sigma = 4.87$ S/m; $\epsilon_r = 34.4$; $\rho = 1000$ kg/m³,Medium parameters used: $f = 5750$ MHz; $\sigma = 5.02$ S/m; $\epsilon_r = 34.2$; $\rho = 1000$ kg/m³

Phantom section: Flat Section

Measurement Standard: DASY5 (IEEE/IEC/ANSI C63.19-2011)

DASY52 Configuration:

- Probe: EX3DV4 - SN3503; ConvF(5.5, 5.5, 5.5) @ 5250 MHz, ConvF(5.1, 5.1, 5.1) @ 5600 MHz, ConvF(5.08, 5.08, 5.08) @ 5750 MHz; Calibrated: 31.12.2021
- Sensor-Surface: 1.4mm (Mechanical Surface Detection)
- Electronics: DAE4 Sn601; Calibrated: 01.11.2021
- Phantom: Flat Phantom 5.0 (front); Type: QD 000 P50 AA; Serial: 1001
- DASY52 52.10.4(1535); SEMCAD X 14.6.14(7501)

Dipole Calibration for Head Tissue/Pin=100mW, dist=10mm, f=5250 MHz/Zoom Scan, dist=1.4mm (8x8x7)/Cube 0: Measurement grid: dx=4mm, dy=4mm, dz=1.4mm

Reference Value = 79.04 V/m; Power Drift = 0.04 dB

Peak SAR (extrapolated) = 28.0 W/kg

SAR(1 g) = 8.15 W/kg; SAR(10 g) = 2.33 W/kg

Smallest distance from peaks to all points 3 dB below = 7.2 mm

Ratio of SAR at M2 to SAR at M1 = 69.9%

Maximum value of SAR (measured) = 18.9 W/kg

Dipole Calibration for Head Tissue/Pin=100mW, dist=10mm, f=5600 MHz/Zoom Scan, dist=1.4mm (8x8x7)/Cube 0: Measurement grid: dx=4mm, dy=4mm, dz=1.4mm

Reference Value = 78.74 V/m; Power Drift = 0.06 dB

Peak SAR (extrapolated) = 31.4 W/kg

SAR(1 g) = 8.51 W/kg; SAR(10 g) = 2.41 W/kg

Smallest distance from peaks to all points 3 dB below = 7.2 mm

Ratio of SAR at M2 to SAR at M1 = 67.6%

Maximum value of SAR (measured) = 20.3 W/kg

Appendix (Additional assessments outside the scope of SCS 0108)**Antenna Parameters with Head TSL at 5200 MHz**

Impedance, transformed to feed point	47.6 Ω - 6.2 j Ω
Return Loss	- 23.3 dB

Antenna Parameters with Head TSL at 5250 MHz

Impedance, transformed to feed point	46.9 Ω - 4.8 j Ω
Return Loss	- 24.5 dB

Antenna Parameters with Head TSL at 5300 MHz

Impedance, transformed to feed point	46.2 Ω - 3.3 j Ω
Return Loss	- 25.6 dB

Antenna Parameters with Head TSL at 5500 MHz

Impedance, transformed to feed point	49.1 Ω - 4.2 j Ω
Return Loss	- 27.3 dB

Antenna Parameters with Head TSL at 5600 MHz

Impedance, transformed to feed point	53.9 Ω + 0.4 j Ω
Return Loss	- 28.4 dB

Dipole Calibration for Head Tissue/Pin=100mW, dist=10mm, f=5750 MHz/Zoom Scan,**dist=1.4mm (8x8x7)/Cube 0:** Measurement grid: dx=4mm, dy=4mm, dz=1.4mm

Reference Value = 75.87 V/m; Power Drift = 0.04 dB

Peak SAR (extrapolated) = 31.9 W/kg

SAR(1 g) = 8.19 W/kg; SAR(10 g) = 2.31 W/kg

Smallest distance from peaks to all points 3 dB below = 7.4 mm

Ratio of SAR at M2 to SAR at M1 = 65.8%

Maximum value of SAR (measured) = 19.9 W/kg

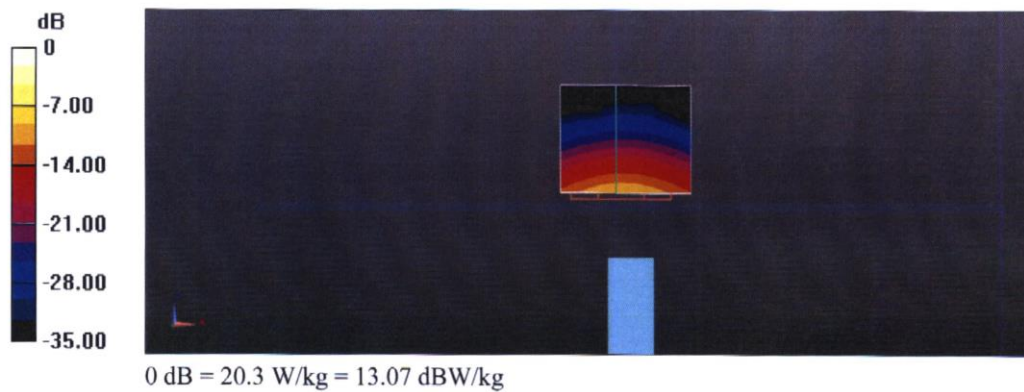

Impedance Measurement Plot for Head TSL

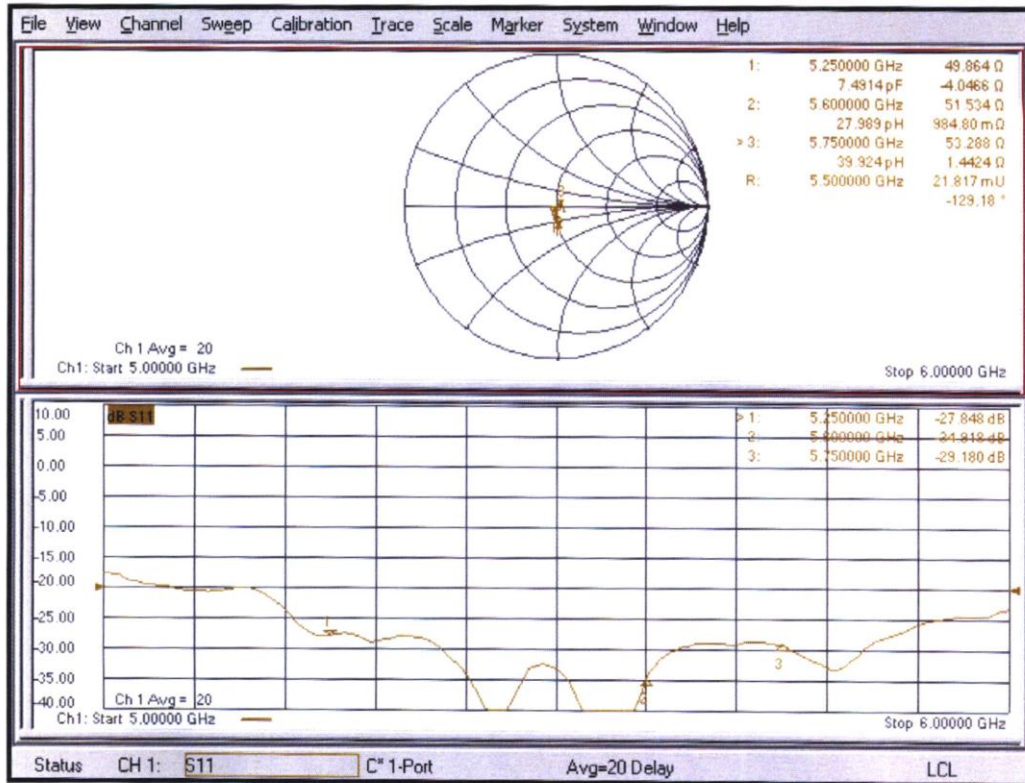

ANNEX I SAR Sensor Triggering Data Summary

istance test	PH0	PH1	PH2	PH4
	Bottom Right ANT0	Bottom Left ANT1	TOP Left ANT3	Top Right ANT5
front	17mm	14mm	15mm	15mm
back	28mm	23mm	22mm	20mm
top	NA	NA	23mm	25mm
bottom	20mm	20mm	NA	NA
left	NA	21mm	15mm	NA
right	11mm	NA	NA	16mm
Threshold	3528	1568	3042	968

Per FCC KDB Publication 616217 D04v01r02, this device was tested by the manufacturer to determine the proximity sensor triggering distances for the rear and bottom edge of the device. The measured output power within ± 5 mm of the triggering points (or until touching the phantom) is included for rear and each applicable edge.

To ensure all production units are compliant it is necessary to test SAR at a distance 1mm less than the smallest distance from the device and SAR phantom (determined from these triggering tests according to the KDB 616217 D04v01r02) with the device at maximum output power without power reduction. These SAR tests are included in addition to the SAR tests for the device touching the SAR phantom, with reduced power.

We tested the power and got the different proximity sensor triggering distances for front/rear /bottom/right edge for ANT0. The manufacturer has declared 17mm/28mm/20mm/11mm is the most conservative triggering distance for ANT0 with front/rear/bottom/right edge. So base on the most conservative triggering distance of 17mm/28mm/20mm/11mm, additional SAR measurements were required at 16mm/27mm/19mm/10mm from the highest SAR position between front/rear/bottom/right edge of ANT0.

We tested the power and got the different proximity sensor triggering distances for front/rear /bottom/left edge for ANT1. The manufacturer has declared 14mm/23mm/20mm/21mm is the most conservative triggering distance for ANT1 with front/rear/bottom/left edge. So base on the most conservative triggering distance of 14mm/23mm/20mm/21mm, additional SAR measurements were required at 13mm/22mm/19mm/20mm from the highest SAR position between front/rear/bottom/left edge of ANT1.

We tested the power and got the different proximity sensor triggering distances for front/rear/top/left edge for ANT3. The manufacturer has declared 15mm/22mm/23mm/15mm is the most conservative triggering distance for ANT3 with front/rear/top/left edge. So base on the most conservative triggering distance of 15mm/22mm/23mm/15mm, additional SAR measurements were required at 14mm/21mm/22mm/14mm from the highest SAR position between front/rear/top/left edge of ANT3.

We tested the power and got the different proximity sensor triggering distances for front/rear/top/right edge for ANT5. The manufacturer has declared 15mm/20mm/25mm/16mm is the most conservative triggering distance for ANT5 with front/rear/top/right edge. So base on the most conservative triggering distance of 15mm/20mm/25mm/16mm, additional SAR measurements were required at 14mm/19mm/24mm/15mm from the highest SAR position between front/rear/top/right edge of ANT5.

ANT0:

Front Edge

Moving device toward the phantom:

sensor near or far(KDB 616217 6.2.6)											
Distance [mm]	22	21	20	19	18	17	16	15	14	13	12
Main antenna	Far	Far	Far	Far	Far	Near	Near	Near	Near	Near	Near

Moving device away from the phantom:

sensor near or far(KDB 616217 6.2.6)											
Distance [mm]	12	13	14	15	16	17	18	19	20	21	22
Main antenna	Near	Near	Near	Near	Near	Near	Far	Far	Far	Far	Far

Rear Edge

Moving device toward the phantom:

sensor near or far(KDB 616217 6.2.6)											
Distance [mm]	33	32	31	30	29	28	27	26	25	24	23
Main antenna	Far	Far	Far	Far	Far	Near	Near	Near	Near	Near	Near

Moving device away from the phantom:

sensor near or far(KDB 616217 6.2.6)											
Distance [mm]	23	24	25	26	27	28	29	30	31	32	33
Main antenna	Near	Near	Near	Near	Near	Near	Far	Far	Far	Far	Far

Bottom Edge

Moving device toward the phantom:

sensor near or far(KDB 616217 6.2.6)											
Distance [mm]	25	24	23	22	21	20	19	18	17	16	15
Main antenna	Far	Far	Far	Far	Far	Near	Near	Near	Near	Near	Near

Moving device away from the phantom:

sensor near or far(KDB 616217 6.2.6)											
Distance [mm]	15	16	17	18	19	20	21	22	23	24	25
Main antenna	Near	Near	Near	Near	Near	Near	Far	Far	Far	Far	Far

Right Edge

Moving device toward the phantom:

sensor near or far(KDB 616217 6.2.6)											
Distance [mm]	15	14	13	12	11	10	9	8	7	6	5
Main antenna	Far	Far	Far	Far	Far	Near	Near	Near	Near	Near	Near

Moving device away from the phantom:

sensor near or far(KDB 616217 6.2.6)											
Distance [mm]	5	6	7	8	9	10	11	12	13	14	15
Main antenna	Near	Near	Near	Near	Near	Near	Far	Far	Far	Far	Far

ANT1:
Front Edge

Moving device toward the phantom:

sensor near or far(KDB 616217 6.2.6)											
Distance [mm]	19	18	17	16	15	14	13	12	11	10	9
Main antenna	Far	Far	Far	Far	Far	Near	Near	Near	Near	Near	Near

Moving device away from the phantom:

sensor near or far(KDB 616217 6.2.6)											
Distance [mm]	9	10	11	12	13	14	15	16	17	18	19
Main antenna	Near	Near	Near	Near	Near	Near	Far	Far	Far	Far	Far

Rear Edge

Moving device toward the phantom:

sensor near or far(KDB 616217 6.2.6)											
Distance [mm]	28	27	26	25	24	23	22	21	20	19	18
Main antenna	Far	Far	Far	Far	Far	Near	Near	Near	Near	Near	Near

Moving device away from the phantom:

sensor near or far(KDB 616217 6.2.6)											
Distance [mm]	18	19	20	21	22	23	24	25	26	27	28
Main antenna	Near	Near	Near	Near	Near	Near	Far	Far	Far	Far	Far

Bottom Edge

Moving device toward the phantom:

sensor near or far(KDB 616217 6.2.6)											
Distance [mm]	25	24	23	22	21	20	19	18	17	16	15
Main antenna	Far	Far	Far	Far	Far	Near	Near	Near	Near	Near	Near

Moving device away from the phantom:

sensor near or far(KDB 616217 6.2.6)											
Distance [mm]	15	16	17	18	19	20	21	22	23	24	25
Main antenna	Near	Near	Near	Near	Near	Near	Far	Far	Far	Far	Far

Left Edge

Moving device toward the phantom:

sensor near or far(KDB 616217 6.2.6)											
Distance [mm]	26	25	24	23	22	21	20	19	18	17	16
Main antenna	Far	Far	Far	Far	Far	Near	Near	Near	Near	Near	Near

Moving device away from the phantom:

sensor near or far(KDB 616217 6.2.6)											
Distance [mm]	16	17	18	19	20	21	22	23	24	25	26
Main antenna	Near	Near	Near	Near	Near	Near	Far	Far	Far	Far	Far

ANT3:

Front Edge

Moving device toward the phantom:

sensor near or far(KDB 616217 6.2.6)											
Distance [mm]	20	19	18	17	16	15	14	13	12	11	10
Main antenna	Far	Far	Far	Far	Far	Near	Near	Near	Near	Near	Near

Moving device away from the phantom:

sensor near or far(KDB 616217 6.2.6)											
Distance [mm]	10	11	12	13	14	15	16	17	18	19	20
Main antenna	Near	Near	Near	Near	Near	Near	Far	Far	Far	Far	Far

Rear Edge

Moving device toward the phantom:

sensor near or far(KDB 616217 6.2.6)											
Distance [mm]	27	26	25	24	23	22	21	20	19	18	17
Main antenna	Far	Far	Far	Far	Far	Near	Near	Near	Near	Near	Near

Moving device away from the phantom:

sensor near or far(KDB 616217 6.2.6)											
Distance [mm]	17	18	19	20	21	22	23	24	25	26	27
Main antenna	Near	Near	Near	Near	Near	Near	Far	Far	Far	Far	Far

Top Edge

Moving device toward the phantom:

sensor near or far(KDB 616217 6.2.6)											
Distance [mm]	28	27	26	25	24	23	22	21	20	19	18
Main antenna	Far	Far	Far	Far	Far	Near	Near	Near	Near	Near	Near

Moving device away from the phantom:

sensor near or far(KDB 616217 6.2.6)											
Distance [mm]	18	19	20	21	22	23	24	25	26	27	28
Main antenna	Near	Near	Near	Near	Near	Near	Far	Far	Far	Far	Far

Left Edge

Moving device toward the phantom:

sensor near or far(KDB 616217 6.2.6)											
Distance [mm]	20	19	18	17	16	15	14	13	12	11	10
Main antenna	Far	Far	Far	Far	Far	Near	Near	Near	Near	Near	Near

Moving device away from the phantom:

sensor near or far(KDB 616217 6.2.6)											
Distance [mm]	10	11	12	13	14	15	16	17	18	19	20
Main antenna	Near	Near	Near	Near	Near	Near	Far	Far	Far	Far	Far

ANT4/ANT5:
Front Edge

Moving device toward the phantom:

sensor near or far(KDB 616217 6.2.6)											
Distance [mm]	20	19	18	17	16	15	14	13	12	11	10
Main antenna	Far	Far	Far	Far	Far	Near	Near	Near	Near	Near	Near

Moving device away from the phantom:

sensor near or far(KDB 616217 6.2.6)											
Distance [mm]	10	11	12	13	14	15	16	17	18	19	20
Main antenna	Near	Near	Near	Near	Near	Near	Far	Far	Far	Far	Far

Rear Edge

Moving device toward the phantom:

sensor near or far(KDB 616217 6.2.6)											
Distance [mm]	25	24	23	22	21	20	19	18	17	16	15
Main antenna	Far	Far	Far	Far	Far	Near	Near	Near	Near	Near	Near

Moving device away from the phantom:

sensor near or far(KDB 616217 6.2.6)											
Distance [mm]	15	16	17	18	19	20	21	22	23	24	25
Main antenna	Near	Near	Near	Near	Near	Near	Far	Far	Far	Far	Far

Top Edge

Moving device toward the phantom:

sensor near or far(KDB 616217 6.2.6)											
Distance [mm]	30	29	28	27	26	25	24	23	22	21	20
Main antenna	Far	Far	Far	Far	Far	Near	Near	Near	Near	Near	Near

Moving device away from the phantom:

sensor near or far(KDB 616217 6.2.6)											
Distance [mm]	20	21	22	23	24	25	26	27	28	29	30
Main antenna	Near	Near	Near	Near	Near	Near	Far	Far	Far	Far	Far

Right Edge

Moving device toward the phantom:

sensor near or far(KDB 616217 6.2.6)											
Distance [mm]	21	20	19	18	17	16	15	14	13	12	11
Main antenna	Far	Far	Far	Far	Far	Near	Near	Near	Near	Near	Near

Moving device away from the phantom:

sensor near or far(KDB 616217 6.2.6)											
Distance [mm]	11	12	13	14	15	16	17	18	19	20	21
Main antenna	Near	Near	Near	Near	Near	Near	Far	Far	Far	Far	Far

Per FCC KDB Publication 616217 D04v01r02, the influence of table tilt angles to proximity sensor triggering is determined by positioning each edge that contains a transmitting antenna, perpendicular to the flat phantom, at the smallest sensor triggering test distance by rotating the device around the edge next to the phantom in $\leq 10^\circ$ increments until the tablet is $\pm 45^\circ$ or more from the vertical position at 0° .

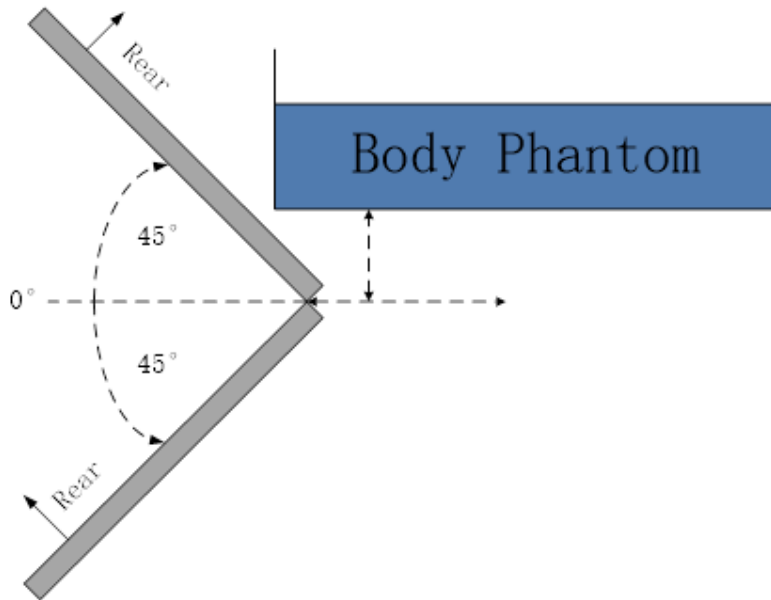

The front/rear edge evaluation

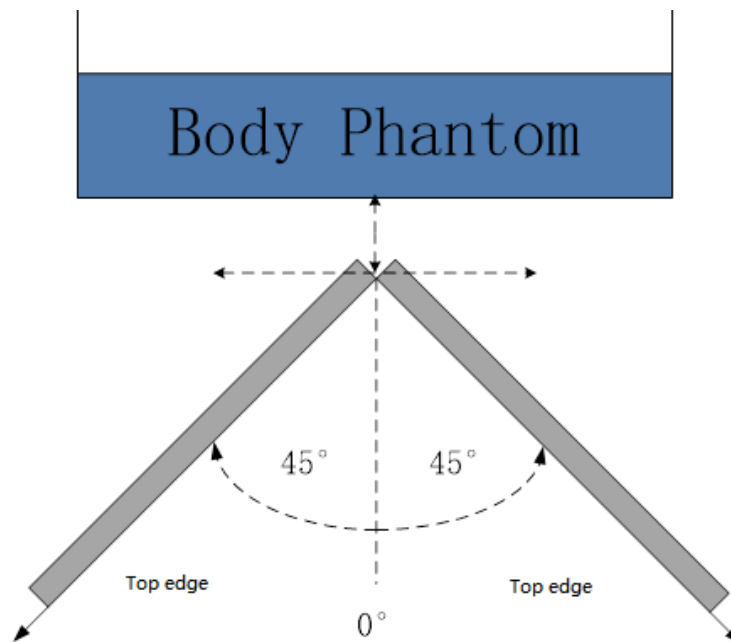

The bottom/top edge evaluation

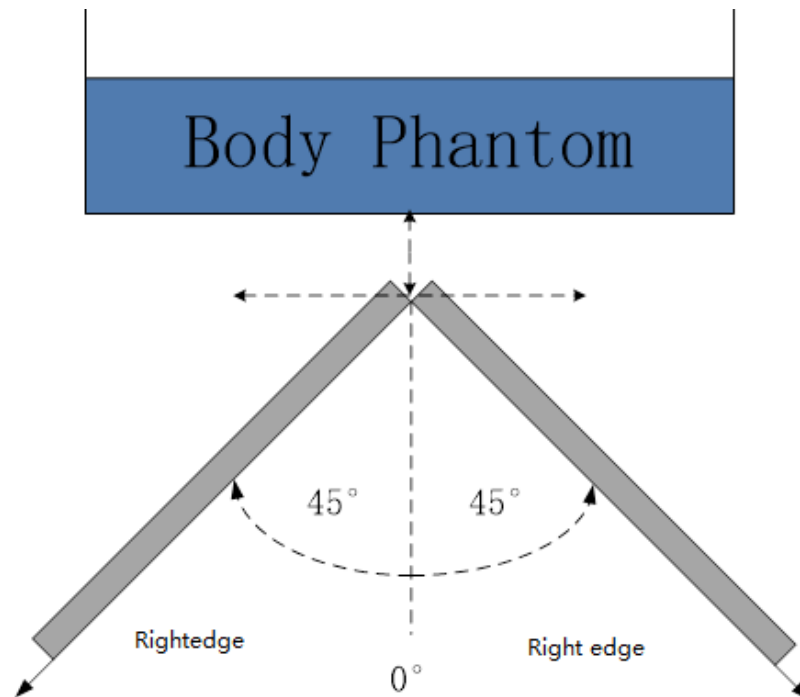

The left/right edge evaluation

Based on the above evaluation, we come to the conclusion that the sensor triggering is not released and normal maximum output power is not restored within the $\pm 45^\circ$ range at the smallest sensor triggering test distance declared by manufacturer.

ANNEX J P-Sensor Triggering Data Summary

P-Sensor Trigger region

Receiver & P-sensor for Head SAR

1. The receiver works and the P-Sensor detects the object approaching (50mm)
2. The AP monitors the status changes of the handset and P-Sensor, and then performs interrupt processing with the defined keyValue
3. The upper layer according to the KeyValue, to execute (send AT instruction) to reduce/restore the antenna power.

Trigger area in yellow box

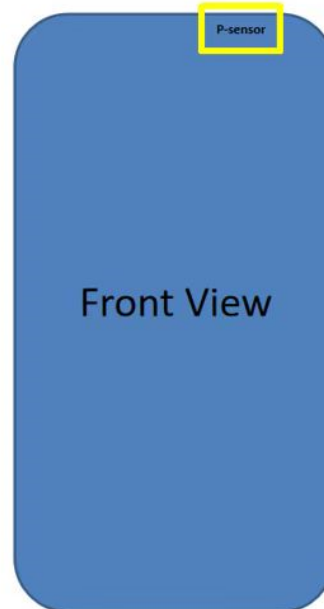

P-Sensor Trigger region

P-sensor is located on the front of the main board as shown in the figure. When the head is close during a voice call, the P-sensor is triggered.

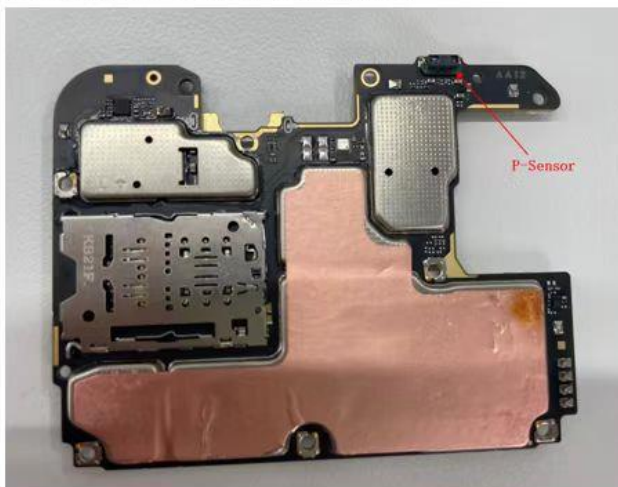

trigger distance 5cm

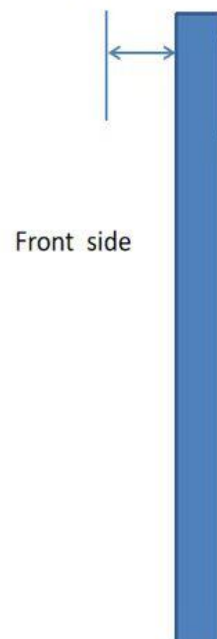

P-Sensor Working principle description

1. P-Sensor is to sense the effect of changing light, and give a judgment signal through the position of the mobile phone receiver near the head 50mm to reduce the antenna transmission power or restore the power.
2. Therefore, the function of P-Sensor SAR is only the position of the receiver on the front of the mobile phone, and it does not judge the close range of each antenna.

STK33562/STK33502

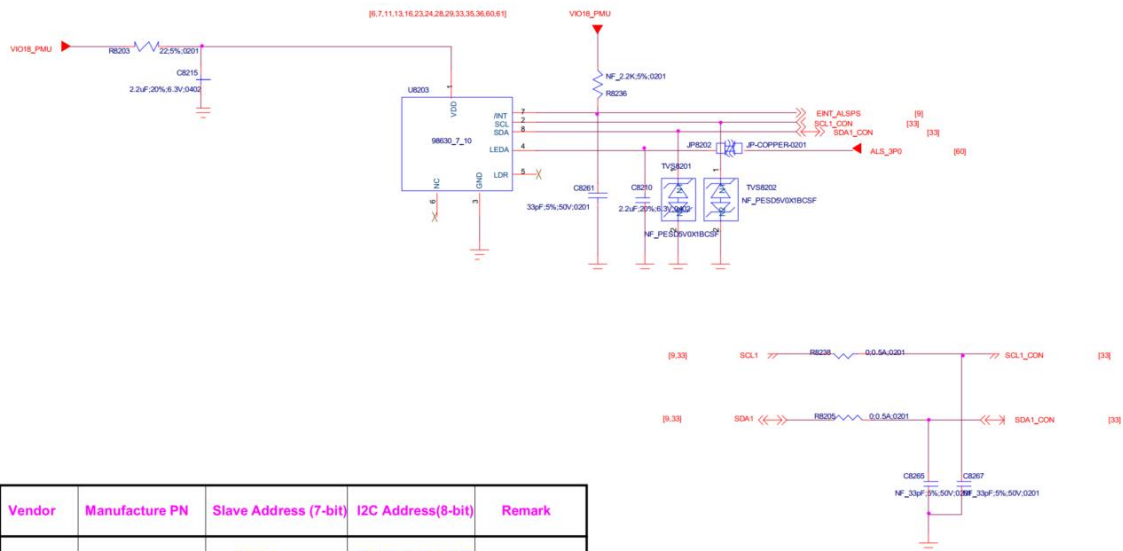

Per FCC KDB Publication 616217 D04v01r02, this device was tested by the manufacturer to determine the proximity sensor triggering distances for the rear and bottom edge of the device. The measured output power within ± 5 mm of the triggering points (or until touching the phantom) is included for rear and each applicable edge.

To ensure all production units are compliant it is necessary to test SAR at a distance 1mm less than the smallest distance from the device and SAR phantom (determined from these triggering tests according to the KDB 616217 D04v01r02) with the device at maximum output power without power reduction. These SAR tests are included in addition to the SAR tests for the device touching the SAR phantom, with reduced power.

Front Edge

Moving device toward the phantom:

sensor near or far(KDB 616217 6.2.6)											
Distance [mm]	55	54	53	52	51	50	49	48	47	48	47
Main antenna	Far	Far	Far	Far	Far	Near	Near	Near	Near	Near	Near

Moving device away from the phantom:

sensor near or far(KDB 616217 6.2.6)											
Distance [mm]	45	46	47	48	49	50	51	52	53	54	55
Main antenna	Near	Near	Near	Near	Near	Near	Far	Far	Far	Far	Far

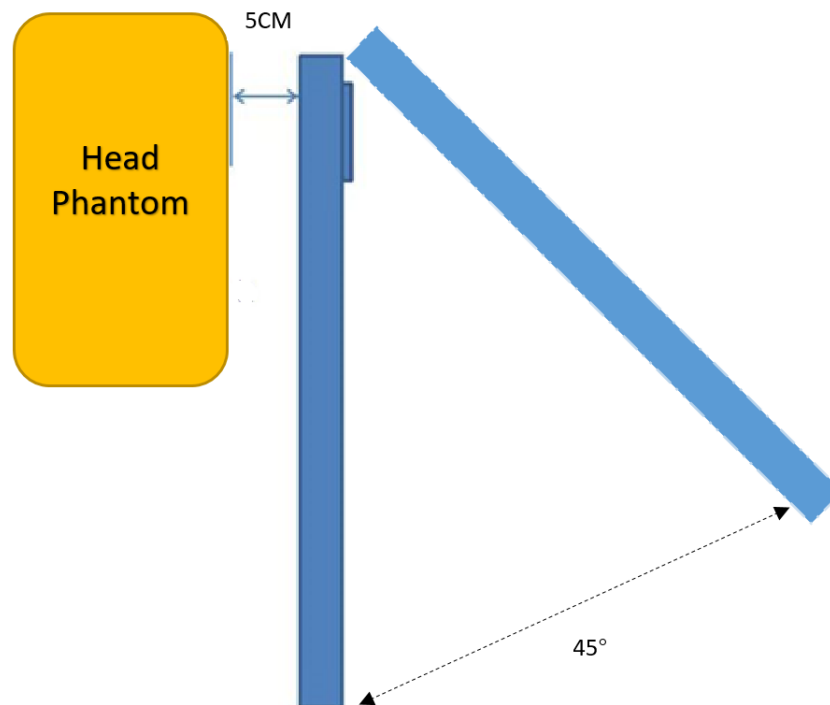

The front edge evaluation

ANNEX K Accreditation Certificate

United States Department of Commerce
National Institute of Standards and Technology

Certificate of Accreditation to ISO/IEC 17025:2017

NVLAP LAB CODE: 600118-0

Telecommunication Technology Labs, CAICT
Beijing
China

*is accredited by the National Voluntary Laboratory Accreditation Program for specific services,
listed on the Scope of Accreditation, for:*

Electromagnetic Compatibility & Telecommunications

*This laboratory is accredited in accordance with the recognized International Standard ISO/IEC 17025:2017.
This accreditation demonstrates technical competence for a defined scope and the operation of a laboratory quality
management system (refer to joint ISO-ILAC-IAF Communiqué dated January 2009).*

2021-09-29 through 2022-09-30
Effective Dates



For the National Voluntary Laboratory Accreditation Program