

Product : Internal Antenna

Model Name : ATTCKTHS02

Date : 2023.10.29

1.Manufacturer

-Huizhou speed wireless technology co.,ltd.

2.Model Name

-ATTCKTHS02

3.Antenna Type

FPC Antenna,IFA

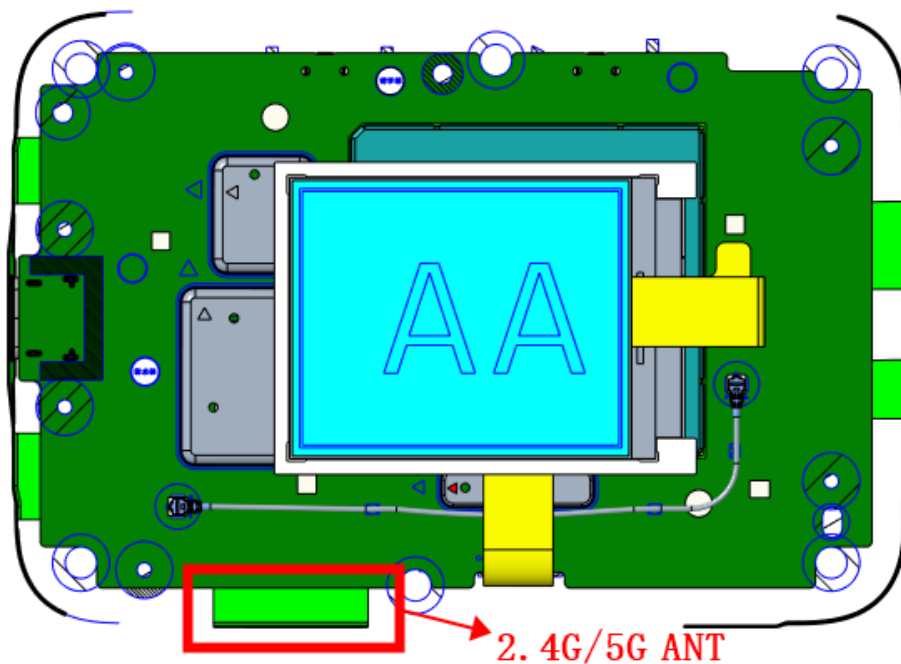

4.Electric Performance Date

4.1Specification Sheet

Electronic Specification		
Frequency Range [MHz]	WIFI 2.4G	WIFI 5G
	2400-2500	5150-5850
Peak gain (dBi)	0.6	2.3
Average gain(dBi)	0.2	1.9

4.2 Antenna Pattern Drawing

2400MHZ:

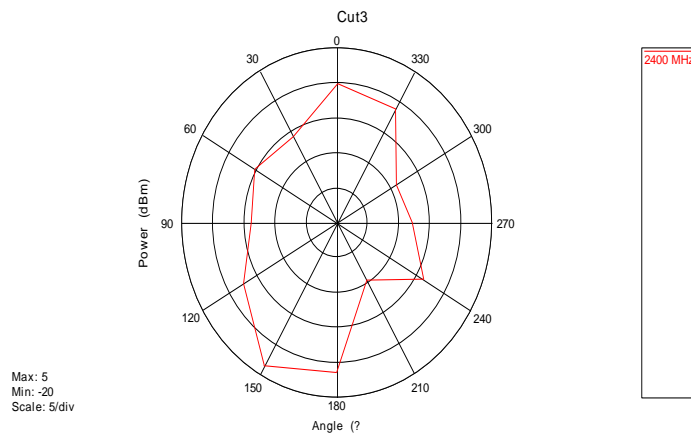
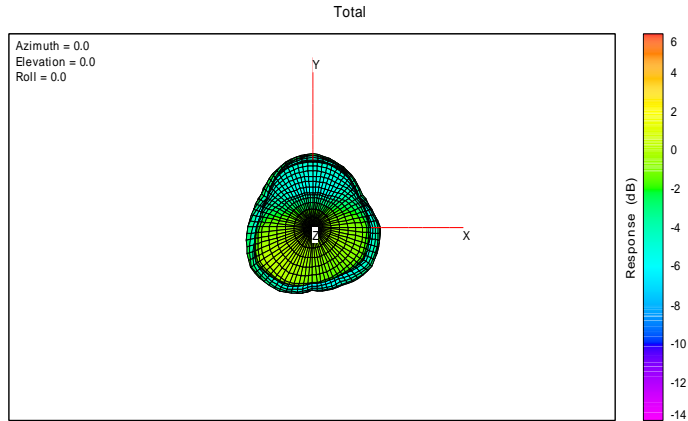

2450MHZ:

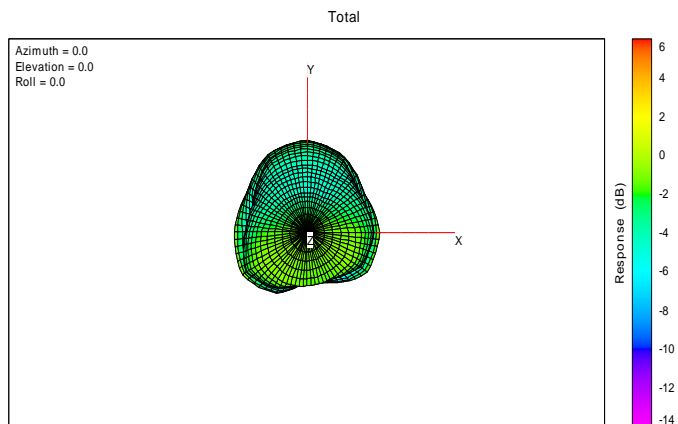

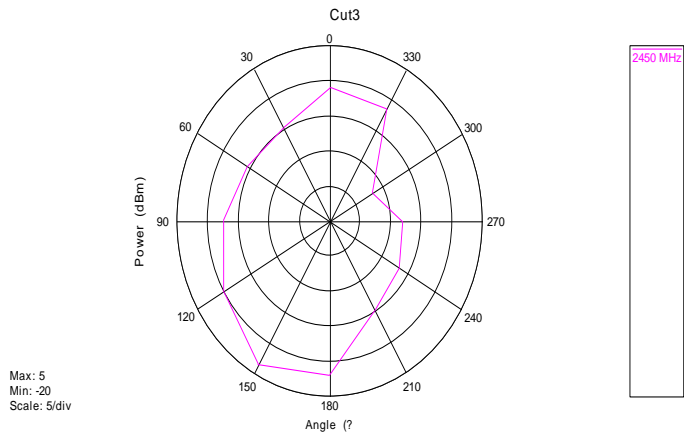

2500MHZ:

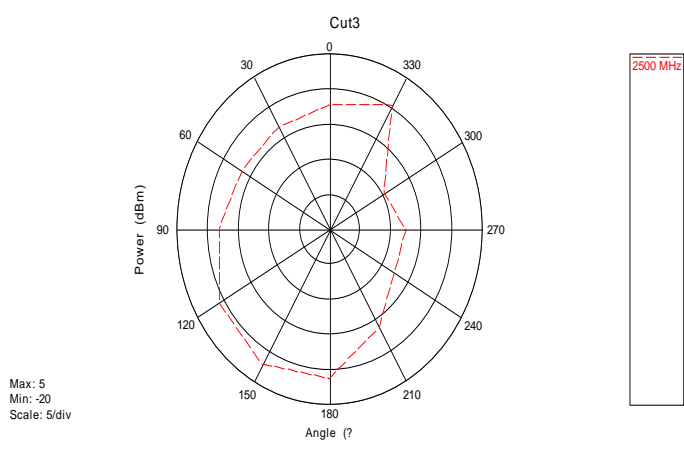
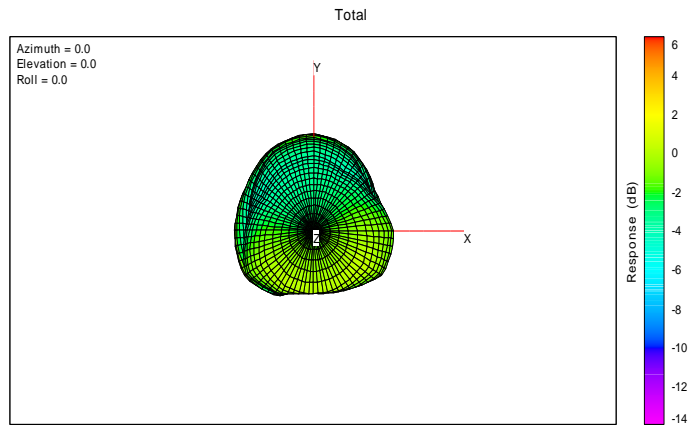

5150MHZ:

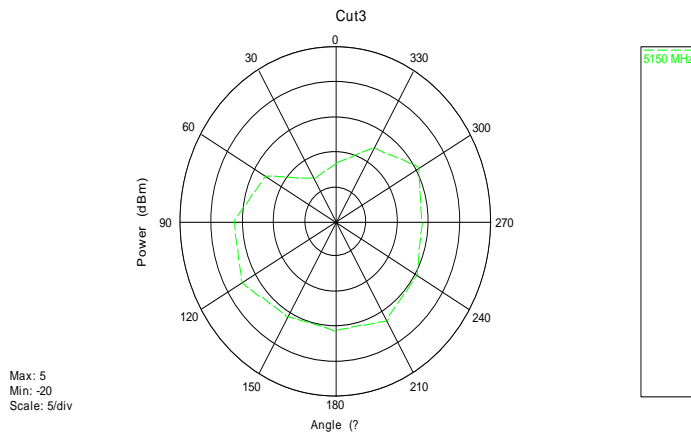
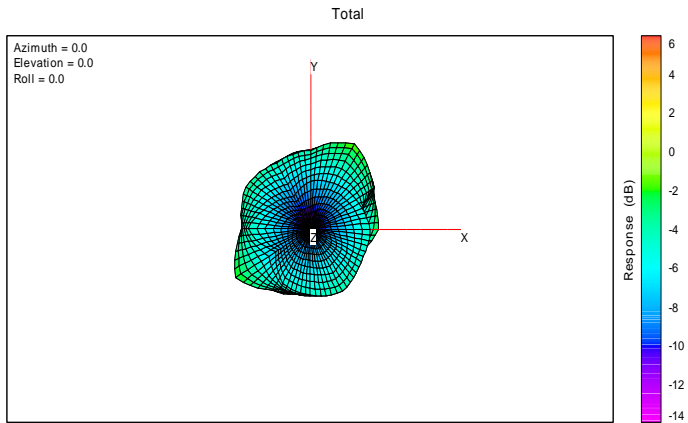

5550MHZ:

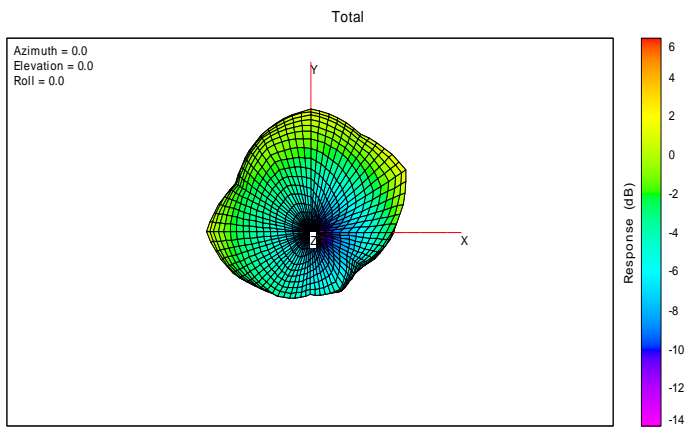

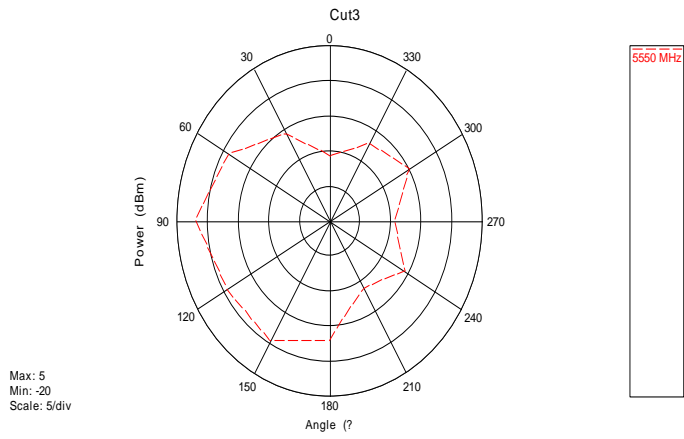

5850MHZ:

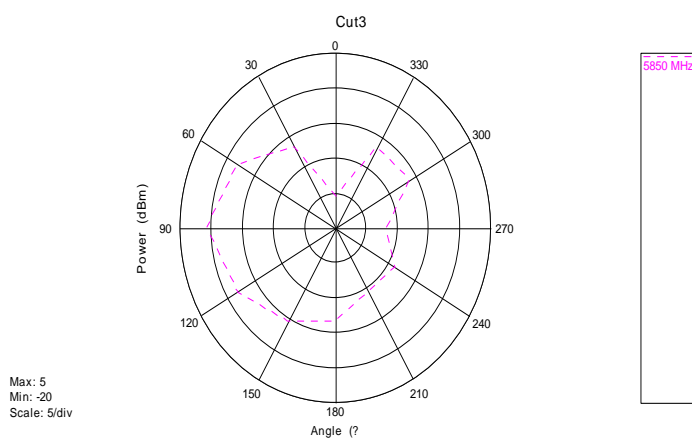
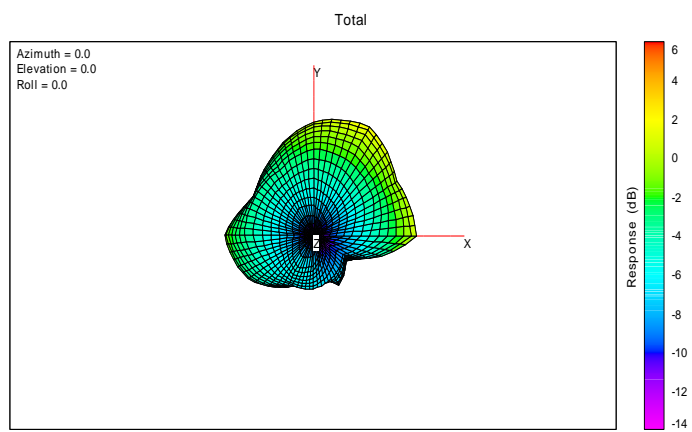

5. Matching circuit

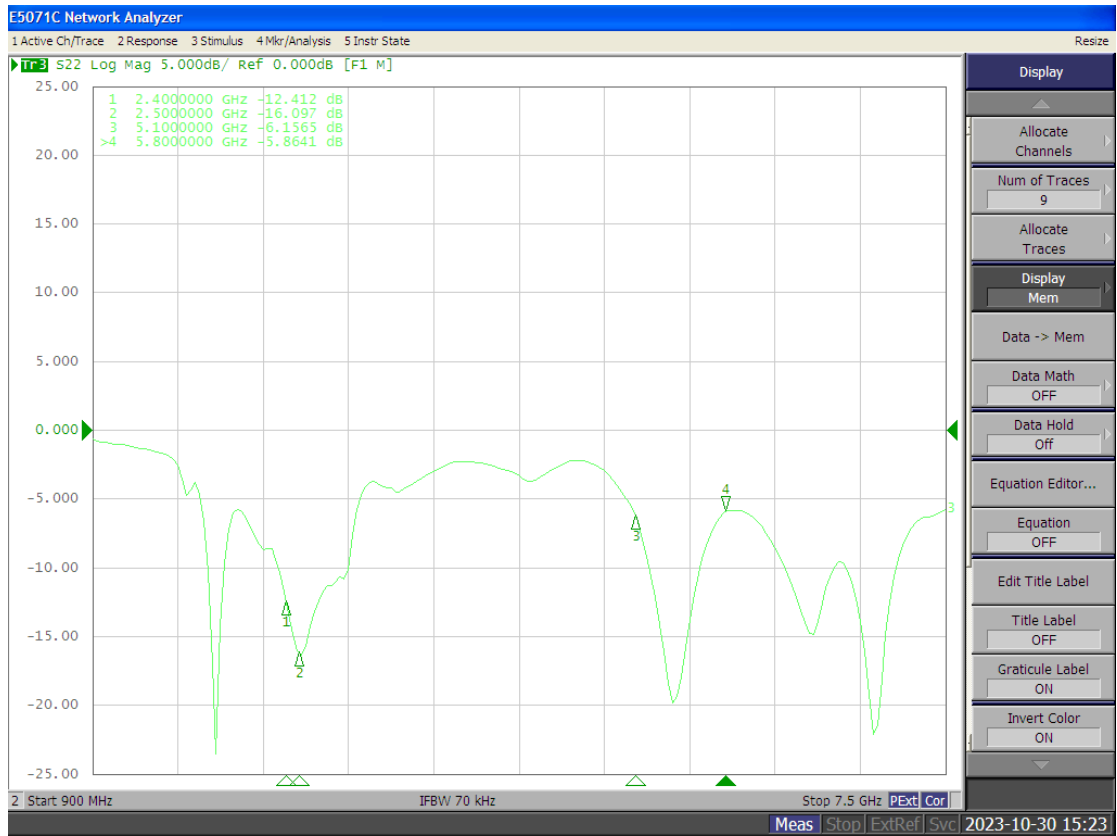

6. ElectricalGraph(Retuenloss)

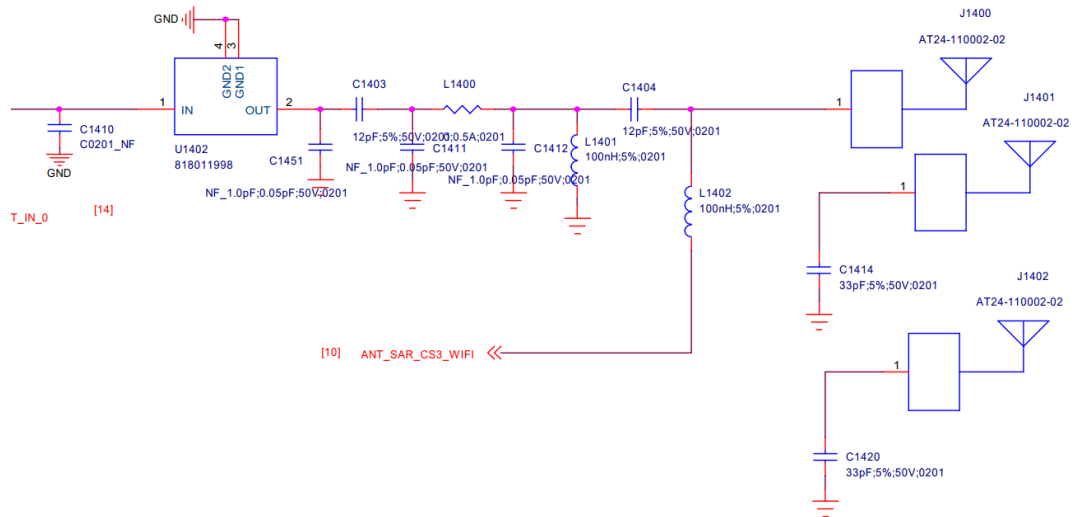

7. External Drawing

Length:17.1mm

Width:14.3mm

