

Smart Body Composition Scale

Model: ES-WBE28

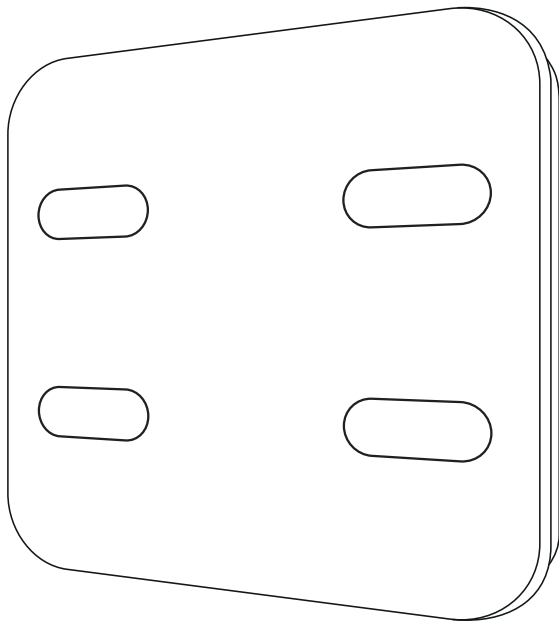

Thank You.

Thank you for purchasing the ES-WBE28 Smart Body Composition Scale by Yolanda. We are dedicated to providing our customers with quality products for building a better living. Feel free to reach out to our helpful customer support team by

400-981-913

Safety Information

IMPORTANT: Please read and comply with all of the instructions and warnings provided in this manual before using the product. Failure to comply with the instructions and warnings provided herein may result in inaccurate results and/or damage to the product itself.

General Safety

- Do not use if you have a pacemaker, artificial lung, an ECG, or any other internal medical devices. Please note that all data should be used as a reference and is not a substitute for medical advice from a licensed healthcare professional.
- This scale should not be used to diagnose or treat any medical condition. Consult your primary care physician before making changes to your diet, exercise plans, or physical activities.
- Check the scale before each use. Do not use the scale if it is damaged.
- The glass platform is slippery when wet. Make sure the platform and feet are dry before stepping on for measurement.

Use & Care

- This scale is not intended for commercial use.
- Always place the scale on a hard, flat surface before measurement.
- To weigh safely and accurately, stand with your feet shoulder-width apart while on the scale.
- **DO NOT** strike or drop the scale.
- **DO NOT** stand on the edge of the scale or jump on it.
- **DO NOT** stand on the scale for a prolonged period of time.
- **DO NOT** store or operate near heat sources or in humid environments.
- Handle the scale with care, as it is a precision instrument.
- Clean the scale with a damp and dry cloth and avoid getting water or any other liquid inside the scale.
- **DO NOT** use chemical or abrasive cleaning agents to clean the scale.
- Keep the scale in a cool environment with dry air.
- Always keep the scale in a horizontal position, do not store vertically.
- If the scale fails to turn on, check whether the batteries are installed correctly. Replace the batteries if necessary.
- If an error appears on the display or if the scale does not turn off automatically, remove the batteries for 3 seconds, then reinstall them.
- **DO NOT** overload the scale (maximum weight capacity: 400 lb / 180 kg).
- **DO NOT** mix new and used batteries or different battery brands to power the scale.
- If the scale is not in use for an extended period of time, remove the batteries to ensure battery conservation and to extend the scale service lifetime.

Scale Overview

1. Weighing Platform
2. Display

3. Anti-skid Padding
4. Battery Compartment

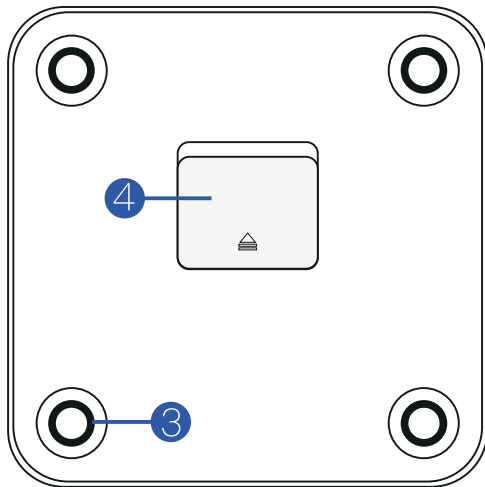
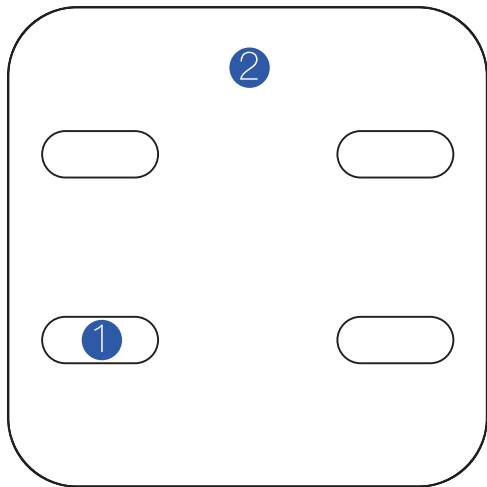

Setup Scale

Insert Batteries

Open the battery compartment and install the batteries under the correct polarity and replace the battery compartment cover.

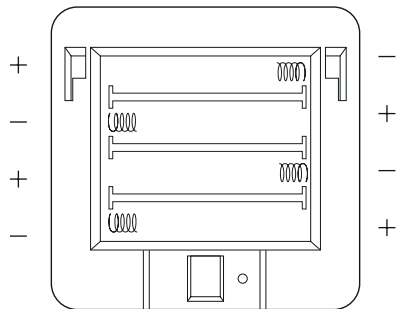
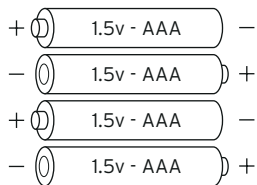
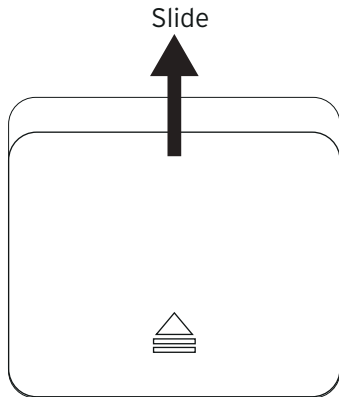

Weighing without the App

After inserting the batteries, your scale is ready to use. However, without the Runcobo app you will only see your weight display on the scale. You will need the app to see other measurements.

1. Place the scale on a hard, flat surface.
2. Step onto the scale to turn on the scale, then step off to let the scale calibrate. Wait until you see the scale displays "CAL" and followed by "00", then step on the scale again to measure your weight.
3. Keep standing on the scale until the digits on the screen flash three (3) times with your final measurement.

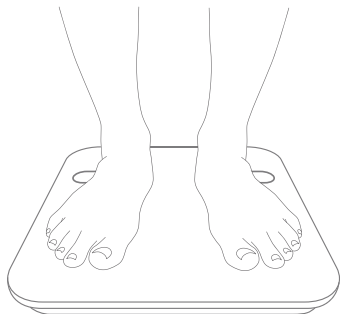
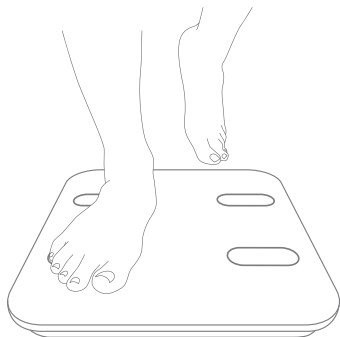
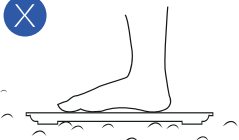
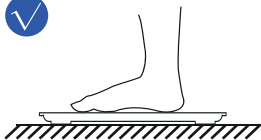

NOTE: The default weight unit for ES-WBE28 is pounds (lbs). To change the weight unit, you must download the Runcobo app and select the desired weight unit in your app's Settings menu (see page 34).

Setup Mobile App

After setting up your scale, you need to setup your mobile app. Without the app you can only see your current weight display on the scale. You don't see your body compositions measurements. You cannot track your history either.

With the mobile app, you will have full access to all the measurements from the ES-WBE28 scale. All the measurements will display on your mobile app. The mobile app provides easy tracking of your weight history and many more features.

The ES-WBE28 scale supports both Bluetooth and Wi-Fi wireless connections. You can use the scale with Bluetooth only, without setting up Wi-Fi connections. With or without the Wi-Fi connections you will have all of your measurements and all of your history. It is highly recommended that you setup Wi-Fi connections if a secure network is available. Scale with Wi-Fi connections offers additional features and conveniences.

1.Scan QR Code or search APP "Megafit" in Apple Store or Google Play to download mobile App



iOS



Android

2.Register



3.Install battery cells



4.Entermy device/add new device/pair device

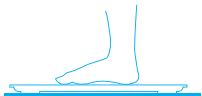

5.Step on scale



6.Pairing scale to APP



7.Step on again and keep to digital number stable



8.Number flash twicemeansweight test finishes.
Number 0 rolling to stable means body fat test finishes.



9.Check the body report in APP

Setup App with Wi-Fi Connections

The ES-WBE28 scale supports both Bluetooth and Wi-Fi wireless connections. You don't have to use the Wi-Fi connections because the Bluetooth alone will have all of your measurements and all of your history. However, it is highly recommended that you setup Wi-Fi connections if a secure network is available. With Wi-Fi connections, your scale offers additional features and conveniences.

- Wi-Fi connections' range is longer than Bluetooth connections.
- With Wi-Fi connections you will be able to receive scale measurement data without running the app. You can use the scale hands-free.
- Wi-Fi wireless connections are more robust. Typically, you don't need reconnections once the Wi-Fi is configured.

During the settings, you will need to have Bluetooth connections first. Then we will configure your scale's Wi-Fi connections. By the end of this section you will have your measurement done using Wi-Fi connections.

NOTE: With the Wi-Fi connections, your measurement data will be uploaded from scale to your home's wireless router through Wi-Fi connections. Then your data will be sent to the Runcobo's secure data server over the internet (the cloud). Your mobile app running on your smartphone will download your measurement data from the data server. It differs from the Bluetooth connections, where your scale sends data directly to your phone.

Measurements

In this section, measurements refer to full measurements with a user's app already setup.

Measurements with Bluetooth Connections

When measuring with your Runcobo app open, the Bluetooth connection will be used. Your measurement data will be sent to your app through the Bluetooth.

1. Make sure your phone's Bluetooth is on. Login to your app.
2. Step onto the scale to turn on the scale, then step off to let the scale calibrate. Wait until you see the scale displays "CAL" and followed by "00", then step on the scale again to measure.
3. On your scale, the Bluetooth icon will appear. On your app's "Measurements" screen the circles will spin until stabilized to display the measurements.

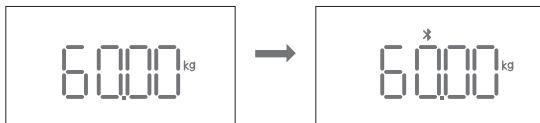

Measurements with Wi-Fi Connections

You don't need to open your Runcobo app before you use the Wi-Fi connections. You may disable your phone's Bluetooth. Your measurement data will be uploaded to the cloud server first then to your app.

1. Don't open your app.
2. Step onto the scale to turn on the scale, then step off to let the scale calibrate. Wait until you see the scale displays 'CAL' and followed by '00', then step on the scale again to measure.
3. On your scale, the Wi-Fi icon will appear. When completed, the scale will display "OPEN APP". It means your measurement data is already sent to the cloud server. You now can open your app to read your measurements. You can open the app now, or you can choose later time to read your data.



Switches between Bluetooth and Wi-Fi Connections

Switches between Bluetooth connections and Wi-Fi connections are automatic, no user interventions are required.

Of course, if you haven't setup your Wi-Fi connections yet, you will always use the Bluetooth connections. There are no switches.

If you already setup your Wi-Fi connections, your Bluetooth connections are also setup. If you open your app before you make a scale measurement, the Bluetooth connections will be used. Otherwise, if you didn't open your Runcobo app (or your phone's Bluetooth is disabled, or your phone is too far away from your scale), then you will use the Wi-Fi connections. Switches between the two are automatic. Users don't need to worry about which connections are used. Either connection method, you will be able to see your data from your app.

Maintenance

Recalibrating the Scale

If the scale has been moved or flipped upside down, it must be recalibrated to ensure accurate results.

1. Place the scale on a hard, flat surface.
2. Step on the scale with one foot until the display until the digits appear on the display, then, step off.
3. The scale will show "CAL" then "0.00", indicating that the calibration process is complete.

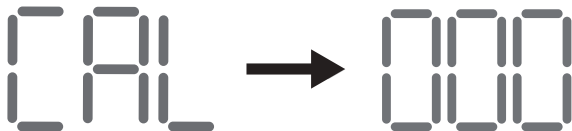
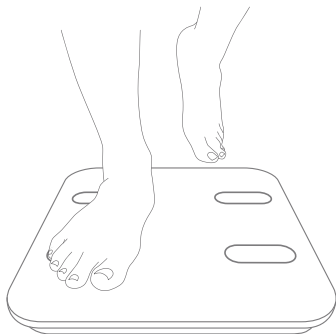

Battery Replacement

The display will show "Lo" when the batteries need to be replaced.

1. Open the battery compartment on the back of the scale.
2. Remove the old batteries and dispose of them properly.







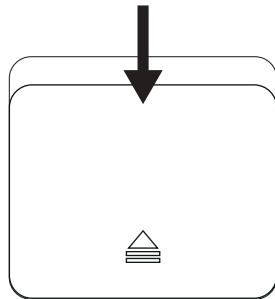
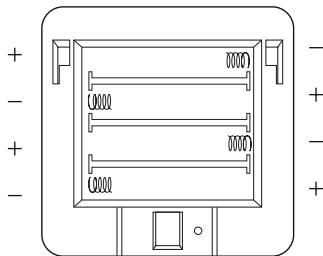
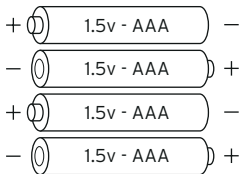
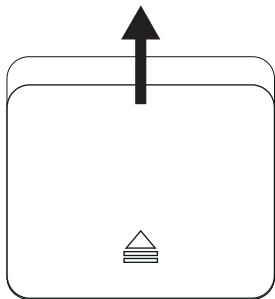

3. Install four new 1.5V AAA batteries, make sure the positive and negative ends are facing the correct direction, as shown below.

4. Replace the battery compartment cover.

NOTE: The scale may need to be recalibrated after replacing the batteries.



Troubleshooting

			
Bluetooth connection	Wi-Fi Connection	Change Battery	Overload
			
Configuring network	Configure network failure	Transferring data	Open App

Frequently Asked Questions

1. Why doesn't the scale work?

- Check if the batteries are properly installed.

2. Why does the data flash on the screen and then disappear?

- The batteries are low and may need to be replaced.

3. Why doesn't the scale connect with the Runcobo app?

- Make sure your phone's operating system is running on iOS 8.0 or above, or Android 4.3 or above.
- Download and open the newest version of the app.
- Turn on Bluetooth on your phone (for Android users, make sure your Location is turned on as well).

4. Why is my body fat not measured when weighing in?

- Step on the scale with dry, bare feet.
- Make sure Bluetooth is turned on.
- Enter your personal information when creating your Runcobo account.

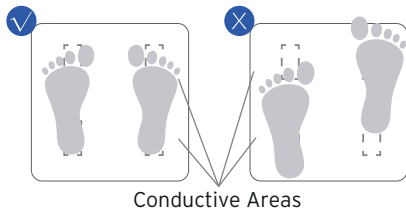

Specifications

Weight Capacity	396 lb / 180kg / 28st
Graduation	0.2 lb (0.05 kg)
Weight Units	lb / kg / st
Platform	Tempered glass
Battery	4 x 1.5V AAA batteries
Dimensions	12.2" x 12.2" x 1.0" (310 x 310 x 25mm)

Warranty

Product	ES-WBE28 Smart Body Composition Scale
Default Warranty Period	1 year(s)
For your own reference, we strongly recommend that you record your Order Number and date of purchase.	
Retail Store	
Order Number	
Date of Purchase	

Terms & Policy

warrants all products to be of the highest quality in material, craftsmanship, and service. effective starting from the date of purchase.

will replace any product found to be defective due to manufacturer flaws based on eligibility; refunds are available within the first 30 days of purchase. This warranty extends only to personal use and does not extend to any product that has been used for commercial, rental, or any other use in which the product is not intended for. There are no warranties other than the warranties expressly set forth with each product.

This warranty is non-transferrable. Runcobo is not responsible in any way for any damages, losses or inconveniences caused by equipment failure or by user negligence, abuse, or use noncompliant with the user manual or any additional safety, use, or warnings included in the product packaging and manual.

This warranty does not apply to the following:

- Damage due to abuse, accident, alteration, misuse, tampering or vandalism.
- Improper or inadequate maintenance.
- Damage in return transit.
- Unsupervised use by children under 18 years of age.

Yolanda and its subsidiaries assume no liability for damage caused by the use of the product other than for its intended use or as instructed in the user manual. Some states do not allow this exclusion or limitation of incidental or consequential losses so the foregoing disclaimer may not apply to you. This warranty gives you specific legal rights and you may also have other rights which may vary from state to state.

Defective Products & Returns

Should your product prove defective within the specified warranty period, please contact Customer Support via support@runcobo.com with your order number. Once our customer service team has approved your request, please return the unit with a copy of the invoice or your order number.

FCC Warning

This device complies with part 15 of the FCC Rules. Operation is subject to the following two conditions: (1) this device may not cause harmful interference, and (2) this device must accept any interference received, including interference that may cause undesired operation.

Any changes or modifications not expressly approved by the party responsible for compliance could void the user's authority to operate the equipment.

NOTE: This equipment has been tested and found to comply with the limits for a Class B digital device, pursuant to Part 15 of the FCC Rules. These limits are designed to provide reasonable protection against harmful interference in a residential installation. This equipment generates, uses and can radiate radio frequency energy and, if not installed and used in accordance with the instructions, may cause harmful interference to radio communications. However, there is no guarantee that interference will not occur in a particular installation.

If this equipment does cause harmful interference to radio or television reception, which can be determined by turning the equipment off and on, the user is encouraged to try to correct the interference by one or more of the following measures:

- Reorient or relocate the receiving antenna.
- Increase the separation between the equipment and receiver.
- Connect the equipment into an outlet on a circuit different from that to which the receiver is connected.
- Consult the dealer or an experienced radio/TV technician for help.

The device has been evaluated to meet general RF exposure requirement. The device can be used in portable exposure condition without restriction.

FCC ID: 2APXU-ES-WBE28

RoHS **CE**  