

APPLICATION CERTIFICATION FCC Part 15C&IC
On Behalf of
ASAP Technology(Jiangxi) Co., Ltd.

10W Fast Wireless Charging Stand - White
10W Fast Wireless Charging Stand - Black

Model No.: B07Q1DJKBQ, B07Q2RH7W9

FCC ID: 2APXNLACA092
IC: 24654-LACA092

Prepared for : ASAP Technology(Jiangxi) Co., Ltd.
Address : No.5, Shuguang Rd, West Zone, Ji'an County Industrial Park,
Ji'an, Jiangxi Ji'an, 343100, P.R.China

Prepared by : Shenzhen Accurate Technology Co., Ltd.
Address : 1/F., Building A, Changyuan New Material Port, Science &
Industry Park, Nanshan District, Shenzhen, Guangdong, P.R.
China

Tel: +86-755-26503290

Fax: +86-755-26503396

Report No. : ATE20190502
Date of Test : March 28-May 28, 2019
Date of Report : May 28, 2019

TABLE OF CONTENTS

Description	Page
Test Report Declaration	
1. TEST RESULTS SUMMARY	4
2. GENERAL INFORMATION	5
2.1. Description of Device (EUT).....	5
2.2. Test Mode	5
2.3. Special Accessory and Auxiliary Equipment	5
2.4. Description of Test Facility	6
2.5. Measurement Uncertainty.....	6
3. MEASURING DEVICE AND TEST EQUIPMENT	7
3.1. The Equipment Used to Measure Conducted Emission	7
3.2. The Equipment Used to Measure Radiated Emission.....	7
4. AC POWER LINE CONDUCTED EMISSION TEST	8
4.1. Block Diagram of Test Setup.....	8
4.2. AC Power Line Conducted Emission Test Limits.....	8
4.3. Configuration of EUT on Test.....	8
4.4. Operating Condition of EUT	8
4.5. Test Procedure	9
4.6. Data Sample.....	9
4.7. Test Results.....	9
5. RADIATED EMISSION TEST	12
5.1. Block Diagram of Test.....	12
5.2. Radiated Emission Test Limit.....	13
5.3. EUT Configuration on Test	13
5.4. Operating Condition of EUT	13
5.5. Test Procedure	14
5.6. Data Sample.....	15
5.7. Test Result	15
6. OCCUPIED BANDWIDTH TEST	21
6.1. The Requirement For Section 15.215(c).....	21
6.2. The Requirement For RSS-Gen Issue 5, section 6.7	21
6.3. Test Procedure	21
6.4. Test Result	22
7. ANTENNA REQUIREMENT.....	23
7.1. The Requirement	23
7.2. Antenna Construction	23

Test Report Declaration

Applicant : ASAP Technology(Jiangxi) Co., Ltd.

Address : No.5, Shuguang Rd, West Zone, Ji'an County Industrial Park, Ji'an, Jiangxi
Ji'an, 343100, P.R.China

Product : 10W Fast Wireless Charging Stand – White
10W Fast Wireless Charging Stand – Black

Model No. : B07Q1DJKBQ, B07Q2RH7W9
(Note: It's just different colors, B07Q1DJKBQ for white, B07Q2RH7W9 for black. So we only tested the B07Q1DJKBQ model)

Measurement Procedure Used:

FCC CFR47 Part 15 Subpart C Section 15.207 and 15.209

ANSI C63.10: 2013

RSS-216 issue 2 January 2016

RSS-Gen Issue 5 April 2018

The device described above is tested by Shenzhen Accurate Technology Co., Ltd. to determine the maximum emission levels emanating from the device. The maximum emission levels are compared to the FCC Part 15 Subpart C and RSS-216 limits both radiated and conducted emissions. The measurement results are contained in this test report and Shenzhen Accurate Technology Co., Ltd. is assumed full responsibility for the accuracy and completeness of these measurements. Also, this report shows that the Equipment Under Test (EUT) is to be technically compliant with the FCC&IC requirements.

This report applies to above tested sample only. This report shall not be reproduced in part without written approval of Shenzhen Accurate Technology Co., Ltd.

Date of Test : March 28-May 28, 2019

Date of Report : May 28, 2019

Prepared by : Star Yang
(Star Yang, Engineer)

Approved & Authorized Signer : Sean Liu
(Sean Liu, Manager)



1. TEST RESULTS SUMMARY

Test Items	Test Standard	Test Results
AC Power Line Conducted Emission	FCC Part 15.207 RSS-216 Issue 2, section 6.2.2.1 RSS-Gen Issue 5, section 8.8	Pass
Radiated Emission	FCC Part 15.209 RSS-216 Issue 2, section 6.2.2.2&6.3.2 RSS-Gen Issue 5, section 8.9	Pass
Occupied Bandwidth	FCC Part 15.215(c) RSS-Gen Issue 5, section 6.7	N/A
Antenna Requirement	FCC Part 15.203 RSS-Gen Issue 5 section 6.8	Pass

2. GENERAL INFORMATION

2.1. Description of Device (EUT)

10W Fast Wireless Charging Stand - White		
Operating Frequency	:	110-205KHz
Type of Modulation	:	FSK
Type of Antenna	:	Induction coil
Operating Voltage	:	Input: DC 5V/2A 9V/1.67A Output: DC 5V/1A 9V/1.1A (10W Max)
Trade Mark	:	

2.2. Test Mode

Test Item	EMI Test Modes
Conducted Emission	Max. Power Output
Radiated Emission	Max. Power Output

2.3. Special Accessory and Auxiliary Equipment

Description	Manufacturer	Model	S/N
Fast charging supply adapter	UGREEN	CD122	N/A
Iphone8S PLUS	Apple	MQ8G2ZP/A	C39V9DEPJCLM

2.4. Description of Test Facility

- EMC Lab : Recognition of accreditation by Federal Communications Commission (FCC)
The Designation Number is CN1189
The Registration Number is 708358
- Listed by Innovation, Science and Economic Development Canada (ISED)
The Registration Number is 5077A-2
- Accredited by China National Accreditation Service for Conformity Assessment (CNAS)
The Registration Number is CNAS L3193
- Accredited by American Association for Laboratory Accreditation (A2LA)
The Certificate Number is 4297.01
- Name of Firm : Shenzhen Accurate Technology Co., Ltd
Site Location : 1/F., Building A, Changyuan New Material Port, Science & Industry Park, Nanshan District, Shenzhen, Guangdong, P.R. China

2.5. Measurement Uncertainty

- Conducted emission expanded uncertainty : U=2.23dB, k=2
- Radiated emission expanded uncertainty (9kHz-30MHz) : U=3.08dB, k=2
- Radiated emission expanded uncertainty (30MHz-1000MHz) : U=4.42dB, k=2
- Radiated emission expanded uncertainty (Above 1GHz) : U=4.06dB, k=2

3. MEASURING DEVICE AND TEST EQUIPMENT

3.1. The Equipment Used to Measure Conducted Emission

Item	Equipment	Manufacturer	Model No.	Serial No.	Last Cal.	Cal. Interval
1.	Test Receiver	Rohde & Schwarz	ESCS30	100307	Jan.05, 2019	1 Year
2.	L.I.S.N.	Schwarzbeck	NLSK8126	8126431	Jan.05, 2019	1 Year
3.	Pulse Limiter	Rohde & Schwarz	ESH3-Z2	100305	Jan.05, 2019	1 Year
4.	50Ω Coaxial Switch	Anritsu Corp	MP59B	6200283936	Jan.05, 2019	1 Year
5.	RF Coaxial Cable	SUHNER	N-2m	No.2	Jan.05, 2019	1 Year
6.	Measurement Software: ES-K1 V1.71					

3.2. The Equipment Used to Measure Radiated Emission

Item	Equipment	Manufacturer	Model No.	Serial No.	Last Cal.	Cal. Interval
1.	Spectrum Analyzer	Rohde&Schwarz	FSV40	101495	Jan.05, 2019	1 Year
2.	Test Receiver	Rohde& Schwarz	ESR	101817	Jan.05, 2019	1 Year
3.	Bilog Antenna	Schwarzbeck	VULB9163	9163-323	Jan.05, 2019	1 Year
4.	Loop Antenna	Schwarzbeck	FMZB1516	1516131	Jan.05, 2019	1 Year
5.	Pre-Amplifier	Agilent	8447D	294A10619	Jan.05, 2019	1 Year
6.	50 Coaxial Switch	Anritsu Corp	MP59B	6200506474	Jan.05, 2019	1 Year
7.	RF Coaxial Cable	RESENBERGER	N-12m	No.11	Jan.05, 2019	1 Year
8.	RF Coaxial Cable	RESENBERGER	N-0.5m	No.12	Jan.05, 2019	1 Year
9.	RF Coaxial Cable	SUHNER	N-2m	No.13	Jan.05, 2019	1 Year
10.	RF Coaxial Cable	SUHNER	N-0.5m	No.15	Jan.05, 2019	1 Year
11.	RF Coaxial Cable	SUHNER	N-2m	No.16	Jan.05, 2019	1 Year
12.	RF Coaxial Cable	RESENBERGER	N-6m	No.17	Jan.05, 2019	1 Year
13.	Measurement Software: EZ EMC V1.1.4.2					

4. AC POWER LINE CONDUCTED EMISSION TEST

4.1. Block Diagram of Test Setup

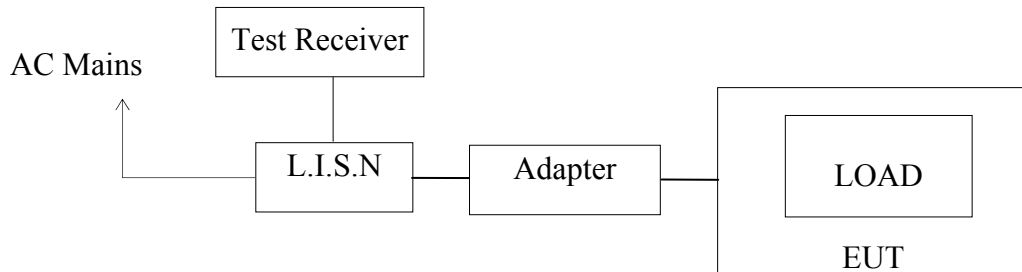

4.2. AC Power Line Conducted Emission Test Limits

Frequency (MHz)	Limit dB(μ V)	
	Quasi-peak Level	Average Level
0.15 - 0.50	66.0 – 56.0 *	56.0 – 46.0 *
0.50 - 5.00	56.0	46.0
5.00 - 30.00	60.0	50.0

NOTE1: The lower limit shall apply at the transition frequencies.
 NOTE2: The limit decreases linearly with the logarithm of the frequency in the range 0.15MHz to 0.50MHz.

4.3. Configuration of EUT on Test

The equipments are installed on Power Line Conducted Emission Measurement to meet the commission requirement and operating regulations in a manner, which tends to maximize its emission characteristics in a normal application.

4.4. Operating Condition of EUT

- 4.4.1. Setup the EUT and simulator as shown as Section 4.1.
- 4.4.2. Turn on the power of all equipment.
- 4.4.3. Let the EUT work in test mode and measure it.

4.5. Test Procedure

The EUT is put on the plane 0.8 m high above the ground by insulating support and is connected to the power mains through a line impedance stabilization network (L.I.S.N.). This provides a 50ohm coupling impedance for the EUT system. Please refer the block diagram of the test setup and photographs. Both sides of AC lines are checked to find out the maximum conducted emission. In order to find the maximum emission levels, the relative positions of equipment and all of the interface cables shall be changed according to ANSI C63.10: 2013 on Conducted Emission Measurement.

The bandwidth of test receiver (R & S ESCS30) is set at 9kHz.

The frequency range from 150kHz to 30MHz is checked.

4.6. Data Sample

Frequency (MHz)	Transducer value (dB)	QuasiPeak Level (dBμV)	Average Level (dBμV)	QuasiPeak Limit (dBμV)	Average Limit (dBμV)	QuasiPeak Margin (dB)	Average Margin (dB)	Remark (Pass/Fail)
X.XX	10.6	25.3	17.0	59.0	49.0	33.7	32.0	Pass

Transducer value = Insertion loss of LISN + Cable Loss
 Result = Quasi-peak Level/Average Level + Transducer value
 Limit = Limit stated in standard

Calculation Formula:

Margin = Limit – Reading level value – Transducer value

4.7. Test Results

Pass.

The frequency range from 150kHz to 30MHz is checked.

Emissions attenuated more than 20 dB below the permissible value are not reported.

The spectral diagrams are attached as below.

ACCURATE TECHNOLOGY CO., LTD

CONDUCTED EMISSION STANDARD FCC PART 15 C

EUT: 10W Fast Wireless Charging Stand - White M/N:B07Q1DJKBQ
 Manufacturer: ASAP Technology(Jiangxi) Co., Ltd.
 Operating Condition: Max. Power Output
 Test Site: 1#Shielding Room
 Operator: WADE
 Test Specification: N 120V/60Hz
 Comment:
 Start of Test: 3/28/2019 /

SCAN TABLE: "V 9K-30MHz fin"

Short Description: _SUB_STD_VTERM2 1.70							
Start Frequency	Stop Frequency	Step Width	Detector	Meas. Time	IF Bandw.	Transducer	
9.0 kHz	150.0 kHz	100.0 Hz	QuasiPeak	1.0 s	200 Hz	NSLK8126 2008	
Average							
150.0 kHz	30.0 MHz	5.0 kHz	QuasiPeak	1.0 s	9 kHz	NSLK8126 2008	
Average							

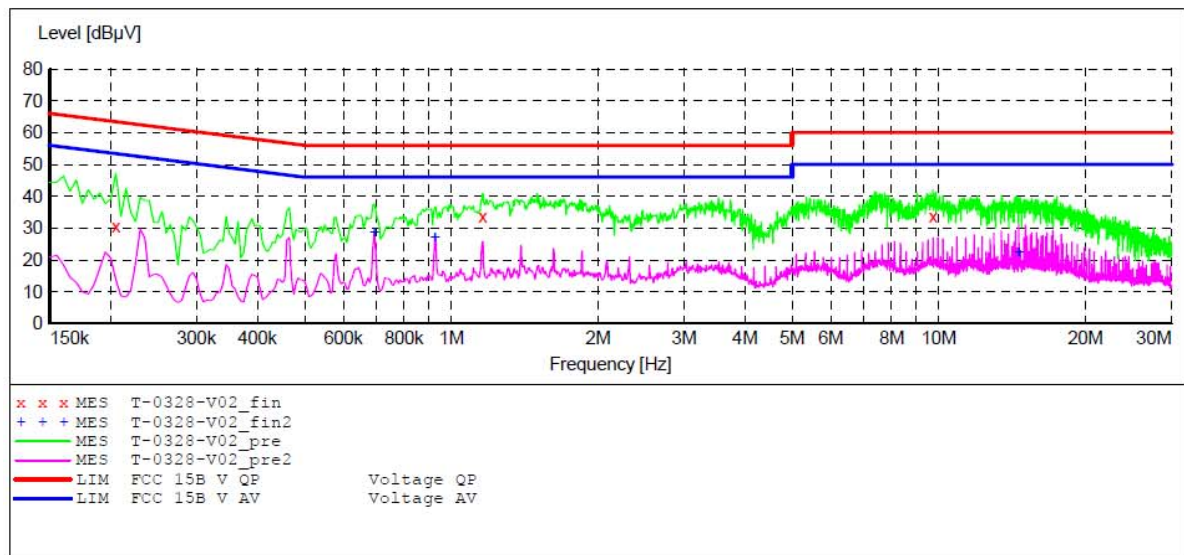

MEASUREMENT RESULT: "T-0328-V02_fin"

3/28/2019

Frequency MHz	Level dBµV	Transd dB	Limit dBµV	Margin dB	Detector	Line	PE
0.205000	30.50	10.5	63	32.9	QP	N	GND
1.160000	33.60	10.9	56	22.4	QP	N	GND
9.720000	33.50	11.3	60	26.5	QP	N	GND

MEASUREMENT RESULT: "T-0328-V02_fin2"

3/28/2019

Frequency MHz	Level dBµV	Transd dB	Limit dBµV	Margin dB	Detector	Line	PE
0.695000	28.40	10.8	46	17.6	AV	N	GND
0.925000	26.90	10.8	46	19.1	AV	N	GND
14.590000	22.20	11.4	50	27.8	AV	N	GND

ACCURATE TECHNOLOGY CO.,LTD

CONDUCTED EMISSION STANDARD FCC PART 15 C

EUT: 10W Fast Wireless Charging Stand - White M/N:B07Q1DJKBQ
 Manufacturer: ASAP Technology(Jiangxi) Co., Ltd.
 Operating Condition: Max. Power Output
 Test Site: 1#Shielding Room
 Operator: WADE
 Test Specification: L 120V/60Hz
 Comment:
 Start of Test: 3/28/2019 /

SCAN TABLE: "V 9K-30MHz fin"

Start Frequency	Stop Frequency	Step Width	Detector	Meas. Time	IF Bandw.	Transducer
9.0 kHz	150.0 kHz	100.0 Hz	QuasiPeak Average	1.0 s	200 Hz	NSLK8126 2008
150.0 kHz	30.0 MHz	5.0 kHz	QuasiPeak Average	1.0 s	9 kHz	NSLK8126 2008

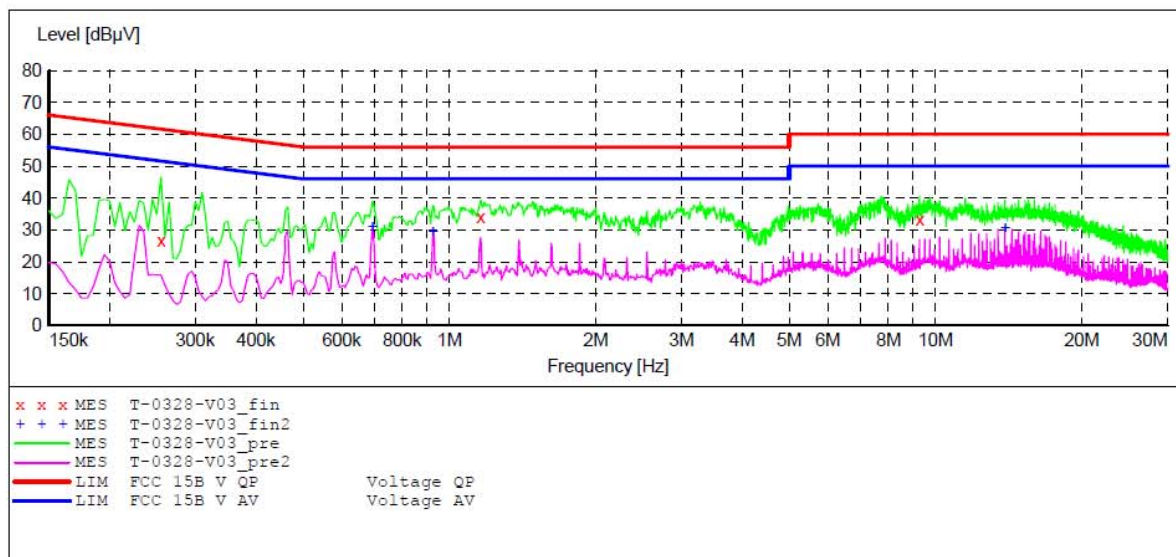

MEASUREMENT RESULT: "T-0328-V03_fin"

3/28/2019

Frequency MHz	Level dBµV	Transd dB	Limit dBµV	Margin dB	Detector	Line	PE
0.255000	26.50	10.6	62	35.1	QP	L1	GND
1.160000	34.00	10.9	56	22.0	QP	L1	GND
9.270000	33.40	11.3	60	26.6	QP	L1	GND

MEASUREMENT RESULT: "T-0328-V03_fin2"

3/28/2019

Frequency MHz	Level dBµV	Transd dB	Limit dBµV	Margin dB	Detector	Line	PE
0.695000	30.70	10.8	46	15.3	AV	L1	GND
0.925000	29.30	10.8	46	16.7	AV	L1	GND
13.900000	30.40	11.4	50	19.6	AV	L1	GND

5. RADIATED EMISSION TEST

5.1. Block Diagram of Test

5.1.1. Block diagram of connection between the EUT and simulators

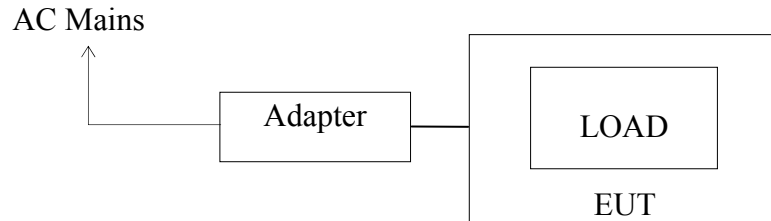

5.1.2. Block diagram of test setup (In chamber)

(A) Radiated Emission Test Set-Up, Frequency below 30MHz

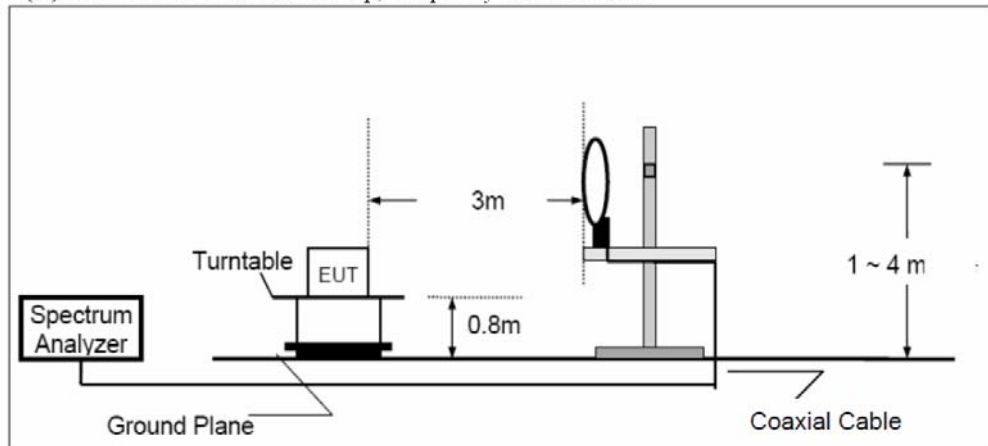

(B) Radiated Emission Test Set-Up, Frequency 30-1000MHz

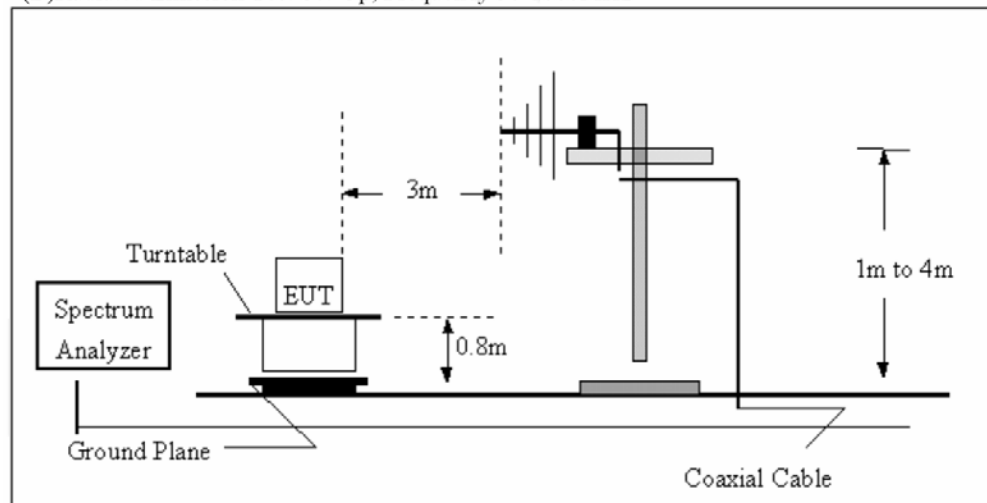

5.2. Radiated Emission Test Limit

Frequency (MHz)	Field Strength Limitation		Field Strength Limitation at 3m Measurement Dist	
	(uV/m)	Dist	(uV/m)	(dBuV/m)
0.009 – 0.490	2400 / F(KHz)	300m	10000 * 2400/F(KHz)	20log 2400/F(KHz) + 80
0.490 – 1.705	24000 / F(KHz)	30m	100 * 24000/F(KHz)	20log 24000/F(KHz) + 40
1.705 – 30.00	30	30m	100* 30	20log 30 + 40
30.0 – 88.0	100	3m	100	20log 100
88.0 – 216.0	150	3m	150	20log 150
216.0 – 960.0	200	3m	200	20log 200
Above 960.0	500	3m	500	20log 500

Limit: $\frac{2400}{125}=19.2\mu\text{V/m}@300\text{m}$

Distance Correction Factor= $40\log(\text{test distance}/\text{specific distance})$

5.3. EUT Configuration on Test

The equipments are installed on Radiated Emission Measurement to meet the commission requirements and operating regulations in a manner which tends to maximize its emission characteristics in normal application.

5.4. Operating Condition of EUT

- 5.4.1. Setup the EUT and simulator as shown as Section 5.1.
- 5.4.2. Turn on the power of all equipment.
- 5.4.3. Let the EUT work in test mode and measure it.

5.5. Test Procedure

The EUT and its simulators are placed on a turntable, which is 0.8 meter high above ground. The turntable can rotate 360 degrees to determine the position of the maximum emission level. EUT is set 3.0 meters away from the receiving antenna, which is mounted on an antenna tower. The antenna can be moved up and down between 1.0 meter and 4 meters to find out the maximum emission level. Broadband antenna (calibrated bilog antenna) is used as receiving antenna. Both horizontal and vertical polarizations of the antenna are set on measurement. In order to find the maximum emission levels, all of the interface cables must be manipulated according to ANSI C63.10: 2013 on radiated emission measurement.

From 9kHz to 30MHz at distance 3m The EUT was rotated a full revolution in order to obtain the maximum value of the electric field intensity.

From 30MHz to 1000MHz at distance 3m The measuring antenna height varied between 1 and 4m and EUT was rotated a full revolution in order to obtain the maximum value of the electric field intensity. The measurements were performed for both vertical and horizontal antenna polarization.

The final measurement will be performed with an EMI Receiver set to Quasi Peak detector for the frequency bands 9kHz to 90kHz and 110 to 490 kHz where an average detector will be used according to Section 15.209(d)(2).

The final level, expressed in dBuV/m, is arrived at by taking the reading from the EMI receiver(Level dBuV) and adding the antenna correction factor and cable loss factor(Factor dB) to it. This result then has to be compared with the relevant FCC limit. The resolution bandwidth during the measurement is as follows:

9kHz – 150kHz: ResBW: 200Hz

150kHz – 30MHz: ResBW: 9kHz

The bandwidth of the EMI test receiver is set at 120kHz from 30MHz to 1000MHz.

5.6.Data Sample

Frequency(MHz)	Reading (dB μ v)	Factor (dB/m)	Result (dB μ v/m)	Limit (dB μ v/m)	Margin (dB)	Remark
X.XX	49.83	-22.03	27.80	43.50	-15.70	QP

Frequency(MHz) = Emission frequency in MHz

Reading(dB μ v) = Uncorrected Analyzer/Receiver reading

Factor (dB/m)= Antenna factor + Cable Loss – Amplifier gain

Result(dB μ v/m) = Reading + Factor

Limit (dB μ v/m)= Limit stated in standard

Calculation Formula:

Margin(dB) = Result (dB μ v/m)–Limit(dB μ v/m)

Result(dB μ v/m)= Reading(dB μ v)+ Factor(dB/m)

The “Margin” column of the following data tables indicates the degree of compliance with the applicable limit. For example, a margin of -7dB means the emission is 7dB below the limit.

5.7.Test Result

Pass.

Emissions attenuated more than 20 dB below the permissible value are not reported.

The spectrum analyzer plots are attached as below.

From 9kHz to 30MHz:

ACCURATE TECHNOLOGY CO.,LTD

RADIATED EMISSION STANDARD FCC PART 15 C

EUT: 10W Fast Wireless Charging Stand - White M/N:B07Q1DJKBQ
 Manufacturer: ASAP Technology(Jiangxi) Co., Ltd.
 Operating Condition: Max. Output Power
 Test Site: 2#Chamber
 Operator: WADE
 Test Specification: DC 5V
 Comment: X
 Start of Test: 2019-4-17 /

SCAN TABLE: "LFRE(E) Fin"

Short Description:			_SUB_STD_VTERM2 1.70				
Start	Stop	Step	Detector	Meas. Time	IF Bandw.	Transducer	
9.0 kHz	150.0 kHz	100.0 Hz	QuasiPeak	1.0 s	200 Hz	1516E	
150.0 kHz	30.0 MHz	5.0 kHz	QuasiPeak	1.0 s	9 kHz	1516E	

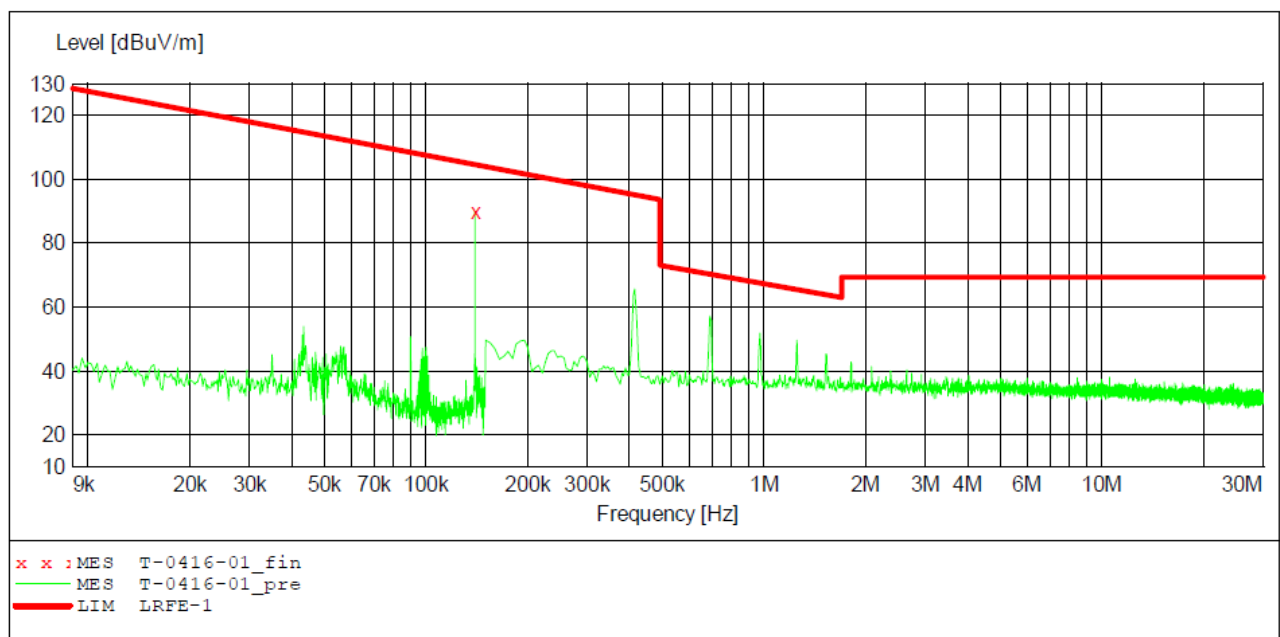

MEASUREMENT RESULT: "T-0416-01_fin"

2019-4-17

Frequency MHz	Level dBuV/m	Transd dB	Limit dBuV/m	Margin dB	Det.	Height cm	Azimuth deg	Polarization
0.139400	89.80	/	/	/	PK	/	/	X

ACCURATE TECHNOLOGY CO., LTD

RADIATED EMISSION STANDARD FCC PART 15 C

EUT: 10W Fast Wireless Charging Stand - White M/N:B07Q1DJKBQ
 Manufacturer: ASAP Technology(Jiangxi) Co., Ltd.
 Operating Condition: Max. Output Power
 Test Site: 2#Chamber
 Operator: WADE
 Test Specification: DC 5V
 Comment: Y
 Start of Test: 2019-4-17 /

SCAN TABLE: "LFRE(E) Fin"

Start	Stop	Step	Detector	Meas. Time	IF Bandw.	Transducer
9.0 kHz	150.0 kHz	100.0 Hz	QuasiPeak	1.0 s	200 Hz	1516E
150.0 kHz	30.0 MHz	5.0 kHz	QuasiPeak	1.0 s	9 kHz	1516E

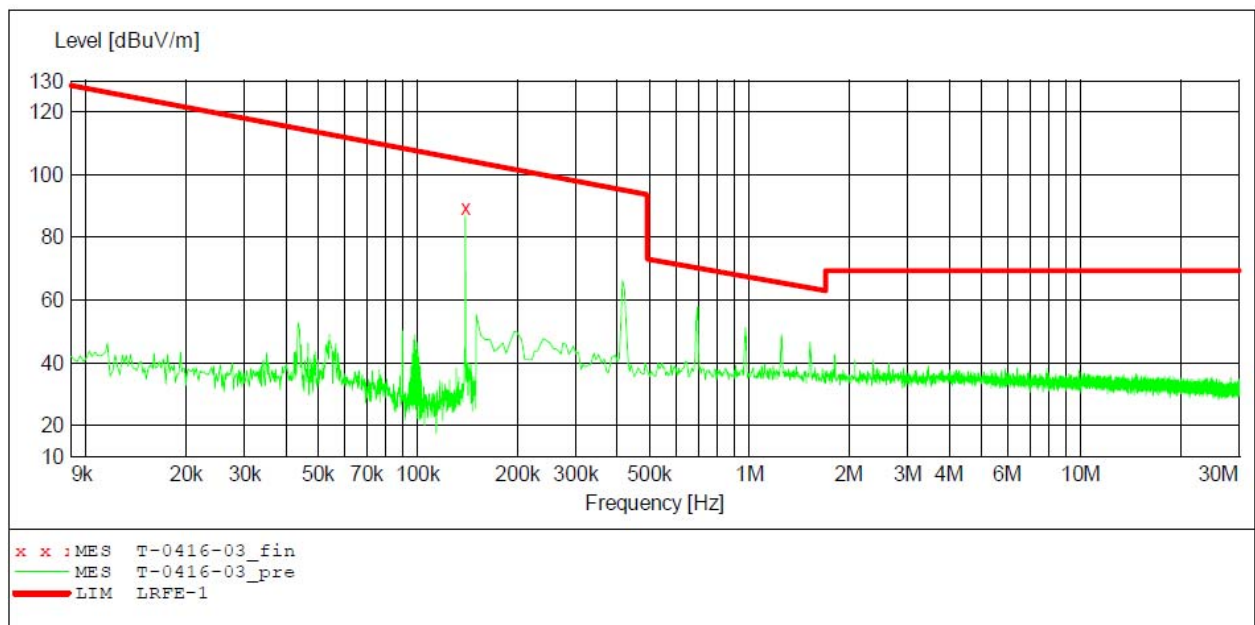

MEASUREMENT RESULT: "T-0416-03_fin"

2019-4-17

Frequency MHz	Level dBuV/m	Transd dB	Limit dBuV/m	Margin dB	Det.	Height cm	Azimuth deg	Polarization
0.138600	89.56	/	/	/	PK	/	/	Y

ACCURATE TECHNOLOGY CO., LTD

RADIATED EMISSION STANDARD FCC PART 15 C

EUT: 10W Fast Wireless Charging Stand - White M/N:B07Q1DJKBQ
 Manufacturer: ASAP Technology(Jiangxi) Co., Ltd.
 Operating Condition: Max. Output Power
 Test Site: 2#Chamber
 Operator: WADE
 Test Specification: DC 5V
 Comment: Z
 Start of Test: 2019-4-17 /

SCAN TABLE: "LFRE(E) Fin"

Short Description:		_SUB_STD_VTERM2 1.70					
Start	Stop	Step	Detector	Meas. Time	IF Bandw.	Transducer	
9.0 kHz	150.0 kHz	100.0 Hz	QuasiPeak	1.0 s	200 Hz	1516E	
150.0 kHz	30.0 MHz	5.0 kHz	QuasiPeak	1.0 s	9 kHz	1516E	

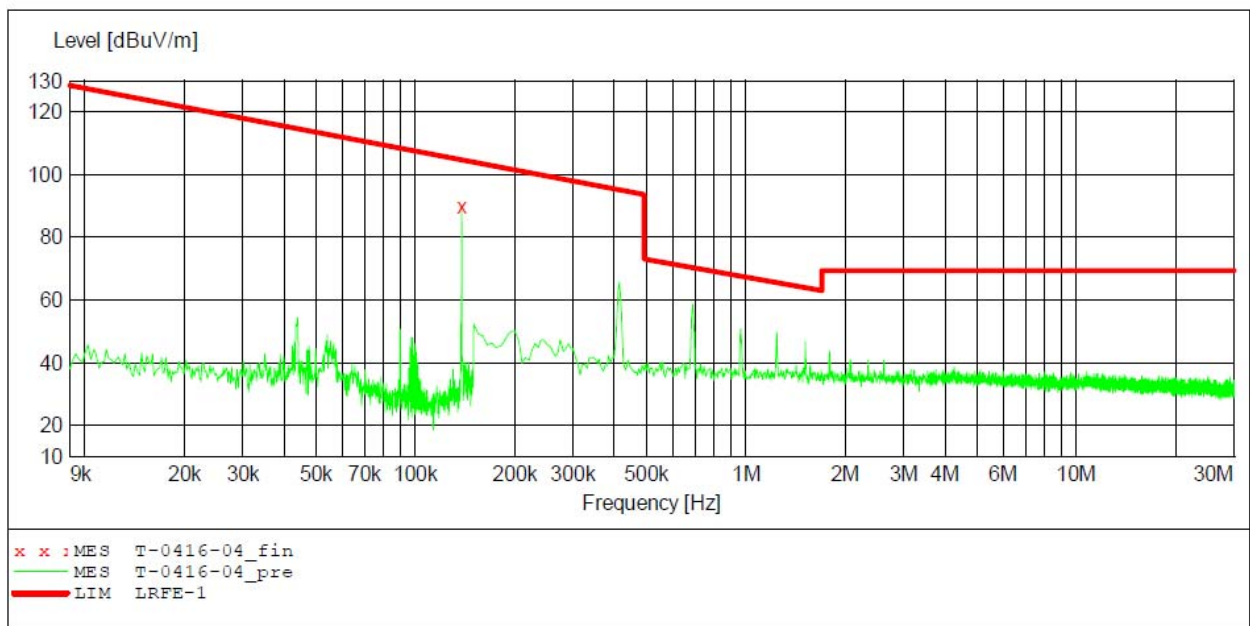

MEASUREMENT RESULT: "T-0416-04_fin"

2019-4-17

Frequency MHz	Level dBuV/m	Transd dB	Limit dBuV/m	Margin dB	Det.	Height cm	Azimuth deg	Polarization
0.137600	90.06	/	/	/	PK	/	/	Z

Job No.: tuv2018 #1962	Polarization: Horizontal
Standard: FCC Part 15C 3M Radiated	Power Source: DC 5V
Test item: Radiation Test	Date: 19/03/29/
Temp.(C)/Hum.(%) 23 C / 48 %	Time:
EUT: 10W Fast Wireless Charging Stand - White	Engineer Signature: WADE
Mode: Max. Output Power	Distance: 3m
Model: B07Q1DJKBQ	
Manufacturer: ASAP Technology(Jiangxi) Co., Ltd.	

Note:

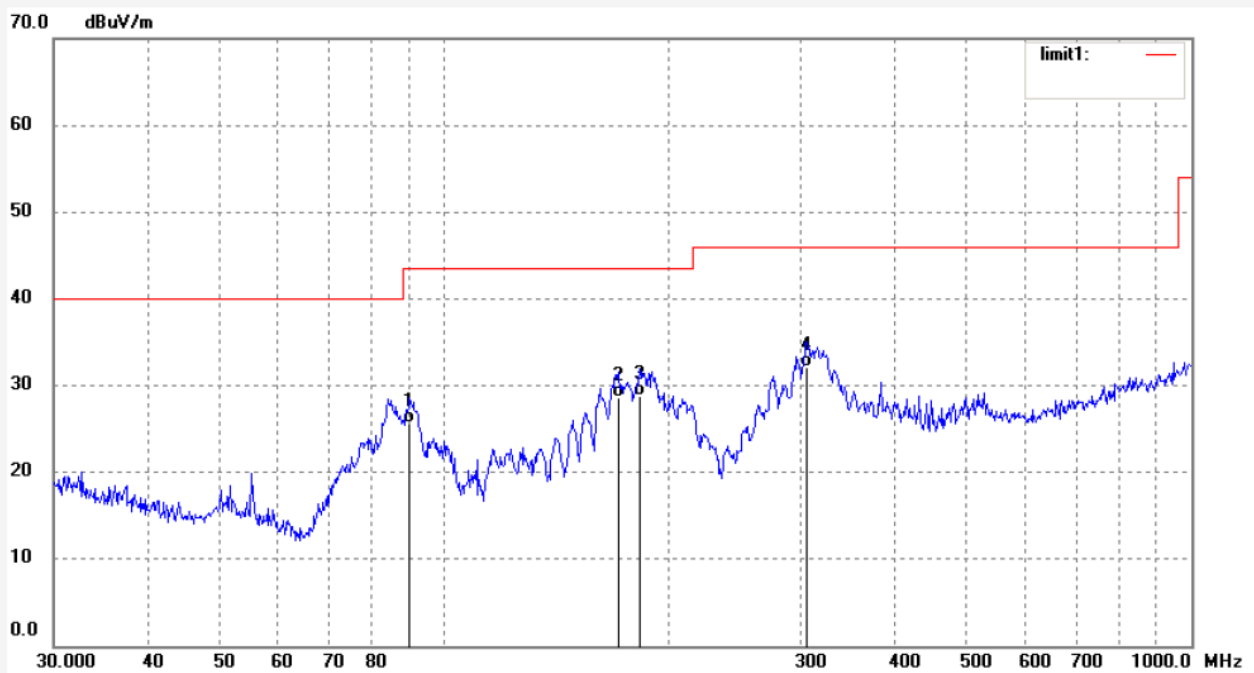

No.	Freq. (MHz)	Reading (dBuV/m)	Factor (dB)	Result (dBuV/m)	Limit (dBuV/m)	Margin (dB)	Detector	Height (cm)	Degree (deg.)	Remark
1	89.9047	40.63	-15.01	25.62	43.50	-17.88	QP			
2	170.7925	42.07	-13.53	28.54	43.50	-14.96	QP			
3	182.5592	41.80	-12.93	28.87	43.50	-14.63	QP			
4	305.6800	41.05	-8.90	32.15	46.00	-13.85	QP			

Job No.: tuv2018 #1963

Standard: FCC Part 15C 3M Radiated

Test item: Radiation Test

Temp.(C)/Hum.(%) 23 C / 48 %

EUT: 10W Fast Wireless Charging Stand - White

Mode: Max. Output Power

Model: B07Q1DJKBQ

Manufacturer: ASAP Technology(Jiangxi) Co., Ltd.

Polarization: Vertical

Power Source: DC 5V

Date: 19/03/29/

Time:

Engineer Signature: WADE

Distance: 3m

Note:

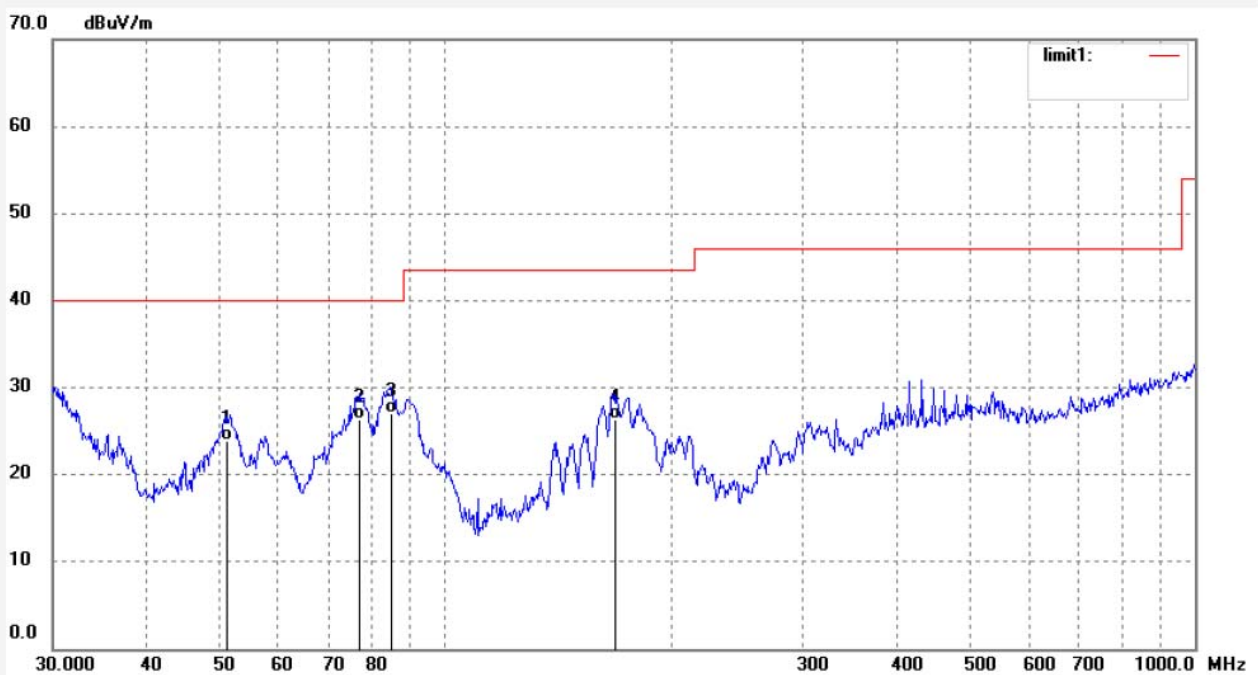

No.	Freq. (MHz)	Reading (dBuV/m)	Factor (dB)	Result (dBuV/m)	Limit (dBuV/m)	Margin (dB)	Detector	Height (cm)	Degree (deg.)	Remark
1	51.1209	36.61	-12.67	23.94	40.00	-16.06	QP			
2	77.0505	42.89	-16.61	26.28	40.00	-13.72	QP			
3	84.7019	42.45	-15.39	27.06	40.00	-12.94	QP			
4	168.4138	40.06	-13.79	26.27	43.50	-17.23	QP			

6. OCCUPIED BANDWIDTH TEST

6.1. The Requirement For Section 15.215(c)

Intentional radiators operating under the alternative provisions to the general emission limits, as contained in §§15.217 through 15.257 and in subpart E of this part, must be designed to ensure that 20dB bandwidth of the emission, or whatever bandwidth may otherwise be specified in the specific rule section under which the equipment compliance with the 20dB attenuation specification may be based on measurement at the intentional radiator's antenna output terminal unless the intentional radiator uses a permanently attached antenna, in which case compliance shall be demonstrated by measuring the radiated emissions.

6.2. The Requirement For RSS-Gen Issue 5, section 6.7

The occupied bandwidth or the "99% emission bandwidth" is defined as the frequency range between two points, one above and the other below the carrier frequency, within which 99% of the total transmitted power of the fundamental transmitted emission is contained. The occupied bandwidth shall be reported for all equipment in addition to the specified bandwidth required in the applicable RSSs.

In some cases, the "x dB bandwidth" is required, which is defined as the frequency range between two points, one at the lowest frequency below and one at the highest frequency above the carrier frequency, at which the maximum power level of the transmitted emission is attenuated x dB below the maximum in-band power level of the modulated signal, where the two points are on the outskirts of the in-band emission.

6.3. Test Procedure

Use the following spectrum analyzer settings:

- a) The spectrum analyzer center frequency is set to the nominal EUT channel center frequency
- b) Span = approximately 2 to 5 times the OBW
- c) RBW = 1% to 5% of the OBW
- d) VBW $\geq 3 \times$ RBW
- e) Sweep = auto;
- f) Detector function = peak
- g) Trace = max hold
- h) All the trace to stabilize, use the marker-to-peak function to set the marker to the peak of the emission, use the marker-delta function to measure and record the 20dB down bandwidth of the emission.

6.4. Test Result

Frequency (KHz)	99% Occupied Bandwidth (KHz)	20dB Bandwidth (KHz)
127.508	0.109	0.126

99% Occupied Bandwidth

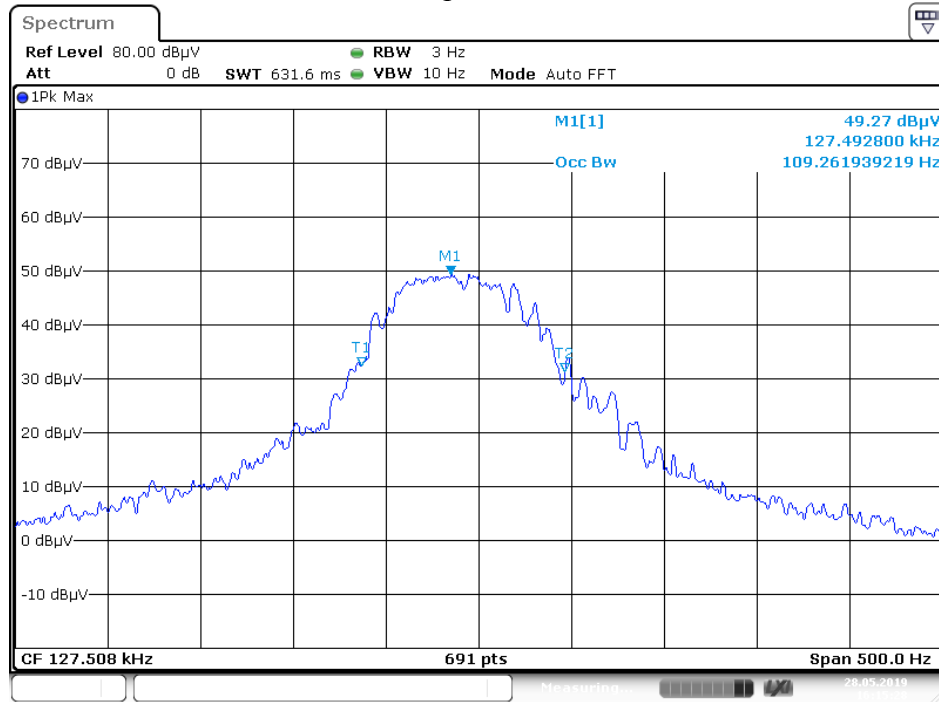

Date: 28.MAY.2019 16:15:28

20dB Bandwidth

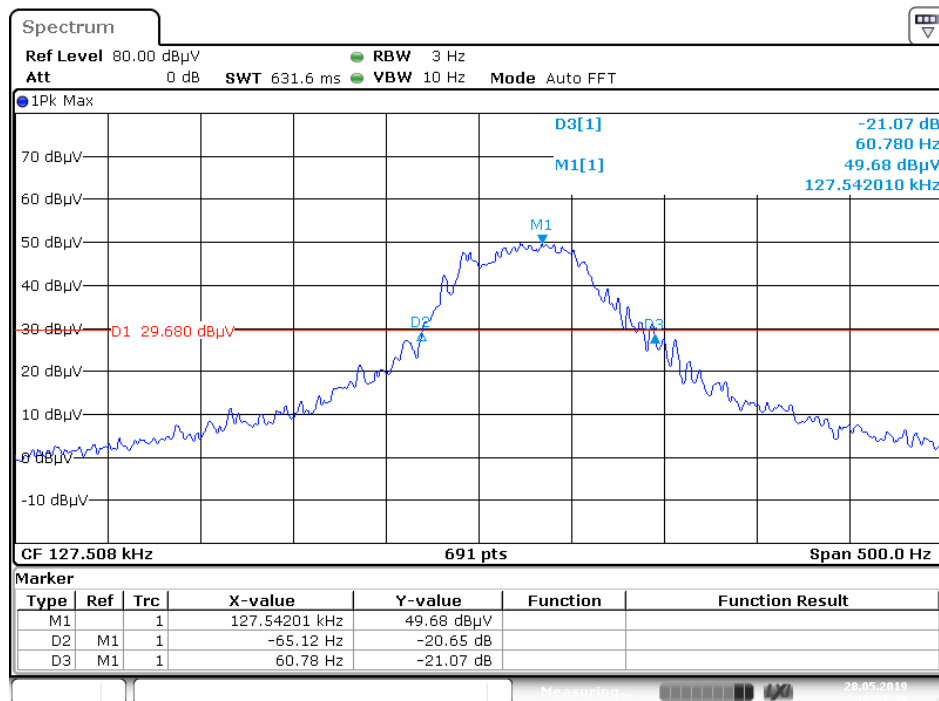

Date: 28.MAY.2019 16:21:39

7. ANTENNA REQUIREMENT

7.1.The Requirement

According to Section 15.203 and RSS-Gen Section 6.8, an intentional radiator shall be designed to ensure that no antenna other than that furnished by the responsible party shall be used with the device.

7.2.Antenna Construction

Device is equipped with permanent attached antenna, which isn't displaced by other antenna. Therefore, the equipment complies with the antenna requirement of Section 15.203 and RSS-Gen Section 6.8.

******* End of Test Report *******