



**CFR 47 FCC PART 15 SUBPART E  
ISED RSS-247 ISSUE 2**

**CERTIFICATION TEST REPORT**

*For*

**Street Fighter II Big Blue**

**MODEL NUMBER: STF-A-01077, STF-A-01246**

**FCC ID: 2APXHSFBB  
IC: 24128-SFBB**

**REPORT NUMBER: 4789938004 .2-1**

**ISSUE DATE: May 28, 2021**

*Prepared for*

**WF Tastemakers Trading Limited (FCC)  
Unit 05 and unit 06, 6th Floor, Greenfield Tower Concordia Plaza, 1 Science Museum  
Road, TST East, Hong Kong**

**WF TASTEMAKERS TRADING LIMITED (ISED)  
980 Avenue of the Americas, 3rd Floor New York NY 10018 American Samoa**

*Prepared by*

**UL Verification Services (Guangzhou) Co., Ltd, Song Shan Lake Branch**

**Building 10, Innovation Technology Park, No. 1, Li Bin Road, Song Shan Lake Hi-  
Tech Development Zone Dongguan, 523808, People's Republic of China**

**Tel: +86 769 22038881  
Fax: +86 769 33244054  
Website: www.ul.com**



Revision History

<u>Rev.</u>	<u>Issue Date</u>	<u>Revisions</u>	<u>Revised By</u>
V0	5/28/2021	Initial Issue	



Summary of Test Results			
Clause	Test Items	FCC/IC Rules	Test Results
1	6dB/26dB Bandwidth	FCC 15.407 (a)&(e) RSS-247 Clause 6.2	PASS
2	99% Occupied Bandwidth	RSS-Gen Clause 6.7	PASS
3	Conducted Output Power	FCC 15.407 (a) RSS-247 Clause 6.2	PASS
4	Power Spectral Density	FCC 15.407 (a) RSS-247 Clause 6.2	PASS
5	Radiated Bandedge and Spurious Emission	FCC 15.407 (b) FCC 15.209 FCC 15.205 RSS-247 Clause 6.2 RSS-GEN Clause 8.9	PASS
6	Conducted Emission Test for AC Power Port	FCC 15.207 RSS-GEN Clause 8.8	PASS
7	Frequency Stability	FCC 15.407 (g)	PASS
8	Dynamic Frequency Selection	FCC 15.407 (h) RSS-247 Clause 6.3	PASS
9	Antenna Requirement	FCC 15.203 RSS-GEN Clause 6.8	PASS
<p>Note:</p> <p>1. This test report is only published to and used by the applicant, and it is not for evidence purpose in China.</p> <p>2. The measurement result for the sample received is &lt;Pass&gt; according to &lt; CFR 47 FCC PART 15 SUBPART C &gt;&lt; ISED RSS-247 &gt; when &lt;Accuracy Method&gt; decision rule is applied.</p>			



## TABLE OF CONTENTS

<b>1. ATTESTATION OF TEST RESULTS .....</b>	<b>7</b>
<b>2. TEST METHODOLOGY .....</b>	<b>9</b>
<b>3. FACILITIES AND ACCREDITATION .....</b>	<b>9</b>
<b>4. CALIBRATION AND UNCERTAINTY .....</b>	<b>10</b>
4.1. <i>MEASURING INSTRUMENT CALIBRATION .....</i>	<i>10</i>
4.2. <i>MEASUREMENT UNCERTAINTY.....</i>	<i>10</i>
<b>5. EQUIPMENT UNDER TEST .....</b>	<b>11</b>
5.1. <i>MAXIMUM OUTPUT POWER.....</i>	<i>11</i>
5.2. <i>CHANNEL LIST .....</i>	<i>12</i>
5.3. <i>DESCRIPTION OF EUT .....</i>	<i>13</i>
5.4. <i>TEST CHANNEL CONFIGURATION.....</i>	<i>14</i>
5.5. <i>DESCRIPTION OF AVAILABLE ANTENNAS .....</i>	<i>15</i>
5.6. <i>THE WORSE CASE POWER SETTING PARAMETER.....</i>	<i>16</i>
5.7. <i>THE WORSE CASE CONFIGURATIONS .....</i>	<i>18</i>
5.8. <i>DESCRIPTION OF TEST SETUP.....</i>	<i>19</i>
<b>6. MEASURING INSTRUMENT AND SOFTWARE USED .....</b>	<b>20</b>
<b>7. ANTENNA PORT TEST RESULTS .....</b>	<b>22</b>
7.1. <i>ON TIME AND DUTY CYCLE.....</i>	<i>22</i>
7.2. <i>6/26 dB EMISSION BANDWIDTH AND 99 % OCCUPIED BANDWIDTH .....</i>	<i>23</i>
7.3. <i>CONDUCTED OUTPUT POWER.....</i>	<i>26</i>
7.4. <i>POWER SPECTRAL DENSITY .....</i>	<i>29</i>
<b>8. RADIATED TEST RESULTS.....</b>	<b>31</b>
8.1. <i>RESTRICTED BANDEDGE.....</i>	<i>37</i>
8.1.1. <i>802.11a MODE .....</i>	<i>37</i>
UNII-1 BAND .....	37
UNII-2A BAND .....	39
UNII-2C BAND.....	41
UNII-3 BAND .....	44
8.1.2. <i>802.11n HT20 MODE .....</i>	<i>46</i>
UNII-1 BAND .....	46
UNII-2A BAND .....	48
UNII-2C BAND.....	50
UNII-3 BAND .....	53
8.1.3. <i>802.11n HT40 MODE .....</i>	<i>55</i>
UNII-1 BAND .....	55
UNII-2A BAND .....	57



UNII-2C BAND .....59  
UNII-3 BAND .....62

8.2. SPURIOUS EMISSIONS (1 GHz ~ 7 GHz) .....64  
8.2.1. 802.11 a MODE .....64  
UNII-1 BAND .....64  
UNII-2A BAND .....70  
UNII-2C BAND .....76  
STRADDLE CHANNEL 144 .....82  
UNII-3 BAND .....84

8.3. SPURIOUS EMISSIONS (7 GHz ~ 18 GHz) .....90  
8.3.1. 802.11a MODE .....90  
UNII-1 BAND .....90  
UNII-2A BAND .....96  
UNII-2C BAND .....102  
STRADDLE CHANNEL 144 .....108  
UNII-3 BAND .....110  
8.3.2. 802.11n HT20 MODE .....116  
UNII-1 BAND .....116  
UNII-2A BAND .....122  
UNII-2C BAND .....128  
STRADDLE CHANNEL 144 .....134  
UNII-3 BAND .....136  
8.3.3. 802.11n HT40 MODE .....142  
UNII-1 BAND .....142  
UNII-2A BAND .....146  
UNII-2C BAND .....150  
STRADDLE CHANNEL 142 .....156  
UNII-3 BAND .....158

8.4. SPURIOUS EMISSIONS (18 GHz ~ 26 GHz) .....162  
8.4.1. 802.11a MODE .....162

8.5. SPURIOUS EMISSIONS (26 GHz ~ 40 GHz) .....164  
8.5.1. 802.11a MODE .....164

8.6. SPURIOUS EMISSIONS (30 MHz ~ 1 GHz) .....166  
8.6.1. 802.11a MODE .....166

8.7. SPURIOUS EMISSIONS BELOW 30 MHz .....168  
8.7.1. 802.11a MODE .....168

**9. AC POWER LINE CONDUCTED EMISSIONS .....171**  
9.1. 802.11a MODE .....173

**10. FREQUENCY STABILITY .....175**

**11. DYNAMIC FREQUENCY SELECTION .....177**

**12. ANTENNA REQUIREMENTS .....181**

**13. Appendix .....182**  
13.1. Appendix A1: Emission Bandwidth .....182



13.1.1. Test Result..... 182  
13.1.2. Test Graphs ..... 183  
13.2. *Appendix A2: Occupied channel bandwidth*..... 195  
13.2.1. Test Result..... 195  
13.2.2. Test Graphs ..... 196  
13.3. *Appendix A3: Min emission bandwidth* ..... 208  
13.3.1. Test Result..... 208  
13.3.2. Test Graphs ..... 209  
13.4. *Appendix B: Maximum AVG conducted output power* ..... 213  
13.4.1. Test Result..... 213  
13.5. *Appendix C: Maximum power spectral density* ..... 214  
13.5.1. Test Result..... 214  
13.5.2. Test Graphs ..... 215  
13.6. *Appendix D: Duty Cycle*..... 228  
13.6.1. Test Result..... 228  
13.6.2. Test Graphs ..... 229  
13.7. *Appendix E: Frequency Stability*..... 230  
Test Result..... 230  
13.8. *Appendix I: Channel Move Time and Channel Closing Transmission Time* ..... 231  
13.8.1. Test Result..... 231  
13.8.2. Test Graphs ..... 232  
13.9. *Appendix J: Non-Occupancy Period*..... 233  
13.9.1. Test Result..... 233  
13.9.2. Test Graphs ..... 234



# 1. ATTESTATION OF TEST RESULTS

## FCC

### Applicant Information

Company Name: WF Tastemakers Trading Limited  
Address: Unit 05 and unit 06, 6th Floor, Greenfield Tower Concordia Plaza,  
1 Science Museum Road, TST East, Hong Kong

## ISED

### Applicant Information

Company Name: WF Tastemakers Trading Limited  
Address: 980 Avenue of the Americas, 3rd Floor New York NY 10018  
American Samoa

## FCC

### Manufacturer Information

Company Name: WF Tastemakers Trading Limited  
Address: Unit 05 and unit 06, 6th Floor, Greenfield Tower Concordia Plaza,  
1 Science Museum Road, TST East, Hong Kong

## ISED

### Manufacturer Information

Company Name: WF Tastemakers Trading Limited  
Address: 980 Avenue of the Americas, 3rd Floor New York NY 10018  
American Samoa

## EUT Information

EUT Name: Street Fighter II Big Blue  
Model: STF-A-01077  
Series Model: STF-A-01246  
Brand: ARCADE 1 UP  
Sample Received Date: May 14, 2021  
Sample Status: Normal  
Sample ID: 3905027

APPLICABLE STANDARDS	
STANDARD	TEST RESULTS
CFR 47 FCC PART 15 SUBPART E	PASS
ISED RSS-247 Issue 2	PASS
ISED RSS-GEN Issue 5	PASS



Prepared By:

---

Kebo Zhang  
Project Engineer

Checked By:

---

Shawn Wen  
Laboratory Leader

Approved By:

---

Stephen Guo  
Laboratory Manager





## 2. TEST METHODOLOGY

The tests documented in this report were performed in accordance with ANSI C63.10-2013, CFR 47 FCC Part 2, CFR 47 FCC Part 15, KDB 789033 D02 v02r01, RSS-GEN Issue 5, RSS-247 Issue 2, KDB414788 D01 Radiated Test Site v01r01, KDB 905462 D02 UNII DFS Compliance Procedures New Rules v02, KDB 905462 D03 UNII clients without radar detection New Rules v01r02, KDB 905462 D04 Operational Modes for DFS Testing New Rules v01 and KDB 905462 D06 802 11 Channel Plans New Rules v02.

## 3. FACILITIES AND ACCREDITATION

Accreditation Certificate	<p><b>A2LA (Certificate No.: 4102.01)</b> UL Verification Services (Guangzhou) Co., Ltd. Song Shan Lake Branch. has been assessed and proved to be in compliance with A2LA.</p> <p><b>FCC (FCC Designation No.: CN1187)</b> UL Verification Services (Guangzhou) Co., Ltd. Song Shan Lake Branch. Has been recognized to perform compliance testing on equipment subject to the Commission's Declaration of Conformity (DoC) and Certification rules</p> <p><b>ISED (Company No.: 21320)</b> UL Verification Services (Guangzhou) Co., Ltd. Song Shan Lake Branch. has been registered and fully described in a report filed with ISED. The Company Number is 21320 and the test lab Conformity Assessment Body Identifier (CABID) is CN0046.</p> <p><b>VCCI (Registration No.: G-20019, R-20004, C-20012 and T-20011)</b> UL Verification Services (Guangzhou) Co., Ltd. Song Shan Lake Branch. has been assessed and proved to be in compliance with VCCI, the Membership No. is 3793. Facility Name: Chamber D, the VCCI registration No. is G-20019 and R-20004 Shielding Room B , the VCCI registration No. is C-20012 and T-20011</p>
---------------------------	---

Note 1: All tests measurement facilities use to collect the measurement data are located at Building 10, Innovation Technology Park, Song Shan Lake Hi tech Development Zone, Dongguan, 523808, China

Note 2: The test anechoic chamber in UL Verification Services (Guangzhou) Co., Ltd. Song Shan Lake Branch had been calibrated and compared to the open field sites and the test anechoic chamber is shown to be equivalent to or worst case from the open field site.

Note 3: For below 30 MHz, lab had performed measurements at test anechoic chamber and comparing to measurements obtained on an open field site. And these measurements below 30 MHz had been correlated to measurements performed on an OFS.



## 4. CALIBRATION AND UNCERTAINTY

### 4.1. MEASURING INSTRUMENT CALIBRATION

The measuring equipment utilized to perform the tests documented in this report has been calibrated in accordance with the manufacturer's recommendations and is traceable to recognize national standards.

### 4.2. MEASUREMENT UNCERTAINTY

Where relevant, the following measurement uncertainty levels have been estimated for tests performed on the apparatus:

Test Item	Uncertainty
Conduction emission	3.62 dB
Radiated Emission (Included Fundamental Emission) (9 kHz ~ 30 MHz)	2.2 dB
Radiated Emission (Included Fundamental Emission) (30 MHz ~ 1 GHz)	4.00 dB
Radiated Emission (Included Fundamental Emission) (1 GHz to 26 GHz)	5.78 dB (1 GHz ~ 18 GHz)
	5.23 dB (18 GHz ~ 26 GHz)
Duty Cycle	±0.028%
Emission Bandwidth and 99% Occupied Bandwidth	±0.0196%
Maximum Conducted Output Power	±0.766 dB
Maximum Power Spectral Density Level	±1.22 dB
Frequency Stability	±2.76%
Conducted Band-edge Compliance	±1.328 dB
Conducted Unwanted Emissions In Non-restricted Frequency Bands	±0.746 dB (9 kHz ~ 1 GHz)
	±1.328dB (1 GHz ~ 26 GHz)
Note: This uncertainty represents an expanded uncertainty expressed at approximately the 95% confidence level using a coverage factor of k=2.	



## 5. EQUIPMENT UNDER TEST

### 5.1. MAXIMUM OUTPUT POWER

#### UNII-1 BAND

IEEE Std. 802.11	Frequency (MHz)	Maximum Average Conducted Power (dBm)
a	5180 ~ 5240	16.13
n HT20		15.83
n HT40		14.58

#### UNII-2A BAND

IEEE Std. 802.11	Frequency (MHz)	Maximum Average Conducted Power (dBm)
a	5260 ~ 5320	15.29
n HT20		15.19
n HT40		13.81

#### UNII-2C BAND

IEEE Std. 802.11	Frequency (MHz)	Maximum Average Conducted Power (dBm)
a	5510 ~ 5670	15.50
n HT20		15.62
n HT40		12.90

#### UNII-3 BAND

IEEE Std. 802.11	Frequency (MHz)	Maximum Average Conducted Power (dBm)
a	5725 ~ 5825	14.44
n HT20		14.29
n HT40		11.92



**5.2. CHANNEL LIST**

UNII-1 (For Bandwidth=20MHz)		UNII-1 (For Bandwidth=40MHz)	
Channel	Frequency (MHz)	Channel	Frequency (MHz)
36	5180	38	5190
40	5200	46	5230
44	5220		
48	5240		

UNII-2A (For Bandwidth=20MHz)		UNII-2A (For Bandwidth=40MHz)	
Channel	Frequency (MHz)	Channel	Frequency (MHz)
52	5260	54	5270
56	5280	62	5310
60	5300		
64	5320		

UNII-2C (For Bandwidth=20MHz)		UNII-2C (For Bandwidth=40MHz)	
Channel	Frequency (MHz)	Channel	Frequency (MHz)
100	5500	102	5510
104	5520	110	5550
108	5540	118	5590
112	5560	126	5630
116	5580	134	5670
120	5600	142	5710
124	5620		
128	5640		
132	5660		
136	5680		
140	5700		
144	5720		

UNII-3 (For Bandwidth=20MHz)		UNII-3 (For Bandwidth=40MHz)	
Channel	Frequency (MHz)	Channel	Frequency (MHz)
149	5745	151	5755
153	5765	159	5795
157	5785		
161	5805		
165	5825		



### 5.3. DESCRIPTION OF EUT

EUT Name	Street Fighter II Big Blue
Model Name	STF-A-01077
Series Model	STF-A-01246
Model differences	STF-A-01077 (New model numbers) have the same technical construction including circuit diagram, PCB Layout, components and component layout, all electrical construction and mechanical construction with STF-A-01246 (original model number). The difference lies only the model name and non metal decoration for the enclosure.
Note	Both models have been considered, only the worst-case model STF-A-01077 test data recorded in this report.
Radio Technology	IEEE802.11a IEEE802.11n HT20/n HT40
Operation frequency	UNII-1/UNII-2A/UNII-2C/UNII-3
Modulation	OFDM (BPSK, QPSK,16QAM,64QAM)
Rating	AC 120 V, 60 Hz



### 5.4. TEST CHANNEL CONFIGURATION

UNII-1 Test Channel Configuration		
IEEE Std.	Test Channel Number	Frequency
802.11a	CH 36(Low Channel), CH 40(MID Channel), CH 48(High Channel)	5180 MHz, 5200 MHz, 5240 MHz
802.11n HT20	CH 36(Low Channel), CH 40(MID Channel), CH 48(High Channel)	5180 MHz, 5200 MHz, 5240 MHz
802.11n HT40	CH 38(Low Channel), CH 46(High Channel)	5190 MHz, 5230 MHz
UNII-2A Test Channel Configuration		
IEEE Std.	Test Channel Number	Frequency
802.11a	CH 52(Low Channel), CH 56(MID Channel), CH 64(High Channel)	5260 MHz, 5280 MHz, 5320 MHz
802.11n HT20	CH 52(Low Channel), CH 56(MID Channel), CH 64(High Channel)	5260 MHz, 5280 MHz, 5320 MHz
802.11n HT40	CH 54(Low Channel), CH 62(High Channel)	5270 MHz, 5310 MHz

UNII-2C Test Channel Configuration		
IEEE Std.	Test Channel Number	Frequency
802.11a	CH 100(Low Channel), CH 120(MID Channel), CH 140(High Channel), CH144	5500 MHz, 5600 MHz, 5700 MHz, 5720 MHz
802.11n HT20	CH 100(Low Channel), CH 120(MID Channel), CH 140(High Channel), CH144	5500 MHz, 5600 MHz, 5700 MHz, 5720 MHz
802.11n HT40	CH 102(Low Channel), CH 118(MID Channel), CH 134(High Channel), CH142	5510 MHz, 5590 MHz, 5670 MHz, 5710 MHz

UNII-3 Test Channel Configuration		
IEEE Std.	Test Channel Number	Frequency
802.11a	CH 149(Low Channel), CH 157(MID Channel), CH 165(High Channel)	5745 MHz, 5785 MHz, 5825 MHz
802.11n HT20	CH 149(Low Channel), CH 157(MID Channel), CH 165(High Channel)	5745 MHz, 5785 MHz, 5825 MHz
802.11n HT40	CH 151(Low Channel), CH 159(High Channel)	5755 MHz, 5795 MHz



### 5.5. DESCRIPTION OF AVAILABLE ANTENNAS

Antenna No.	Frequency Band	Antenna Type	Max Antenna Gain (dBi)
1	5180~5825	PCB Antenna	4.17

IEE Std. 802.11	Transmit and Receive Mode	Description
802.11a	<input checked="" type="checkbox"/> 1TX, 1RX	ANT 1 can be used as transmitting/receiving antenna.
802.11n HT20	<input checked="" type="checkbox"/> 1TX, 1RX	ANT 1 can be used as transmitting/receiving antenna.
802.11n HT40	<input checked="" type="checkbox"/> 1TX, 1RX	ANT 1 can be used as transmitting/receiving antenna.

### 5.6. THE WORSE CASE POWER SETTING PARAMETER

The Worse Case Power Setting Parameter	
Test Software	RF test tool

#### UNII-1

Mode	Rate	Channel	Soft set value
			ANT 1
11a	6M	36	17
		40	17
		48	17
11n HT20	MCS0	36	default
		40	default
		48	default
11n HT40	MCS0	38	default
		46	default

#### UNII-2A

Mode	Rate	Channel	Soft set value
			ANT 1
11a	6M	52	17
		56	17
		64	17
11n HT20	MCS0	52	default
		56	default
		64	default
11n HT40	MCS0	54	default
		62	default





UNII-2C

Mode	Rate	Channel	Soft set value
			ANT 1
11a	6M	100	17
		116	17
		140	17
11n HT20	MCS0	100	default
		116	default
		140	default
11n HT40	MCS0	102	default
		118	default
		134	default

UNII-3

Mode	Rate	Channel	Soft set value
			ANT1
11a	6M	149	17
		157	17
		165	17
11n HT20	MCS0	149	default
		157	default
		165	default
11n HT40	MCS0	151	default
		159	default



## 5.7. THE WORSE CASE CONFIGURATIONS

The EUT was tested in the following configuration(s):

Controlled in test mode using a software application on the EUT supplied by customer. The application was used to enable a continuous transmission and to select the mode, test channels, bandwidth, data rates as required.

Test channels referring to section 5.4.

Maximum power setting referring to section 5.6.

Worst-case data rates as provided by the client were:

802.11a mode: 6 Mbps

802.11n HT20 mode: MCS0

802.11n HT40 mode: MCS0

The measured additional path loss was included in any path loss calculations for all RF cable used during tested.

## 5.8. DESCRIPTION OF TEST SETUP

### SUPPORT EQUIPMENT

Item	Equipment	Brand Name	Model Name	Remarks
1	Earphone	ELIFE	/	/

### I/O CABLES

Cable No	Port	Connector Type	Cable Type	Cable Length(m)	Remarks
/	/	/	/	/	/

### ACCESSORIES

Item	Accessory	Brand Name	Model Name	Description
1	Switching Power Supply	/	BI36-120300-U2	Input: AC100~240V,50/60Hz,1.2A Output: 12Vdc,3A

### TEST SETUP

The EUT can work in engineering mode with a software inside.

### SETUP DIAGRAM FOR TESTS

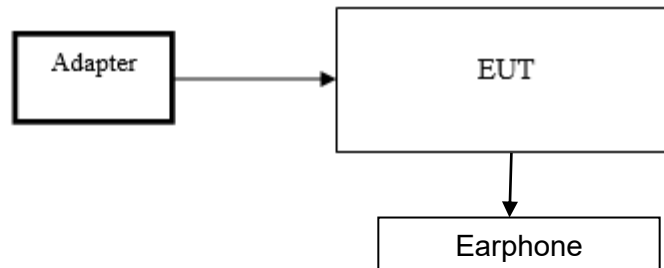

**6. MEASURING INSTRUMENT AND SOFTWARE USED**

Conducted Emissions					
Equipment	Manufacturer	Model No.	Serial No.	Last Cal.	Due Date
EMI Test Receiver	R&S	ESR3	101961	Nov. 12, 2020	Nov. 11, 2021
Two-Line V-Network	R&S	ENV216	101983	Nov. 12, 2020	Nov. 11, 2021
Software					
Description			Manufacturer	Name	Version
Test Software for Conducted Emissions			Farad	EZ-EMC	Ver. UL-3A1

Radiated Emissions					
Equipment	Manufacturer	Model No.	Serial No.	Last Cal.	Due Date
MXE EMI Receiver	KESIGHT	N9038A	MY56400036	Nov. 12, 2020	Nov. 11, 2021
Hybrid Log Periodic Antenna	TDK	HLP-3003C	130960	Aug. 11, 2018	Aug. 10, 2021
Preamplifier	HP	8447D	2944A09099	Nov. 12, 2020	Nov. 11, 2021
EMI Measurement Receiver	R&S	ESR26	101377	Nov. 12, 2020	Nov. 11, 2021
Horn Antenna	TDK	HRN-0118	130939	Sept. 17, 2018	Sept. 17, 2021
Preamplifier	TDK	PA-02-0118	TRS-305-00067	Nov. 20, 2020	Nov. 19, 2021
Horn Antenna	Schwarzbeck	BBHA9170	#691	Aug. 11, 2018	Aug. 11, 2021
Preamplifier	TDK	PA-02-2	TRS-307-00003	Nov. 12, 2020	Nov. 11, 2021
Preamplifier	TDK	PA-02-3	TRS-308-00002	Nov. 12, 2020	Nov. 11, 2021
Loop antenna	Schwarzbeck	1519B	00008	Jan.17, 2019	Jan.17,2022
Preamplifier	TDK	PA-02-001-3000	TRS-302-00050	Nov. 12, 2020	Nov. 11, 2021
Preamplifier	Mini-Circuits	ZX60-83LN-S+	SUP01201941	Nov. 20, 2020	Nov. 19, 2021
Highpass Filter	Wainwright	WHKX10-5850-6500-1800-40SS	4	Nov. 12, 2020	Nov. 11, 2021
Band Reject Filter	Wainwright	WRCJV12-5695-5725-5850-5880-40SS	4	Nov. 12, 2020	Nov. 11, 2021
Band Reject Filter	Wainwright	WRCJV20-5120-5150-5350-5380-	2	Nov. 12, 2020	Nov. 11, 2021



		60SS			
Band Reject Filter	Wainwright	WRCJV20-5440-5470-5725-5755-60SS	1	Nov. 12, 2020	Nov. 11, 2021
<b>Software</b>					
Description		Manufacturer	Name	Version	
Test Software for Radiated Emissions		Farad	EZ-EMC	Ver. UL-3A1	

<b>Tonsend RF Test System</b>					
Equipment	Manufacturer	Model No.	Serial No.	Last Cal.	Due. Date
Wideband Radio Communication Tester	R&S	CMW500	155523	Nov.20,2020	Nov.19,2021
PXA Signal Analyzer	Keysight	N9030A	MY55410512	Nov.20,2020	Nov.19,2021
MXG Vector Signal Generator	Keysight	N5182B	MY56200284	Nov.20,2020	Nov.19,2021
MXG Vector Signal Generator	Keysight	N5172B	MY56200301	Nov.20,2020	Nov.19,2021
DC power supply	Keysight	E3642A	MY55159130	Nov.24,2020	Nov.23,2021
Temperature & Humidity Chamber	SANMOOD	SG-80-CC-2	2088	Nov.20,2020	Nov.19,2021
<b>Software</b>					
Description		Manufacturer	Name	Version	
Tonsend SRD Test System		Tonsend	JS1120-3 RF Test System	2.6.77.0518	

<b>Other Instruments</b>					
Equipment	Manufacturer	Model No.	Serial No.	Last Cal.	Next Cal.
Dual Channel Power Meter	Keysight	N1912A	MY55416024	Nov. 20, 2020	Nov. 19, 2021
Power Sensor	Keysight	USB Wideband Power Sensor	MY5100022	Nov. 20, 2020	Nov. 19, 2021

## 7. ANTENNA PORT TEST RESULTS

### 7.1. ON TIME AND DUTY CYCLE

#### LIMITS

None; for reporting purposes only.

#### PROCEDURE

Refer to KDB 789033 D02 General U-NII Test Procedures New Rules v02r01 section II.B.

The zero-span mode on a spectrum analyzer or EMI receiver, if the response time and spacing between bins on the sweep are sufficient to permit accurate measurements of the on and off times of the transmitted signal. Set the center frequency of the instrument to the center frequency of the transmission. Set  $RBW \geq EBW$  if possible; otherwise, set RBW to the largest available value. Set  $VBW \geq RBW$ . Set detector = peak or average. The zero-span measurement method shall not be used unless both RBW and VBW are  $> 50/T$ , where T is defined in II.B.1.a), and the number of sweep points across duration T exceeds 100. (For example, if VBW and/or RBW are limited to 3 MHz, then the zero-span method of measuring duty cycle shall not be used if  $T \leq 16.7$  microseconds.)

#### TEST SETUP

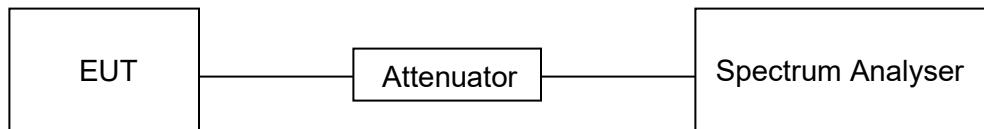

#### TEST ENVIRONMENT

Temperature	25.9 °C	Relative Humidity	66.8 %
Atmosphere Pressure	101 kPa	Test Voltage	AC 120 V,60 Hz

#### RESULTS

Please refer to appendix H.



## 7.2. 6/26 dB EMISSION BANDWIDTH AND 99 % OCCUPIED BANDWIDTH

### LIMITS

CFR 47 FCC Part15, Subpart E ISED RSS-247 ISSUE 2		
Test Item	Limit	Frequency Range (MHz)
26 dB Emission Bandwidth	For reporting purposes only.	5150 ~ 5250
26 dB Emission Bandwidth	For reporting purposes only.	5250 ~ 5350
26 dB Emission Bandwidth	For reporting purposes only.	5470 ~ 5725 (For FCC) 5470 ~ 5600 (For ISED) 5650 ~ 5725 (For ISED)
6 dB Emission Bandwidth	The minimum 6 dB emission bandwidth shall be 500 kHz.	5725 ~ 5850
99 % Occupied Bandwidth	For reporting purposes only.	5150 ~ 5825 (For ISED)

### TEST PROCEDURE

ISED RSS-247 6.2.1.2 clause unwanted emission limits

For transmitters with operating frequencies in the band 5150-5250 MHz, all emissions outside the band 5150-5350 MHz shall not exceed -27 dBm/MHz e.i.r.p. Any unwanted emissions that fall into the band 5250-5350 MHz shall be attenuated below the channel power by at least 26 dB, when measured using a resolution bandwidth between 1 and 5% of the occupied bandwidth (i.e. 99% bandwidth), above 5250 MHz.



**TEST PROCEDURE**

Refer to KDB 789033 D02 General U-NII Test Procedures New Rules v02r01 section II.C1. for 26 dB Emission Bandwidth; section II.C2. for 6 dB Emission Bandwidth; section II.D. for 99 % Occupied Bandwidth.

Connect the EUT to the spectrum analyser and use the following settings:

Center Frequency	The center frequency of the channel under test
Detector	Peak
RBW	For 6 dB Emission Bandwidth: RBW=100 kHz For 26 dB Emission bandwidth: approximately 1 % ~ 5 % of the OBW For 99 % Occupied Bandwidth: approximately 1 % ~ 5 % of the OBW.
VBW	For 6 dB Bandwidth: $\geq 3 \cdot \text{RBW}$ For 26 dB Bandwidth $> \text{RBW}$ For 99 % Bandwidth: $> 3 \cdot \text{RBW}$
Trace	Max hold
Sweep	Auto couple

- a) Use the 99 % power bandwidth function of the instrument, allow the trace to stabilize and report the measured bandwidth.
- b) Allow the trace to stabilize and measure the maximum width of the emission that is constrained by the frequencies associated with the two outermost amplitude points (upper and lower frequencies) that are attenuated by 6/26 dB relative to the maximum level measured in the fundamental emission.



**Calculation for 99 % Bandwidth of UNII-2C and UNII-3 Straddle Channel:**

For Example: Fundamental Frequency: 5720 MHz

99 % OBW: 21.00 MHz

Turning Frequency: 5725 MHz

99 % Bandwidth of UNII-2C Band Portion =  $(5725 - (5720 - (21.00/2))) = 15.50$  MHz99 % Bandwidth of UNII-3 Band Portion =  $(5720 + (21.00/2) - 5725) = 5.50$  MHz**Calculation for 26 dB Bandwidth of UNII-2C Straddle Channel:**

For Example: Fundamental frequency: 5720 MHz

26 dB BW: 20.00 MHz

FL: 5710.16 MHz

FH: 5730.16 MHz

Turning Frequency: 5725 MHz

26 dB Bandwidth of UNII-2C Band Portion =  $5725 - 5710.16 = 14.84$  MHz**Calculation for 6dB Bandwidth of UNII-3 Straddle Channel:**

For Example: Fundamental frequency: 5720 MHz

6 dB BW: 16.44 MHz

FL: 5711.76 MHz

FH: 5728.2 MHz

Turning Frequency: 5725 MHz

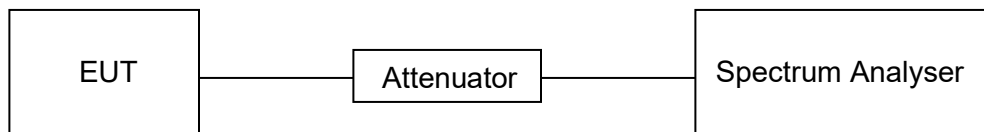
6 dB Bandwidth of UNII-3 band Portion =  $5728.2 - 5725 = 3.2$  MHz**TEST SETUP****TEST ENVIRONMENT**

Temperature	25.9 °C	Relative Humidity	66.8 %
Atmosphere Pressure	101 kPa	Test Voltage	AC 120 V,60 Hz

**RESULTS**

Please refer to Appendix A1&amp;A2&amp;A3.



### 7.3. CONDUCTED OUTPUT POWER

**LIMITS**

CFR 47 FCC Part15, Subpart E		
Test Item	Limit	Frequency Range (MHz)
Conducted Output Power	<input type="checkbox"/> Outdoor Access Point: 1 W (30 dBm) <input type="checkbox"/> Indoor Access Point: 1 W (30 dBm) <input type="checkbox"/> Fixed Point-To-Point Access Points: 1 W (30 dBm) <input checked="" type="checkbox"/> Client Devices: 250 mW (24 dBm)	5150 ~ 5250
	Shall not exceed the lesser of 250 mW (24dBm) or 11 dBm + 10 log B, where B is the 26 dB emission bandwidth in megahertz.	5250 ~ 5350 5470 ~ 5725
	Shall not exceed 1 Watt (30 dBm).	5725 ~ 5850

ISED RSS-247 ISSUE 2		
Test Item	Limit	Frequency Range (MHz)
Conducted Output Power or e.i.r.p.	The maximum e.i.r.p. shall not exceed 200 mW (23 dBm) or 10 + 10 log <sub>10</sub> B, dBm, whichever power is less. B is the 99 % emission bandwidth in megahertz.	5150 ~ 5250
	a. The maximum conducted output power shall not exceed 250 mW (24 dBm) or 11 + 10 log <sub>10</sub> B dBm, whichever is less. b. The maximum e.i.r.p. shall not exceed 1.0 W (30 dBm) or 17 + 10 log <sub>10</sub> B dBm, whichever is less. B is the 99 % emission bandwidth in megahertz. Note that devices with a maximum e.i.r.p. greater than 500 mW shall implement TPC in order to have the capability to operate at least 6 dB below the maximum permitted e.i.r.p. of 1 W.	5250 ~ 5350 5470 ~ 5600 5650 ~ 5725
	Shall not exceed 1 Watt (30 dBm).	5725 ~ 5850

**Note:**

The above limits are based upon the maximum antenna gain does not exceed 6 dBi. If transmitting antennas of directional gain greater than 6 dBi are used, the maximum conducted output power shall be reduced by the amount in dB that the directional gain of the antenna exceeds 6 dBi.

## **TEST PROCEDURE**

Refer to KDB 789033 D02 General U-NII Test Procedures New Rules v02r01 section II.E.

### **Method SA-1 (trace averaging with the EUT transmitting at full power throughout each sweep):**

- (i) Set span to encompass the entire emission bandwidth (EBW) (or, alternatively, the entire 99% occupied bandwidth) of the signal.
- (ii) Set RBW = 1 MHz.
- (iii) Set VBW  $\geq$  3 MHz.
- (iv) Number of points in sweep  $\geq 2 \times$  span / RBW. (This ensures that bin-to-bin spacing is  $\leq$  RBW/2, so that narrowband signals are not lost between frequency bins.)
- (v) Sweep time = auto.
- (vi) Detector = power averaging (rms), if available. Otherwise, use sample detector mode.
- (vii) If transmit duty cycle  $<$  98 %, use a video trigger with the trigger level set to enable triggering only on full power pulses. Transmitter must operate at maximum power control level for the entire duration of every sweep. If the EUT transmits continuously (i.e., with no off intervals) or at duty cycle  $\geq$  98 %, and if each transmission is entirely at the maximum power control level, then the trigger shall be set to “free run.”
- (viii) Trace average at least 100 traces in power averaging (rms) mode.
- (ix) Compute power by integrating the spectrum across the EBW (or, alternatively, the entire 99% occupied bandwidth) of the signal using the instrument’s band power measurement function with band limits set equal to the EBW (or occupied bandwidth) band edges. If the instrument does not have a band power function, sum the spectrum levels (in power units) at 1 MHz intervals extending across the EBW (or, alternatively, the entire 99% occupied bandwidth) of the spectrum.

### **Method PM (Measurement using an RF average power meter):**

- (i) Measurements may be performed using a wideband RF power meter with a thermocouple detector or equivalent if all of the following conditions are satisfied:
  - a. The EUT is configured to transmit continuously or to transmit with a constant duty cycle.
  - b. At all times when the EUT is transmitting, it must be transmitting at its maximum power control level.
  - c. The integration period of the power meter exceeds the repetition period of the transmitted signal by at least a factor of five.
- (ii) If the transmitter does not transmit continuously, measure the duty cycle,  $x$ , of the transmitter output signal as described in II.B.
- (iii) Measure the average power of the transmitter. This measurement is an average over both the on and off periods of the transmitter.
- (iv) Adjust the measurement in dBm by adding  $10 \log (1/x)$  where  $x$  is the duty cycle (e.g.,  $10 \log (1/0.25)$  if the duty cycle is 25 %).

### **Method PM-G (Measurement using a gated RF average power meter):**

Measurements may be performed using a wideband gated RF power meter provided that the gate parameters are adjusted such that the power is measured only when the EUT is transmitting at its maximum power control level. Since the measurement is made only during the ON time of the transmitter, no duty cycle correction factor is required.

Straddle channel power was measured using spectrum analyzer.

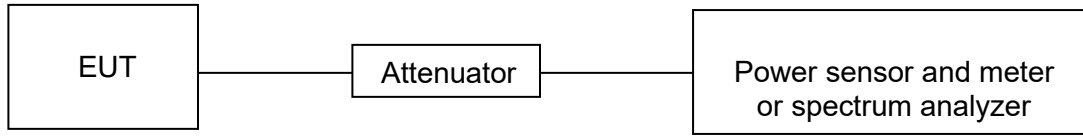
**TEST SETUP****TEST ENVIRONMENT**

Temperature	25.9 °C	Relative Humidity	66.8 %
Atmosphere Pressure	101 kPa	Test Voltage	AC 120 V,60 Hz

**RESULTS**

Please refer to appendix B.



## 7.4. POWER SPECTRAL DENSITY

### LIMITS

CFR 47 FCC Part15, Subpart E		
Test Item	Limit	Frequency Range (MHz)
Power Spectral Density	<input type="checkbox"/> Outdoor Access Point: 17 dBm/MHz <input type="checkbox"/> Indoor Access Point: 17 dBm/MHz <input type="checkbox"/> Fixed Point-To-Point Access Points: 17 dBm/MHz <input checked="" type="checkbox"/> Client Devices: 11 dBm/MHz	5150 ~ 5250
	11 dBm/MHz	5250 ~ 5350 5470 ~ 5725
	30 dBm/500kHz	5725 ~ 5850

ISED RSS-247 ISSUE 2		
Test Item	Limit	Frequency Range (MHz)
Power Spectral Density	The e.i.r.p. spectral density shall not exceed 10 dBm in any 1.0 MHz band.	5150 ~ 5250
	The power spectral density shall not exceed 11 dBm in any 1.0 MHz band.	5250 ~ 5350 5470 ~ 5600 5650 ~ 5725
	30 dBm / 500 kHz	5725 ~ 5850

**Note:**

The above limits are based upon the maximum antenna gain does not exceed 6 dBi. If transmitting antennas of directional gain greater than 6 dBi are used, maximum power spectral density shall be reduced by the amount in dB that the directional gain of the antenna exceeds 6 dBi.

### TEST PROCEDURE

Refer to KDB 789033 D02 General U-NII Test Procedures New Rules v02r01 section II.F.

Connect the EUT to the spectrum analyser and use the following settings:

For U-NII-1, U-NII-2A and U-NII-2C band:

Center Frequency	The center frequency of the channel under test
Detector	RMS
RBW	1 MHz
VBW	$\geq 3 \times \text{RBW}$
Span	Encompass the entire emissions bandwidth (EBW) of the signal
Trace	Max hold
Sweep time	Auto

For U-NII-3:

Center Frequency	The center frequency of the channel under test
Detector	RMS
RBW	500 kHz
VBW	$\geq 3 \times \text{RBW}$
Span	Encompass the entire emissions bandwidth (EBW) of the signal
Trace	Max hold
Sweep time	Auto

Allow trace to fully stabilize and Use the peak search function on the instrument to find the peak of the spectrum and record its value.

Add  $10 \log(1/x)$ , where  $x$  is the duty cycle, to the peak of the spectrum, the result is the Maximum PSD over 1 MHz / 500 kHz reference bandwidth.

## TEST SETUP

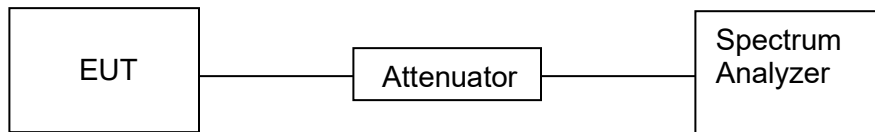

## TEST ENVIRONMENT

Temperature	25.9 °C	Relative Humidity	66.8 %
Atmosphere Pressure	101 kPa	Test Voltage	AC 120 V,60 Hz

## RESULTS

Please refer to Appendix C.



## 8. RADIATED TEST RESULTS

### LIMITS

Refer to CFR 47 FCC §15.205, §15.209 and §15.407 (b).

Refer to ISED RSS-GEN Clause 8.9, Clause 8.10 and ISED RSS-247 6.2.

Radiation Disturbance Test Limit for FCC (Class B) (9 kHz ~ 1 GHz)

Emissions radiated outside of the specified frequency bands above 30 MHz			
Frequency Range (MHz)	Field Strength Limit (uV/m) at 3 m	Field Strength Limit (dBuV/m) at 3 m	
		Quasi-Peak	
30 - 88	100	40	
88 - 216	150	43.5	
216 - 960	200	46	
Above 960	500	54	
Above 1000	500	Peak	Average
		74	54

FCC Emissions radiated outside of the specified frequency bands below 30 MHz		
Frequency (MHz)	Field strength (microvolts/meter)	Measurement distance (meters)
0.009-0.490	2400/F(kHz)	300
0.490-1.705	24000/F(kHz)	30
1.705-30.0	30	30



FCC Restricted bands of operation refer to FCC §15.205 (a):

MHz	MHz	MHz	GHz
0.090-0.110	16.42-16.423	399.9-410	4.5-5.15
<sup>1</sup> 0.495-0.505	16.69475-16.69525	608-614	5.35-5.46
2.1735-2.1905	16.80425-16.80475	960-1240	7.25-7.75
4.125-4.128	25.5-25.67	1300-1427	8.025-8.5
4.17725-4.17775	37.5-38.25	1435-1626.5	9.0-9.2
4.20725-4.20775	73-74.6	1645.5-1646.5	9.3-9.5
6.215-6.218	74.8-75.2	1660-1710	10.6-12.7
6.26775-6.26825	108-121.94	1718.8-1722.2	13.25-13.4
6.31175-6.31225	123-138	2200-2300	14.47-14.5
8.291-8.294	149.9-150.05	2310-2390	15.35-16.2
8.362-8.366	156.52475-156.52525	2483.5-2500	17.7-21.4
8.37625-8.38675	156.7-156.9	2690-2900	22.01-23.12
8.41425-8.41475	162.0125-167.17	3260-3267	23.6-24.0
12.29-12.293	167.72-173.2	3332-3339	31.2-31.8
12.51975-12.52025	240-285	3345.8-3358	36.43-36.5
12.57675-12.57725	322-335.4	3600-4400	( <sup>2</sup> )
13.36-13.41			

Note: <sup>1</sup>Until February 1, 1999, this restricted band shall be 0.490-0.510 MHz.

<sup>2</sup>Above 38.6c

Limits of unwanted/undesirable emission out of the restricted bands refer to CFR 47 FCC §15.407 (b).

LIMITS OF RADIATED EMISSION MEASUREMENT (Above 1GHz)		
Frequency Range (MHz)	EIRP Limit	Field Strength Limit (dBuV/m) at 3 m
5150~5250 MHz	PK: -27 (dBm/MHz)	PK:68.2(dBμV/m)
5250~5350 MHz		
5470~5725 MHz		
5725~5850 MHz	PK: -27 (dBm/MHz) *1 PK: 10 (dBm/MHz) *2 PK: 15.6 (dBm/MHz) *3 PK: 27 (dBm/MHz) *4	PK: 68.2(dBμV/m) *1 PK: 105.2 (dBμV/m) *2 PK: 110.8(dBμV/m) *3 PK: 122.2 (dBμV/m) *4

Note:

\*1 beyond 75 MHz or more above of the band edge.

\*2 below the band edge increasing linearly to 10 dBm/MHz at 25 MHz above.

\*3 below the band edge increasing linearly to a level of 15.6 dBm/MHz at 5 MHz above.

\*4 from 5 MHz above or below the band edge increasing linearly to a level of 27 dBm/MHz at the band edge.



**TEST SETUP AND PROCEDURE**

Below 30 MHz

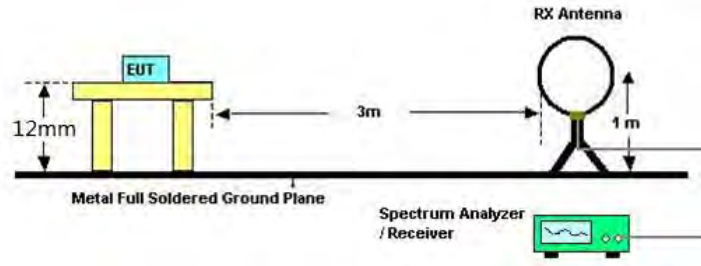

The setting of the spectrum analyser

RBW	200 Hz (From 9 kHz to 0.15 MHz)/ 9 kHz (From 0.15 MHz to 30 MHz)
VBW	200 Hz (From 9 kHz to 0.15 MHz)/ 9 kHz (From 0.15 MHz to 30 MHz)
Sweep	Auto
Trace	Max hold

1. The testing follows the guidelines in ANSI C63.10-2013 clause 6.4.
2. The EUT was arranged to its worst case and then turntable (from 0 degree to 360 degrees) to find the maximum reading. A pre-amp and a high pass filter are used for the test in order to get better signal level. Both Horizontal, Face-on and Face-off polarizations of the antenna are set to make the measurement.
3. The EUT was placed on a turntable with 12 mm above ground.
4. The EUT was set 3 meters from the interference receiving antenna, which was mounted on the top of a 1 m height antenna tower.
5. The radiated emission limits are based on measurements employing a CISPR quasi-peak detector except for the frequency bands 9-90 kHz, 110-490 kHz and above 1000 MHz Radiated emission limits in these three bands are based on measurements employing an average detector.
6. For measurement below 1 GHz, the initial step in collecting conducted emission data is a spectrum analyzer peak detector mode pre-scanning the measurement frequency range. Significant peaks are then marked and then Quasi Peak and average detector mode re-measured. If the emission level of the EUT measured by the peak detector is 3 dB lower than the applicable limit, the peak emission level will be reported. Otherwise, the emission measurement will be repeated using the quasi-peak and average detector and reported.
7. Although these tests were performed other than open field site, adequate comparison measurements were confirmed against 30m open field site. Therefore sufficient tests were made to demonstrate that the alternative site produces results that correlate with the ones of tests made in an open field site based on KDB 414788.
8. The limits in CFR 47, Part 15, Subpart C, paragraph 15.209 (a), are identical to those in RSS-GEN Section 8.9, Table 6, since the measurements are performed in terms of magnetic field strength and converted to electric field strength levels (as reported in the table) using the free space impedance of  $377\Omega$ . For example, the measurement frequency X KHz resulted in a level of Y dBuV/m, which is equivalent to  $Y-51.5 = Z$  dBuA/m, which has the same margin, W dB, to the corresponding RSS-GEN Table 6 limit as it has to be 15.209(a) limit.

Below 1 GHz and above 30 MHz

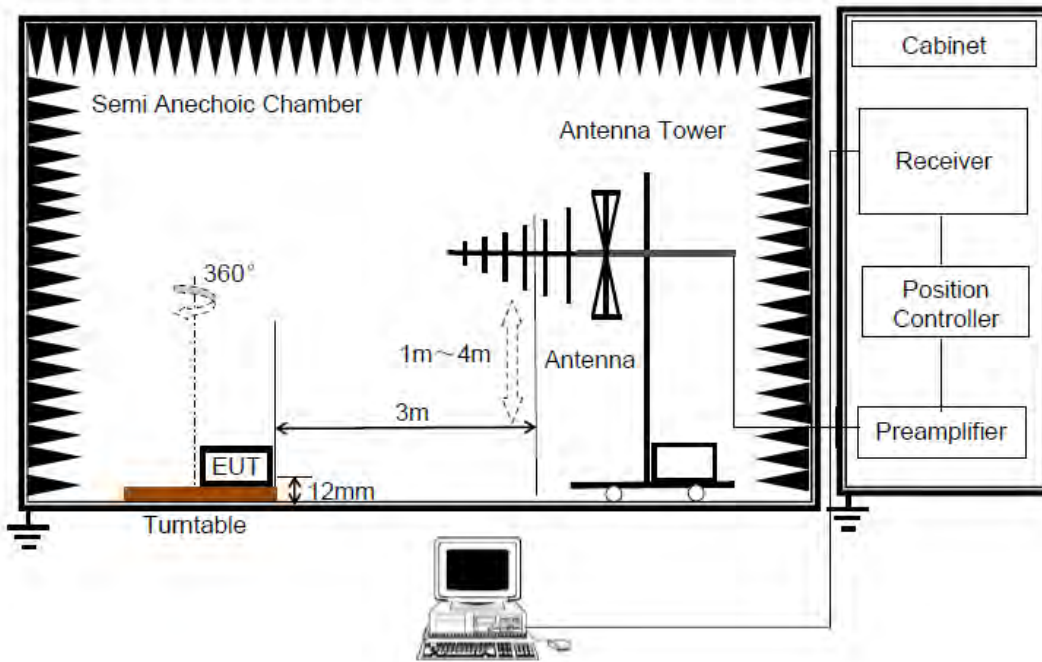

The setting of the spectrum analyser

RBW	120 kHz
VBW	300 kHz
Sweep	Auto
Detector	Peak/QP
Trace	Max hold

1. The testing follows the guidelines in ANSI C63.10-2013 clause 6.5.
2. The EUT was arranged to its worst case and then tune the antenna tower (from 1 m to 4 m) and turntable (from 0 degree to 360 degrees) to find the maximum reading. A pre-amp and a high pass filter are used for the test in order to get better signal level. Both horizontal and vertical polarizations of the antenna are set to make the measurement.
3. The EUT was placed on a turntable with 12 mm above ground.
4. The EUT was set 3 meters from the interference receiving antenna, which was mounted on the top of a variable height antenna tower.
5. For measurement below 1 GHz, the initial step in collecting conducted emission data is a spectrum analyzer peak detector mode pre-scanning the measurement frequency range. Significant peaks are then marked and then Quasi Peak detector mode re-measured. If the emission level of the EUT measured by the peak detector is 3 dB lower than the applicable limit, the peak emission level will be reported. Otherwise, the emission measurement will be repeated using the quasi-peak detector and reported.

Above 1 GHz

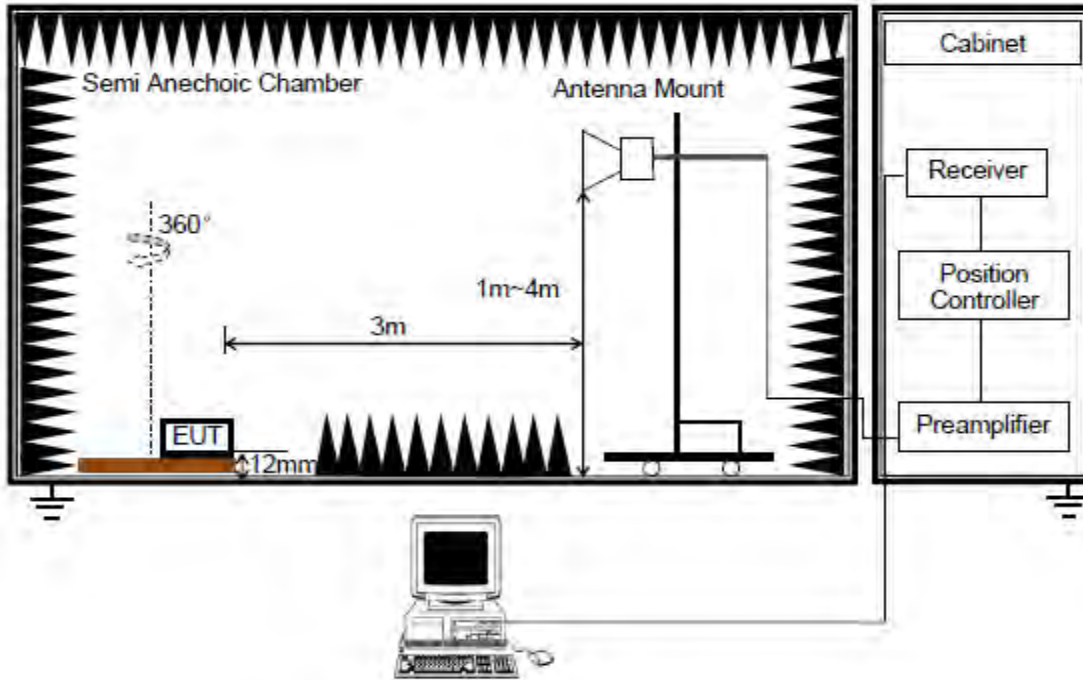

The setting of the spectrum analyser

RBW	1 MHz
VBW	PEAK: 3 MHz AVG: see note 6
Sweep	Auto
Detector	Peak
Trace	Max hold

1. The testing follows the guidelines in ANSI C63.10-2013 clause 6.6.
2. The EUT was arranged to its worst case and then tune the antenna tower (from 1 m to 4 m) and turntable (from 0 degree to 360 degrees) to find the maximum reading. A pre-amp and a high pass filter are used for the test in order to get better signal level. Both horizontal and vertical polarizations of the antenna are set to make the measurement.
3. The EUT was placed on a turntable with 12 mm above ground.
4. The EUT was set 3 meters from the interference receiving antenna, which was mounted on the top of a variable height antenna tower.
5. For measurement above 1 GHz, the emission measurement will be measured by the peak detector. This peak level, once corrected, must comply with the limit specified in Section 15.209.
6. For measurements above 1 GHz the resolution bandwidth is set to 1 MHz, then the video bandwidth is set to 3 MHz for peak measurements and 1 MHz resolution bandwidth with 1/T video bandwidth with peak detector for average measurements. For the Duty Cycle please refer to clause 7.1. ON TIME AND DUTY CYCLE.

X axis, Y axis, Z axis positions:

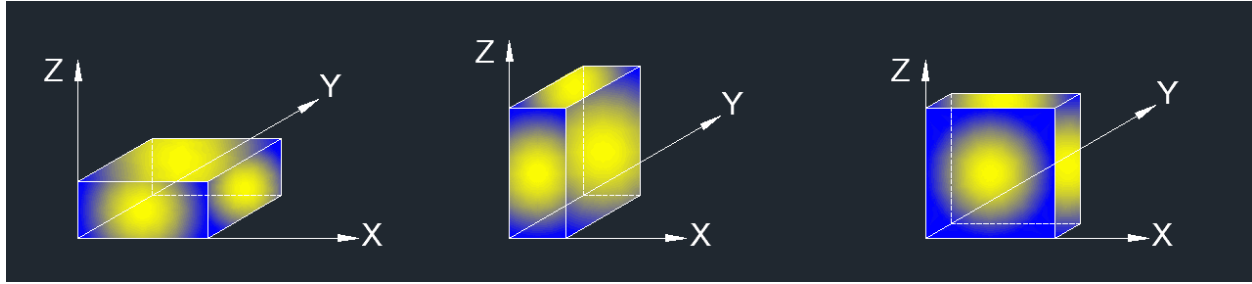

Note: The manufacturer has recommended that the EUT only be used in the Floor-standing orientation; therefore, all radiated testing was performed in the orientation. The EUT was placed on normal orientation and all radiated emissions were performed with the EUT shown on the setup photo.

**TEST ENVIRONMENT**

Temperature	25.4 °C	Relative Humidity	62.3 %
Atmosphere Pressure	101 kPa	Test Voltage	AC 120 V,60 Hz

**RESULTS**



## 8.1. RESTRICTED BANDEGE

### 8.1.1. 802.11a MODE

#### UNII-1 BAND

#### RESTRICTED BANDEGE (LOW CHANNEL, Vertical)

#### PEAK

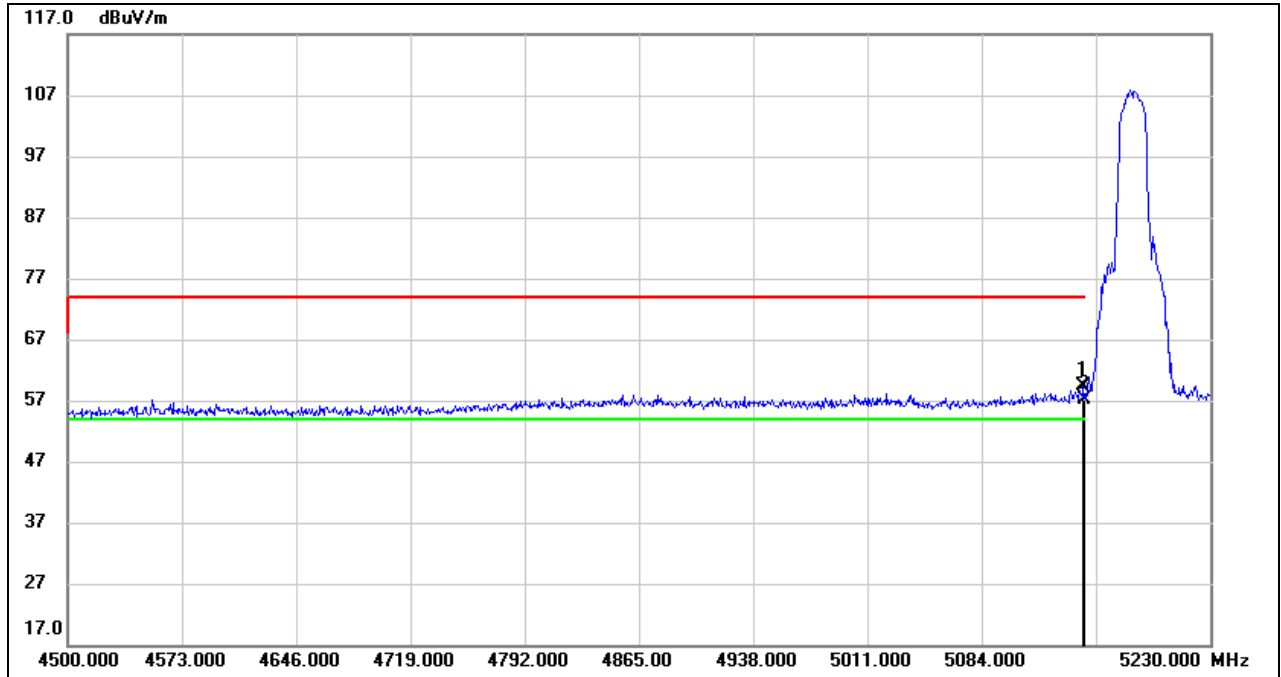

No.	Frequency (MHz)	Reading (dBuV)	Correct (dB/m)	Result (dBuV/m)	Limit (dBuV/m)	Margin (dB)	Remark
1	5148.970	18.26	41.18	59.44	74.00	-14.56	peak
2	5150.000	16.02	41.19	57.21	74.00	-16.79	peak

- Note: 1. Measurement = Reading Level + Correct Factor.  
 2. If Peak Result complies with AV limit, AV Result is deemed to comply with AV limit.  
 3. Peak: Peak detector.  
 4. Only the worst data was recorded, if it complies with the limit, the other emissions deemed to comply with the limit.



**AVG**

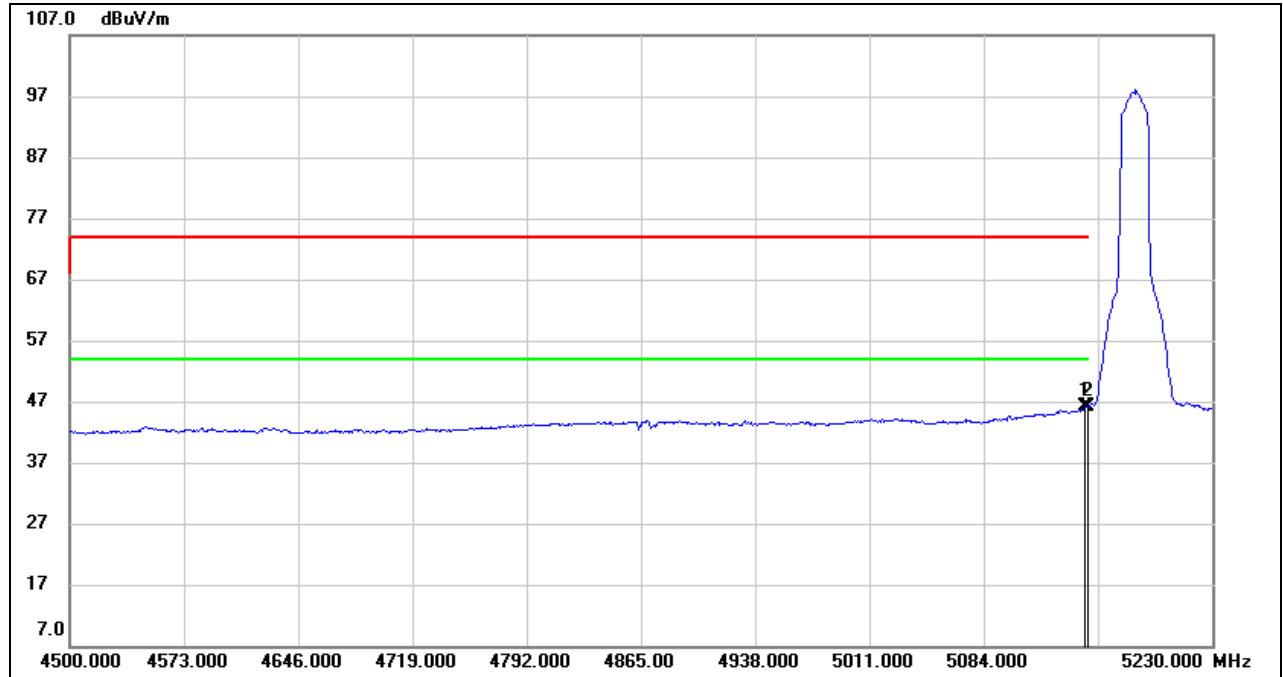

No.	Frequency (MHz)	Reading (dBuV)	Correct (dB/m)	Result (dBuV/m)	Limit (dBuV/m)	Margin (dB)	Remark
1	5148.970	4.86	41.18	46.04	54.00	-7.96	AVG
2	5150.000	4.95	41.19	46.14	54.00	-7.86	AVG

- Note:
1. Measurement = Reading Level + Correct Factor.
  2. If Peak Result complies with AV limit, AV Result is deemed to comply with AV limit.
  3. AVG:  $VBW=1/Ton$ , where: Ton is the transmitting duration.
  4. For the transmitting duration, please refer to clause 7.1.
  5. Only the worst data was recorded, if it complies with the limit, the other emissions deemed to comply with the limit.



**UNII-2A BAND**

**RESTRICTED BANDEDGE (HIGH CHANNEL, Vertical)**

**PEAK**

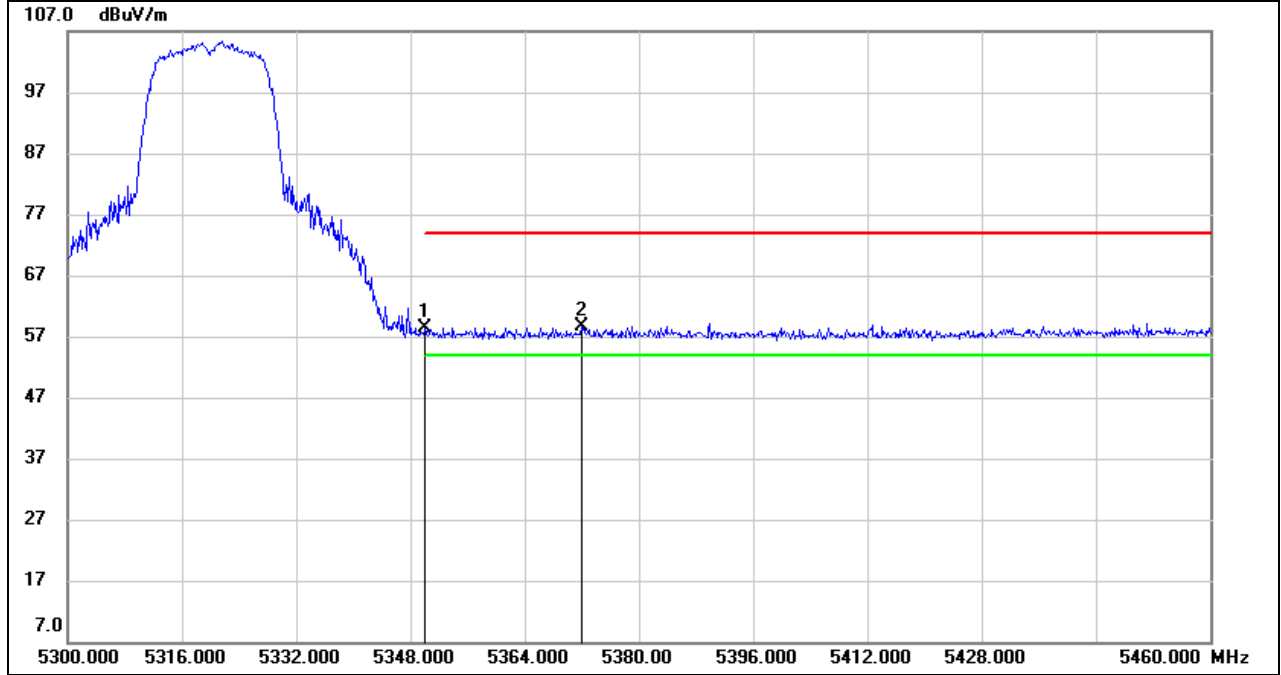

No.	Frequency (MHz)	Reading (dBuV)	Correct (dB/m)	Result (dBuV/m)	Limit (dBuV/m)	Margin (dB)	Remark
1	5350.000	17.19	41.20	58.39	74.00	-15.61	peak
2	5372.000	17.19	41.33	58.52	74.00	-15.48	peak

Note: 1. Measurement = Reading Level + Correct Factor.  
 2. If Peak Result complies with AV limit, AV Result is deemed to comply with AV limit.  
 3. Peak: Peak detector.  
 4. Only the worst data was recorded, if it complies with the limit, the other emissions deemed to comply with the limit.

**AVG**

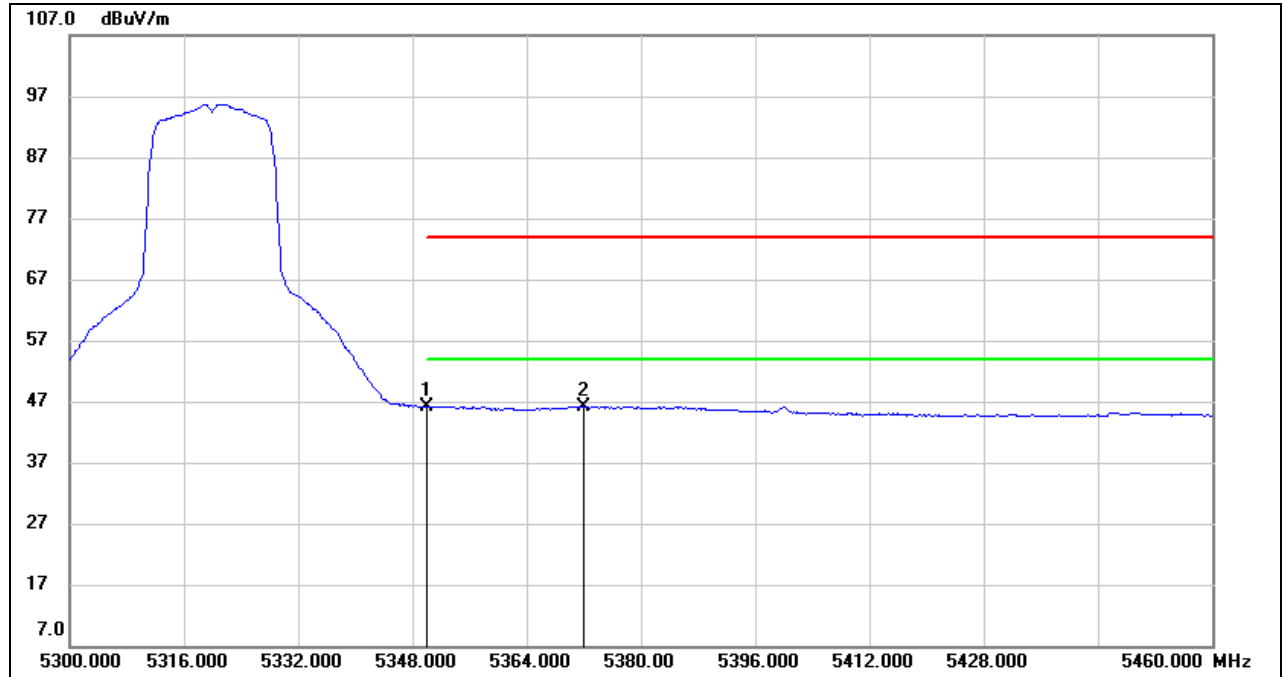

No.	Frequency (MHz)	Reading (dBuV)	Correct (dB/m)	Result (dBuV/m)	Limit (dBuV/m)	Margin (dB)	Remark
1	5350.000	4.90	41.20	46.10	54.00	-7.90	AVG
2	5372.000	4.91	41.33	46.24	54.00	-7.76	AVG

- Note:
1. Measurement = Reading Level + Correct Factor.
  2. If Peak Result complies with AV limit, AV Result is deemed to comply with AV limit.
  3. AVG:  $VBW=1/Ton$ , where: Ton is the transmitting duration.
  4. For the transmitting duration, please refer to clause 7.1.
  5. Only the worst data was recorded, if it complies with the limit, the other emissions deemed to comply with the limit.





**UNII-2C BAND**

**RESTRICTED BANDEGE (LOW CHANNEL, Vertical)**

**PEAK**

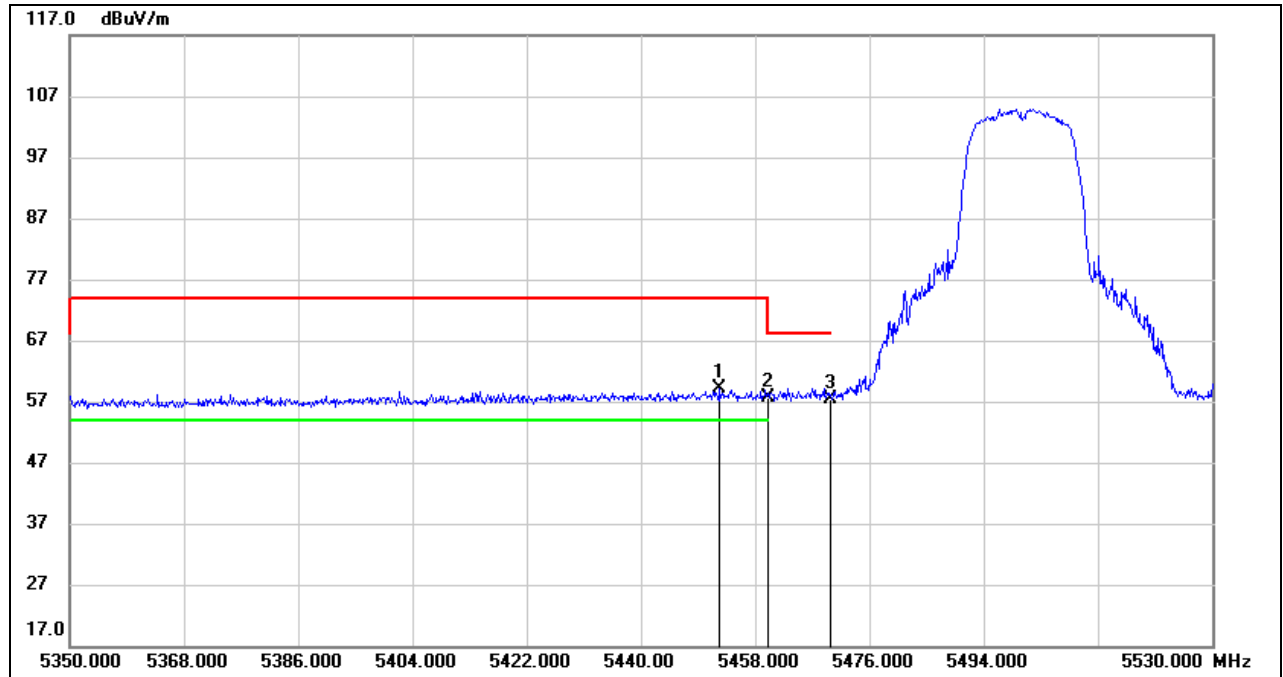

No.	Frequency (MHz)	Reading (dBuV)	Correct (dB/m)	Result (dBuV/m)	Limit (dBuV/m)	Margin (dB)	Remark
1	5452.420	17.37	41.78	59.15	74.00	-14.85	peak
2	5460.000	15.69	41.82	57.51	68.20	-10.69	peak
3	5470.000	15.50	41.87	57.37	68.20	-10.83	peak

- Note: 1. Measurement = Reading Level + Correct Factor.  
 2. If Peak Result complies with AV limit, AV Result is deemed to comply with AV limit.  
 3. Peak: Peak detector.  
 4. Only the worst data was recorded, if it complies with the limit, the other emissions deemed to comply with the limit.

**AVG**

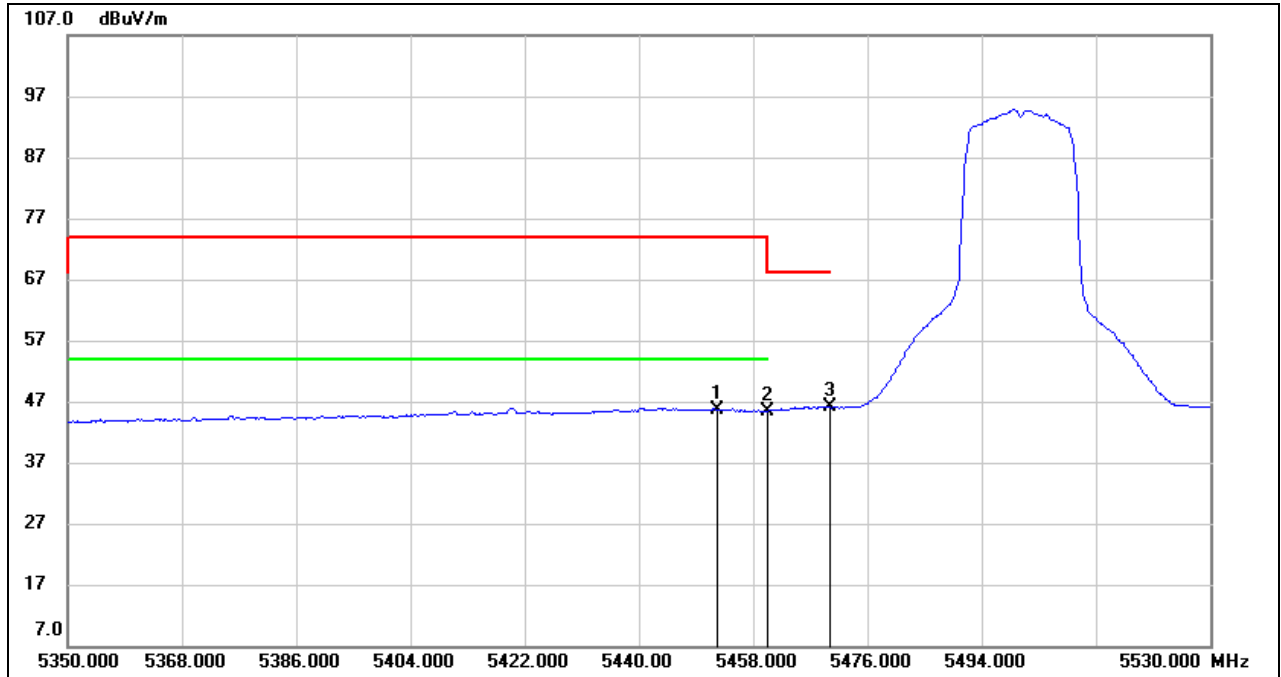

No.	Frequency (MHz)	Reading (dBuV)	Correct (dB/m)	Result (dBuV/m)	Limit (dBuV/m)	Margin (dB)	Remark
1	5452.420	3.84	41.78	45.62	54.00	-8.38	AVG
2	5460.000	3.67	41.82	45.49	54.00	-8.51	AVG
3	5470.000	4.34	41.87	46.21	/	/	AVG

- Note: 1. Measurement = Reading Level + Correct Factor.  
 2. If Peak Result complies with AV limit, AV Result is deemed to comply with AV limit.  
 3. AVG:  $VBW=1/Ton$ , where: Ton is the transmitting duration.  
 4. For the transmitting duration, please refer to clause 7.1.  
 5. Only the worst data was recorded, if it complies with the limit, the other emissions deemed to comply with the limit.



**RESTRICTED BANDEDGE (HIGH CHANNEL, Vertical)**

**PEAK**

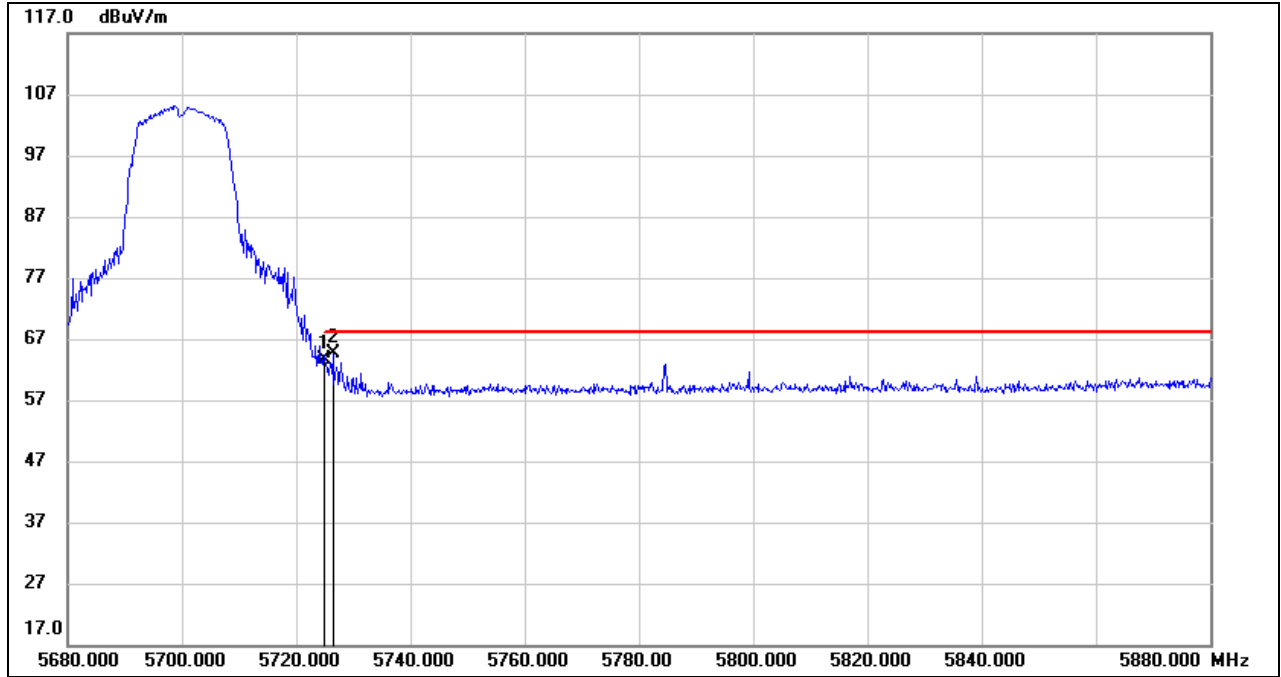

No.	Frequency (MHz)	Reading (dBuV)	Correct (dB/m)	Result (dBuV/m)	Limit (dBuV/m)	Margin (dB)	Remark
1	5725.000	21.99	41.67	63.66	68.20	-4.54	peak
2	5726.400	22.98	41.67	64.65	68.20	-3.55	peak

- Note:
1. Measurement = Reading Level + Correct Factor.
  2. If Peak Result complies with AV limit, AV Result is deemed to comply with AV limit.
  3. Peak: Peak detector.
  4. Only the worst data was recorded, if it complies with the limit, the other emissions deemed to comply with the limit.

**UNII-3 BAND**

**RESTRICTED BANDEDGE (LOW CHANNEL, Vertical)**

**PEAK**

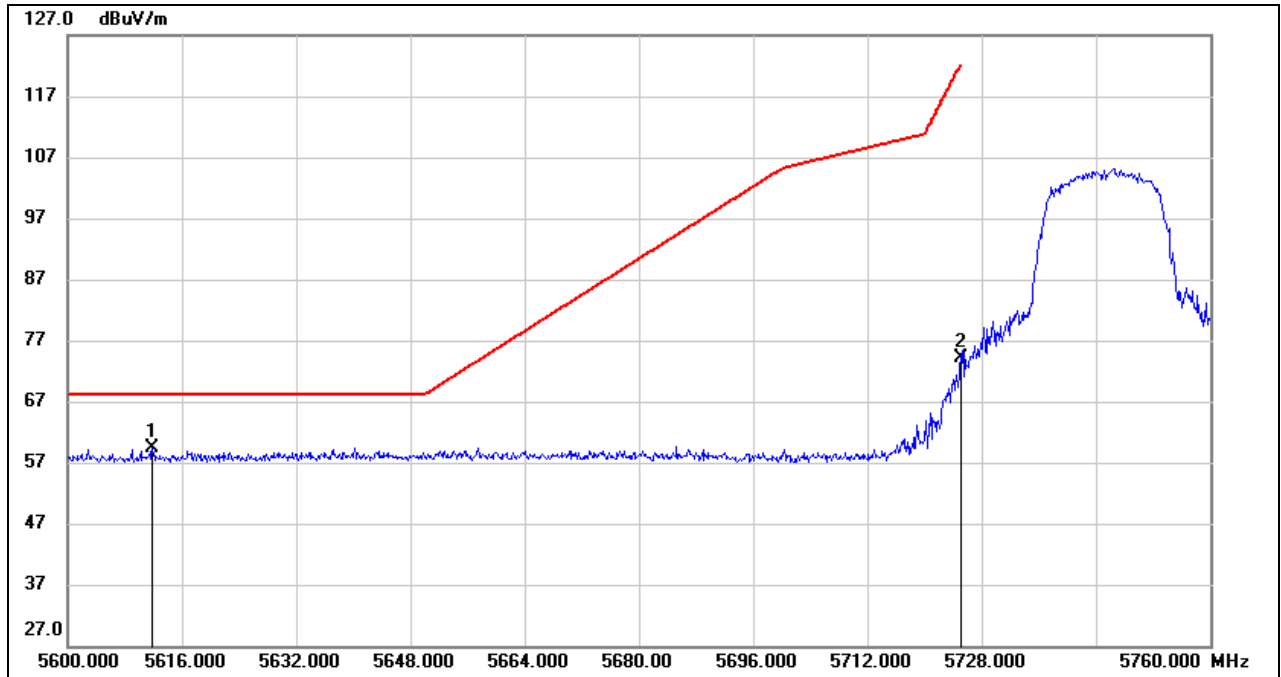

No.	Frequency (MHz)	Reading (dBuV)	Correct (dB/m)	Result (dBuV/m)	Limit (dBuV/m)	Margin (dB)	Remark
1	5611.840	17.75	41.70	59.45	68.20	-8.75	peak
2	5725.000	32.56	41.67	74.23	122.20	-47.97	peak

- Note:
1. Measurement = Reading Level + Correct Factor.
  2. If Peak Result complies with AV limit, AV Result is deemed to comply with AV limit.
  3. Peak: Peak detector.
  4. Only the worst data was recorded, if it complies with the limit, the other emissions deemed to comply with the limit.

**RESTRICTED BANDEDGE (HIGH CHANNEL, Vertical)**

**PEAK**

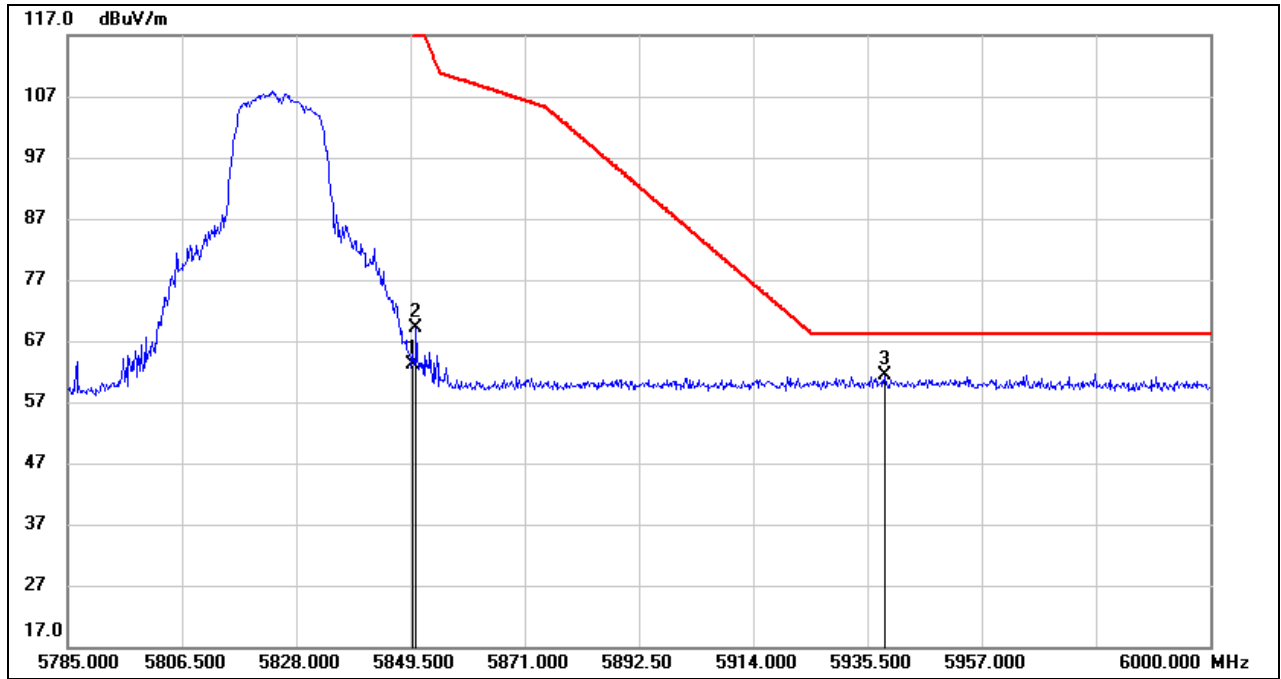

No.	Frequency (MHz)	Reading (dBuV)	Correct (dB/m)	Result (dBuV/m)	Limit (dBuV/m)	Margin (dB)	Remark
1	5850.000	20.55	42.52	63.07	122.20	-59.13	peak
2	5850.575	26.61	42.53	69.14	120.89	-51.75	peak
3	5938.725	18.59	42.85	61.44	68.20	-6.76	peak

Note: 1. Measurement = Reading Level + Correct Factor.  
 2. If Peak Result complies with AV limit, AV Result is deemed to comply with AV limit.  
 3. Peak: Peak detector.  
 4. Only the worst data was recorded, if it complies with the limit, the other emissions deemed to comply with the limit.

Note: Both horizontal and vertical had been tested, but only the worst data was recorded in the report.



8.1.2. 802.11n HT20 MODE

UNII-1 BAND

RESTRICTED BANDEGE (LOW CHANNEL, Vertical)

PEAK

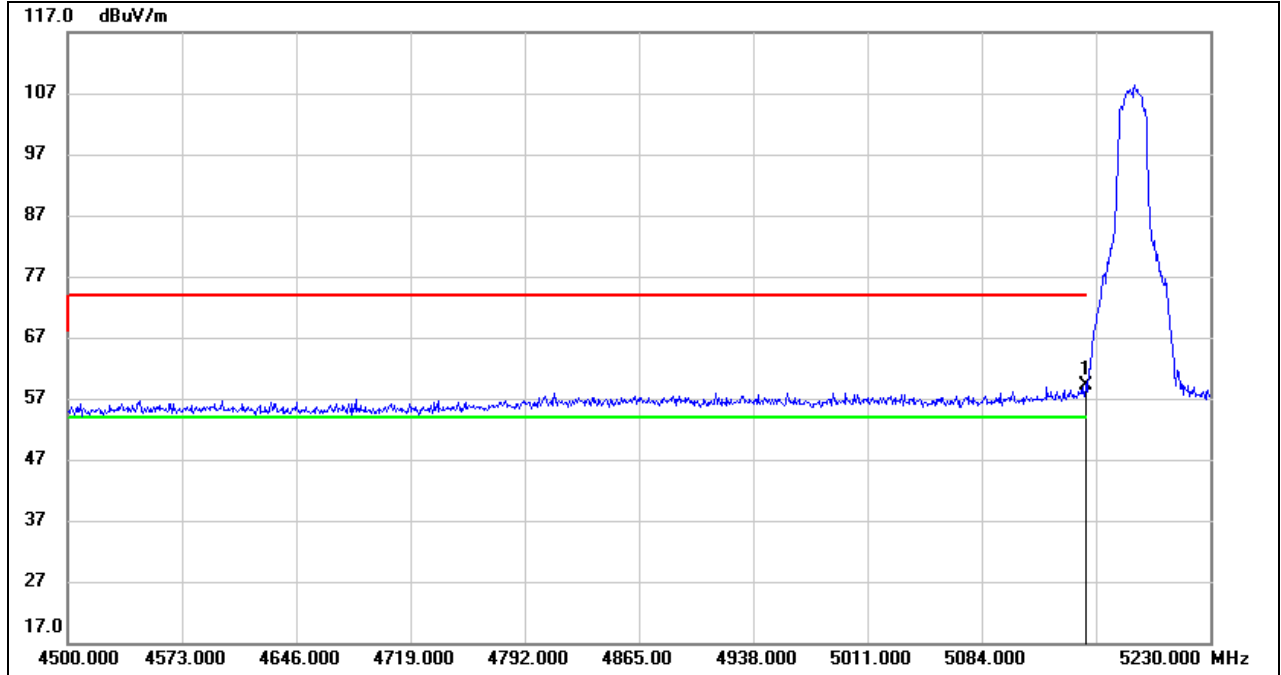

No.	Frequency (MHz)	Reading (dBuV)	Correct (dB/m)	Result (dBuV/m)	Limit (dBuV/m)	Margin (dB)	Remark
1	5150.000	17.94	41.19	59.13	74.00	-14.87	peak

- Note:
1. Measurement = Reading Level + Correct Factor.
  2. If Peak Result complies with AV limit, AV Result is deemed to comply with AV limit.
  3. Peak: Peak detector.
  4. Only the worst data was recorded, if it complies with the limit, the other emissions deemed to comply with the limit.



**AVG**

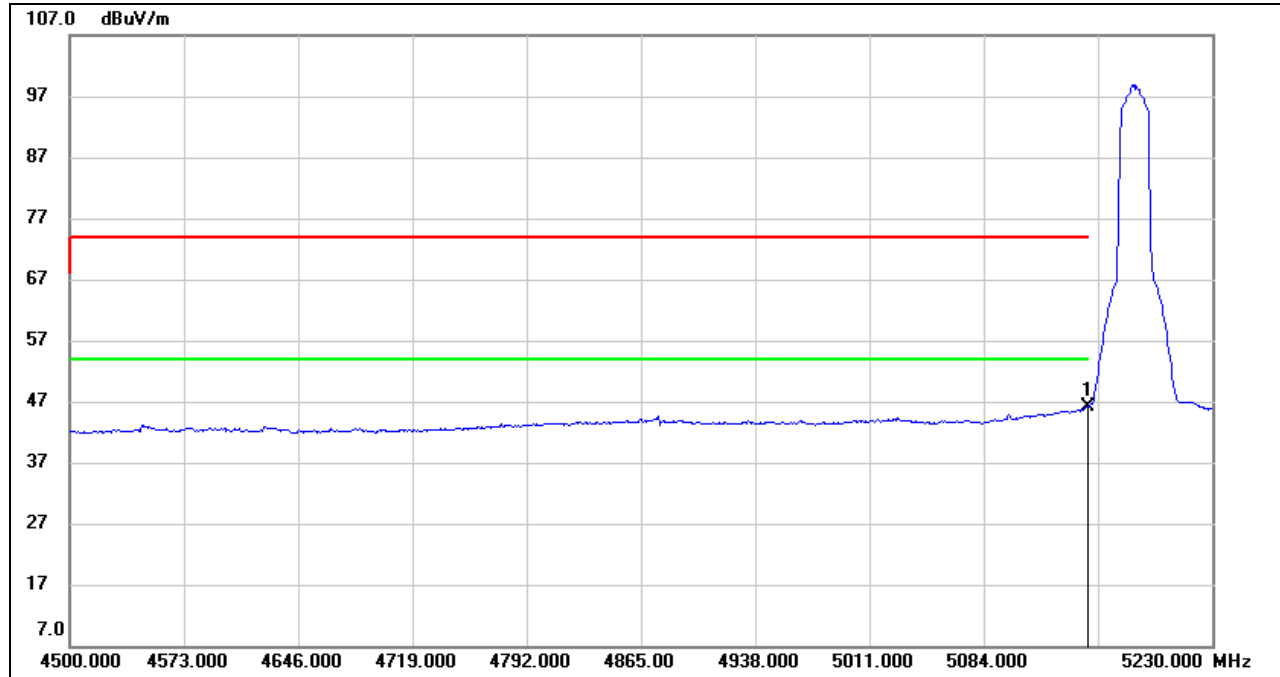

No.	Frequency (MHz)	Reading (dBuV)	Correct (dB/m)	Result (dBuV/m)	Limit (dBuV/m)	Margin (dB)	Remark
1	5150.000	4.97	41.19	46.16	54.00	-7.84	AVG

- Note:
1. Measurement = Reading Level + Correct Factor.
  2. If Peak Result complies with AV limit, AV Result is deemed to comply with AV limit.
  3. AVG:  $VBW=1/Ton$ , where: Ton is the transmitting duration.
  4. For the transmitting duration, please refer to clause 7.1.
  5. Only the worst data was recorded, if it complies with the limit, the other emissions deemed to comply with the limit.



**UNII-2A BAND**

**RESTRICTED BANDEDGE (HIGH CHANNEL, Vertical)**

**PEAK**

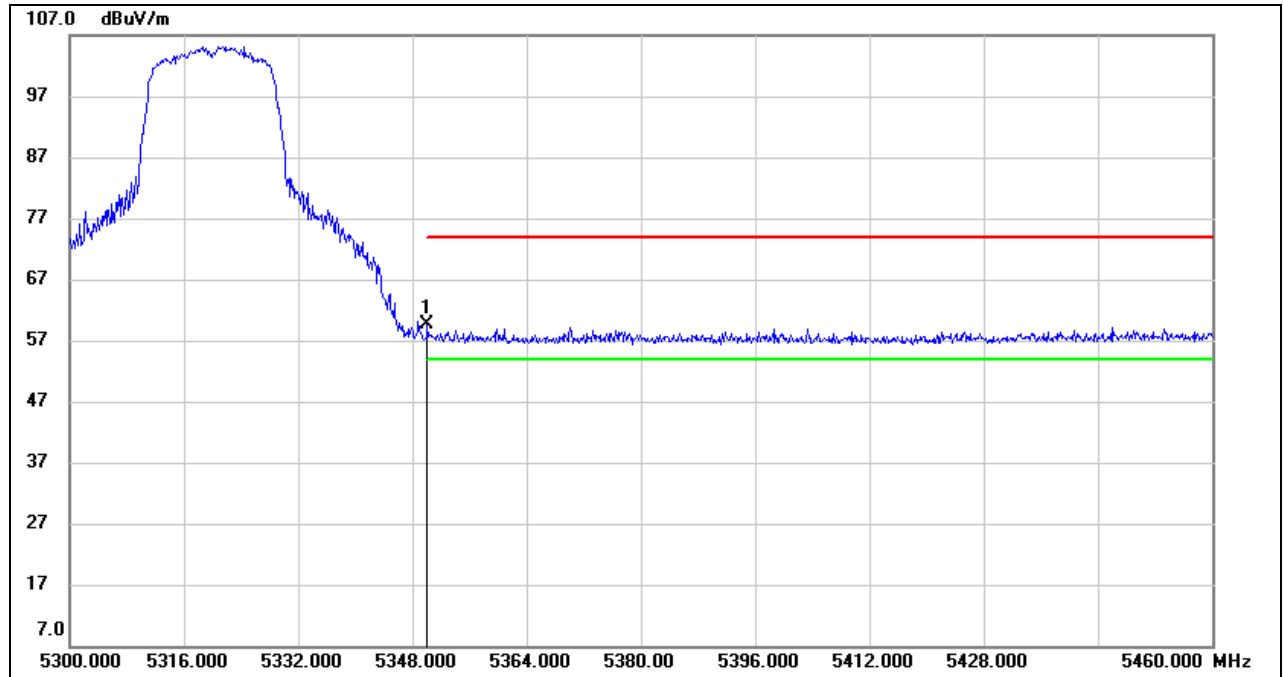

No.	Frequency (MHz)	Reading (dBuV)	Correct (dB/m)	Result (dBuV/m)	Limit (dBuV/m)	Margin (dB)	Remark
1	5350.000	18.53	41.20	59.73	74.00	-14.27	peak

- Note:
1. Measurement = Reading Level + Correct Factor.
  2. If Peak Result complies with AV limit, AV Result is deemed to comply with AV limit.
  3. Peak: Peak detector.
  4. Only the worst data was recorded, if it complies with the limit, the other emissions deemed to comply with the limit.





**AVG**

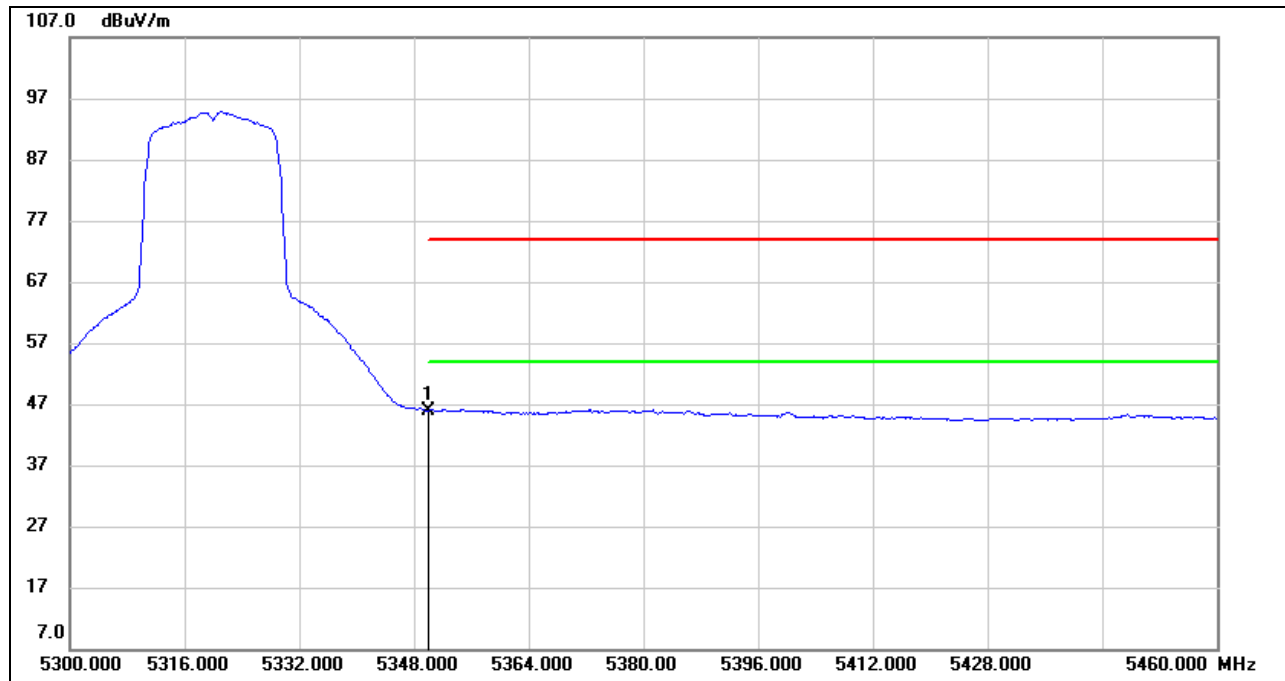

No.	Frequency (MHz)	Reading (dBuV)	Correct (dB/m)	Result (dBuV/m)	Limit (dBuV/m)	Margin (dB)	Remark
1	5350.000	4.78	41.20	45.98	54.00	-8.02	AVG

- Note:
1. Measurement = Reading Level + Correct Factor.
  2. If Peak Result complies with AV limit, AV Result is deemed to comply with AV limit.
  3. AVG:  $VBW=1/Ton$ , where: Ton is the transmitting duration.
  4. For the transmitting duration, please refer to clause 7.1.
  5. Only the worst data was recorded, if it complies with the limit, the other emissions deemed to comply with the limit.

**UNII-2C BAND**

**RESTRICTED BANDEGE (LOW CHANNEL, Vertical)**

**PEAK**

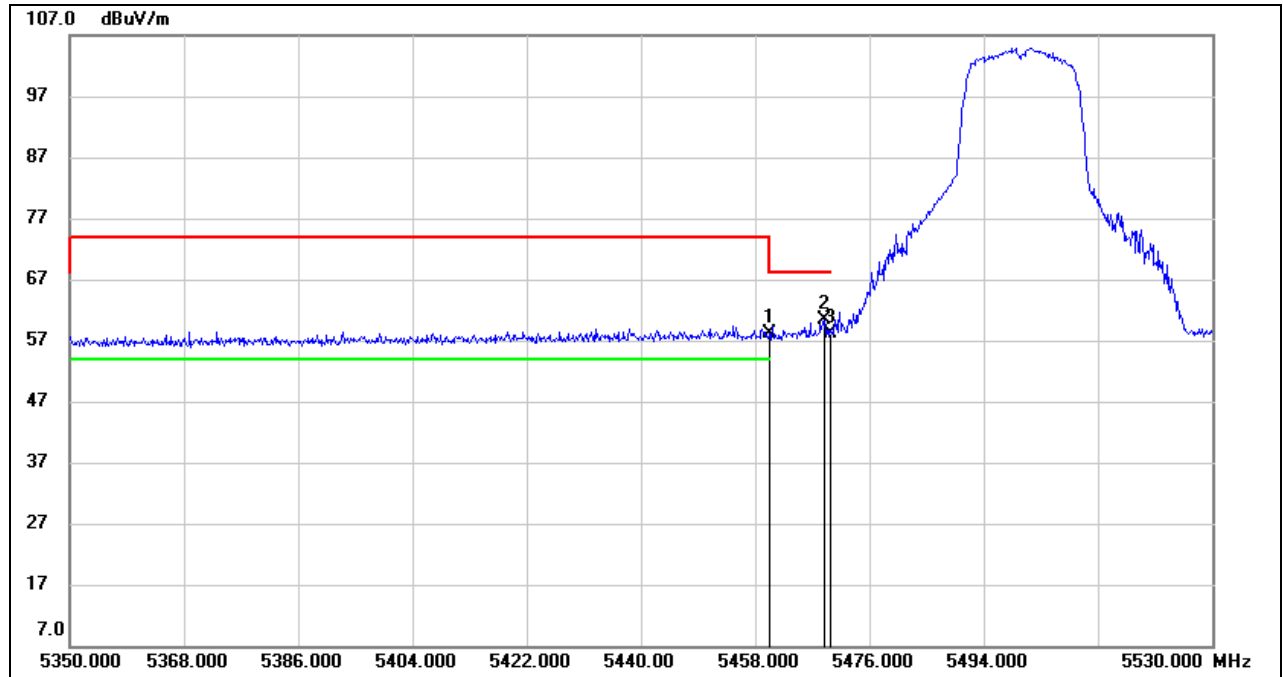

No.	Frequency (MHz)	Reading (dBuV)	Correct (dB/m)	Result (dBuV/m)	Limit (dBuV/m)	Margin (dB)	Remark
1	5460.000	16.37	41.82	58.19	68.20	-10.01	peak
2	5468.800	18.41	41.87	60.28	68.20	-7.92	peak
3	5470.000	16.25	41.87	58.12	68.20	-10.08	peak

- Note: 1. Measurement = Reading Level + Correct Factor.  
 2. If Peak Result complies with AV limit, AV Result is deemed to comply with AV limit.  
 3. Peak: Peak detector.  
 4. Only the worst data was recorded, if it complies with the limit, the other emissions deemed to comply with the limit.



**AVG**

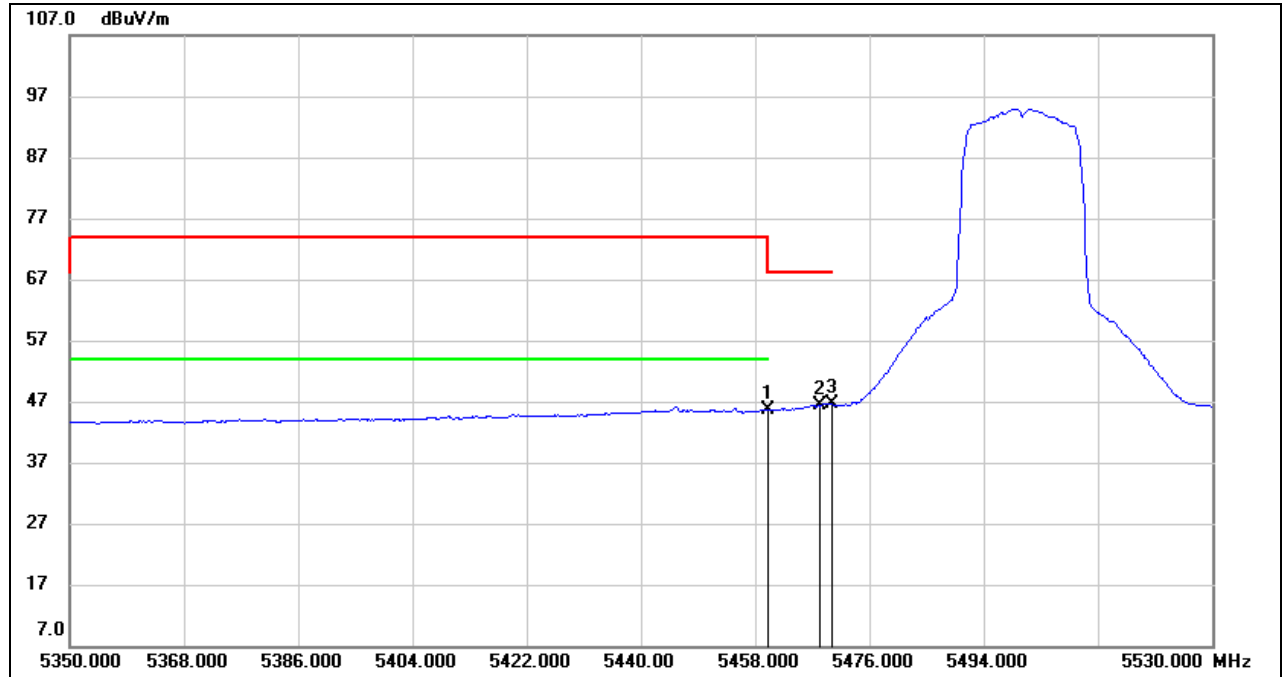

No.	Frequency (MHz)	Reading (dBuV)	Correct (dB/m)	Result (dBuV/m)	Limit (dBuV/m)	Margin (dB)	Remark
1	5460.000	3.70	41.82	45.52	54.00	-8.48	AVG
2	5468.000	4.42	41.87	46.29	/	/	AVG
3	5470.000	4.69	41.87	46.56	/	/	AVG

- Note:
1. Measurement = Reading Level + Correct Factor.
  2. If Peak Result complies with AV limit, AV Result is deemed to comply with AV limit.
  3. AVG:  $VBW=1/Ton$ , where: Ton is the transmitting duration.
  4. For the transmitting duration, please refer to clause 7.1.
  5. Only the worst data was recorded, if it complies with the limit, the other emissions deemed to comply with the limit.



**RESTRICTED BANDEDGE (HIGH CHANNEL, Vertical)**

**PEAK**

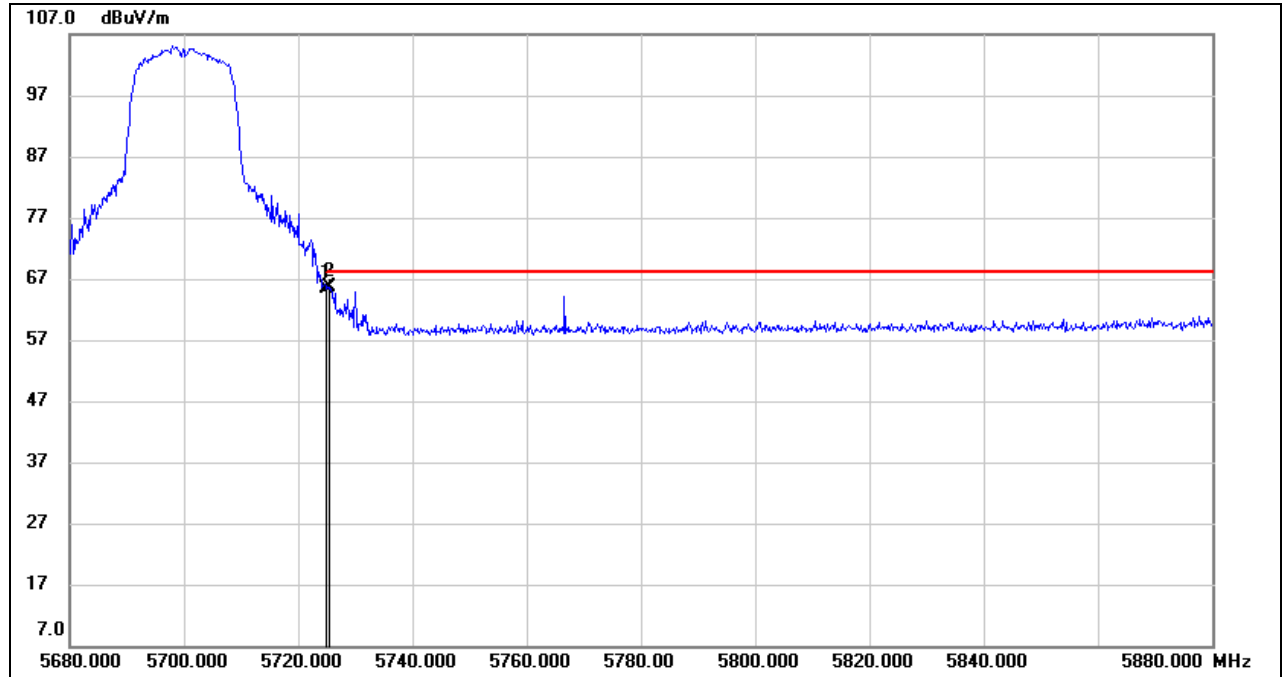

No.	Frequency (MHz)	Reading (dBuV)	Correct (dB/m)	Result (dBuV/m)	Limit (dBuV/m)	Margin (dB)	Remark
1	5725.000	23.68	41.67	65.35	68.20	-2.85	peak
2	5725.400	24.02	41.67	65.69	68.20	-2.51	peak

- Note: 1. Measurement = Reading Level + Correct Factor.  
 2. If Peak Result complies with AV limit, AV Result is deemed to comply with AV limit.  
 3. Peak: Peak detector.  
 4. Only the worst data was recorded, if it complies with the limit, the other emissions deemed to comply with the limit.



**UNII-3 BAND**

**RESTRICTED BANDEGE (LOW CHANNEL, Vertical)**

**PEAK**

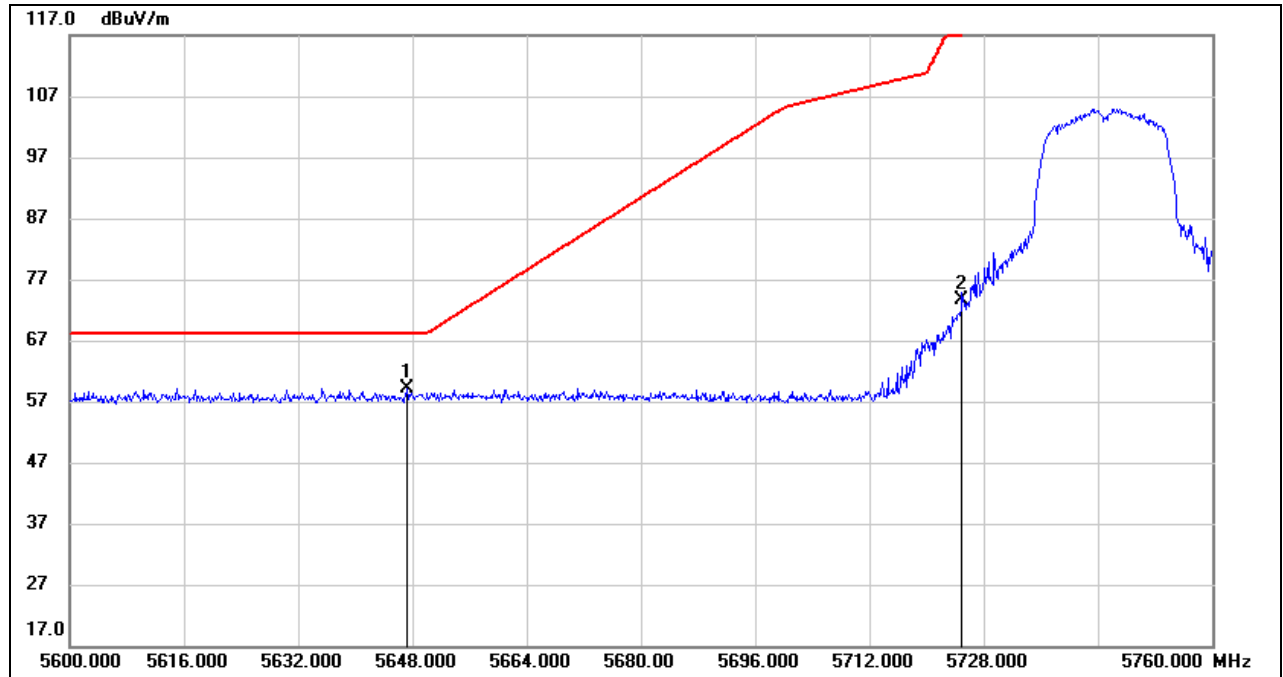

No.	Frequency (MHz)	Reading (dBuV)	Correct (dB/m)	Result (dBuV/m)	Limit (dBuV/m)	Margin (dB)	Remark
1	5647.200	17.53	41.65	59.18	68.20	-9.02	peak
2	5725.000	31.97	41.67	73.64	122.20	-48.56	peak

- Note: 1. Measurement = Reading Level + Correct Factor.  
 2. If Peak Result complies with AV limit, AV Result is deemed to comply with AV limit.  
 3. Peak: Peak detector.  
 4. Only the worst data was recorded, if it complies with the limit, the other emissions deemed to comply with the limit.

**RESTRICTED BANDEDGE (HIGH CHANNEL, Vertical)**

**PEAK**

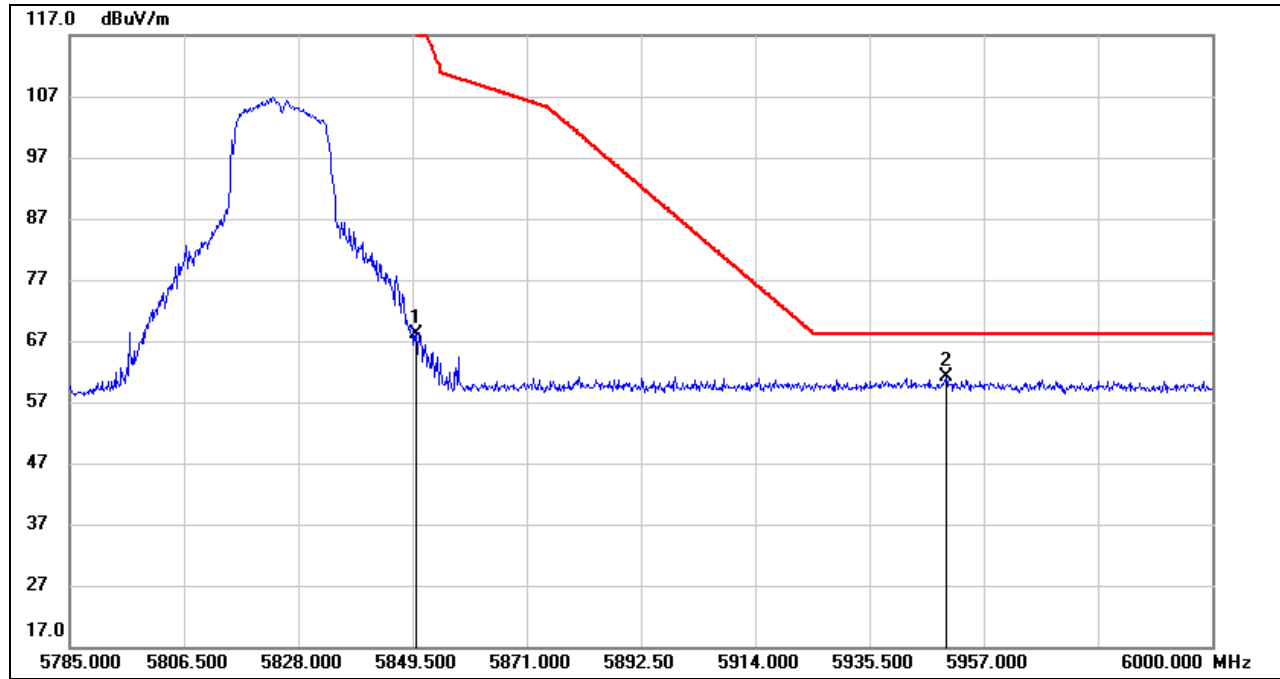

No.	Frequency (MHz)	Reading (dBuV)	Correct (dB/m)	Result (dBuV/m)	Limit (dBuV/m)	Margin (dB)	Remark
1	5850.000	25.54	42.52	68.06	122.20	-54.14	peak
2	5949.905	18.24	42.80	61.04	68.20	-7.16	peak

- Note: 1. Measurement = Reading Level + Correct Factor.  
 2. If Peak Result complies with AV limit, AV Result is deemed to comply with AV limit.  
 3. Peak: Peak detector.  
 4. Only the worst data was recorded, if it complies with the limit, the other emissions deemed to comply with the limit.

Note: Both horizontal and vertical had been tested, but only the worst data was recorded in the report.



8.1.3. 802.11n HT40 MODE

UNII-1 BAND

RESTRICTED BANDEGE (LOW CHANNEL, Vertical

PEAK

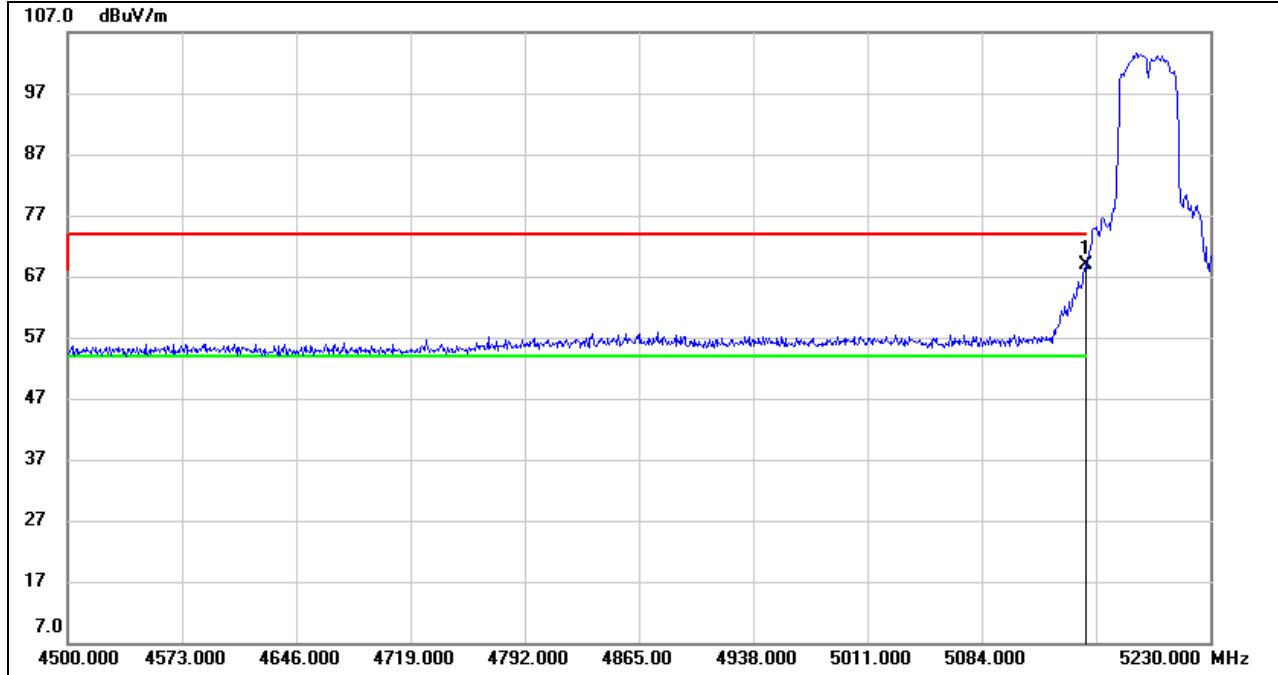

No.	Frequency (MHz)	Reading (dBuV)	Correct (dB/m)	Result (dBuV/m)	Limit (dBuV/m)	Margin (dB)	Remark
1	5150.000	27.62	41.19	68.81	74.00	-5.19	peak

- Note: 1. Measurement = Reading Level + Correct Factor.  
 2. If Peak Result complies with AV limit, AV Result is deemed to comply with AV limit.  
 3. Peak: Peak detector.  
 4. Only the worst data was recorded, if it complies with the limit, the other emissions deemed to comply with the limit.



**AVG**

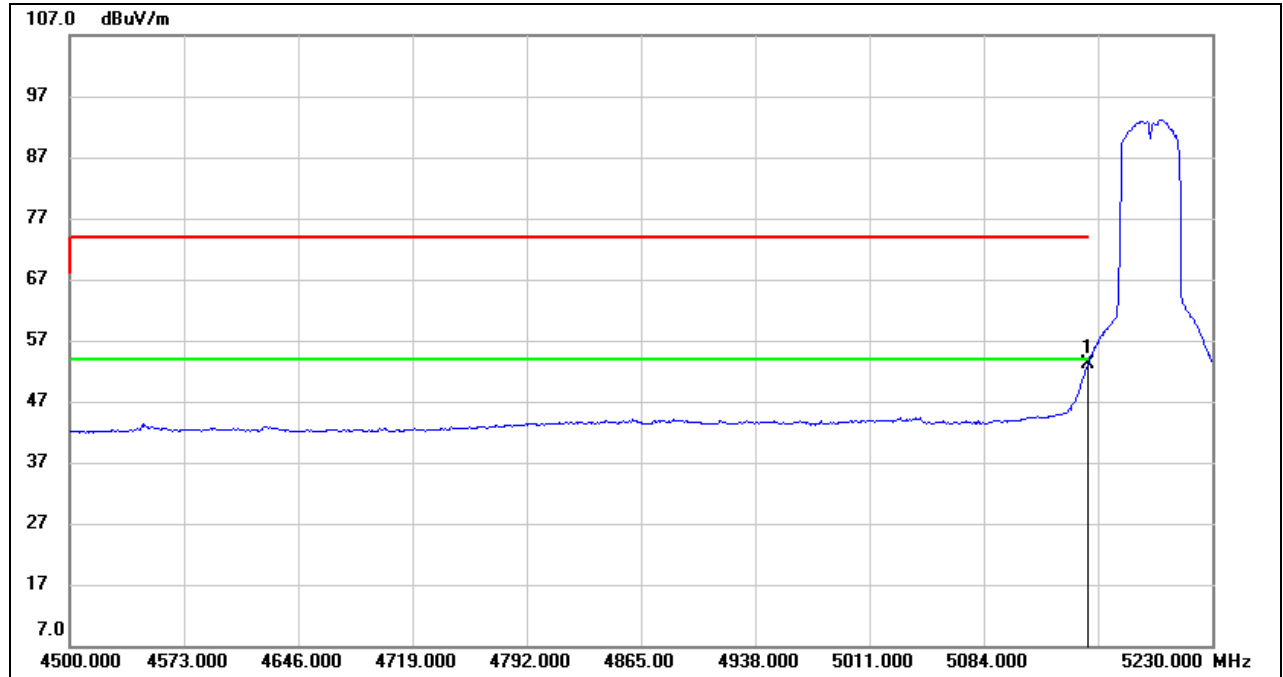

No.	Frequency (MHz)	Reading (dBuV)	Correct (dB/m)	Result (dBuV/m)	Limit (dBuV/m)	Margin (dB)	Remark
1	5150.000	12.03	41.19	53.22	54.00	-0.78	AVG

- Note:
1. Measurement = Reading Level + Correct Factor.
  2. If Peak Result complies with AV limit, AV Result is deemed to comply with AV limit.
  3. AVG:  $VBW=1/T_{on}$ , where:  $T_{on}$  is the transmitting duration.
  4. For the transmitting duration, please refer to clause 7.1.
  5. Only the worst data was recorded, if it complies with the limit, the other emissions deemed to comply with the limit.





**UNII-2A BAND**

**RESTRICTED BANDEDGE (HIGH CHANNEL, Vertical)**

**PEAK**

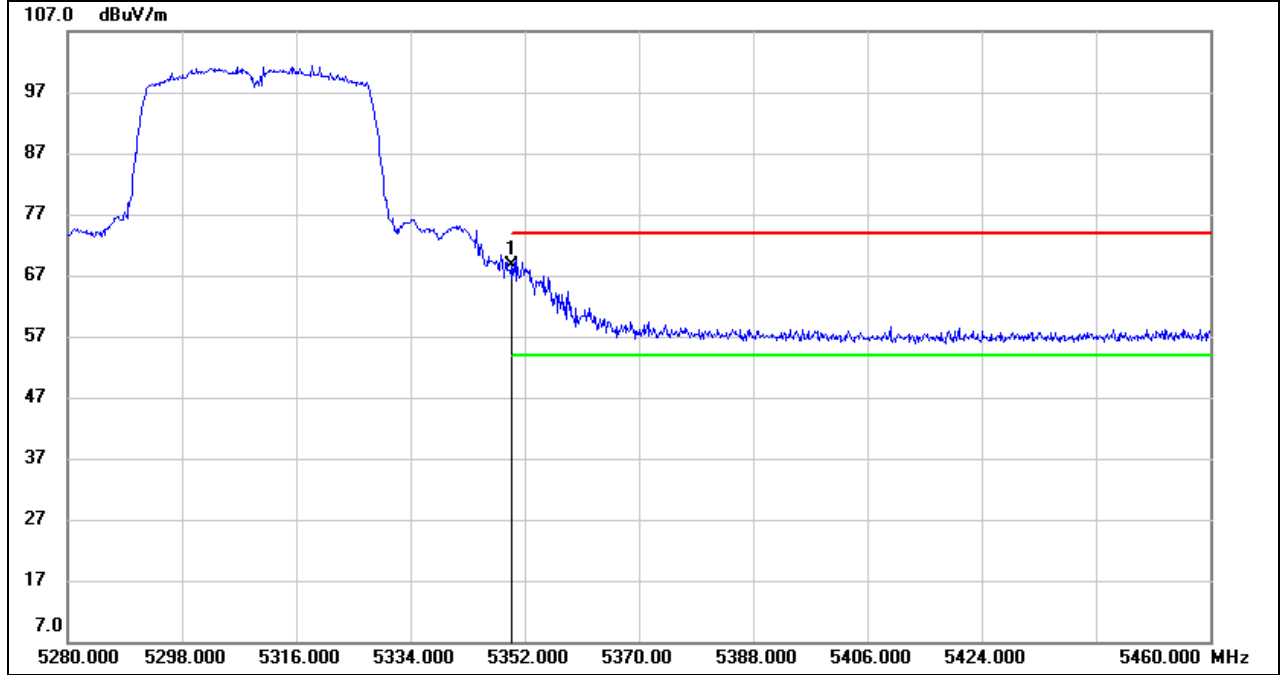

No.	Frequency (MHz)	Reading (dBuV)	Correct (dB/m)	Result (dBuV/m)	Limit (dBuV/m)	Margin (dB)	Remark
1	5350.000	27.38	41.20	68.58	74.00	-5.42	peak

- Note: 1. Measurement = Reading Level + Correct Factor.  
 2. If Peak Result complies with AV limit, AV Result is deemed to comply with AV limit.  
 3. Peak: Peak detector.  
 4. Only the worst data was recorded, if it complies with the limit, the other emissions deemed to comply with the limit.



**AVG**

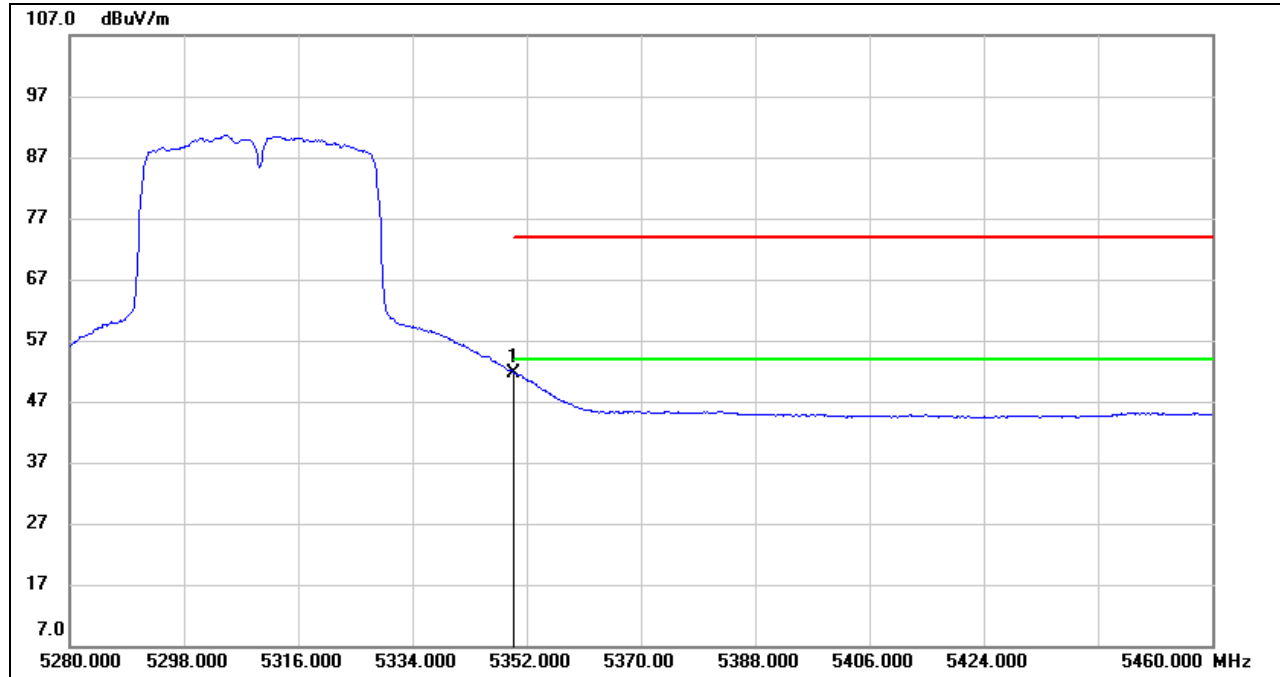

No.	Frequency (MHz)	Reading (dBuV)	Correct (dB/m)	Result (dBuV/m)	Limit (dBuV/m)	Margin (dB)	Remark
1	5350.000	10.51	41.20	51.71	54.00	-2.29	AVG

- Note:
1. Measurement = Reading Level + Correct Factor.
  2. If Peak Result complies with AV limit, AV Result is deemed to comply with AV limit.
  3. AVG:  $VBW=1/Ton$ , where: Ton is the transmitting duration.
  4. For the transmitting duration, please refer to clause 7.1.
  5. Only the worst data was recorded, if it complies with the limit, the other emissions deemed to comply with the limit.



**UNII-2C BAND**

**RESTRICTED BANDEGE (LOW CHANNEL, Vertical)**

**PEAK**

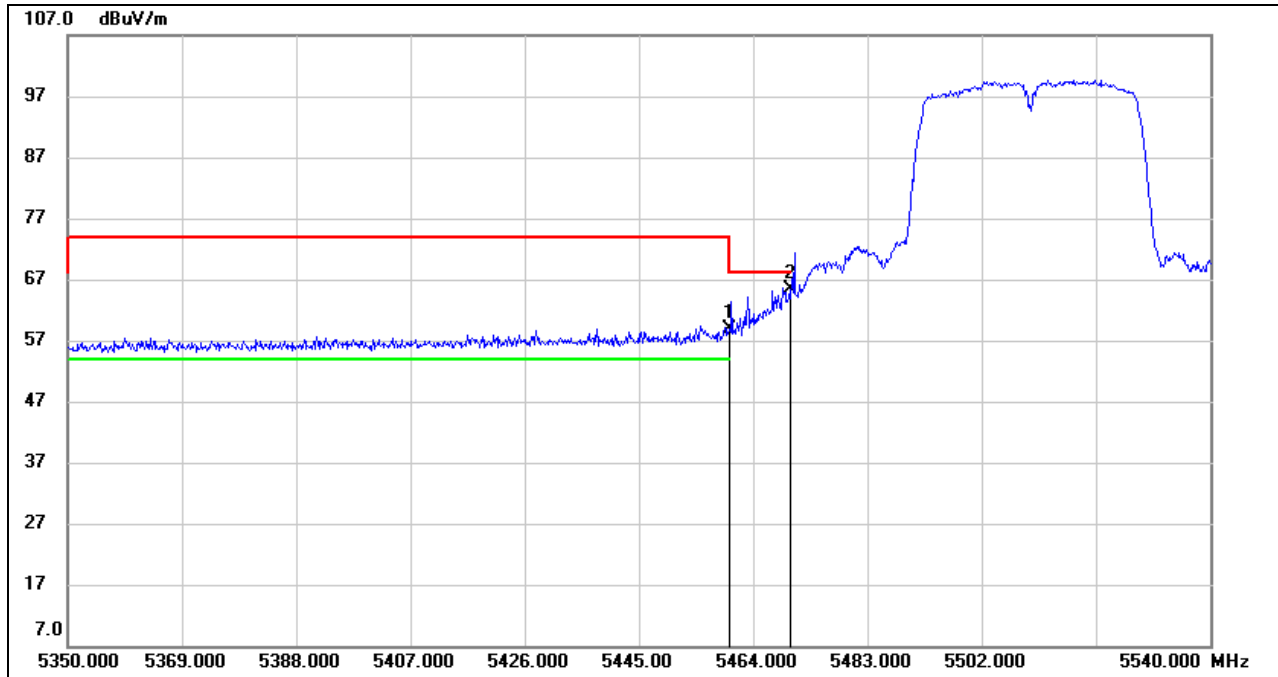

No.	Frequency (MHz)	Reading (dBuV)	Correct (dB/m)	Result (dBuV/m)	Limit (dBuV/m)	Margin (dB)	Remark
1	5460.000	17.02	41.82	58.84	68.20	-9.36	peak
2	5470.000	23.52	41.87	65.39	68.20	-2.81	peak

- Note: 1. Measurement = Reading Level + Correct Factor.  
 2. If Peak Result complies with AV limit, AV Result is deemed to comply with AV limit.  
 3. Peak: Peak detector.  
 4. Only the worst data was recorded, if it complies with the limit, the other emissions deemed to comply with the limit.

**AVG**

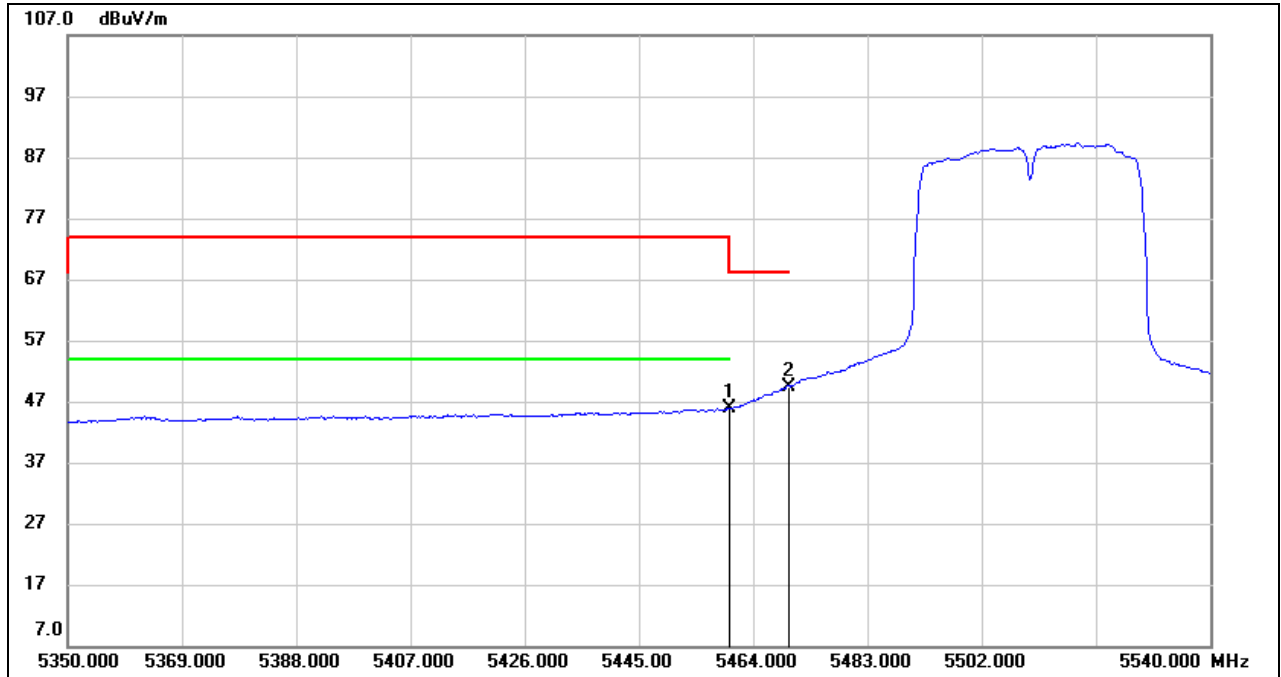

No.	Frequency (MHz)	Reading (dBuV)	Correct (dB/m)	Result (dBuV/m)	Limit (dBuV/m)	Margin (dB)	Remark
1	5460.000	3.95	41.82	45.77	54.00	-8.23	AVG
2	5470.000	7.51	41.87	49.38	68.20	-18.82	AVG

- Note:
1. Measurement = Reading Level + Correct Factor.
  2. If Peak Result complies with AV limit, AV Result is deemed to comply with AV limit.
  3. AVG:  $VBW=1/Ton$ , where: Ton is the transmitting duration.
  4. For the transmitting duration, please refer to clause 7.1.
  5. Only the worst data was recorded, if it complies with the limit, the other emissions deemed to comply with the limit.



**RESTRICTED BANDEDGE (HIGH CHANNEL, Vertical)**

**PEAK**

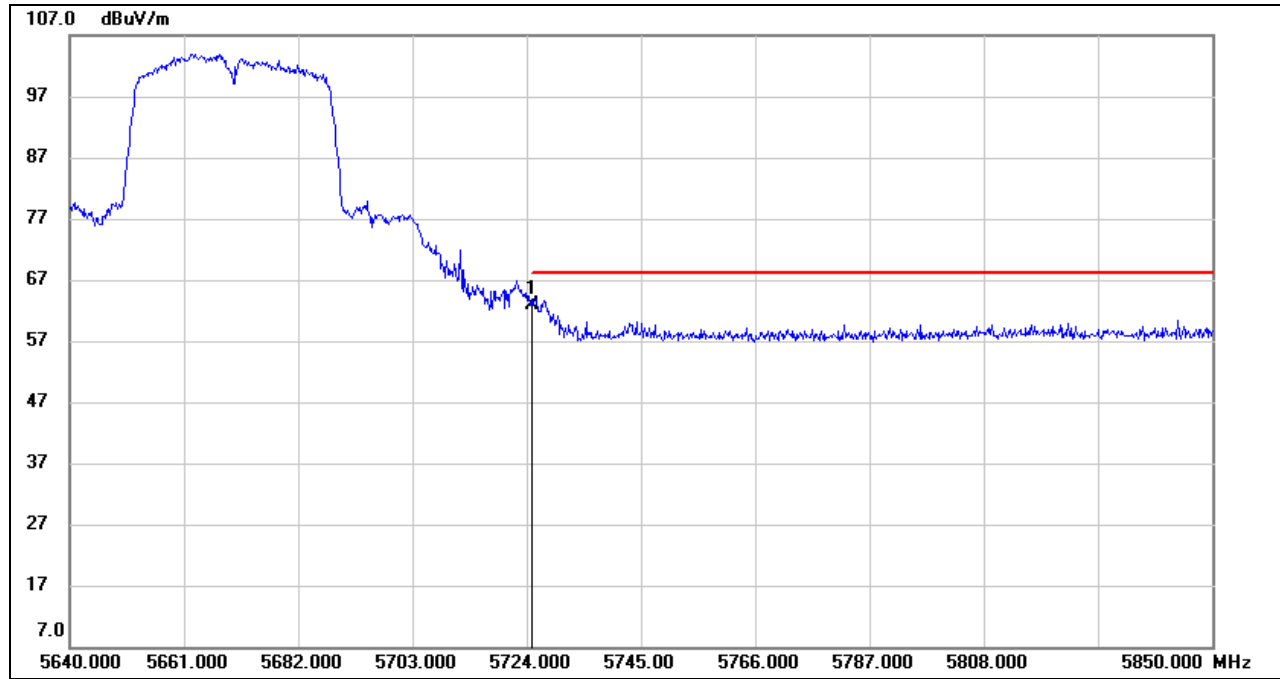

No.	Frequency (MHz)	Reading (dBuV)	Correct (dB/m)	Result (dBuV/m)	Limit (dBuV/m)	Margin (dB)	Remark
1	5725.000	21.16	41.67	62.83	68.20	-5.37	peak

- Note:
1. Measurement = Reading Level + Correct Factor.
  2. If Peak Result complies with AV limit, AV Result is deemed to comply with AV limit.
  3. Peak: Peak detector.
  4. Only the worst data was recorded, if it complies with the limit, the other emissions deemed to comply with the limit.

**UNII-3 BAND**

**RESTRICTED BANDEDGE (LOW CHANNEL, Vertical)**

**PEAK**

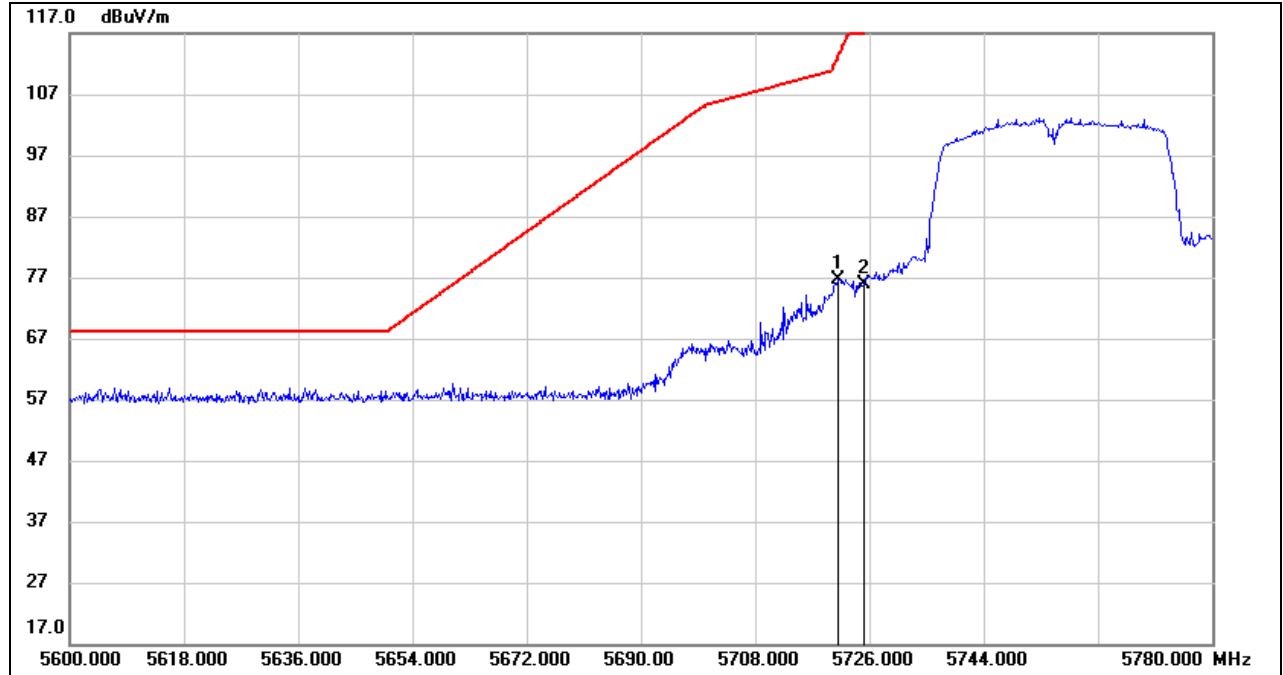

No.	Frequency (MHz)	Reading (dBuV)	Correct (dB/m)	Result (dBuV/m)	Limit (dBuV/m)	Margin (dB)	Remark
1	5721.140	35.03	41.65	76.68	113.40	-36.72	peak
2	5725.000	34.21	41.67	75.88	122.20	-46.32	peak

- Note: 1. Measurement = Reading Level + Correct Factor.  
 2. If Peak Result complies with AV limit, AV Result is deemed to comply with AV limit.  
 3. Peak: Peak detector.  
 4. Only the worst data was recorded, if it complies with the limit, the other emissions deemed to comply with the limit.

**RESTRICTED BANDEDGE (HIGH CHANNEL, Vertical)**

**PEAK**

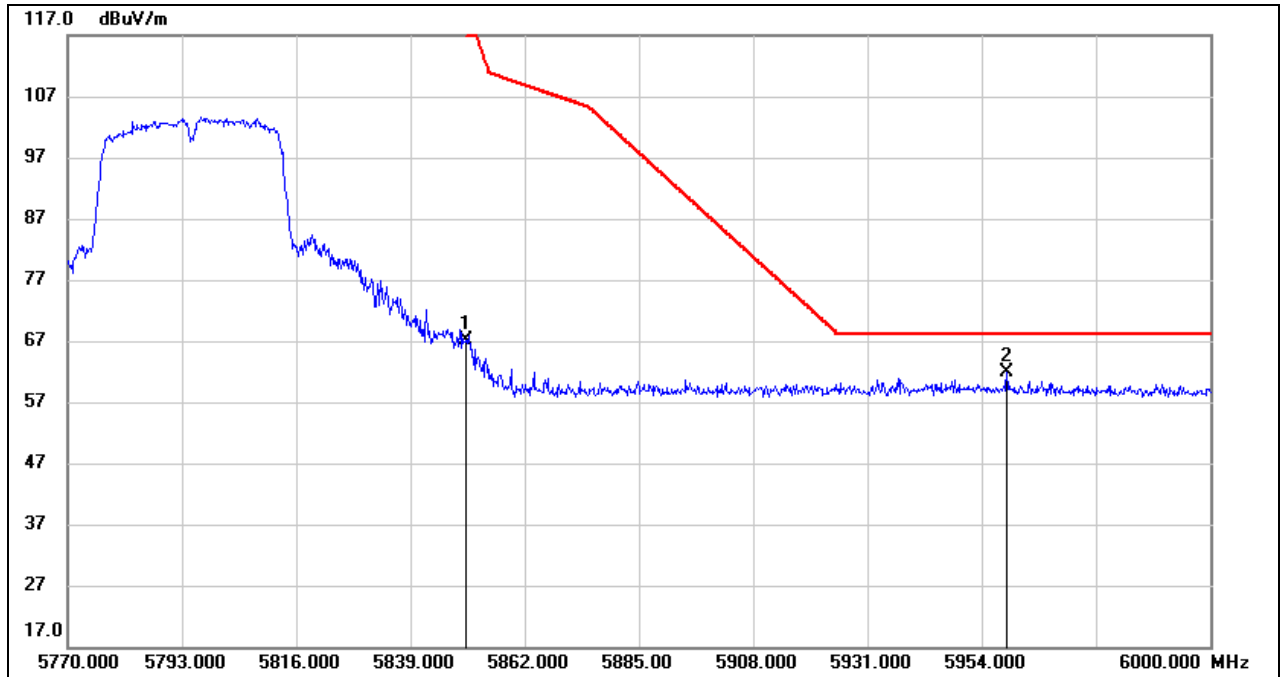

No.	Frequency (MHz)	Reading (dBuV)	Correct (dB/m)	Result (dBuV/m)	Limit (dBuV/m)	Margin (dB)	Remark
1	5850.000	24.64	42.52	67.16	122.20	-55.04	peak
2	5959.060	19.08	42.75	61.83	68.20	-6.37	peak

- Note:
1. Measurement = Reading Level + Correct Factor.
  2. If Peak Result complies with AV limit, AV Result is deemed to comply with AV limit.
  3. Peak: Peak detector.
  4. Only the worst data was recorded, if it complies with the limit, the other emissions deemed to comply with the limit.

Note: Both horizontal and vertical had been tested, but only the worst data was recorded in the report.



## 8.2. SPURIOUS EMISSIONS (1 GHz ~ 7 GHz)

### 8.2.1. 802.11 a MODE

#### UNII-1 BAND

#### HARMONICS AND SPURIOUS EMISSIONS (LOW CHANNEL, HORIZONTAL)

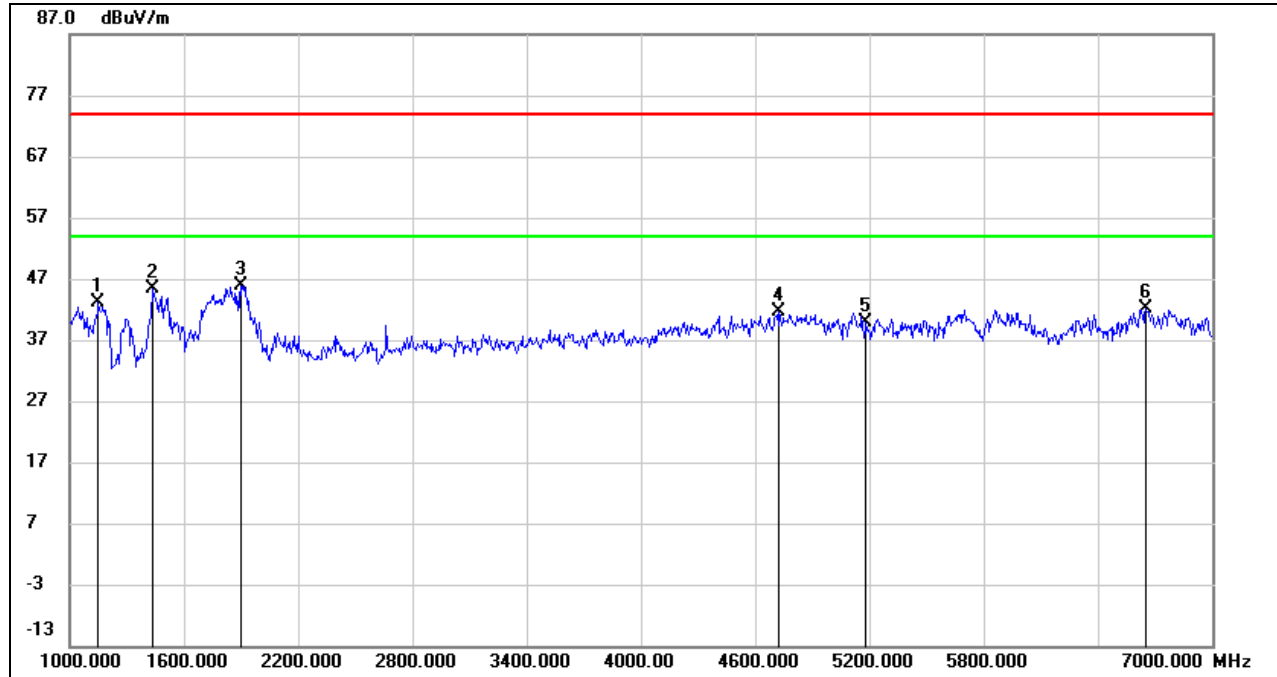

No.	Frequency (MHz)	Reading (dBuV)	Correct (dB/m)	Result (dBuV/m)	Limit (dBuV/m)	Margin (dB)	Remark
1	1150.000	56.47	-13.24	43.23	74.00	-30.77	peak
2	1438.000	57.96	-12.52	45.44	74.00	-28.56	peak
3	1900.000	56.00	-10.12	45.88	74.00	-28.12	peak
4	4726.000	41.58	0.17	41.75	74.00	-32.25	peak
5	5180.000	38.00	1.99	39.99	74.00	-34.01	peak
6	6652.000	36.71	5.52	42.23	74.00	-31.77	peak

- Note: 1. Measurement = Reading Level + Correct Factor.  
 2. If Peak Result complies with AV limit, AV Result is deemed to comply with AV limit.  
 3. Peak: Peak detector.  
 4. Filter losses were only considered in the spurious frequency bands and the authorized band was not corrected for Band reject filter losses.  
 5. Proper operation of the transmitter prior to adding the filter to the measurement chain.  
 6. Since non-restricted band peak emissions are less than the average limit, they also comply with the -27dBm/MHz (68.2dBuV/m) limit.



**HARMONICS AND SPURIOUS EMISSIONS (LOW CHANNEL, VERTICAL)**

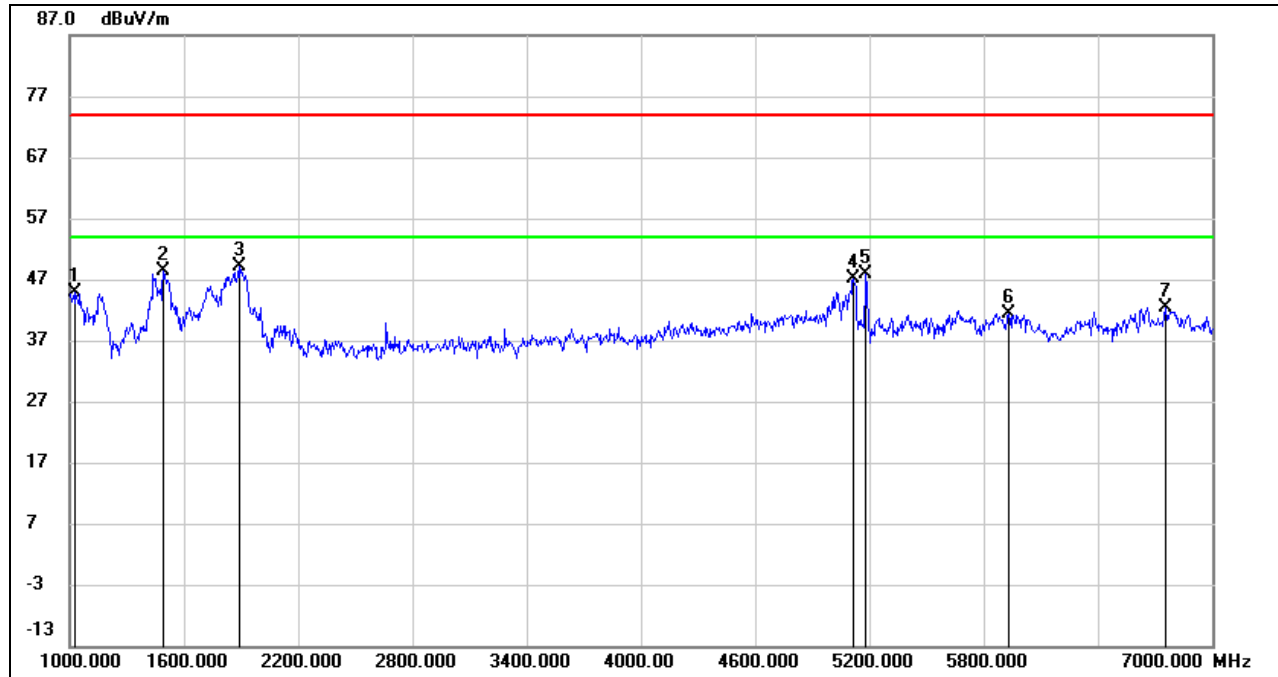

No.	Frequency (MHz)	Reading (dBuV)	Correct (dB/m)	Result (dBuV/m)	Limit (dBuV/m)	Margin (dB)	Remark
1	1030.000	58.69	-13.84	44.85	74.00	-29.15	peak
2	1492.000	60.57	-12.26	48.31	74.00	-25.69	peak
3	1888.000	59.15	-10.12	49.03	74.00	-24.97	peak
4	5116.000	45.57	1.60	47.17	74.00	-26.83	peak
5	5180.000	45.93	1.99	47.92	74.00	-26.08	peak
6	5932.000	38.26	3.03	41.29	74.00	-32.71	peak
7	6754.000	36.82	5.56	42.38	74.00	-31.62	peak

Note: 1. Measurement = Reading Level + Correct Factor.  
 2. If Peak Result complies with AV limit, AV Result is deemed to comply with AV limit.  
 3. Peak: Peak detector.  
 4. Filter losses were only considered in the spurious frequency bands and the authorized band was not corrected for Band reject filter losses.  
 5. Proper operation of the transmitter prior to adding the filter to the measurement chain.  
 6. Since non-restricted band peak emissions are less than the average limit, they also comply with the -27dBm/MHz (68.2dBuV/m) limit.

**HARMONICS AND SPURIOUS EMISSIONS (MID CHANNEL, HORIZONTAL)**

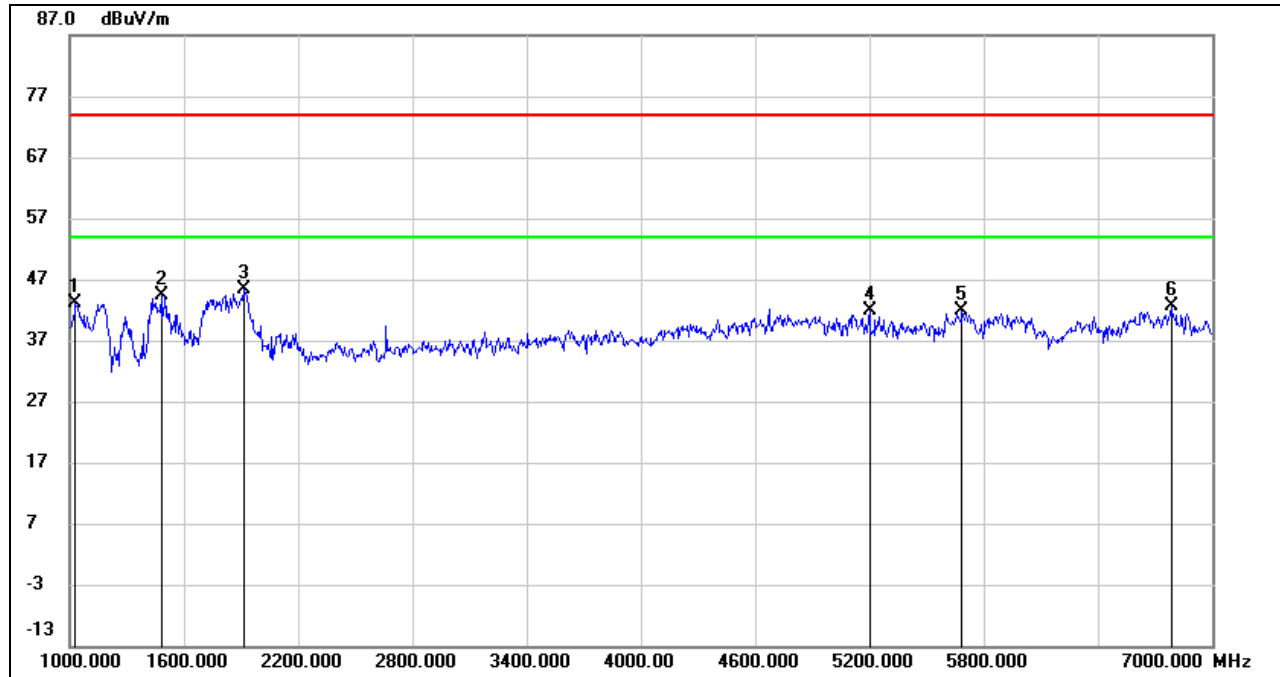

No.	Frequency (MHz)	Reading (dBuV)	Correct (dB/m)	Result (dBuV/m)	Limit (dBuV/m)	Margin (dB)	Remark
1	1030.000	56.88	-13.84	43.04	74.00	-30.96	peak
2	1480.000	56.73	-12.33	44.40	74.00	-29.60	peak
3	1912.000	55.62	-10.12	45.50	74.00	-28.50	peak
4	5200.000	39.66	2.10	41.76	74.00	-32.24	peak
5	5686.000	39.46	2.47	41.93	74.00	-32.07	peak
6	6784.000	37.09	5.56	42.65	74.00	-31.35	peak

- Note: 1. Measurement = Reading Level + Correct Factor.  
 2. If Peak Result complies with AV limit, AV Result is deemed to comply with AV limit.  
 3. Peak: Peak detector.  
 4. Filter losses were only considered in the spurious frequency bands and the authorized band was not corrected for Band reject filter losses.  
 5. Proper operation of the transmitter prior to adding the filter to the measurement chain.  
 6. Since non-restricted band peak emissions are less than the average limit, they also comply with the -27dBm/MHz (68.2dBuV/m) limit.

**HARMONICS AND SPURIOUS EMISSIONS (MID CHANNEL, VERTICAL)**

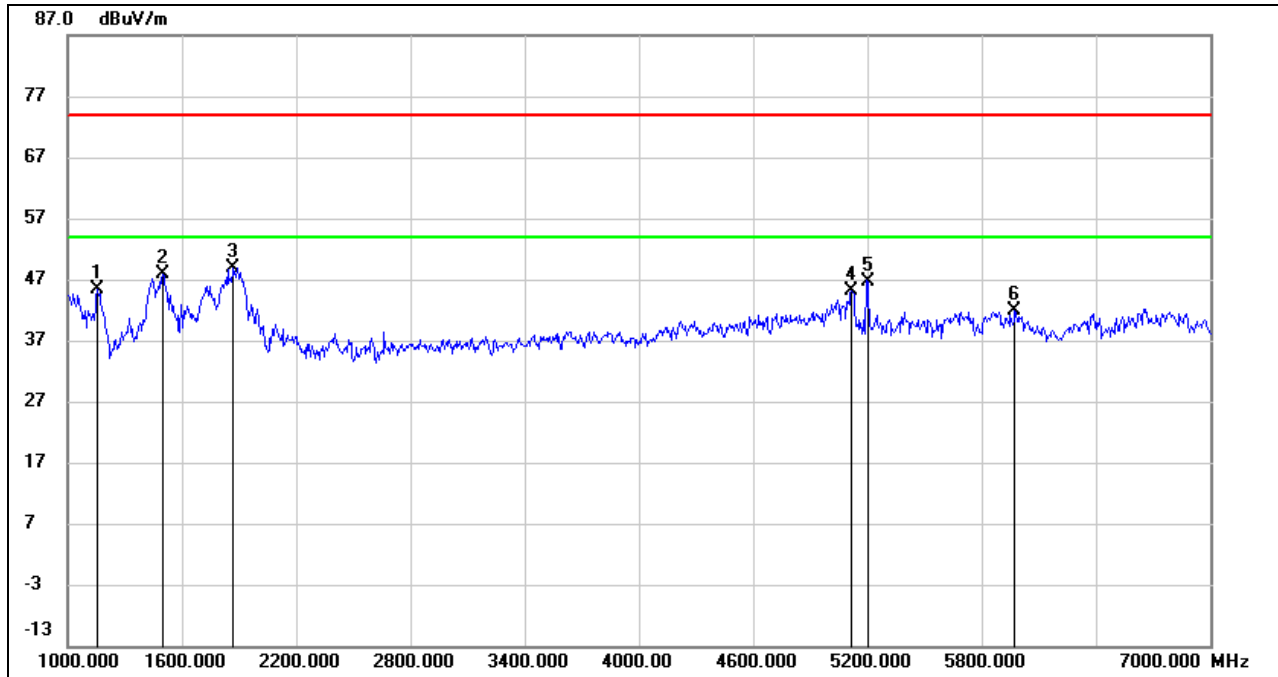

No.	Frequency (MHz)	Reading (dBuV)	Correct (dB/m)	Result (dBuV/m)	Limit (dBuV/m)	Margin (dB)	Remark
1	1156.000	58.48	-13.21	45.27	74.00	-28.73	peak
2	1498.000	60.18	-12.23	47.95	74.00	-26.05	peak
3	1870.000	59.07	-10.09	48.98	74.00	-25.02	peak
4	5116.000	43.59	1.60	45.19	74.00	-28.81	peak
5	5200.000	44.57	2.10	46.67	74.00	-27.33	peak
6	5974.000	38.73	3.20	41.93	74.00	-32.07	peak

Note: 1. Measurement = Reading Level + Correct Factor.  
 2. If Peak Result complies with AV limit, AV Result is deemed to comply with AV limit.  
 3. Peak: Peak detector.  
 4. Filter losses were only considered in the spurious frequency bands and the authorized band was not corrected for Band reject filter losses.  
 5. Proper operation of the transmitter prior to adding the filter to the measurement chain.  
 6. Since non-restricted band peak emissions are less than the average limit, they also comply with the -27dBm/MHz (68.2dBuV/m) limit.

**HARMONICS AND SPURIOUS EMISSIONS (HIGH CHANNEL, HORIZONTAL)**

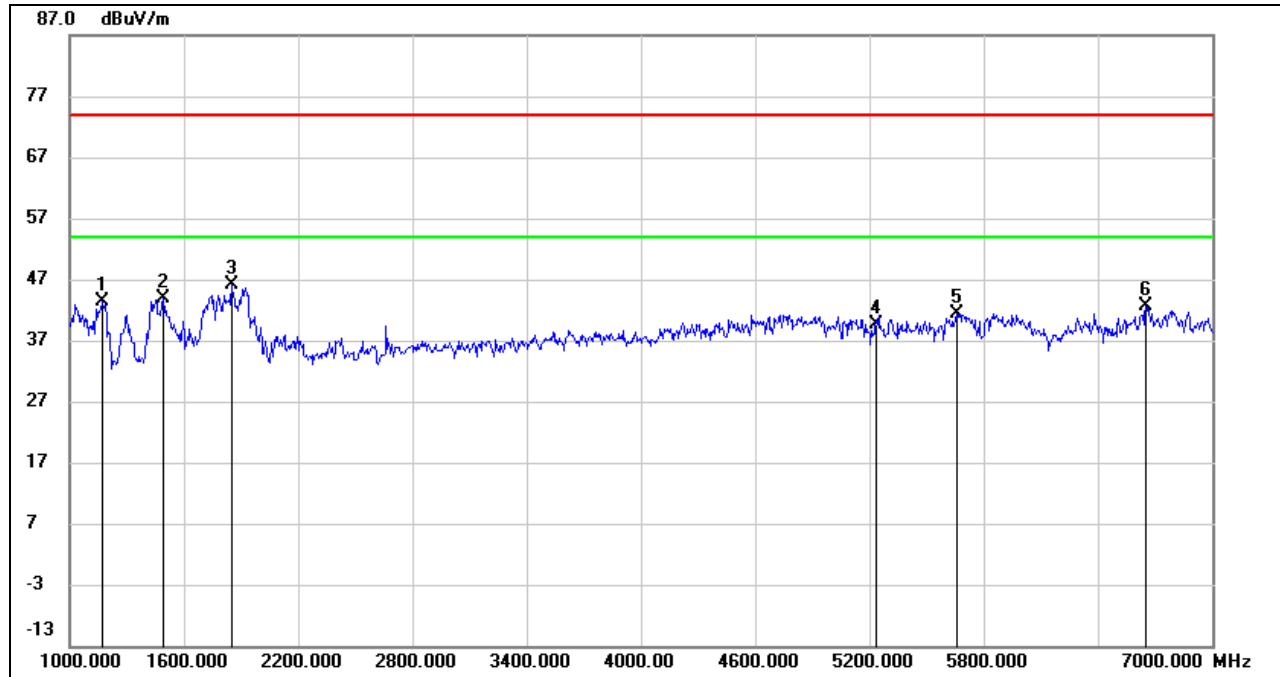

No.	Frequency (MHz)	Reading (dBuV)	Correct (dB/m)	Result (dBuV/m)	Limit (dBuV/m)	Margin (dB)	Remark
1	1168.000	56.55	-13.16	43.39	74.00	-30.61	peak
2	1492.000	56.17	-12.26	43.91	74.00	-30.09	peak
3	1852.000	56.25	-10.08	46.17	74.00	-27.83	peak
4	5240.000	37.49	2.05	39.54	74.00	-34.46	peak
5	5656.000	38.88	2.47	41.35	74.00	-32.65	peak
6	6652.000	37.17	5.52	42.69	74.00	-31.31	peak

Note: 1. Measurement = Reading Level + Correct Factor.  
 2. If Peak Result complies with AV limit, AV Result is deemed to comply with AV limit.  
 3. Peak: Peak detector.  
 4. Filter losses were only considered in the spurious frequency bands and the authorized band was not corrected for Band reject filter losses.  
 5. Proper operation of the transmitter prior to adding the filter to the measurement chain.  
 6. Since non-restricted band peak emissions are less than the average limit, they also comply with the -27dBm/MHz (68.2dBuV/m) limit.

**HARMONICS AND SPURIOUS EMISSIONS (HIGH CHANNEL, VERTICAL)**

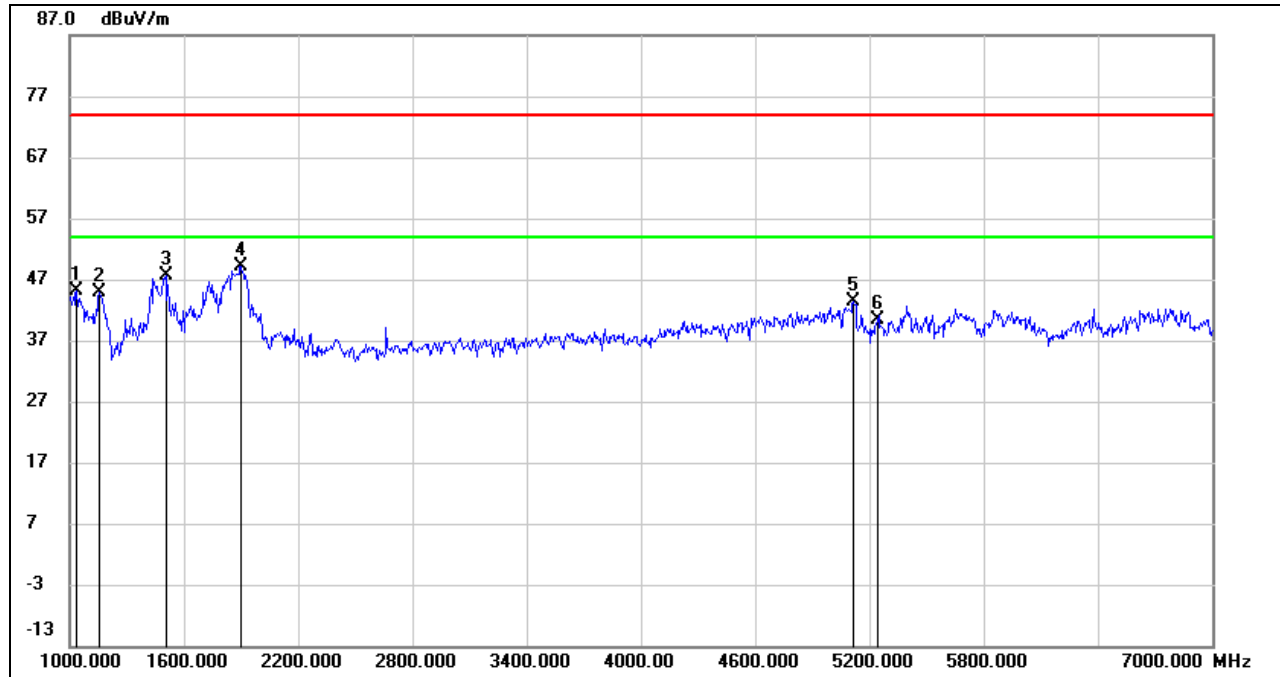

No.	Frequency (MHz)	Reading (dBuV)	Correct (dB/m)	Result (dBuV/m)	Limit (dBuV/m)	Margin (dB)	Remark
1	1036.000	58.86	-13.81	45.05	74.00	-28.95	peak
2	1156.000	58.16	-13.21	44.95	74.00	-29.05	peak
3	1504.000	59.80	-12.20	47.60	74.00	-26.40	peak
4	1900.000	59.32	-10.12	49.20	74.00	-24.80	peak
5	5116.000	41.70	1.60	43.30	74.00	-30.70	peak
6	5240.000	38.41	2.05	40.46	74.00	-33.54	peak

Note: 1. Measurement = Reading Level + Correct Factor.  
 2. If Peak Result complies with AV limit, AV Result is deemed to comply with AV limit.  
 3. Peak: Peak detector.  
 4. Filter losses were only considered in the spurious frequency bands and the authorized band was not corrected for Band reject filter losses.  
 5. Proper operation of the transmitter prior to adding the filter to the measurement chain.  
 6. Since non-restricted band peak emissions are less than the average limit, they also comply with the -27dBm/MHz (68.2dBuV/m) limit.



**UNII-2A BAND**

**HARMONICS AND SPURIOUS EMISSIONS (LOW CHANNEL, HORIZONTAL)**

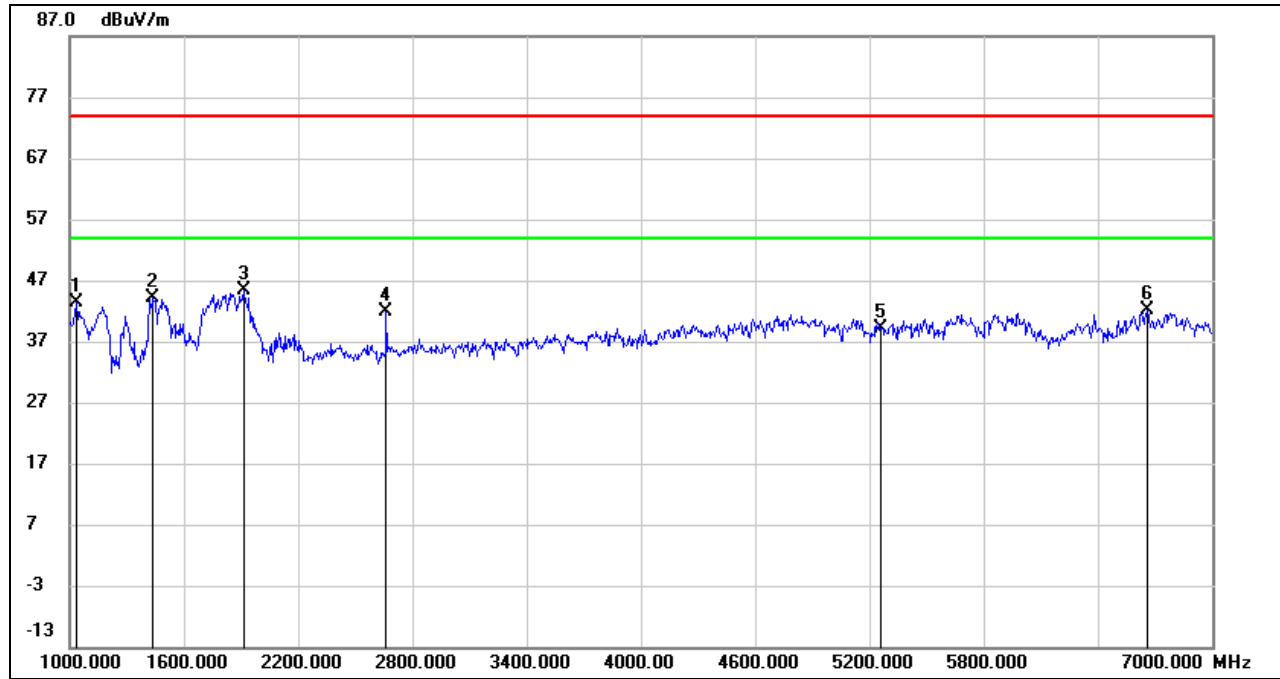

No.	Frequency (MHz)	Reading (dBuV)	Correct (dB/m)	Result (dBuV/m)	Limit (dBuV/m)	Margin (dB)	Remark
1	1036.000	57.23	-13.81	43.42	74.00	-30.58	peak
2	1438.000	56.77	-12.52	44.25	74.00	-29.75	peak
3	1912.000	55.46	-10.12	45.34	74.00	-28.66	peak
4	2662.000	49.36	-7.46	41.90	74.00	-32.10	peak
5	5260.000	37.22	2.03	39.25	74.00	-34.75	peak
6	6658.000	36.73	5.51	42.24	74.00	-31.76	peak

- Note: 1. Measurement = Reading Level + Correct Factor.  
 2. If Peak Result complies with AV limit, AV Result is deemed to comply with AV limit.  
 3. Peak: Peak detector.  
 4. Filter losses were only considered in the spurious frequency bands and the authorized band was not corrected for Band reject filter losses.  
 5. Proper operation of the transmitter prior to adding the filter to the measurement chain.  
 6. Since non-restricted band peak emissions are less than the average limit, they also comply with the -27dBm/MHz (68.2dBuV/m) limit.



**HARMONICS AND SPURIOUS EMISSIONS (LOW CHANNEL, VERTICAL)**

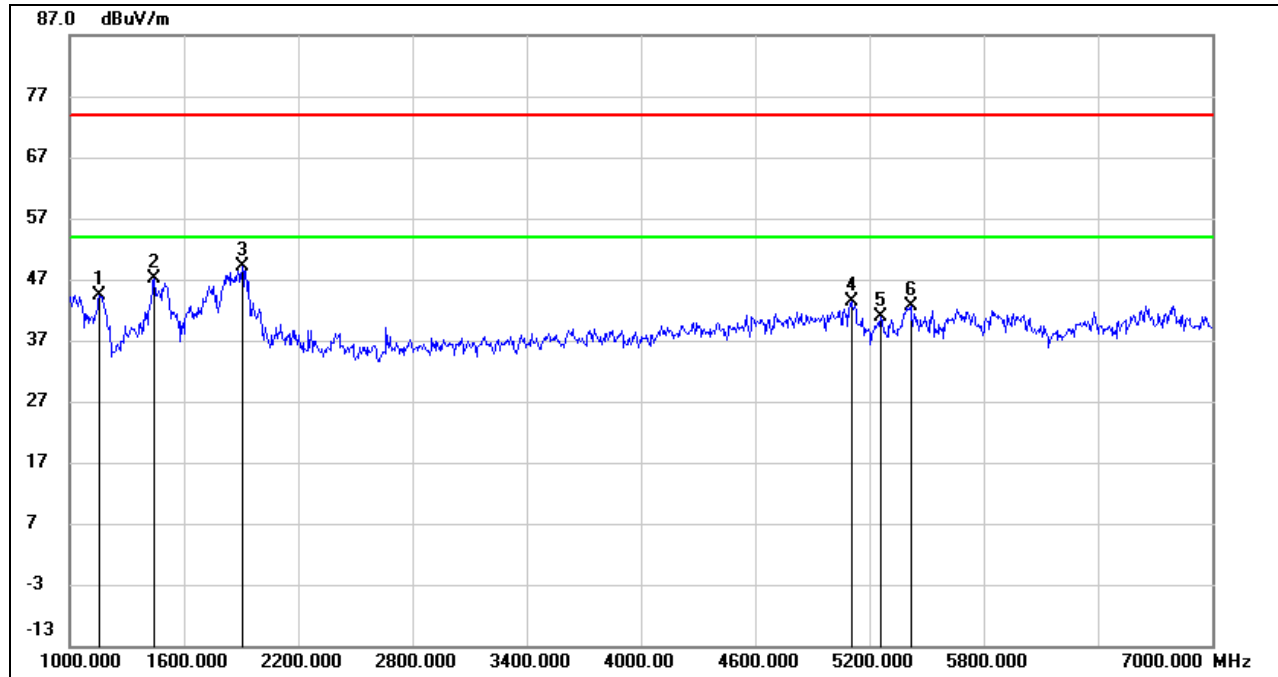

No.	Frequency (MHz)	Reading (dBuV)	Correct (dB/m)	Result (dBuV/m)	Limit (dBuV/m)	Margin (dB)	Remark
1	1156.000	57.68	-13.21	44.47	74.00	-29.53	peak
2	1444.000	59.74	-12.49	47.25	74.00	-26.75	peak
3	1906.000	59.19	-10.13	49.06	74.00	-24.94	peak
4	5104.000	41.93	1.52	43.45	74.00	-30.55	peak
5	5260.000	38.85	2.03	40.88	74.00	-33.12	peak
6	5416.000	40.77	1.92	42.69	74.00	-31.31	peak

Note: 1. Measurement = Reading Level + Correct Factor.  
 2. If Peak Result complies with AV limit, AV Result is deemed to comply with AV limit.  
 3. Peak: Peak detector.  
 4. Filter losses were only considered in the spurious frequency bands and the authorized band was not corrected for Band reject filter losses.  
 5. Proper operation of the transmitter prior to adding the filter to the measurement chain.  
 6. Since non-restricted band peak emissions are less than the average limit, they also comply with the -27dBm/MHz (68.2dBuV/m) limit.

**HARMONICS AND SPURIOUS EMISSIONS (MID CHANNEL, HORIZONTAL)**

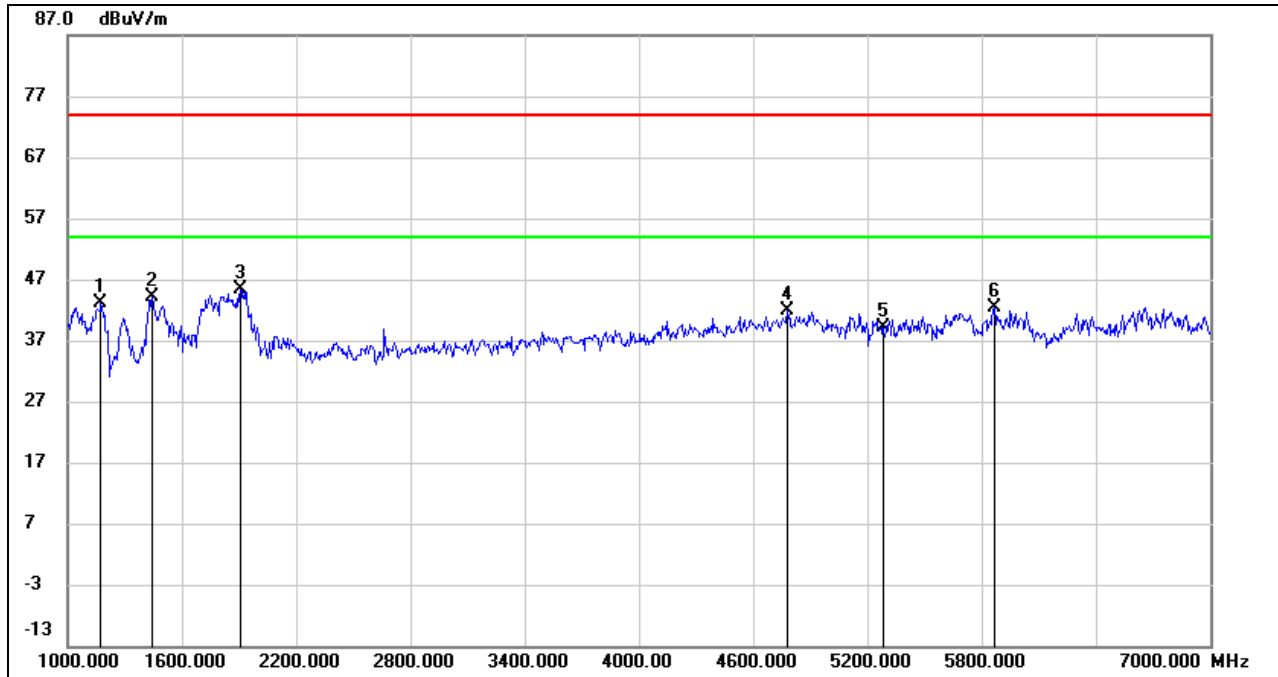

No.	Frequency (MHz)	Reading (dBuV)	Correct (dB/m)	Result (dBuV/m)	Limit (dBuV/m)	Margin (dB)	Remark
1	1174.000	56.19	-13.13	43.06	74.00	-30.94	peak
2	1444.000	56.53	-12.49	44.04	74.00	-29.96	peak
3	1906.000	55.42	-10.13	45.29	74.00	-28.71	peak
4	4780.000	41.32	0.48	41.80	74.00	-32.20	peak
5	5280.000	37.20	2.02	39.22	74.00	-34.78	peak
6	5866.000	39.49	2.77	42.26	74.00	-31.74	peak

- Note: 1. Measurement = Reading Level + Correct Factor.  
 2. If Peak Result complies with AV limit, AV Result is deemed to comply with AV limit.  
 3. Peak: Peak detector.  
 4. Filter losses were only considered in the spurious frequency bands and the authorized band was not corrected for Band reject filter losses.  
 5. Proper operation of the transmitter prior to adding the filter to the measurement chain.  
 6. Since non-restricted band peak emissions are less than the average limit, they also comply with the -27dBm/MHz (68.2dBuV/m) limit.



**HARMONICS AND SPURIOUS EMISSIONS (MID CHANNEL, VERTICAL)**

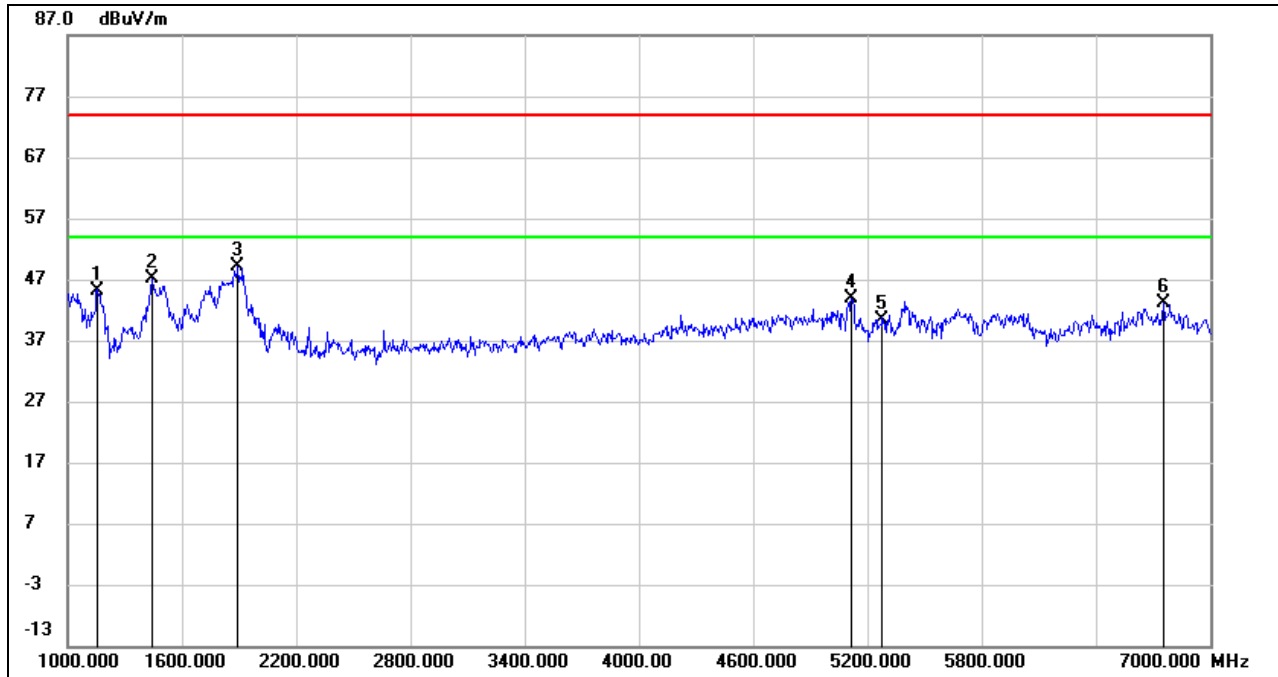

No.	Frequency (MHz)	Reading (dBuV)	Correct (dB/m)	Result (dBuV/m)	Limit (dBuV/m)	Margin (dB)	Remark
1	1156.000	58.46	-13.21	45.25	74.00	-28.75	peak
2	1444.000	59.59	-12.49	47.10	74.00	-26.90	peak
3	1894.000	59.23	-10.11	49.12	74.00	-24.88	peak
4	5116.000	42.22	1.60	43.82	74.00	-30.18	peak
5	5280.000	38.36	2.02	40.38	74.00	-33.62	peak
6	6754.000	37.48	5.56	43.04	74.00	-30.96	peak

Note: 1. Measurement = Reading Level + Correct Factor.  
 2. If Peak Result complies with AV limit, AV Result is deemed to comply with AV limit.  
 3. Peak: Peak detector.  
 4. Filter losses were only considered in the spurious frequency bands and the authorized band was not corrected for Band reject filter losses.  
 5. Proper operation of the transmitter prior to adding the filter to the measurement chain.  
 6. Since non-restricted band peak emissions are less than the average limit, they also comply with the -27dBm/MHz (68.2dBuV/m) limit.



**HARMONICS AND SPURIOUS EMISSIONS (HIGH CHANNEL, HORIZONTAL)**

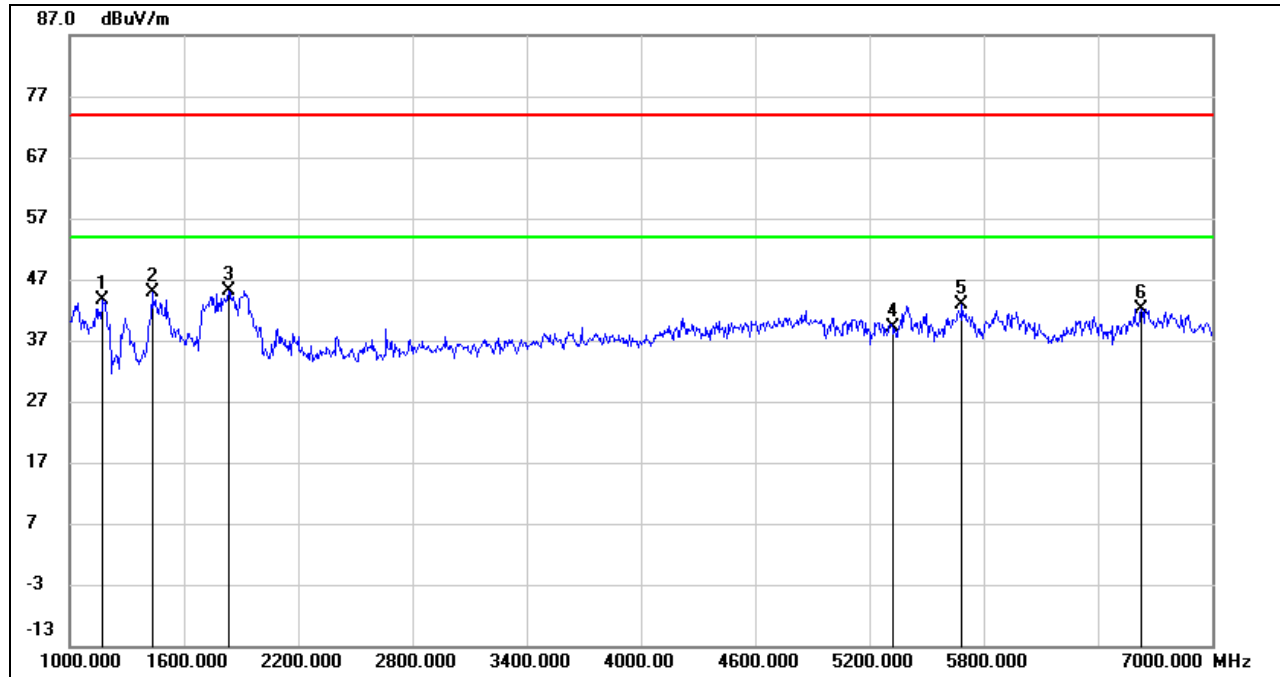

No.	Frequency (MHz)	Reading (dBUV)	Correct (dB/m)	Result (dBUV/m)	Limit (dBUV/m)	Margin (dB)	Remark
1	1174.000	56.80	-13.13	43.67	74.00	-30.33	peak
2	1432.000	57.36	-12.55	44.81	74.00	-29.19	peak
3	1834.000	55.16	-10.08	45.08	74.00	-28.92	peak
4	5320.000	37.14	1.96	39.10	74.00	-34.90	peak
5	5686.000	40.32	2.47	42.79	74.00	-31.21	peak
6	6628.000	36.62	5.50	42.12	74.00	-31.88	peak

Note: 1. Measurement = Reading Level + Correct Factor.  
 2. If Peak Result complies with AV limit, AV Result is deemed to comply with AV limit.  
 3. Peak: Peak detector.  
 4. Filter losses were only considered in the spurious frequency bands and the authorized band was not corrected for Band reject filter losses.  
 5. Proper operation of the transmitter prior to adding the filter to the measurement chain.  
 6. Since non-restricted band peak emissions are less than the average limit, they also comply with the -27dBm/MHz (68.2dBuV/m) limit.

**HARMONICS AND SPURIOUS EMISSIONS (HIGH CHANNEL, VERTICAL)**

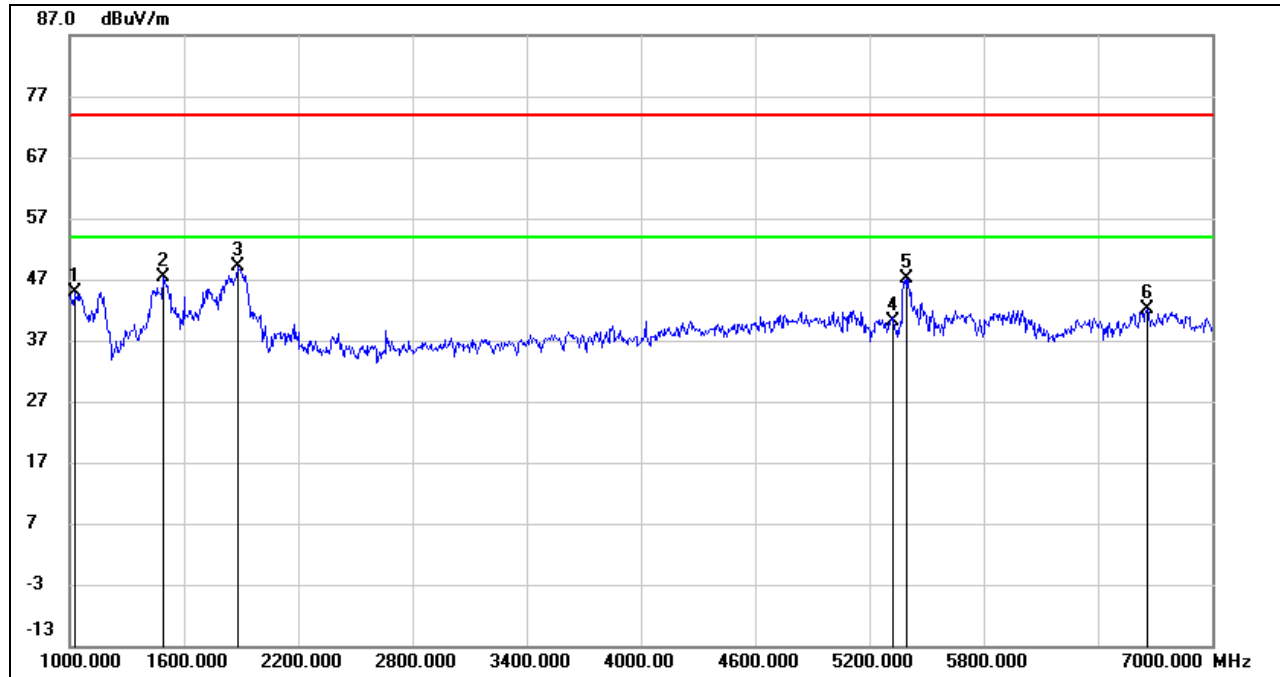

No.	Frequency (MHz)	Reading (dBuV)	Correct (dB/m)	Result (dBuV/m)	Limit (dBuV/m)	Margin (dB)	Remark
1	1030.000	58.83	-13.84	44.99	74.00	-29.01	peak
2	1492.000	59.61	-12.26	47.35	74.00	-26.65	peak
3	1882.000	59.18	-10.11	49.07	74.00	-24.93	peak
4	5320.000	38.25	1.96	40.21	74.00	-33.79	peak
5	5398.000	45.15	1.88	47.03	74.00	-26.97	peak
6	6658.000	36.72	5.51	42.23	74.00	-31.77	peak

Note: 1. Measurement = Reading Level + Correct Factor.  
 2. If Peak Result complies with AV limit, AV Result is deemed to comply with AV limit.  
 3. Peak: Peak detector.  
 4. Filter losses were only considered in the spurious frequency bands and the authorized band was not corrected for Band reject filter losses.  
 5. Proper operation of the transmitter prior to adding the filter to the measurement chain.  
 6. Since non-restricted band peak emissions are less than the average limit, they also comply with the -27dBm/MHz (68.2dBuV/m) limit.



**UNII-2C BAND**

**HARMONICS AND SPURIOUS EMISSIONS (LOW CHANNEL, HORIZONTAL)**

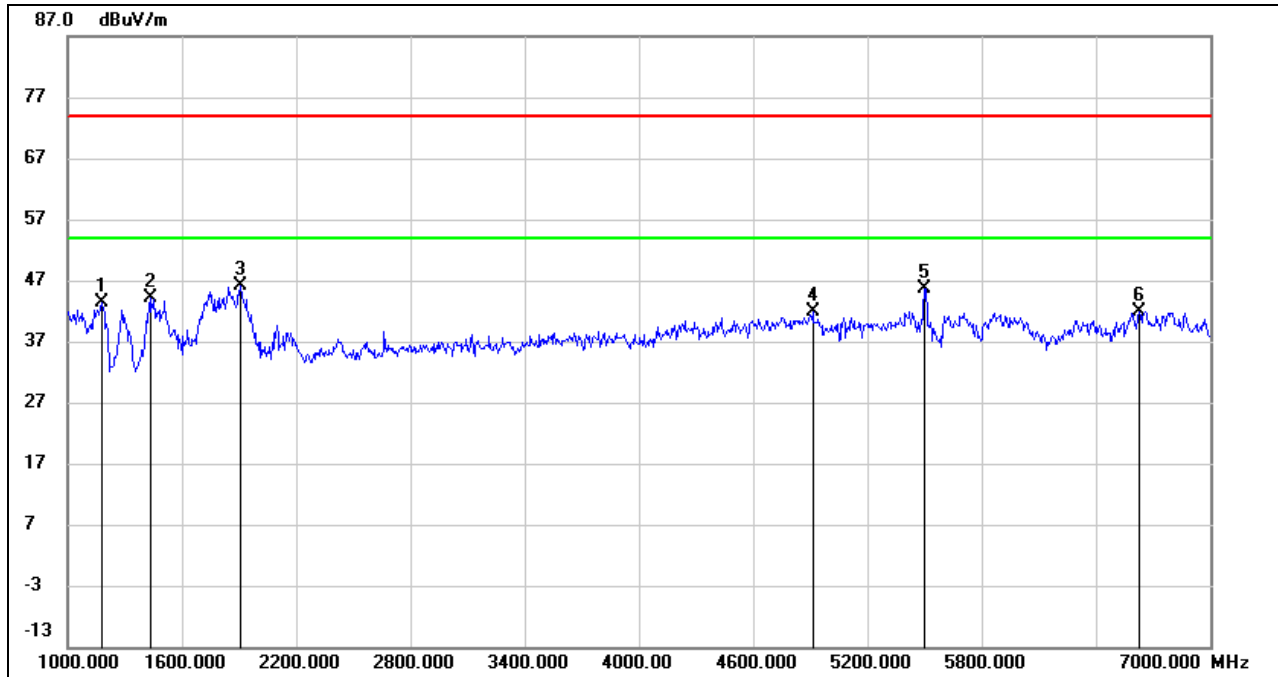

No.	Frequency (MHz)	Reading (dBuV)	Correct (dB/m)	Result (dBuV/m)	Limit (dBuV/m)	Margin (dB)	Remark
1	1180.000	56.50	-13.10	43.40	74.00	-30.60	peak
2	1438.000	56.77	-12.52	44.25	74.00	-29.75	peak
3	1906.000	56.16	-10.13	46.03	74.00	-27.97	peak
4	4912.000	41.19	0.77	41.96	74.00	-32.04	peak
5	5500.000	43.56	2.17	45.73	74.00	-28.27	peak
6	6628.000	36.40	5.50	41.90	74.00	-32.10	peak

Note: 1. Measurement = Reading Level + Correct Factor.  
 2. If Peak Result complies with AV limit, AV Result is deemed to comply with AV limit.  
 3. Peak: Peak detector.  
 4. Filter losses were only considered in the spurious frequency bands and the authorized band was not corrected for Band reject filter losses.  
 5. Proper operation of the transmitter prior to adding the filter to the measurement chain.  
 6. Since non-restricted band peak emissions are less than the average limit, they also comply with the -27dBm/MHz (68.2dBuV/m) limit.

**HARMONICS AND SPURIOUS EMISSIONS (LOW CHANNEL, VERTICAL)**

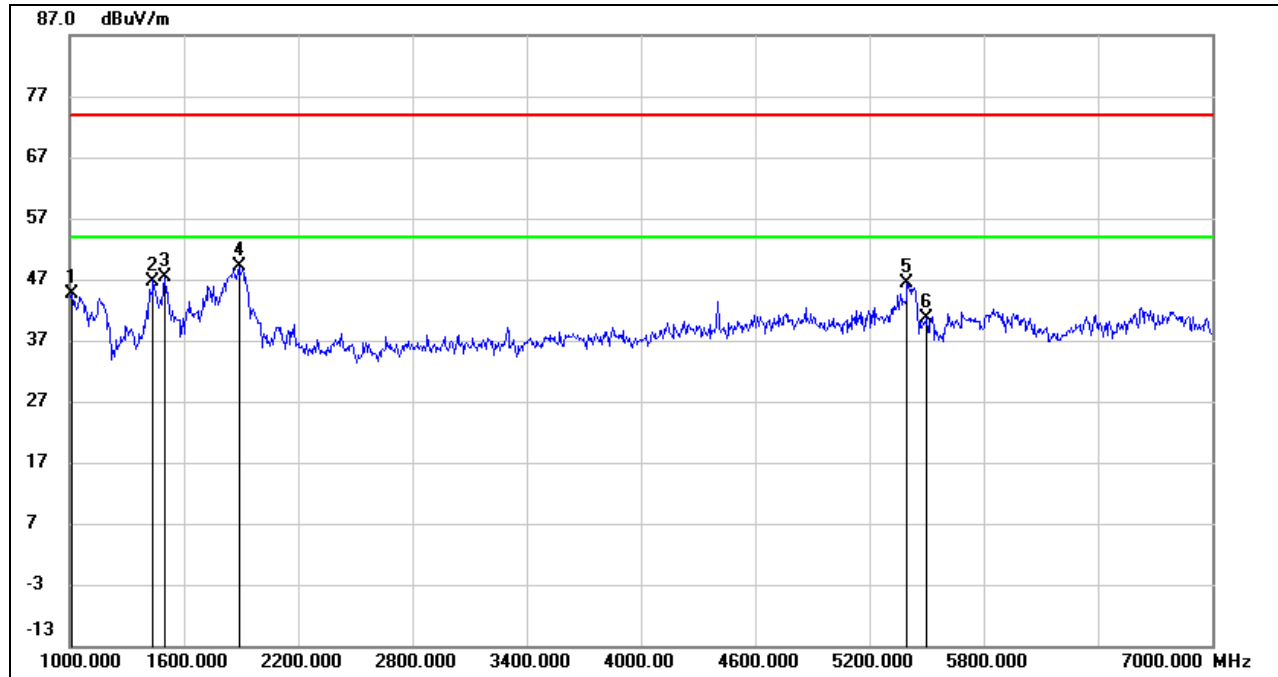

No.	Frequency (MHz)	Reading (dBuV)	Correct (dB/m)	Result (dBuV/m)	Limit (dBuV/m)	Margin (dB)	Remark
1	1012.000	58.62	-13.92	44.70	74.00	-29.30	peak
2	1438.000	59.27	-12.52	46.75	74.00	-27.25	peak
3	1498.000	59.50	-12.23	47.27	74.00	-26.73	peak
4	1888.000	59.37	-10.12	49.25	74.00	-24.75	peak
5	5398.000	44.62	1.88	46.50	74.00	-27.50	peak
6	5500.000	38.42	2.17	40.59	74.00	-33.41	peak

Note: 1. Measurement = Reading Level + Correct Factor.  
 2. If Peak Result complies with AV limit, AV Result is deemed to comply with AV limit.  
 3. Peak: Peak detector.  
 4. Filter losses were only considered in the spurious frequency bands and the authorized band was not corrected for Band reject filter losses.  
 5. Proper operation of the transmitter prior to adding the filter to the measurement chain.  
 6. Since non-restricted band peak emissions are less than the average limit, they also comply with the -27dBm/MHz (68.2dBuV/m) limit.

**HARMONICS AND SPURIOUS EMISSIONS (MID CHANNEL, HORIZONTAL)**

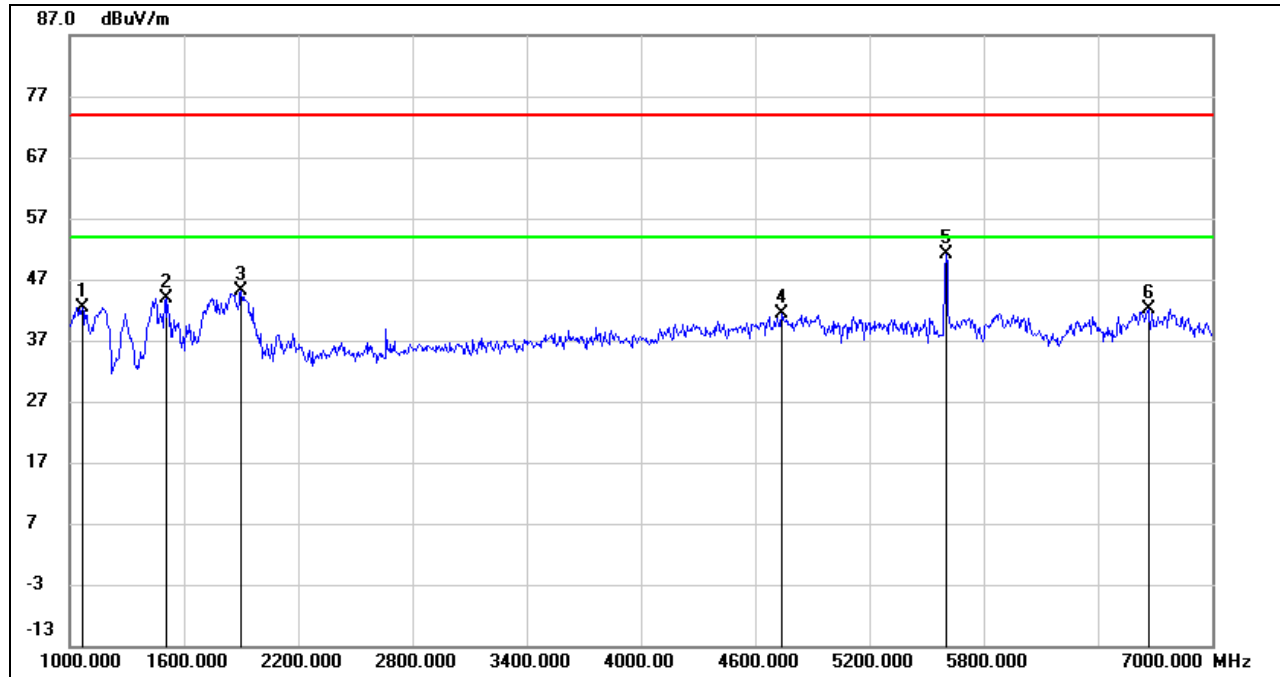

No.	Frequency (MHz)	Reading (dBuV)	Correct (dB/m)	Result (dBuV/m)	Limit (dBuV/m)	Margin (dB)	Remark
1	1066.000	56.10	-13.65	42.45	74.00	-31.55	peak
2	1510.000	56.11	-12.16	43.95	74.00	-30.05	peak
3	1900.000	55.21	-10.12	45.09	74.00	-28.91	peak
4	4738.000	41.16	0.22	41.38	74.00	-32.62	peak
5	5600.000	48.60	2.46	51.06	74.00	-22.94	peak
6	6664.000	36.66	5.53	42.19	74.00	-31.81	peak

- Note: 1. Measurement = Reading Level + Correct Factor.  
 2. If Peak Result complies with AV limit, AV Result is deemed to comply with AV limit.  
 3. Peak: Peak detector.  
 4. Filter losses were only considered in the spurious frequency bands and the authorized band was not corrected for Band reject filter losses.  
 5. Proper operation of the transmitter prior to adding the filter to the measurement chain.  
 6. Since non-restricted band peak emissions are less than the average limit, they also comply with the -27dBm/MHz (68.2dBuV/m) limit.

**HARMONICS AND SPURIOUS EMISSIONS (MID CHANNEL, VERTICAL)**

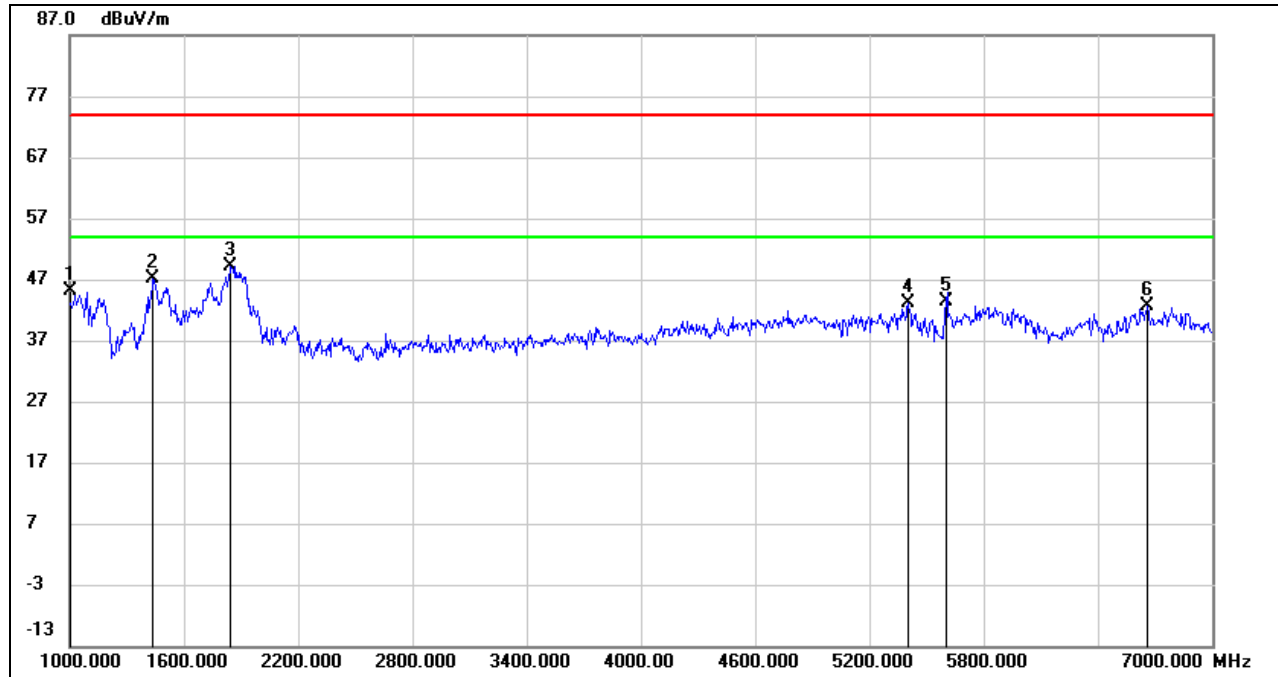

No.	Frequency (MHz)	Reading (dBuV)	Correct (dB/m)	Result (dBuV/m)	Limit (dBuV/m)	Margin (dB)	Remark
1	1000.0000	59.16	-13.98	45.18	74.00	-28.82	peak
2	1438.000	59.73	-12.52	47.21	74.00	-26.79	peak
3	1846.000	59.29	-10.09	49.20	74.00	-24.80	peak
4	5404.000	41.26	1.89	43.15	74.00	-30.85	peak
5	5600.000	40.80	2.46	43.26	74.00	-30.74	peak
6	6658.000	37.16	5.51	42.67	74.00	-31.33	peak

Note: 1. Measurement = Reading Level + Correct Factor.  
 2. If Peak Result complies with AV limit, AV Result is deemed to comply with AV limit.  
 3. Peak: Peak detector.  
 4. Filter losses were only considered in the spurious frequency bands and the authorized band was not corrected for Band reject filter losses.  
 5. Proper operation of the transmitter prior to adding the filter to the measurement chain.  
 6. Since non-restricted band peak emissions are less than the average limit, they also comply with the -27dBm/MHz (68.2dBuV/m) limit.



**HARMONICS AND SPURIOUS EMISSIONS (HIGH CHANNEL, HORIZONTAL)**

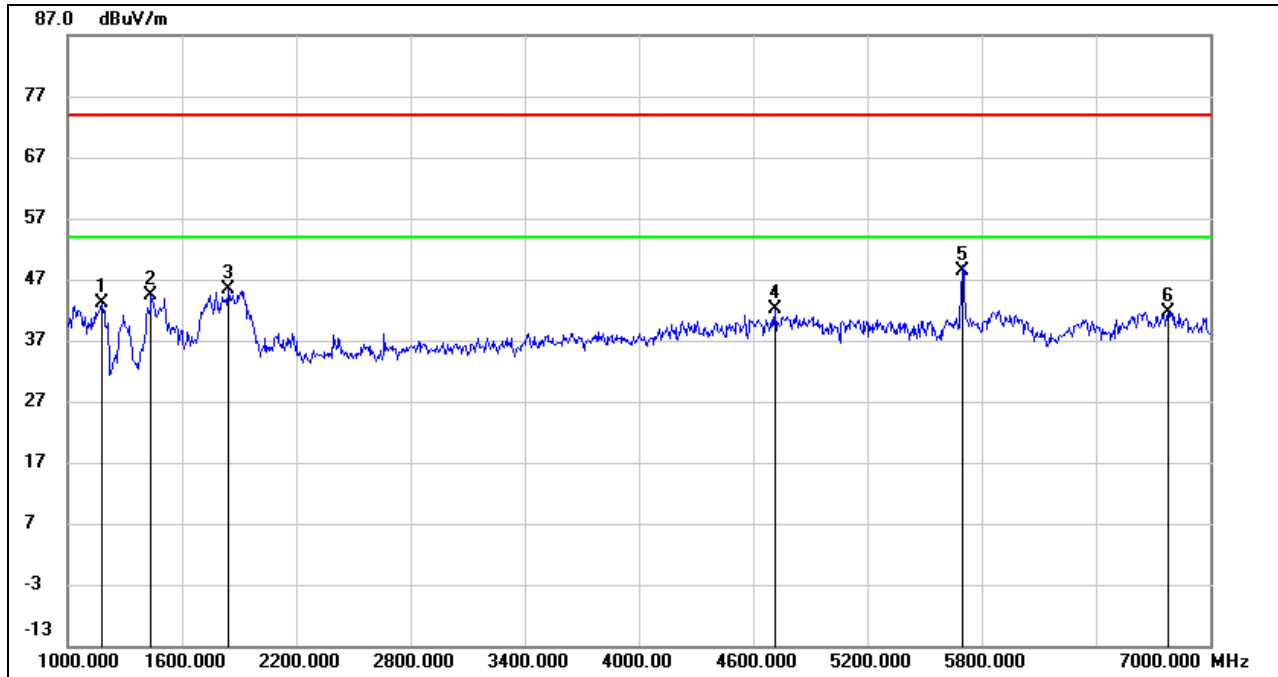

No.	Frequency (MHz)	Reading (dBuV)	Correct (dB/m)	Result (dBuV/m)	Limit (dBuV/m)	Margin (dB)	Remark
1	1180.000	56.35	-13.10	43.25	74.00	-30.75	peak
2	1438.000	56.79	-12.52	44.27	74.00	-29.73	peak
3	1846.000	55.46	-10.09	45.37	74.00	-28.63	peak
4	4714.000	41.95	0.09	42.04	74.00	-31.96	peak
5	5700.000	45.90	2.48	48.38	74.00	-25.62	peak
6	6778.000	36.01	5.56	41.57	74.00	-32.43	peak

Note: 1. Measurement = Reading Level + Correct Factor.  
 2. If Peak Result complies with AV limit, AV Result is deemed to comply with AV limit.  
 3. Peak: Peak detector.  
 4. Filter losses were only considered in the spurious frequency bands and the authorized band was not corrected for Band reject filter losses.  
 5. Proper operation of the transmitter prior to adding the filter to the measurement chain.  
 6. Since non-restricted band peak emissions are less than the average limit, they also comply with the -27dBm/MHz (68.2dBuV/m) limit.



**HARMONICS AND SPURIOUS EMISSIONS (HIGH CHANNEL, VERTICAL)**

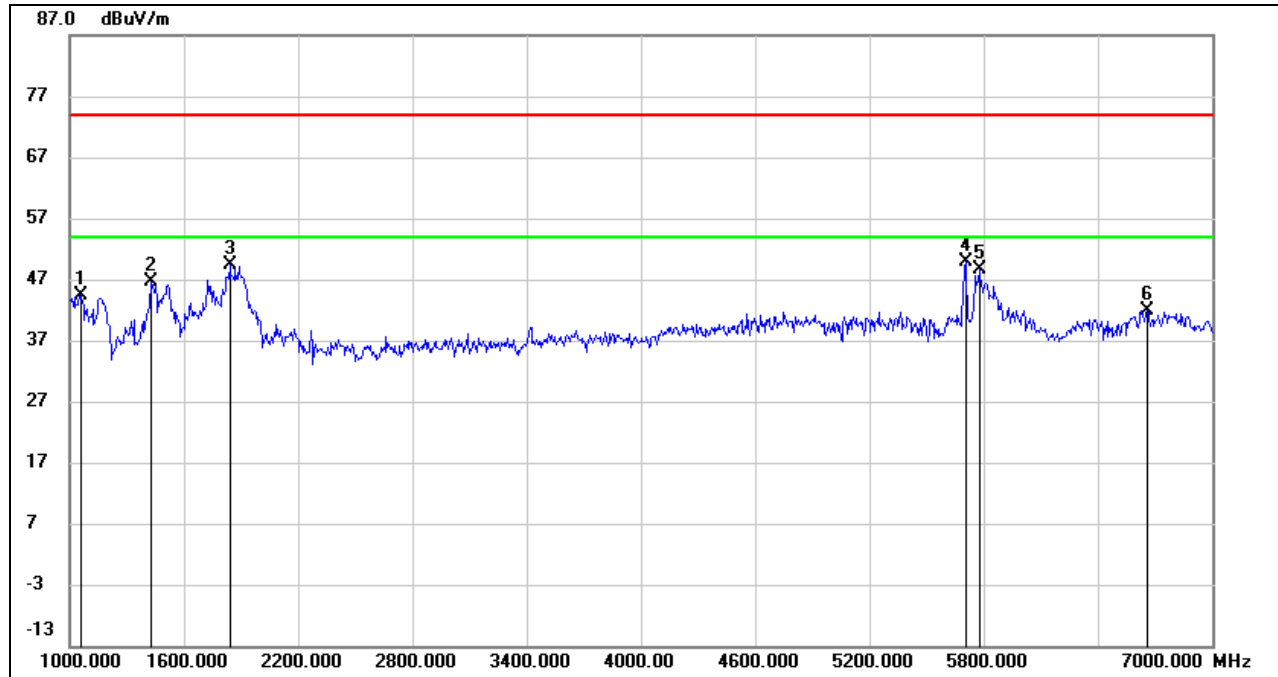

No.	Frequency (MHz)	Reading (dBuV)	Correct (dB/m)	Result (dBuV/m)	Limit (dBuV/m)	Margin (dB)	Remark
1	1060.000	58.13	-13.68	44.45	74.00	-29.55	peak
2	1426.000	59.12	-12.58	46.54	74.00	-27.46	peak
3	1840.000	59.45	-10.08	49.37	74.00	-24.63	peak
4	5700.000	47.28	2.48	49.76	74.00	-24.24	peak
5	5776.000	46.24	2.50	48.74	74.00	-25.26	peak
6	6658.000	36.46	5.51	41.97	74.00	-32.03	peak

Note: 1. Measurement = Reading Level + Correct Factor.  
 2. If Peak Result complies with AV limit, AV Result is deemed to comply with AV limit.  
 3. Peak: Peak detector.  
 4. Filter losses were only considered in the spurious frequency bands and the authorized band was not corrected for Band reject filter losses.  
 5. Proper operation of the transmitter prior to adding the filter to the measurement chain.  
 6. Since non-restricted band peak emissions are less than the average limit, they also comply with the -27dBm/MHz (68.2dBuV/m) limit.

**STRADDLE CHANNEL 144**

**HARMONICS AND SPURIOUS EMISSIONS (HORIZONTAL)**

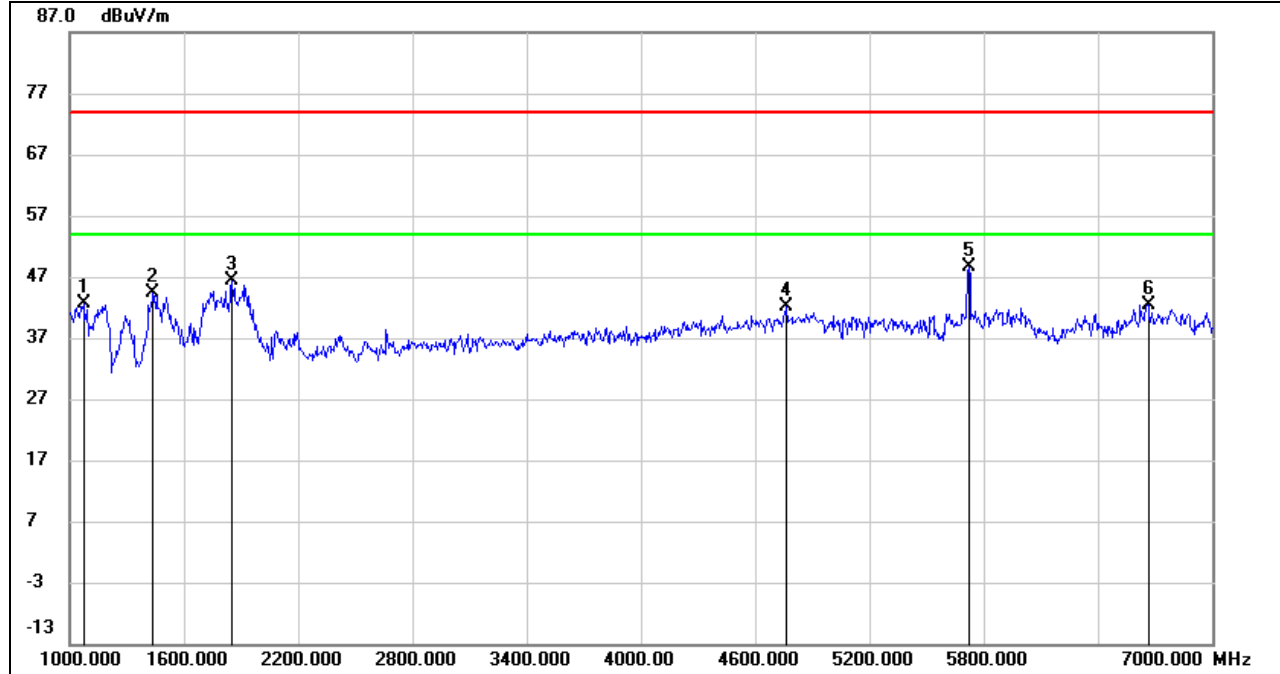

No.	Frequency (MHz)	Reading (dBuV)	Correct (dB/m)	Result (dBuV/m)	Limit (dBuV/m)	Margin (dB)	Remark
1	1072.000	56.20	-13.63	42.57	74.00	-31.43	peak
2	1438.000	56.79	-12.52	44.27	74.00	-29.73	peak
3	1852.000	56.49	-10.08	46.41	74.00	-27.59	peak
4	4762.000	41.85	0.38	42.23	74.00	-31.77	peak
5	5720.000	46.10	2.48	48.58	74.00	-25.42	peak
6	6664.000	36.97	5.53	42.50	74.00	-31.50	peak

Note: 1. Measurement = Reading Level + Correct Factor.  
 2. If Peak Result complies with AV limit, AV Result is deemed to comply with AV limit.  
 3. Peak: Peak detector.  
 4. Filter losses were only considered in the spurious frequency bands and the authorized band was not corrected for Band reject filter losses.  
 5. Proper operation of the transmitter prior to adding the filter to the measurement chain.  
 6. Since non-restricted band peak emissions are less than the average limit, they also comply with the -27dBm/MHz (68.2dBuV/m) limit.



**HARMONICS AND SPURIOUS EMISSIONS (VERTICAL)**

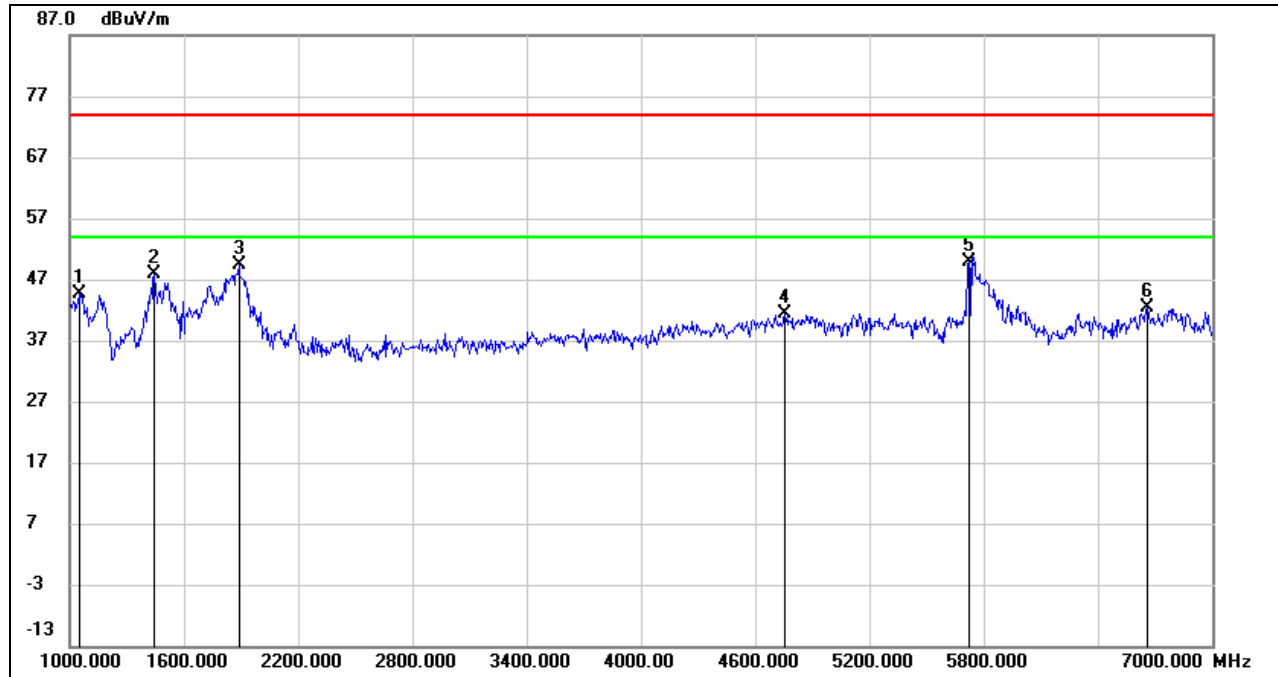

No.	Frequency (MHz)	Reading (dBuV)	Correct (dB/m)	Result (dBuV/m)	Limit (dBuV/m)	Margin (dB)	Remark
1	1048.000	58.29	-13.74	44.55	74.00	-29.45	peak
2	1444.000	60.47	-12.49	47.98	74.00	-26.02	peak
3	1888.000	59.50	-10.12	49.38	74.00	-24.62	peak
4	4756.000	41.12	0.33	41.45	74.00	-32.55	peak
5	5720.000	47.36	2.48	49.84	74.00	-24.16	peak
6	6658.000	36.78	5.51	42.29	74.00	-31.71	peak

Note: 1. Measurement = Reading Level + Correct Factor.  
 2. If Peak Result complies with AV limit, AV Result is deemed to comply with AV limit.  
 3. Peak: Peak detector.  
 4. Filter losses were only considered in the spurious frequency bands and the authorized band was not corrected for Band reject filter losses.  
 5. Proper operation of the transmitter prior to adding the filter to the measurement chain.  
 6. Since non-restricted band peak emissions are less than the average limit, they also comply with the -27dBm/MHz (68.2dBuV/m) limit.

**UNII-3 BAND**

**HARMONICS AND SPURIOUS EMISSIONS (LOW CHANNEL, HORIZONTAL)**

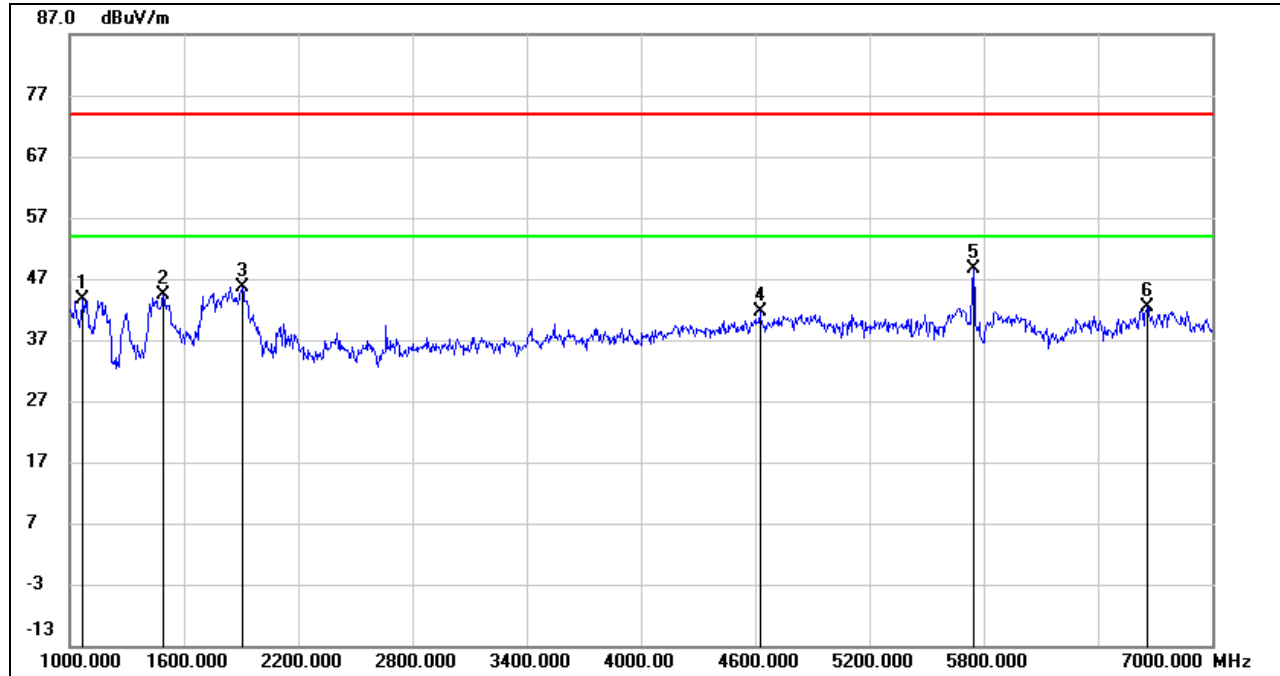

No.	Frequency (MHz)	Reading (dBuV)	Correct (dB/m)	Result (dBuV/m)	Limit (dBuV/m)	Margin (dB)	Remark
1	1066.000	57.33	-13.65	43.68	74.00	-30.32	peak
2	1492.000	56.53	-12.26	44.27	74.00	-29.73	peak
3	1906.000	55.81	-10.13	45.68	74.00	-28.32	peak
4	4624.000	42.10	-0.43	41.67	74.00	-32.33	peak
5	5745.000	46.02	2.49	48.51	74.00	-25.49	peak
6	6658.000	36.86	5.51	42.37	74.00	-31.63	peak

Note: 1. Measurement = Reading Level + Correct Factor.  
 2. If Peak Result complies with AV limit, AV Result is deemed to comply with AV limit.  
 3. Peak: Peak detector.  
 4. Filter losses were only considered in the spurious frequency bands and the authorized band was not corrected for Band reject filter losses.  
 5. Proper operation of the transmitter prior to adding the filter to the measurement chain.  
 6. Since non-restricted band peak emissions are less than the average limit, they also comply with the -27dBm/MHz (68.2dBuV/m) limit.

**HARMONICS AND SPURIOUS EMISSIONS (LOW CHANNEL, VERTICAL)**

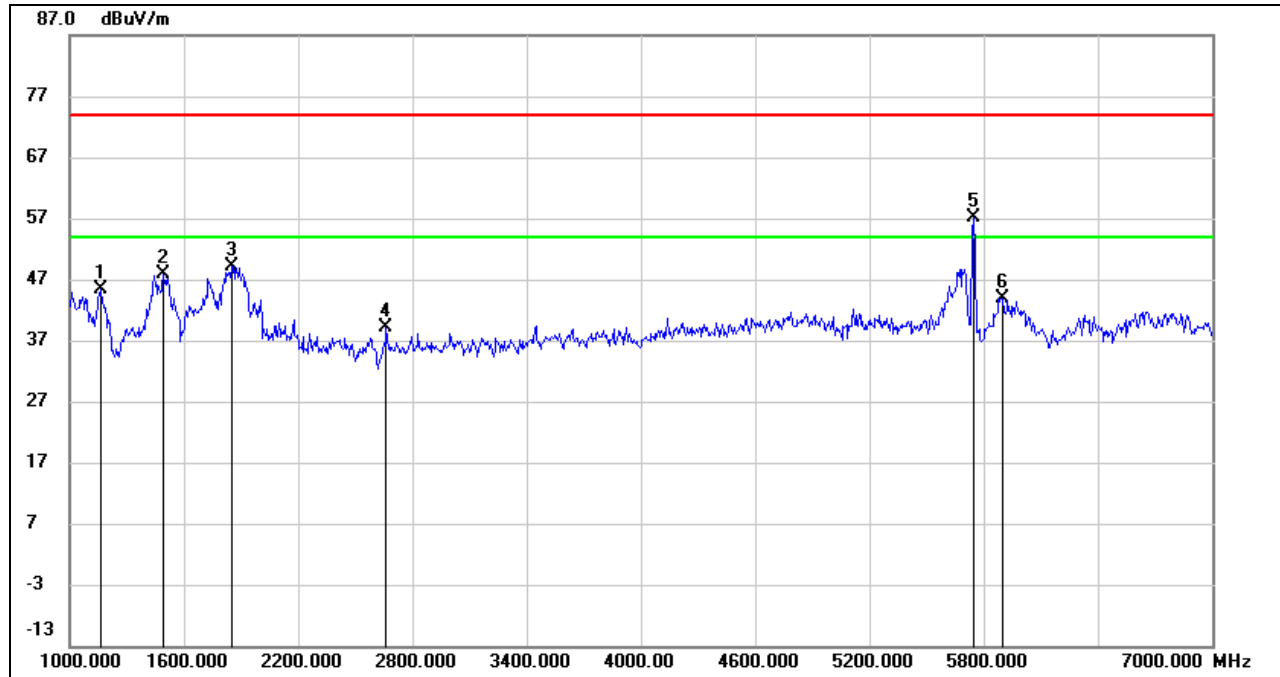

No.	Frequency (MHz)	Reading (dBuV)	Correct (dB/m)	Result (dBuV/m)	Limit (dBuV/m)	Margin (dB)	Remark
1	1162.000	58.51	-13.18	45.33	74.00	-28.67	peak
2	1492.000	60.19	-12.26	47.93	74.00	-26.07	peak
3	1852.000	59.10	-10.08	49.02	74.00	-24.98	peak
4	2662.000	46.55	-7.46	39.09	74.00	-34.91	peak
5*	5745.000	54.59	2.49	57.08	68.2	-11.12	peak
6	5896.000	41.05	2.90	43.95	74.00	-30.05	peak

Note: 1. Measurement = Reading Level + Correct Factor.  
 2. If Peak Result complies with AV limit, AV Result is deemed to comply with AV limit.  
 3. Peak: Peak detector.  
 4. Filter losses were only considered in the spurious frequency bands and the authorized band was not corrected for Band reject filter losses.  
 5. Proper operation of the transmitter prior to adding the filter to the measurement chain.  
 6. Since non-restricted band peak emissions are less than the average limit, they also comply with the -27dBm/MHz (68.2dBuV/m) limit.

**HARMONICS AND SPURIOUS EMISSIONS (MID CHANNEL, HORIZONTAL)**

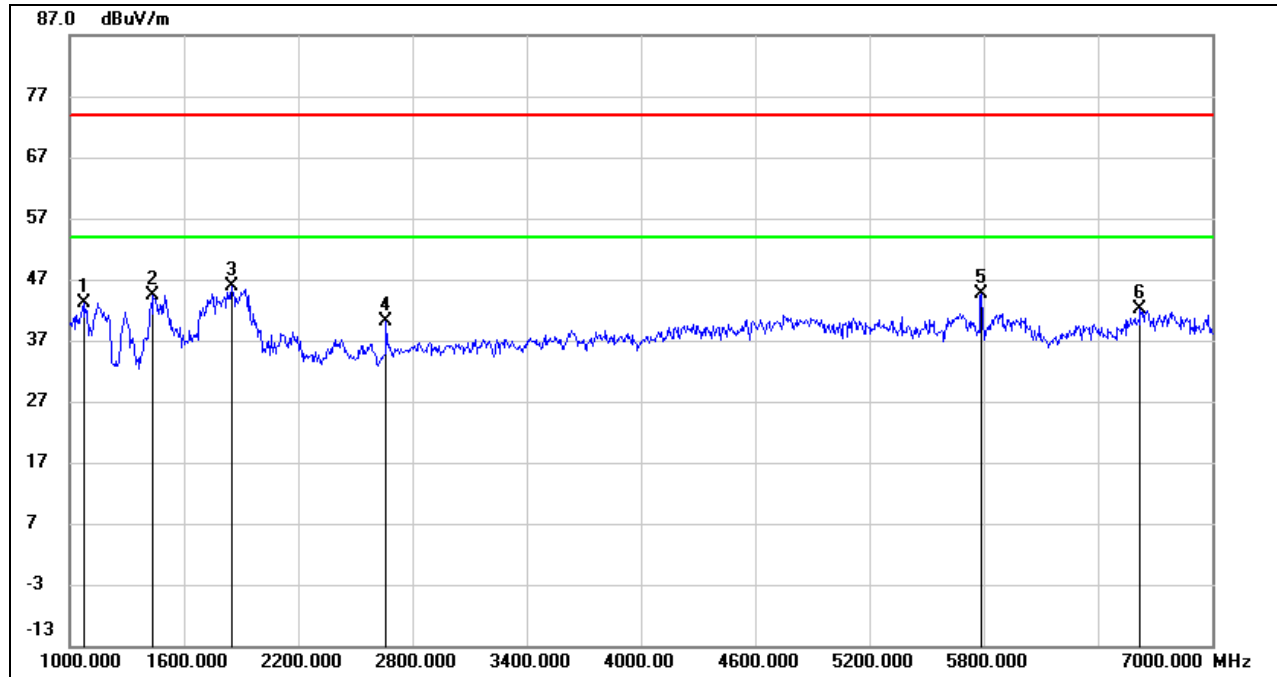

No.	Frequency (MHz)	Reading (dBuV)	Correct (dB/m)	Result (dBuV/m)	Limit (dBuV/m)	Margin (dB)	Remark
1	1072.000	56.75	-13.63	43.12	74.00	-30.88	peak
2	1438.000	56.88	-12.52	44.36	74.00	-29.64	peak
3	1852.000	55.88	-10.08	45.80	74.00	-28.20	peak
4	2662.000	47.65	-7.46	40.19	74.00	-33.81	peak
5	5785.000	42.06	2.50	44.56	74.00	-29.44	peak
6	6622.000	36.54	5.51	42.05	74.00	-31.95	peak

- Note: 1. Measurement = Reading Level + Correct Factor.  
 2. If Peak Result complies with AV limit, AV Result is deemed to comply with AV limit.  
 3. Peak: Peak detector.  
 4. Filter losses were only considered in the spurious frequency bands and the authorized band was not corrected for Band reject filter losses.  
 5. Proper operation of the transmitter prior to adding the filter to the measurement chain.  
 6. Since non-restricted band peak emissions are less than the average limit, they also comply with the -27dBm/MHz (68.2dBuV/m) limit.

**HARMONICS AND SPURIOUS EMISSIONS (MID CHANNEL, VERTICAL)**

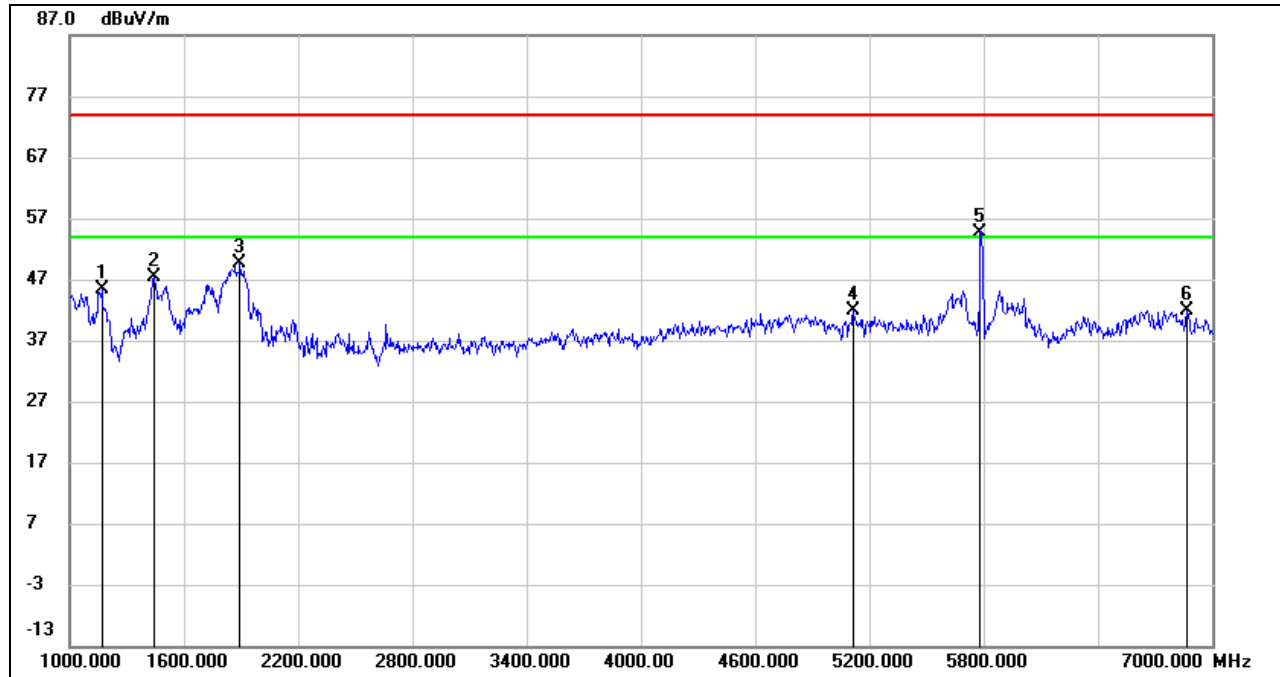

No.	Frequency (MHz)	Reading (dBuV)	Correct (dB/m)	Result (dBuV/m)	Limit (dBuV/m)	Margin (dB)	Remark
1	1168.000	58.53	-13.16	45.37	74.00	-28.63	peak
2	1444.000	59.94	-12.49	47.45	74.00	-26.55	peak
3	1894.000	59.73	-10.11	49.62	74.00	-24.38	peak
4	5116.000	40.36	1.60	41.96	74.00	-32.04	peak
5*	5785.000	52.25	2.50	54.75	68.2	-13.45	peak
6	6868.000	36.16	5.76	41.92	74.00	-32.08	peak

- Note: 1. Measurement = Reading Level + Correct Factor.  
 2. If Peak Result complies with AV limit, AV Result is deemed to comply with AV limit.  
 3. Peak: Peak detector.  
 4. Filter losses were only considered in the spurious frequency bands and the authorized band was not corrected for Band reject filter losses.  
 5. Proper operation of the transmitter prior to adding the filter to the measurement chain.  
 6. Since non-restricted band peak emissions are less than the average limit, they also comply with the -27dBm/MHz (68.2dBuV/m) limit.

**HARMONICS AND SPURIOUS EMISSIONS (HIGH CHANNEL, HORIZONTAL)**

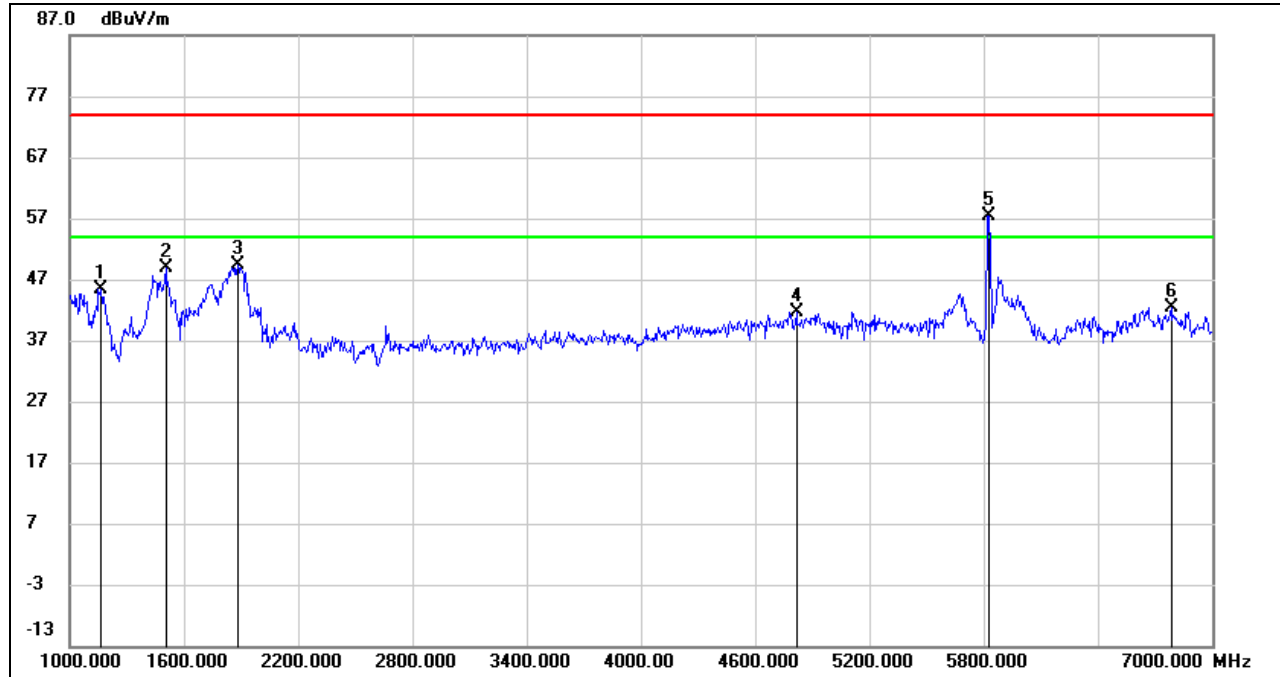

No.	Frequency (MHz)	Reading (dBuV)	Correct (dB/m)	Result (dBuV/m)	Limit (dBuV/m)	Margin (dB)	Remark
1	1162.000	58.57	-13.18	45.39	74.00	-28.61	peak
2	1504.000	60.99	-12.20	48.79	74.00	-25.21	peak
3	1882.000	59.52	-10.11	49.41	74.00	-24.59	peak
4	4816.000	41.01	0.62	41.63	74.00	-32.37	peak
5*	5825.000	54.71	2.61	57.32	68.2	-10.88	peak
6	6784.000	36.87	5.56	42.43	74.00	-31.57	peak

- Note: 1. Measurement = Reading Level + Correct Factor.  
 2. If Peak Result complies with AV limit, AV Result is deemed to comply with AV limit.  
 3. Peak: Peak detector.  
 4. Filter losses were only considered in the spurious frequency bands and the authorized band was not corrected for Band reject filter losses.  
 5. Proper operation of the transmitter prior to adding the filter to the measurement chain.  
 6. Since non-restricted band peak emissions are less than the average limit, they also comply with the -27dBm/MHz (68.2dBuV/m) limit.



**HARMONICS AND SPURIOUS EMISSIONS (HIGH CHANNEL, VERTICAL)**

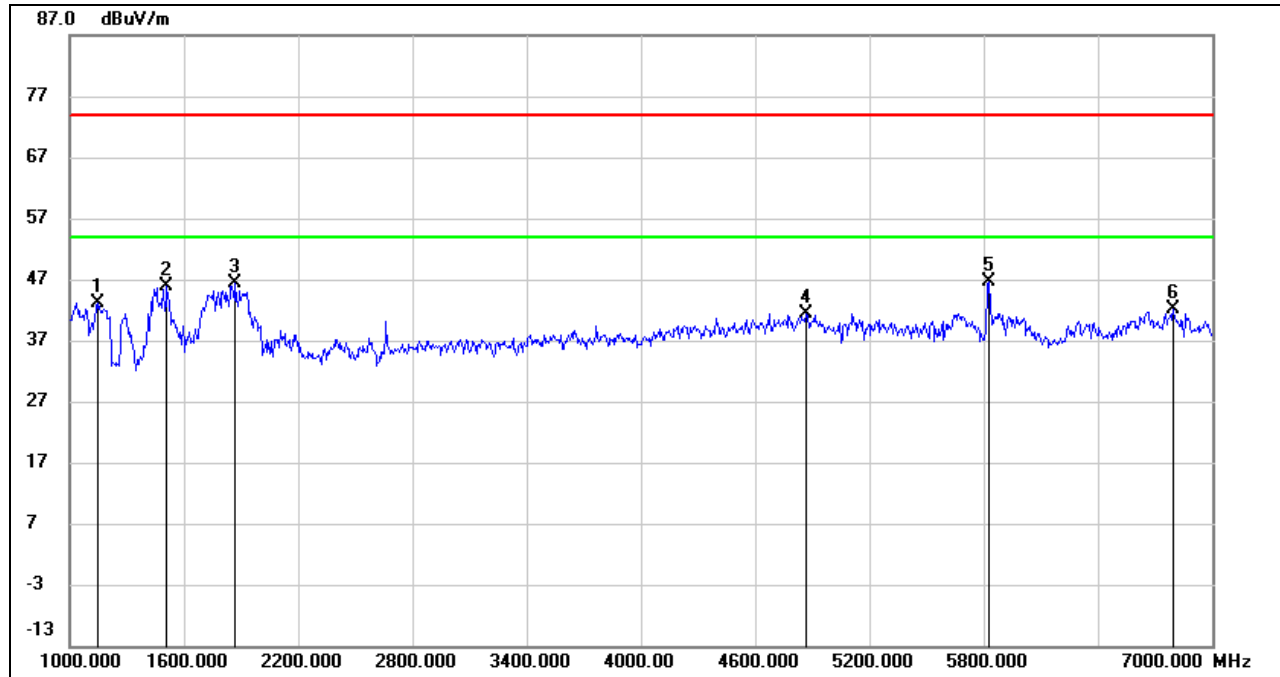

No.	Frequency (MHz)	Reading (dBuV)	Correct (dB/m)	Result (dBuV/m)	Limit (dBuV/m)	Margin (dB)	Remark
1	1144.000	56.43	-13.27	43.16	74.00	-30.84	peak
2	1510.000	57.93	-12.16	45.77	74.00	-28.23	peak
3	1870.000	56.37	-10.09	46.28	74.00	-27.72	peak
4	4870.000	40.80	0.69	41.49	74.00	-32.51	peak
5	5825.000	43.99	2.61	46.60	74.00	-27.40	peak
6	6796.000	36.45	5.57	42.02	74.00	-31.98	peak

- Note: 1. Measurement = Reading Level + Correct Factor.  
 2. If Peak Result complies with AV limit, AV Result is deemed to comply with AV limit.  
 3. Peak: Peak detector.  
 4. Filter losses were only considered in the spurious frequency bands and the authorized band was not corrected for Band reject filter losses.  
 5. Proper operation of the transmitter prior to adding the filter to the measurement chain.  
 6. Since non-restricted band peak emissions are less than the average limit, they also comply with the -27dBm/MHz (68.2dBuV/m) limit.

Note: All the modes and antennas had been tested, but only the worst data was recorded in the report.

### 8.3. SPURIOUS EMISSIONS (7 GHz ~ 18 GHz)

#### 8.3.1. 802.11a MODE

#### UNII-1 BAND

#### HARMONICS AND SPURIOUS EMISSIONS (LOW CHANNEL, HORIZONTAL)

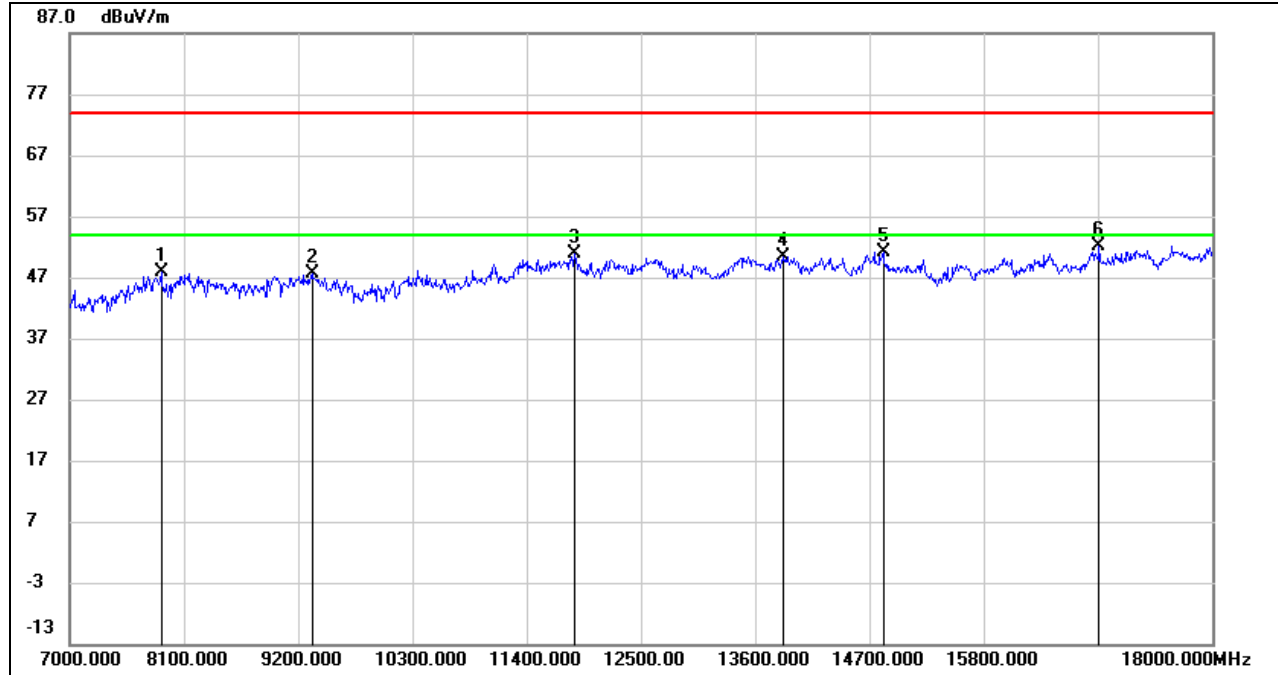

No.	Frequency (MHz)	Reading (dBuV)	Correct (dB/m)	Result (dBuV/m)	Limit (dBuV/m)	Margin (dB)	Remark
1	7880.000	38.81	8.95	47.76	74.00	-26.24	peak
2	9332.000	37.15	10.59	47.74	74.00	-26.26	peak
3	11862.000	35.51	15.41	50.92	74.00	-23.08	peak
4	13875.000	32.92	17.55	50.47	74.00	-23.53	peak
5	14832.000	33.28	17.83	51.11	74.00	-22.89	peak
6	16911.000	30.47	21.54	52.01	74.00	-21.99	peak

Note: 1. Measurement = Reading Level + Correct Factor.  
 2. If Peak Result complies with AV limit, AV Result is deemed to comply with AV limit.  
 3. Peak: Peak detector.  
 4. Filter losses were only considered in the spurious frequency bands and the authorized band was not corrected for High Pass Filter losses.  
 5. Proper operation of the transmitter prior to adding the filter to the measurement chain.  
 6. Since non-restricted band peak emissions are less than the average limit, they also comply with the -27dBm/MHz (68.2dBuV/m) limit.

**HARMONICS AND SPURIOUS EMISSIONS (LOW CHANNEL, VERTICAL)**

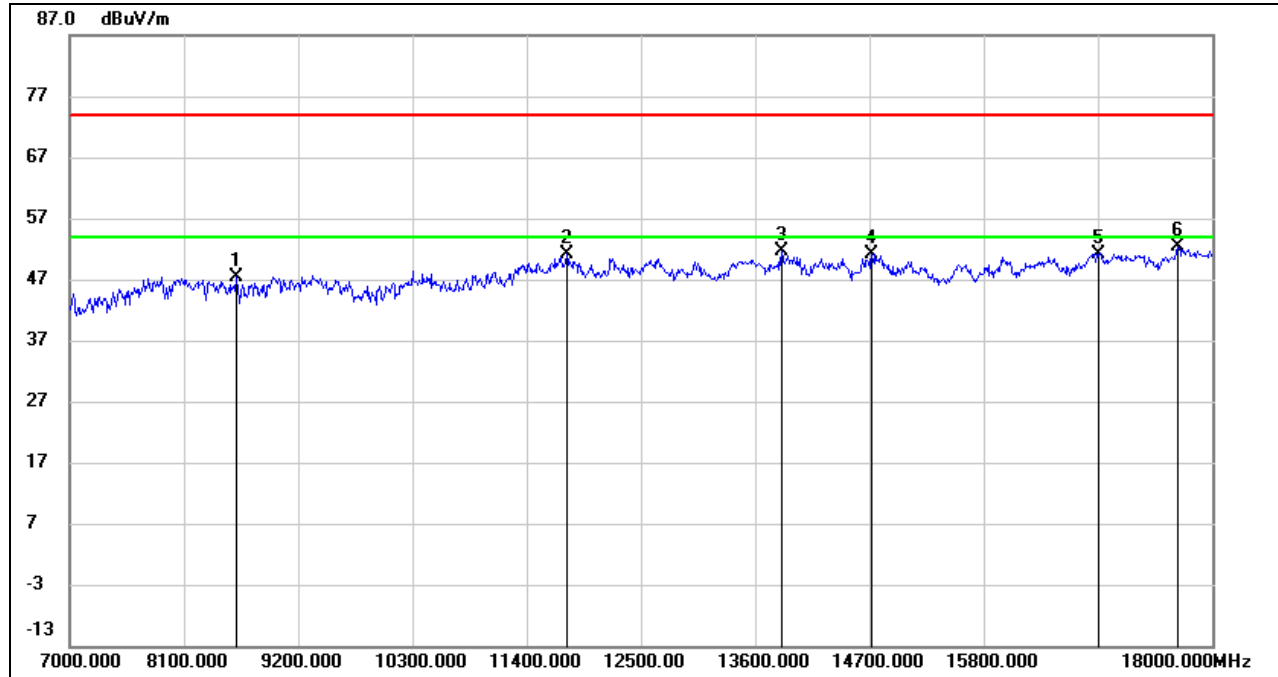

No.	Frequency (MHz)	Reading (dBuV)	Correct (dB/m)	Result (dBuV/m)	Limit (dBuV/m)	Margin (dB)	Remark
1	8606.000	38.23	9.16	47.39	74.00	-26.61	peak
2	11785.000	35.85	15.25	51.10	74.00	-22.90	peak
3	13853.000	34.04	17.56	51.60	74.00	-22.40	peak
4	14722.000	33.39	17.77	51.16	74.00	-22.84	peak
5	16911.000	29.70	21.54	51.24	74.00	-22.76	peak
6	17670.000	29.15	23.24	52.39	74.00	-21.61	peak

- Note: 1. Measurement = Reading Level + Correct Factor.  
 2. If Peak Result complies with AV limit, AV Result is deemed to comply with AV limit.  
 3. Peak: Peak detector.  
 4. Filter losses were only considered in the spurious frequency bands and the authorized band was not corrected for High Pass Filter losses.  
 5. Proper operation of the transmitter prior to adding the filter to the measurement chain.  
 6. Since non-restricted band peak emissions are less than the average limit, they also comply with the -27dBm/MHz (68.2dBuV/m) limit.

**HARMONICS AND SPURIOUS EMISSIONS (MID CHANNEL, HORIZONTAL)**

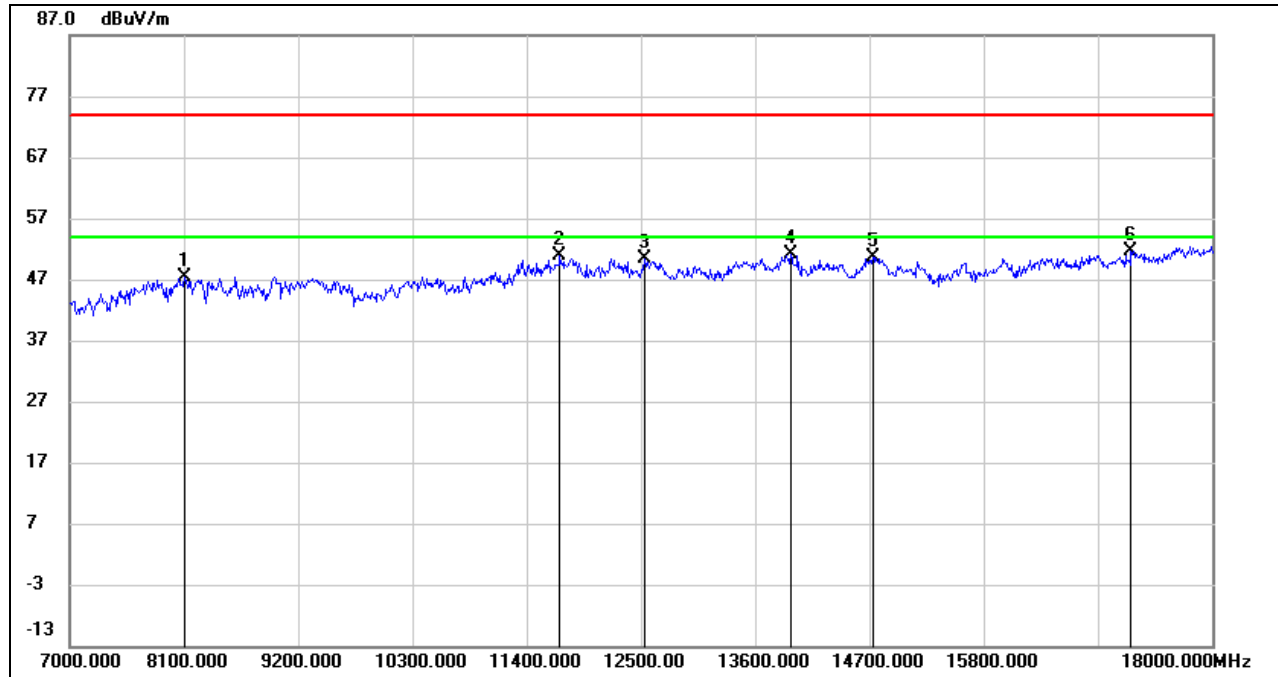

No.	Frequency (MHz)	Reading (dBuV)	Correct (dB/m)	Result (dBuV/m)	Limit (dBuV/m)	Margin (dB)	Remark
1	8100.000	37.21	10.18	47.39	74.00	-26.61	peak
2	11719.000	35.64	15.33	50.97	74.00	-23.03	peak
3	12533.000	34.74	15.71	50.45	74.00	-23.55	peak
4	13941.000	33.52	17.58	51.10	74.00	-22.90	peak
5	14733.000	32.91	17.81	50.72	74.00	-23.28	peak
6	17219.000	29.57	22.11	51.68	74.00	-22.32	peak

Note: 1. Measurement = Reading Level + Correct Factor.  
 2. If Peak Result complies with AV limit, AV Result is deemed to comply with AV limit.  
 3. Peak: Peak detector.  
 4. Filter losses were only considered in the spurious frequency bands and the authorized band was not corrected for High Pass Filter losses.  
 5. Proper operation of the transmitter prior to adding the filter to the measurement chain.  
 6. Since non-restricted band peak emissions are less than the average limit, they also comply with the -27dBm/MHz (68.2dBuV/m) limit.

**HARMONICS AND SPURIOUS EMISSIONS (MID CHANNEL, VERTICAL)**

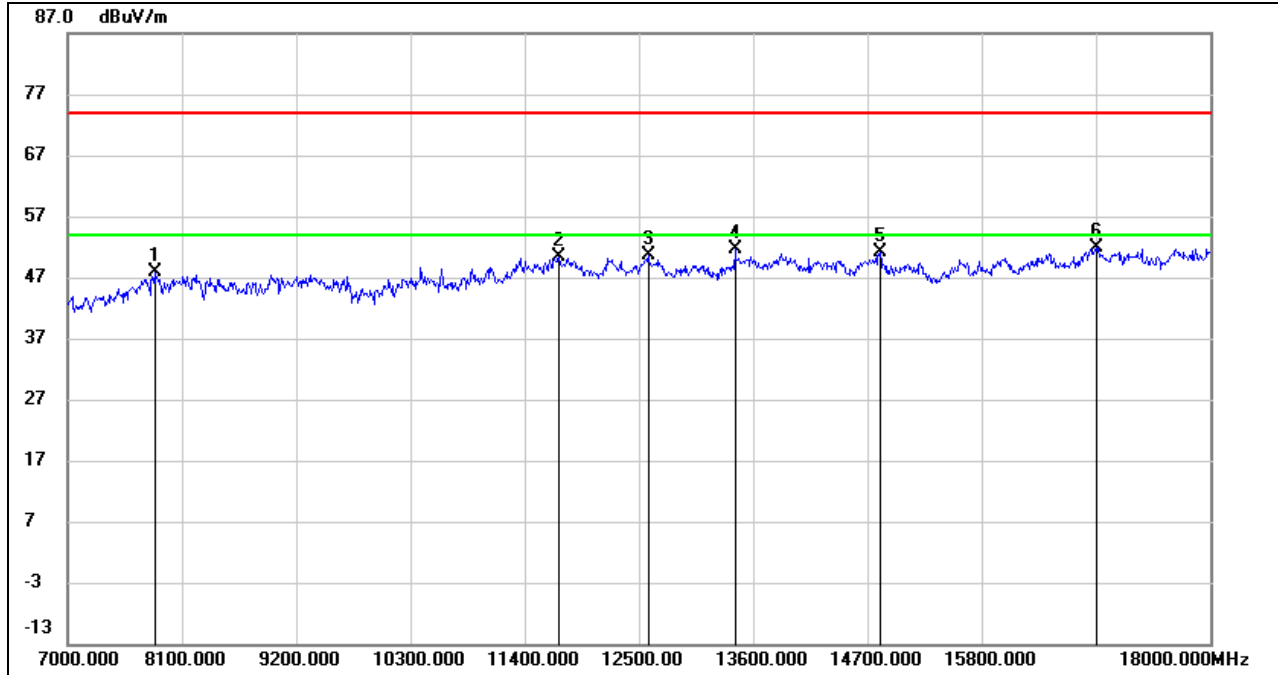

No.	Frequency (MHz)	Reading (dBuV)	Correct (dB/m)	Result (dBuV/m)	Limit (dBuV/m)	Margin (dB)	Remark
1	7836.000	38.78	9.17	47.95	74.00	-26.05	peak
2	11730.000	34.95	15.32	50.27	74.00	-23.73	peak
3	12588.000	34.96	15.76	50.72	74.00	-23.28	peak
4	13424.000	34.48	17.07	51.55	74.00	-22.45	peak
5	14821.000	33.12	17.90	51.02	74.00	-22.98	peak
6	16911.000	30.25	21.54	51.79	74.00	-22.21	peak

Note: 1. Measurement = Reading Level + Correct Factor.  
 2. If Peak Result complies with AV limit, AV Result is deemed to comply with AV limit.  
 3. Peak: Peak detector.  
 4. Filter losses were only considered in the spurious frequency bands and the authorized band was not corrected for High Pass Filter losses.  
 5. Proper operation of the transmitter prior to adding the filter to the measurement chain.  
 6. Since non-restricted band peak emissions are less than the average limit, they also comply with the -27dBm/MHz (68.2dBuV/m) limit.

**HARMONICS AND SPURIOUS EMISSIONS (HIGH CHANNEL, HORIZONTAL)**

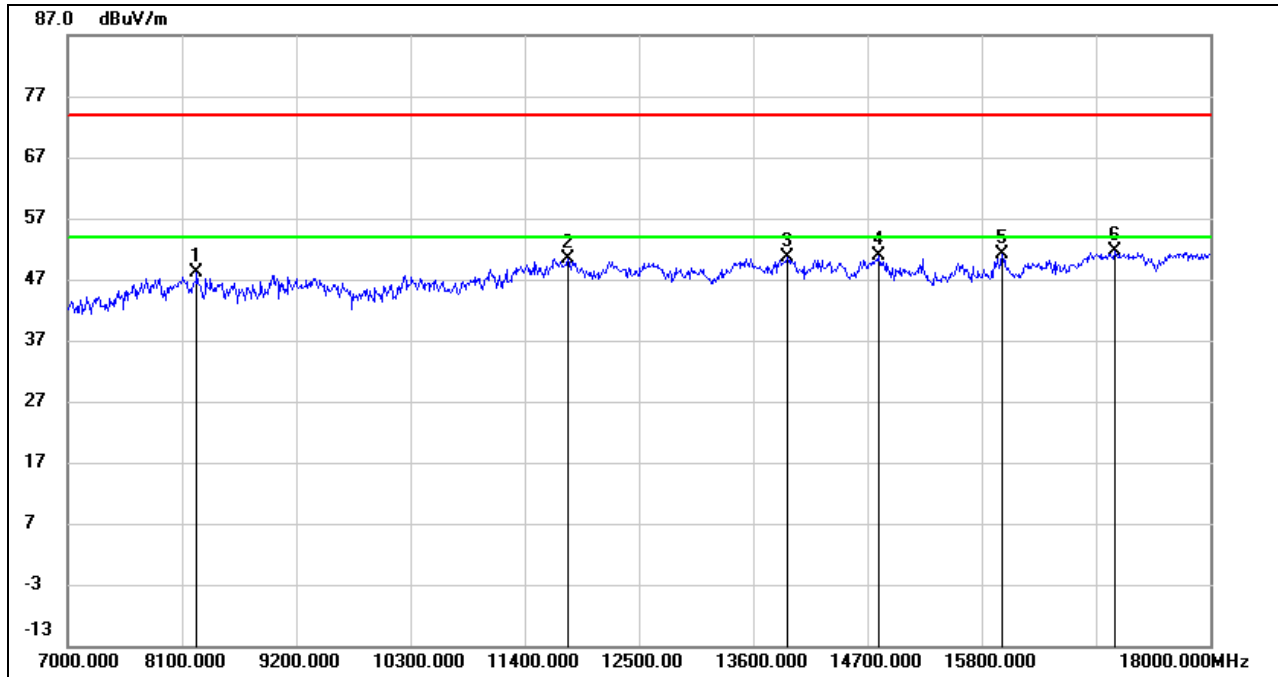

No.	Frequency (MHz)	Reading (dBuV)	Correct (dB/m)	Result (dBuV/m)	Limit (dBuV/m)	Margin (dB)	Remark
1	8243.000	38.29	9.76	48.05	74.00	-25.95	peak
2	11818.000	35.07	15.29	50.36	74.00	-23.64	peak
3	13930.000	33.11	17.57	50.68	74.00	-23.32	peak
4	14810.000	32.83	17.97	50.80	74.00	-23.20	peak
5	15998.000	32.74	18.42	51.16	74.00	-22.84	peak
6	17087.000	29.82	21.81	51.63	74.00	-22.37	peak

- Note: 1. Measurement = Reading Level + Correct Factor.  
 2. If Peak Result complies with AV limit, AV Result is deemed to comply with AV limit.  
 3. Peak: Peak detector.  
 4. Filter losses were only considered in the spurious frequency bands and the authorized band was not corrected for High Pass Filter losses.  
 5. Proper operation of the transmitter prior to adding the filter to the measurement chain.  
 6. Since non-restricted band peak emissions are less than the average limit, they also comply with the -27dBm/MHz (68.2dBuV/m) limit.



**HARMONICS AND SPURIOUS EMISSIONS (HIGH CHANNEL, VERTICAL)**

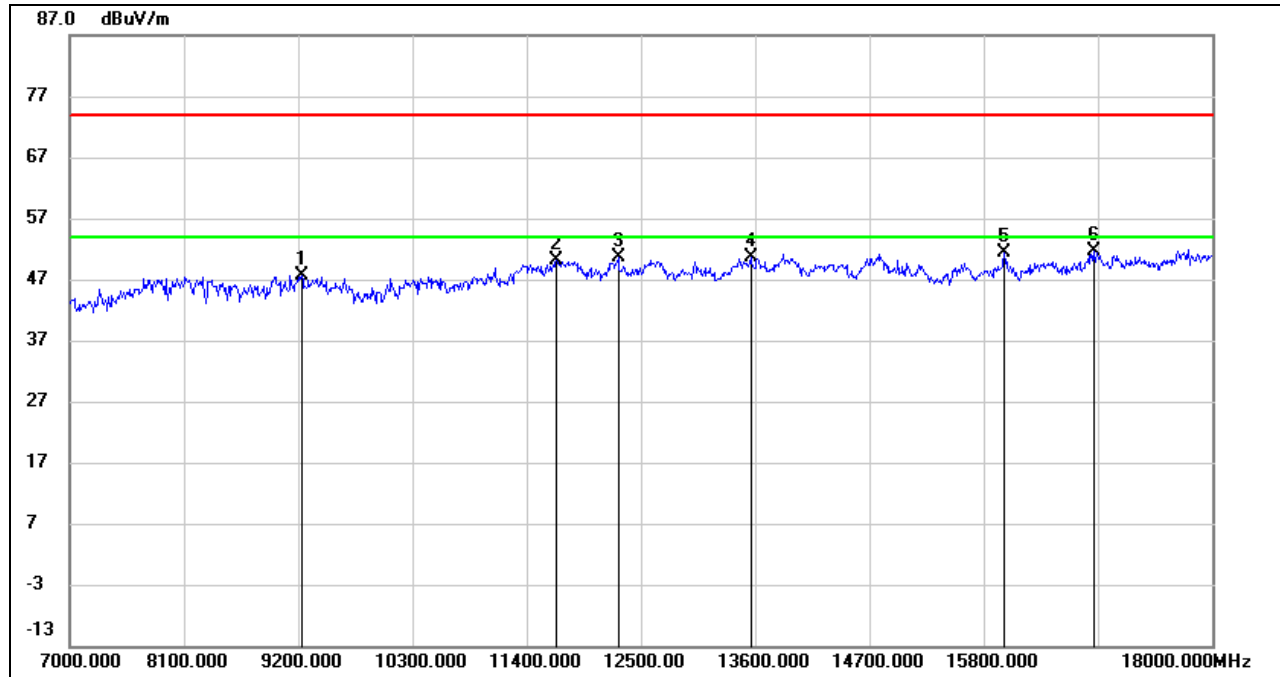

No.	Frequency (MHz)	Reading (dBuV)	Correct (dB/m)	Result (dBuV/m)	Limit (dBuV/m)	Margin (dB)	Remark
1	9233.000	37.54	10.08	47.62	74.00	-26.38	peak
2	11686.000	34.79	15.27	50.06	74.00	-23.94	peak
3	12280.000	34.46	16.07	50.53	74.00	-23.47	peak
4	13556.000	33.49	17.14	50.63	74.00	-23.37	peak
5	15998.000	32.85	18.42	51.27	74.00	-22.73	peak
6	16856.000	30.39	21.19	51.58	74.00	-22.42	peak

- Note: 1. Measurement = Reading Level + Correct Factor.  
 2. If Peak Result complies with AV limit, AV Result is deemed to comply with AV limit.  
 3. Peak: Peak detector.  
 4. Filter losses were only considered in the spurious frequency bands and the authorized band was not corrected for High Pass Filter losses.  
 5. Proper operation of the transmitter prior to adding the filter to the measurement chain.  
 6. Since non-restricted band peak emissions are less than the average limit, they also comply with the -27dBm/MHz (68.2dBuV/m) limit.



**UNII-2A BAND**

**HARMONICS AND SPURIOUS EMISSIONS (LOW CHANNEL, HORIZONTAL)**

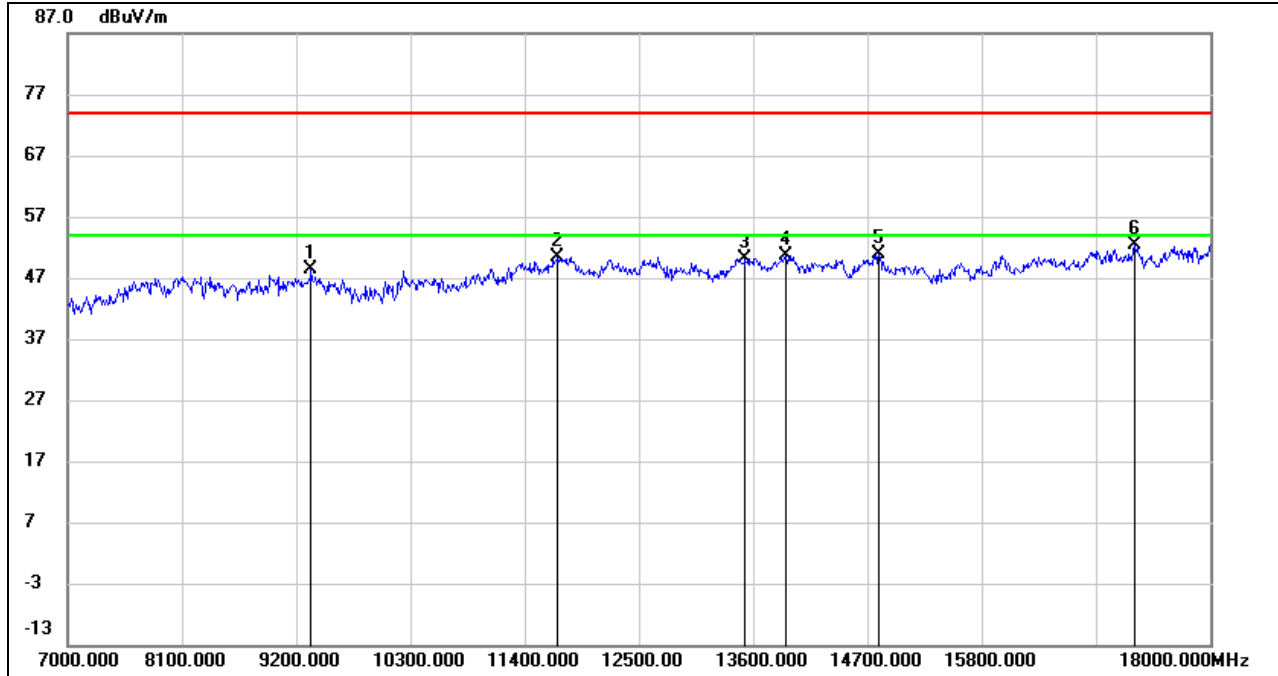

No.	Frequency (MHz)	Reading (dBuV)	Correct (dB/m)	Result (dBuV/m)	Limit (dBuV/m)	Margin (dB)	Remark
1	9343.000	37.82	10.64	48.46	74.00	-25.54	peak
2	11719.000	34.98	15.33	50.31	74.00	-23.69	peak
3	13523.000	33.04	17.19	50.23	74.00	-23.77	peak
4	13908.000	33.11	17.54	50.65	74.00	-23.35	peak
5	14810.000	32.89	17.97	50.86	74.00	-23.14	peak
6	17274.000	29.85	22.45	52.30	74.00	-21.70	peak

Note: 1. Measurement = Reading Level + Correct Factor.  
 2. If Peak Result complies with AV limit, AV Result is deemed to comply with AV limit.  
 3. Peak: Peak detector.  
 4. Filter losses were only considered in the spurious frequency bands and the authorized band was not corrected for High Pass Filter losses.  
 5. Proper operation of the transmitter prior to adding the filter to the measurement chain.  
 6. Since non-restricted band peak emissions are less than the average limit, they also comply with the -27dBm/MHz (68.2dBuV/m) limit.



**HARMONICS AND SPURIOUS EMISSIONS (LOW CHANNEL, VERTICAL)**



No.	Frequency (MHz)	Reading (dBuV)	Correct (dB/m)	Result (dBuV/m)	Limit (dBuV/m)	Margin (dB)	Remark
1	7880.000	38.77	8.95	47.72	74.00	-26.28	peak
2	11840.000	35.23	15.35	50.58	74.00	-23.42	peak
3	12214.000	34.90	15.97	50.87	74.00	-23.13	peak
4	13908.000	32.88	17.54	50.42	74.00	-23.58	peak
5	14810.000	33.01	17.97	50.98	74.00	-23.02	peak
6	16834.000	31.05	21.00	52.05	74.00	-21.95	peak

Note: 1. Measurement = Reading Level + Correct Factor.  
 2. If Peak Result complies with AV limit, AV Result is deemed to comply with AV limit.  
 3. Peak: Peak detector.  
 4. Filter losses were only considered in the spurious frequency bands and the authorized band was not corrected for High Pass Filter losses.  
 5. Proper operation of the transmitter prior to adding the filter to the measurement chain.  
 6. Since non-restricted band peak emissions are less than the average limit, they also comply with the -27dBm/MHz (68.2dBuV/m) limit.

**HARMONICS AND SPURIOUS EMISSIONS (MID CHANNEL, HORIZONTAL)**

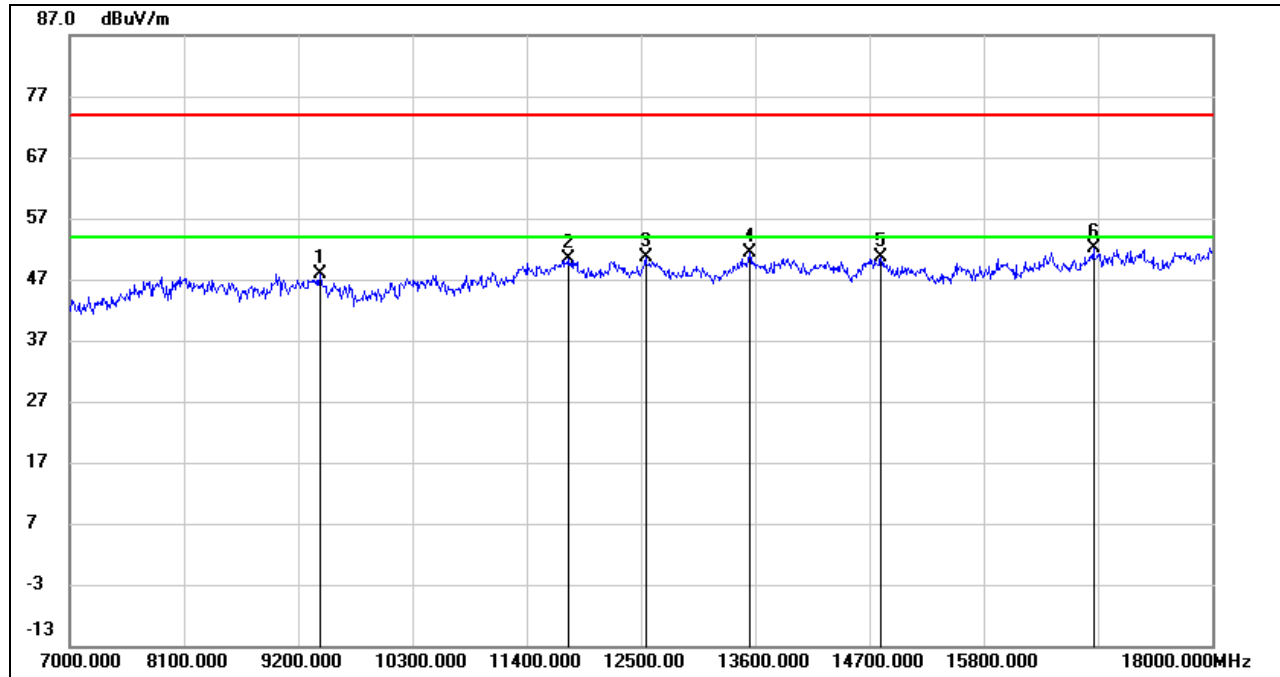

No.	Frequency (MHz)	Reading (dBuV)	Correct (dB/m)	Result (dBuV/m)	Limit (dBuV/m)	Margin (dB)	Remark
1	9409.000	37.03	10.94	47.97	74.00	-26.03	peak
2	11807.000	35.04	15.27	50.31	74.00	-23.69	peak
3	12544.000	34.94	15.72	50.66	74.00	-23.34	peak
4	13545.000	34.12	17.16	51.28	74.00	-22.72	peak
5	14810.000	32.74	17.97	50.71	74.00	-23.29	peak
6	16856.000	30.98	21.19	52.17	74.00	-21.83	peak

Note: 1. Measurement = Reading Level + Correct Factor.  
 2. If Peak Result complies with AV limit, AV Result is deemed to comply with AV limit.  
 3. Peak: Peak detector.  
 4. Filter losses were only considered in the spurious frequency bands and the authorized band was not corrected for High Pass Filter losses.  
 5. Proper operation of the transmitter prior to adding the filter to the measurement chain.  
 6. Since non-restricted band peak emissions are less than the average limit, they also comply with the -27dBm/MHz (68.2dBuV/m) limit.

**HARMONICS AND SPURIOUS EMISSIONS (MID CHANNEL, VERTICAL)**

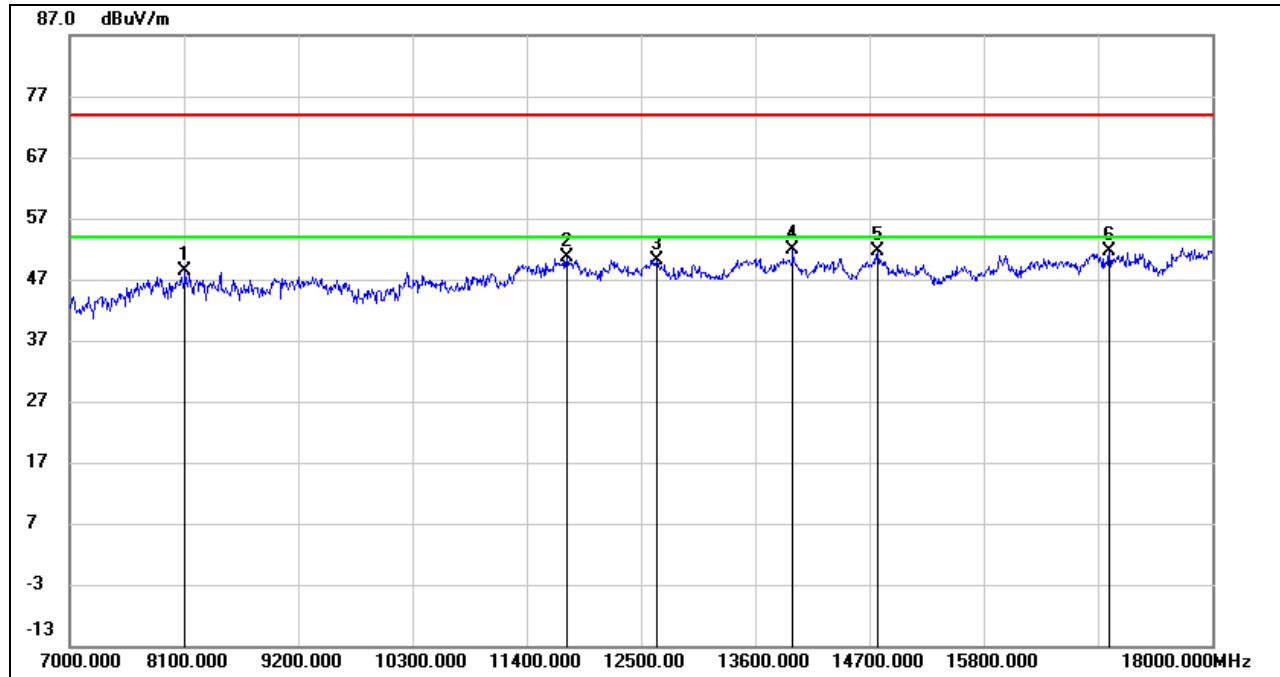

No.	Frequency (MHz)	Reading (dBuV)	Correct (dB/m)	Result (dBuV/m)	Limit (dBuV/m)	Margin (dB)	Remark
1	8111.000	38.30	10.14	48.44	74.00	-25.56	peak
2	11785.000	35.30	15.25	50.55	74.00	-23.45	peak
3	12654.000	34.56	15.69	50.25	74.00	-23.75	peak
4	13963.000	34.22	17.61	51.83	74.00	-22.17	peak
5	14777.000	33.72	17.96	51.68	74.00	-22.32	peak
6	17010.000	30.40	21.31	51.71	74.00	-22.29	peak

Note: 1. Measurement = Reading Level + Correct Factor.  
 2. If Peak Result complies with AV limit, AV Result is deemed to comply with AV limit.  
 3. Peak: Peak detector.  
 4. Filter losses were only considered in the spurious frequency bands and the authorized band was not corrected for High Pass Filter losses.  
 5. Proper operation of the transmitter prior to adding the filter to the measurement chain.  
 6. Since non-restricted band peak emissions are less than the average limit, they also comply with the -27dBm/MHz (68.2dBuV/m) limit.

**HARMONICS AND SPURIOUS EMISSIONS (HIGH CHANNEL, HORIZONTAL)**

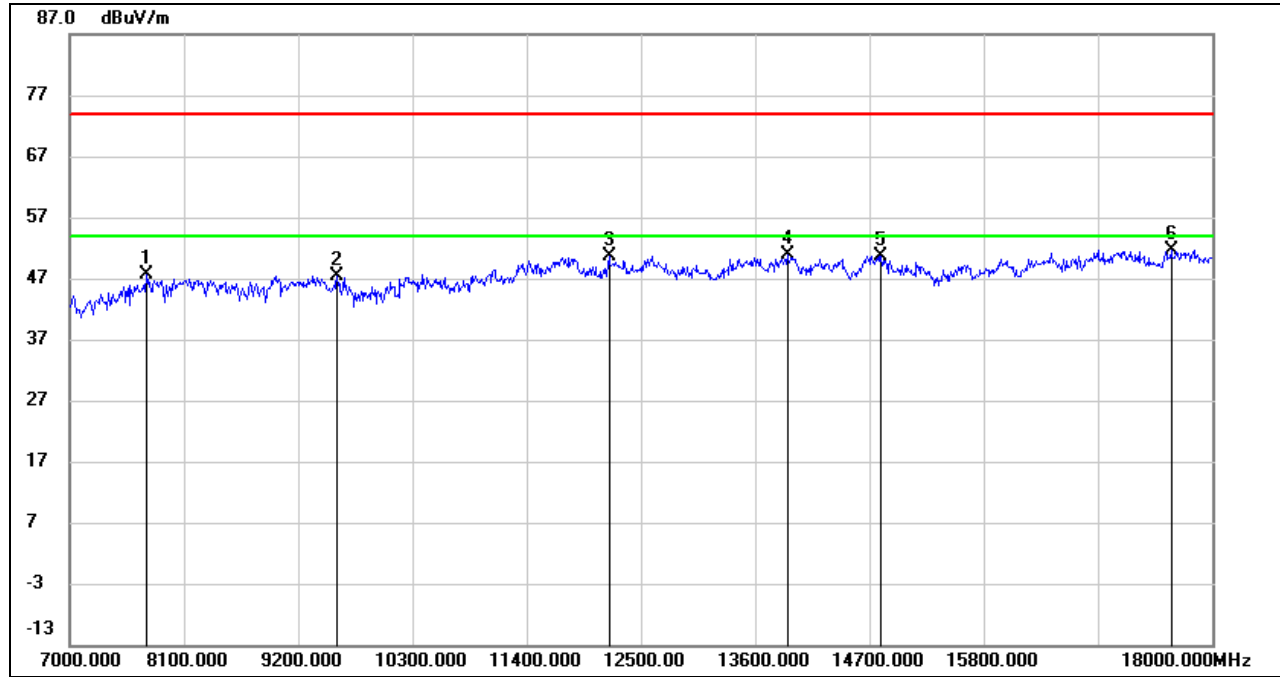

No.	Frequency (MHz)	Reading (dBuV)	Correct (dB/m)	Result (dBuV/m)	Limit (dBuV/m)	Margin (dB)	Remark
1	7737.000	38.78	8.78	47.56	74.00	-26.44	peak
2	9574.000	36.57	10.90	47.47	74.00	-26.53	peak
3	12192.000	34.69	15.91	50.60	74.00	-23.40	peak
4	13908.000	33.39	17.54	50.93	74.00	-23.07	peak
5	14810.000	32.71	17.97	50.68	74.00	-23.32	peak
6	17604.000	28.85	22.76	51.61	74.00	-22.39	peak

Note: 1. Measurement = Reading Level + Correct Factor.  
 2. If Peak Result complies with AV limit, AV Result is deemed to comply with AV limit.  
 3. Peak: Peak detector.  
 4. Filter losses were only considered in the spurious frequency bands and the authorized band was not corrected for High Pass Filter losses.  
 5. Proper operation of the transmitter prior to adding the filter to the measurement chain.  
 6. Since non-restricted band peak emissions are less than the average limit, they also comply with the -27dBm/MHz (68.2dBuV/m) limit.



**HARMONICS AND SPURIOUS EMISSIONS (HIGH CHANNEL, VERTICAL)**

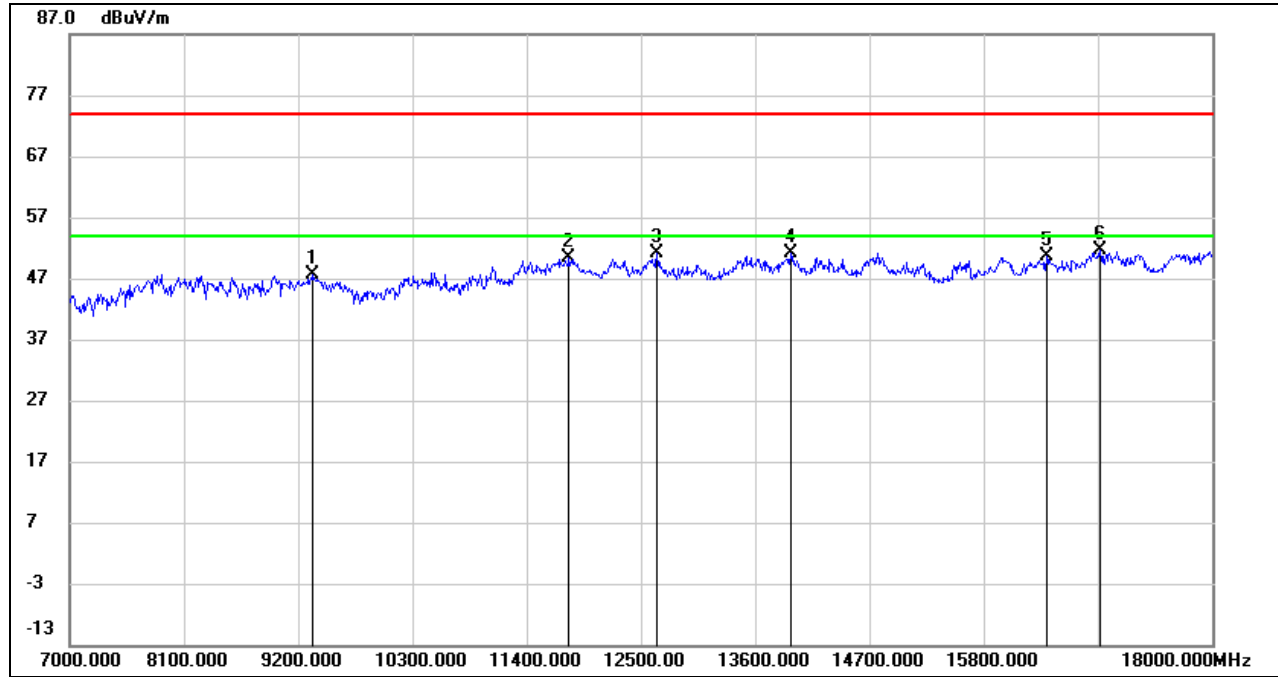

No.	Frequency (MHz)	Reading (dBuV)	Correct (dB/m)	Result (dBuV/m)	Limit (dBuV/m)	Margin (dB)	Remark
1	9343.000	37.06	10.64	47.70	74.00	-26.30	peak
2	11807.000	35.21	15.27	50.48	74.00	-23.52	peak
3	12654.000	35.42	15.69	51.11	74.00	-22.89	peak
4	13941.000	33.49	17.58	51.07	74.00	-22.93	peak
5	16405.000	30.99	19.68	50.67	74.00	-23.33	peak
6	16922.000	30.24	21.49	51.73	74.00	-22.27	peak

Note: 1. Measurement = Reading Level + Correct Factor.  
 2. If Peak Result complies with AV limit, AV Result is deemed to comply with AV limit.  
 3. Peak: Peak detector.  
 4. Filter losses were only considered in the spurious frequency bands and the authorized band was not corrected for High Pass Filter losses.  
 5. Proper operation of the transmitter prior to adding the filter to the measurement chain.  
 6. Since non-restricted band peak emissions are less than the average limit, they also comply with the -27dBm/MHz (68.2dBuV/m) limit.

**UNII-2C BAND**

**HARMONICS AND SPURIOUS EMISSIONS (LOW CHANNEL, HORIZONTAL)**

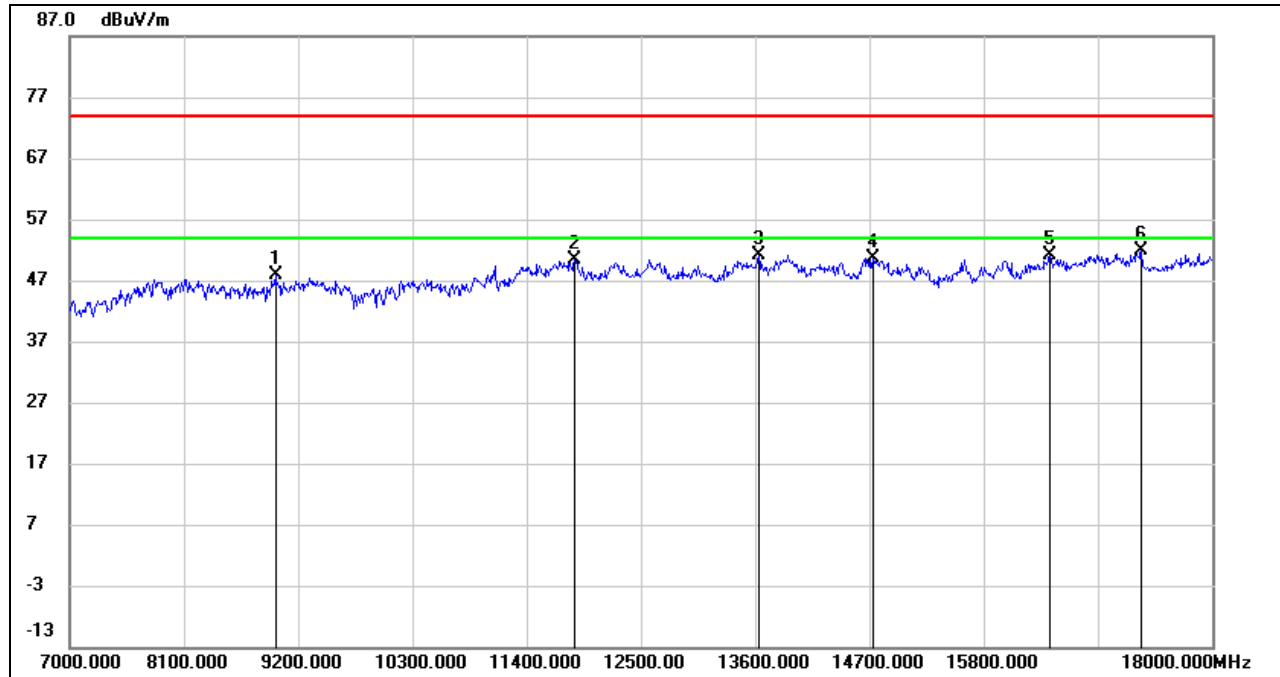

No.	Frequency (MHz)	Reading (dBuV)	Correct (dB/m)	Result (dBuV/m)	Limit (dBuV/m)	Margin (dB)	Remark
1	8980.000	37.10	10.89	47.99	74.00	-26.01	peak
2	11862.000	34.88	15.41	50.29	74.00	-23.71	peak
3	13633.000	33.82	17.26	51.08	74.00	-22.92	peak
4	14733.000	32.72	17.81	50.53	74.00	-23.47	peak
5	16438.000	31.39	19.68	51.07	74.00	-22.93	peak
6	17318.000	29.31	22.47	51.78	74.00	-22.22	peak

Note: 1. Measurement = Reading Level + Correct Factor.  
 2. If Peak Result complies with AV limit, AV Result is deemed to comply with AV limit.  
 3. Peak: Peak detector.  
 4. Filter losses were only considered in the spurious frequency bands and the authorized band was not corrected for High Pass Filter losses.  
 5. Proper operation of the transmitter prior to adding the filter to the measurement chain.  
 6. Since non-restricted band peak emissions are less than the average limit, they also comply with the -27dBm/MHz (68.2dBuV/m) limit.

**HARMONICS AND SPURIOUS EMISSIONS (LOW CHANNEL, VERTICAL)**

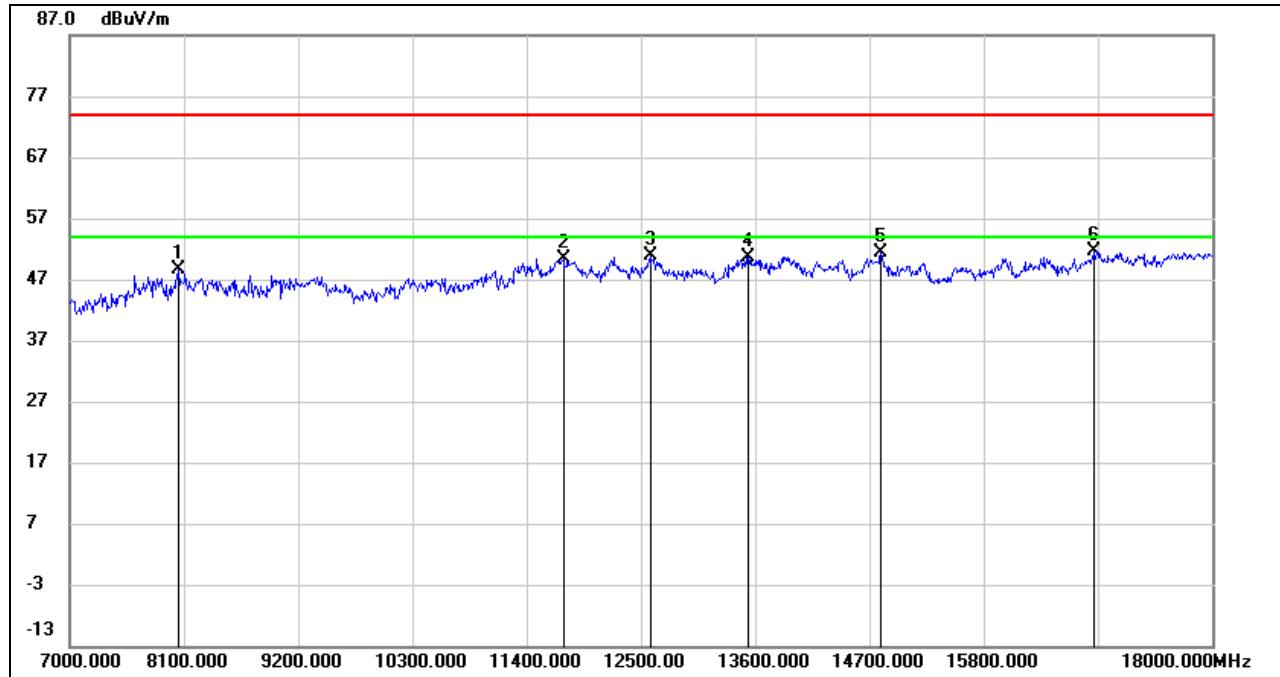

No.	Frequency (MHz)	Reading (dBuV)	Correct (dB/m)	Result (dBuV/m)	Limit (dBuV/m)	Margin (dB)	Remark
1	8045.000	39.35	9.33	48.68	74.00	-25.32	peak
2	11752.000	35.08	15.29	50.37	74.00	-23.63	peak
3	12588.000	35.12	15.76	50.88	74.00	-23.12	peak
4	13534.000	33.53	17.18	50.71	74.00	-23.29	peak
5	14810.000	33.49	17.97	51.46	74.00	-22.54	peak
6	16867.000	30.38	21.29	51.67	74.00	-22.33	peak

Note: 1. Measurement = Reading Level + Correct Factor.  
 2. If Peak Result complies with AV limit, AV Result is deemed to comply with AV limit.  
 3. Peak: Peak detector.  
 4. Filter losses were only considered in the spurious frequency bands and the authorized band was not corrected for High Pass Filter losses.  
 5. Proper operation of the transmitter prior to adding the filter to the measurement chain.  
 6. Since non-restricted band peak emissions are less than the average limit, they also comply with the -27dBm/MHz (68.2dBuV/m) limit.

**HARMONICS AND SPURIOUS EMISSIONS (MID CHANNEL, HORIZONTAL)**

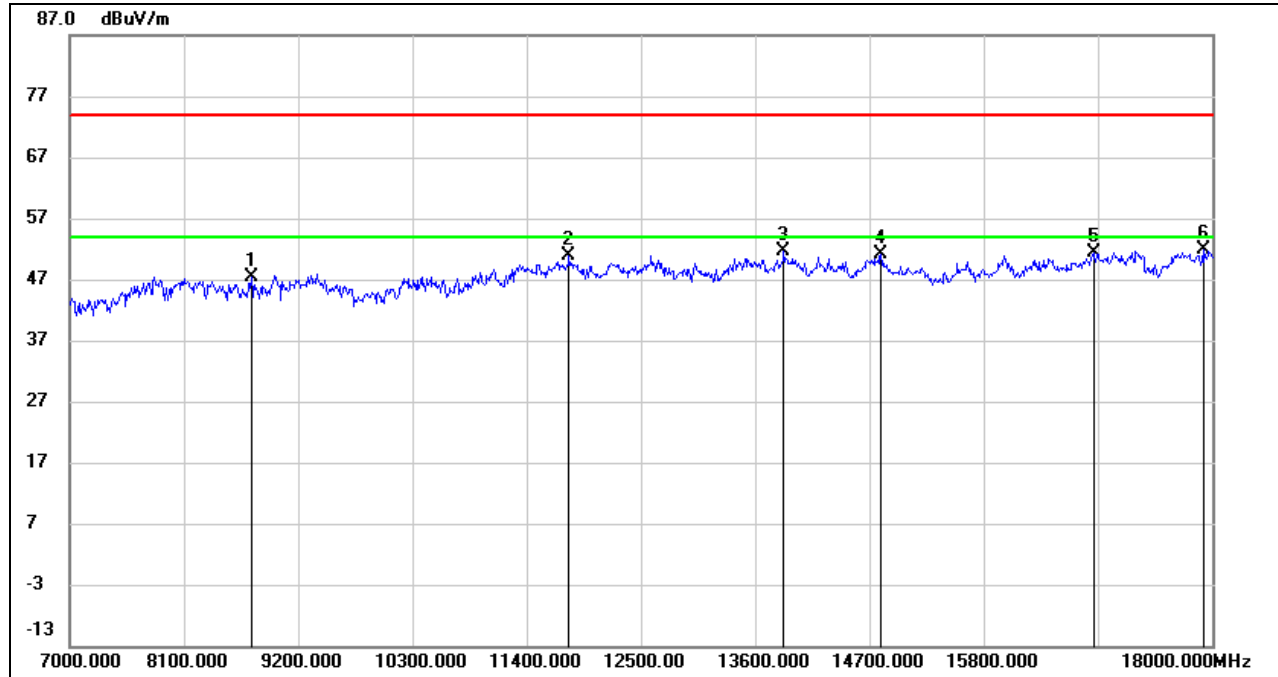

No.	Frequency (MHz)	Reading (dBuV)	Correct (dB/m)	Result (dBuV/m)	Limit (dBuV/m)	Margin (dB)	Remark
1	8749.000	38.14	9.14	47.28	74.00	-26.72	peak
2	11807.000	35.50	15.27	50.77	74.00	-23.23	peak
3	13875.000	33.97	17.55	51.52	74.00	-22.48	peak
4	14810.000	33.26	17.97	51.23	74.00	-22.77	peak
5	16856.000	30.29	21.19	51.48	74.00	-22.52	peak
6	17912.000	27.90	23.94	51.84	74.00	-22.16	peak

Note: 1. Measurement = Reading Level + Correct Factor.  
 2. If Peak Result complies with AV limit, AV Result is deemed to comply with AV limit.  
 3. Peak: Peak detector.  
 4. Filter losses were only considered in the spurious frequency bands and the authorized band was not corrected for High Pass Filter losses.  
 5. Proper operation of the transmitter prior to adding the filter to the measurement chain.  
 6. Since non-restricted band peak emissions are less than the average limit, they also comply with the -27dBm/MHz (68.2dBuV/m) limit.



**HARMONICS AND SPURIOUS EMISSIONS (MID CHANNEL, VERTICAL)**

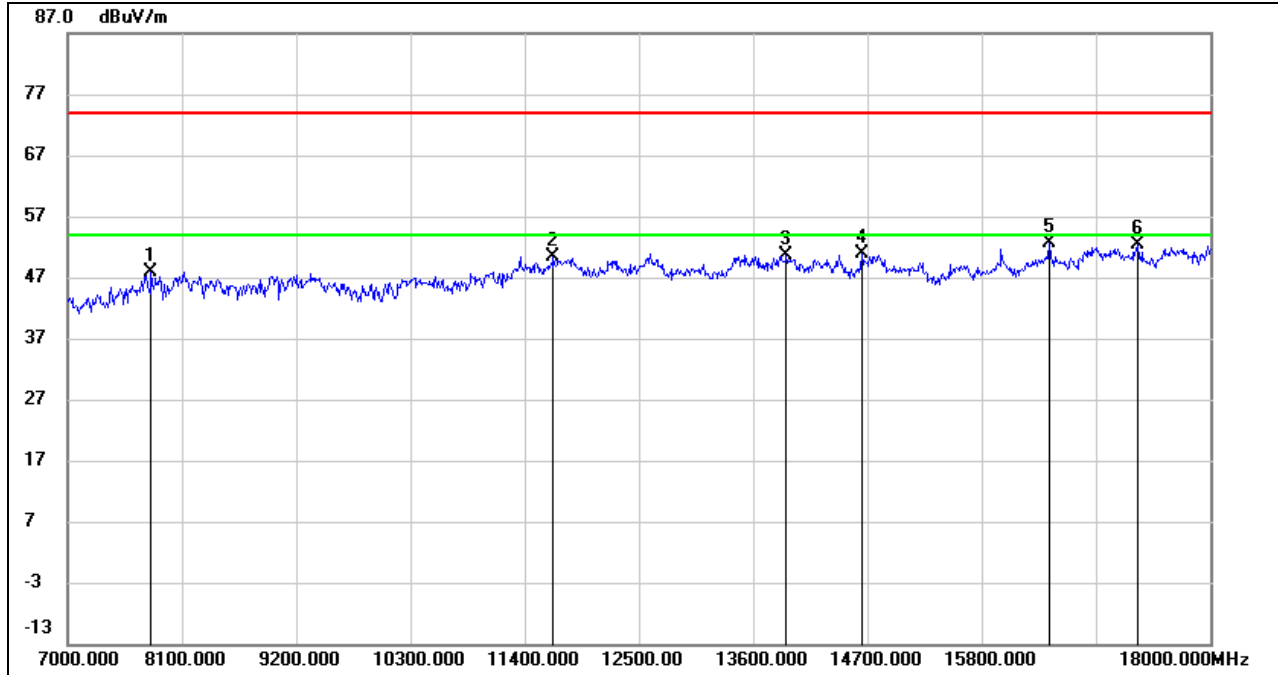

No.	Frequency (MHz)	Reading (dBuV)	Correct (dB/m)	Result (dBuV/m)	Limit (dBuV/m)	Margin (dB)	Remark
1	7803.000	38.66	9.33	47.99	74.00	-26.01	peak
2	11675.000	35.23	15.18	50.41	74.00	-23.59	peak
3	13919.000	33.17	17.55	50.72	74.00	-23.28	peak
4	14645.000	33.31	17.51	50.82	74.00	-23.18	peak
5	16449.000	32.98	19.69	52.67	74.00	-21.33	peak
6	17296.000	29.70	22.59	52.29	74.00	-21.71	peak

Note: 1. Measurement = Reading Level + Correct Factor.  
 2. If Peak Result complies with AV limit, AV Result is deemed to comply with AV limit.  
 3. Peak: Peak detector.  
 4. Filter losses were only considered in the spurious frequency bands and the authorized band was not corrected for High Pass Filter losses.  
 5. Proper operation of the transmitter prior to adding the filter to the measurement chain.  
 6. Since non-restricted band peak emissions are less than the average limit, they also comply with the -27dBm/MHz (68.2dBuV/m) limit.

**HARMONICS AND SPURIOUS EMISSIONS (HIGH CHANNEL, HORIZONTAL)**

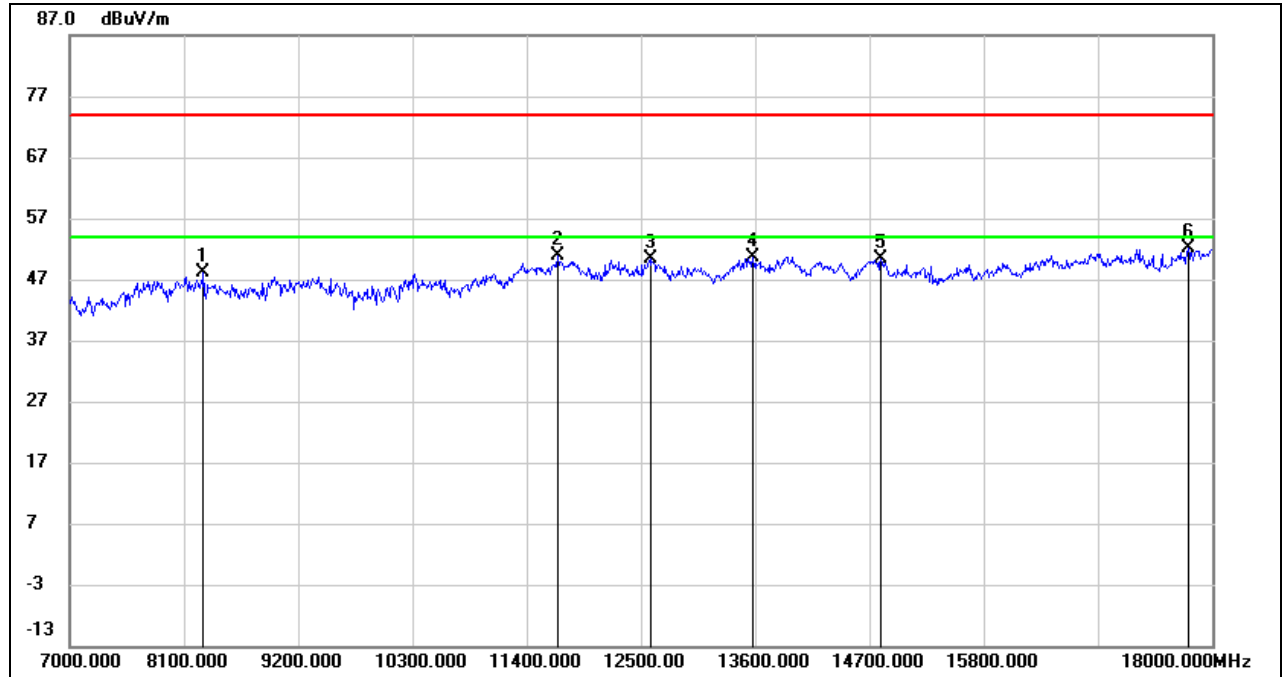

No.	Frequency (MHz)	Reading (dBuV)	Correct (dB/m)	Result (dBuV/m)	Limit (dBuV/m)	Margin (dB)	Remark
1	8287.000	38.33	9.70	48.03	74.00	-25.97	peak
2	11697.000	35.53	15.34	50.87	74.00	-23.13	peak
3	12588.000	34.67	15.76	50.43	74.00	-23.57	peak
4	13578.000	33.46	17.13	50.59	74.00	-23.41	peak
5	14810.000	32.53	17.97	50.50	74.00	-23.50	peak
6	17769.000	28.24	23.87	52.11	74.00	-21.89	peak

Note: 1. Measurement = Reading Level + Correct Factor.  
 2. If Peak Result complies with AV limit, AV Result is deemed to comply with AV limit.  
 3. Peak: Peak detector.  
 4. Filter losses were only considered in the spurious frequency bands and the authorized band was not corrected for High Pass Filter losses.  
 5. Proper operation of the transmitter prior to adding the filter to the measurement chain.  
 6. Since non-restricted band peak emissions are less than the average limit, they also comply with the -27dBm/MHz (68.2dBuV/m) limit.



**HARMONICS AND SPURIOUS EMISSIONS (HIGH CHANNEL, VERTICAL)**

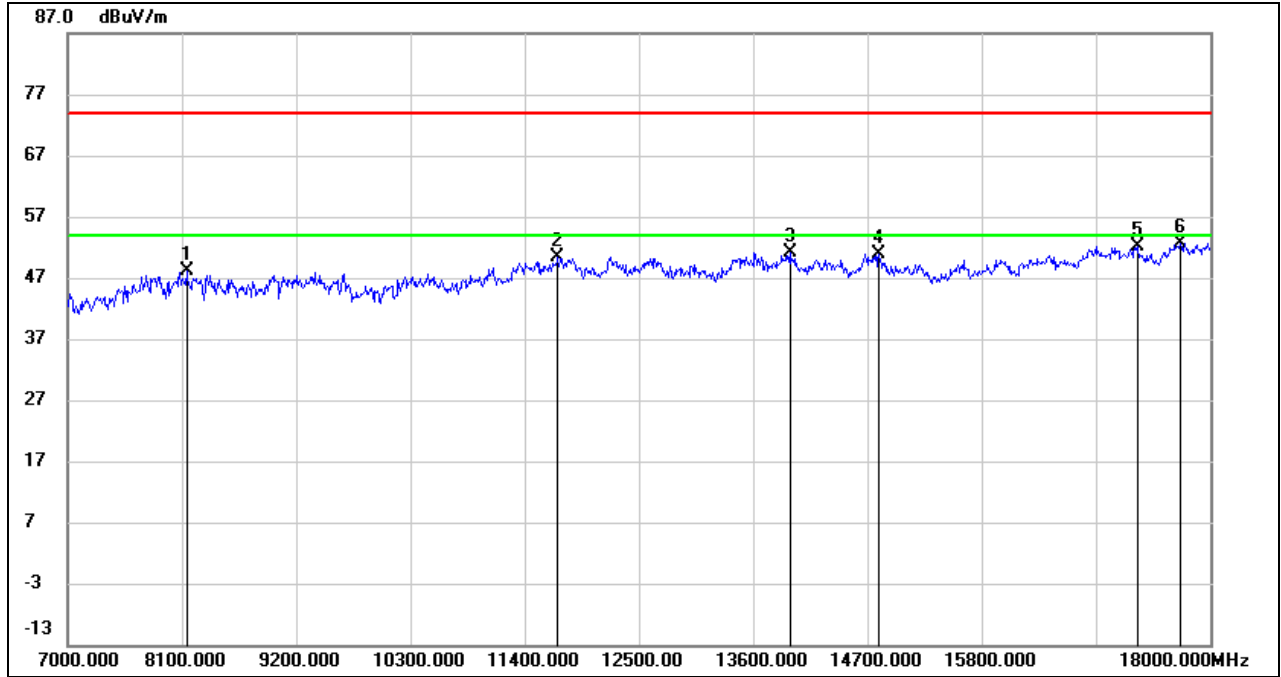

No.	Frequency (MHz)	Reading (dBuV)	Correct (dB/m)	Result (dBuV/m)	Limit (dBuV/m)	Margin (dB)	Remark
1	8144.000	38.22	10.02	48.24	74.00	-25.76	peak
2	11719.000	34.93	15.33	50.26	74.00	-23.74	peak
3	13952.000	33.58	17.60	51.18	74.00	-22.82	peak
4	14810.000	32.89	17.97	50.86	74.00	-23.14	peak
5	17296.000	29.64	22.59	52.23	74.00	-21.77	peak
6	17714.000	29.15	23.55	52.70	74.00	-21.30	peak

- Note: 1. Measurement = Reading Level + Correct Factor.  
 2. If Peak Result complies with AV limit, AV Result is deemed to comply with AV limit.  
 3. Peak: Peak detector.  
 4. Filter losses were only considered in the spurious frequency bands and the authorized band was not corrected for High Pass Filter losses.  
 5. Proper operation of the transmitter prior to adding the filter to the measurement chain.  
 6. Since non-restricted band peak emissions are less than the average limit, they also comply with the -27dBm/MHz (68.2dBuV/m) limit.

**STRADDLE CHANNEL 144**

**HARMONICS AND SPURIOUS EMISSIONS (HORIZONTAL)**

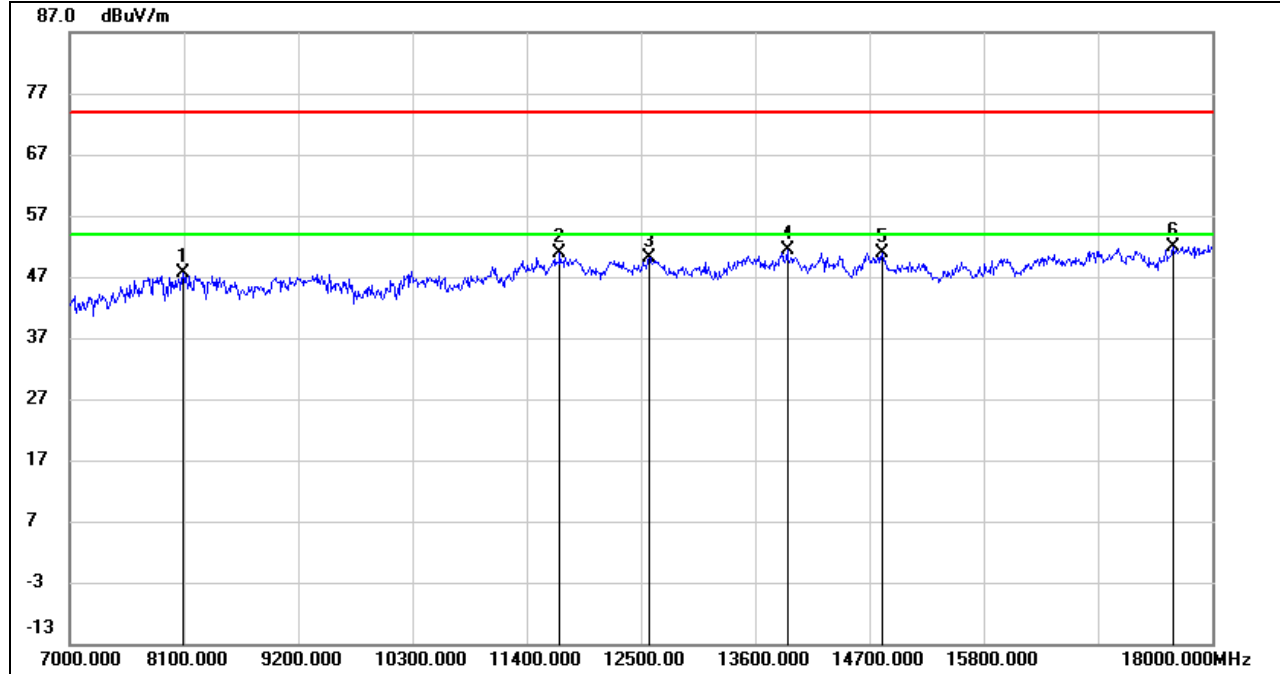

No.	Frequency (MHz)	Reading (dBuV)	Correct (dB/m)	Result (dBuV/m)	Limit (dBuV/m)	Margin (dB)	Remark
1	8089.000	37.58	10.01	47.59	74.00	-26.41	peak
2	11719.000	35.48	15.33	50.81	74.00	-23.19	peak
3	12577.000	34.38	15.75	50.13	74.00	-23.87	peak
4	13908.000	33.90	17.54	51.44	74.00	-22.56	peak
5	14821.000	33.07	17.90	50.97	74.00	-23.03	peak
6	17626.000	29.04	22.92	51.96	74.00	-22.04	peak

Note: 1. Measurement = Reading Level + Correct Factor.  
 2. If Peak Result complies with AV limit, AV Result is deemed to comply with AV limit.  
 3. Peak: Peak detector.  
 4. Filter losses were only considered in the spurious frequency bands and the authorized band was not corrected for High Pass Filter losses.  
 5. Proper operation of the transmitter prior to adding the filter to the measurement chain.  
 6. Since non-restricted band peak emissions are less than the average limit, they also comply with the -27dBm/MHz (68.2dBuV/m) limit.

**HARMONICS AND SPURIOUS EMISSIONS (VERTICAL)**

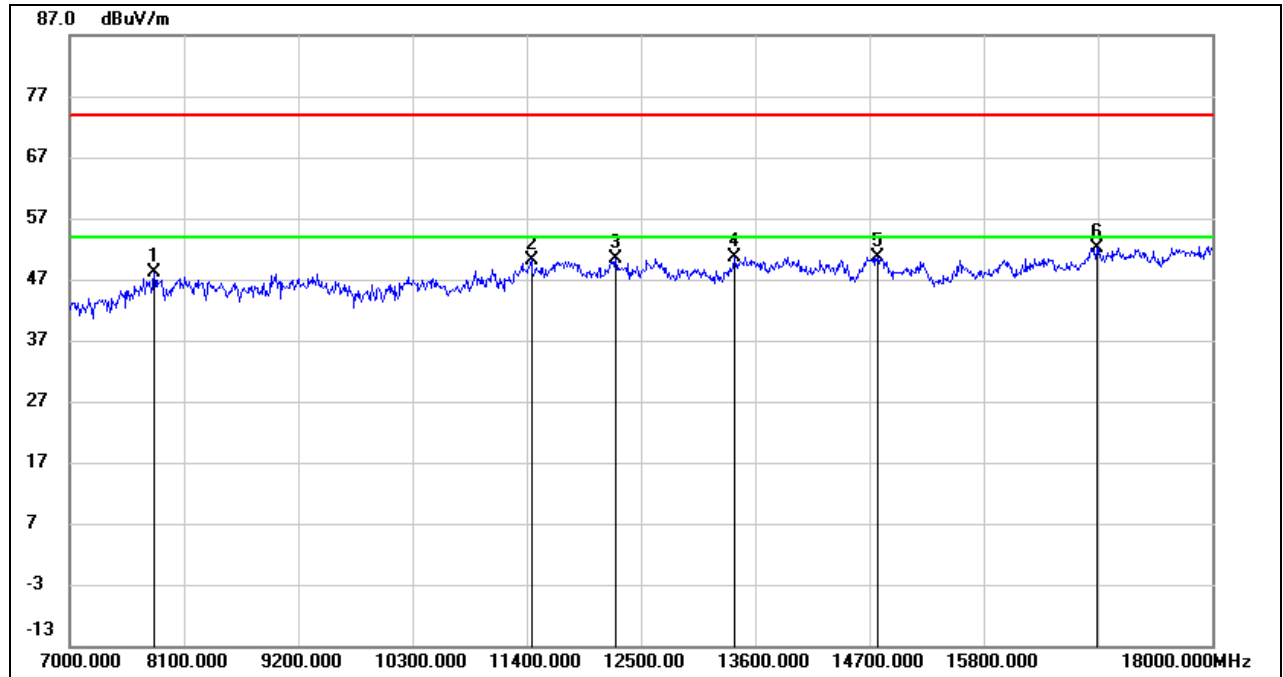

No.	Frequency (MHz)	Reading (dBuV)	Correct (dB/m)	Result (dBuV/m)	Limit (dBuV/m)	Margin (dB)	Remark
1	7814.000	38.83	9.28	48.11	74.00	-25.89	peak
2	11444.000	35.54	14.71	50.25	74.00	-23.75	peak
3	12258.000	34.35	16.03	50.38	74.00	-23.62	peak
4	13402.000	33.72	17.02	50.74	74.00	-23.26	peak
5	14777.000	32.67	17.96	50.63	74.00	-23.37	peak
6	16889.000	30.77	21.47	52.24	74.00	-21.76	peak

- Note:
1. Measurement = Reading Level + Correct Factor.
  2. If Peak Result complies with AV limit, AV Result is deemed to comply with AV limit.
  3. Peak: Peak detector.
  4. Filter losses were only considered in the spurious frequency bands and the authorized band was not corrected for High Pass Filter losses.
  5. Proper operation of the transmitter prior to adding the filter to the measurement chain.
  6. Since non-restricted band peak emissions are less than the average limit, they also comply with the -27dBm/MHz (68.2dBuV/m) limit.

**UNII-3 BAND**

**HARMONICS AND SPURIOUS EMISSIONS (LOW CHANNEL, HORIZONTAL)**

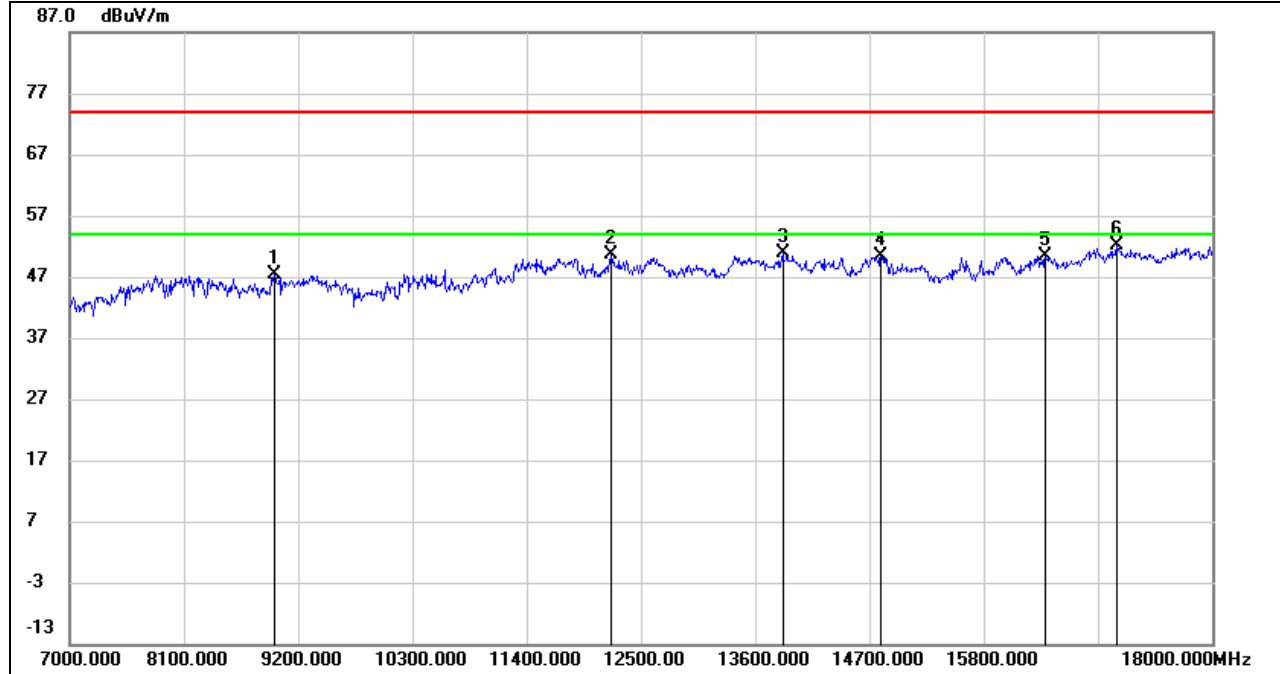

No.	Frequency (MHz)	Reading (dBuV)	Correct (dB/m)	Result (dBuV/m)	Limit (dBuV/m)	Margin (dB)	Remark
1	8969.000	36.64	10.69	47.33	74.00	-26.67	peak
2	12214.000	34.73	15.97	50.70	74.00	-23.30	peak
3	13864.000	33.32	17.55	50.87	74.00	-23.13	peak
4	14810.000	32.29	17.97	50.26	74.00	-23.74	peak
5	16394.000	30.67	19.67	50.34	74.00	-23.66	peak
6	17076.000	30.37	21.74	52.11	74.00	-21.89	peak

- Note: 1. Measurement = Reading Level + Correct Factor.  
 2. If Peak Result complies with AV limit, AV Result is deemed to comply with AV limit.  
 3. Peak: Peak detector.  
 4. Filter losses were only considered in the spurious frequency bands and the authorized band was not corrected for High Pass Filter losses.  
 5. Proper operation of the transmitter prior to adding the filter to the measurement chain.  
 6. Since non-restricted band peak emissions are less than the average limit, they also comply with the -27dBm/MHz (68.2dBuV/m) limit.

**HARMONICS AND SPURIOUS EMISSIONS (LOW CHANNEL, VERTICAL)**

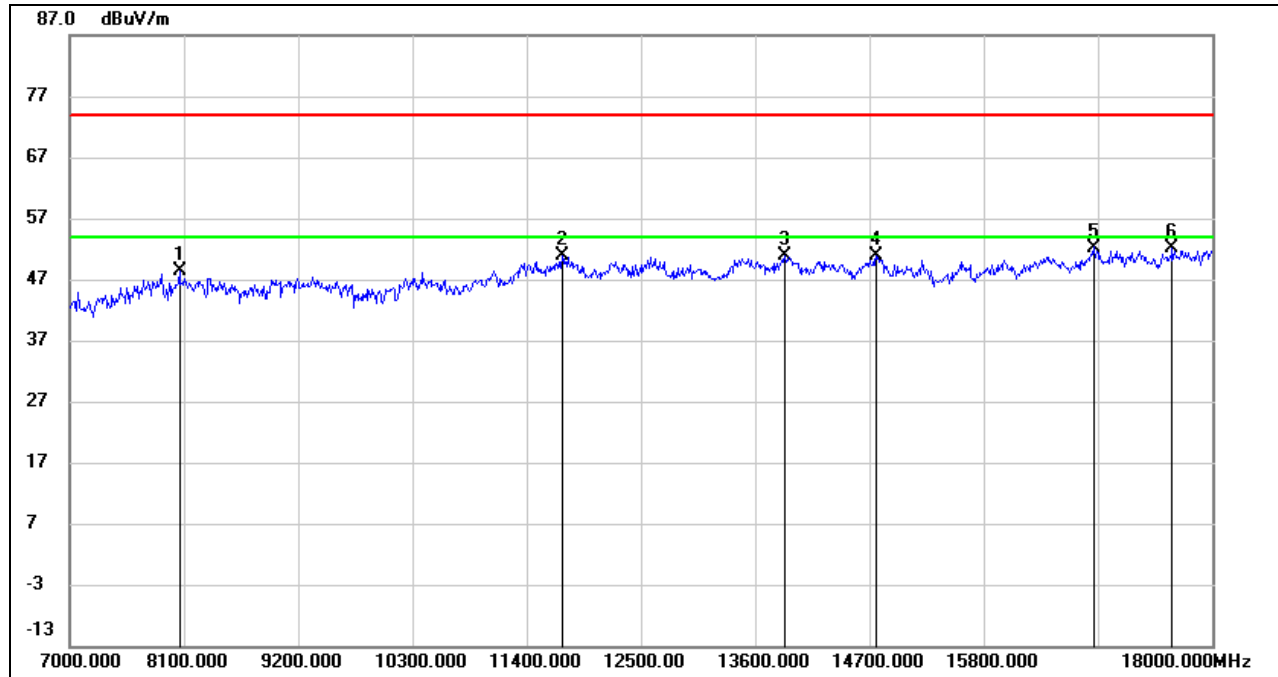

No.	Frequency (MHz)	Reading (dBuV)	Correct (dB/m)	Result (dBuV/m)	Limit (dBuV/m)	Margin (dB)	Remark
1	8056.000	38.79	9.50	48.29	74.00	-25.71	peak
2	11741.000	35.54	15.30	50.84	74.00	-23.16	peak
3	13886.000	33.22	17.54	50.76	74.00	-23.24	peak
4	14766.000	32.84	17.92	50.76	74.00	-23.24	peak
5	16856.000	31.06	21.19	52.25	74.00	-21.75	peak
6	17615.000	29.26	22.84	52.10	74.00	-21.90	peak

Note: 1. Measurement = Reading Level + Correct Factor.  
 2. If Peak Result complies with AV limit, AV Result is deemed to comply with AV limit.  
 3. Peak: Peak detector.  
 4. Filter losses were only considered in the spurious frequency bands and the authorized band was not corrected for High Pass Filter losses.  
 5. Proper operation of the transmitter prior to adding the filter to the measurement chain.  
 6. Since non-restricted band peak emissions are less than the average limit, they also comply with the -27dBm/MHz (68.2dBuV/m) limit.

**HARMONICS AND SPURIOUS EMISSIONS (MID CHANNEL, HORIZONTAL)**

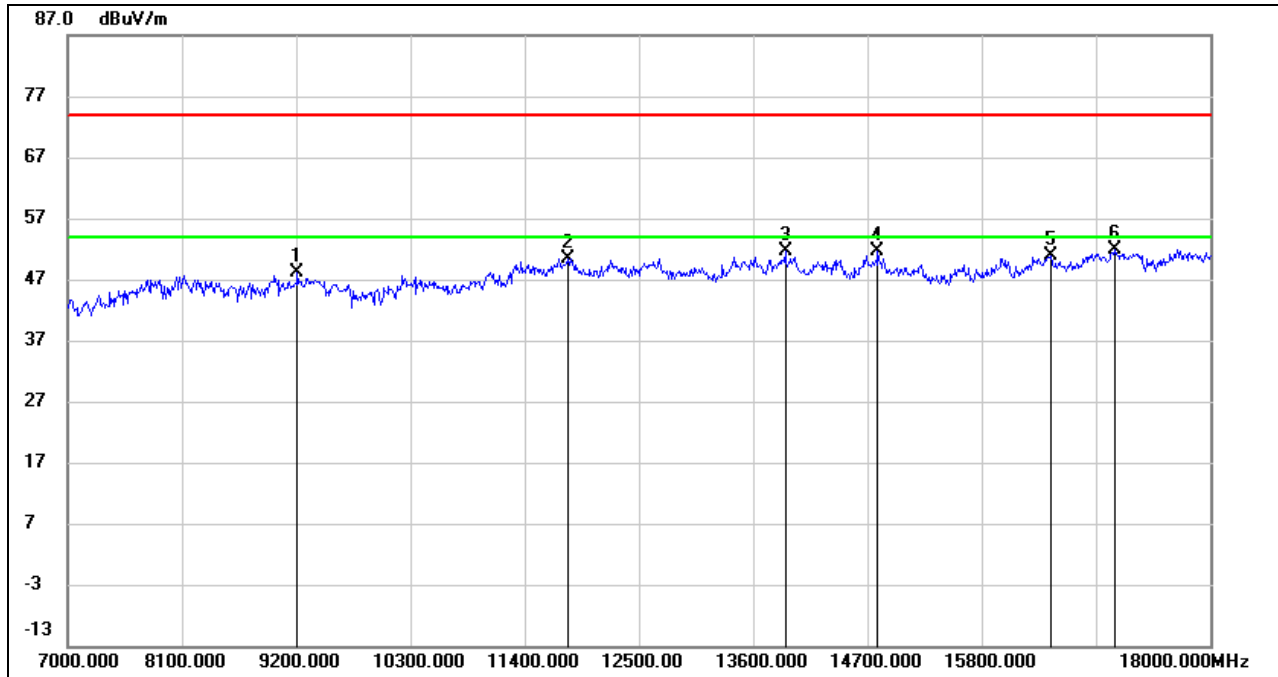

No.	Frequency (MHz)	Reading (dBuV)	Correct (dB/m)	Result (dBuV/m)	Limit (dBuV/m)	Margin (dB)	Remark
1	9211.000	38.06	9.96	48.02	74.00	-25.98	peak
2	11818.000	35.20	15.29	50.49	74.00	-23.51	peak
3	13908.000	34.05	17.54	51.59	74.00	-22.41	peak
4	14799.000	33.57	18.04	51.61	74.00	-22.39	peak
5	16460.000	31.26	19.69	50.95	74.00	-23.05	peak
6	17076.000	30.18	21.74	51.92	74.00	-22.08	peak

Note: 1. Measurement = Reading Level + Correct Factor.  
 2. If Peak Result complies with AV limit, AV Result is deemed to comply with AV limit.  
 3. Peak: Peak detector.  
 4. Filter losses were only considered in the spurious frequency bands and the authorized band was not corrected for High Pass Filter losses.  
 5. Proper operation of the transmitter prior to adding the filter to the measurement chain.  
 6. Since non-restricted band peak emissions are less than the average limit, they also comply with the -27dBm/MHz (68.2dBuV/m) limit.



**HARMONICS AND SPURIOUS EMISSIONS (MID CHANNEL, VERTICAL)**

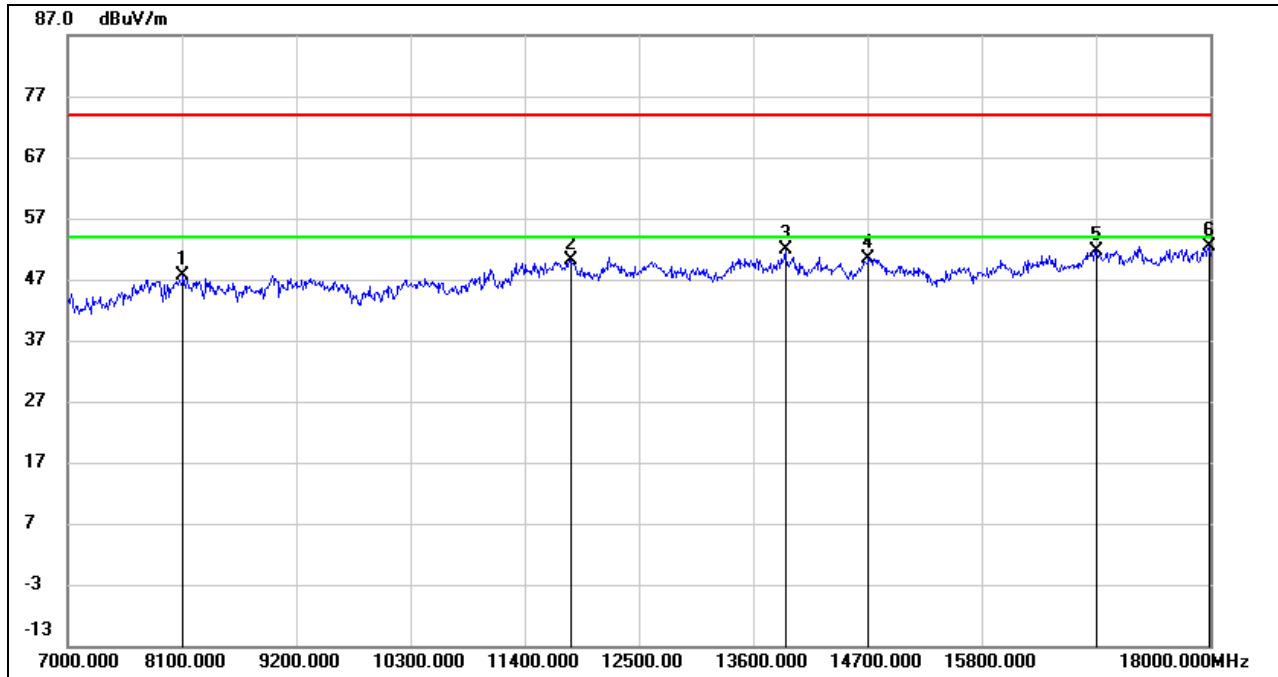

No.	Frequency (MHz)	Reading (dBuV)	Correct (dB/m)	Result (dBuV/m)	Limit (dBuV/m)	Margin (dB)	Remark
1	8111.000	37.55	10.14	47.69	74.00	-26.31	peak
2	11851.000	34.73	15.38	50.11	74.00	-23.89	peak
3	13908.000	34.37	17.54	51.91	74.00	-22.09	peak
4	14711.000	32.62	17.73	50.35	74.00	-23.65	peak
5	16911.000	30.15	21.54	51.69	74.00	-22.31	peak
6	17989.000	28.25	24.22	52.47	74.00	-21.53	peak

- Note: 1. Measurement = Reading Level + Correct Factor.  
 2. If Peak Result complies with AV limit, AV Result is deemed to comply with AV limit.  
 3. Peak: Peak detector.  
 4. Filter losses were only considered in the spurious frequency bands and the authorized band was not corrected for High Pass Filter losses.  
 5. Proper operation of the transmitter prior to adding the filter to the measurement chain.  
 6. Since non-restricted band peak emissions are less than the average limit, they also comply with the -27dBm/MHz (68.2dBuV/m) limit.

**HARMONICS AND SPURIOUS EMISSIONS (HIGH CHANNEL, HORIZONTAL)**

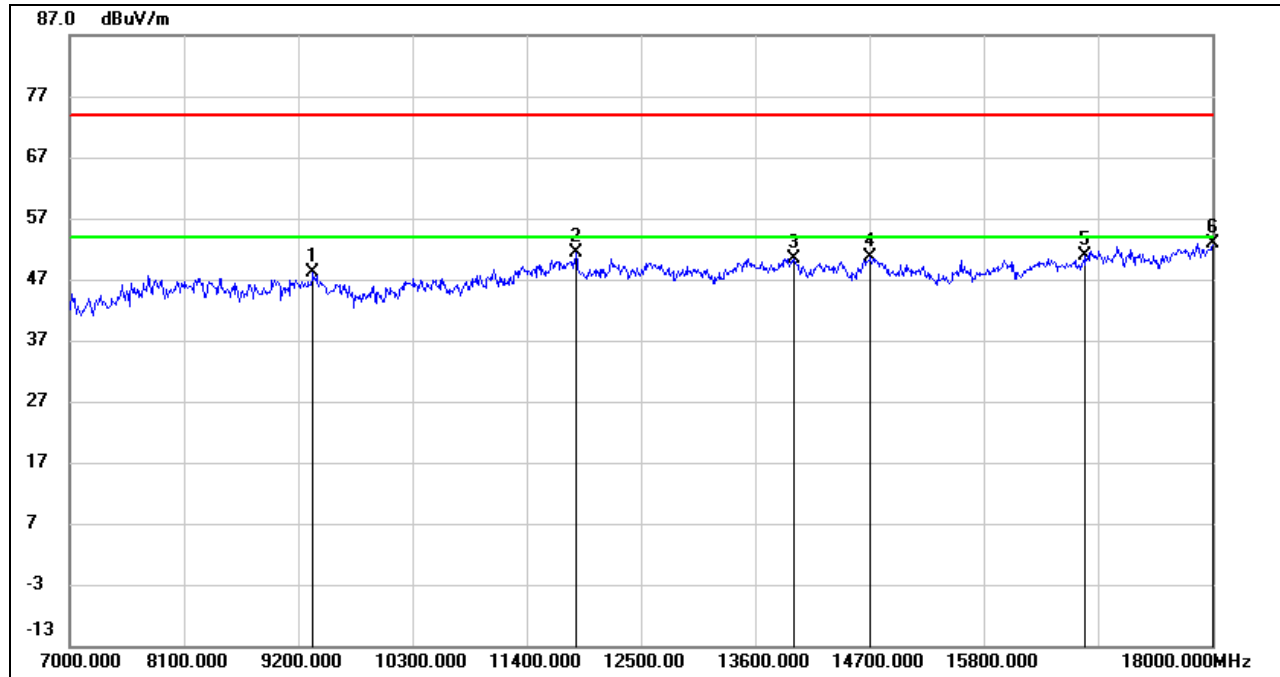

No.	Frequency (MHz)	Reading (dBuV)	Correct (dB/m)	Result (dBuV/m)	Limit (dBuV/m)	Margin (dB)	Remark
1	9343.000	37.38	10.64	48.02	74.00	-25.98	peak
2	11873.000	35.96	15.44	51.40	74.00	-22.60	peak
3	13974.000	32.84	17.62	50.46	74.00	-23.54	peak
4	14711.000	33.01	17.73	50.74	74.00	-23.26	peak
5	16779.000	30.28	20.55	50.83	74.00	-23.17	peak
6	18000.000	28.61	24.27	52.88	74.00	-21.12	peak

Note: 1. Measurement = Reading Level + Correct Factor.  
 2. If Peak Result complies with AV limit, AV Result is deemed to comply with AV limit.  
 3. Peak: Peak detector.  
 4. Filter losses were only considered in the spurious frequency bands and the authorized band was not corrected for High Pass Filter losses.  
 5. Proper operation of the transmitter prior to adding the filter to the measurement chain.  
 6. Since non-restricted band peak emissions are less than the average limit, they also comply with the -27dBm/MHz (68.2dBuV/m) limit.

**HARMONICS AND SPURIOUS EMISSIONS (HIGH CHANNEL, VERTICAL)**

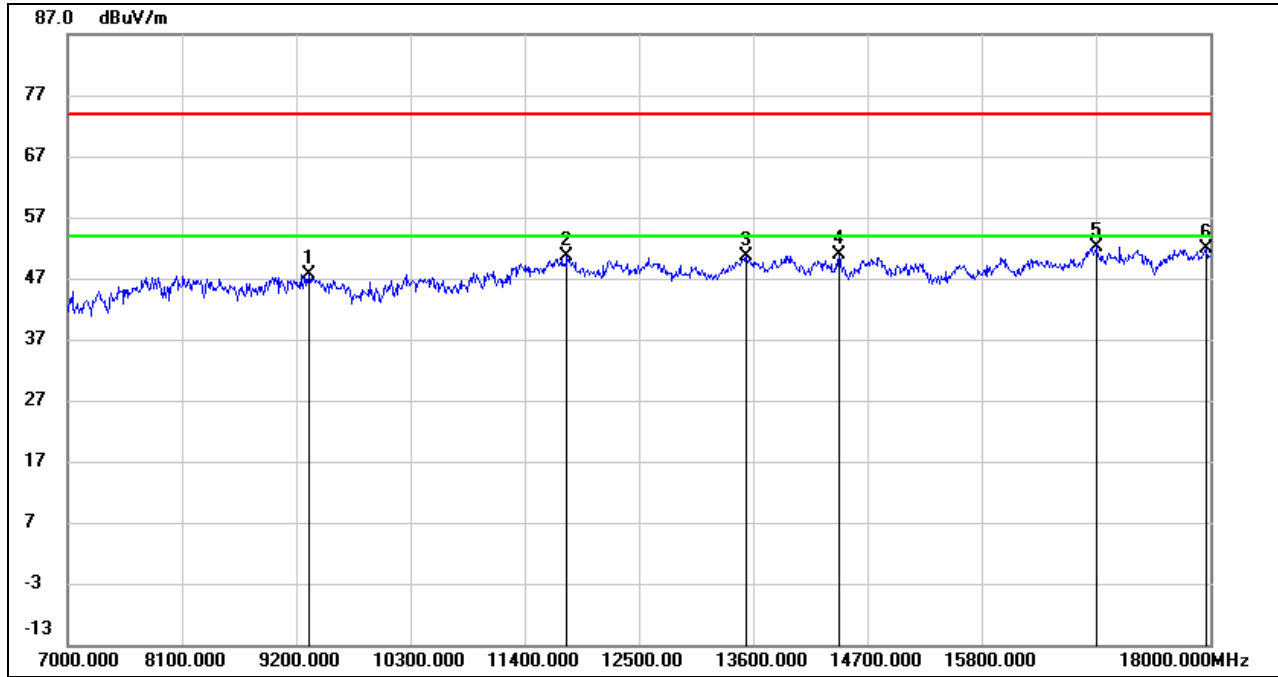

No.	Frequency (MHz)	Reading (dBuV)	Correct (dB/m)	Result (dBuV/m)	Limit (dBuV/m)	Margin (dB)	Remark
1	9321.000	37.17	10.52	47.69	74.00	-26.31	peak
2	11807.000	35.26	15.27	50.53	74.00	-23.47	peak
3	13534.000	33.54	17.18	50.72	74.00	-23.28	peak
4	14425.000	33.63	17.34	50.97	74.00	-23.03	peak
5	16900.000	30.51	21.57	52.08	74.00	-21.92	peak
6	17967.000	27.77	24.14	51.91	74.00	-22.09	peak

Note: 1. Measurement = Reading Level + Correct Factor.  
 2. If Peak Result complies with AV limit, AV Result is deemed to comply with AV limit.  
 3. Peak: Peak detector.  
 4. Filter losses were only considered in the spurious frequency bands and the authorized band was not corrected for High Pass Filter losses.  
 5. Proper operation of the transmitter prior to adding the filter to the measurement chain.  
 6. Since non-restricted band peak emissions are less than the average limit, they also comply with the -27dBm/MHz (68.2dBuV/m) limit.

**8.3.2. 802.11n HT20 MODE**

**UNII-1 BAND**

**HARMONICS AND SPURIOUS EMISSIONS (LOW CHANNEL, HORIZONTAL)**

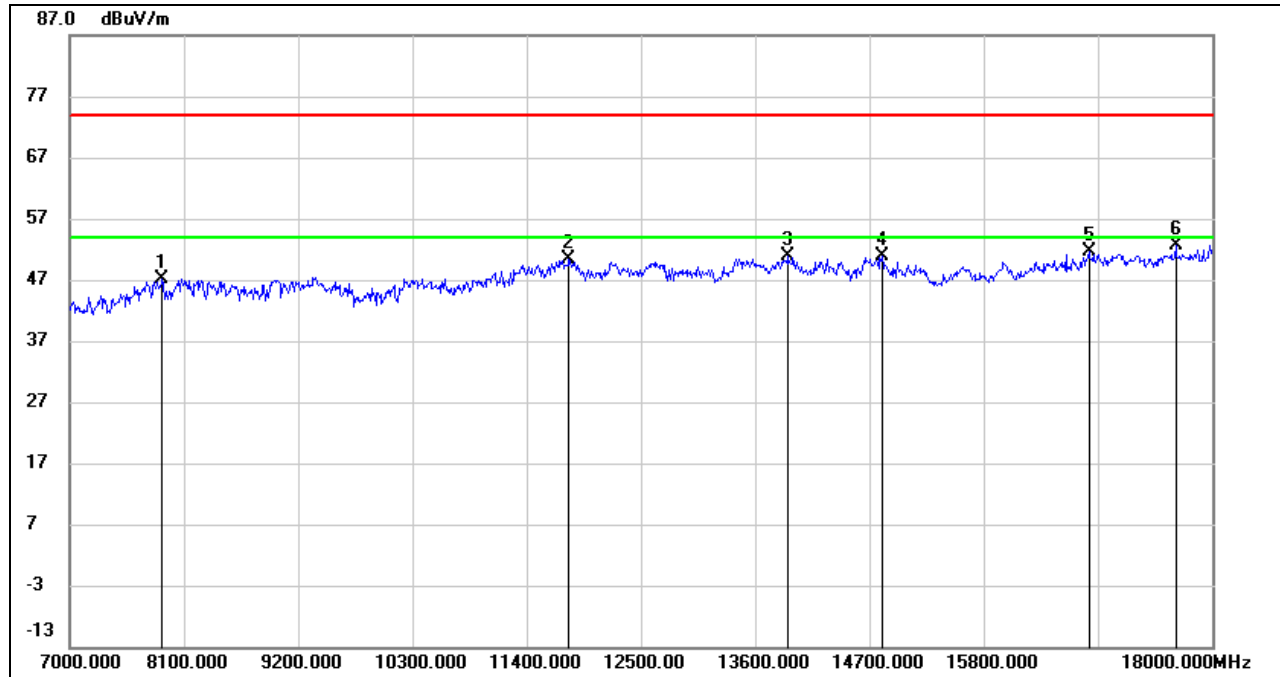

No.	Frequency (MHz)	Reading (dBuV)	Correct (dB/m)	Result (dBuV/m)	Limit (dBuV/m)	Margin (dB)	Remark
1	7891.000	38.20	8.90	47.10	74.00	-26.90	peak
2	11807.000	35.13	15.27	50.40	74.00	-23.60	peak
3	13919.000	33.34	17.55	50.89	74.00	-23.11	peak
4	14821.000	33.09	17.90	50.99	74.00	-23.01	peak
5	16812.000	30.78	20.81	51.59	74.00	-22.41	peak
6	17648.000	29.60	23.08	52.68	74.00	-21.32	peak

Note: 1. Measurement = Reading Level + Correct Factor.  
 2. If Peak Result complies with AV limit, AV Result is deemed to comply with AV limit.  
 3. Peak: Peak detector.  
 4. Filter losses were only considered in the spurious frequency bands and the authorized band was not corrected for High Pass Filter losses.  
 5. Proper operation of the transmitter prior to adding the filter to the measurement chain.  
 6. Since non-restricted band peak emissions are less than the average limit, they also comply with the -27dBm/MHz (68.2dBuV/m) limit.



**HARMONICS AND SPURIOUS EMISSIONS (LOW CHANNEL, VERTICAL)**

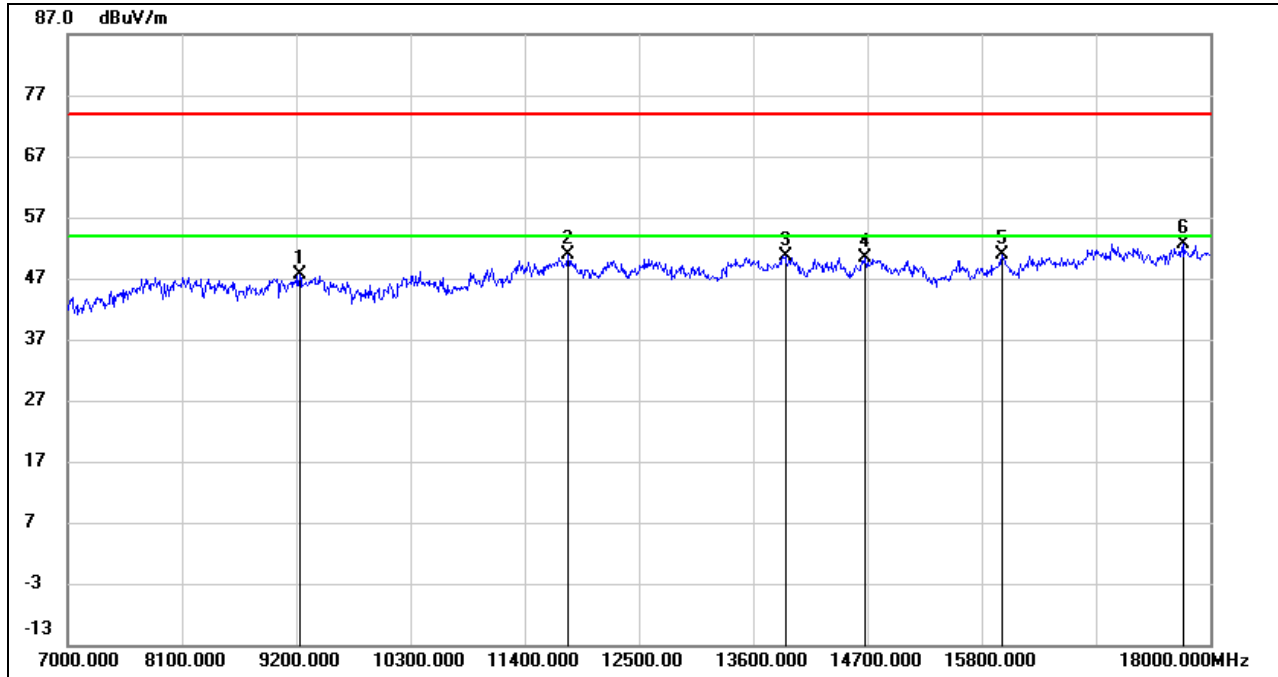

No.	Frequency (MHz)	Reading (dBuV)	Correct (dB/m)	Result (dBuV/m)	Limit (dBuV/m)	Margin (dB)	Remark
1	9233.000	37.50	10.08	47.58	74.00	-26.42	peak
2	11818.000	35.62	15.29	50.91	74.00	-23.09	peak
3	13908.000	33.07	17.54	50.61	74.00	-23.39	peak
4	14678.000	32.86	17.62	50.48	74.00	-23.52	peak
5	15998.000	32.39	18.42	50.81	74.00	-23.19	peak
6	17747.000	28.84	23.75	52.59	74.00	-21.41	peak

- Note: 1. Measurement = Reading Level + Correct Factor.  
 2. If Peak Result complies with AV limit, AV Result is deemed to comply with AV limit.  
 3. Peak: Peak detector.  
 4. Filter losses were only considered in the spurious frequency bands and the authorized band was not corrected for High Pass Filter losses.  
 5. Proper operation of the transmitter prior to adding the filter to the measurement chain.  
 6. Since non-restricted band peak emissions are less than the average limit, they also comply with the -27dBm/MHz (68.2dBuV/m) limit.

**HARMONICS AND SPURIOUS EMISSIONS (MID CHANNEL, HORIZONTAL)**

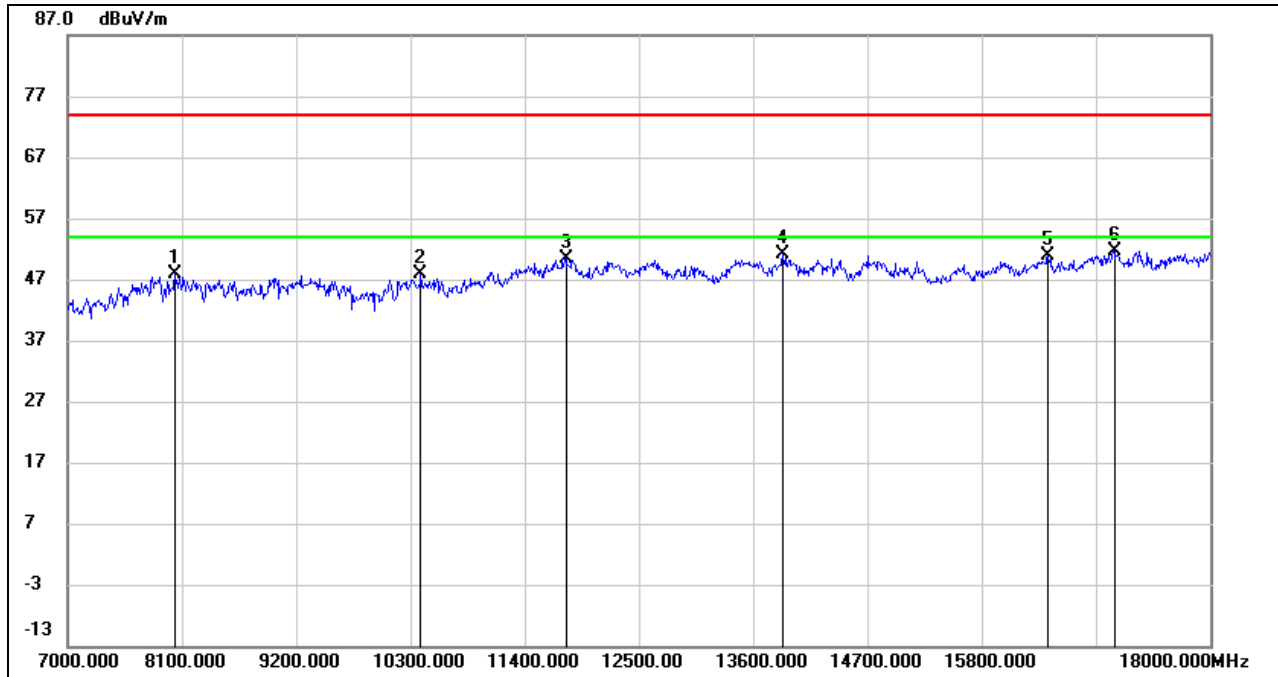

No.	Frequency (MHz)	Reading (dBuV)	Correct (dB/m)	Result (dBuV/m)	Limit (dBuV/m)	Margin (dB)	Remark
1	8034.000	38.68	9.15	47.83	74.00	-26.17	peak
2	10399.000	35.57	12.23	47.80	74.00	-26.20	peak
3	11796.000	35.23	15.25	50.48	74.00	-23.52	peak
4	13886.000	33.66	17.54	51.20	74.00	-22.80	peak
5	16438.000	31.10	19.68	50.78	74.00	-23.22	peak
6	17076.000	29.90	21.74	51.64	74.00	-22.36	peak

Note: 1. Measurement = Reading Level + Correct Factor.  
 2. If Peak Result complies with AV limit, AV Result is deemed to comply with AV limit.  
 3. Peak: Peak detector.  
 4. Filter losses were only considered in the spurious frequency bands and the authorized band was not corrected for High Pass Filter losses.  
 5. Proper operation of the transmitter prior to adding the filter to the measurement chain.  
 6. Since non-restricted band peak emissions are less than the average limit, they also comply with the -27dBm/MHz (68.2dBuV/m) limit.

**HARMONICS AND SPURIOUS EMISSIONS (MID CHANNEL, VERTICAL)**

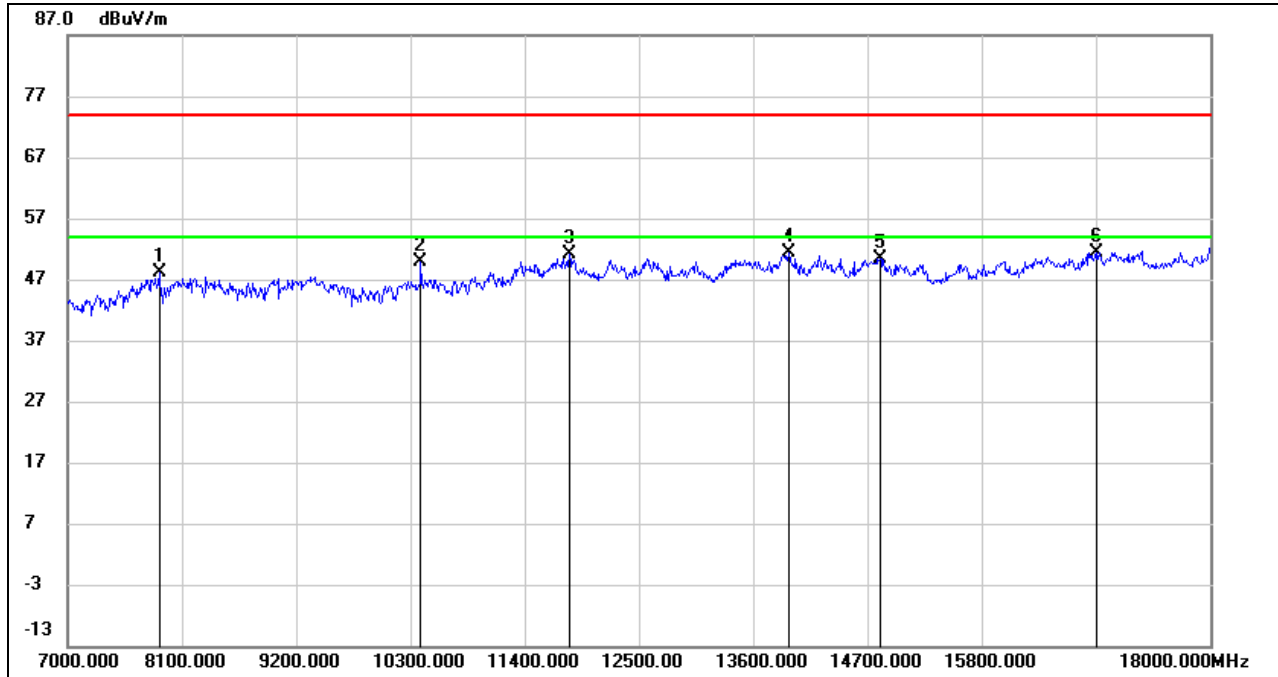

No.	Frequency (MHz)	Reading (dBuV)	Correct (dB/m)	Result (dBuV/m)	Limit (dBuV/m)	Margin (dB)	Remark
1	7880.000	39.12	8.95	48.07	74.00	-25.93	peak
2	10399.000	37.63	12.23	49.86	74.00	-24.14	peak
3	11829.000	35.91	15.32	51.23	74.00	-22.77	peak
4	13941.000	33.73	17.58	51.31	74.00	-22.69	peak
5	14821.000	32.54	17.90	50.44	74.00	-23.56	peak
6	16900.000	29.91	21.57	51.48	74.00	-22.52	peak

- Note: 1. Measurement = Reading Level + Correct Factor.  
 2. If Peak Result complies with AV limit, AV Result is deemed to comply with AV limit.  
 3. Peak: Peak detector.  
 4. Filter losses were only considered in the spurious frequency bands and the authorized band was not corrected for High Pass Filter losses.  
 5. Proper operation of the transmitter prior to adding the filter to the measurement chain.  
 6. Since non-restricted band peak emissions are less than the average limit, they also comply with the -27dBm/MHz (68.2dBuV/m) limit.

**HARMONICS AND SPURIOUS EMISSIONS (HIGH CHANNEL, HORIZONTAL)**

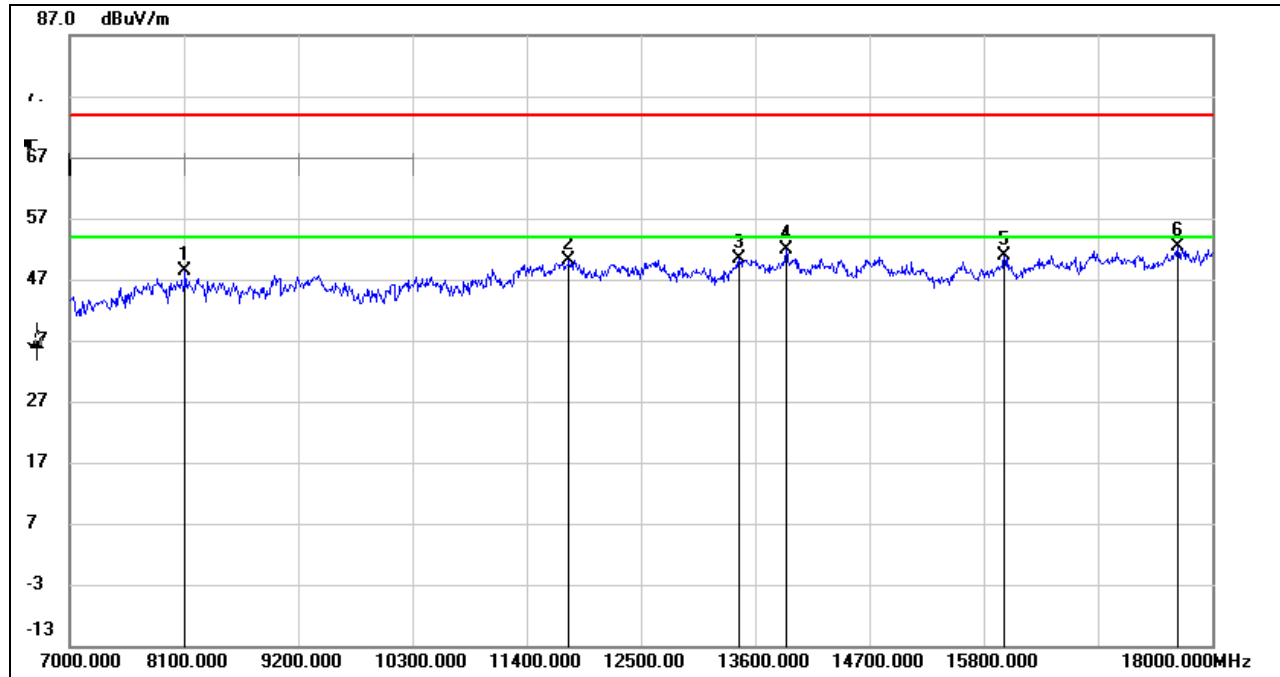

No.	Frequency (MHz)	Reading (dBuV)	Correct (dB/m)	Result (dBuV/m)	Limit (dBuV/m)	Margin (dB)	Remark
1	8111.000	38.15	10.14	48.29	74.00	-25.71	peak
2	11807.000	34.81	15.27	50.08	74.00	-23.92	peak
3	13446.000	33.31	17.12	50.43	74.00	-23.57	peak
4	13897.000	34.27	17.52	51.79	74.00	-22.21	peak
5	15998.000	32.47	18.42	50.89	74.00	-23.11	peak
6	17670.000	29.09	23.24	52.33	74.00	-21.67	peak

Note: 1. Measurement = Reading Level + Correct Factor.  
 2. If Peak Result complies with AV limit, AV Result is deemed to comply with AV limit.  
 3. Peak: Peak detector.  
 4. Filter losses were only considered in the spurious frequency bands and the authorized band was not corrected for High Pass Filter losses.  
 5. Proper operation of the transmitter prior to adding the filter to the measurement chain.  
 6. Since non-restricted band peak emissions are less than the average limit, they also comply with the -27dBm/MHz (68.2dBuV/m) limit.



**HARMONICS AND SPURIOUS EMISSIONS (HIGH CHANNEL, VERTICAL)**

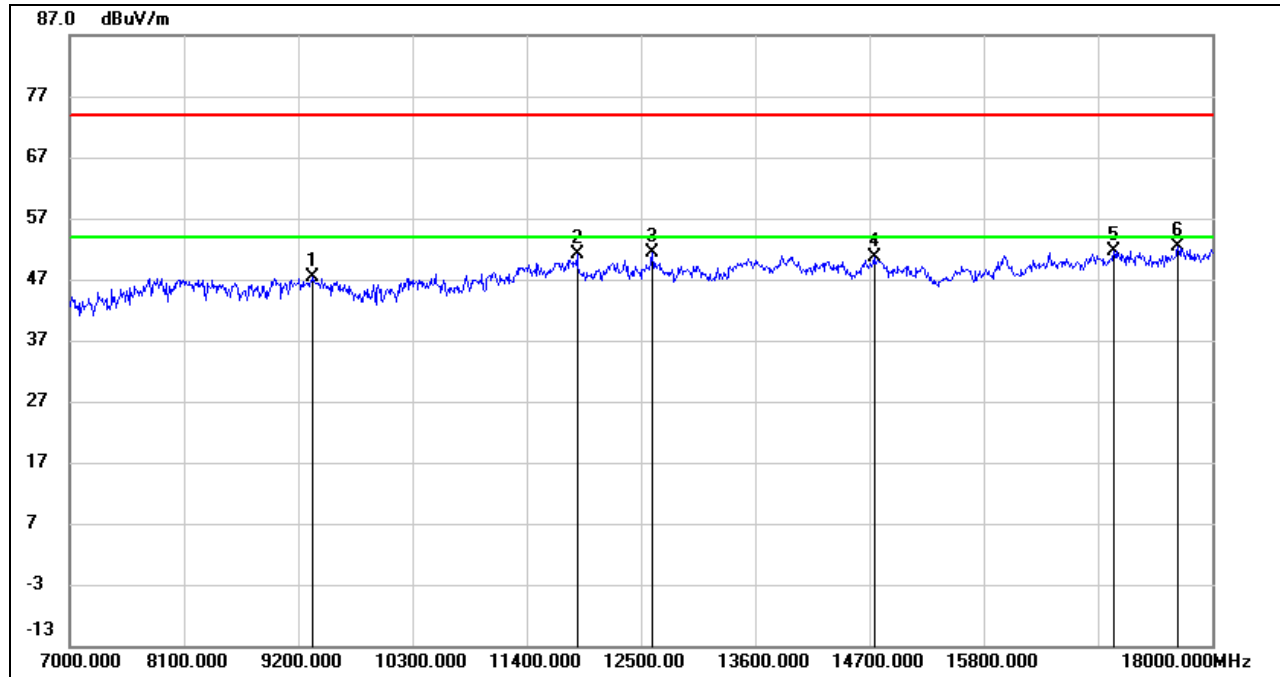

No.	Frequency (MHz)	Reading (dBuV)	Correct (dB/m)	Result (dBuV/m)	Limit (dBuV/m)	Margin (dB)	Remark
1	9343.000	36.79	10.64	47.43	74.00	-26.57	peak
2	11884.000	35.54	15.47	51.01	74.00	-22.99	peak
3	12610.000	35.56	15.76	51.32	74.00	-22.68	peak
4	14744.000	32.87	17.84	50.71	74.00	-23.29	peak
5	17054.000	30.02	21.59	51.61	74.00	-22.39	peak
6	17670.000	29.14	23.24	52.38	74.00	-21.62	peak

Note: 1. Measurement = Reading Level + Correct Factor.  
 2. If Peak Result complies with AV limit, AV Result is deemed to comply with AV limit.  
 3. Peak: Peak detector.  
 4. Filter losses were only considered in the spurious frequency bands and the authorized band was not corrected for High Pass Filter losses.  
 5. Proper operation of the transmitter prior to adding the filter to the measurement chain.  
 6. Since non-restricted band peak emissions are less than the average limit, they also comply with the -27dBm/MHz (68.2dBuV/m) limit.

**UNII-2A BAND**

**HARMONICS AND SPURIOUS EMISSIONS (LOW CHANNEL, HORIZONTAL)**

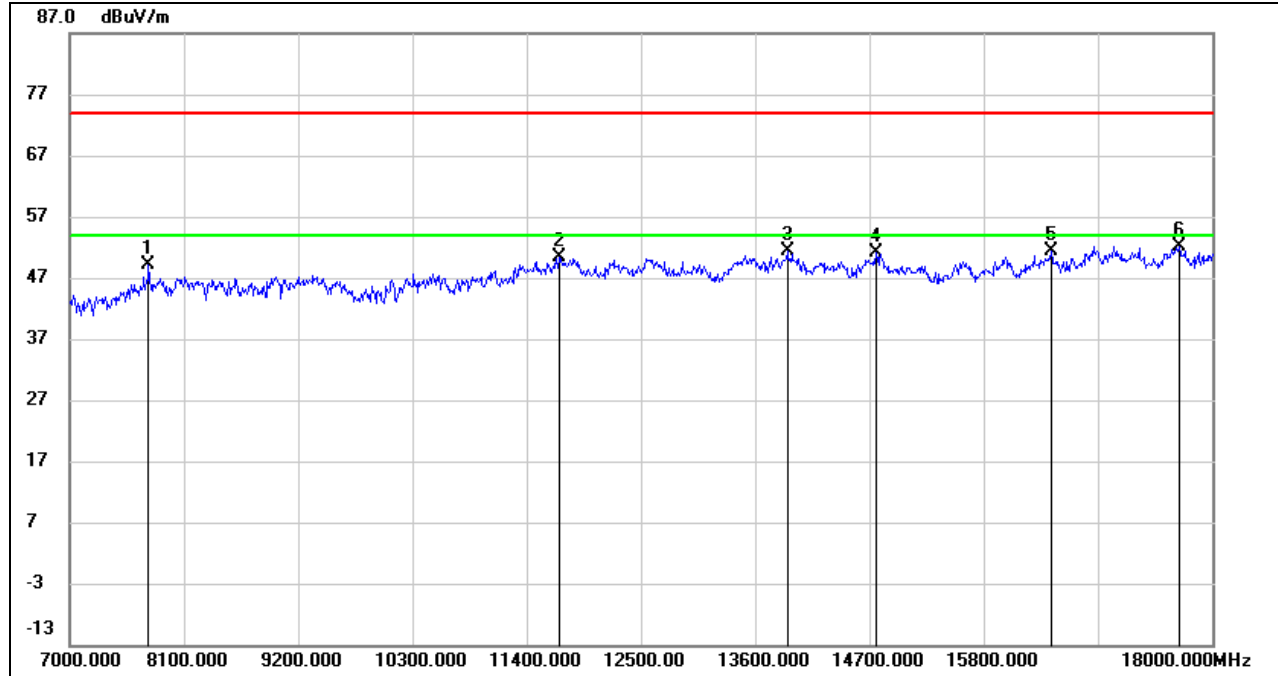

No.	Frequency (MHz)	Reading (dBuV)	Correct (dB/m)	Result (dBuV/m)	Limit (dBuV/m)	Margin (dB)	Remark
1	7759.000	40.11	8.98	49.09	74.00	-24.91	peak
2	11708.000	35.14	15.34	50.48	74.00	-23.52	peak
3	13908.000	33.84	17.54	51.38	74.00	-22.62	peak
4	14766.000	33.33	17.92	51.25	74.00	-22.75	peak
5	16449.000	31.63	19.69	51.32	74.00	-22.68	peak
6	17681.000	28.86	23.33	52.19	74.00	-21.81	peak

Note: 1. Measurement = Reading Level + Correct Factor.  
 2. If Peak Result complies with AV limit, AV Result is deemed to comply with AV limit.  
 3. Peak: Peak detector.  
 4. Filter losses were only considered in the spurious frequency bands and the authorized band was not corrected for High Pass Filter losses.  
 5. Proper operation of the transmitter prior to adding the filter to the measurement chain.  
 6. Since non-restricted band peak emissions are less than the average limit, they also comply with the -27dBm/MHz (68.2dBuV/m) limit.

**HARMONICS AND SPURIOUS EMISSIONS (LOW CHANNEL, VERTICAL)**

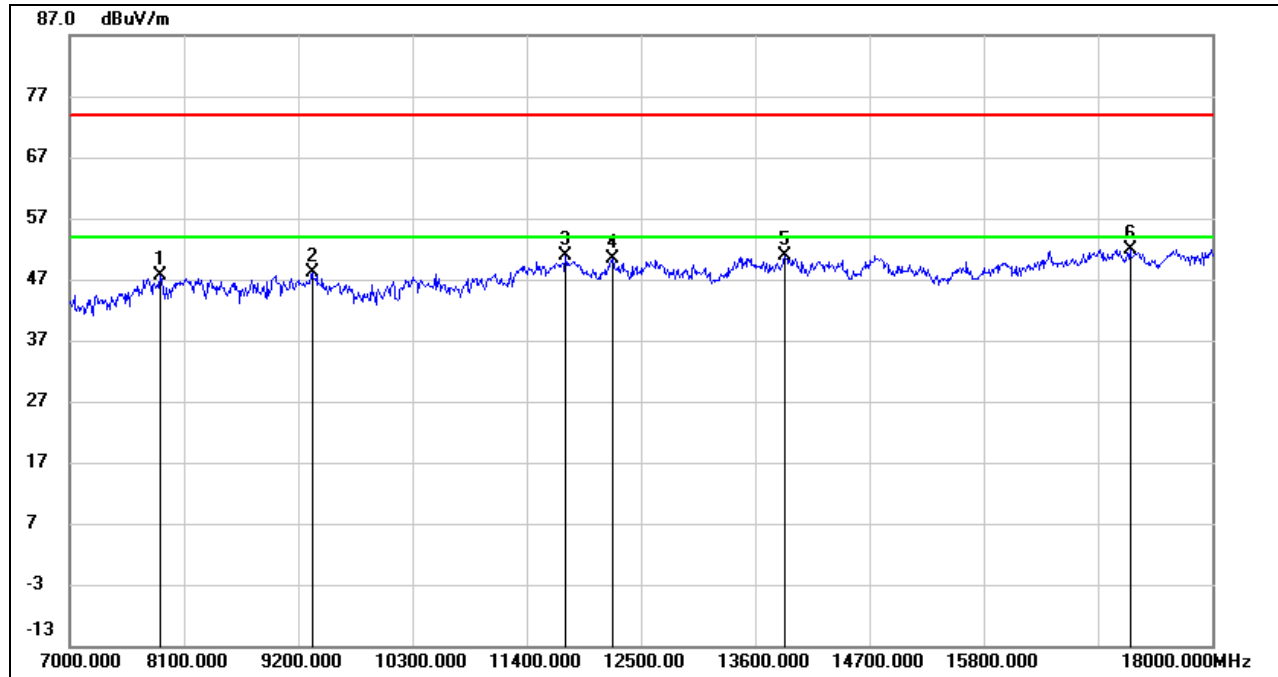

No.	Frequency (MHz)	Reading (dBuV)	Correct (dB/m)	Result (dBuV/m)	Limit (dBuV/m)	Margin (dB)	Remark
1	7869.000	38.65	9.02	47.67	74.00	-26.33	peak
2	9332.000	37.52	10.59	48.11	74.00	-25.89	peak
3	11774.000	35.72	15.27	50.99	74.00	-23.01	peak
4	12225.000	34.41	15.99	50.40	74.00	-23.60	peak
5	13886.000	33.29	17.54	50.83	74.00	-23.17	peak
6	17208.000	29.86	22.04	51.90	74.00	-22.10	peak

- Note:
1. Measurement = Reading Level + Correct Factor.
  2. If Peak Result complies with AV limit, AV Result is deemed to comply with AV limit.
  3. Peak: Peak detector.
  4. Filter losses were only considered in the spurious frequency bands and the authorized band was not corrected for High Pass Filter losses.
  5. Proper operation of the transmitter prior to adding the filter to the measurement chain.
  6. Since non-restricted band peak emissions are less than the average limit, they also comply with the -27dBm/MHz (68.2dBuV/m) limit.

**HARMONICS AND SPURIOUS EMISSIONS (MID CHANNEL, HORIZONTAL)**

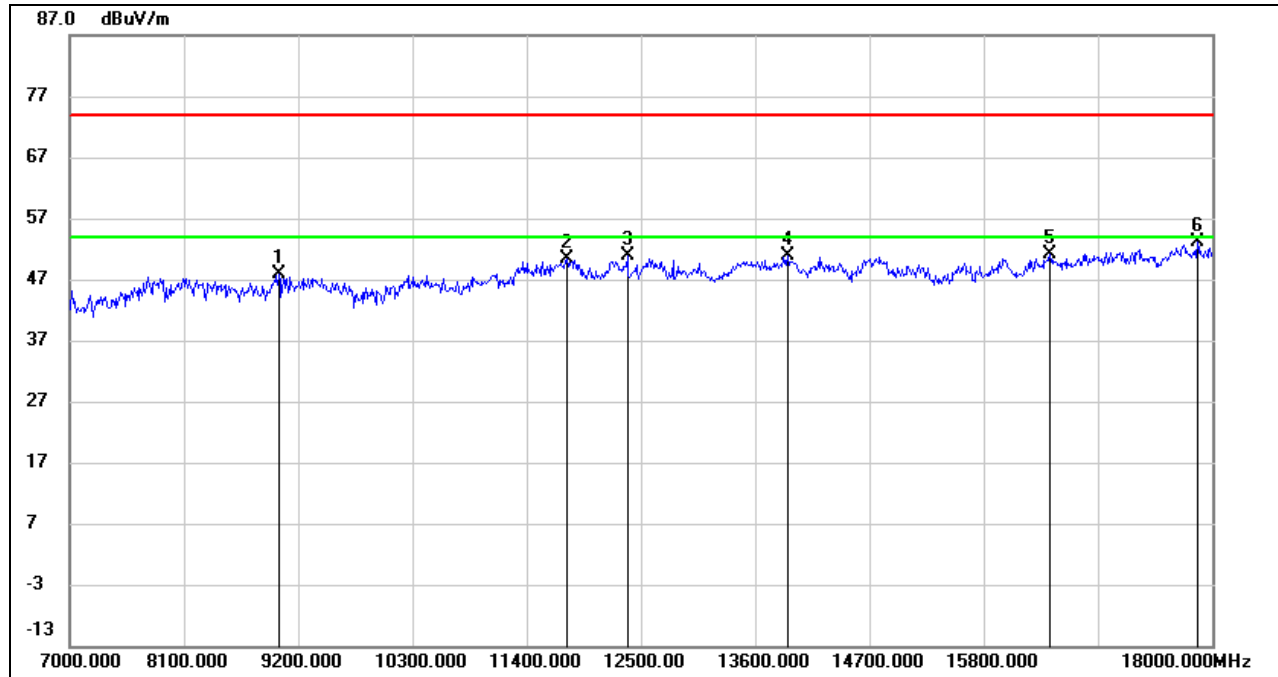

No.	Frequency (MHz)	Reading (dBuV)	Correct (dB/m)	Result (dBuV/m)	Limit (dBuV/m)	Margin (dB)	Remark
1	9013.000	36.70	11.12	47.82	74.00	-26.18	peak
2	11785.000	35.02	15.25	50.27	74.00	-23.73	peak
3	12368.000	34.77	16.00	50.77	74.00	-23.23	peak
4	13908.000	33.46	17.54	51.00	74.00	-23.00	peak
5	16438.000	31.50	19.68	51.18	74.00	-22.82	peak
6	17857.000	29.06	23.96	53.02	74.00	-20.98	peak

Note: 1. Measurement = Reading Level + Correct Factor.  
 2. If Peak Result complies with AV limit, AV Result is deemed to comply with AV limit.  
 3. Peak: Peak detector.  
 4. Filter losses were only considered in the spurious frequency bands and the authorized band was not corrected for High Pass Filter losses.  
 5. Proper operation of the transmitter prior to adding the filter to the measurement chain.  
 6. Since non-restricted band peak emissions are less than the average limit, they also comply with the -27dBm/MHz (68.2dBuV/m) limit.

**HARMONICS AND SPURIOUS EMISSIONS (MID CHANNEL, VERTICAL)**

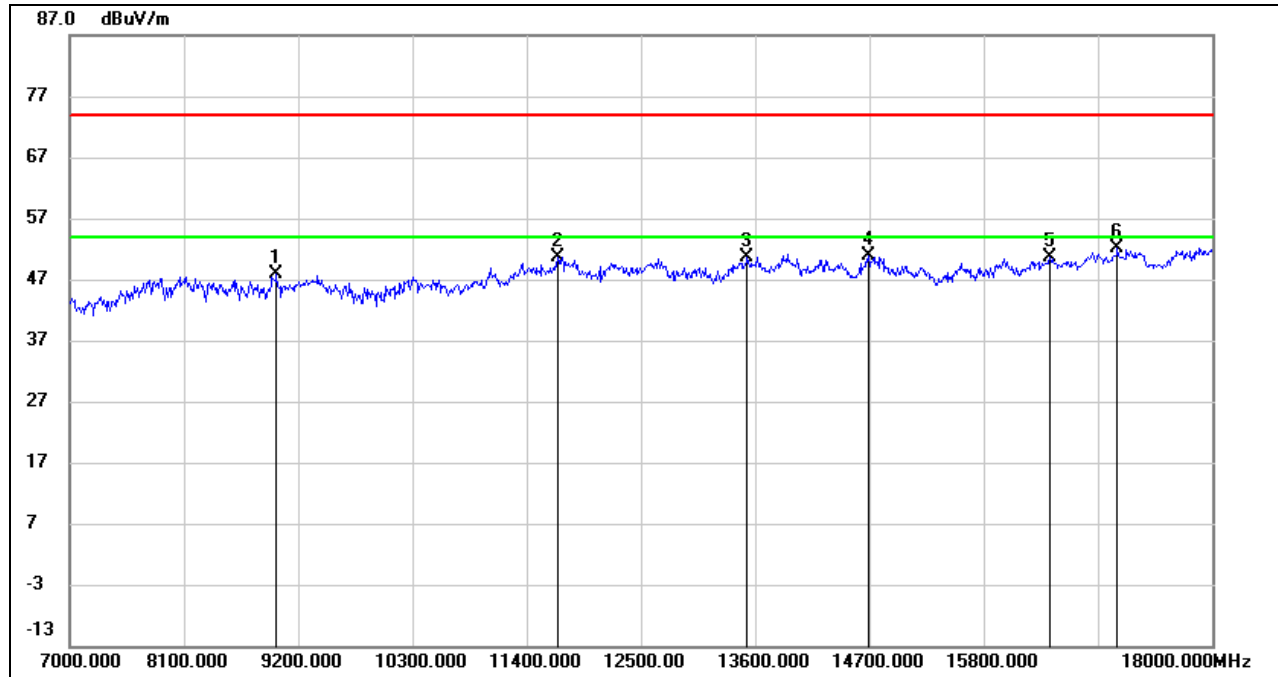

No.	Frequency (MHz)	Reading (dBuV)	Correct (dB/m)	Result (dBuV/m)	Limit (dBuV/m)	Margin (dB)	Remark
1	8991.000	36.69	11.10	47.79	74.00	-26.21	peak
2	11697.000	35.21	15.34	50.55	74.00	-23.45	peak
3	13523.000	33.44	17.19	50.63	74.00	-23.37	peak
4	14689.000	33.11	17.65	50.76	74.00	-23.24	peak
5	16438.000	30.93	19.68	50.61	74.00	-23.39	peak
6	17087.000	30.32	21.81	52.13	74.00	-21.87	peak

Note: 1. Measurement = Reading Level + Correct Factor.  
 2. If Peak Result complies with AV limit, AV Result is deemed to comply with AV limit.  
 3. Peak: Peak detector.  
 4. Filter losses were only considered in the spurious frequency bands and the authorized band was not corrected for High Pass Filter losses.  
 5. Proper operation of the transmitter prior to adding the filter to the measurement chain.  
 6. Since non-restricted band peak emissions are less than the average limit, they also comply with the -27dBm/MHz (68.2dBuV/m) limit.

**HARMONICS AND SPURIOUS EMISSIONS (HIGH CHANNEL, HORIZONTAL)**

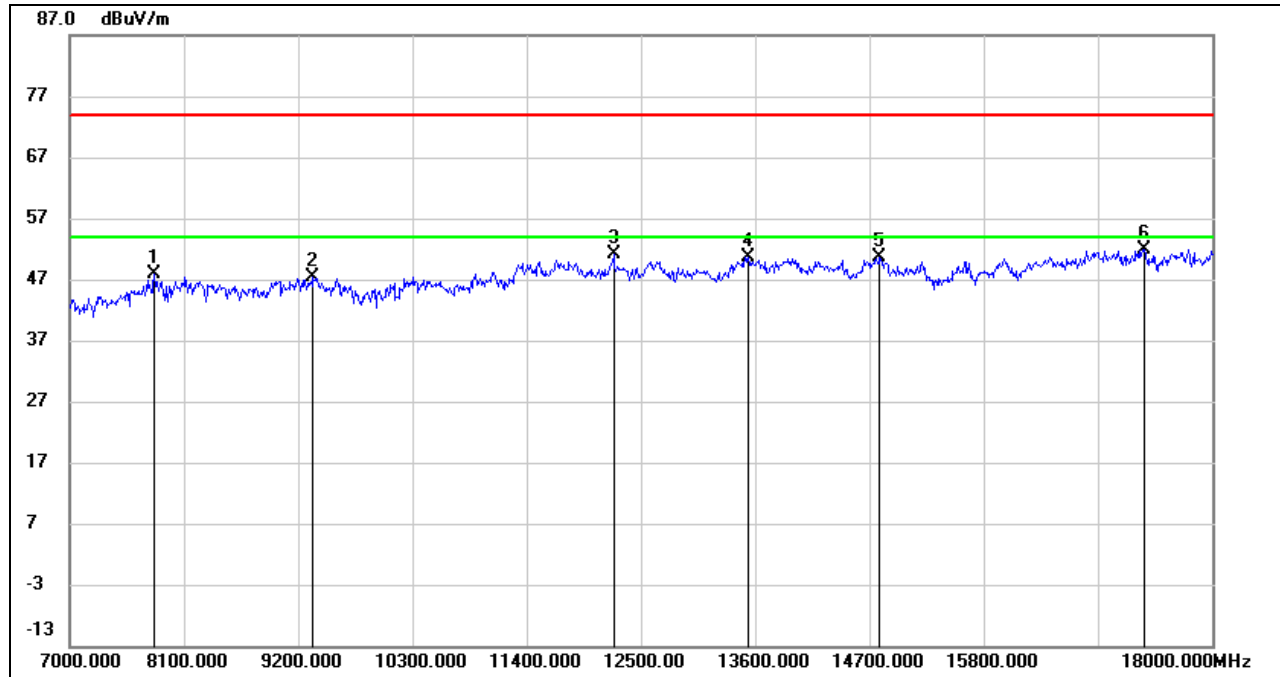

No.	Frequency (MHz)	Reading (dBuV)	Correct (dB/m)	Result (dBuV/m)	Limit (dBuV/m)	Margin (dB)	Remark
1	7814.000	38.49	9.28	47.77	74.00	-26.23	peak
2	9343.000	36.81	10.64	47.45	74.00	-26.55	peak
3	12236.000	35.04	16.01	51.05	74.00	-22.95	peak
4	13534.000	33.44	17.18	50.62	74.00	-23.38	peak
5	14799.000	32.56	18.04	50.60	74.00	-23.40	peak
6	17351.000	29.68	22.23	51.91	74.00	-22.09	peak

Note: 1. Measurement = Reading Level + Correct Factor.  
 2. If Peak Result complies with AV limit, AV Result is deemed to comply with AV limit.  
 3. Peak: Peak detector.  
 4. Filter losses were only considered in the spurious frequency bands and the authorized band was not corrected for High Pass Filter losses.  
 5. Proper operation of the transmitter prior to adding the filter to the measurement chain.  
 6. Since non-restricted band peak emissions are less than the average limit, they also comply with the -27dBm/MHz (68.2dBuV/m) limit.

**HARMONICS AND SPURIOUS EMISSIONS (HIGH CHANNEL, VERTICAL)**

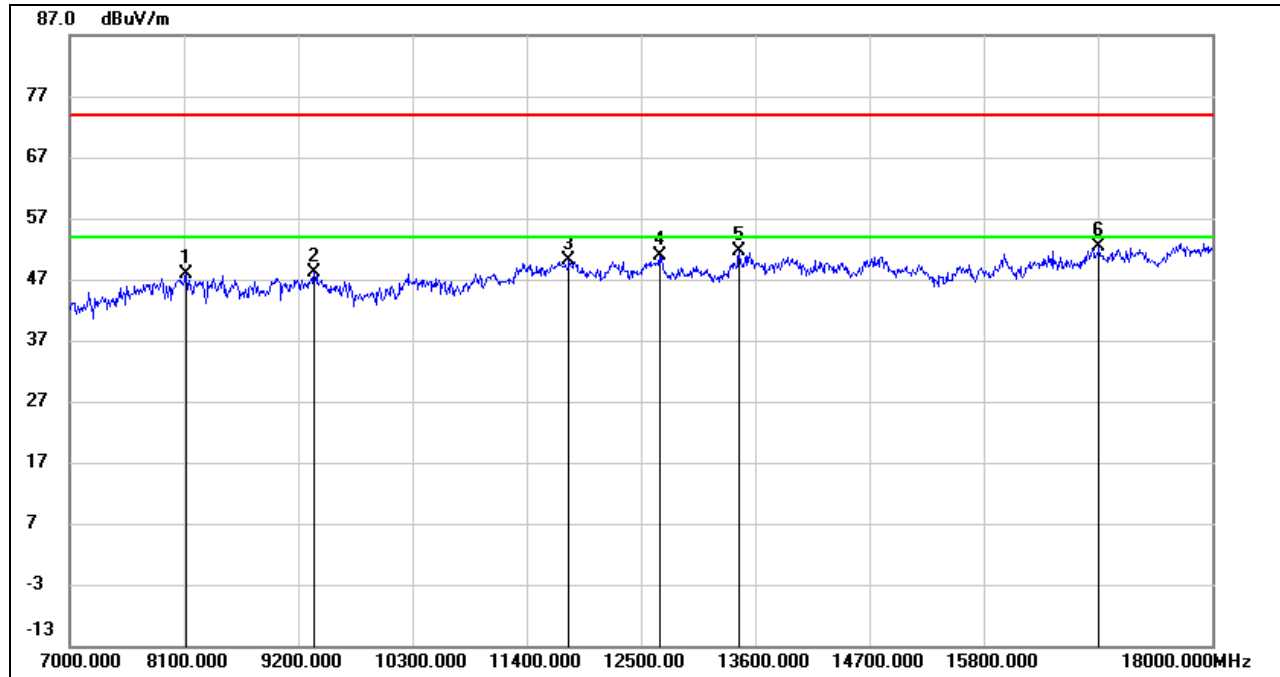

No.	Frequency (MHz)	Reading (dBuV)	Correct (dB/m)	Result (dBuV/m)	Limit (dBuV/m)	Margin (dB)	Remark
1	8122.000	37.82	10.10	47.92	74.00	-26.08	peak
2	9354.000	37.38	10.70	48.08	74.00	-25.92	peak
3	11807.000	34.80	15.27	50.07	74.00	-23.93	peak
4	12676.000	35.23	15.66	50.89	74.00	-23.11	peak
5	13446.000	34.41	17.12	51.53	74.00	-22.47	peak
6	16911.000	30.84	21.54	52.38	74.00	-21.62	peak

Note: 1. Measurement = Reading Level + Correct Factor.  
 2. If Peak Result complies with AV limit, AV Result is deemed to comply with AV limit.  
 3. Peak: Peak detector.  
 4. Filter losses were only considered in the spurious frequency bands and the authorized band was not corrected for High Pass Filter losses.  
 5. Proper operation of the transmitter prior to adding the filter to the measurement chain.  
 6. Since non-restricted band peak emissions are less than the average limit, they also comply with the -27dBm/MHz (68.2dBuV/m) limit.



**UNII-2C BAND**

**HARMONICS AND SPURIOUS EMISSIONS (LOW CHANNEL, HORIZONTAL)**

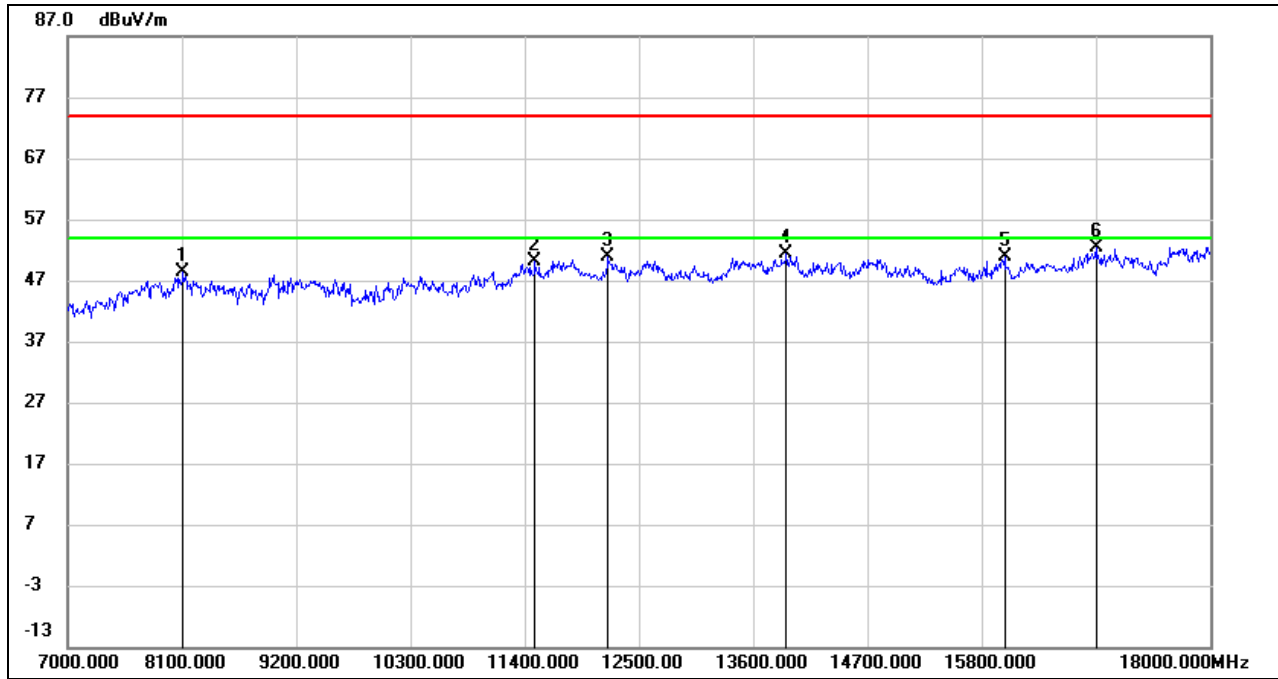

No.	Frequency (MHz)	Reading (dBuV)	Correct (dB/m)	Result (dBuV/m)	Limit (dBuV/m)	Margin (dB)	Remark
1	8111.000	38.14	10.14	48.28	74.00	-25.72	peak
2	11499.000	35.51	14.65	50.16	74.00	-23.84	peak
3	12203.000	34.98	15.95	50.93	74.00	-23.07	peak
4	13919.000	33.77	17.55	51.32	74.00	-22.68	peak
5	16020.000	32.50	18.41	50.91	74.00	-23.09	peak
6	16900.000	30.85	21.57	52.42	74.00	-21.58	peak

Note: 1. Measurement = Reading Level + Correct Factor.  
 2. If Peak Result complies with AV limit, AV Result is deemed to comply with AV limit.  
 3. Peak: Peak detector.  
 4. Filter losses were only considered in the spurious frequency bands and the authorized band was not corrected for High Pass Filter losses.  
 5. Proper operation of the transmitter prior to adding the filter to the measurement chain.  
 6. Since non-restricted band peak emissions are less than the average limit, they also comply with the -27dBm/MHz (68.2dBuV/m) limit.



**HARMONICS AND SPURIOUS EMISSIONS (LOW CHANNEL, VERTICAL)**

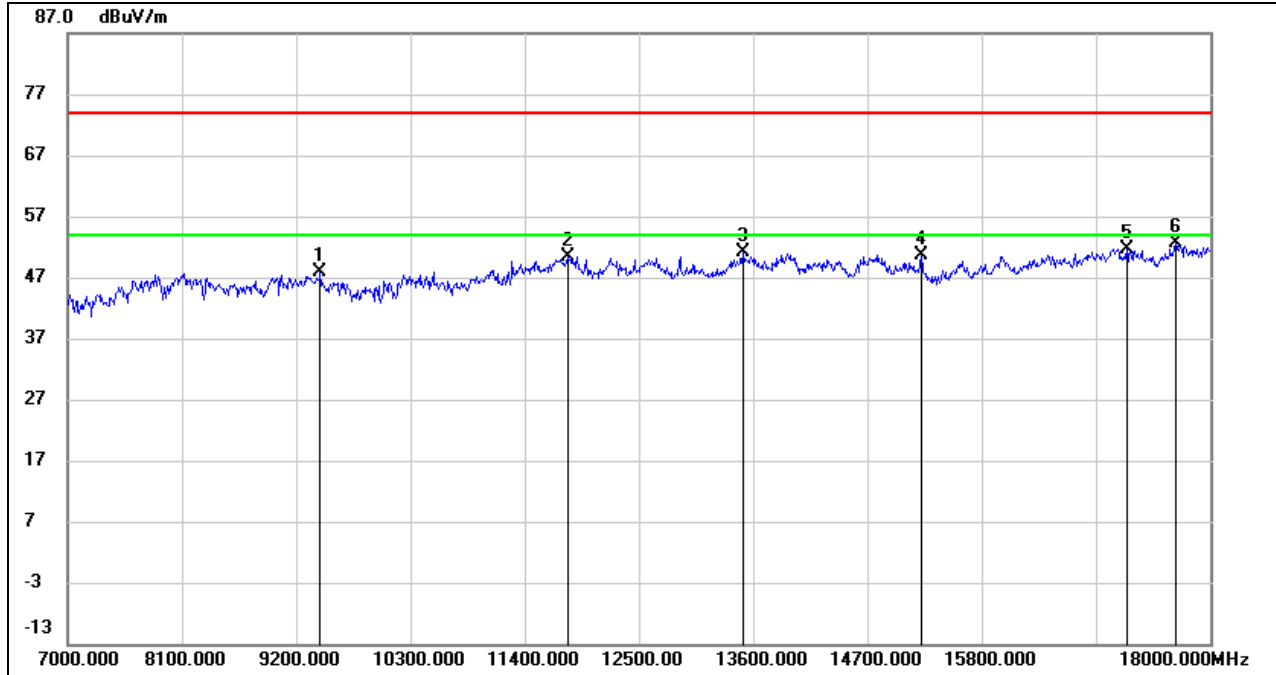

No.	Frequency (MHz)	Reading (dBuV)	Correct (dB/m)	Result (dBuV/m)	Limit (dBuV/m)	Margin (dB)	Remark
1	9431.000	37.12	10.83	47.95	74.00	-26.05	peak
2	11818.000	35.17	15.29	50.46	74.00	-23.54	peak
3	13501.000	33.79	17.22	51.01	74.00	-22.99	peak
4	15217.000	33.64	16.88	50.52	74.00	-23.48	peak
5	17197.000	29.73	21.99	51.72	74.00	-22.28	peak
6	17670.000	29.36	23.24	52.60	74.00	-21.40	peak

Note: 1. Measurement = Reading Level + Correct Factor.  
 2. If Peak Result complies with AV limit, AV Result is deemed to comply with AV limit.  
 3. Peak: Peak detector.  
 4. Filter losses were only considered in the spurious frequency bands and the authorized band was not corrected for High Pass Filter losses.  
 5. Proper operation of the transmitter prior to adding the filter to the measurement chain.  
 6. Since non-restricted band peak emissions are less than the average limit, they also comply with the -27dBm/MHz (68.2dBuV/m) limit.



**HARMONICS AND SPURIOUS EMISSIONS (MID CHANNEL, HORIZONTAL)**

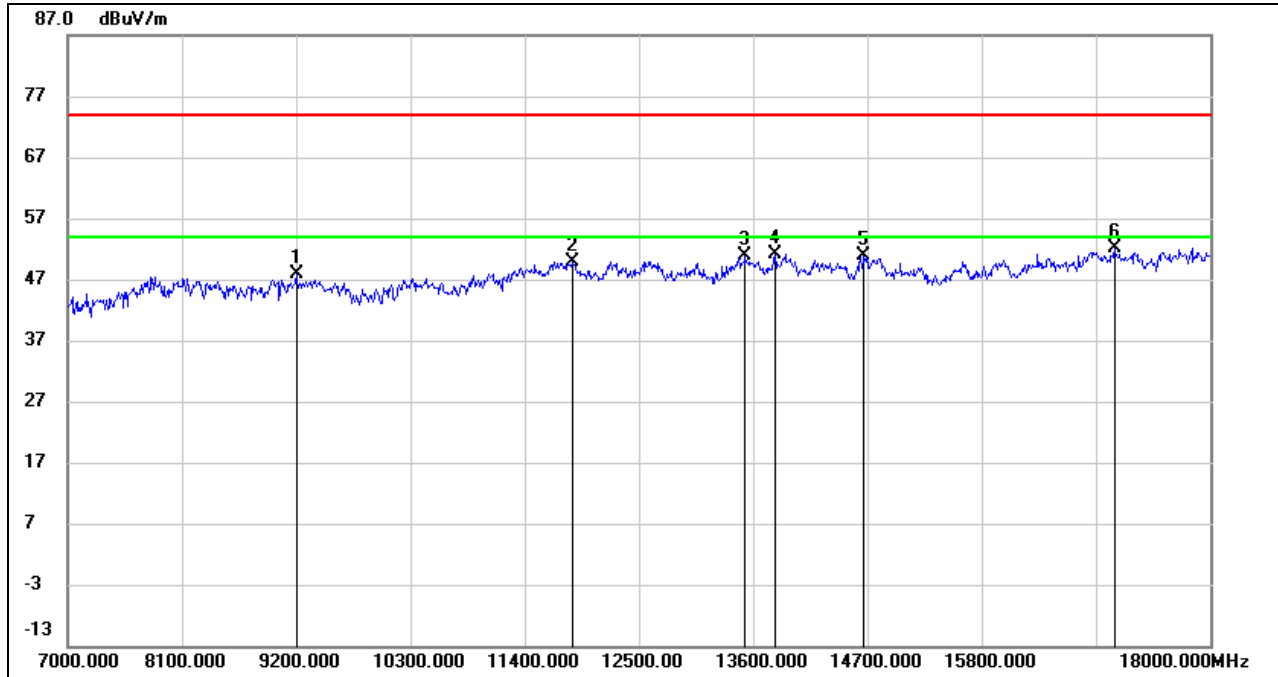

No.	Frequency (MHz)	Reading (dBuV)	Correct (dB/m)	Result (dBuV/m)	Limit (dBuV/m)	Margin (dB)	Remark
1	9200.000	38.04	9.91	47.95	74.00	-26.05	peak
2	11862.000	34.48	15.41	49.89	74.00	-24.11	peak
3	13523.000	33.76	17.19	50.95	74.00	-23.05	peak
4	13809.000	33.60	17.60	51.20	74.00	-22.80	peak
5	14667.000	33.37	17.58	50.95	74.00	-23.05	peak
6	17076.000	30.30	21.74	52.04	74.00	-21.96	peak

Note: 1. Measurement = Reading Level + Correct Factor.  
 2. If Peak Result complies with AV limit, AV Result is deemed to comply with AV limit.  
 3. Peak: Peak detector.  
 4. Filter losses were only considered in the spurious frequency bands and the authorized band was not corrected for High Pass Filter losses.  
 5. Proper operation of the transmitter prior to adding the filter to the measurement chain.  
 6. Since non-restricted band peak emissions are less than the average limit, they also comply with the -27dBm/MHz (68.2dBuV/m) limit.

**HARMONICS AND SPURIOUS EMISSIONS (MID CHANNEL, VERTICAL)**

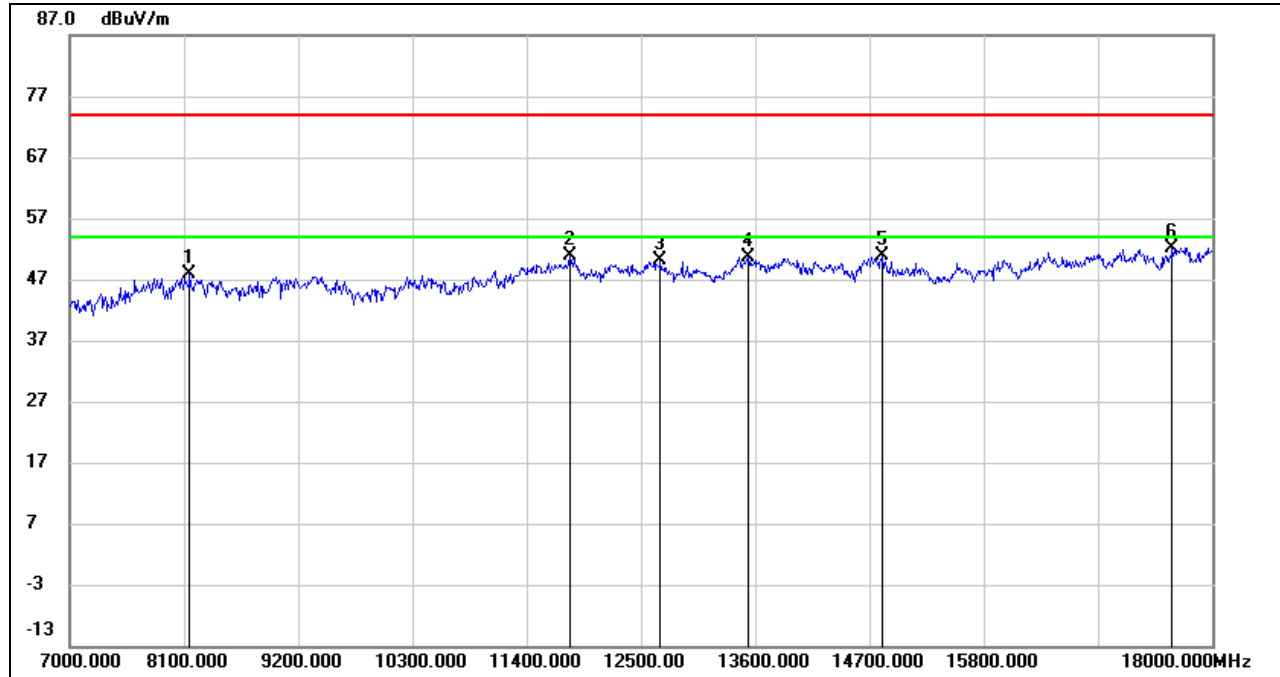

No.	Frequency (MHz)	Reading (dBuV)	Correct (dB/m)	Result (dBuV/m)	Limit (dBuV/m)	Margin (dB)	Remark
1	8155.000	37.98	9.98	47.96	74.00	-26.04	peak
2	11818.000	35.57	15.29	50.86	74.00	-23.14	peak
3	12687.000	34.54	15.64	50.18	74.00	-23.82	peak
4	13534.000	33.34	17.18	50.52	74.00	-23.48	peak
5	14821.000	32.95	17.90	50.85	74.00	-23.15	peak
6	17615.000	29.38	22.84	52.22	74.00	-21.78	peak

- Note: 1. Measurement = Reading Level + Correct Factor.  
 2. If Peak Result complies with AV limit, AV Result is deemed to comply with AV limit.  
 3. Peak: Peak detector.  
 4. Filter losses were only considered in the spurious frequency bands and the authorized band was not corrected for High Pass Filter losses.  
 5. Proper operation of the transmitter prior to adding the filter to the measurement chain.  
 6. Since non-restricted band peak emissions are less than the average limit, they also comply with the -27dBm/MHz (68.2dBuV/m) limit.



**HARMONICS AND SPURIOUS EMISSIONS (HIGH CHANNEL, HORIZONTAL)**

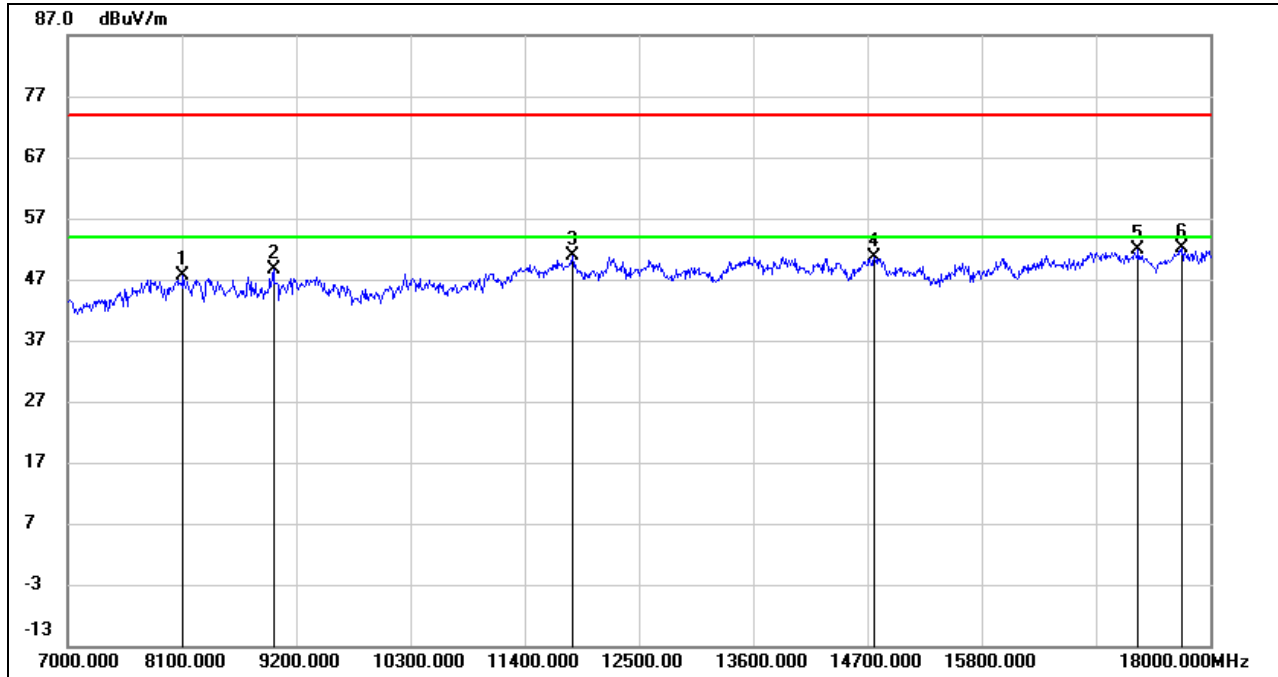

No.	Frequency (MHz)	Reading (dBuV)	Correct (dB/m)	Result (dBuV/m)	Limit (dBuV/m)	Margin (dB)	Remark
1	8111.000	37.48	10.14	47.62	74.00	-26.38	peak
2	8980.000	37.63	10.89	48.52	74.00	-25.48	peak
3	11862.000	35.39	15.41	50.80	74.00	-23.20	peak
4	14766.000	32.60	17.92	50.52	74.00	-23.48	peak
5	17307.000	29.29	22.56	51.85	74.00	-22.15	peak
6	17725.000	28.45	23.61	52.06	74.00	-21.94	peak

- Note: 1. Measurement = Reading Level + Correct Factor.  
 2. If Peak Result complies with AV limit, AV Result is deemed to comply with AV limit.  
 3. Peak: Peak detector.  
 4. Filter losses were only considered in the spurious frequency bands and the authorized band was not corrected for High Pass Filter losses.  
 5. Proper operation of the transmitter prior to adding the filter to the measurement chain.  
 6. Since non-restricted band peak emissions are less than the average limit, they also comply with the -27dBm/MHz (68.2dBuV/m) limit.

**HARMONICS AND SPURIOUS EMISSIONS (HIGH CHANNEL, VERTICAL)**

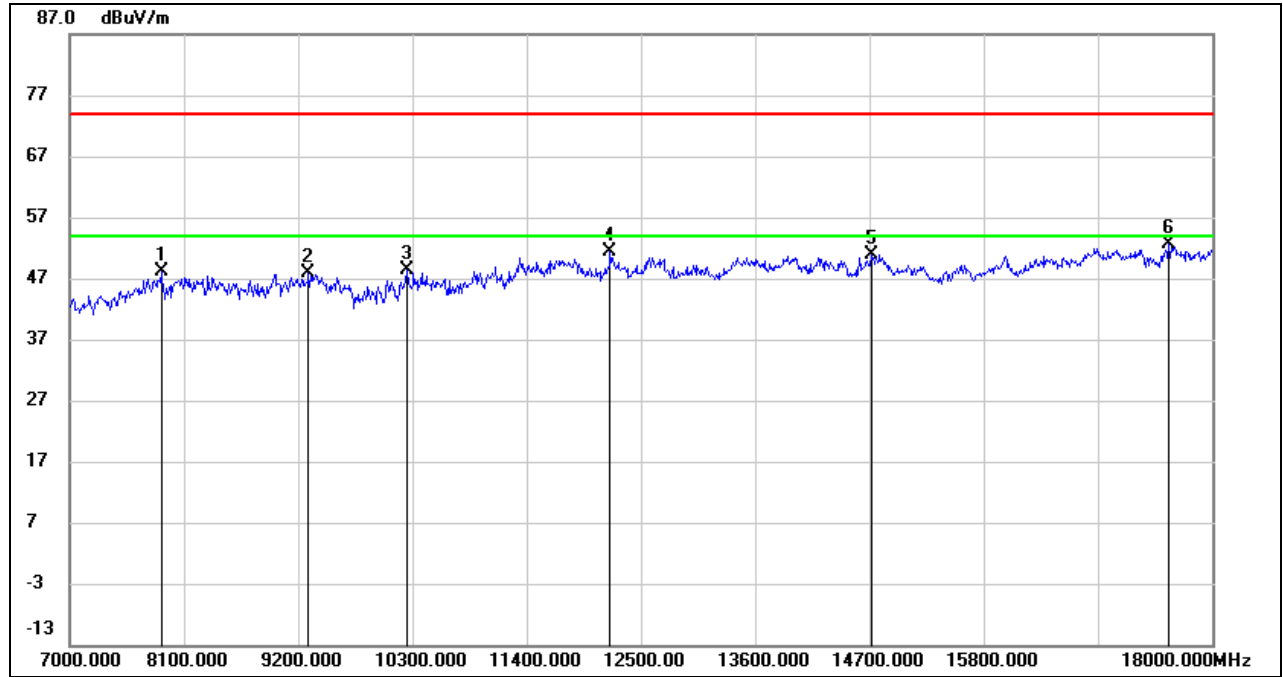

No.	Frequency (MHz)	Reading (dBuV)	Correct (dB/m)	Result (dBuV/m)	Limit (dBuV/m)	Margin (dB)	Remark
1	7880.000	39.24	8.95	48.19	74.00	-25.81	peak
2	9299.000	37.37	10.40	47.77	74.00	-26.23	peak
3	10245.000	36.71	11.63	48.34	74.00	-25.66	peak
4	12203.000	35.34	15.95	51.29	74.00	-22.71	peak
5	14722.000	33.14	17.77	50.91	74.00	-23.09	peak
6	17582.000	30.00	22.60	52.60	74.00	-21.40	peak

- Note: 1. Measurement = Reading Level + Correct Factor.  
 2. If Peak Result complies with AV limit, AV Result is deemed to comply with AV limit.  
 3. Peak: Peak detector.  
 4. Filter losses were only considered in the spurious frequency bands and the authorized band was not corrected for High Pass Filter losses.  
 5. Proper operation of the transmitter prior to adding the filter to the measurement chain.  
 6. Since non-restricted band peak emissions are less than the average limit, they also comply with the -27dBm/MHz (68.2dBuV/m) limit.

**STRADDLE CHANNEL 144**

**HARMONICS AND SPURIOUS EMISSIONS (HORIZONTAL)**

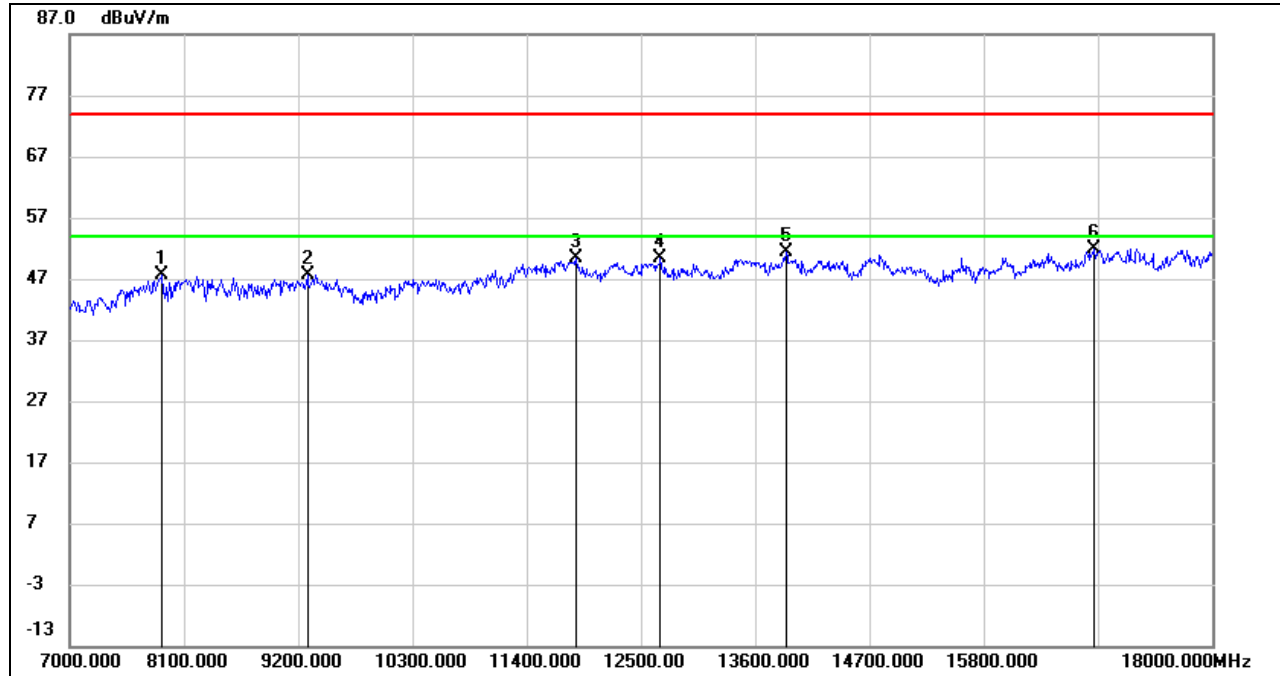

No.	Frequency (MHz)	Reading (dBuV)	Correct (dB/m)	Result (dBuV/m)	Limit (dBuV/m)	Margin (dB)	Remark
1	7891.000	38.68	8.90	47.58	74.00	-26.42	peak
2	9288.000	37.33	10.34	47.67	74.00	-26.33	peak
3	11873.000	34.86	15.44	50.30	74.00	-23.70	peak
4	12687.000	34.85	15.64	50.49	74.00	-23.51	peak
5	13897.000	33.75	17.52	51.27	74.00	-22.73	peak
6	16867.000	30.70	21.29	51.99	74.00	-22.01	peak

Note: 1. Measurement = Reading Level + Correct Factor.  
 2. If Peak Result complies with AV limit, AV Result is deemed to comply with AV limit.  
 3. Peak: Peak detector.  
 4. Filter losses were only considered in the spurious frequency bands and the authorized band was not corrected for High Pass Filter losses.  
 5. Proper operation of the transmitter prior to adding the filter to the measurement chain.  
 6. Since non-restricted band peak emissions are less than the average limit, they also comply with the -27dBm/MHz (68.2dBuV/m) limit.



**HARMONICS AND SPURIOUS EMISSIONS (VERTICAL)**

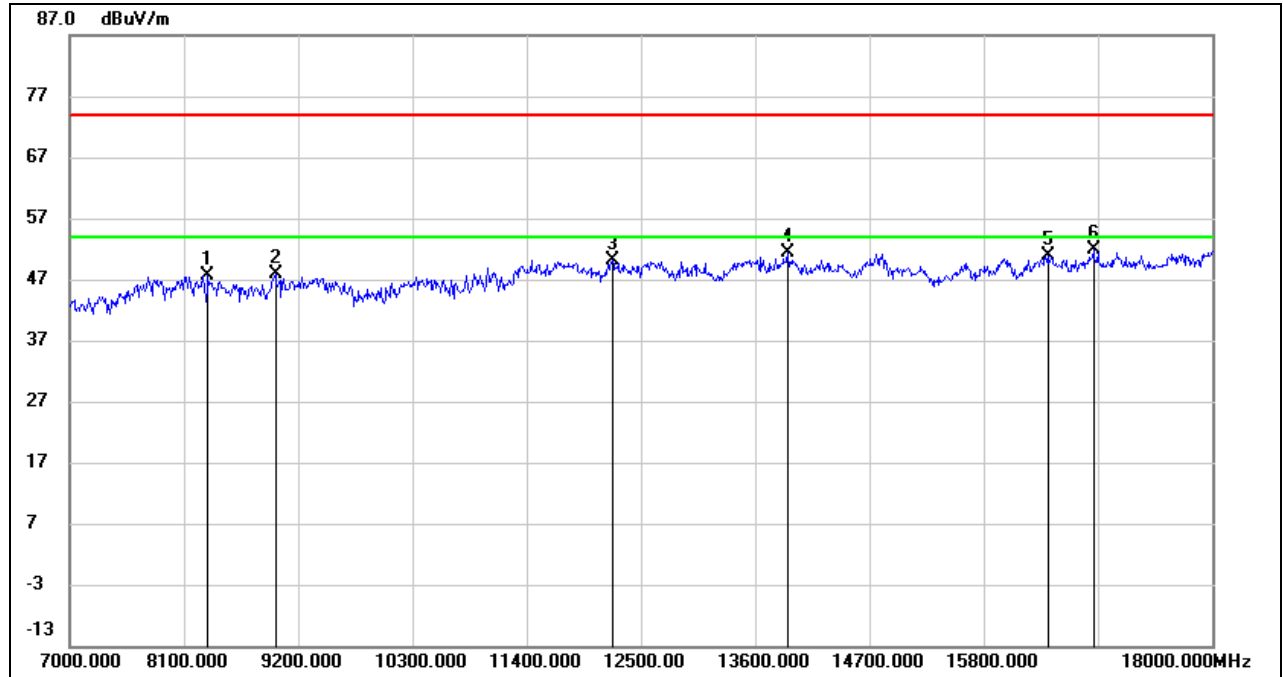

No.	Frequency (MHz)	Reading (dBuV)	Correct (dB/m)	Result (dBuV/m)	Limit (dBuV/m)	Margin (dB)	Remark
1	8331.000	38.10	9.58	47.68	74.00	-26.32	peak
2	8980.000	36.88	10.89	47.77	74.00	-26.23	peak
3	12225.000	34.24	15.99	50.23	74.00	-23.77	peak
4	13908.000	33.75	17.54	51.29	74.00	-22.71	peak
5	16416.000	31.24	19.68	50.92	74.00	-23.08	peak
6	16856.000	30.63	21.19	51.82	74.00	-22.18	peak

Note: 1. Measurement = Reading Level + Correct Factor.  
 2. If Peak Result complies with AV limit, AV Result is deemed to comply with AV limit.  
 3. Peak: Peak detector.  
 4. Filter losses were only considered in the spurious frequency bands and the authorized band was not corrected for High Pass Filter losses.  
 5. Proper operation of the transmitter prior to adding the filter to the measurement chain.  
 6. Since non-restricted band peak emissions are less than the average limit, they also comply with the -27dBm/MHz (68.2dBuV/m) limit.

**UNII-3 BAND**

**HARMONICS AND SPURIOUS EMISSIONS (LOW CHANNEL, HORIZONTAL)**

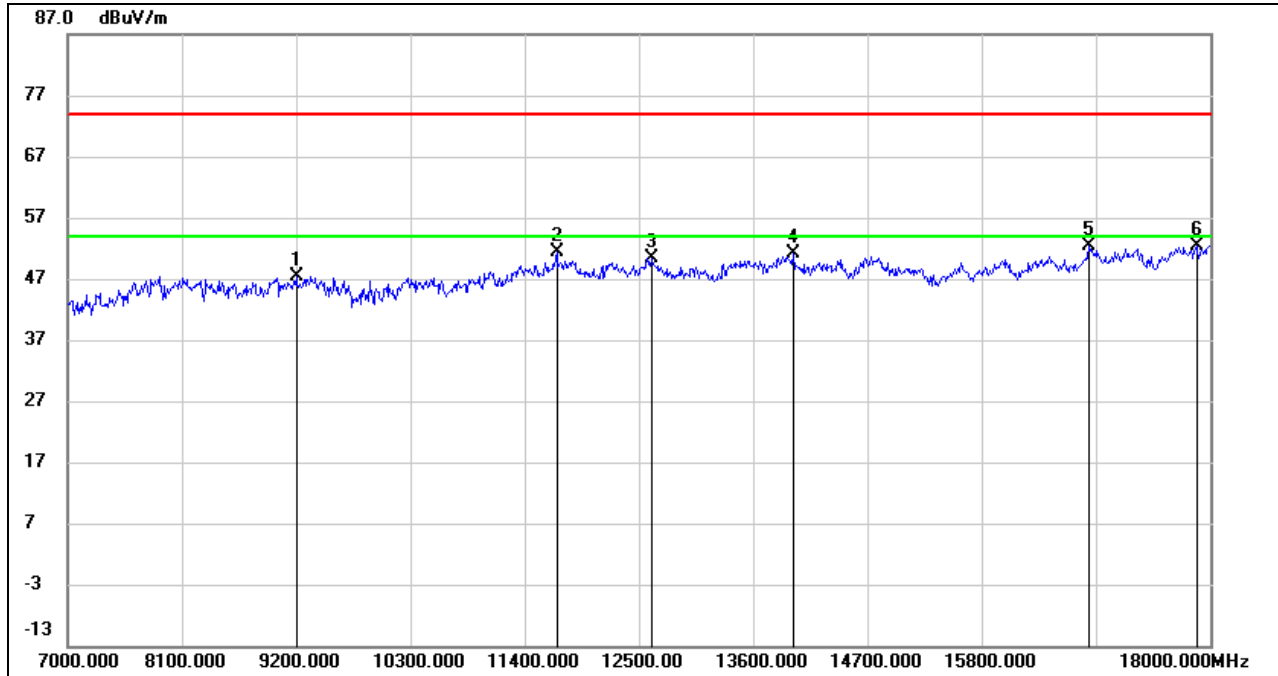

No.	Frequency (MHz)	Reading (dBuV)	Correct (dB/m)	Result (dBuV/m)	Limit (dBuV/m)	Margin (dB)	Remark
1	9200.000	37.56	9.91	47.47	74.00	-26.53	peak
2	11708.000	35.97	15.34	51.31	74.00	-22.69	peak
3	12621.000	34.67	15.75	50.42	74.00	-23.58	peak
4	13985.000	33.37	17.65	51.02	74.00	-22.98	peak
5	16834.000	31.28	21.00	52.28	74.00	-21.72	peak
6	17868.000	28.55	23.94	52.49	74.00	-21.51	peak

Note: 1. Measurement = Reading Level + Correct Factor.  
 2. If Peak Result complies with AV limit, AV Result is deemed to comply with AV limit.  
 3. Peak: Peak detector.  
 4. Filter losses were only considered in the spurious frequency bands and the authorized band was not corrected for High Pass Filter losses.  
 5. Proper operation of the transmitter prior to adding the filter to the measurement chain.  
 6. Since non-restricted band peak emissions are less than the average limit, they also comply with the -27dBm/MHz (68.2dBuV/m) limit.





**HARMONICS AND SPURIOUS EMISSIONS (LOW CHANNEL, VERTICAL)**

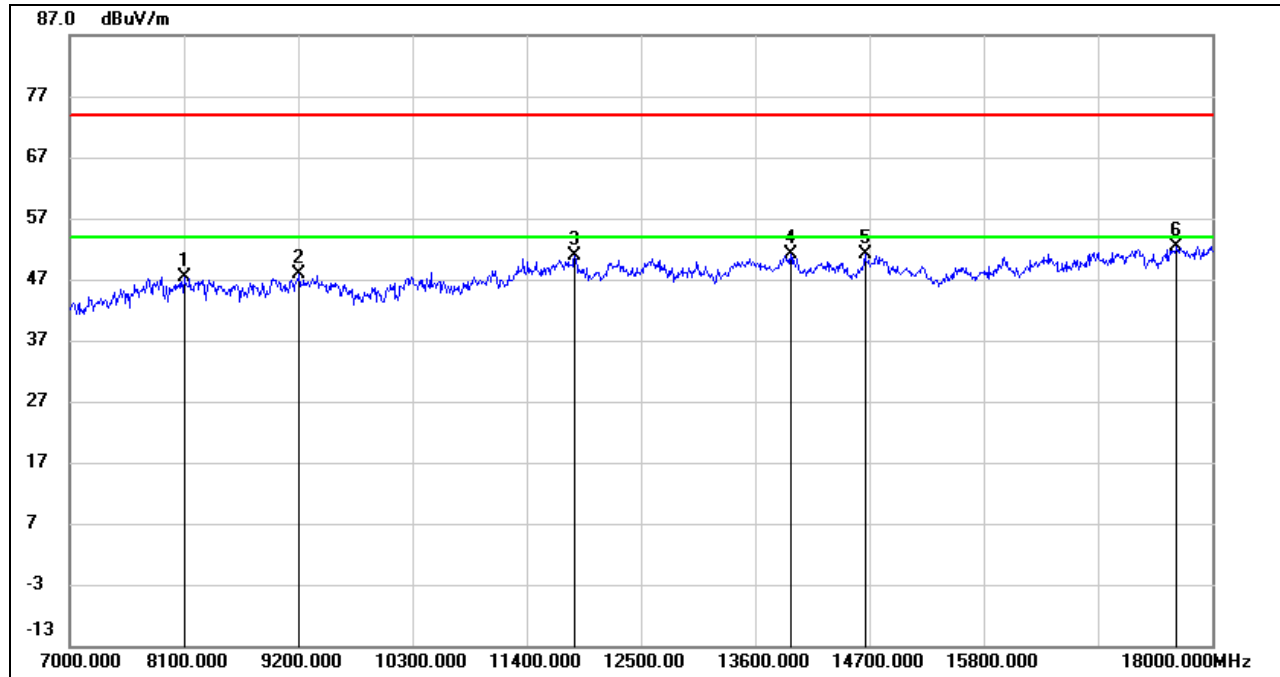

No.	Frequency (MHz)	Reading (dBuV)	Correct (dB/m)	Result (dBuV/m)	Limit (dBuV/m)	Margin (dB)	Remark
1	8100.000	37.12	10.18	47.30	74.00	-26.70	peak
2	9211.000	38.01	9.96	47.97	74.00	-26.03	peak
3	11862.000	35.39	15.41	50.80	74.00	-23.20	peak
4	13941.000	33.64	17.58	51.22	74.00	-22.78	peak
5	14656.000	33.50	17.55	51.05	74.00	-22.95	peak
6	17659.000	29.29	23.17	52.46	74.00	-21.54	peak

Note: 1. Measurement = Reading Level + Correct Factor.  
 2. If Peak Result complies with AV limit, AV Result is deemed to comply with AV limit.  
 3. Peak: Peak detector.  
 4. Filter losses were only considered in the spurious frequency bands and the authorized band was not corrected for High Pass Filter losses.  
 5. Proper operation of the transmitter prior to adding the filter to the measurement chain.  
 6. Since non-restricted band peak emissions are less than the average limit, they also comply with the -27dBm/MHz (68.2dBuV/m) limit.

**HARMONICS AND SPURIOUS EMISSIONS (MID CHANNEL, HORIZONTAL)**

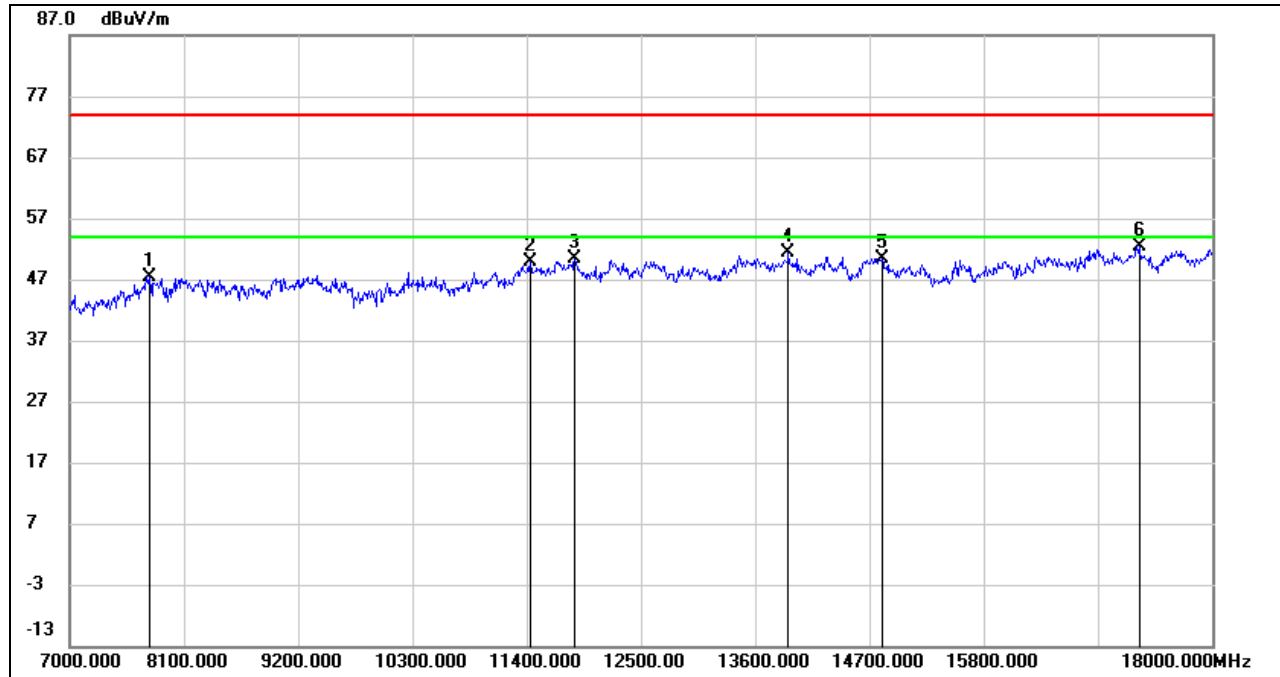

No.	Frequency (MHz)	Reading (dBuV)	Correct (dB/m)	Result (dBuV/m)	Limit (dBuV/m)	Margin (dB)	Remark
1	7770.000	38.29	9.09	47.38	74.00	-26.62	peak
2	11433.000	35.22	14.73	49.95	74.00	-24.05	peak
3	11862.000	35.00	15.41	50.41	74.00	-23.59	peak
4	13919.000	33.83	17.55	51.38	74.00	-22.62	peak
5	14821.000	32.59	17.90	50.49	74.00	-23.51	peak
6	17296.000	29.91	22.59	52.50	74.00	-21.50	peak

- Note: 1. Measurement = Reading Level + Correct Factor.  
 2. If Peak Result complies with AV limit, AV Result is deemed to comply with AV limit.  
 3. Peak: Peak detector.  
 4. Filter losses were only considered in the spurious frequency bands and the authorized band was not corrected for High Pass Filter losses.  
 5. Proper operation of the transmitter prior to adding the filter to the measurement chain.  
 6. Since non-restricted band peak emissions are less than the average limit, they also comply with the -27dBm/MHz (68.2dBuV/m) limit.

**HARMONICS AND SPURIOUS EMISSIONS (MID CHANNEL, VERTICAL)**

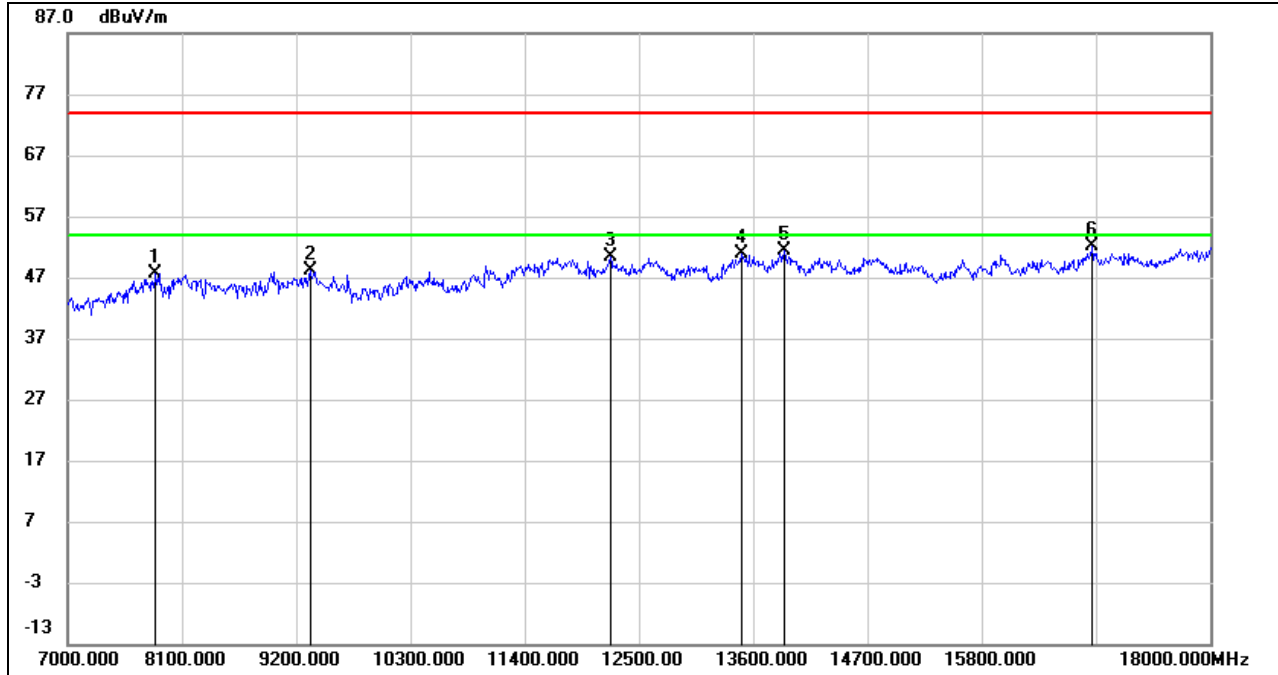

No.	Frequency (MHz)	Reading (dBuV)	Correct (dB/m)	Result (dBuV/m)	Limit (dBuV/m)	Margin (dB)	Remark
1	7847.000	38.58	9.12	47.70	74.00	-26.30	peak
2	9332.000	37.56	10.59	48.15	74.00	-25.85	peak
3	12225.000	34.34	15.99	50.33	74.00	-23.67	peak
4	13490.000	33.79	17.20	50.99	74.00	-23.01	peak
5	13897.000	33.91	17.52	51.43	74.00	-22.57	peak
6	16867.000	30.91	21.29	52.20	74.00	-21.80	peak

Note: 1. Measurement = Reading Level + Correct Factor.  
 2. If Peak Result complies with AV limit, AV Result is deemed to comply with AV limit.  
 3. Peak: Peak detector.  
 4. Filter losses were only considered in the spurious frequency bands and the authorized band was not corrected for High Pass Filter losses.  
 5. Proper operation of the transmitter prior to adding the filter to the measurement chain.  
 6. Since non-restricted band peak emissions are less than the average limit, they also comply with the -27dBm/MHz (68.2dBuV/m) limit.



**HARMONICS AND SPURIOUS EMISSIONS (HIGH CHANNEL, HORIZONTAL)**

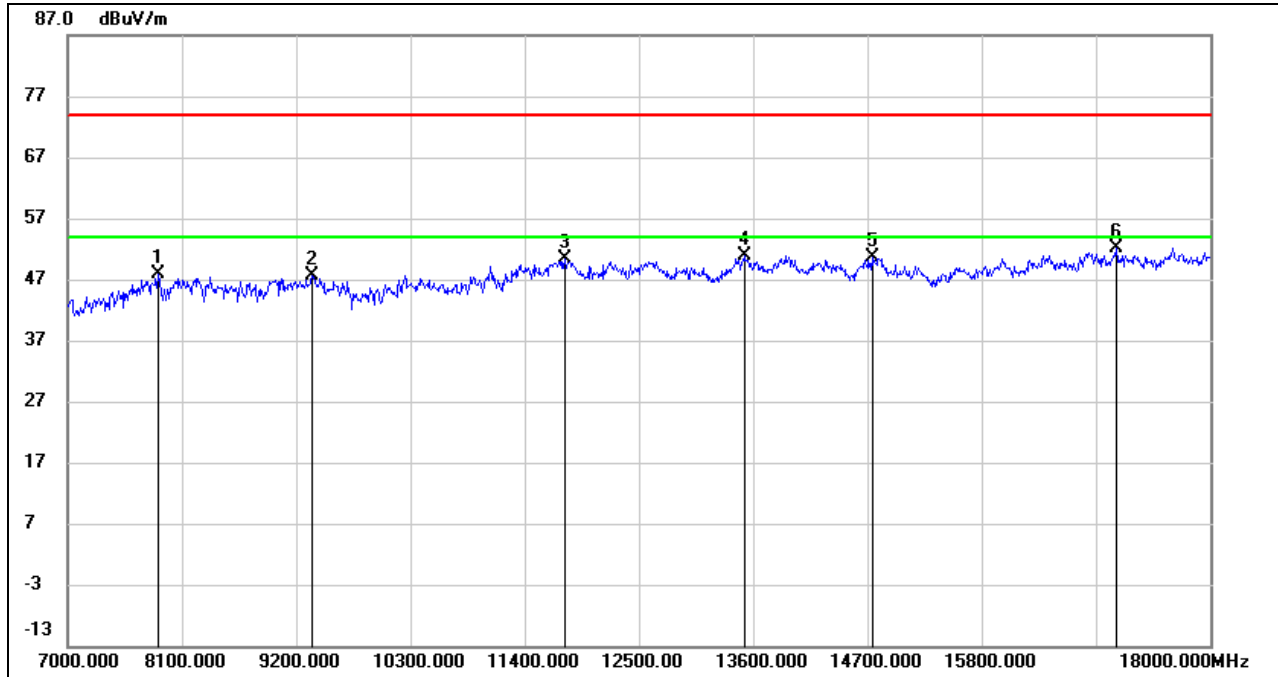

No.	Frequency (MHz)	Reading (dBuV)	Correct (dB/m)	Result (dBuV/m)	Limit (dBuV/m)	Margin (dB)	Remark
1	7869.000	38.96	9.02	47.98	74.00	-26.02	peak
2	9354.000	36.91	10.70	47.61	74.00	-26.39	peak
3	11785.000	35.11	15.25	50.36	74.00	-23.64	peak
4	13512.000	33.80	17.20	51.00	74.00	-23.00	peak
5	14744.000	32.74	17.84	50.58	74.00	-23.42	peak
6	17098.000	30.19	21.89	52.08	74.00	-21.92	peak

Note: 1. Measurement = Reading Level + Correct Factor.  
 2. If Peak Result complies with AV limit, AV Result is deemed to comply with AV limit.  
 3. Peak: Peak detector.  
 4. Filter losses were only considered in the spurious frequency bands and the authorized band was not corrected for High Pass Filter losses.  
 5. Proper operation of the transmitter prior to adding the filter to the measurement chain.  
 6. Since non-restricted band peak emissions are less than the average limit, they also comply with the -27dBm/MHz (68.2dBuV/m) limit.

**HARMONICS AND SPURIOUS EMISSIONS (HIGH CHANNEL, VERTICAL)**

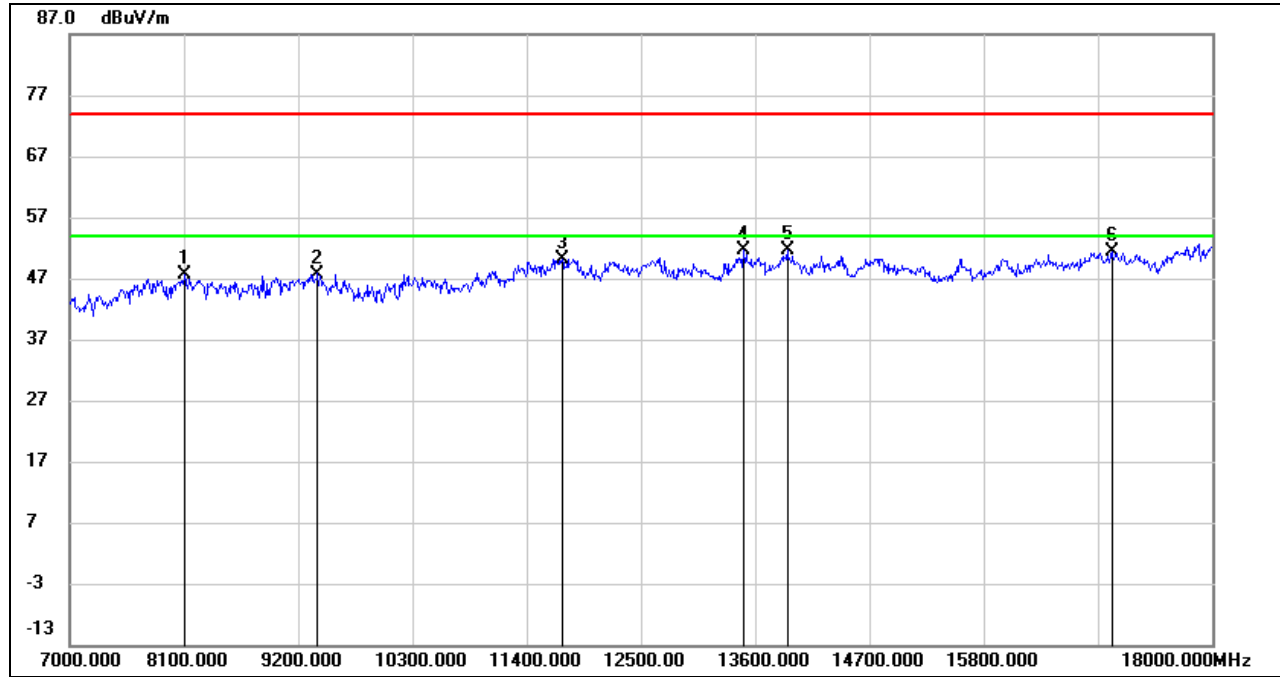

No.	Frequency (MHz)	Reading (dBuV)	Correct (dB/m)	Result (dBuV/m)	Limit (dBuV/m)	Margin (dB)	Remark
1	8111.000	37.37	10.14	47.51	74.00	-26.49	peak
2	9387.000	36.86	10.89	47.75	74.00	-26.25	peak
3	11741.000	34.95	15.30	50.25	74.00	-23.75	peak
4	13490.000	34.39	17.20	51.59	74.00	-22.41	peak
5	13908.000	33.97	17.54	51.51	74.00	-22.49	peak
6	17032.000	29.85	21.46	51.31	74.00	-22.69	peak

Note: 1. Measurement = Reading Level + Correct Factor.  
 2. If Peak Result complies with AV limit, AV Result is deemed to comply with AV limit.  
 3. Peak: Peak detector.  
 4. Filter losses were only considered in the spurious frequency bands and the authorized band was not corrected for High Pass Filter losses.  
 5. Proper operation of the transmitter prior to adding the filter to the measurement chain.  
 6. Since non-restricted band peak emissions are less than the average limit, they also comply with the -27dBm/MHz (68.2dBuV/m) limit.

**8.3.3. 802.11n HT40 MODE**

**UNII-1 BAND**

**HARMONICS AND SPURIOUS EMISSIONS (LOW CHANNEL, HORIZONTAL)**

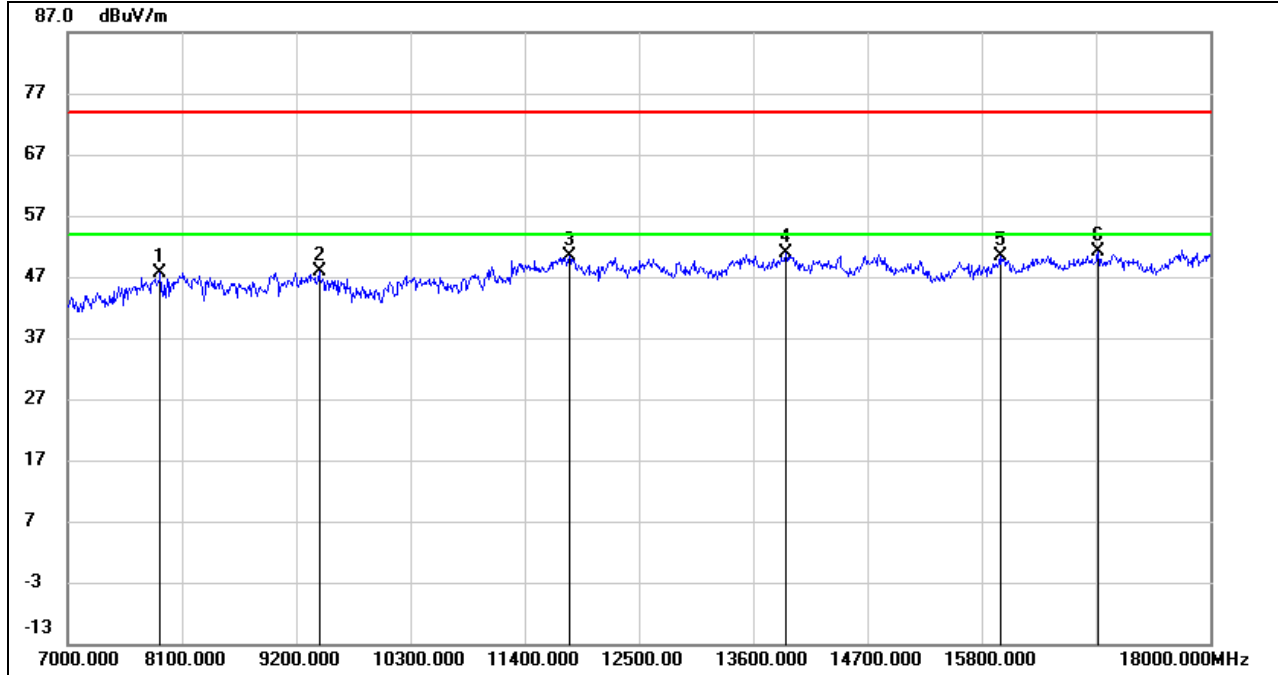

No.	Frequency (MHz)	Reading (dBuV)	Correct (dB/m)	Result (dBuV/m)	Limit (dBuV/m)	Margin (dB)	Remark
1	7891.000	38.76	8.90	47.66	74.00	-26.34	peak
2	9420.000	36.92	10.88	47.80	74.00	-26.20	peak
3	11829.000	35.13	15.32	50.45	74.00	-23.55	peak
4	13919.000	33.43	17.55	50.98	74.00	-23.02	peak
5	15976.000	32.01	18.34	50.35	74.00	-23.65	peak
6	16922.000	29.60	21.49	51.09	74.00	-22.91	peak

- Note: 1. Measurement = Reading Level + Correct Factor.  
 2. If Peak Result complies with AV limit, AV Result is deemed to comply with AV limit.  
 3. Peak: Peak detector.  
 4. Filter losses were only considered in the spurious frequency bands and the authorized band was not corrected for High Pass Filter losses.  
 5. Proper operation of the transmitter prior to adding the filter to the measurement chain.  
 6. Since non-restricted band peak emissions are less than the average limit, they also comply with the -27dBm/MHz (68.2dBuV/m) limit.

**HARMONICS AND SPURIOUS EMISSIONS (LOW CHANNEL, VERTICAL)**

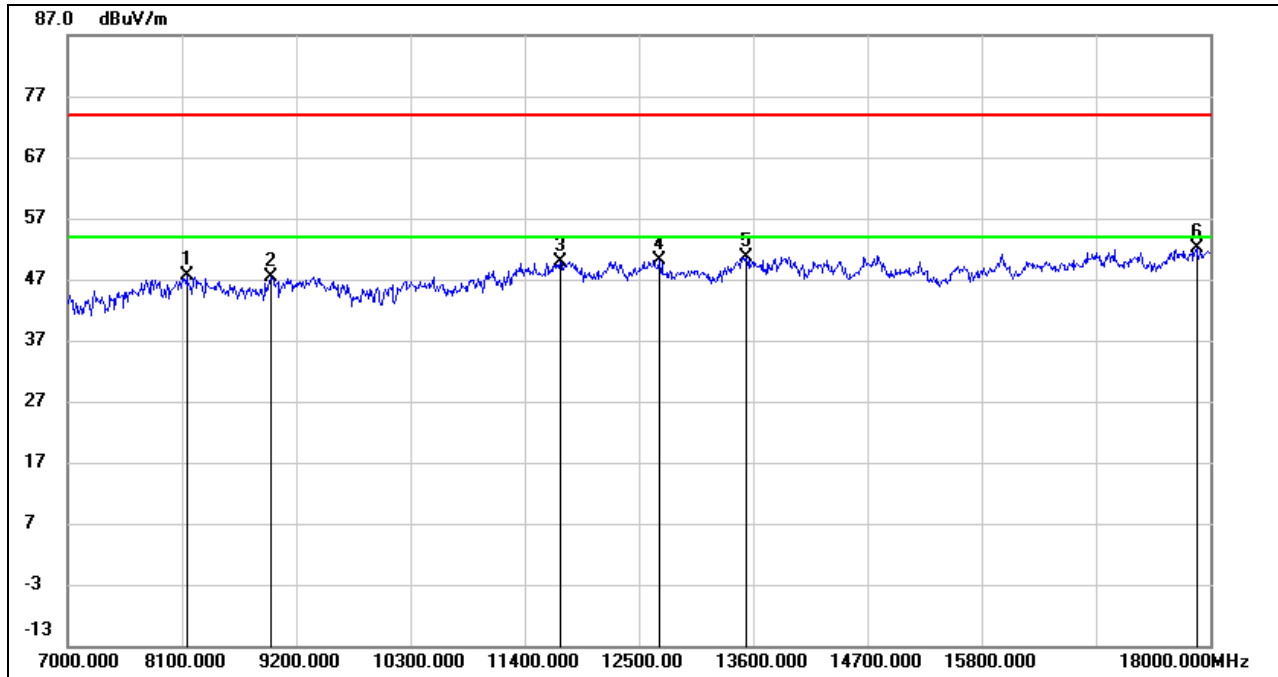

No.	Frequency (MHz)	Reading (dBuV)	Correct (dB/m)	Result (dBuV/m)	Limit (dBuV/m)	Margin (dB)	Remark
1	8144.000	37.63	10.02	47.65	74.00	-26.35	peak
2	8958.000	36.90	10.48	47.38	74.00	-26.62	peak
3	11741.000	34.58	15.30	49.88	74.00	-24.12	peak
4	12698.000	34.48	15.62	50.10	74.00	-23.90	peak
5	13534.000	33.55	17.18	50.73	74.00	-23.27	peak
6	17868.000	28.15	23.94	52.09	74.00	-21.91	peak

Note: 1. Measurement = Reading Level + Correct Factor.  
 2. If Peak Result complies with AV limit, AV Result is deemed to comply with AV limit.  
 3. Peak: Peak detector.  
 4. Filter losses were only considered in the spurious frequency bands and the authorized band was not corrected for High Pass Filter losses.  
 5. Proper operation of the transmitter prior to adding the filter to the measurement chain.  
 6. Since non-restricted band peak emissions are less than the average limit, they also comply with the -27dBm/MHz (68.2dBuV/m) limit.

**HARMONICS AND SPURIOUS EMISSIONS (HIGH CHANNEL, HORIZONTAL)**

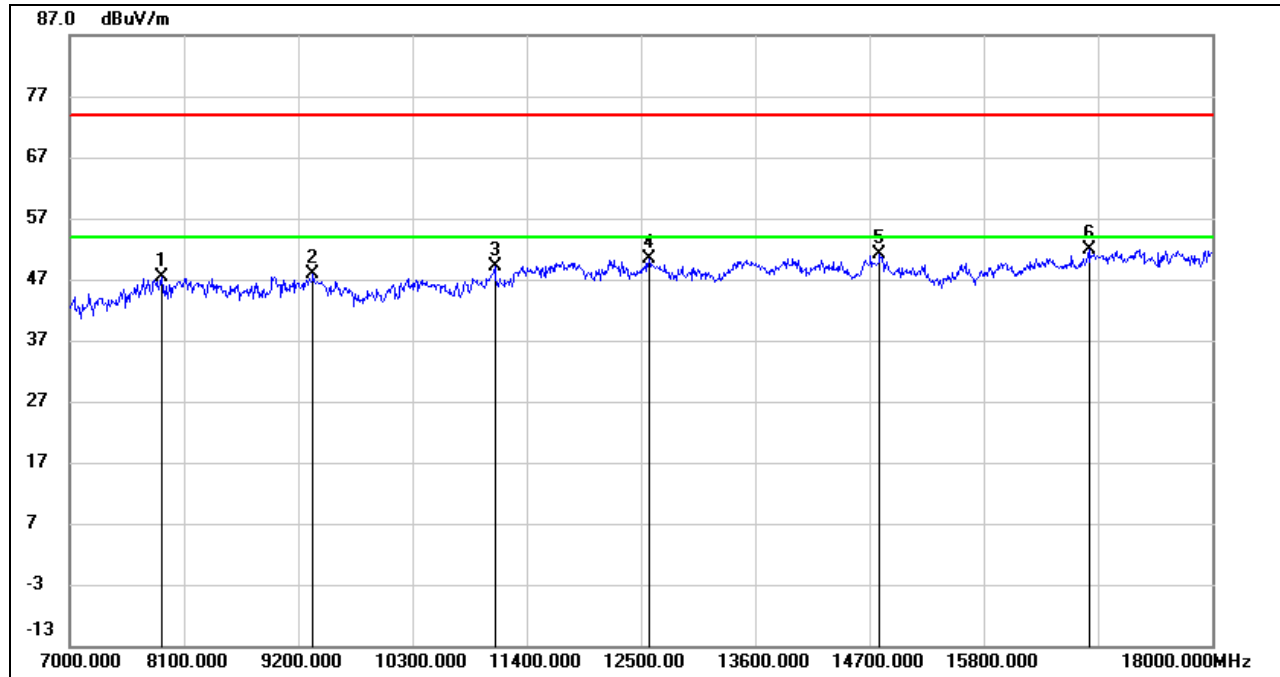

No.	Frequency (MHz)	Reading (dBuV)	Correct (dB/m)	Result (dBuV/m)	Limit (dBuV/m)	Margin (dB)	Remark
1	7891.000	38.38	8.90	47.28	74.00	-26.72	peak
2	9343.000	37.32	10.64	47.96	74.00	-26.04	peak
3	11092.000	35.41	13.75	49.16	74.00	-24.84	peak
4	12577.000	34.59	15.75	50.34	74.00	-23.66	peak
5	14799.000	33.14	18.04	51.18	74.00	-22.82	peak
6	16812.000	31.10	20.81	51.91	74.00	-22.09	peak

Note: 1. Measurement = Reading Level + Correct Factor.  
 2. If Peak Result complies with AV limit, AV Result is deemed to comply with AV limit.  
 3. Peak: Peak detector.  
 4. Filter losses were only considered in the spurious frequency bands and the authorized band was not corrected for High Pass Filter losses.  
 5. Proper operation of the transmitter prior to adding the filter to the measurement chain.  
 6. Since non-restricted band peak emissions are less than the average limit, they also comply with the -27dBm/MHz (68.2dBuV/m) limit.





**HARMONICS AND SPURIOUS EMISSIONS (HIGH CHANNEL, VERTICAL)**

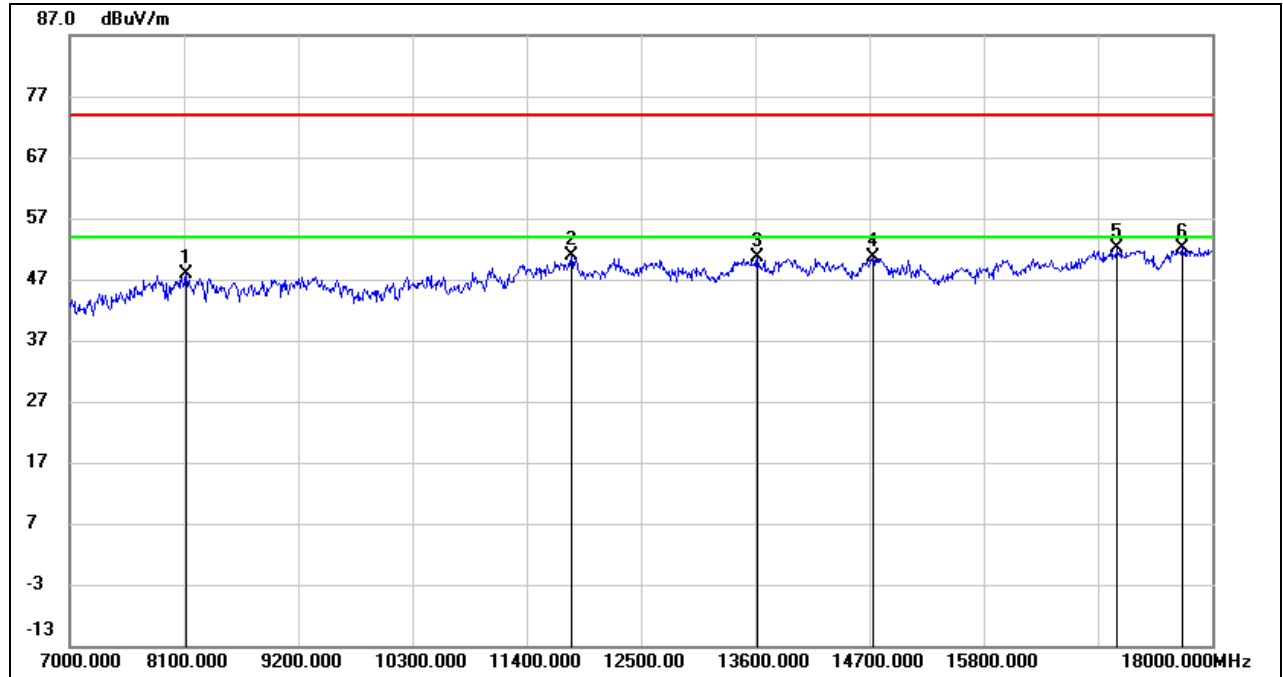

No.	Frequency (MHz)	Reading (dBuV)	Correct (dB/m)	Result (dBuV/m)	Limit (dBuV/m)	Margin (dB)	Remark
1	8122.000	37.78	10.10	47.88	74.00	-26.12	peak
2	11829.000	35.67	15.32	50.99	74.00	-23.01	peak
3	13622.000	33.37	17.20	50.57	74.00	-23.43	peak
4	14733.000	32.92	17.81	50.73	74.00	-23.27	peak
5	17087.000	30.36	21.81	52.17	74.00	-21.83	peak
6	17714.000	28.66	23.55	52.21	74.00	-21.79	peak

- Note: 1. Measurement = Reading Level + Correct Factor.  
 2. If Peak Result complies with AV limit, AV Result is deemed to comply with AV limit.  
 3. Peak: Peak detector.  
 4. Filter losses were only considered in the spurious frequency bands and the authorized band was not corrected for High Pass Filter losses.  
 5. Proper operation of the transmitter prior to adding the filter to the measurement chain.  
 6. Since non-restricted band peak emissions are less than the average limit, they also comply with the -27dBm/MHz (68.2dBuV/m) limit.



**UNII-2A BAND**

**HARMONICS AND SPURIOUS EMISSIONS (LOW CHANNEL, HORIZONTAL)**

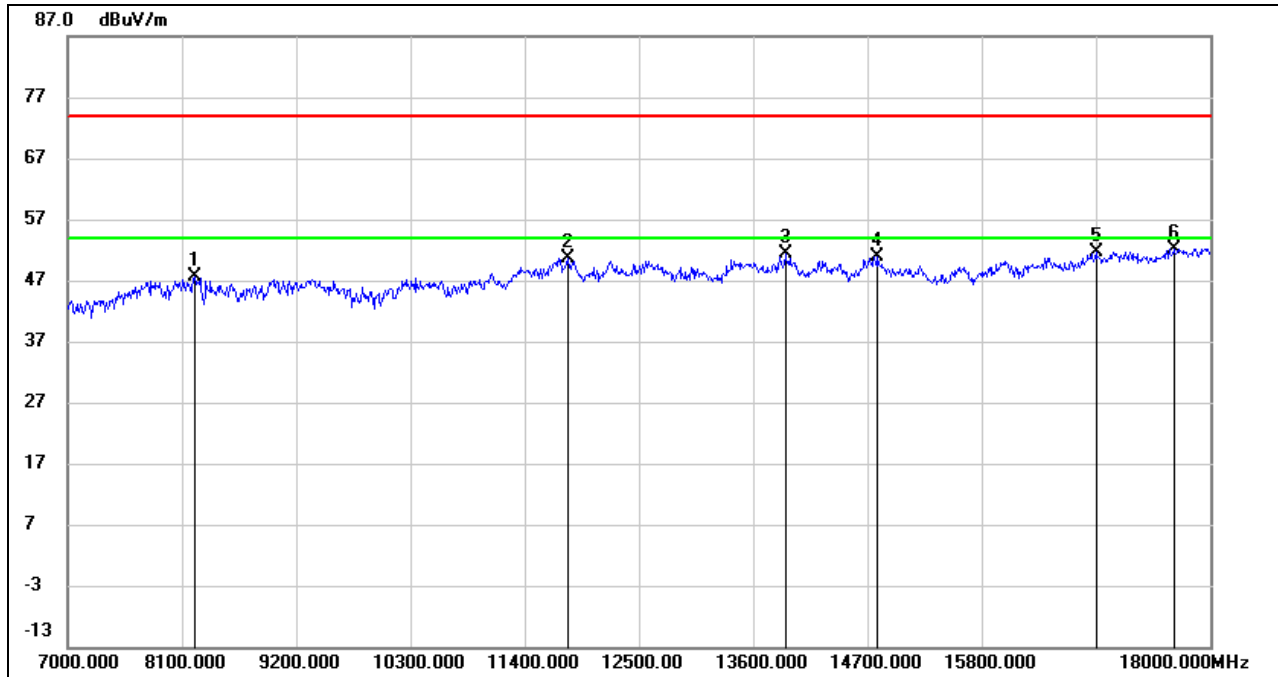

No.	Frequency (MHz)	Reading (dBuV)	Correct (dB/m)	Result (dBuV/m)	Limit (dBuV/m)	Margin (dB)	Remark
1	8221.000	37.89	9.79	47.68	74.00	-26.32	peak
2	11818.000	35.41	15.29	50.70	74.00	-23.30	peak
3	13908.000	33.91	17.54	51.45	74.00	-22.55	peak
4	14799.000	32.76	18.04	50.80	74.00	-23.20	peak
5	16900.000	30.10	21.57	51.67	74.00	-22.33	peak
6	17648.000	29.17	23.08	52.25	74.00	-21.75	peak

Note: 1. Measurement = Reading Level + Correct Factor.  
 2. If Peak Result complies with AV limit, AV Result is deemed to comply with AV limit.  
 3. Peak: Peak detector.  
 4. Filter losses were only considered in the spurious frequency bands and the authorized band was not corrected for High Pass Filter losses.  
 5. Proper operation of the transmitter prior to adding the filter to the measurement chain.  
 6. Since non-restricted band peak emissions are less than the average limit, they also comply with the -27dBm/MHz (68.2dBuV/m) limit.

**HARMONICS AND SPURIOUS EMISSIONS (LOW CHANNEL, VERTICAL)**

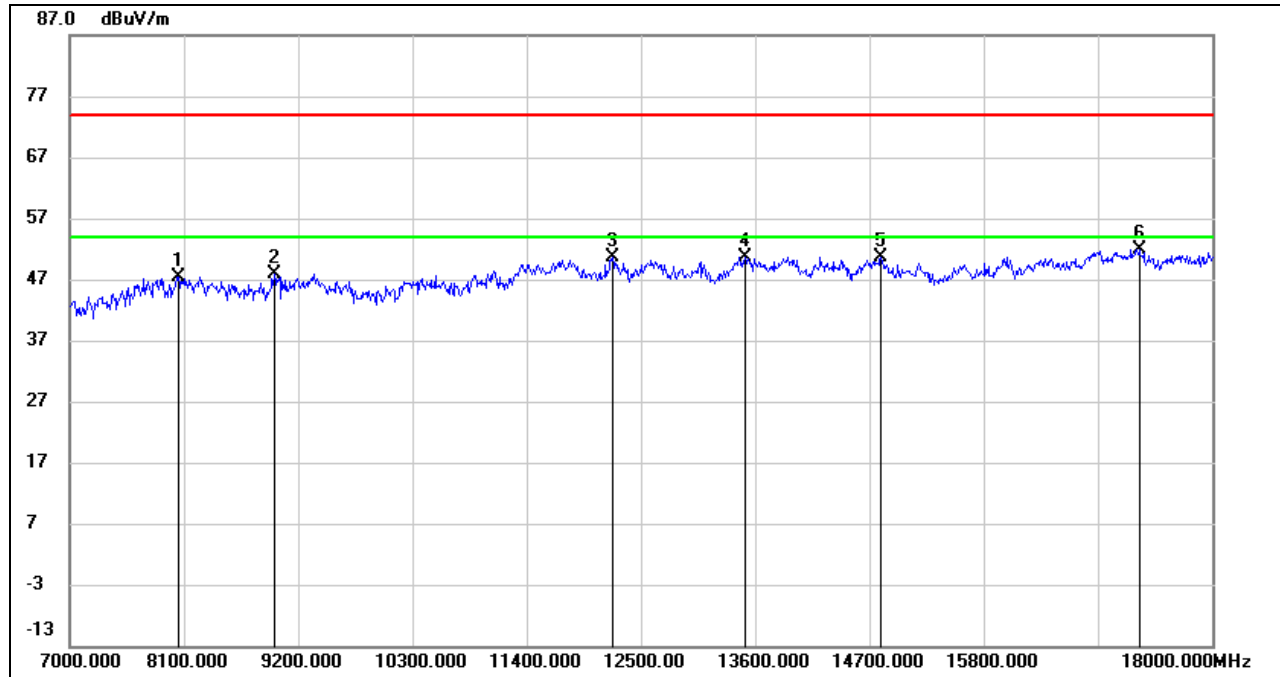

No.	Frequency (MHz)	Reading (dBuV)	Correct (dB/m)	Result (dBuV/m)	Limit (dBuV/m)	Margin (dB)	Remark
1	8045.000	38.02	9.33	47.35	74.00	-26.65	peak
2	8969.000	37.10	10.69	47.79	74.00	-26.21	peak
3	12225.000	34.62	15.99	50.61	74.00	-23.39	peak
4	13501.000	33.38	17.22	50.60	74.00	-23.40	peak
5	14810.000	32.62	17.97	50.59	74.00	-23.41	peak
6	17296.000	29.41	22.59	52.00	74.00	-22.00	peak

- Note: 1. Measurement = Reading Level + Correct Factor.  
 2. If Peak Result complies with AV limit, AV Result is deemed to comply with AV limit.  
 3. Peak: Peak detector.  
 4. Filter losses were only considered in the spurious frequency bands and the authorized band was not corrected for High Pass Filter losses.  
 5. Proper operation of the transmitter prior to adding the filter to the measurement chain.  
 6. Since non-restricted band peak emissions are less than the average limit, they also comply with the -27dBm/MHz (68.2dBuV/m) limit.

**HARMONICS AND SPURIOUS EMISSIONS (HIGH CHANNEL, HORIZONTAL)**

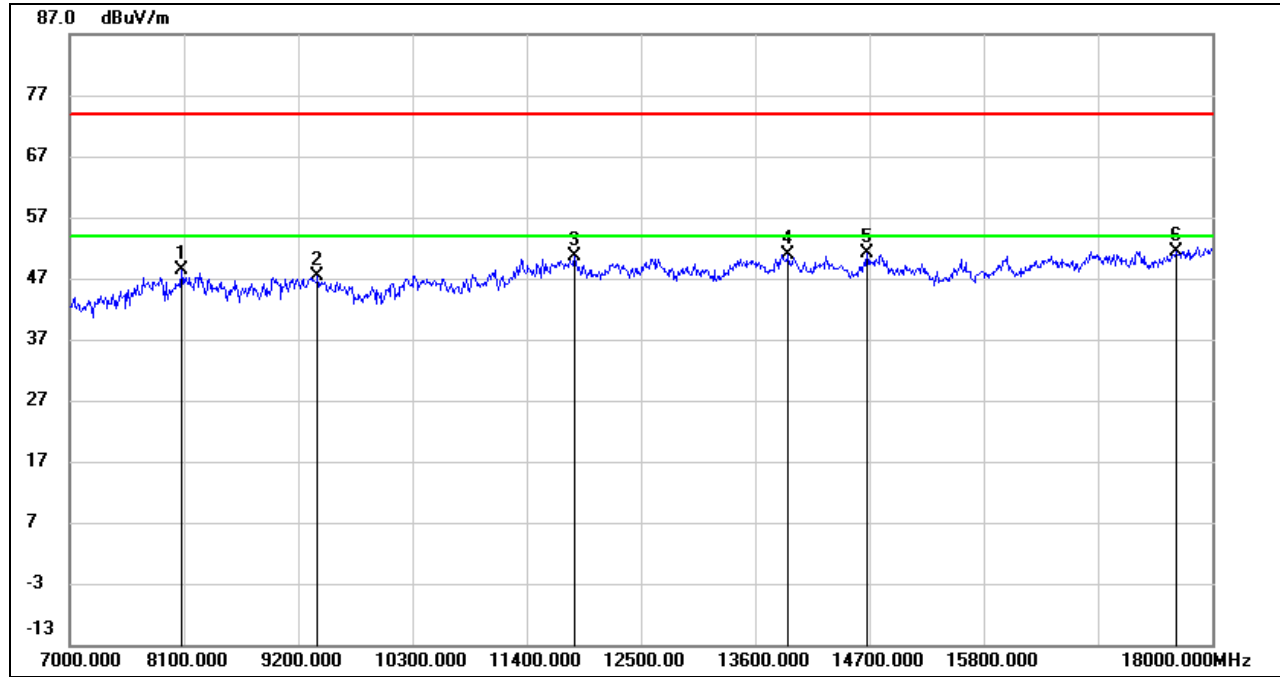

No.	Frequency (MHz)	Reading (dBuV)	Correct (dB/m)	Result (dBuV/m)	Limit (dBuV/m)	Margin (dB)	Remark
1	8078.000	38.64	9.83	48.47	74.00	-25.53	peak
2	9387.000	36.37	10.89	47.26	74.00	-26.74	peak
3	11862.000	35.21	15.41	50.62	74.00	-23.38	peak
4	13919.000	33.43	17.55	50.98	74.00	-23.02	peak
5	14678.000	33.48	17.62	51.10	74.00	-22.90	peak
6	17659.000	28.33	23.17	51.50	74.00	-22.50	peak

Note: 1. Measurement = Reading Level + Correct Factor.  
 2. If Peak Result complies with AV limit, AV Result is deemed to comply with AV limit.  
 3. Peak: Peak detector.  
 4. Filter losses were only considered in the spurious frequency bands and the authorized band was not corrected for High Pass Filter losses.  
 5. Proper operation of the transmitter prior to adding the filter to the measurement chain.  
 6. Since non-restricted band peak emissions are less than the average limit, they also comply with the -27dBm/MHz (68.2dBuV/m) limit.

**HARMONICS AND SPURIOUS EMISSIONS (HIGH CHANNEL, VERTICAL)**

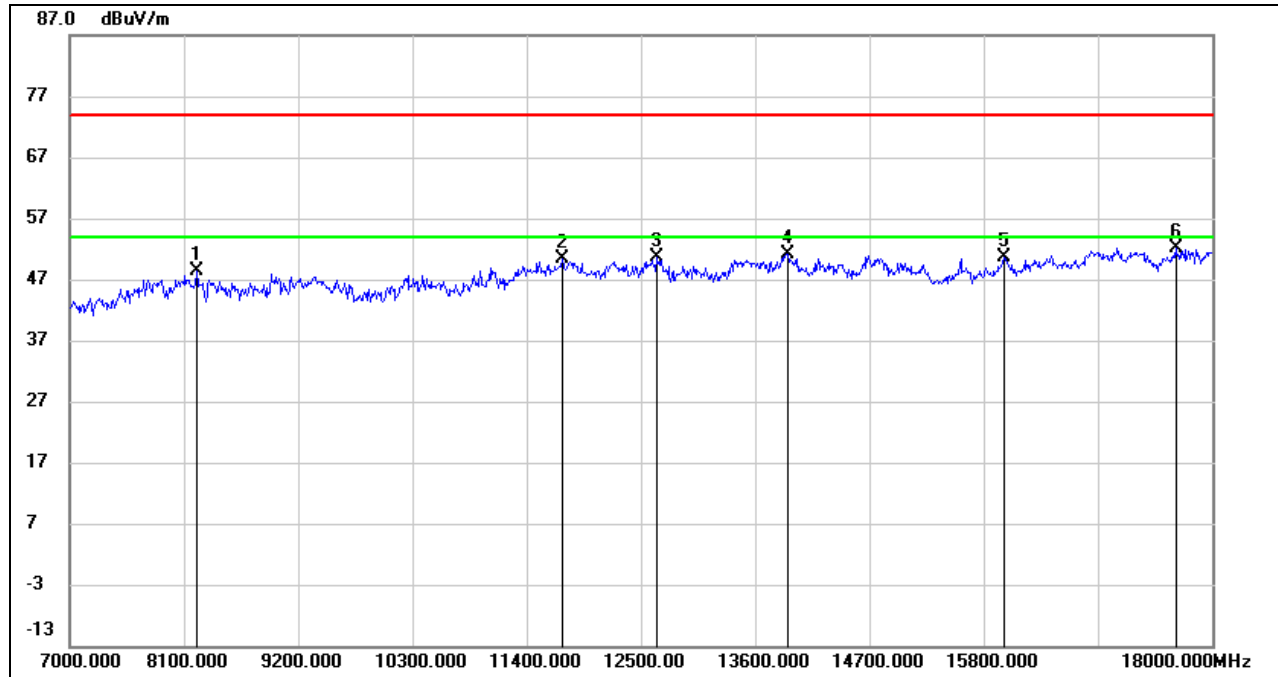

No.	Frequency (MHz)	Reading (dBuV)	Correct (dB/m)	Result (dBuV/m)	Limit (dBuV/m)	Margin (dB)	Remark
1	8221.000	38.51	9.79	48.30	74.00	-25.70	peak
2	11741.000	35.12	15.30	50.42	74.00	-23.58	peak
3	12654.000	34.94	15.69	50.63	74.00	-23.37	peak
4	13908.000	33.57	17.54	51.11	74.00	-22.89	peak
5	15998.000	32.17	18.42	50.59	74.00	-23.41	peak
6	17648.000	29.09	23.08	52.17	74.00	-21.83	peak

Note: 1. Measurement = Reading Level + Correct Factor.  
 2. If Peak Result complies with AV limit, AV Result is deemed to comply with AV limit.  
 3. Peak: Peak detector.  
 4. Filter losses were only considered in the spurious frequency bands and the authorized band was not corrected for High Pass Filter losses.  
 5. Proper operation of the transmitter prior to adding the filter to the measurement chain.  
 6. Since non-restricted band peak emissions are less than the average limit, they also comply with the -27dBm/MHz (68.2dBuV/m) limit.



**UNII-2C BAND**

**HARMONICS AND SPURIOUS EMISSIONS (LOW CHANNEL, HORIZONTAL)**

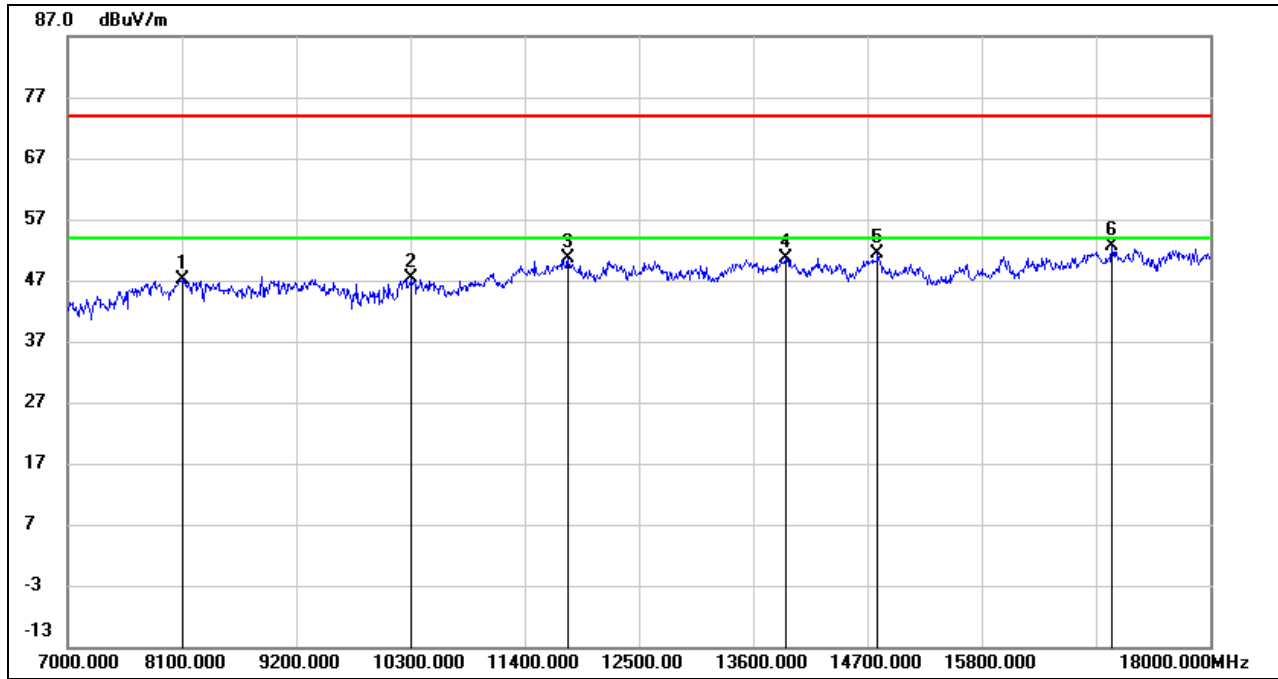

No.	Frequency (MHz)	Reading (dBuV)	Correct (dB/m)	Result (dBuV/m)	Limit (dBuV/m)	Margin (dB)	Remark
1	8111.000	36.99	10.14	47.13	74.00	-26.87	peak
2	10311.000	35.42	11.86	47.28	74.00	-26.72	peak
3	11818.000	35.26	15.29	50.55	74.00	-23.45	peak
4	13919.000	33.17	17.55	50.72	74.00	-23.28	peak
5	14799.000	33.35	18.04	51.39	74.00	-22.61	peak
6	17054.000	31.03	21.59	52.62	74.00	-21.38	peak

Note: 1. Measurement = Reading Level + Correct Factor.  
 2. If Peak Result complies with AV limit, AV Result is deemed to comply with AV limit.  
 3. Peak: Peak detector.  
 4. Filter losses were only considered in the spurious frequency bands and the authorized band was not corrected for High Pass Filter losses.  
 5. Proper operation of the transmitter prior to adding the filter to the measurement chain.  
 6. Since non-restricted band peak emissions are less than the average limit, they also comply with the -27dBm/MHz (68.2dBuV/m) limit.

**HARMONICS AND SPURIOUS EMISSIONS (LOW CHANNEL, VERTICAL)**

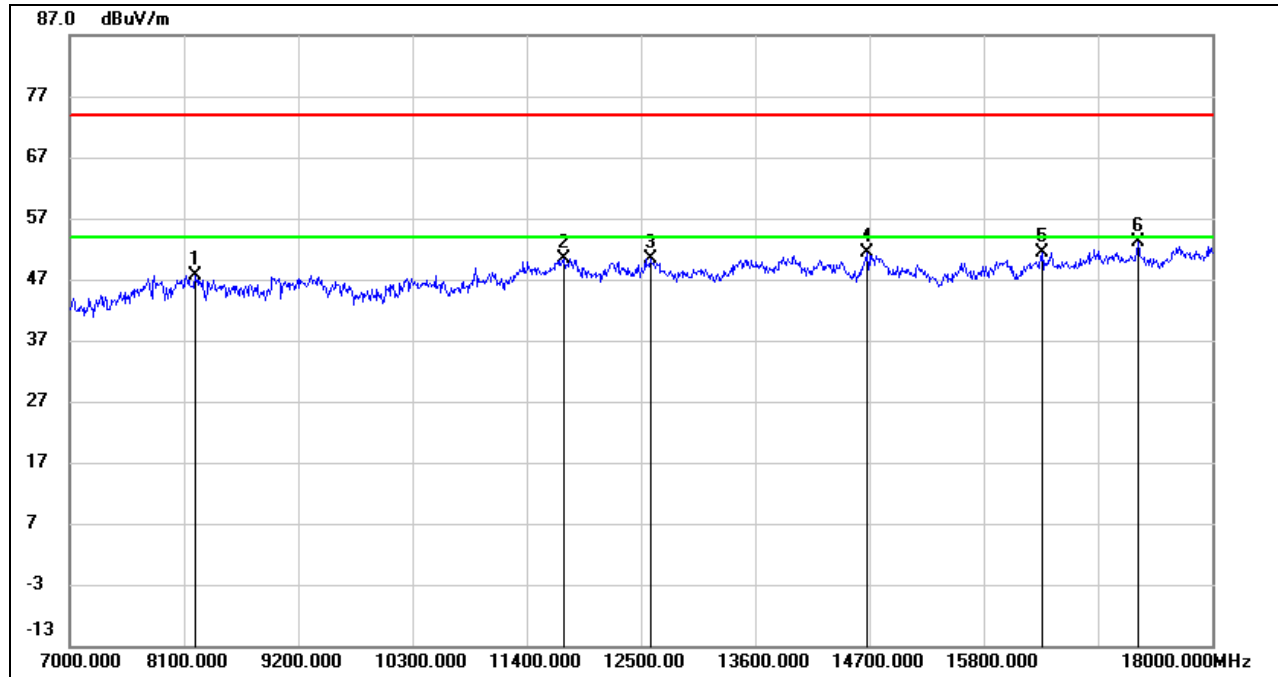

No.	Frequency (MHz)	Reading (dBuV)	Correct (dB/m)	Result (dBuV/m)	Limit (dBuV/m)	Margin (dB)	Remark
1	8210.000	37.87	9.80	47.67	74.00	-26.33	peak
2	11763.000	35.00	15.28	50.28	74.00	-23.72	peak
3	12588.000	34.67	15.76	50.43	74.00	-23.57	peak
4	14678.000	33.71	17.62	51.33	74.00	-22.67	peak
5	16361.000	31.67	19.66	51.33	74.00	-22.67	peak
6	17285.000	30.49	22.52	53.01	74.00	-20.99	peak

Note: 1. Measurement = Reading Level + Correct Factor.  
 2. If Peak Result complies with AV limit, AV Result is deemed to comply with AV limit.  
 3. Peak: Peak detector.  
 4. Filter losses were only considered in the spurious frequency bands and the authorized band was not corrected for High Pass Filter losses.  
 5. Proper operation of the transmitter prior to adding the filter to the measurement chain.  
 6. Since non-restricted band peak emissions are less than the average limit, they also comply with the -27dBm/MHz (68.2dBuV/m) limit.

**HARMONICS AND SPURIOUS EMISSIONS (MID CHANNEL, HORIZONTAL)**

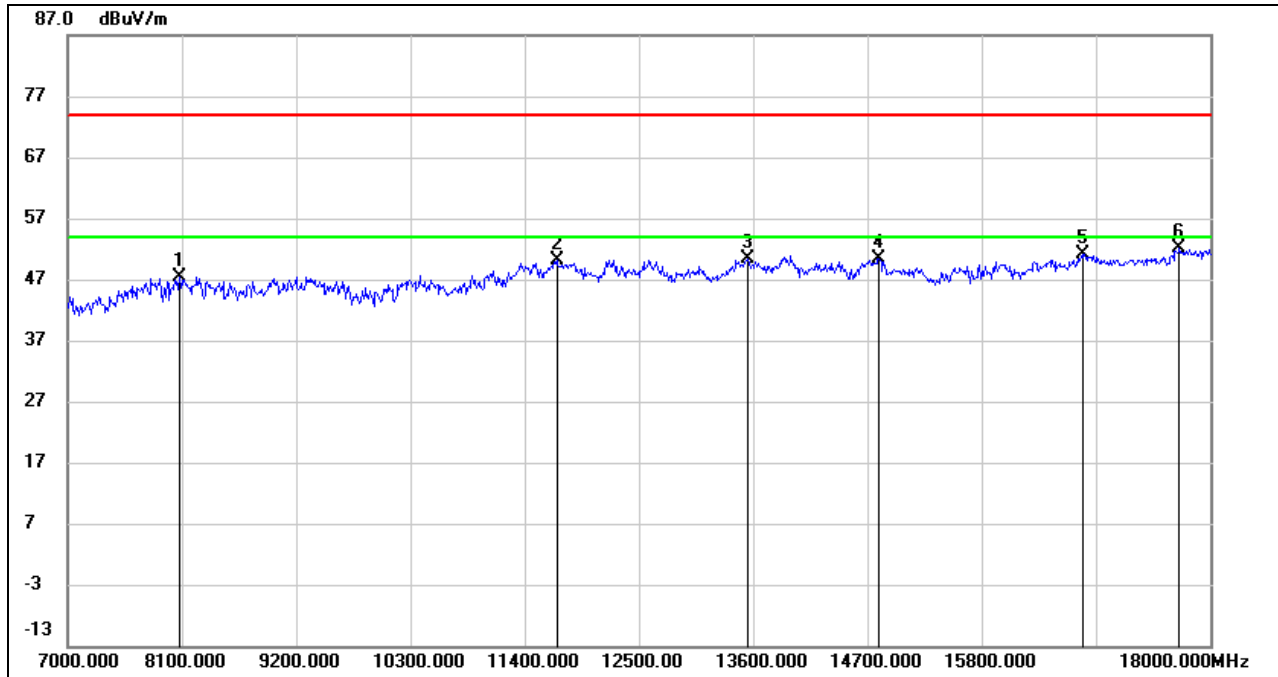

No.	Frequency (MHz)	Reading (dBuV)	Correct (dB/m)	Result (dBuV/m)	Limit (dBuV/m)	Margin (dB)	Remark
1	8078.000	37.51	9.83	47.34	74.00	-26.66	peak
2	11708.000	34.81	15.34	50.15	74.00	-23.85	peak
3	13545.000	33.22	17.16	50.38	74.00	-23.62	peak
4	14810.000	32.50	17.97	50.47	74.00	-23.53	peak
5	16779.000	30.62	20.55	51.17	74.00	-22.83	peak
6	17703.000	28.64	23.49	52.13	74.00	-21.87	peak

Note: 1. Measurement = Reading Level + Correct Factor.  
 2. If Peak Result complies with AV limit, AV Result is deemed to comply with AV limit.  
 3. Peak: Peak detector.  
 4. Filter losses were only considered in the spurious frequency bands and the authorized band was not corrected for High Pass Filter losses.  
 5. Proper operation of the transmitter prior to adding the filter to the measurement chain.  
 6. Since non-restricted band peak emissions are less than the average limit, they also comply with the -27dBm/MHz (68.2dBuV/m) limit.





**HARMONICS AND SPURIOUS EMISSIONS (MID CHANNEL, VERTICAL)**

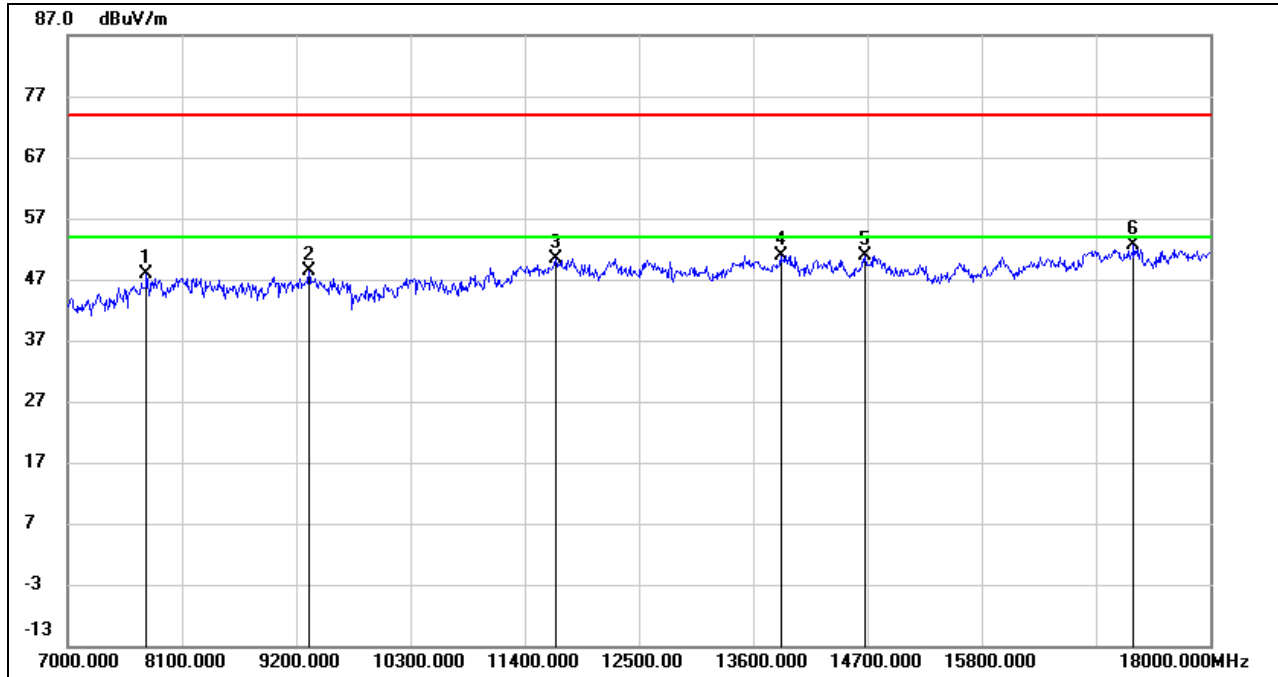

No.	Frequency (MHz)	Reading (dBuV)	Correct (dB/m)	Result (dBuV/m)	Limit (dBuV/m)	Margin (dB)	Remark
1	7759.000	38.85	8.98	47.83	74.00	-26.17	peak
2	9321.000	37.83	10.52	48.35	74.00	-25.65	peak
3	11697.000	35.10	15.34	50.44	74.00	-23.56	peak
4	13864.000	33.41	17.55	50.96	74.00	-23.04	peak
5	14678.000	33.31	17.62	50.93	74.00	-23.07	peak
6	17263.000	30.34	22.38	52.72	74.00	-21.28	peak

Note: 1. Measurement = Reading Level + Correct Factor.  
 2. If Peak Result complies with AV limit, AV Result is deemed to comply with AV limit.  
 3. Peak: Peak detector.  
 4. Filter losses were only considered in the spurious frequency bands and the authorized band was not corrected for High Pass Filter losses.  
 5. Proper operation of the transmitter prior to adding the filter to the measurement chain.  
 6. Since non-restricted band peak emissions are less than the average limit, they also comply with the -27dBm/MHz (68.2dBuV/m) limit.

**HARMONICS AND SPURIOUS EMISSIONS (HIGH CHANNEL, HORIZONTAL)**

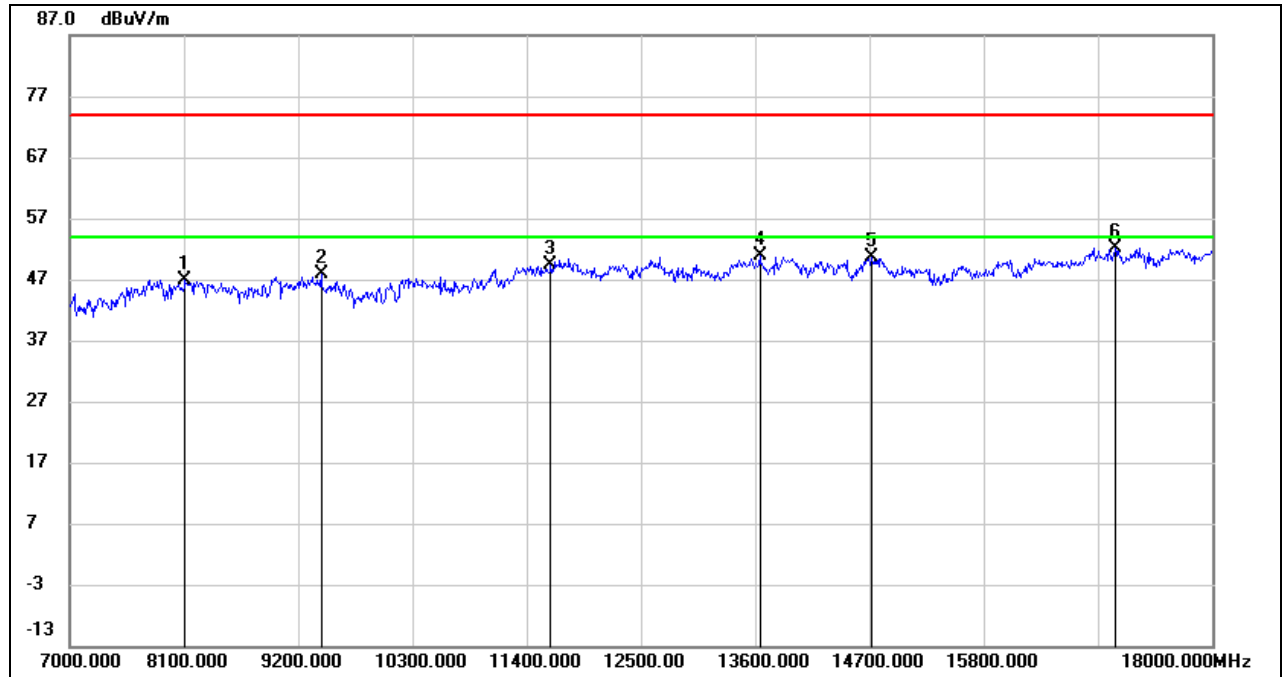

No.	Frequency (MHz)	Reading (dBuV)	Correct (dB/m)	Result (dBuV/m)	Limit (dBuV/m)	Margin (dB)	Remark
1	8111.000	36.69	10.14	46.83	74.00	-27.17	peak
2	9420.000	37.11	10.88	47.99	74.00	-26.01	peak
3	11631.000	34.37	14.91	49.28	74.00	-24.72	peak
4	13644.000	33.65	17.33	50.98	74.00	-23.02	peak
5	14722.000	32.94	17.77	50.71	74.00	-23.29	peak
6	17065.000	30.55	21.67	52.22	74.00	-21.78	peak

- Note: 1. Measurement = Reading Level + Correct Factor.  
 2. If Peak Result complies with AV limit, AV Result is deemed to comply with AV limit.  
 3. Peak: Peak detector.  
 4. Filter losses were only considered in the spurious frequency bands and the authorized band was not corrected for High Pass Filter losses.  
 5. Proper operation of the transmitter prior to adding the filter to the measurement chain.  
 6. Since non-restricted band peak emissions are less than the average limit, they also comply with the -27dBm/MHz (68.2dBuV/m) limit.

**HARMONICS AND SPURIOUS EMISSIONS (HIGH CHANNEL, VERTICAL)**

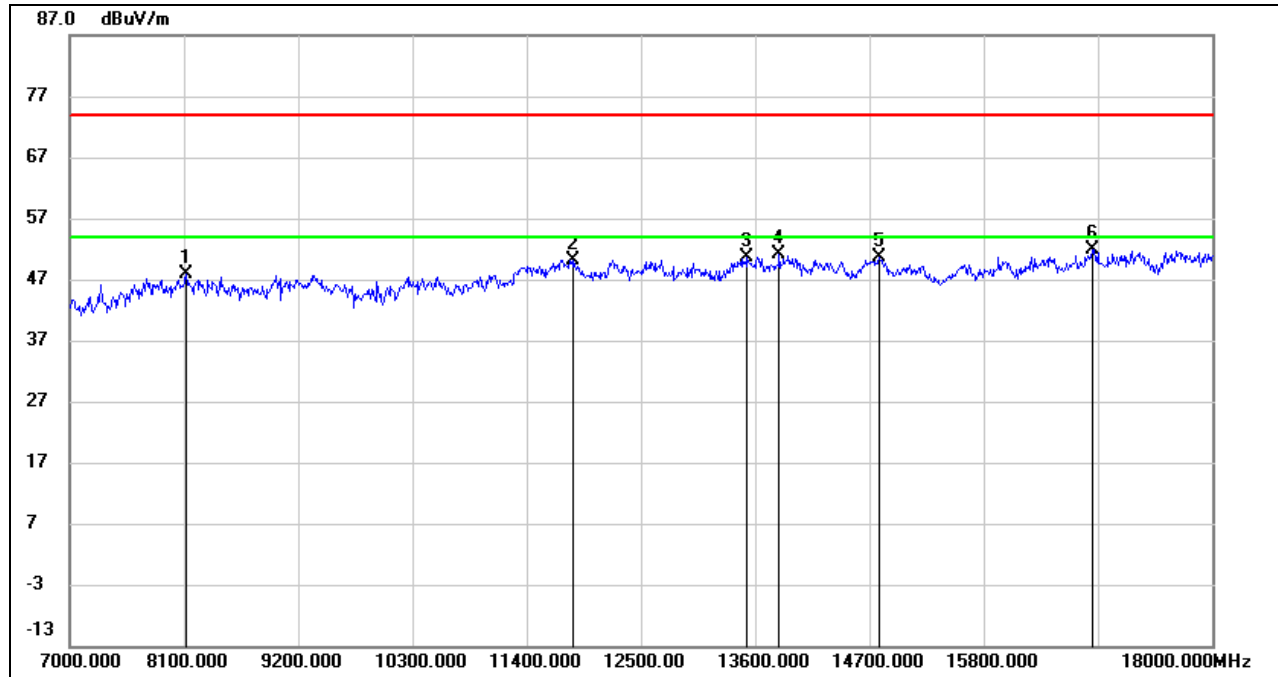

No.	Frequency (MHz)	Reading (dBuV)	Correct (dB/m)	Result (dBuV/m)	Limit (dBuV/m)	Margin (dB)	Remark
1	8122.000	37.66	10.10	47.76	74.00	-26.24	peak
2	11851.000	34.79	15.38	50.17	74.00	-23.83	peak
3	13523.000	33.34	17.19	50.53	74.00	-23.47	peak
4	13831.000	33.65	17.59	51.24	74.00	-22.76	peak
5	14799.000	32.54	18.04	50.58	74.00	-23.42	peak
6	16845.000	30.84	21.10	51.94	74.00	-22.06	peak

Note: 1. Measurement = Reading Level + Correct Factor.  
 2. If Peak Result complies with AV limit, AV Result is deemed to comply with AV limit.  
 3. Peak: Peak detector.  
 4. Filter losses were only considered in the spurious frequency bands and the authorized band was not corrected for High Pass Filter losses.  
 5. Proper operation of the transmitter prior to adding the filter to the measurement chain.  
 6. Since non-restricted band peak emissions are less than the average limit, they also comply with the -27dBm/MHz (68.2dBuV/m) limit.

**STRADDLE CHANNEL 142**

**HARMONICS AND SPURIOUS EMISSIONS (HORIZONTAL)**

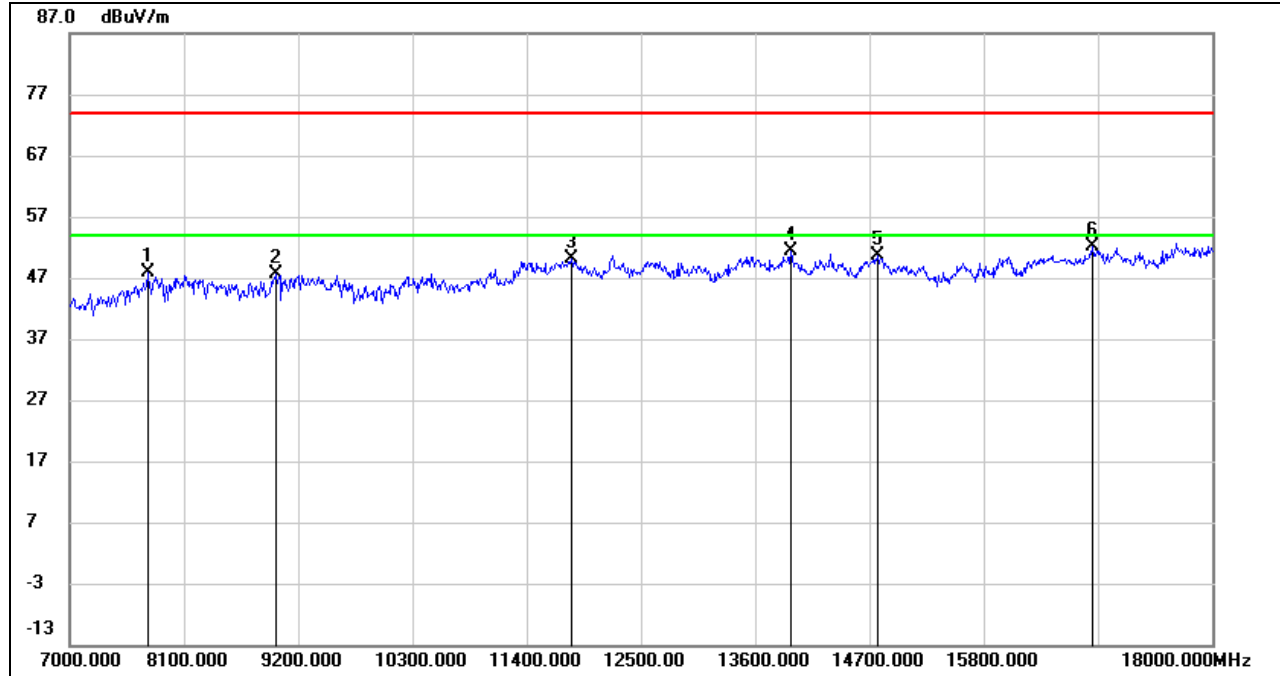

No.	Frequency (MHz)	Reading (dBuV)	Correct (dB/m)	Result (dBuV/m)	Limit (dBuV/m)	Margin (dB)	Remark
1	7748.000	39.07	8.88	47.95	74.00	-26.05	peak
2	8991.000	36.44	11.10	47.54	74.00	-26.46	peak
3	11829.000	34.83	15.32	50.15	74.00	-23.85	peak
4	13941.000	33.82	17.58	51.40	74.00	-22.60	peak
5	14777.000	32.67	17.96	50.63	74.00	-23.37	peak
6	16845.000	30.92	21.10	52.02	74.00	-21.98	peak

Note: 1. Measurement = Reading Level + Correct Factor.  
 2. If Peak Result complies with AV limit, AV Result is deemed to comply with AV limit.  
 3. Peak: Peak detector.  
 4. Filter losses were only considered in the spurious frequency bands and the authorized band was not corrected for High Pass Filter losses.  
 5. Proper operation of the transmitter prior to adding the filter to the measurement chain.  
 6. Since non-restricted band peak emissions are less than the average limit, they also comply with the -27dBm/MHz (68.2dBuV/m) limit.

**HARMONICS AND SPURIOUS EMISSIONS (VERTICAL)**

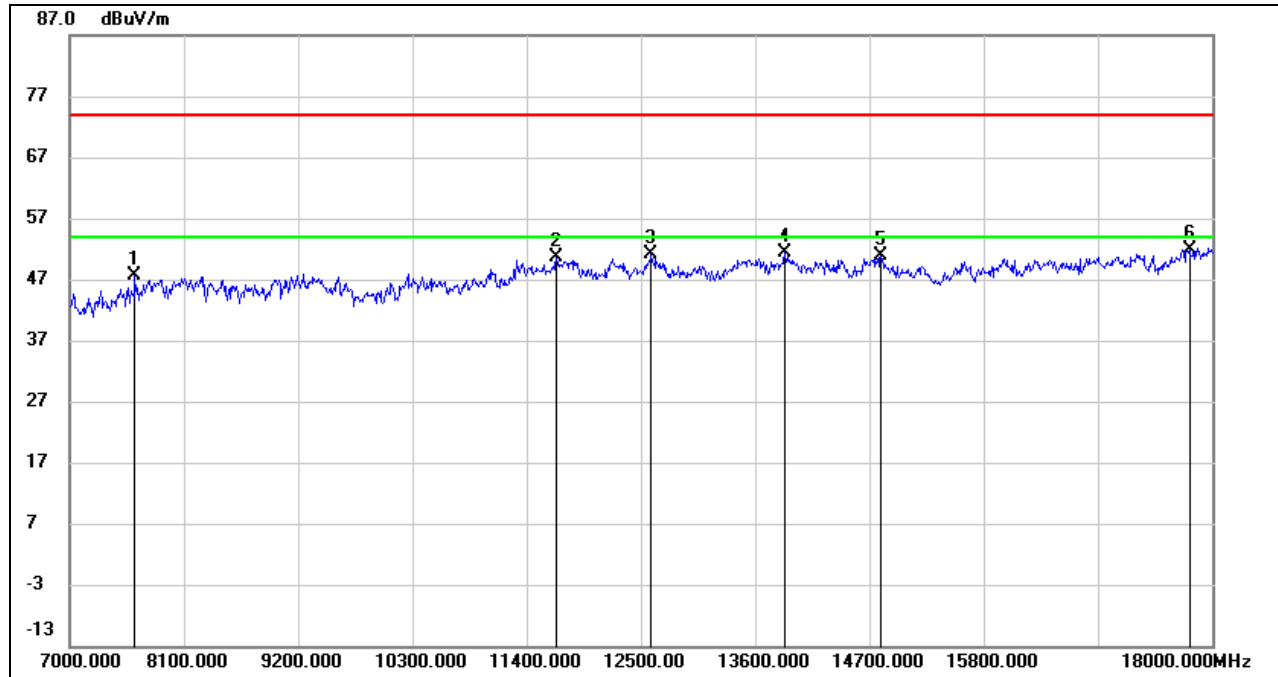

No.	Frequency (MHz)	Reading (dBuV)	Correct (dB/m)	Result (dBuV/m)	Limit (dBuV/m)	Margin (dB)	Remark
1	7627.000	39.44	8.08	47.52	74.00	-26.48	peak
2	11686.000	35.39	15.27	50.66	74.00	-23.34	peak
3	12599.000	35.34	15.78	51.12	74.00	-22.88	peak
4	13886.000	33.77	17.54	51.31	74.00	-22.69	peak
5	14810.000	32.98	17.97	50.95	74.00	-23.05	peak
6	17780.000	27.83	23.94	51.77	74.00	-22.23	peak

- Note: 1. Measurement = Reading Level + Correct Factor.  
 2. If Peak Result complies with AV limit, AV Result is deemed to comply with AV limit.  
 3. Peak: Peak detector.  
 4. Filter losses were only considered in the spurious frequency bands and the authorized band was not corrected for High Pass Filter losses.  
 5. Proper operation of the transmitter prior to adding the filter to the measurement chain.  
 6. Since non-restricted band peak emissions are less than the average limit, they also comply with the -27dBm/MHz (68.2dBuV/m) limit.



**UNII-3 BAND**

**HARMONICS AND SPURIOUS EMISSIONS (LOW CHANNEL, HORIZONTAL)**

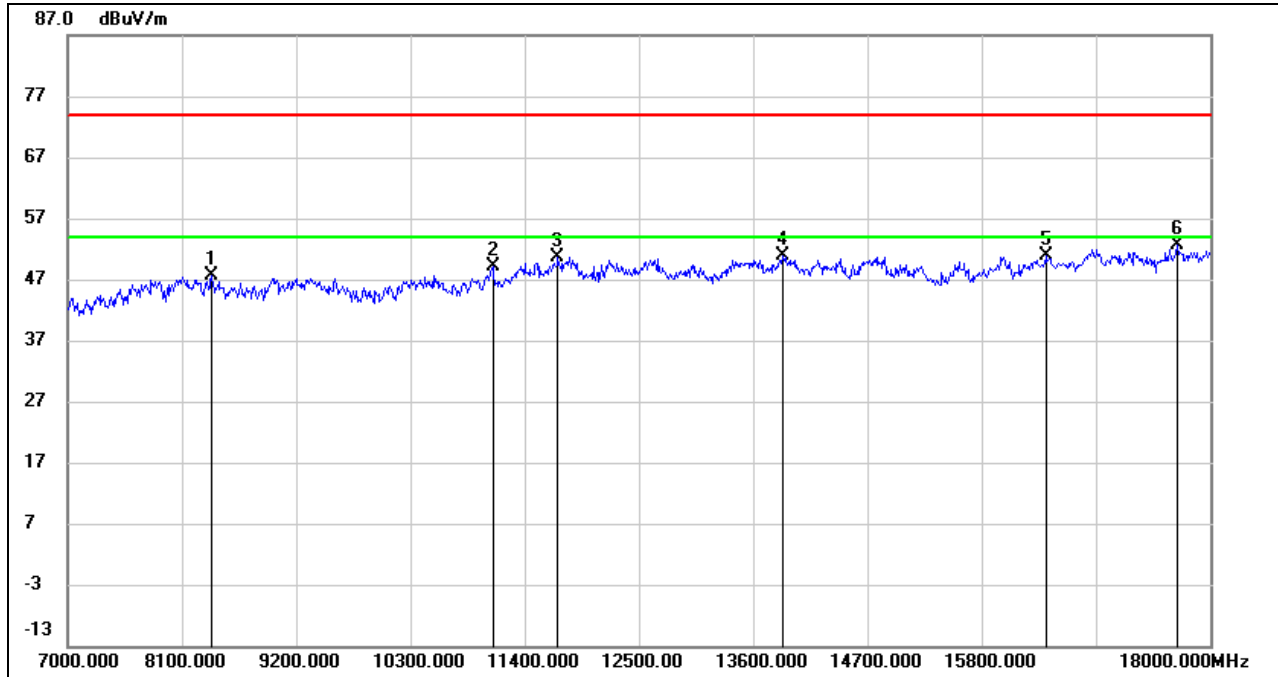

No.	Frequency (MHz)	Reading (dBuV)	Correct (dB/m)	Result (dBuV/m)	Limit (dBuV/m)	Margin (dB)	Remark
1	8386.000	38.17	9.39	47.56	74.00	-26.44	peak
2	11092.000	35.33	13.75	49.08	74.00	-24.92	peak
3	11719.000	35.31	15.33	50.64	74.00	-23.36	peak
4	13886.000	33.31	17.54	50.85	74.00	-23.15	peak
5	16416.000	31.08	19.68	50.76	74.00	-23.24	peak
6	17681.000	29.40	23.33	52.73	74.00	-21.27	peak

- Note: 1. Measurement = Reading Level + Correct Factor.  
 2. If Peak Result complies with AV limit, AV Result is deemed to comply with AV limit.  
 3. Peak: Peak detector.  
 4. Filter losses were only considered in the spurious frequency bands and the authorized band was not corrected for High Pass Filter losses.  
 5. Proper operation of the transmitter prior to adding the filter to the measurement chain.  
 6. Since non-restricted band peak emissions are less than the average limit, they also comply with the -27dBm/MHz (68.2dBuV/m) limit.

**HARMONICS AND SPURIOUS EMISSIONS (LOW CHANNEL, VERTICAL)**

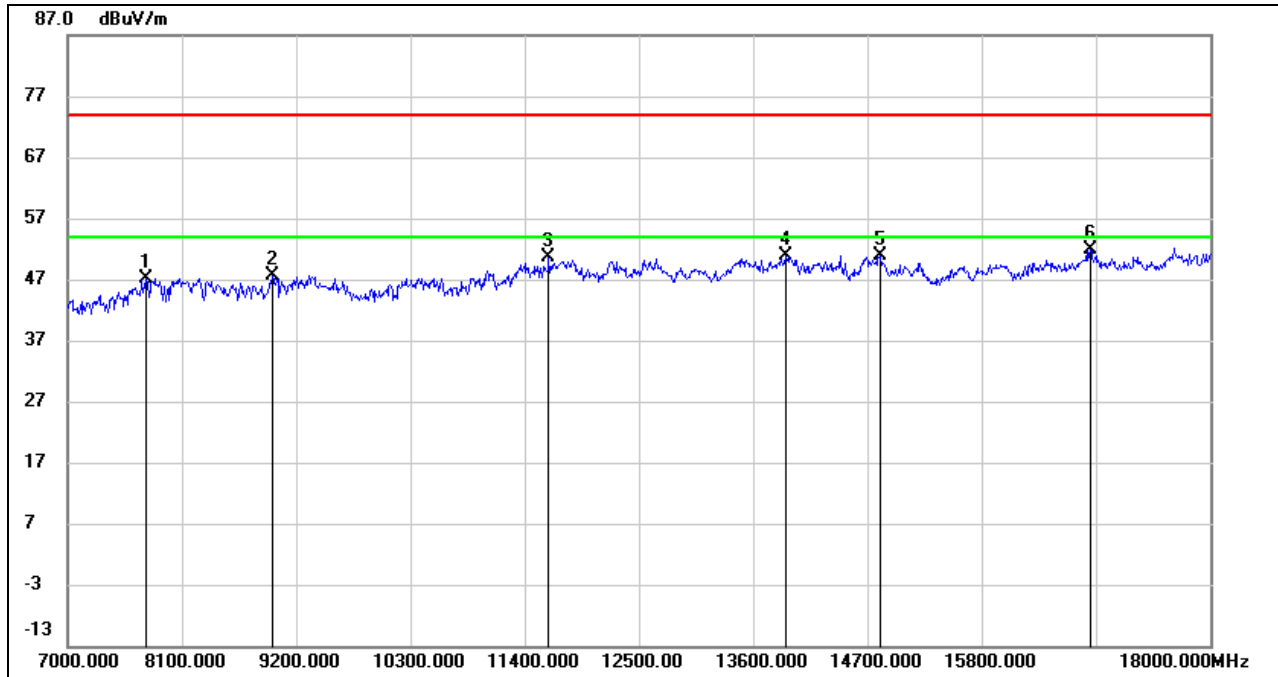

No.	Frequency (MHz)	Reading (dBuV)	Correct (dB/m)	Result (dBuV/m)	Limit (dBuV/m)	Margin (dB)	Remark
1	7759.000	38.24	8.98	47.22	74.00	-26.78	peak
2	8969.000	37.03	10.69	47.72	74.00	-26.28	peak
3	11631.000	35.72	14.91	50.63	74.00	-23.37	peak
4	13908.000	33.26	17.54	50.80	74.00	-23.20	peak
5	14821.000	32.94	17.90	50.84	74.00	-23.16	peak
6	16845.000	30.82	21.10	51.92	74.00	-22.08	peak

Note: 1. Measurement = Reading Level + Correct Factor.  
 2. If Peak Result complies with AV limit, AV Result is deemed to comply with AV limit.  
 3. Peak: Peak detector.  
 4. Filter losses were only considered in the spurious frequency bands and the authorized band was not corrected for High Pass Filter losses.  
 5. Proper operation of the transmitter prior to adding the filter to the measurement chain.  
 6. Since non-restricted band peak emissions are less than the average limit, they also comply with the -27dBm/MHz (68.2dBuV/m) limit.

**HARMONICS AND SPURIOUS EMISSIONS (HIGH CHANNEL, HORIZONTAL)**

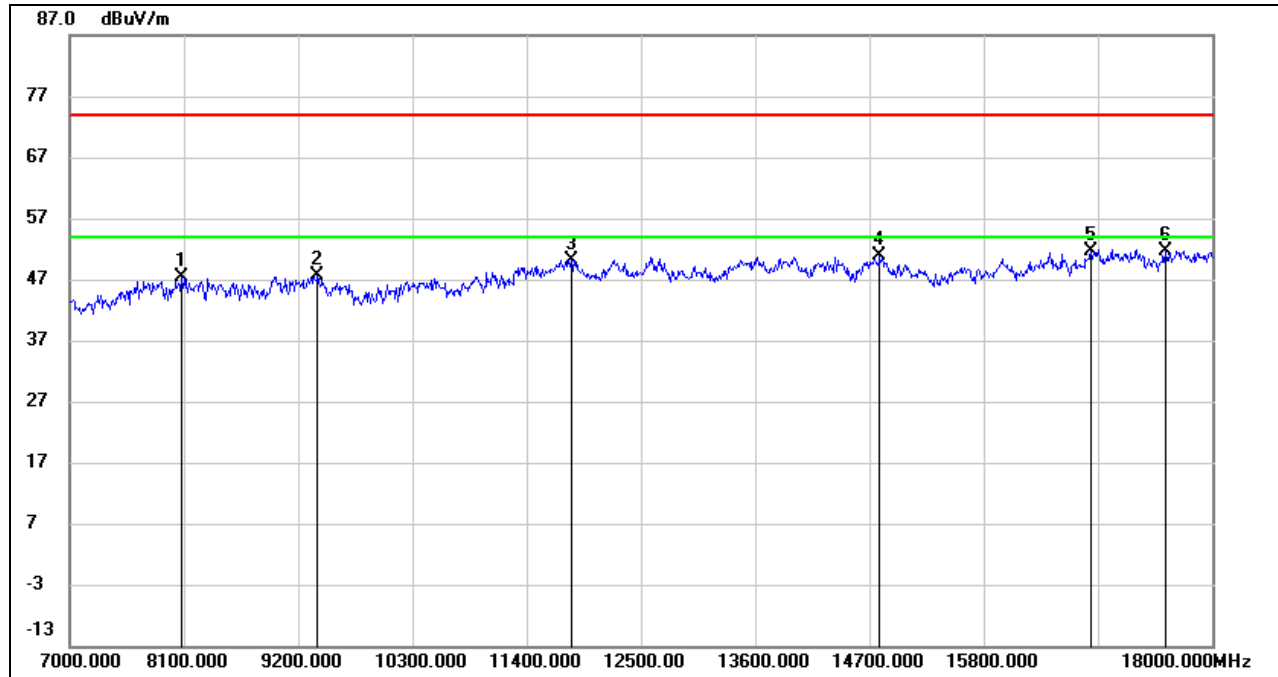

No.	Frequency (MHz)	Reading (dBuV)	Correct (dB/m)	Result (dBuV/m)	Limit (dBuV/m)	Margin (dB)	Remark
1	8078.000	37.43	9.83	47.26	74.00	-26.74	peak
2	9387.000	36.75	10.89	47.64	74.00	-26.36	peak
3	11829.000	34.89	15.32	50.21	74.00	-23.79	peak
4	14799.000	32.93	18.04	50.97	74.00	-23.03	peak
5	16834.000	30.56	21.00	51.56	74.00	-22.44	peak
6	17549.000	29.27	22.38	51.65	74.00	-22.35	peak

- Note: 1. Measurement = Reading Level + Correct Factor.  
 2. If Peak Result complies with AV limit, AV Result is deemed to comply with AV limit.  
 3. Peak: Peak detector.  
 4. Filter losses were only considered in the spurious frequency bands and the authorized band was not corrected for High Pass Filter losses.  
 5. Proper operation of the transmitter prior to adding the filter to the measurement chain.  
 6. Since non-restricted band peak emissions are less than the average limit, they also comply with the -27dBm/MHz (68.2dBuV/m) limit.



**HARMONICS AND SPURIOUS EMISSIONS (HIGH CHANNEL, VERTICAL)**

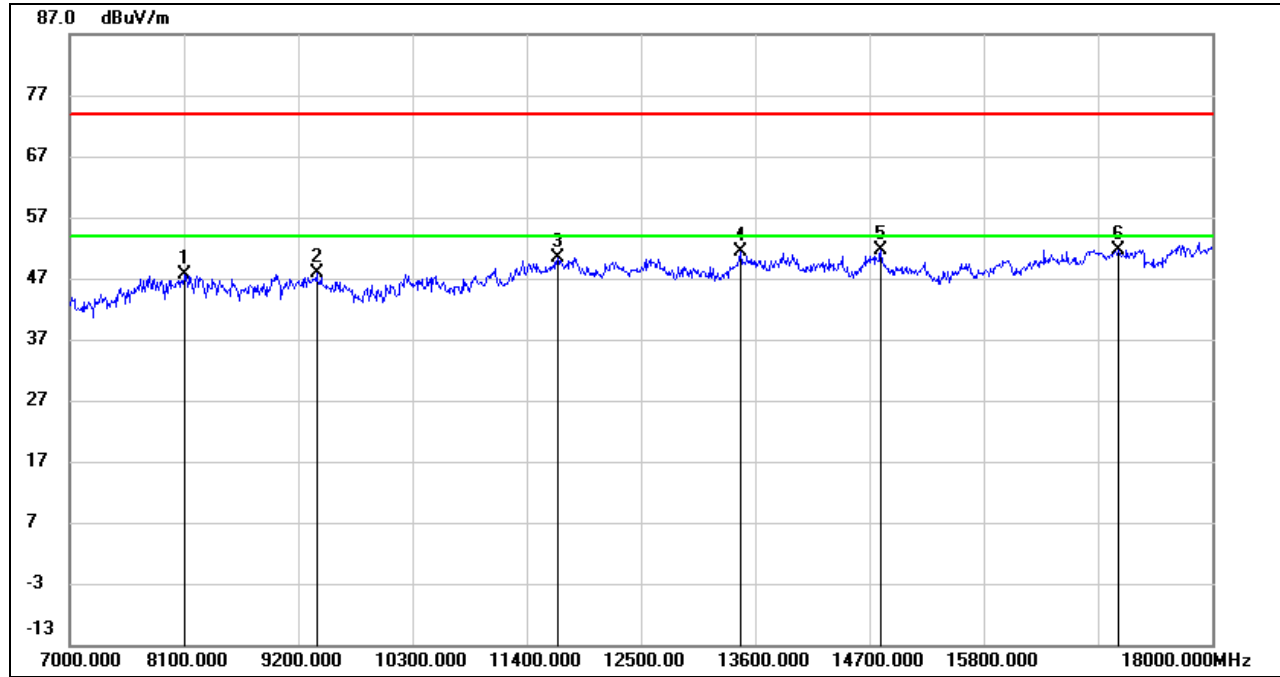

No.	Frequency (MHz)	Reading (dBuV)	Correct (dB/m)	Result (dBuV/m)	Limit (dBuV/m)	Margin (dB)	Remark
1	8111.000	37.51	10.14	47.65	74.00	-26.35	peak
2	9376.000	37.14	10.84	47.98	74.00	-26.02	peak
3	11697.000	34.92	15.34	50.26	74.00	-23.74	peak
4	13457.000	34.35	17.14	51.49	74.00	-22.51	peak
5	14810.000	33.77	17.97	51.74	74.00	-22.26	peak
6	17098.000	29.85	21.89	51.74	74.00	-22.26	peak

- Note: 1. Measurement = Reading Level + Correct Factor.  
 2. If Peak Result complies with AV limit, AV Result is deemed to comply with AV limit.  
 3. Peak: Peak detector.  
 4. Filter losses were only considered in the spurious frequency bands and the authorized band was not corrected for High Pass Filter losses.  
 5. Proper operation of the transmitter prior to adding the filter to the measurement chain.  
 6. Since non-restricted band peak emissions are less than the average limit, they also comply with the -27dBm/MHz (68.2dBuV/m) limit.

### 8.4. SPURIOUS EMISSIONS (18 GHz ~ 26 GHz)

#### 8.4.1. 802.11a MODE

#### SPURIOUS EMISSIONS (UNII-1 BAND MID CHANNEL, HORIZONTAL, WORST-CASE CONFIGURATION)

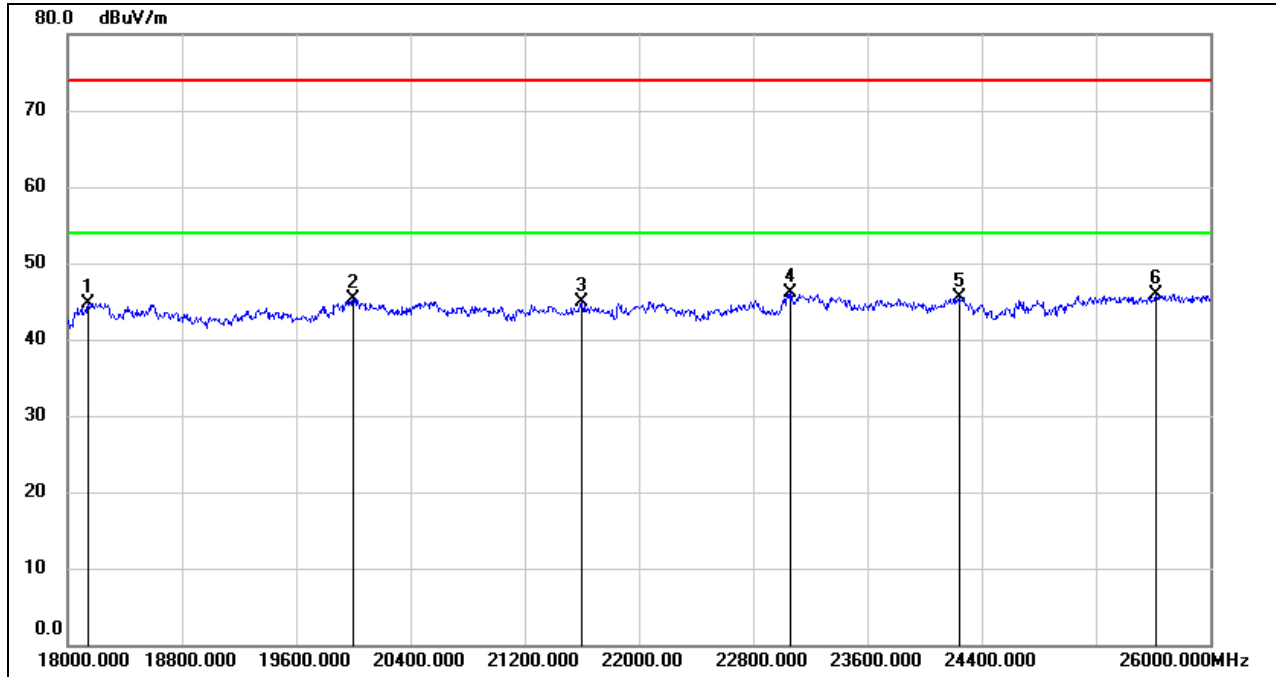

No.	Frequency (MHz)	Reading (dBuV)	Correct (dB/m)	Result (dBuV/m)	Limit (dBuV/m)	Margin (dB)	Remark
1	18144.000	50.27	-5.48	44.79	74.00	-29.21	peak
2	20000.000	50.81	-5.45	45.36	74.00	-28.64	peak
3	21600.000	49.52	-4.54	44.98	74.00	-29.02	peak
4	23064.000	49.49	-3.42	46.07	74.00	-27.93	peak
5	24248.000	48.32	-2.83	45.49	74.00	-28.51	peak
6	25616.000	47.18	-1.24	45.94	74.00	-28.06	peak

Note: 1. Measurement = Reading Level + Correct Factor.  
 2. If Peak Result complies with AV limit, AV Result is deemed to comply with AV limit.  
 3. Peak: Peak detector.



**SPURIOUS EMISSIONS (UNII-1 BAND MID CHANNEL, VERTICAL, WORST-CASE CONFIGURATION)**

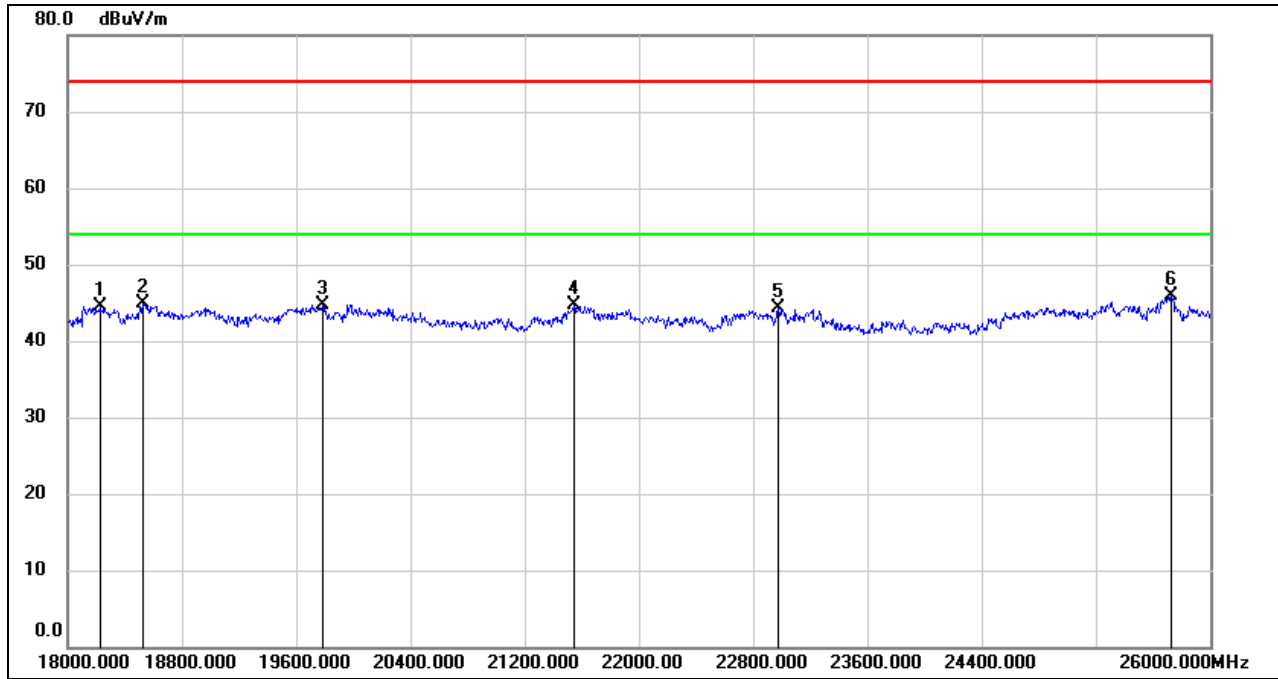

No.	Frequency (MHz)	Reading (dBuV)	Correct (dB/m)	Result (dBuV/m)	Limit (dBuV/m)	Margin (dB)	Remark
1	18224.000	50.08	-5.53	44.55	74.00	-29.45	peak
2	18528.000	50.11	-5.26	44.85	74.00	-29.15	peak
3	19784.000	50.07	-5.28	44.79	74.00	-29.21	peak
4	21544.000	49.26	-4.63	44.63	74.00	-29.37	peak
5	22976.000	47.76	-3.46	44.30	74.00	-29.70	peak
6	25728.000	46.61	-0.72	45.89	74.00	-28.11	peak

- Note: 1. Measurement = Reading Level + Correct Factor.  
 2. If Peak Result complies with AV limit, AV Result is deemed to comply with AV limit.  
 3. Peak: Peak detector.

Note: All the modes and channels had been tested, but only the worst data was recorded in the report.



## 8.5. SPURIOUS EMISSIONS (26 GHz ~ 40 GHz)

### 8.5.1. 802.11a MODE

#### SPURIOUS EMISSIONS (UNII-1 BAND MID CHANNEL, HORIZONTAL, WORST-CASE CONFIGURATION)

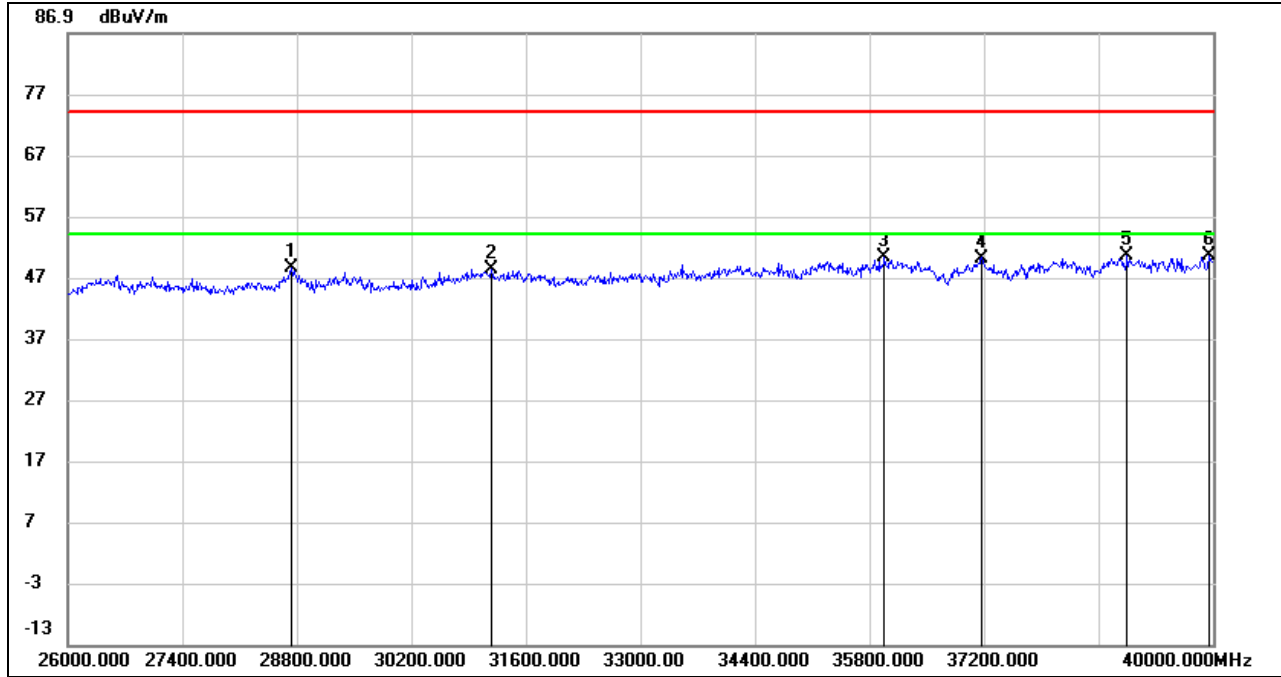

No.	Frequency (MHz)	Reading (dBuV)	Correct (dB/m)	Result (dBuV/m)	Limit (dBuV/m)	Margin (dB)	Remark
1	28730.000	49.22	-0.69	48.53	74.00	-25.47	peak
2	31180.000	49.00	-0.79	48.21	74.00	-25.79	peak
3	35982.000	46.29	4.01	50.30	74.00	-23.70	peak
4	37172.000	46.99	3.16	50.15	74.00	-23.85	peak
5	38950.000	46.28	4.31	50.59	74.00	-23.41	peak
6	39944.000	45.53	5.09	50.62	74.00	-23.38	peak

- Note: 1. Measurement = Reading Level + Correct Factor.  
 2. If Peak Result complies with AV limit, AV Result is deemed to comply with AV limit.  
 3. Peak: Peak detector.  
 4. Proper operation of the transmitter prior to adding the filter to the measurement chain.



**SPURIOUS EMISSIONS (UNII-1 BAND MID CHANNEL, VERTICAL, WORST-CASE CONFIGURATION)**

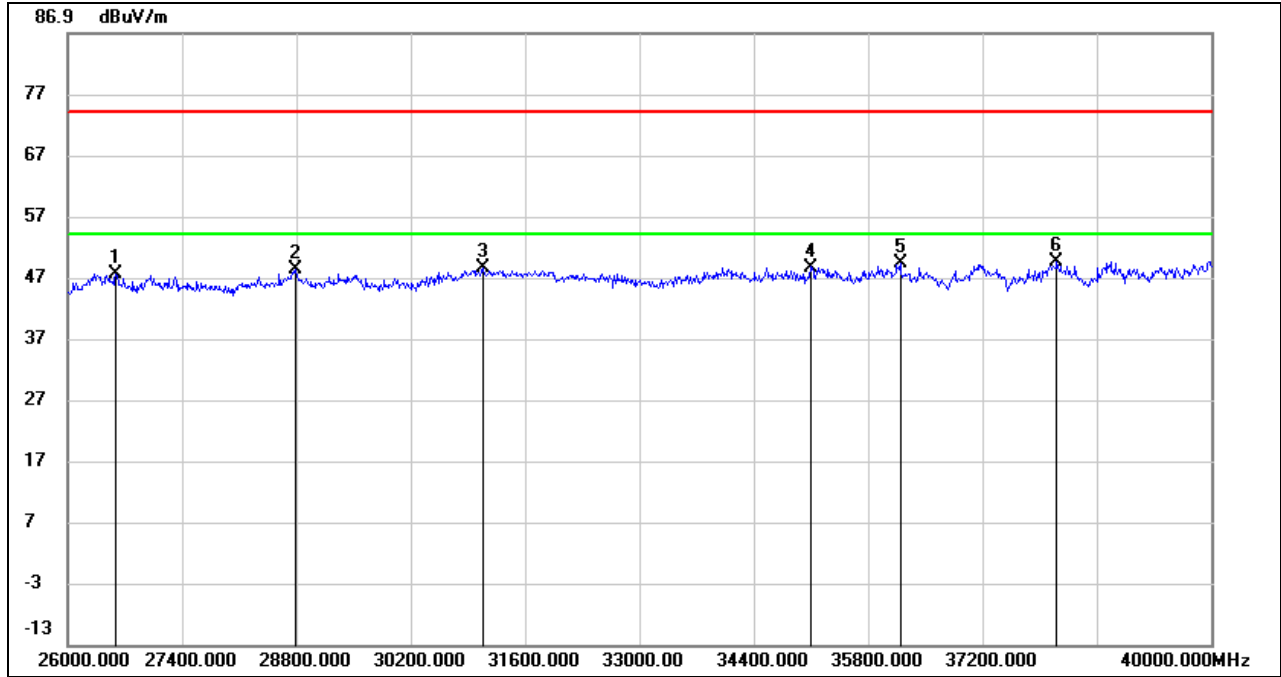

No.	Frequency (MHz)	Reading (dBuV)	Correct (dB/m)	Result (dBuV/m)	Limit (dBuV/m)	Margin (dB)	Remark
1	26588.000	52.42	-4.80	47.62	74.00	-26.38	peak
2	28786.000	48.80	-0.64	48.16	74.00	-25.84	peak
3	31082.000	49.29	-0.74	48.55	74.00	-25.45	peak
4	35100.000	46.80	1.85	48.65	74.00	-25.35	peak
5	36192.000	45.86	3.43	49.29	74.00	-24.71	peak
6	38110.000	46.07	3.53	49.60	74.00	-24.40	peak

- Note: 1. Measurement = Reading Level + Correct Factor.  
 2. If Peak Result complies with AV limit, AV Result is deemed to comply with AV limit.  
 3. Peak: Peak detector.  
 4. Proper operation of the transmitter prior to adding the filter to the measurement chain.

Note: All the modes and channels had been tested, but only the worst data was recorded in the report.

## 8.6. SPURIOUS EMISSIONS (30 MHz ~ 1 GHz)

### 8.6.1. 802.11a MODE

#### SPURIOUS EMISSIONS (UNII-1 BAND MID CHANNEL, HORIZONTAL, WORST-CASE CONFIGURATION)

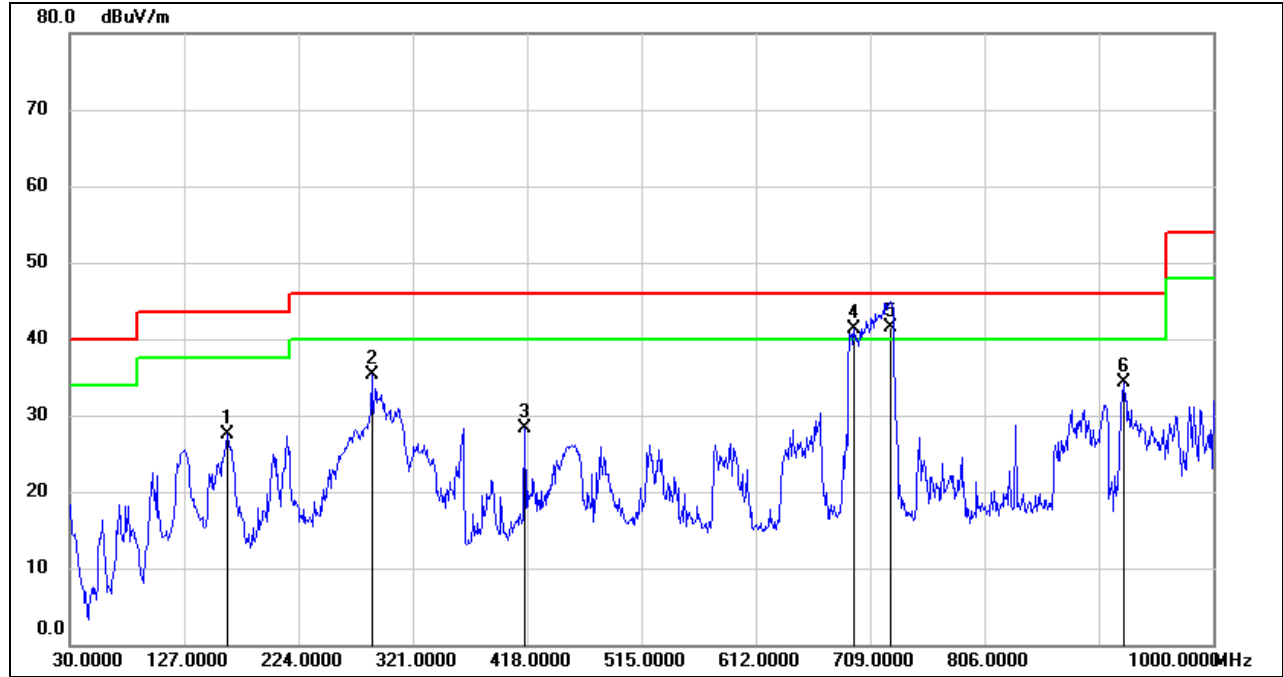

No.	Frequency (MHz)	Reading (dBuV)	Correct (dB/m)	Result (dBuV/m)	Limit (dBuV/m)	Margin (dB)	Remark
1	163.8600	45.11	-17.59	27.52	43.50	-15.98	QP
2	286.0799	51.61	-16.21	35.40	46.00	-10.60	QP
3	416.0600	41.38	-13.04	28.34	46.00	-17.66	QP
4	695.4200	49.61	-8.32	41.29	46.00	-4.71	QP
5	726.4600	49.69	-8.11	41.58	46.00	-4.42	QP
6	924.3400	39.04	-4.77	34.27	46.00	-11.73	QP

- Note: 1. Result Level = Read Level + Correct Factor.  
 2. If Peak Result complies with QP limit, QP Result is deemed to comply with QP limit.  
 3. Test setup: RBW: 120 kHz, VBW: 300 kHz, Sweep time: auto.



**SPURIOUS EMISSIONS (UNII-1 BAND MID CHANNEL, VERTICAL, WORST-CASE CONFIGURATION)**

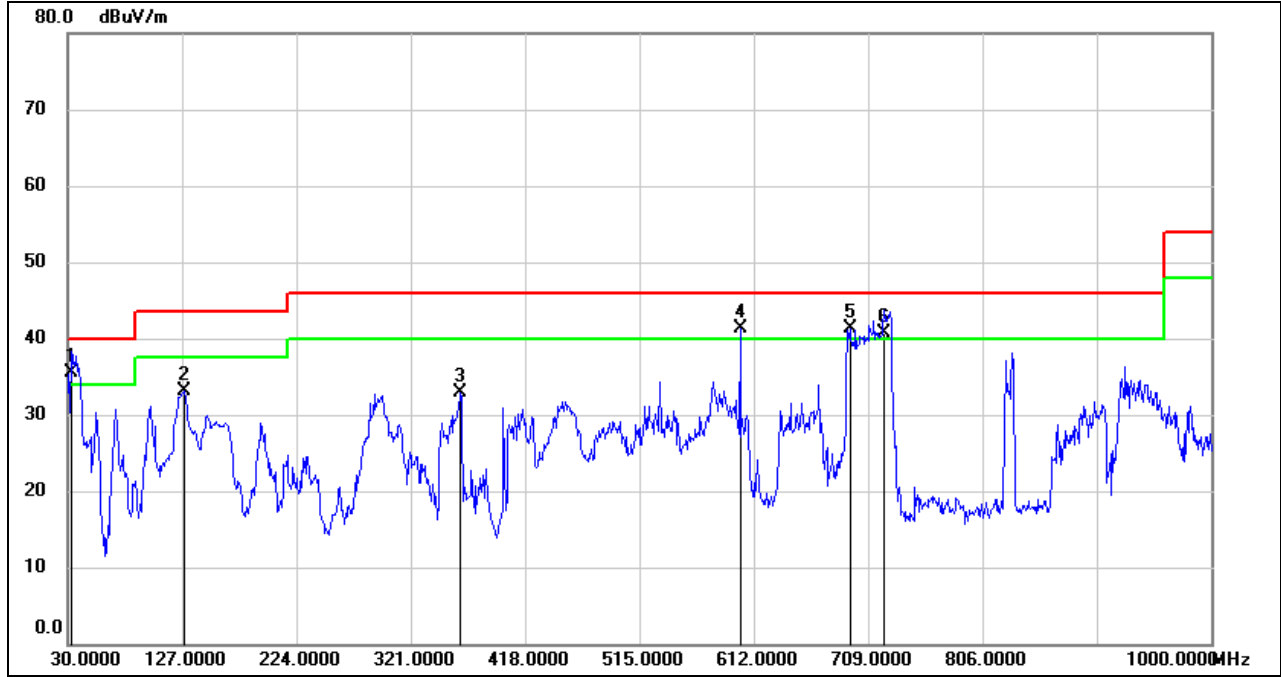

No.	Frequency (MHz)	Reading (dBuV)	Correct (dB/m)	Result (dBuV/m)	Limit (dBuV/m)	Margin (dB)	Remark
1	32.9100	54.63	-19.22	35.41	40.00	-4.59	QP
2	128.9400	52.46	-19.41	33.05	43.50	-10.45	QP
3	362.7100	46.95	-14.07	32.88	46.00	-13.12	QP
4	600.3600	50.83	-9.54	41.29	46.00	-4.71	QP
5	693.4800	49.66	-8.33	41.33	46.00	-4.67	QP
6	722.5800	48.84	-8.08	40.76	46.00	-5.24	QP

- Note: 1. Result Level = Read Level + Correct Factor.  
 2. If Peak Result complies with QP limit, QP Result is deemed to comply with QP limit.  
 3. Test setup: RBW: 120 kHz, VBW: 300 kHz, Sweep time: auto

Note: All the modes and channels had been tested, but only the worst data was recorded in the report.

## 8.7. SPURIOUS EMISSIONS BELOW 30 MHz

### 8.7.1. 802.11a MODE

#### SPURIOUS EMISSIONS (UNII-1 BAND MID CHANNEL, LOOP ANTENNA FACE ON TO THE EUT, WORST-CASE CONFIGURATION)

9 kHz~ 150 kHz

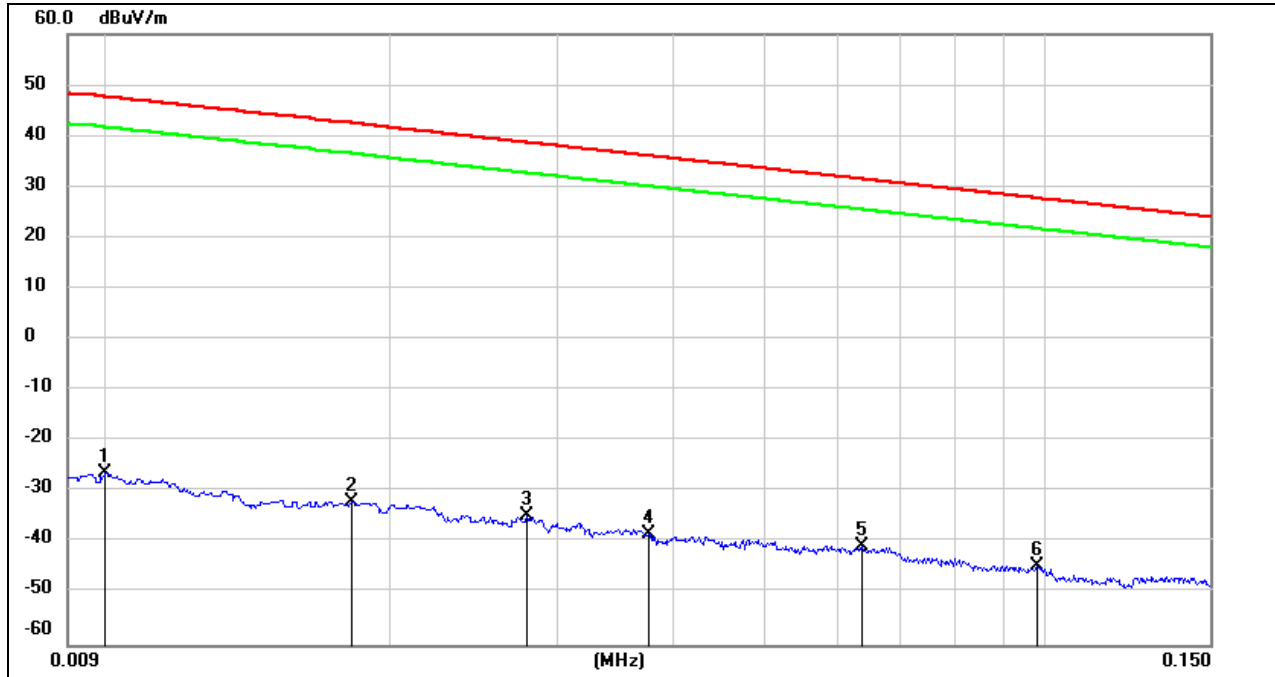

No.	Frequency (MHz)	Reading (dBuV)	Correct (dB/m)	FCC Result (dBuV/m)	FCC Limit (dBuV/m)	ISED Result (dBuA/m)	ISED Limit (dBuA/m)	Margin (dB)	Remark
1	0.0100	75.22	-101.40	-26.18	47.6	-77.68	-3.90	-73.78	peak
2	0.0181	69.35	-101.36	-32.01	42.45	-83.51	-9.05	-74.46	peak
3	0.0279	66.67	-101.38	-34.71	38.69	-86.21	-12.81	-73.40	peak
4	0.0376	63.25	-101.42	-38.17	36.1	-89.67	-15.40	-74.27	peak
5	0.0636	60.81	-101.54	-40.73	31.53	-92.23	-19.97	-72.26	peak
6	0.0981	57.27	-101.78	-44.51	27.77	-96.01	-23.73	-72.28	peak

- Note: 1. Measurement = Reading Level + Correct Factor.  
 2. If Peak Result complies with AV and QP limit, AV and QP Result are deemed to comply with AV limit.  
 3. All 3 polarizations (Horizontal, Face-on and Face-off) of the loop antenna had been tested, but only the worst data recorded in the report.





**150 kHz ~ 490 kHz**

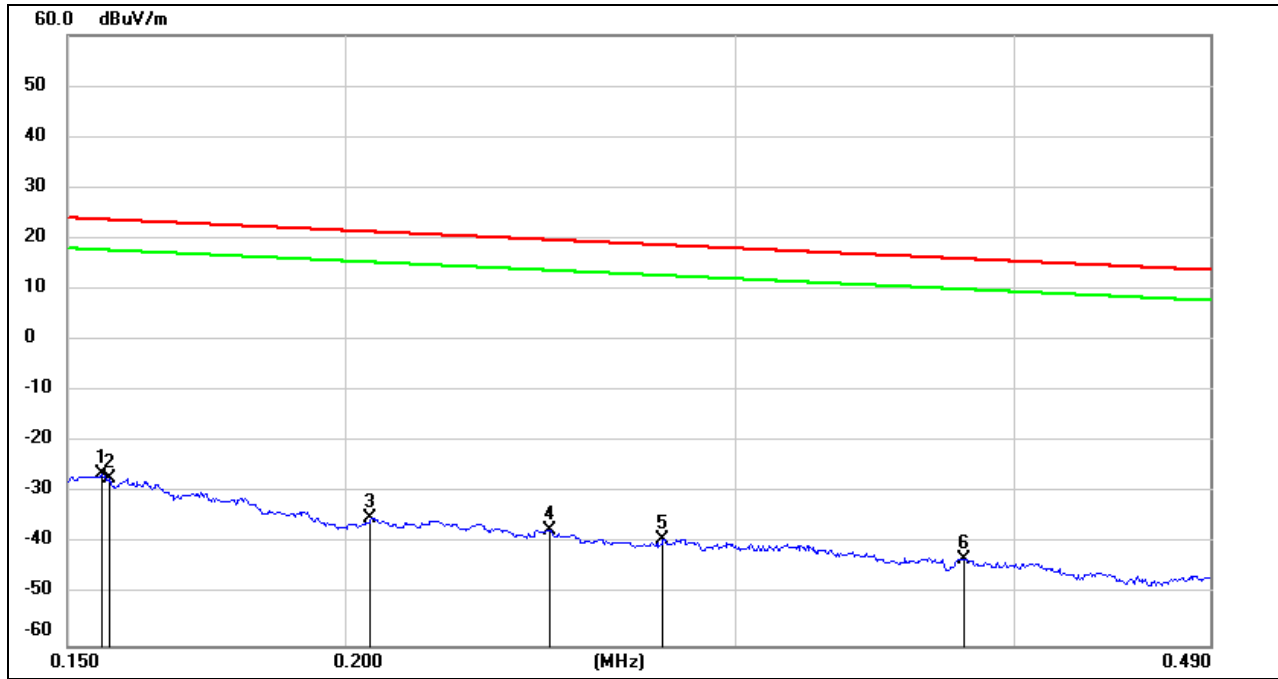

No.	Frequency (MHz)	Reading (dBuV)	Correct (dB/m)	FCC Result (dBuV/m)	FCC Limit (dBuV/m)	ISED Result (dBuA/m)	ISED Limit (dBuA/m)	Margin (dB)	Remark
1	0.1554	75.27	-101.65	-26.38	23.77	-77.88	-27.73	-50.15	peak
2	0.1567	74.45	-101.65	-27.2	23.7	-78.70	-27.80	-50.90	peak
3	0.2053	66.79	-101.73	-34.94	21.35	-86.44	-30.15	-56.29	peak
4	0.2472	64.45	-101.80	-37.35	19.74	-88.85	-31.76	-57.09	peak
5	0.2782	62.79	-101.83	-39.04	18.71	-90.54	-32.79	-57.75	peak
6	0.3800	59.02	-101.94	-42.92	16.01	-94.42	-35.49	-58.93	peak

Note: 1. Measurement = Reading Level + Correct Factor.  
 2. If Peak Result complies with AV and QP limit, AV and QP Result are deemed to comply with AV limit.  
 3. All 3 polarizations (Horizontal, Face-on and Face-off) of the loop antenna had been tested, but only the worst data recorded in the report.

**490 kHz ~ 30 MHz**

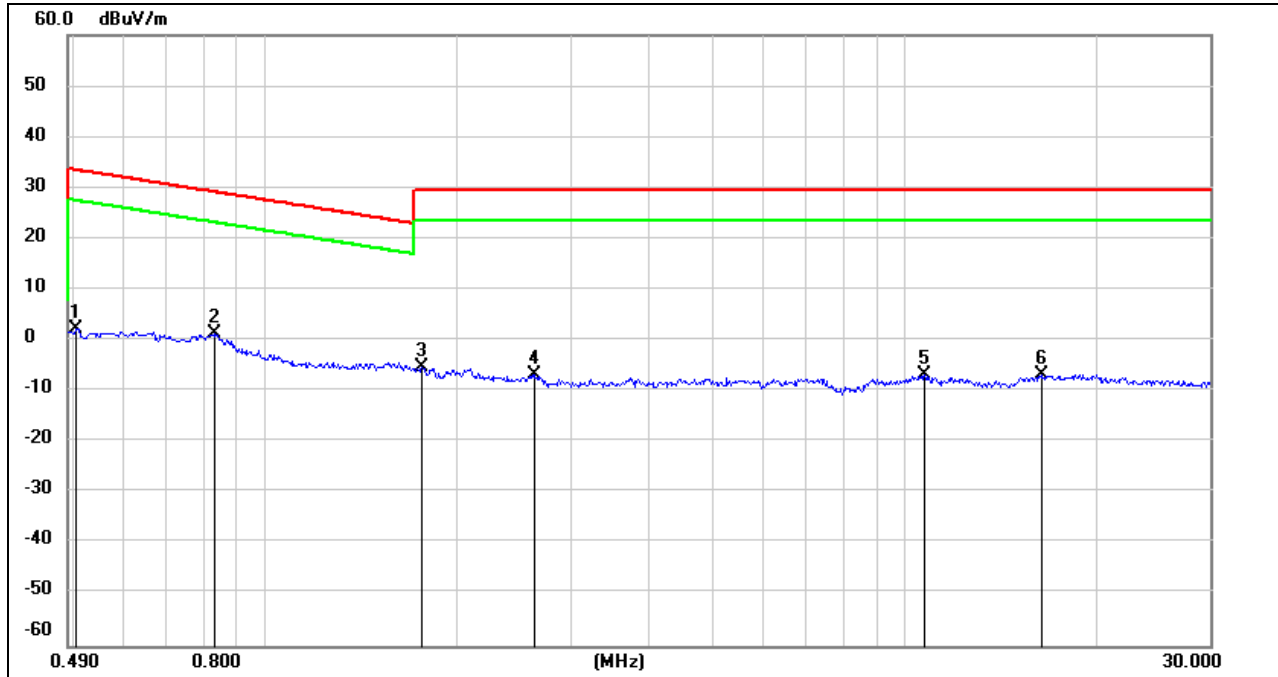

No.	Frequency (MHz)	Reading (dBuV)	Correct (dB/m)	FCC Result (dBuV/m)	FCC Limit (dBuV/m)	ISED Result (dBuA/m)	ISED Limit (dBuA/m)	Margin (dB)	Remark
1	0.5039	64.44	-62.07	2.37	33.56	-49.13	-17.94	-31.19	peak
2	0.8296	63.44	-62.17	1.27	29.23	-50.23	-22.27	-27.96	peak
3	1.7580	56.58	-61.93	-5.35	29.54	-56.85	-21.96	-34.89	peak
4	2.6442	54.80	-61.67	-6.87	29.54	-58.37	-21.96	-36.41	peak
5	10.7299	53.98	-60.83	-6.85	29.54	-58.35	-21.96	-36.39	peak
6	16.3959	54.17	-60.96	-6.79	29.54	-58.29	-21.96	-36.33	peak

Note: 1. Measurement = Reading Level + Correct Factor.

2. If Peak Result complies with AV and QP limit, AV and QP Result are deemed to comply with AV limit.

3. All 3 polarizations (Horizontal, Face-on and Face-off) of the loop antenna had been tested, but only the worst data recorded in the report.

Note: All the modes and channels had been tested, but only the worst data was recorded in the report.

## 9. AC POWER LINE CONDUCTED EMISSIONS

### LIMITS

Please refer to CFR 47 FCC §15.207 (a) and ISED RSS-Gen Clause 8.8

FREQUENCY (MHz)	Quasi-peak	Average
0.15 -0.5	66 - 56 *	56 - 46 *
0.50 -5.0	56.00	46.00
5.0 -30.0	60.00	50.00

### TEST SETUP AND PROCEDURE

Refer to ANSI C63.10-2013 clause 6.2.

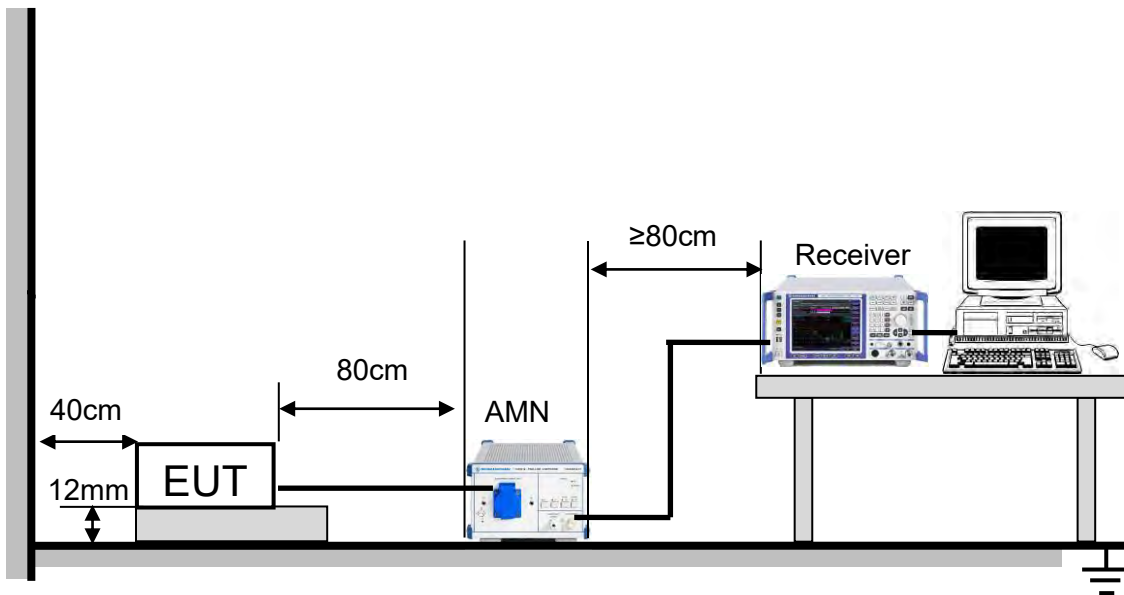

The EUT is put on a table of non-conducting material that is 12 mm high. The vertical conducting wall of shielding is located 40 cm to the rear of the EUT. The power line of the EUT is connected to the AC mains through a Artificial Mains Network (A.M.N.). A EMI Measurement Receiver (R&S Test Receiver ESR3) is used to test the emissions from both sides of AC line. According to the requirements in Section 6.2 of ANSI C63.10-2013. Conducted emissions from the EUT measured in the frequency range between 0.15 MHz and 30 MHz using CISPR Quasi-Peak and average detector mode. The bandwidth of EMI test receiver is set at 9 kHz.

The arrangement of the equipment is installed to meet the standards and operating in a manner, which tends to maximize its emission characteristics in a normal application.



**TEST ENVIRONMENT**

Temperature	23.9 °C	Relative Humidity	66.8 %
Atmosphere Pressure	101 kPa	Test Voltage	AC 120V,60HZ

**RESULTS**

### 9.1. 802.11a MODE

**LINE N RESULTS (UNII-1 BAND MID CHANNEL, WORST-CASE CONFIGURATION)**

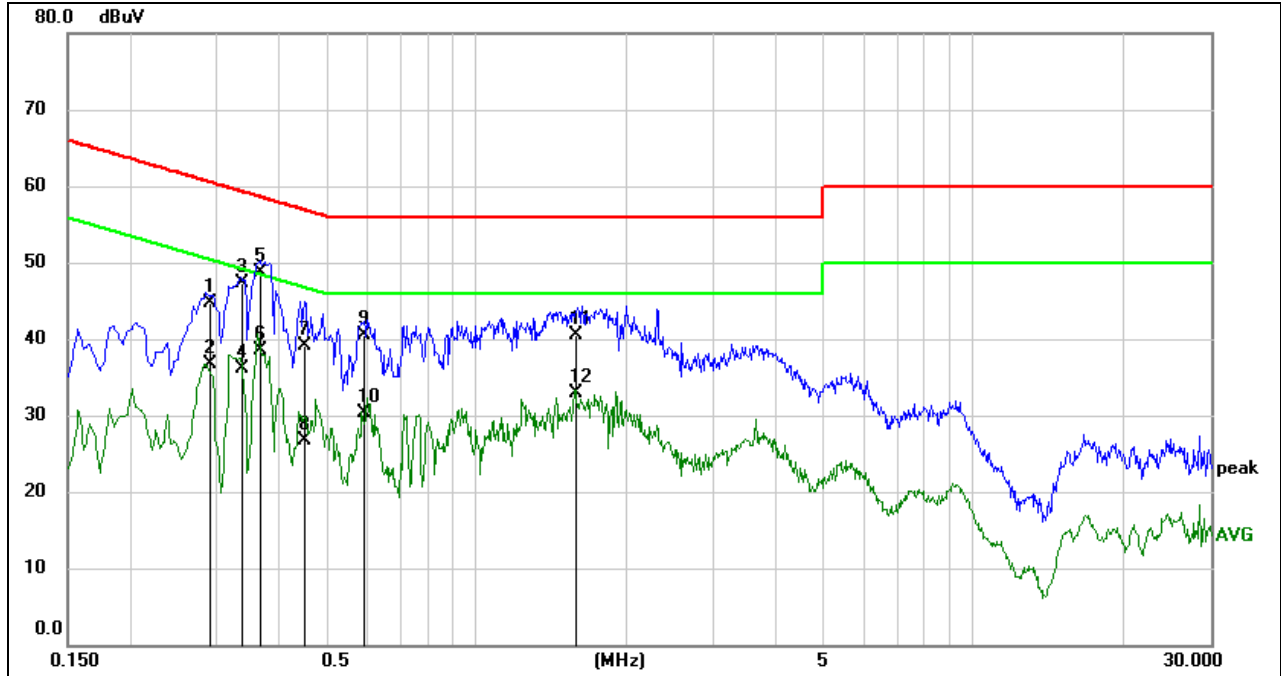

No.	Frequency (MHz)	Reading (dBuV)	Correct (dB)	Result (dBuV)	Limit (dBuV)	Margin (dB)	Remark
1	0.2904	35.16	9.59	44.75	60.51	-15.76	QP
2	0.2904	27.04	9.59	36.63	50.51	-13.88	AVG
3	0.3387	37.64	9.59	47.23	59.24	-12.01	QP
4	0.3387	26.53	9.59	36.12	49.24	-13.12	AVG
5	0.3663	39.17	9.59	48.76	58.58	-9.82	QP
6	0.3663	28.88	9.59	38.47	48.58	-10.11	AVG
7	0.4494	29.49	9.60	39.09	56.89	-17.80	QP
8	0.4494	17.04	9.60	26.64	46.89	-20.25	AVG
9	0.5941	30.97	9.60	40.57	56.00	-15.43	QP
10	0.5941	20.62	9.60	30.22	46.00	-15.78	AVG
11	1.5773	30.95	9.62	40.57	56.00	-15.43	QP
12	1.5773	23.23	9.62	32.85	46.00	-13.15	AVG

- Note: 1. Result = Reading + Correct Factor.  
 2. If QP Result complies with AV limit, AV Result is deemed to comply with AV limit.  
 3. Test setup: RBW: 200 Hz (9 kHz ~ 150 kHz), 9 kHz (150 kHz ~ 30 MHz).  
 4. Step size: 80 Hz (0.009 MHz ~ 0.15 MHz), 4 kHz (0.15 MHz ~ 30 MHz), Scan time: auto.



**LINE L RESULTS (UNII-1 BAND MID CHANNEL, WORST-CASE CONFIGURATION)**

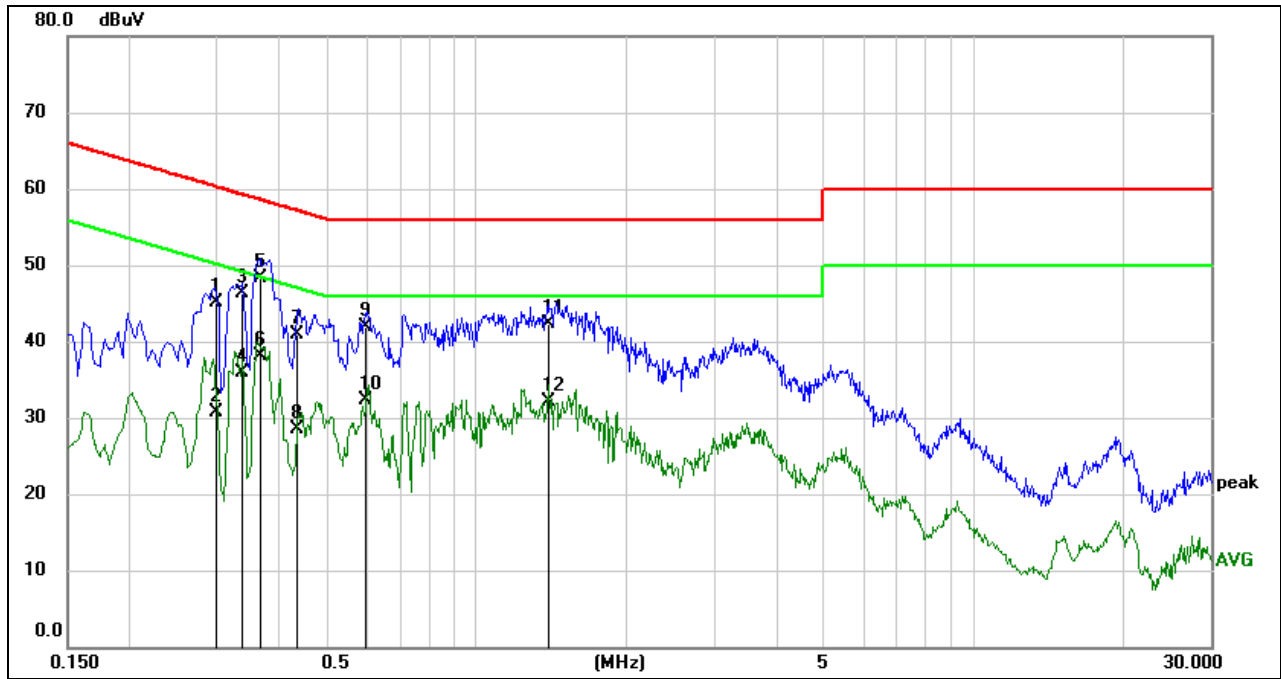

No.	Frequency (MHz)	Reading (dBuV)	Correct (dB)	Result (dBuV)	Limit (dBuV)	Margin (dB)	Remark
1	0.2996	35.47	9.59	45.06	60.25	-15.19	QP
2	0.2996	21.06	9.59	30.65	50.25	-19.60	AVG
3	0.3379	36.75	9.59	46.34	59.25	-12.91	QP
4	0.3379	26.22	9.59	35.81	49.25	-13.44	AVG
5	0.3673	38.81	9.59	48.40	58.56	-10.16	QP
6	0.3673	28.42	9.59	38.01	48.56	-10.55	AVG
7	0.4345	31.40	9.60	41.00	57.17	-16.17	QP
8	0.4345	19.00	9.60	28.60	47.17	-18.57	AVG
9	0.5961	32.38	9.60	41.98	56.00	-14.02	QP
10	0.5961	22.67	9.60	32.27	46.00	-13.73	AVG
11	1.3962	32.71	9.61	42.32	56.00	-13.68	QP
12	1.3962	22.52	9.61	32.13	46.00	-13.87	AVG

- Note: 1. Result = Reading + Correct Factor.  
 2. If QP Result complies with AV limit, AV Result is deemed to comply with AV limit.  
 3. Test setup: RBW: 200 Hz (9 kHz ~ 150 kHz), 9 kHz (150 kHz ~ 30 MHz).  
 4. Step size: 80 Hz (0.009 MHz ~ 0.15 MHz), 4 kHz (0.15 MHz ~ 30 MHz), Scan time: auto.

Note: All the modes and channels had been tested, but only the worst data was recorded in the report.

## 10. FREQUENCY STABILITY

### LIMITS

The frequency of the carrier signal shall be maintained within band of operation.

### TEST PROCEDURE

1. The EUT was placed inside an environmental chamber as the temperature in the chamber was varied between 0 °C ~ 40 °C (declared by customer).
2. The temperature was incremented by 10 °C intervals and the unit allowed to stabilize at each temperature before each measurement. The center frequency of the transmitting channel was evaluated at each temperature and the frequency deviation from the channel's center frequency was recorded.
3. The primary supply voltage is varied from 85 % to 115 % of the nominal value for non hand-carried battery and AC powered equipment. For hand-carried, battery-powered equipment, primary supply voltage is reduced to the battery operating end point which shall be specified by the manufacturer.

Connect the EUT to the spectrum analyser and use the following settings:

Center Frequency	The center frequency of the channel under test
Detector	Peak
RBW	10 kHz
VBW	$\geq 3 \times \text{RBW}$
Span	Encompass the entire emissions bandwidth (EBW) of the signal
Trace	Max hold
Sweep time	Auto

4. While maintaining a constant temperature inside the environmental chamber, turn the EUT on and record the operating frequency at startup, and at 2 minutes, 5 minutes, and 10 minutes after the EUT is energized.
5. Allow the trace to stabilize, find the peak value of the power envelope and record the frequency, then calculated the frequency drift.

### TEST SETUP

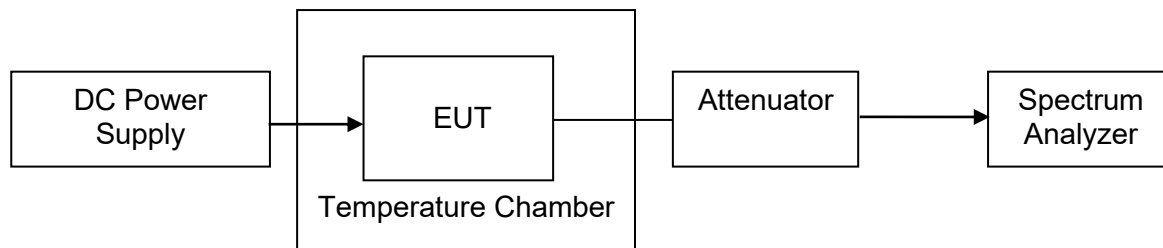



**TEST ENVIRONMENT**

	Normal Test Conditions	Extreme Test Conditions
Relative Humidity	20 % - 75 %	/
Atmospheric Pressure	100 kPa ~102 kPa	/
Temperature	T <sub>N</sub> (Normal Temperature): 22 °C – 28 °C	T <sub>L</sub> (Low Temperature): 0 °C
		T <sub>H</sub> (High Temperature): 40 °C
Supply Voltage	V <sub>N</sub> (Normal Voltage): AC 120 V, 60Hz	V <sub>L</sub> (Low Voltage): AC 138 V, 60Hz
		V <sub>H</sub> (High Voltage): AC 102 V, 60Hz

**RESULTS**

Please refer to Appendix E.



## 11. DYNAMIC FREQUENCY SELECTION

### APPLICABILITY OF DFS REQUIREMENTS

A U-NII network will employ a DFS function to detect signals from radar systems and to avoid co-channel operation with these systems. This applies to the 5250-5350 MHz and/or 5470-5725 MHz bands.

Within the context of the operation of the DFS function, a U-NII device will operate in either Master Mode or Client Mode. U-NII devices operating in Client Mode can only operate in a network controlled by a U-NII device operating in Master Mode.

Table 1: Applicability of DFS Requirements Prior to Use of a Channel

Requirement	Operational Mode		
	<input type="checkbox"/> Master	<input checked="" type="checkbox"/> Client Without Radar Detection	<input type="checkbox"/> Client With Radar Detection
Non-Occupancy Period	Yes	Not required	Yes
DFS Detection Threshold	Yes	Not required	Yes
Channel Availability Check Time	Yes	Not required	Not required
U-NII Detection Bandwidth	Yes	Not required	Yes

Table 2: Applicability of DFS requirements during normal operation

Requirement	Operational Mode	
	<input type="checkbox"/> Master Device or Client with Radar Detection	<input checked="" type="checkbox"/> Client Without Radar Detection
DFS Detection Threshold	Yes	Not required
Channel Closing Transmission Time	Yes	Yes
Channel Move Time	Yes	Yes
U-NII Detection Bandwidth	Yes	Not required

Additional requirements for devices with multiple bandwidth modes	<input type="checkbox"/> Master Device or Client with Radar Detection	<input checked="" type="checkbox"/> Client Without Radar Detection
U-NII Detection Bandwidth and Statistical Performance Check	All BW modes must be tested	Not required
Channel Move Time and Channel Closing Transmission Time	Test using widest BW mode available	Test using the widest BW mode available for the link
All other tests	Any single BW mode	Not required

Note: Frequencies selected for statistical performance check should include several frequencies within the radar detection bandwidth and frequencies near the edge of the radar detection bandwidth. For 802.11 devices it is suggested to select frequencies in each of the bonded 20 MHz channels and the channel center frequency.



**LIMITS**

(1) DFS Detection Thresholds

Table 3: DFS Detection Thresholds for Master Devices and Client Devices With Radar Detection

Maximum Transmit Power	Value (See Notes 1, 2, and 3)
EIRP ≥ 200 milliwatt	-64 dBm
EIRP < 200 milliwatt and power spectral density < 10 dBm/MHz	-62 dBm
EIRP < 200 milliwatt that do not meet the power spectral density requirement	-64 dBm

Note 1: This is the level at the input of the receiver assuming a 0 dBi receive antenna.  
 Note 2: Throughout these test procedures an additional 1 dB has been added to the amplitude of the test transmission waveforms to account for variations in measurement equipment. This will ensure that the test signal is at or above the detection threshold level to trigger a DFS response.  
 Note3: EIRP is based on the highest antenna gain. For MIMO devices refer to KDB Publication 662911 D01.

(2) DFS Response Requirements

Table 4: DFS Response Requirement Values

Parameter	Value
Non-occupancy period	Minimum 30 minutes
Channel Availability Check Time	60 seconds
Channel Move Time	10 seconds See Note 1.
Channel Closing Transmission Time	200 milliseconds + an aggregate of 60 milliseconds over remaining 10 second period. See Notes 1 and 2.
U-NII Detection Bandwidth	Minimum 100% of the U-NII 99% transmission power bandwidth. See Note 3.

Note 1: Channel Move Time and the Channel Closing Transmission Time should be performed with Radar Type 0. The measurement timing begins at the end of the Radar Type 0 burst.  
 Note 2: The Channel Closing Transmission Time is comprised of 200 milliseconds starting at the beginning of the Channel Move Time plus any additional intermittent control signals required facilitating a Channel move (an aggregate of 60 milliseconds) during the remainder of the 10 second period. The aggregate duration of control signals will not count quiet periods in between transmissions.  
 Note 3: During the U-NII Detection Bandwidth detection test, radar type 0 should be used. For each frequency step the minimum percentage of detection is 90 percent. Measurements are performed with no data traffic.

**PARAMETERS OF RADAR TEST WAVEFORMS**

This section provides the parameters for required test waveforms, minimum percentage of successful detections, and the minimum number of trials that must be used for determining DFS conformance. Step intervals of 0.1 microsecond for Pulse Width, 1 microsecond for PRI, 1 MHz for chirp width and 1 for the number of pulses will be utilized for the random determination of specific test waveforms.

Table 5 Short Pulse Radar Test Waveforms

Radar Type	Pulse Width (µsec)	PRI (µsec)	Number of Pulses	Minimum Percentage of Successful Detection	Minimum Number of Trials
0	1	1428	18	See Note 1	See Note 1
1	1	Test A	Roundup $\left\{ \frac{1}{360} \right\}$	60%	30
		Test B			
2	1-5	150-230	23-29	60%	30
3	6-10	200-500	16-18	60%	30
4	11-20	200-500	12-16	60%	30
Aggregate (Radar Types 1-4)				80%	120
<p>Note 1: Short Pulse Radar Type 0 should be used for the detection bandwidth test, channel move time, and channel closing time tests.</p> <p>Test A: 15 unique PRI values randomly selected from the list of 23 PRI values in Table 5a.</p> <p>Test B: 15 unique PRI values randomly selected within the range of 518-3066 µsec, with a minimum increment of 1 µsec, excluding PRI values selected in Test A.</p>					

A minimum of 30 unique waveforms are required for each of the Short Pulse Radar Types 2 through 4. If more than 30 waveforms are used for Short Pulse Radar Types 2 through 4, then each additional waveform must also be unique and not repeated from the previous waveforms. If more than 30 waveforms are used for Short Pulse Radar Type 1, then each additional waveform is generated with Test B and must also be unique and not repeated from the previous waveforms in Tests A or B. Test aggregate is average of the percentage of successful detections of short pulse radar types 1-4.

**TEST SETUP**

Setup for Client with injection at the Master

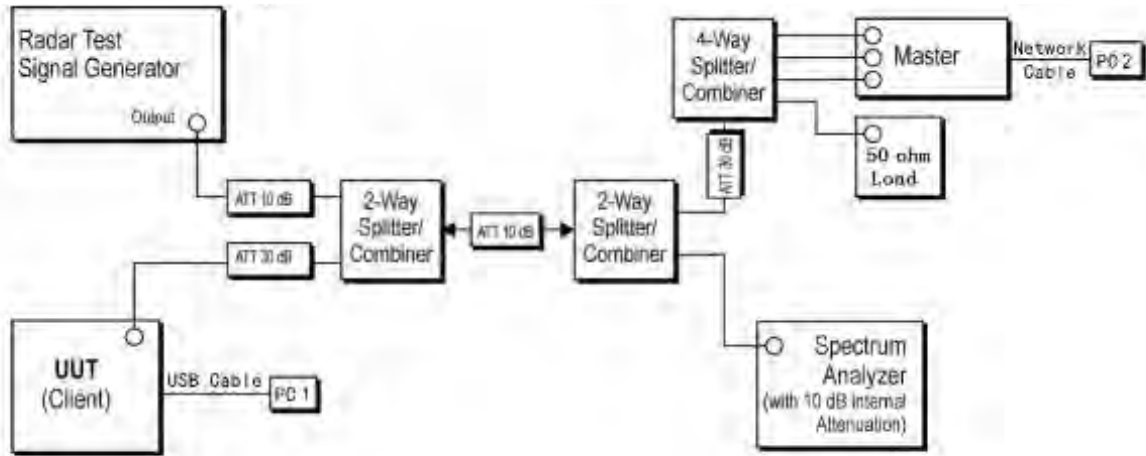

**RESULTS**

Please refer to Appendix I&J.



## 12. ANTENNA REQUIREMENTS

### APPLICABLE REQUIREMENTS

Please refer to FCC §15.203

An intentional radiator shall be designed to ensure that no antenna other than that furnished by the responsible party shall be used with the device. The use of a permanently attached antenna or of an antenna that uses a unique coupling to the intentional radiator shall be considered sufficient to comply with the provisions of this section. The manufacturer may design the unit so that a broken antenna can be replaced by the user, but the use of a standard antenna jack or electrical connector is prohibited.

Please refer to FCC §15.247(b)(4)

The conducted output power limit specified in paragraph (b) of this section is based on the use of antennas with directional gains that do not exceed 6 dBi. Except as shown in paragraph (c) of this section, if transmitting antennas of directional gain greater than 6 dBi are used, the conducted output power from the intentional radiator shall be reduced below the stated values in paragraphs (b)(1), (b)(2), and (b)(3) of this section, as appropriate, by the amount in dB that the directional gain of the antenna exceeds 6 dBi.

### RESULTS

Complies



### 13. Appendix

#### 13.1. Appendix A1: Emission Bandwidth

##### 13.1.1. Test Result

Test Mode	Antenna	Channel	26db EBW [MHz]	FL[MHz]	FH[MHz]	Verdict
11A	Ant1	5180	19.320	5170.360	5189.680	PASS
		5200	19.440	5190.160	5209.600	PASS
		5240	19.480	5230.320	5249.800	PASS
		5260	19.160	5250.560	5269.720	PASS
		5280	19.400	5270.240	5289.640	PASS
		5320	19.120	5310.560	5329.680	PASS
		5500	19.160	5490.280	5509.440	PASS
		5580	19.120	5570.600	5589.720	PASS
		5700	19.160	5690.480	5709.640	PASS
		5720	19.760	5709.800	5729.560	PASS
		5720 UNII-2C	15.2	5709.800	5725	PASS
		5720 UNII-3	4.56	5725	5729.560	PASS
		5745	19.160	5735.320	5754.480	PASS
		5785	19.720	5775.000	5794.720	PASS
		5825	19.320	5815.360	5834.680	PASS
11N20SISO	Ant1	5180	19.720	5170.440	5190.160	PASS
		5200	19.240	5190.360	5209.600	PASS
		5240	19.200	5230.480	5249.680	PASS
		5260	19.560	5250.080	5269.640	PASS
		5280	19.480	5270.000	5289.480	PASS
		5320	19.360	5310.160	5329.520	PASS
		5500	18.880	5490.720	5509.600	PASS
		5580	19.320	5570.440	5589.760	PASS
		5700	19.480	5690.440	5709.920	PASS
		5720	19.800	5710.000	5729.800	PASS
		5720 UNII-2C	15	5710.000	5725	PASS
		5720 UNII-3	4.8	5725	5729.800	PASS
		5745	19.440	5735.200	5754.640	PASS
		5785	19.600	5775.160	5794.760	PASS
		5825	19.920	5814.760	5834.680	PASS
11N40SISO	Ant1	5190	40.560	5170.560	5211.120	PASS
		5230	39.120	5210.400	5249.520	PASS
		5270	39.280	5250.320	5289.600	PASS
		5310	39.520	5290.240	5329.760	PASS
		5510	39.120	5490.560	5529.680	PASS
		5550	39.200	5530.560	5569.760	PASS
		5670	38.880	5650.640	5689.520	PASS
		5710	39.760	5690.400	5730.160	PASS
		5710 UNII-2C	34.6	5690.400	5725	PASS
		5710 UNII-3	5.16	5725	5730.160	PASS
		5755	39.440	5735.480	5774.920	PASS
		5795	38.800	5775.800	5814.600	PASS

### 13.1.2. Test Graphs





11A Ant1 5260



11A Ant1 5280



11A Ant1 5320





11A Ant1 5500



11A Ant1 5580

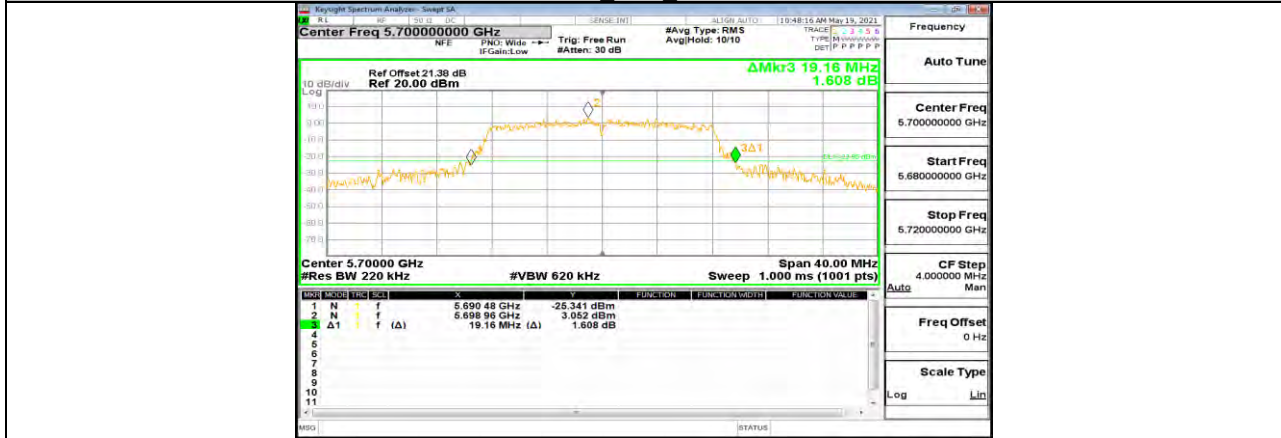

11A Ant1 5700



11A Ant1 5720

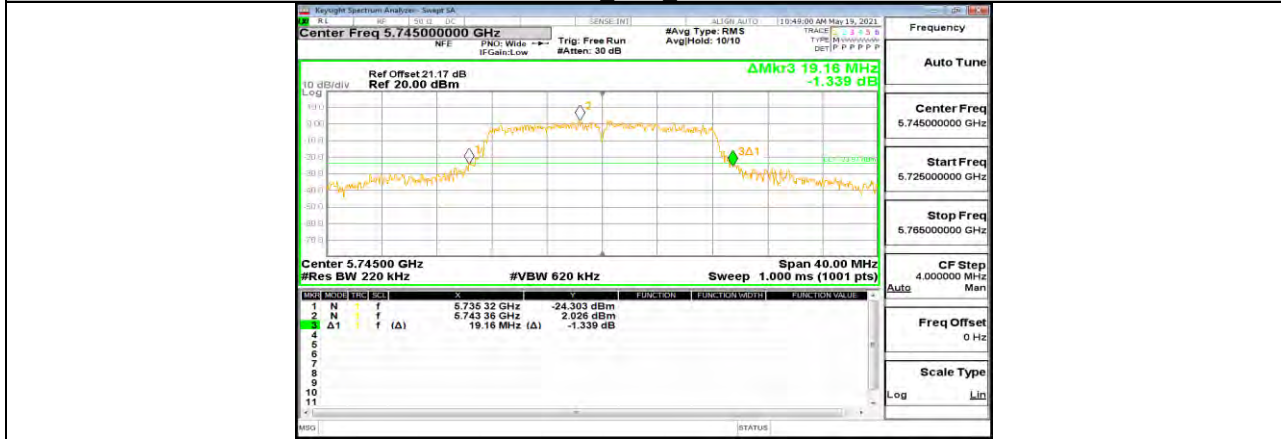

11A Ant1 5745



11A Ant1 5785



11A Ant1 5825



11N20SISO Ant1 5180



11N20SISO Ant1 5200

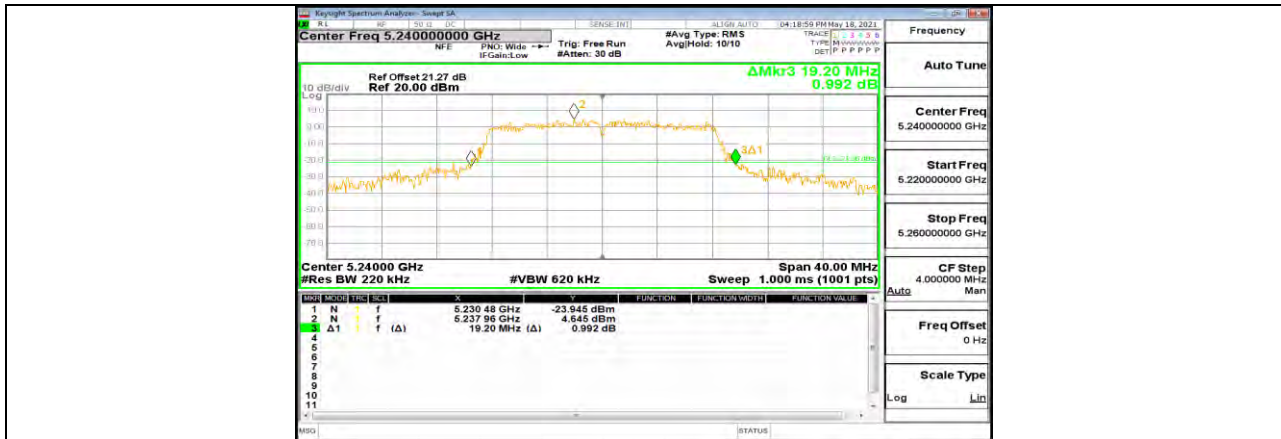

11N20SISO Ant1 5240



11N20SISO Ant1 5260



11N20SISO Ant1 5280



11N20SISO Ant1 5320



11N20SISO Ant1 5500



11N20SISO Ant1 5580

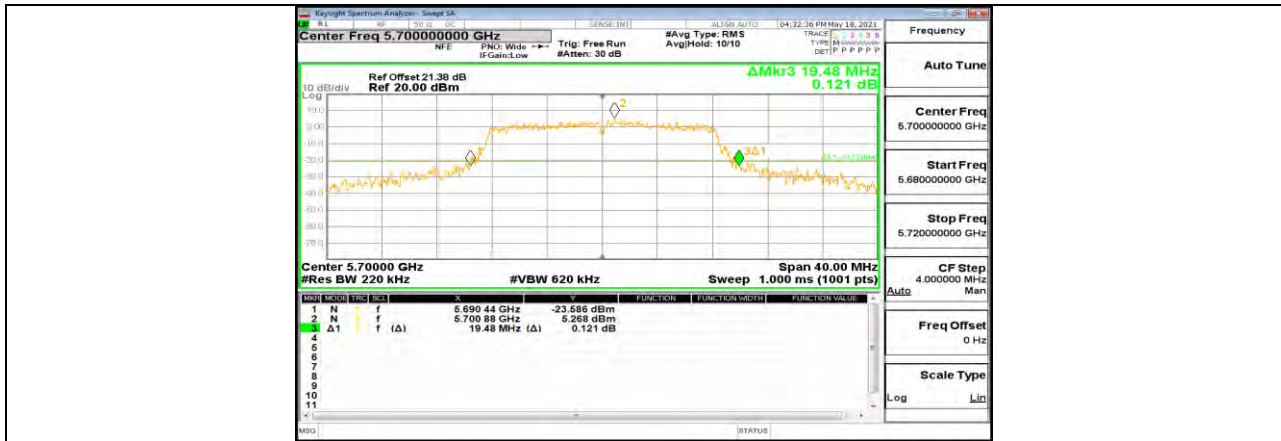

11N20SISO Ant1 5700



11N20SISO Ant1 5720



11N20SISO Ant1 5745



11N20SISO Ant1 5785

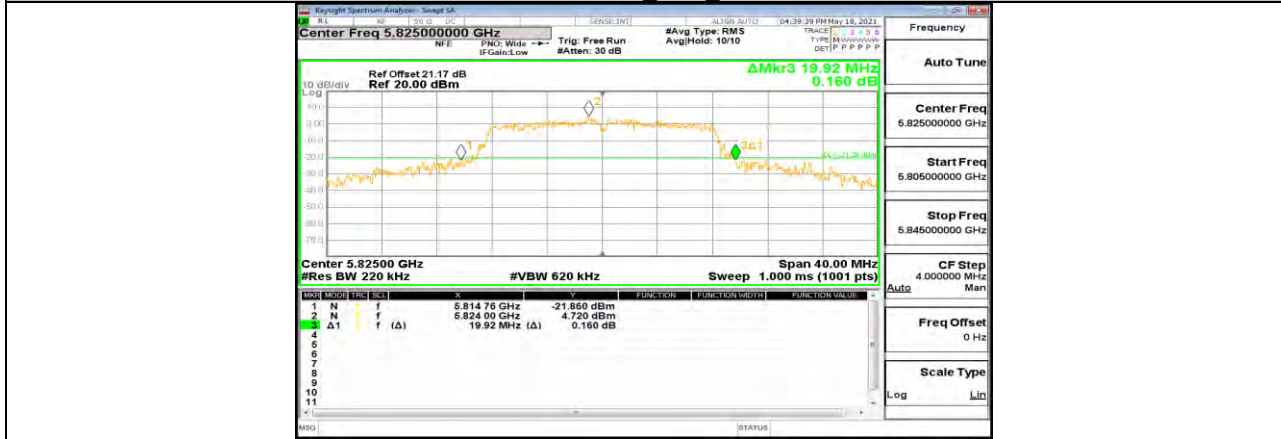

11N20SISO Ant1 5825



11N40SISO Ant1 5190



11N40SISO Ant1 5230

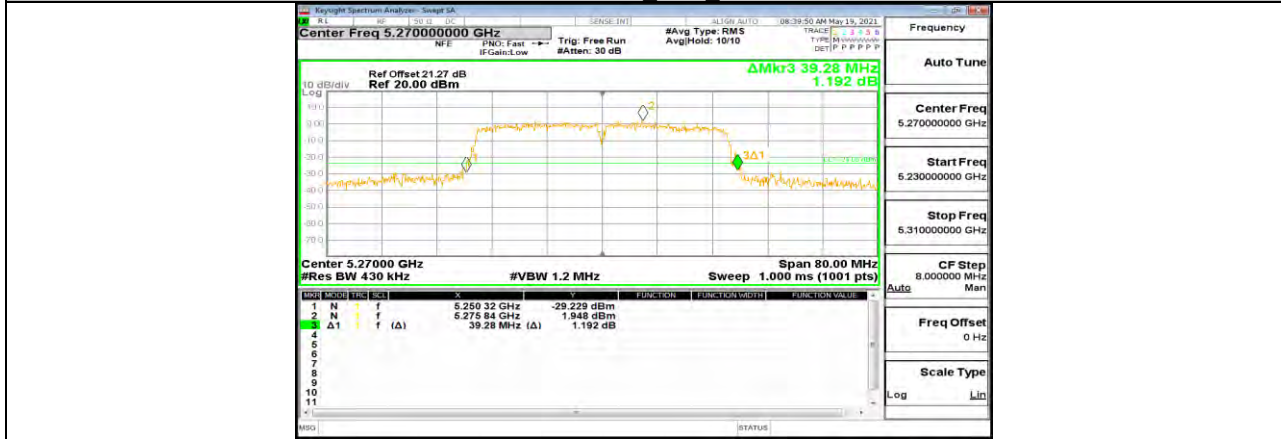

11N40SISO Ant1 5270

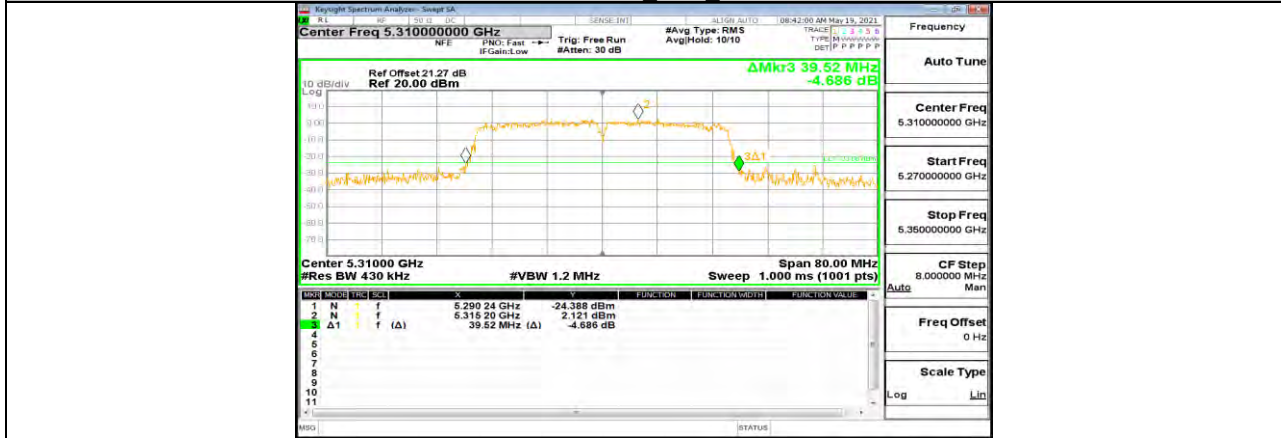

11N40SISO Ant1 5310





11N40SISO Ant1 5510



11N40SISO Ant1 5550



11N40SISO Ant1 5670



11N40SISO Ant1 5710



11N40SISO Ant1 5755



11N40SISO Ant1 5795

### 13.2. Appendix A2: Occupied channel bandwidth

#### 13.2.1. Test Result

Test Mode	Antenna	Channel	OCB [MHz]	FL[MHz]	FH[MHz]	Verdict
11A	Ant1	5180	16.675	5171.718	5188.393	PASS
		5200	16.574	5191.753	5208.327	PASS
		5240	16.679	5231.745	5248.424	PASS
		5260	16.732	5251.604	5268.336	PASS
		5280	16.703	5271.692	5288.395	PASS
		5320	16.636	5311.727	5328.363	PASS
		5500	16.561	5491.754	5508.315	PASS
		5580	16.660	5571.680	5588.340	PASS
		5700	16.636	5691.714	5708.350	PASS
		5720	16.983	5711.561	5728.544	PASS
		5720 UNII-2C	13.439	5711.561	5725	PASS
		5720 UNII-3	3.544	5725	5728.544	PASS
		5745	16.769	5736.687	5753.456	PASS
		5785	16.716	5776.664	5793.380	PASS
11N20SISO	Ant1	5825	16.768	5816.718	5833.486	PASS
		5180	16.623	5171.688	5188.311	PASS
		5200	16.727	5191.713	5208.440	PASS
		5240	16.706	5231.706	5248.412	PASS
		5260	16.641	5251.695	5268.336	PASS
		5280	16.590	5271.690	5288.280	PASS
		5320	16.562	5311.756	5328.318	PASS
		5500	16.649	5491.727	5508.376	PASS
		5580	16.595	5571.735	5588.330	PASS
		5700	16.714	5691.674	5708.388	PASS
		5720	17.955	5711.102	5729.057	PASS
		5720 UNII-2C	13.898	5711.102	5725	PASS
		5720 UNII-3	4.057	5725	5729.057	PASS
		5745	16.782	5736.626	5753.408	PASS
11N40SISO	Ant1	5785	16.791	5776.658	5793.449	PASS
		5825	16.774	5816.645	5833.419	PASS
		5190	36.114	5171.896	5208.010	PASS
		5230	36.013	5211.949	5247.962	PASS
		5270	36.066	5251.927	5287.993	PASS
		5310	36.191	5291.938	5328.129	PASS
		5510	36.004	5491.931	5527.935	PASS
		5550	36.052	5531.982	5568.034	PASS
		5670	36.039	5651.953	5687.992	PASS
		5710	36.123	5692.054	5728.177	PASS
		5710 UNII-2C	32.946	5692.054	5725	PASS
		5710 UNII-3	3.177	5725	5728.177	PASS
		5755	36.066	5736.943	5773.009	PASS
		5795	36.049	5776.974	5813.023	PASS



### 13.2.2. Test Graphs



