



**CFR 47 FCC PART 15 SUBPART C  
ISED RSS-247 ISSUE 2**

**TEST REPORT**

*For*

**Infinity Game Board**

**MODEL NUMBER: IGB-I-301200**

**REPORT NUMBER: 4790665413.2-1-RF-1**

**ISSUE DATE: January 05, 2023**

**FCC ID:2APXHIGB23  
IC:24128-IGB23**

*Prepared for*

**WF Tastemakers Trading Limited**

**Unit 05 and unit 06, 6th Floor, Greenfield Tower Concordia Plaza, 1 Science  
Museum Road, TST East, Hong Kong(For FCC)**

**347 Fifth Avenue Suite 1402-199, New York NY 10018 United States Of America  
(Excluding The States Of Alaska)(For ISED)**

*Prepared by*

**UL Verification Services (Guangzhou) Co., Ltd, Song Shan Lake Branch**

**Building 10, Innovation Technology Park, No. 1, Li Bin Road, Song Shan Lake Hi-  
Tech Development Zone Dongguan, 523808, People's Republic of China**

**Tel: +86 769 22038881**

**Fax: +86 769 33244054**

**Website: [www.ul.com](http://www.ul.com)**

The results reported herein have been performed in accordance with the laboratory's terms of accreditation. This report shall not be reproduced except in full without the written approval of the Laboratory. The results in this report apply to the test sample(s) mentioned above at the time of the testing period only and are not to be used to indicate applicability to other similar products.



Revision History

Rev.	Issue Date	Revisions	Revised By
V0	January 05, 2023	Initial Issue	



### Summary of Test Results

Test Item	Clause	Limit/Requirement	Result
Antenna Requirement	N/A	FCC Part 15.203/15.247 (c) RSS-GEN Clause 6.8	Pass
AC Power Line Conducted Emission	ANSI C63.10-2013, Clause 6.2	FCC Part 15.207 RSS-GEN Clause 8.8	Pass
Conducted Output Power	ANSI C63.10-2013, Clause 11.9.1.3	FCC Part 15.247 (b)(3) RSS-247 Clause 5.4 (d)	Pass
6dB Bandwidth and 99% Occupied Bandwidth	ANSI C63.10-2013, Clause 11.8.1	FCC Part 15.247 (a)(2) RSS-247 Clause 5.2 (a) ISED RSS-Gen Clause 6.7	Pass
Power Spectral Density	ANSI C63.10-2013, Clause 11.10.2	FCC Part 15.247 (e) RSS-247 Clause 5.2 (b)	Pass
Conducted Band edge and spurious emission	ANSI C63.10-2013, Clause 11.11	FCC Part 15.247(d) RSS-247 Clause 5.5	Pass
Radiated Band edge and Spurious Emission	ANSI C63.10-2013, Clause 11.12 & Clause 11.13	FCC Part 15.247 (d) FCC Part 15.205/15.209 RSS-247 Clause 5.5 RSS-GEN Clause 8.9	Pass
Duty Cycle	ANSI C63.10-2013, Clause 11.6	None; for reporting purposes only.	Pass

\*This test report is only published to and used by the applicant, and it is not for evidence purpose in China.

\*The measurement result for the sample received is <Pass> according to <CFR 47 FCC PART 15 SUBPART C ISED RSS-247 ISSUE 2> when <Accuracy Method> decision rule is applied.

## CONTENTS

<b>1. ATTESTATION OF TEST RESULTS</b> .....	<b>6</b>
<b>2. TEST METHODOLOGY</b> .....	<b>7</b>
<b>3. FACILITIES AND ACCREDITATION</b> .....	<b>7</b>
<b>4. CALIBRATION AND UNCERTAINTY</b> .....	<b>8</b>
4.1. <i>MEASURING INSTRUMENT CALIBRATION</i> .....	8
4.2. <i>MEASUREMENT UNCERTAINTY</i> .....	8
<b>5. EQUIPMENT UNDER TEST</b> .....	<b>9</b>
5.1. <i>DESCRIPTION OF EUT</i> .....	9
5.2. <i>CHANNEL LIST</i> .....	9
5.3. <i>MAXIMUM EIRP</i> .....	9
5.4. <i>TEST CHANNEL CONFIGURATION</i> .....	9
5.5. <i>THE WORSE CASE POWER SETTING PARAMETER</i> .....	10
5.6. <i>DESCRIPTION OF AVAILABLE ANTENNAS</i> .....	11
5.7. <i>SUPPORT UNITS FOR SYSTEM TEST</i> .....	12
<b>6. MEASURING EQUIPMENT AND SOFTWARE USED</b> .....	<b>13</b>
<b>7. ANTENNA PORT TEST RESULTS</b> .....	<b>16</b>
7.1. <i>CONDUCTED OUTPUT POWER</i> .....	16
7.2. <i>6DB BANDWIDTH AND 99% OCCUPIED BANDWIDTH</i> .....	17
7.3. <i>POWER SPECTRAL DENSITY</i> .....	19
7.4. <i>CONDUCTED BAND EDGE AND SPURIOUS EMISSION</i> .....	21
7.5. <i>DUTY CYCLE</i> .....	23
<b>8. RADIATED TEST RESULTS</b> .....	<b>24</b>
8.1. <i>RESTRICTED BANDEDGE</i> .....	33
8.2. <i>SPURIOUS EMISSIONS(1 GHZ~3 GHZ)</i> .....	46
8.3. <i>SPURIOUS EMISSIONS(3 GHZ~18 GHZ)</i> .....	52
8.4. <i>SPURIOUS EMISSIONS(9 KHZ~30 MHZ)</i> .....	70
8.5. <i>SPURIOUS EMISSIONS(18 GHZ~26 GHZ)</i> .....	73
8.6. <i>SPURIOUS EMISSIONS(30 MHZ~1 GHZ)</i> .....	75
<b>9. ANTENNA REQUIREMENT</b> .....	<b>77</b>
<b>10. AC POWER LINE CONDUCTED EMISSION</b> .....	<b>78</b>
<b>11. TEST DATA</b> .....	<b>82</b>
11.1. <i>APPENDIX A: DTS BANDWIDTH</i> .....	82



11.1.1.	Test Result .....	82
11.1.2.	Test Graphs .....	83
11.2.	<i>APPENDIX B: OCCUPIED CHANNEL BANDWIDTH .....</i>	<i>86</i>
11.2.1.	Test Result .....	86
11.2.2.	Test Graphs .....	87
11.3.	<i>APPENDIX C: MAXIMUM CONDUCTED AVG OUTPUT POWER.....</i>	<i>90</i>
11.3.1.	Test Result .....	90
11.4.	<i>APPENDIX D: MAXIMUM POWER SPECTRAL DENSITY .....</i>	<i>91</i>
11.4.1.	Test Result .....	91
11.4.2.	Test Graphs .....	92
11.5.	<i>APPENDIX E: BAND EDGE MEASUREMENTS .....</i>	<i>95</i>
11.5.1.	Test Result .....	95
11.5.2.	Test Graphs .....	96
11.6.	<i>APPENDIX F: CONDUCTED SPURIOUS EMISSION .....</i>	<i>98</i>
11.6.1.	Test Result .....	98
11.6.2.	Test Graphs .....	99
11.7.	<i>APPENDIX G: DUTY CYCLE.....</i>	<i>108</i>
11.7.1.	Test Result .....	108
11.7.2.	Test Graphs .....	109



## 1. ATTESTATION OF TEST RESULTS

### Applicant Information

Company Name: WF Tastemakers Trading Limited  
 FCC Address: Unit 05 and unit 06, 6th Floor, Greenfield Tower Concordia Plaza,  
 1 Science Museum Road, TST East, Hong Kong  
 ISED Address: 347 Fifth Avenue Suite 1402-199, New York NY 10018 United  
 States Of America (Excluding The States Of Alaska)

### Manufacturer Information

Company Name: WF Tastemakers Trading Limited  
 FCC Address: Unit 05 and unit 06, 6th Floor, Greenfield Tower Concordia Plaza,  
 1 Science Museum Road, TST East, Hong Kong  
 ISED Address: 347 Fifth Avenue Suite 1402-199, New York NY 10018 United  
 States Of America (Excluding The States Of Alaska)

### EUT Information

EUT Name: Infinity Game Board  
 Model: IGB-I-301200  
 Sample Received Date: December 2, 2022  
 Sample Status: Normal  
 Sample ID: 5588950  
 Date of Tested: December 2, 2022 to January 05, 2023

APPLICABLE STANDARDS	
STANDARD	TEST RESULTS
CFR 47 FCC PART 15 SUBPART C ISED RSS-247 ISSUE 2	Pass

Prepared By:

Kebo Zhang  
 Senior Project Engineer

Checked By:

Denny Huang  
 Senior Project Engineer

Approved By:

Stephen Guo  
 Operations Manager



## 2. TEST METHODOLOGY

All tests were performed in accordance with the standard CFR 47 FCC PART 15 SUBPART C ISED RSS-247 ISSUE 2, KDB 558074 D01 15.247 Meas Guidance v05r02, KDB 414788 D01 Radiated Test Site v01r01, CFR 47 FCC Part 2, CFR 47 FCC Part 15, ANSI C63.10-2013, ISED RSS-247 Issue 2 and ISED RSS-GEN Issue 5.

## 3. FACILITIES AND ACCREDITATION

Accreditation Certificate	<p><b>A2LA (Certificate No.: 4102.01)</b> UL Verification Services (Guangzhou) Co., Ltd. Song Shan Lake Branch. has been assessed and proved to be in compliance with A2LA.</p> <p><b>FCC (FCC Designation No.: CN1187)</b> UL Verification Services (Guangzhou) Co., Ltd. Song Shan Lake Branch. Has been recognized to perform compliance testing on equipment subject to the Commission's Declaration of Conformity (DoC) and Certification rules</p> <p><b>ISED (Company No.: 21320)</b> UL Verification Services (Guangzhou) Co., Ltd. Song Shan Lake Branch. has been registered and fully described in a report filed with ISED. The Company Number is 21320 and the test lab Conformity Assessment Body Identifier (CABID) is CN0046.</p> <p><b>VCCI (Registration No.: G-20019, R-20004, C-20012 and T-20011)</b> UL Verification Services (Guangzhou) Co., Ltd. Song Shan Lake Branch. has been assessed and proved to be in compliance with VCCI, the Membership No. is 3793. Facility Name: Chamber D, the VCCI registration No. is G-20019 and R-20004 Shielding Room B , the VCCI registration No. is C-20012 and T-20011</p>
---------------------------	---

### Note1:

All tests measurement facilities use to collect the measurement data are located at Building 10, Innovation Technology Park, No. 1, Li Bin Road, Song Shan Lake Hi-Tech Development Zone Dongguan, 523808, People's Republic of China.

### Note2:

The test anechoic chamber in UL Verification Services (Guangzhou) Co., Ltd. Song Shan Lake Branch had been calibrated and compared to the open field sites and the test anechoic chamber is shown to be equivalent to or worst case from the open field site.

### Note3:

For below 30 MHz, lab had performed measurements at test anechoic chamber and comparing to measurements obtained on an open field site. And these measurements below 30 MHz had been correlated to measurements performed on an OFS.



## 4. CALIBRATION AND UNCERTAINTY

### 4.1. MEASURING INSTRUMENT CALIBRATION

The measuring equipment utilized to perform the tests documented in this report has been calibrated in accordance with the manufacturer's recommendations and is traceable to recognized national standards.

### 4.2. MEASUREMENT UNCERTAINTY

Where relevant, the following measurement uncertainty levels have been estimated for tests performed on the apparatus:

Test Item	Uncertainty
Conduction emission	3.62 dB
Radiated Emission (Included Fundamental Emission) (9 kHz ~ 30 MHz)	2.2 dB
Radiated Emission (Included Fundamental Emission) (30 MHz ~ 1 GHz)	4.00 dB
Radiated Emission (Included Fundamental Emission) (1 GHz to 26 GHz)	5.78 dB (1 GHz ~ 18 GHz)
	5.23 dB (18 GHz ~ 26 GHz)
Note: This uncertainty represents an expanded uncertainty expressed at approximately the 95% confidence level using a coverage factor of k=2.	



## 5. EQUIPMENT UNDER TEST

### 5.1. DESCRIPTION OF EUT

EUT Name	Infinity Game Board
Model	IGB-I-301200
Power Supply	AC 120 V, 60 Hz
Frequency Range:	2412 MHz to 2462 MHz
Radio Technology	IEEE802.11b/g/n HT20
Type of Modulation:	IEEE 802.11b: DSSS(CCK, DQPSK, DBPSK) IEEE 802.11g/n: OFDM(64-QAM, 16-QAM, QPSK, BPSK)
Normal Test Voltage:	AC 120 V, 60 Hz

### 5.2. CHANNEL LIST

Channel List for 802.11b/g/n (20 MHz)							
Channel	Frequency (MHz)	Channel	Frequency (MHz)	Channel	Frequency (MHz)	Channel	Frequency (MHz)
1	2412	4	2427	7	2442	10	2457
2	2417	5	2432	8	2447	11	2462
3	2422	6	2437	9	2452	/	/

### 5.3. MAXIMUM EIRP

IEEE Std. 802.11	Frequency (MHz)	Channel Number	Maximum Conducted AVG Output Power (dBm)	Maximum AVG EIRP (dBm)
b	2412 ~ 2462	1-11[11]	11.80	16.72
g	2412 ~ 2462	1-11[11]	10.63	15.55
n HT20	2412 ~ 2462	1-11[11]	10.11	15.03

### 5.4. TEST CHANNEL CONFIGURATION

IEEE Std. 802.11	Test Channel Number	Frequency
b	CH 1(Low Channel), CH 6(MID Channel), CH 11(High Channel)	2412 MHz, 2437 MHz, 2462 MHz
g	CH 1(Low Channel), CH 6(MID Channel), CH 11(High Channel)	2412 MHz, 2437 MHz, 2462 MHz
n HT20	CH 1(Low Channel), CH 6(MID Channel), CH 11(High Channel)	2412 MHz, 2437 MHz, 2462 MHz



### 5.5. THE WORSE CASE POWER SETTING PARAMETER

The Worse Case Power Setting Parameter under 2400 ~ 2483.5MHz Band							
Test Software		RF Test Tool					
Modulation Mode	Transmit Antenna Number	Test Channel					
		NCB: 20MHz			NCB: 40MHz		
		CH 1	CH 6	CH 11	CH 3	CH 6	CH 9
802.11b	1	Default	Default	Default	/		
802.11g	1	Default	Default	Default			
802.11n HT20	1	Default	Default	Default			

## WORST-CASE CONFIGURATIONS

The EUT was tested in the following configuration(s):

Controlled in test mode using a software application on the EUT supplied by customer. The application was used to enable a continuous transmission and to select the mode, test channels, bandwidth, data rates as required.

Test channels referring to section 5.4.

Maximum power setting referring to section 5.5.

Worst-case data rates as provided by the client were:

- 802.11b mode: 1 Mbps
- 802.11g mode: 6 Mbps
- 802.11n HT20 mode: MCS0

The measured additional path loss was included in any path loss calculations for all RF cable used during tested.



### 5.6. DESCRIPTION OF AVAILABLE ANTENNAS

Antenna	Frequency (MHz)	Antenna Type	MAX Antenna Gain (dBi)
1	2412-2462	IPEX Connector	4.92

Test Mode	Transmit and Receive Mode	Description
IEEE 802.11b	<input checked="" type="checkbox"/> 1TX, 1RX	ANT 1 can be used as transmitting/receiving antenna.
IEEE 802.11g	<input checked="" type="checkbox"/> 1TX, 1RX	ANT 1 can be used as transmitting/receiving antenna.
IEEE 802.11n HT20	<input checked="" type="checkbox"/> 1TX, 1RX	ANT 1 can be used as transmitting/receiving antenna.

Note: The value of the antenna gain was declared by customer.

## 5.7. SUPPORT UNITS FOR SYSTEM TEST

### SUPPORT EQUIPMENT

Item	Equipment	Brand Name	Model Name	P/N
1	PC	Lenovo	E42-80	/

### I/O CABLES

Cable No	Port	Connector Type	Cable Type	Cable Length(m)	Remarks
1	USB	/	/	1.0	/

### ACCESSORIES

Item	Accessory	Brand Name	Model Name	Description
1	Switching Power Supply	Royal-Etech International Limited	BI36L-120300-I-LED	Input: 100-240V~ 50/60Hz 1.2A Output: 12.0V  3.0A 36.0W

### TEST SETUP

The EUT can work in engineering mode with a software through a Laptop.

### SETUP DIAGRAM FOR TESTS

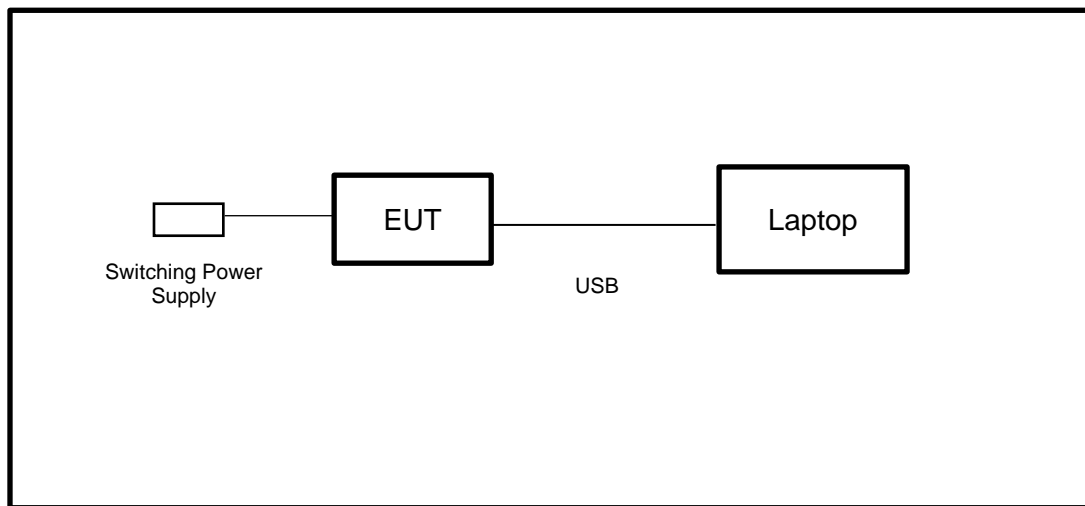

**6. MEASURING EQUIPMENT AND SOFTWARE USED**

<b>R&amp;S TS 8997 Test System</b>					
Equipment	Manufacturer	Model No.	Serial No.	Last Cal.	Due. Date
Power sensor, Power Meter	R&S	OSP120	100921	Apr.02,2022	Apr.01,2023
Vector Signal Generator	R&S	SMBV100A	261637	Oct.17, 2022	Oct.16, 2023
Signal Generator	R&S	SMB100A	178553	Oct.17, 2022	Oct.16, 2023
Signal Analyzer	R&S	FSV40	101118	Oct.17, 2022	Oct.16, 2023
<b>Software</b>					
Description	Manufacturer	Name		Version	
For R&S TS 8997 Test System	Rohde & Schwarz	EMC 32		10.60.10	
<b>Tonsend RF Test System</b>					
Equipment	Manufacturer	Model No.	Serial No.	Last Cal.	Due. Date
Wideband Radio Communication Tester	R&S	CMW500	155523	Oct.17, 2022	Oct.16, 2023
Wireless Connectivity Tester	R&S	CMW270	1201.0002N75-102	Sep.28, 2022	Sep.27, 2023
PXA Signal Analyzer	Keysight	N9030A	MY55410512	Oct.17, 2022	Oct.16, 2023
MXG Vector Signal Generator	Keysight	N5182B	MY56200284	Oct.17, 2022	Oct.16, 2023
MXG Vector Signal Generator	Keysight	N5172B	MY56200301	Oct.17, 2022	Oct.16, 2023
DC power supply	Keysight	E3642A	MY55159130	Oct.17, 2022	Oct.16, 2023
Temperature & Humidity Chamber	SANMOOD	SG-80-CC-2	2088	Oct.17, 2022	Oct.16, 2023
<b>Software</b>					
Description	Manufacturer	Name		Version	
Tonsend SRD Test System	Tonsend	JS1120-3 RF Test System		2.6.77.0518	



Conducted Emissions					
Equipment	Manufacturer	Model No.	Serial No.	Last Cal.	Due Date
EMI Test Receiver	R&S	ESR3	101961	Oct.17, 2022	Oct.16, 2023
Two-Line V-Network	R&S	ENV216	101983	Oct.17, 2022	Oct.16, 2023
Artificial Mains Networks	Schwarzbeck	NSLK 8126	8126465	Oct.17, 2022	Oct.16, 2023
Software					
Description			Manufacturer	Name	Version
Test Software for Conducted Emissions			Farad	EZ-EMC	Ver. UL-3A1

Radiated Emissions					
Equipment	Manufacturer	Model No.	Serial No.	Last Cal.	Due Date
MXE EMI Receiver	KESIGHT	N9038A	MY56400036	Oct.17, 2022	Oct.16, 2023
Hybrid Log Periodic Antenna	TDK	HLP-3003C	130959	Aug.02, 2021	Aug.01, 2024
Preamplifier	HP	8447D	2944A09099	Oct.17, 2022	Oct.16, 2023
EMI Measurement Receiver	R&S	ESR26	101377	Oct.17, 2022	Oct.16, 2023
Horn Antenna	TDK	HRN-0118	130940	July 20, 2021	July 19, 2024
Preamplifier	TDK	PA-02-0118	TRS-305-00067	Oct.17, 2022	Oct.16, 2023
Horn Antenna	Schwarzbeck	BBHA9170	697	July 20, 2021	July 19, 2024
Preamplifier	TDK	PA-02-2	TRS-307-00003	Oct.17, 2022	Oct.16, 2023
Preamplifier	TDK	PA-02-3	TRS-308-00002	Oct.17, 2022	Oct.16, 2023
Loop antenna	Schwarzbeck	1519B	00008	Dec.14, 2021	Dec.13, 2024
Preamplifier	TDK	PA-02-001-3000	TRS-302-00050	Oct.17, 2022	Oct.16, 2023
Preamplifier	Mini-Circuits	ZX60-83LN-S+	SUP01202035	Oct.17, 2022	Oct.16, 2023
High Pass Filter	Wi	WHKX10-2700-3000-18000-40SS	23	/	/
Highpass Filter	Wainwright	WHKX10-5850-6500-1800-40SS	4	/	/
Band Reject Filter	Wainwright	WRCJV12-5695-5725-5850-5880-40SS	4	/	/
Band Reject Filter	Wainwright	WRCJV20-5120-5150-	2	/	/



		5350-5380-60SS			
Band Reject Filter	Wainwright	WRCJV20-5440-5470-5725-5755-60SS	1	/	/
Band Reject Filter	Wainwright	WRCJV8-2350-2400-2483.5-2533.5-40SS	4	/	/
Band Reject Filter	Wainwright	WRCD5-1879-1879.85-1880.15-1881-40SS	1	/	/
Notch Filter	Wainwright	WHJ10-882-980-7000-40SS	1	/	/
Software					
Description			Manufacturer	Name	Version
Test Software for Radiated Emissions			Farad	EZ-EMC	Ver. UL-3A1

Other Instrument					
Equipment	Manufacturer	Model No.	Serial No.	Last Cal.	Due Date
Temperature humidity probe	OMEGA	ITHX-SD-5	18470007	Oct.22, 2022	Oct.21, 2023
Barometer	Yiyi	Baro	N/A	Oct.24, 2022	Oct.23, 2023
Attenuator	Agilent	8495B	2814a12853	Oct.18, 2022	Oct.17, 2023



## 7. ANTENNA PORT TEST RESULTS

### 7.1. CONDUCTED OUTPUT POWER

#### LIMITS

CFR 47 FCC Part15 (15.247) Subpart C ISED RSS-247 ISSUE 2			
Section	Test Item	Limit	Frequency Range (MHz)
CFR 47 FCC 15.247(b)(3) ISED RSS-247 5.4 (d)	AVG Output Power	1 watt or 30 dBm	2400-2483.5

#### TEST PROCEDURE

Refer to ANSI C63.10-2013 clause 11.9.2.3.1.

Connect the EUT to a low loss RF cable from the antenna port to the power sensor (video bandwidth is greater than the occupied bandwidth).

Measure peak emission level, the indicated level is the average output power, after any corrections for external attenuators and cables.

The test result in dBm by adding  $[10 \log (1 / D)]$ , where D is the duty cycle.

#### TEST SETUP

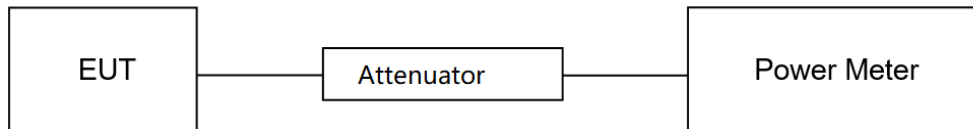

#### TEST ENVIRONMENT

Temperature	22.3°C	Relative Humidity	51.6%
Atmosphere Pressure	101.2kPa	Test Voltage	AC 120 V, 60 Hz

#### TEST DATE / ENGINEER

Test Date	December 14, 2022	Test By	Walker Yuan
-----------	-------------------	---------	-------------

#### TEST RESULTS

Please refer to section "Test Data" - Appendix C



## 7.2. 6DB BANDWIDTH AND 99% OCCUPIED BANDWIDTH

### LIMITS

CFR 47 FCC Part15 (15.247) Subpart C ISED RSS-247 ISSUE 2			
Section	Test Item	Limit	Frequency Range (MHz)
CFR 47 FCC 15.247(a)(2) ISED RSS-247 5.2 (a)	6 dB Bandwidth	≥ 500 kHz	2400-2483.5
ISED RSS-Gen Clause 6.7	99 % Occupied Bandwidth	For reporting purposes only.	2400-2483.5

### TEST PROCEDURE

Refer to ANSI C63.10-2013 clause 11.8 for DTS bandwidth and clause 6.9 for Occupied Bandwidth.

Connect the EUT to the spectrum analyser and use the following settings:

Center Frequency	The center frequency of the channel under test
Frequency Span	For 6 dB Bandwidth: Enough to capture all products of the modulation carrier emission For 99 % Occupied Bandwidth: Between 1.5 times and 5.0 times the OBW
Detector	Peak
RBW	For 6 dB Bandwidth: 100 kHz For 99 % Occupied Bandwidth: 1 % to 5 % of the occupied bandwidth
VBW	For 6 dB Bandwidth: ≥3 × RBW For 99 % Occupied Bandwidth: ≥3 × RBW
Trace	Max hold
Sweep	Auto couple

a) Use the 99 % power bandwidth function of the instrument, allow the trace to stabilize and report the measured bandwidth.

b) Allow the trace to stabilize and measure the maximum width of the emission that is constrained by the frequencies associated with the two outermost amplitude points (upper and lower frequencies) that are attenuated by 6 dB relative to the maximum level measured in the fundamental emission.



**TEST SETUP**

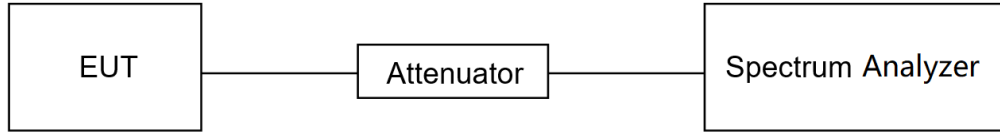

**TEST ENVIRONMENT**

Temperature	22.3°C	Relative Humidity	51.6%
Atmosphere Pressure	101.2kPa	Test Voltage	AC 120 V, 60 Hz

**TEST DATE / ENGINEER**

Test Date	December 14, 2022	Test By	Walker Yuan
-----------	-------------------	---------	-------------

**TEST RESULTS**

Please refer to section "Test Data" - Appendix A&B

### 7.3. POWER SPECTRAL DENSITY

#### LIMITS

CFR 47 FCC Part15 (15.247) Subpart C ISED RSS-247 ISSUE 2			
Section	Test Item	Limit	Frequency Range (MHz)
CFR 47 FCC §15.247 (e) ISED RSS-247 5.2 (b)	Power Spectral Density	8 dBm in any 3 kHz band	2400-2483.5

#### TEST PROCEDURE

Refer to ANSI C63.10-2013 clause 11.10.5.

Connect the EUT to the spectrum analyser and use the following settings:

Center Frequency	The center frequency of the channel under test
Detector	power averaging (rms)
RBW	$3 \text{ kHz} \leq \text{RBW} \leq 100 \text{ kHz}$
VBW	$\geq 3 \times \text{RBW}$
Span	1.5 x OBW bandwidth
Trace	Average
Sweep time	Auto couple

Allow trace to fully stabilize and use the peak marker function to determine the maximum amplitude level within the RBW.

If measured value exceeds limit, reduce RBW (no less than 3 kHz) and repeat.

#### TEST SETUP

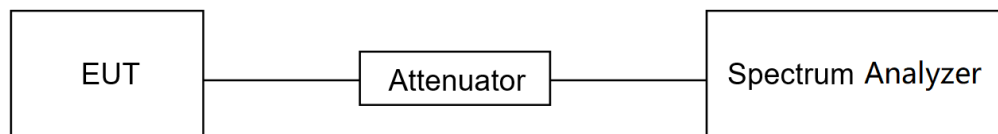

#### TEST ENVIRONMENT

Temperature	22.3°C	Relative Humidity	51.6%
Atmosphere Pressure	101.2kPa	Test Voltage	AC 120 V, 60 Hz

#### TEST DATE / ENGINEER

Test Date	December 14, 2022	Test By	Walker Yuan
-----------	-------------------	---------	-------------



**TEST RESULTS**

Please refer to section "Test Data" - Appendix D

## 7.4. CONDUCTED BAND EDGE AND SPURIOUS EMISSION

### LIMITS

CFR 47 FCC Part15 (15.247) Subpart C ISED RSS-247 ISSUE 2		
Section	Test Item	Limit
CFR 47 FCC §15.247 (d) ISED RSS-247 5.5	Conducted Bandedge and Spurious Emissions	at least 30 dB below that in the 100 kHz bandwidth within the band that contains the highest level of the desired power

### TEST PROCEDURE

Refer to ANSI C63.10-2013 clause 11.11 and 11.13.

Connect the EUT to the spectrum analyser and use the following settings for reference level measurement:

Center Frequency	The center frequency of the channel under test
Detector	Peak
RBW	100 kHz
VBW	$\geq 3 \times \text{RBW}$
Span	1.5 x DTS bandwidth
Trace	Max hold
Sweep time	Auto couple.

Allow trace to fully stabilize and use the peak marker function to determine the maximum PSD level.

Change the settings for emission level measurement:

Span	Set the center frequency and span to encompass frequency range to be measured
Detector	Peak
RBW	100 kHz
VBW	$\geq 3 \times \text{RBW}$
measurement points	$\geq \text{span}/\text{RBW}$
Trace	Max hold
Sweep time	Auto couple.

Allow trace to fully stabilize and use the peak marker function to determine the maximum PSD level. Ensure that the amplitude of all unwanted emissions outside of the authorized frequency band (excluding restricted frequency bands) is attenuated by at least the minimum requirements specified in 11.11.



**TEST SETUP**

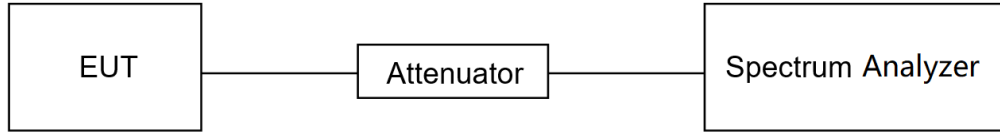

**TEST ENVIRONMENT**

Temperature	22.3°C	Relative Humidity	51.6%
Atmosphere Pressure	101.2kPa	Test Voltage	AC 120 V, 60 Hz

**TEST DATE / ENGINEER**

Test Date	December 14, 2022	Test By	Walker Yuan
-----------	-------------------	---------	-------------

**TEST RESULTS**

Please refer to section "Test Data" - Appendix E&F



## 7.5. DUTY CYCLE

### LIMITS

None; for reporting purposes only.

### TEST PROCEDURE

Refer to ANSI C63.10-2013 clause 11.6 Zero – Span Spectrum Analyzer method.

### TEST SETUP

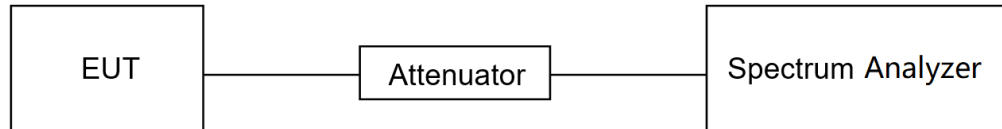

### TEST ENVIRONMENT

Temperature	22.3°C	Relative Humidity	51.6%
Atmosphere Pressure	101.2kPa	Test Voltage	AC 120 V, 60 Hz

### TEST DATE / ENGINEER

Test Date	December 14, 2022	Test By	Walker Yuan
-----------	-------------------	---------	-------------

### TEST RESULTS

Please refer to section "Test Data" - Appendix G



## 8. RADIATED TEST RESULTS

### LIMITS

Please refer to CFR 47 FCC §15.205 and §15.209.

Please refer to ISED RSS-GEN Clause 8.9 and Clause 8.10.

Radiation Disturbance Test Limit for FCC (Class B) (9 kHz ~ 1 GHz)

Emissions radiated outside of the specified frequency bands above 30 MHz			
Frequency Range (MHz)	Field Strength Limit (uV/m) at 3 m	Field Strength Limit (dBuV/m) at 3 m	
		Quasi-Peak	
30 - 88	100	40	
88 - 216	150	43.5	
216 - 960	200	46	
Above 960	500	54	
Above 1000	500	Peak	Average
		74	54

FCC Emissions radiated outside of the specified frequency bands below 30 MHz		
Frequency (MHz)	Field strength (microvolts/meter)	Measurement distance (meters)
0.009-0.490	2400/F(kHz)	300
0.490-1.705	24000/F(kHz)	30
1.705-30.0	30	30

ISED General field strength limits at frequencies below 30 MHz

Table 6 – General field strength limits at frequencies below 30 MHz		
Frequency	Magnetic field strength (H-Field) (uA/m)	Measurement distance (m)
9 - 490 kHz <sup>Note 1</sup>	6.37/F (F in kHz)	300
490 - 1705 kHz	63.7/F (F in kHz)	30
1.705 - 30 MHz	0.08	30

**Note 1:** The emission limits for the ranges 9-90 kHz and 110-490 kHz are based on measurements employing a linear average detector.





ISED Restricted bands please refer to ISED RSS-GEN Clause 8.10

Table 7 – Restricted frequency bands <sup>Note 1</sup>		
MHz	MHz	GHz
0.090 - 0.110	149.9 - 150.05	9.0 - 9.2
0.495 - 0.505	156.52475 - 156.52525	9.3 - 9.5
2.1735 - 2.1905	156.7 - 156.9	10.6 - 12.7
3.020 - 3.026	162.0125 - 167.17	13.25 - 13.4
4.125 - 4.128	167.72 - 173.2	14.47 - 14.5
4.17725 - 4.17775	240 - 285	15.35 - 16.2
4.20725 - 4.20775	322 - 335.4	17.7 - 21.4
5.677 - 5.683	399.9 - 410	22.01 - 23.12
6.215 - 6.218	608 - 614	23.6 - 24.0
6.26775 - 6.26825	960 - 1427	31.2 - 31.8
6.31175 - 6.31225	1435 - 1626.5	36.43 - 36.5
8.291 - 8.294	1645.5 - 1646.5	Above 38.6
8.362 - 8.366	1660 - 1710	
8.37625 - 8.38675	1718.8 - 1722.2	
8.41425 - 8.41475	2200 - 2300	
12.29 - 12.293	2310 - 2390	
12.51975 - 12.52025	2483.5 - 2500	
12.57675 - 12.57725	2655 - 2900	
13.36 - 13.41	3260 - 3267	
16.42 - 16.423	3332 - 3339	
16.60475 - 16.60525	3345.8 - 3358	
16.80425 - 16.80475	3500 - 4400	
25.5 - 25.67	4500 - 5150	
37.5 - 38.25	5350 - 5460	
73 - 74.6	7250 - 7750	
74.8 - 75.2	8025 - 8500	
108 - 138		

**Note 1:** Certain frequency bands listed in table 7 and in bands above 38.6 GHz are designated for licence-exempt applications. These frequency bands and the requirements that apply to related devices are set out in the 200 and 300 series of RSSs.

FCC Restricted bands of operation refer to FCC §15.205 (a):

MHz	MHz	MHz	GHz
0.090-0.110	16.42-16.423	399.9-410	4.5-5.15
<sup>1</sup> 0.495-0.505	16.69475-16.69525	608-614	5.35-5.46
2.1735-2.1905	16.80425-16.80475	960-1240	7.25-7.75
4.125-4.128	25.5-25.67	1300-1427	8.025-8.5
4.17725-4.17775	37.5-38.25	1435-1626.5	9.0-9.2
4.20725-4.20775	73-74.6	1645.5-1646.5	9.3-9.5
6.215-6.218	74.8-75.2	1660-1710	10.6-12.7
6.26775-6.26825	108-121.94	1718.8-1722.2	13.25-13.4
6.31175-6.31225	123-138	2200-2300	14.47-14.5
8.291-8.294	149.9-150.05	2310-2390	15.35-16.2
8.362-8.366	156.52475-156.52525	2483.5-2500	17.7-21.4
8.37625-8.38675	156.7-156.9	2690-2900	22.01-23.12
8.41425-8.41475	162.0125-167.17	3260-3267	23.6-24.0
12.29-12.293	167.72-173.2	3332-3339	31.2-31.8
12.51975-12.52025	240-285	3345.8-3358	36.43-36.5
12.57675-12.57725	322-335.4	3600-4400	( <sup>2</sup> )
13.36-13.41			

Note: <sup>1</sup>Until February 1, 1999, this restricted band shall be 0.490-0.510 MHz.

<sup>2</sup>Above 38.6c

**TEST PROCEDURE**

Below 30 MHz

The setting of the spectrum analyser

RBW	200 Hz (From 9 kHz to 0.15 MHz)/ 9 kHz (From 0.15 MHz to 30 MHz)
VBW	200 Hz (From 9 kHz to 0.15 MHz)/ 9 kHz (From 0.15 MHz to 30 MHz)
Sweep	Auto

1. The testing follows the guidelines in ANSI C63.10-2013 clause 6.4.
2. The EUT was arranged to its worst case and then turntable (from 0 degree to 360 degrees) to find the maximum reading. A pre-amp and a high pass filter are used for the test in order to get better signal level. Both Horizontal, Face-on and Face-off polarizations of the antenna are set to make the measurement.
3. The EUT was placed on a turntable with 80 cm above ground.
4. The EUT was set 3 meters from the interference receiving antenna, which was mounted on the top of a 1 m height antenna tower.
5. The radiated emission limits are based on measurements employing a CISPR quasi-peak detector except for the frequency bands 9-90 kHz, 110-490 kHz and above 1000 MHz Radiated emission limits in these three bands are based on measurements employing an average detector.
6. For measurement below 1 GHz, the initial step in collecting conducted emission data is a spectrum analyzer peak detector mode pre-scanning the measurement frequency range. Significant peaks are then marked and then Quasi Peak and average detector mode re-measured. If the emission level of the EUT measured by the peak detector is 3 dB lower than the applicable limit, the peak emission level will be reported. Otherwise, the emission measurement will be repeated using the quasi-peak and average detector and reported.
7. Although these tests were performed other than open field site, adequate comparison measurements were confirmed against 30m open field site. Therefore sufficient tests were made to demonstrate that the alternative site produces results that correlate with the ones of tests made in an open field site based on KDB 414788.
8. The limits in CFR 47, Part 15, Subpart C, paragraph 15.209 (a), are identical to those in RSS-GEN Section 8.9, Table 6, since the measurements are performed in terms of magnetic field strength and converted to electric field strength levels (as reported in the table) using the free space impedance of 377Ω. For example, the measurement frequency X KHz resulted in a level of Y dBuV/m, which is equivalent to  $Y-51.5 = Z$  dBuA/m, which has the same margin, W dB, to the corresponding RSS-GEN Table 6 limit as it has to be 15.209(a) limit.

Below 1 GHz and above 30 MHz

The setting of the spectrum analyser

RBW	120 kHz
VBW	300 kHz
Sweep	Auto
Detector	Peak/QP
Trace	Max hold

1. The testing follows the guidelines in ANSI C63.10-2013 clause 6.5.
2. The EUT was arranged to its worst case and then tune the antenna tower (from 1 m to 4 m) and turntable (from 0 degree to 360 degrees) to find the maximum reading. A pre-amp and a high pass filter are used for the test in order to get better signal level. Both horizontal and vertical polarizations of the antenna are set to make the measurement.
3. The EUT was placed on a turntable with 80 cm above ground.
4. The EUT was set 3 meters from the interference receiving antenna, which was mounted on the top of a variable height antenna tower.
5. For measurement below 1 GHz, the initial step in collecting conducted emission data is a spectrum analyzer peak detector mode pre-scanning the measurement frequency range. Significant peaks are then marked and then Quasi Peak detector mode re-measured. If the emission level of the EUT measured by the peak detector is 3 dB lower than the applicable limit, the peak emission level will be reported. Otherwise, the emission measurement will be repeated using the quasi-peak detector and reported.

Above 1G

The setting of the spectrum analyser

RBW	1 MHz
VBW	PEAK: 3 MHz AVG: see note 6
Sweep	Auto
Detector	Peak
Trace	Max hold

1. The testing follows the guidelines in ANSI C63.10-2013 clause 6.6.
2. The EUT was arranged to its worst case and then tune the antenna tower (from 1 m to 4 m) and turntable (from 0 degree to 360 degrees) to find the maximum reading. A pre-amp and a high pass filter are used for the test in order to get better signal level. Both horizontal and vertical polarizations of the antenna are set to make the measurement.
3. The EUT was placed on a turntable with 1.5 m above ground.
4. The EUT was set 3 meters from the interference receiving antenna, which was mounted on the top of a variable height antenna tower.
5. For measurement above 1 GHz, the emission measurement will be measured by the peak detector. This peak level, once corrected, must comply with the limit specified in Section 15.209.
6. For measurements above 1 GHz the resolution bandwidth is set to 1 MHz, then the video bandwidth is set to 3 MHz for peak measurements and 1 MHz resolution bandwidth with 1/T video bandwidth with peak detector for average measurements. For the Duty Cycle please refer to clause 7.5.ON TIME AND DUTY CYCLE.

X axis, Y axis, Z axis positions:

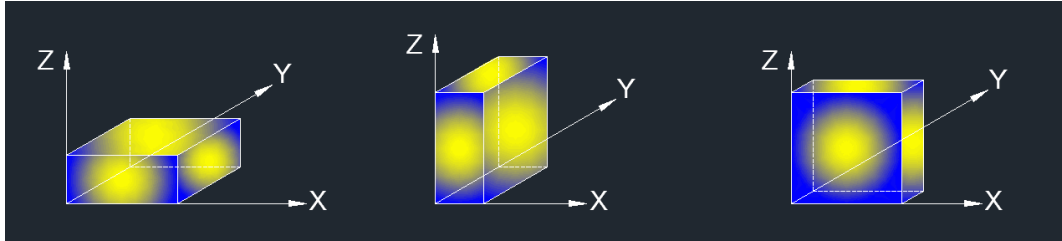

Note 1: For all radiated test, EUT in each of three orthogonal axis emissions had been tested, but only the worst case (X axis) data recorded in the report.

For Band edge note:

1. Measurement = Reading Level + Correct Factor.
2. If Peak Result complies with AV limit, AV Result is deemed to comply with AV limit.
3. Peak: Peak detector.
4. AVG:  $VBW=1/Ton$ , where: Ton is the transmitting duration.
5. For the transmitting duration, please refer to clause 7.5.
6. Only the worst data was recorded, if it complies with the limit, the other emissions deemed to comply with the limit.
7. Horizontal and Vertical have been tested, only the worst data was recorded in the report.
8. All modes and channels have been tested, only the worst data was recorded in the report.

For Radiate Spurious emission 1GHz-3GHz note:

- Note:
1. Measurement = Reading Level + Correct Factor.
  2. If Peak Result complies with AV limit, AV Result is deemed to comply with AV limit.
  3. Peak: Peak detector.
  4. AVG:  $VBW=1/Ton$ , where: Ton is the transmitting duration.
  5. For the transmitting duration, please refer to clause 7.5.
  6. Filter losses were only considered in the spurious frequency bands and the authorized band was not corrected for Band reject filter losses.
  7. Proper operation of the transmitter prior to adding the filter to the measurement chain.
  8. All modes and channels have been tested, only the worst data was recorded in the report.

For Radiate Spurious emission 3GHz-18GHz note:

- Note:
1. Peak Result = Reading Level + Correct Factor.
  2. If Peak Result complies with AV limit, AV Result is deemed to comply with AV limit.
  3. Peak: Peak detector.
  4. AVG:  $VBW=1/Ton$ , where: Ton is the transmitting duration.
  5. For the transmitting duration, please refer to clause 7.5.
  6. Filter losses were only considered in the spurious frequency bands and the authorized band was not corrected for High Pass Filter losses.
  7. Proper operation of the transmitter prior to adding the filter to the measurement chain.
  8. All modes and channels have been tested, only the worst data was recorded in the report.



For Radiate Spurious emission 9kHz-30MHz note:

1. Measurement = Reading Level + Correct Factor.
2. If Peak Result complies with AV and QP limit, AV and QP Result are deemed to comply with AV limit.
3. All 3 polarizations (Horizontal, Face-on and Face-off) of the loop antenna had been tested, but only the worst data recorded in the report.
4. All modes and channels have been tested, only the worst data was recorded in the report.



For Radiate Spurious emission 18GHz-26GHz note:

1. Measurement = Reading Level + Correct Factor.
2. If Peak Result complies with AV limit, AV Result is deemed to comply with AV limit.
3. Peak: Peak detector.
4. All modes and channels have been tested, only the worst data was recorded in the report.

For Radiate Spurious emission 30MHz-1GHz note:

1. Result Level = Read Level + Correct Factor.
2. If Peak Result complies with QP limit, QP Result is deemed to comply with QP limit.
3. Test setup: RBW: 120 kHz, VBW: 300 kHz, Sweep time: auto.
4. All modes and channels have been tested, only the worst data was recorded in the report.

**TEST SETUP**

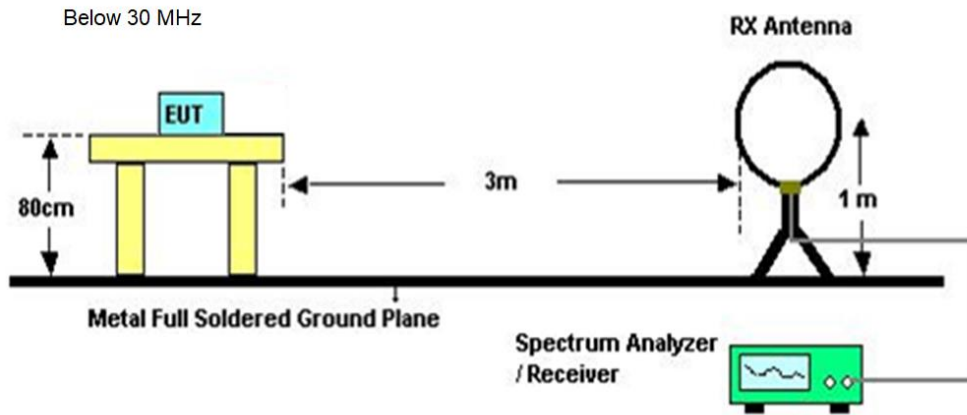

Below 1 GHz and above 30 MHz

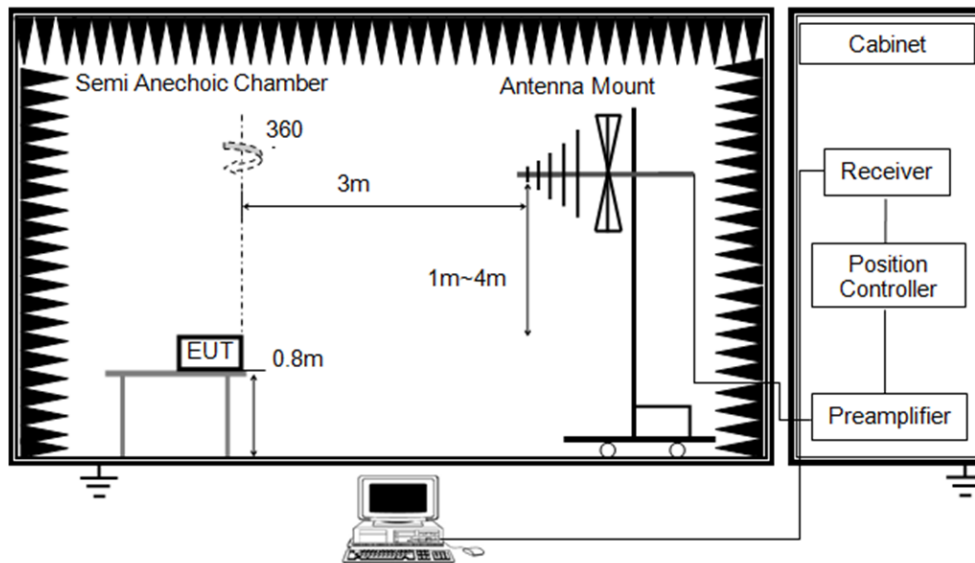

Above 1 GHz

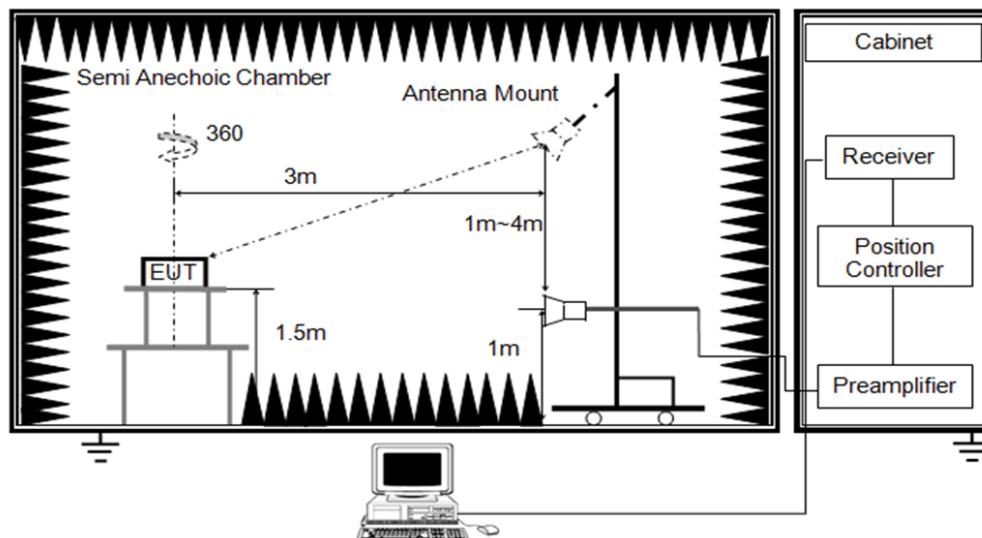



**TEST ENVIRONMENT**

Temperature	25.1°C	Relative Humidity	59%
Atmosphere Pressure	101kPa	Test Voltage	AC 120 V, 60 Hz

**TEST DATE / ENGINEER**

Test Date	December 14, 2022	Test By	Rex Huang
-----------	-------------------	---------	-----------

**TEST RESULTS**





### 8.1. RESTRICTED BANDEDGE

Test Mode:	802.11b PK	Channel:	2412
Polarity:	Horizontal	Test Voltage:	AC 120V_60Hz

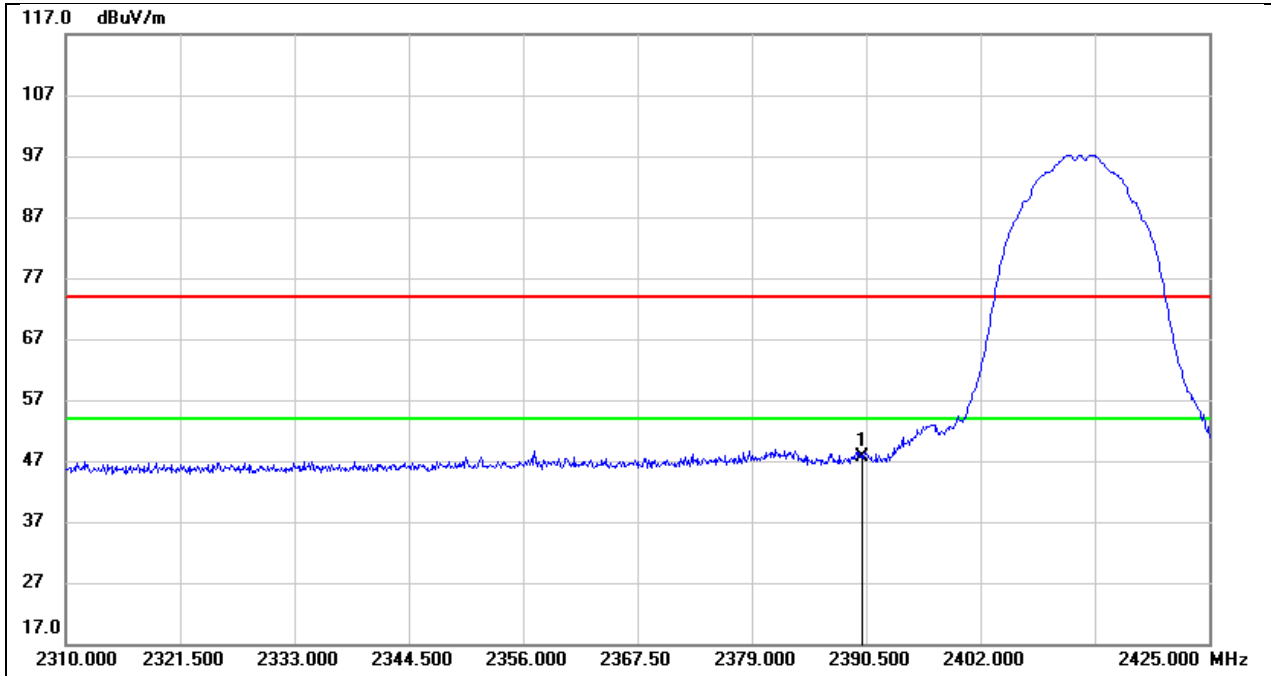

No.	Frequency (MHz)	Reading (dBuV)	Correct (dB/m)	Result (dBuV/m)	Limit (dBuV/m)	Margin (dB)	Remark
1	2390.000	15.58	32.16	47.74	74.00	-26.26	peak



Test Mode:	802.11b PK	Channel:	2412
Polarity:	Vertical	Test Voltage:	AC 120V_60Hz

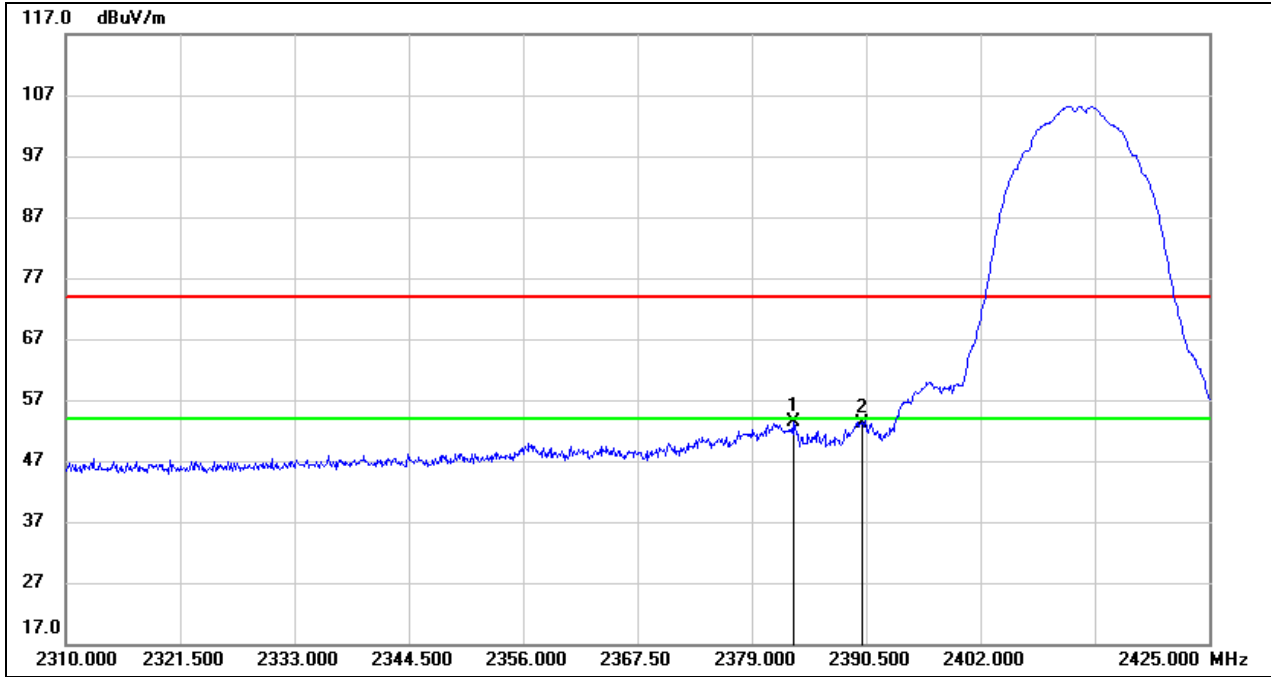

No.	Frequency (MHz)	Reading (dBuV)	Correct (dB/m)	Result (dBuV/m)	Limit (dBuV/m)	Margin (dB)	Remark
1	2383.140	21.14	32.14	53.28	74.00	-20.72	peak
2	2390.000	20.99	32.16	53.15	74.00	-20.85	peak



Test Mode:	802.11b AV	Channel:	2412
Polarity:	Vertical	Test Voltage:	AC 120V_60Hz

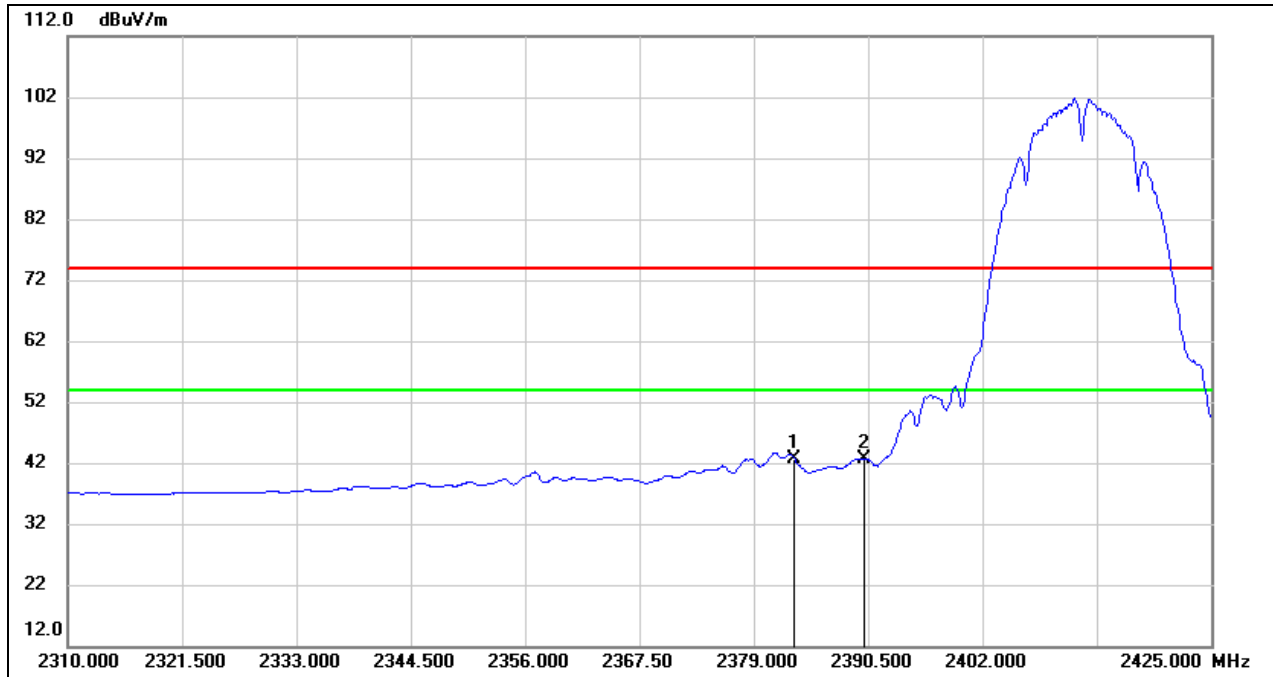

No.	Frequency (MHz)	Reading (dBuV)	Correct (dB/m)	Result (dBuV/m)	Limit (dBuV/m)	Margin (dB)	Remark
1	2383.140	10.46	32.14	42.60	54.00	-11.40	AVG
2	2390.000	10.49	32.16	42.65	54.00	-11.35	AVG



Test Mode:	802.11b PK	Channel:	2462
Polarity:	Vertical	Test Voltage:	AC 120V_60Hz

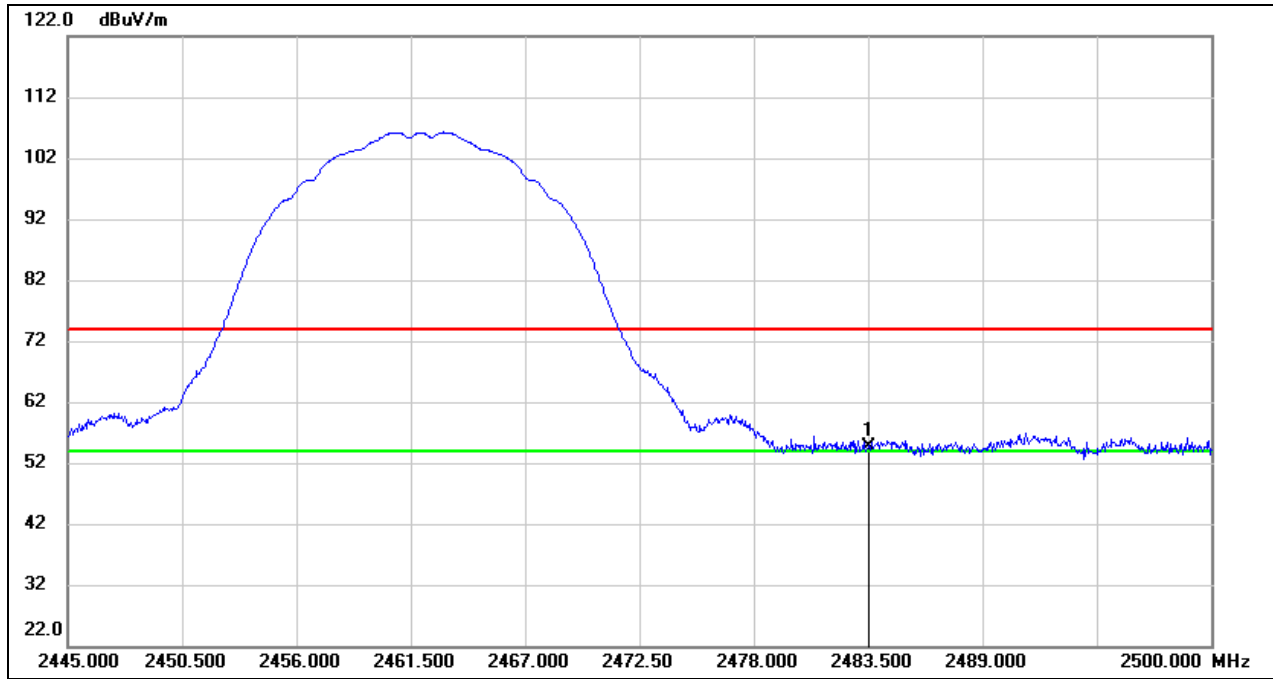

No.	Frequency (MHz)	Reading (dBuV)	Correct (dB/m)	Result (dBuV/m)	Limit (dBuV/m)	Margin (dB)	Remark
1	2483.500	22.13	32.44	54.57	74.00	-19.43	peak



Test Mode:	802.11b AV	Channel:	2462
Polarity:	Vertical	Test Voltage:	AC 120V_60Hz

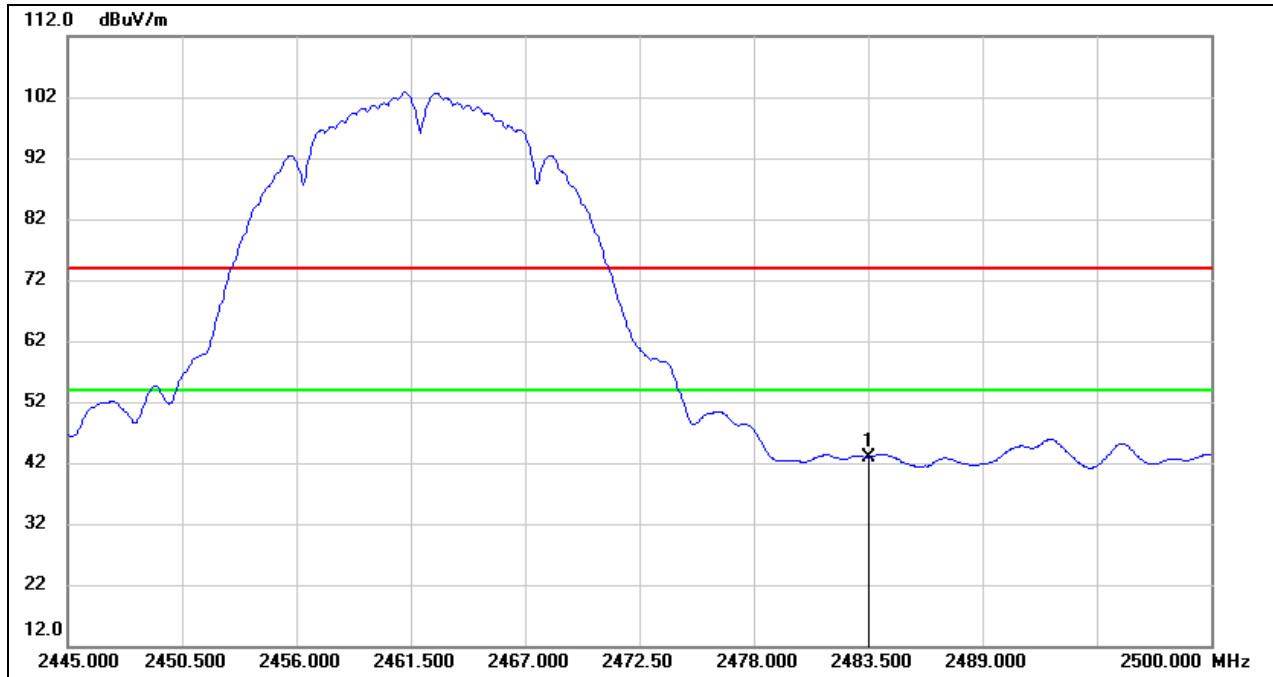

No.	Frequency (MHz)	Reading (dBuV)	Correct (dB/m)	Result (dBuV/m)	Limit (dBuV/m)	Margin (dB)	Remark
1	2483.500	10.39	32.44	42.83	54.00	-11.17	AVG



Test Mode:	802.11g PK	Channel:	2412
Polarity:	Vertical	Test Voltage:	AC 120V_60Hz

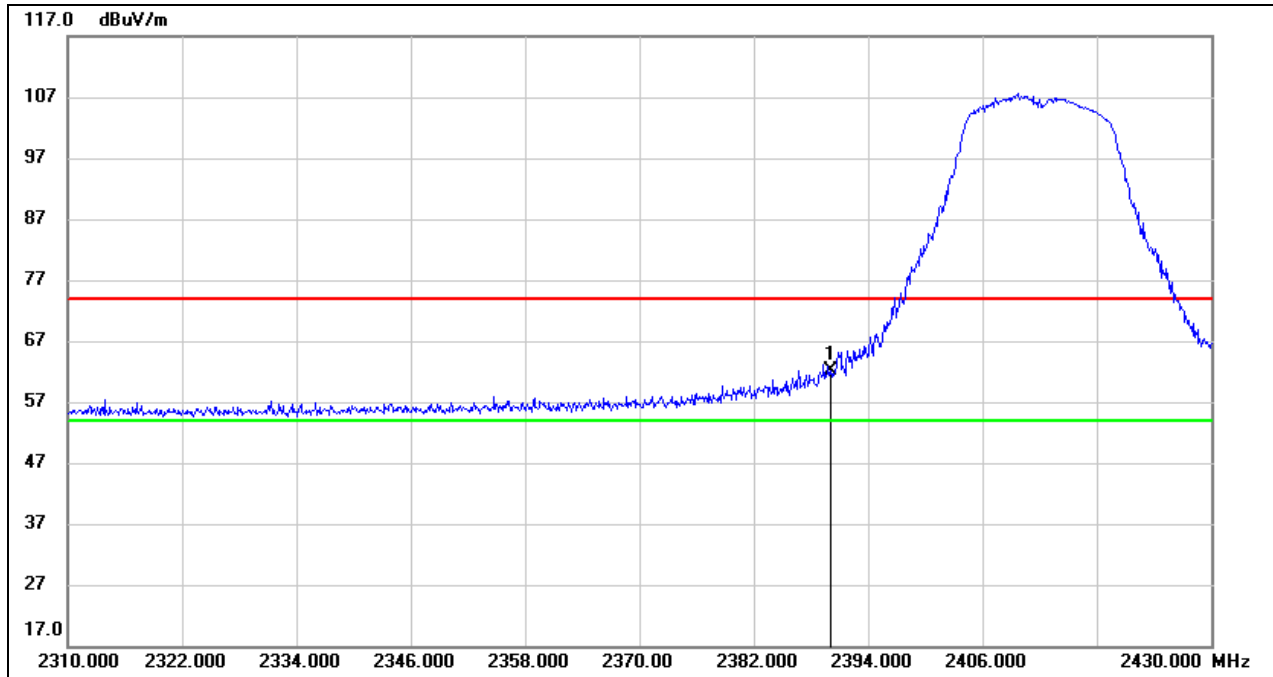

No.	Frequency (MHz)	Reading (dBuV)	Correct (dB/m)	Result (dBuV/m)	Limit (dBuV/m)	Margin (dB)	Remark
1	2390.000	29.93	32.16	62.09	74.00	-11.91	peak



Test Mode:	802.11g AV	Channel:	2412
Polarity:	Vertical	Test Voltage:	AC 120V_60Hz

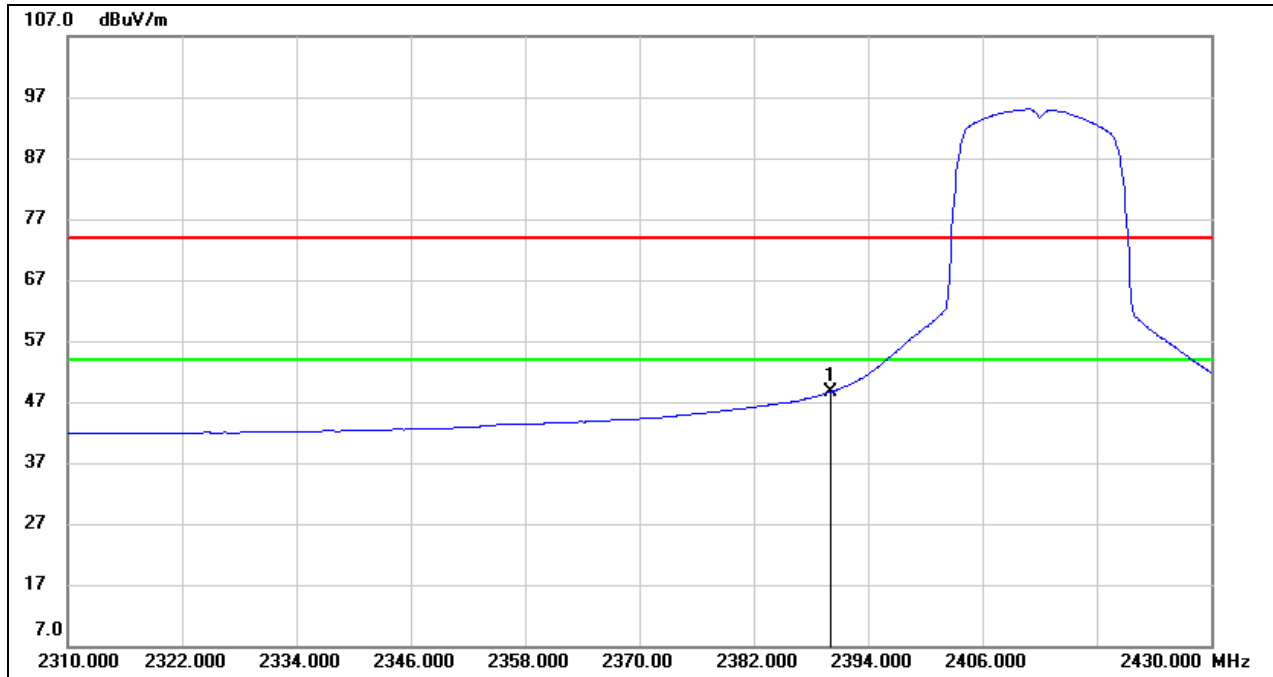

No.	Frequency (MHz)	Reading (dBuV)	Correct (dB/m)	Result (dBuV/m)	Limit (dBuV/m)	Margin (dB)	Remark
1	2390.000	16.52	32.16	48.68	54.00	-5.32	AVG



Test Mode:	802.11g PK	Channel:	2462
Polarity:	Vertical	Test Voltage:	AC 120V_60Hz

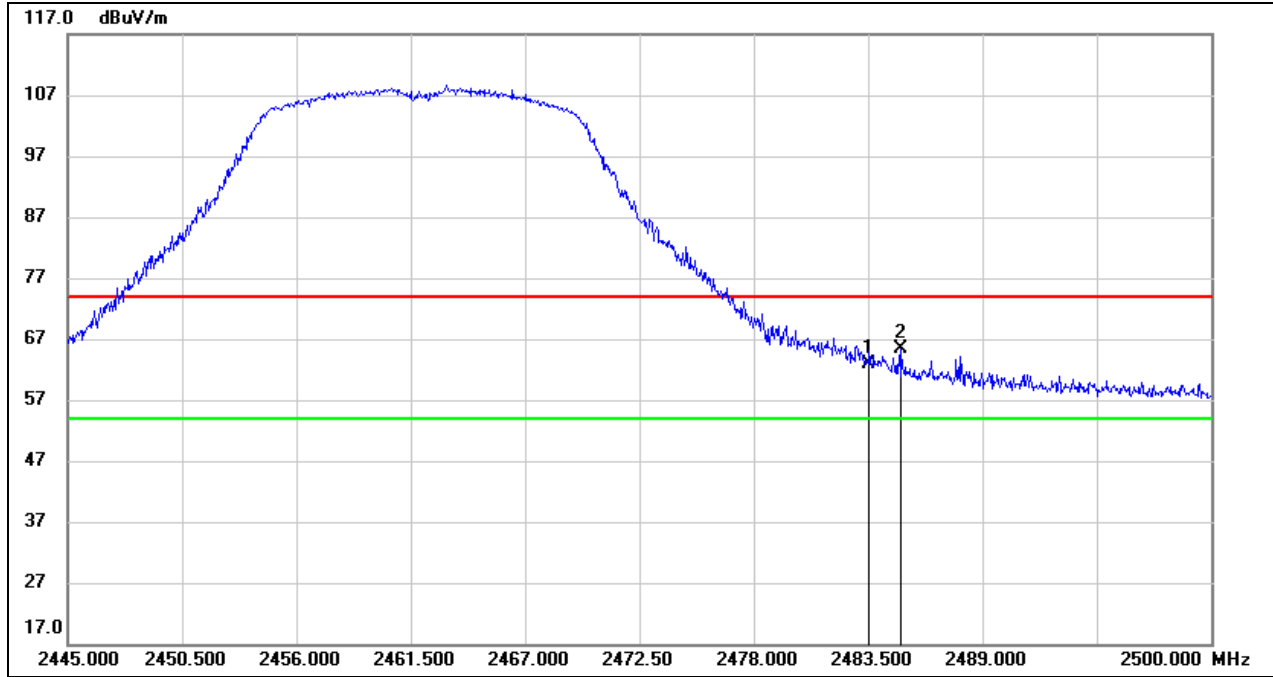

No.	Frequency (MHz)	Reading (dBuV)	Correct (dB/m)	Result (dBuV/m)	Limit (dBuV/m)	Margin (dB)	Remark
1	2483.500	30.52	32.44	62.96	74.00	-11.04	peak
2	2485.095	32.94	32.44	65.38	74.00	-8.62	peak





Test Mode:	802.11g AV	Channel:	2462
Polarity:	Vertical	Test Voltage:	AC 120V_60Hz

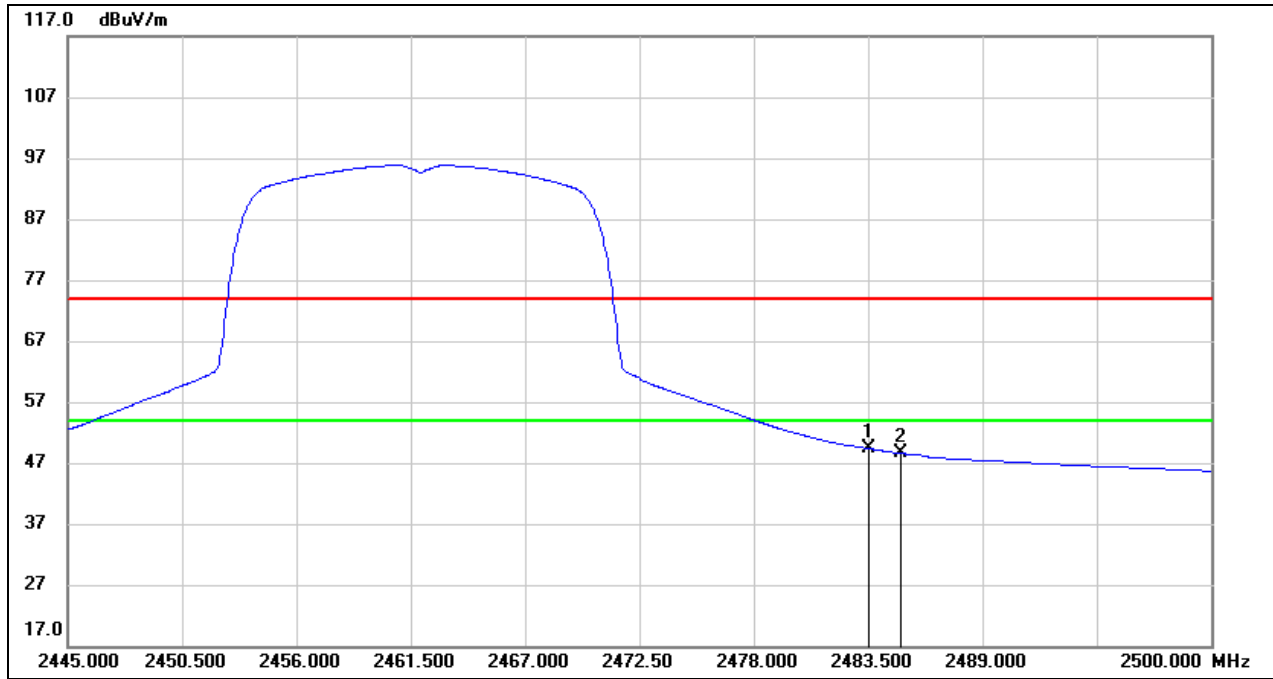

No.	Frequency (MHz)	Reading (dBuV)	Correct (dB/m)	Result (dBuV/m)	Limit (dBuV/m)	Margin (dB)	Remark
1	2483.500	16.97	32.44	49.41	54.00	-4.59	AVG
2	2485.095	16.15	32.44	48.59	54.00	-5.41	AVG



Test Mode:	802.11n HT20 PK	Channel:	2412
Polarity:	Vertical	Test Voltage:	AC 120V_60Hz

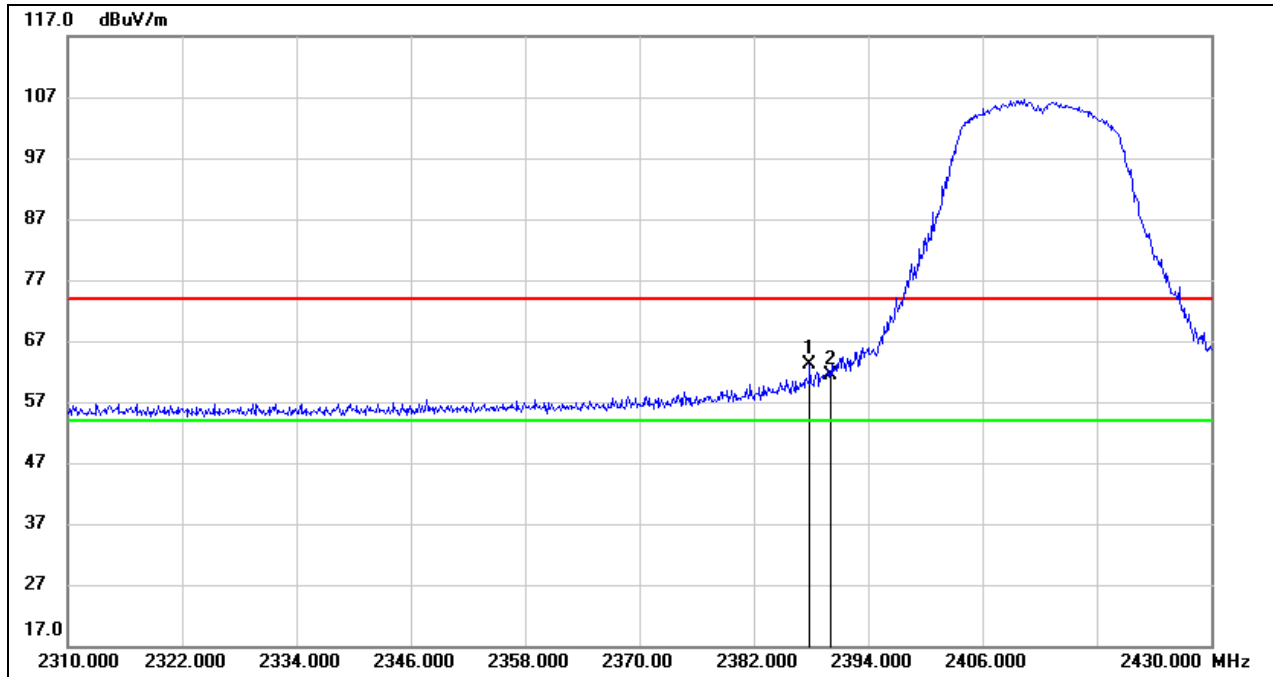

No.	Frequency (MHz)	Reading (dBuV)	Correct (dB/m)	Result (dBuV/m)	Limit (dBuV/m)	Margin (dB)	Remark
1	2387.880	30.88	32.16	63.04	74.00	-10.96	peak
2	2390.000	29.31	32.16	61.47	74.00	-12.53	peak



Test Mode:	802.11n HT20 AV	Channel:	2412
Polarity:	Vertical	Test Voltage:	AC 120V_60Hz

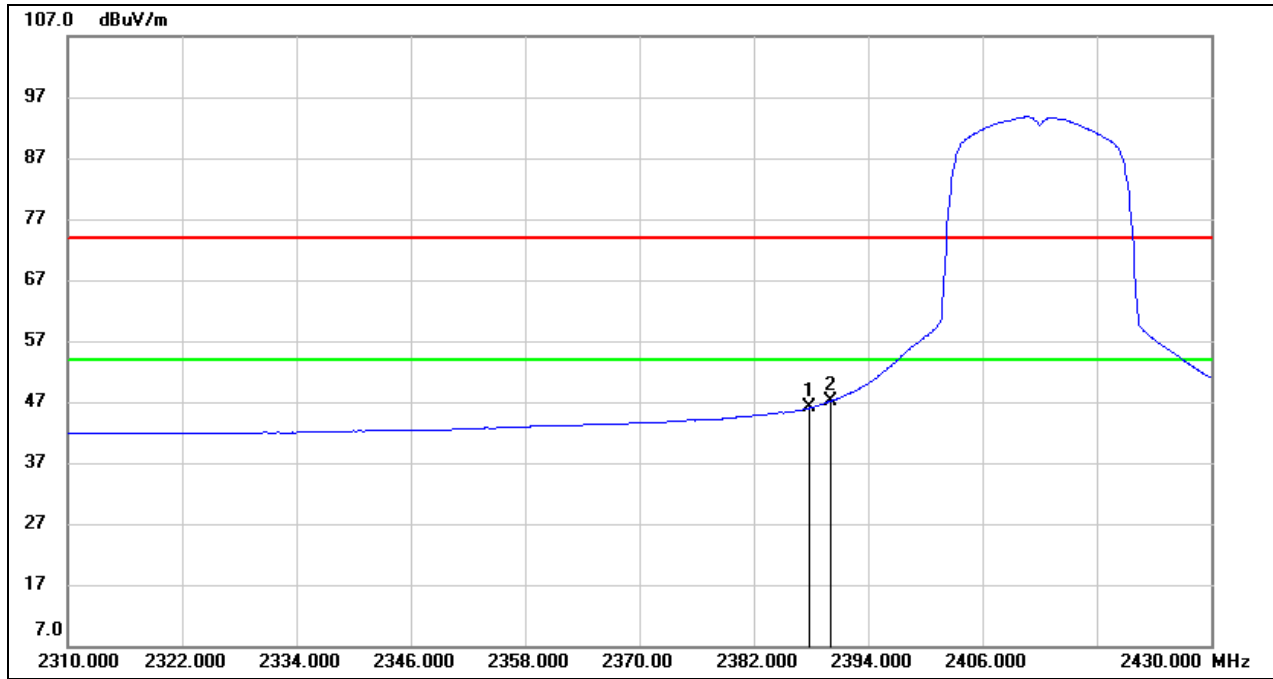

No.	Frequency (MHz)	Reading (dBuV)	Correct (dB/m)	Result (dBuV/m)	Limit (dBuV/m)	Margin (dB)	Remark
1	2387.880	13.89	32.16	46.05	54.00	-7.95	AVG
2	2390.000	14.96	32.16	47.12	54.00	-6.88	AVG



Test Mode:	802.11n HT20 PK	Channel:	2462
Polarity:	Vertical	Test Voltage:	AC 120V_60Hz

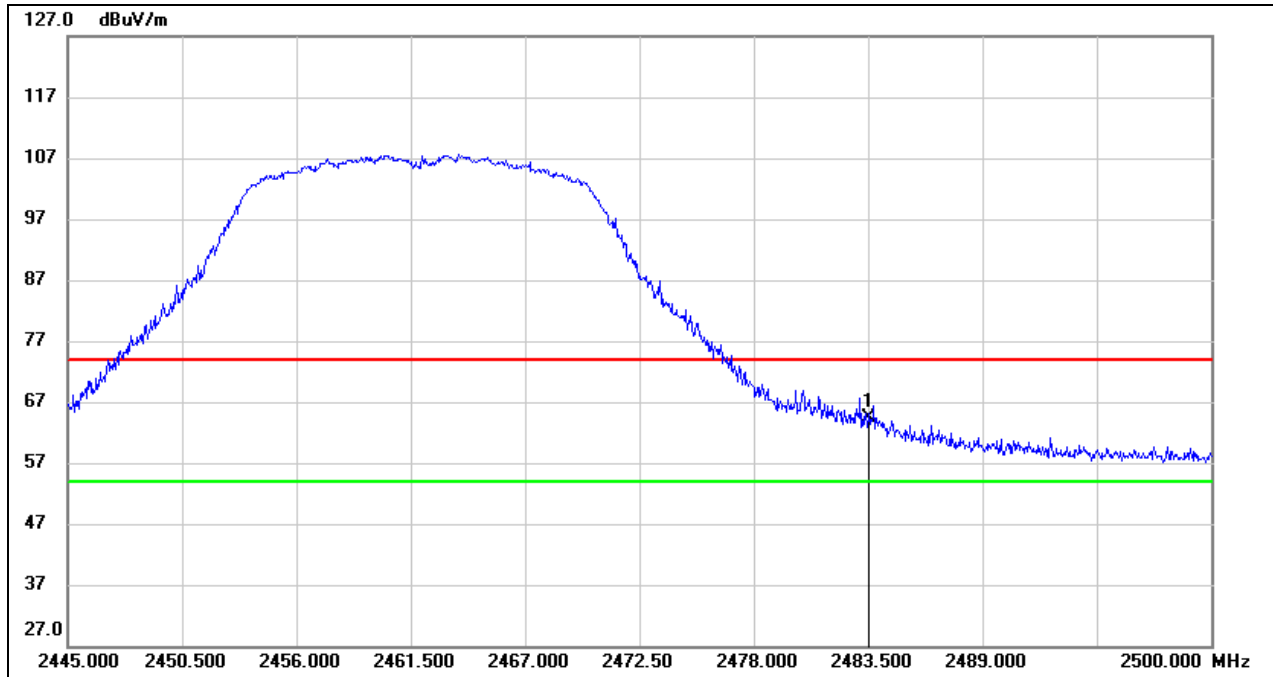

No.	Frequency (MHz)	Reading (dBuV)	Correct (dB/m)	Result (dBuV/m)	Limit (dBuV/m)	Margin (dB)	Remark
1	2483.500	31.89	32.44	64.33	74.00	-9.67	peak



Test Mode:	802.11n HT20 AV	Channel:	2462
Polarity:	Vertical	Test Voltage:	AC 120V_60Hz

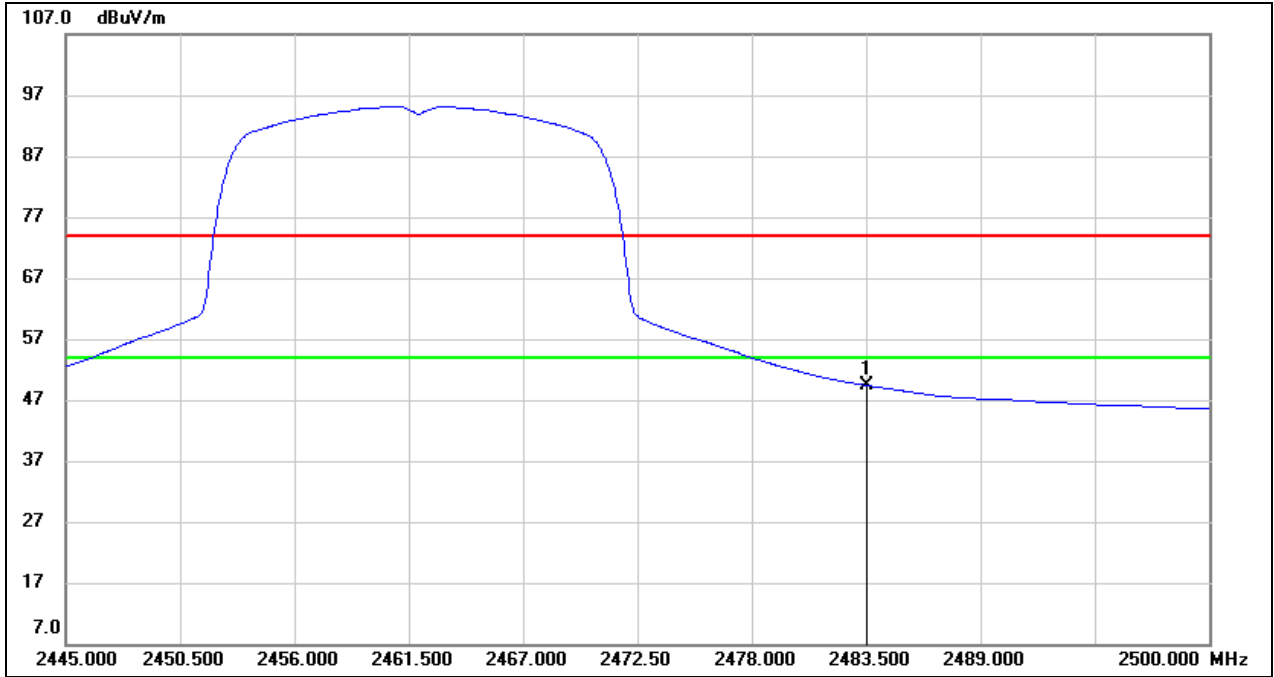

No.	Frequency (MHz)	Reading (dBuV)	Correct (dB/m)	Result (dBuV/m)	Limit (dBuV/m)	Margin (dB)	Remark
1	2483.500	16.96	32.44	49.40	54.00	-4.60	AVG



### 8.2. SPURIOUS EMISSIONS(1 GHZ~3 GHZ)

Test Mode:	802.11b	Channel:	2412
Polarity:	Horizontal	Test Voltage:	AC 120V_60Hz

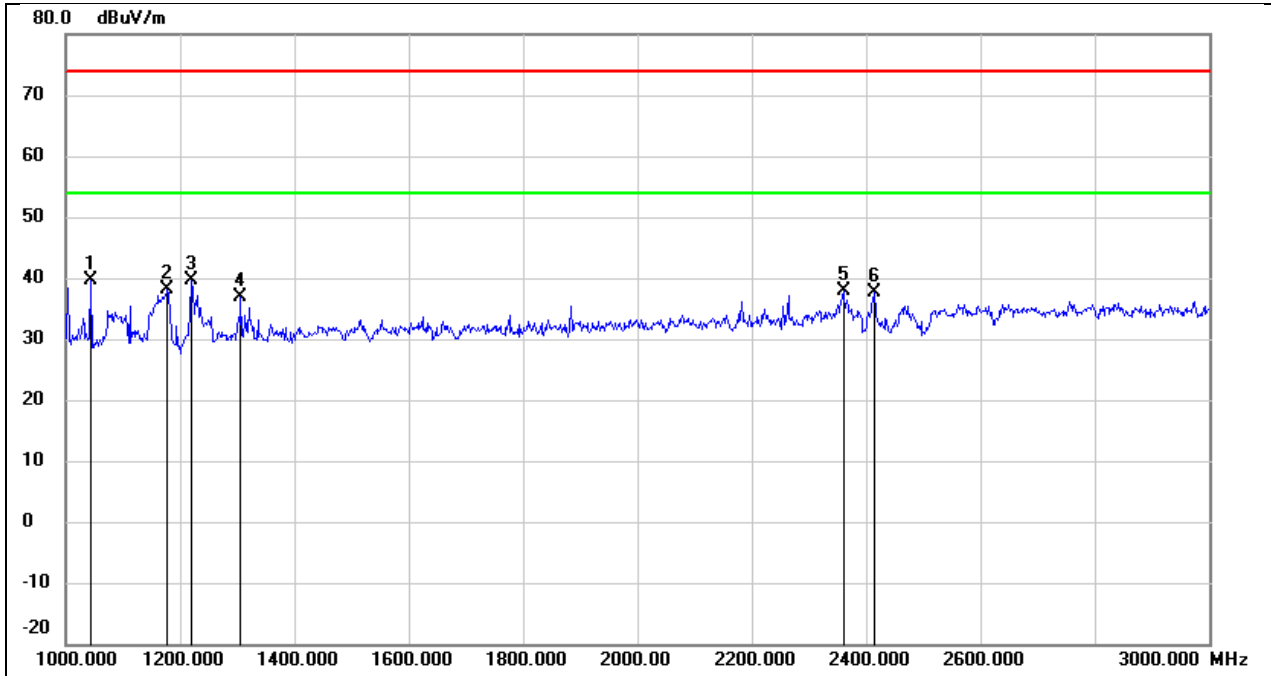

No.	Frequency (MHz)	Reading (dBuV)	Correct (dB/m)	Result (dBuV/m)	Limit (dBuV/m)	Margin (dB)	Remark
1	1044.000	54.39	-14.83	39.56	74.00	-34.44	peak
2	1178.000	52.28	-14.20	38.08	74.00	-35.92	peak
3	1220.000	53.55	-14.01	39.54	74.00	-34.46	peak
4	1306.000	50.37	-13.61	36.76	74.00	-37.24	peak
5	2360.000	47.12	-9.21	37.91	74.00	-36.09	peak
6	2412.000	46.44	-8.93	37.51	/	/	Fundamental



Test Mode:	802.11b	Channel:	2412
Polarity:	Vertical	Test Voltage:	AC 120V_60Hz

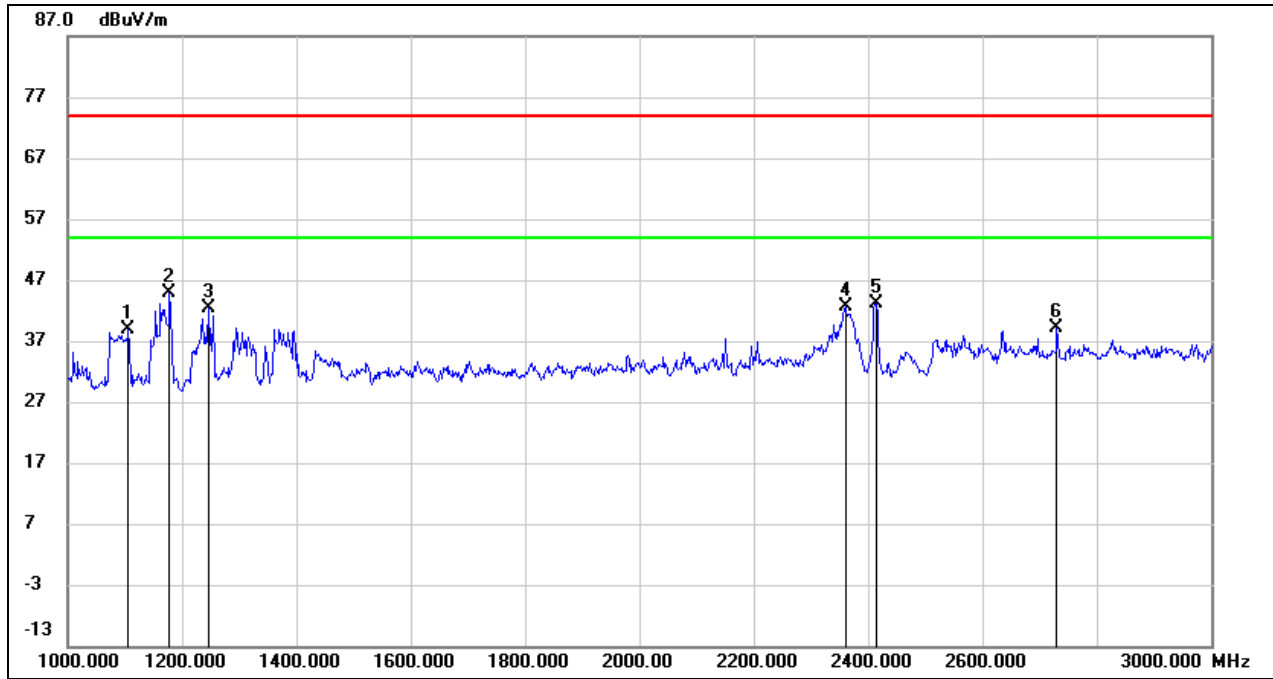

No.	Frequency (MHz)	Reading (dBuV)	Correct (dB/m)	Result (dBuV/m)	Limit (dBuV/m)	Margin (dB)	Remark
1	1106.000	53.51	-14.54	38.97	74.00	-35.03	peak
2	1178.000	59.16	-14.20	44.96	74.00	-29.04	peak
3	1246.000	56.23	-13.88	42.35	74.00	-31.65	peak
4	2360.000	51.78	-9.21	42.57	74.00	-31.43	peak
5	2412.000	52.16	-8.93	43.23	/	/	Fundamental
6	2730.000	46.96	-7.80	39.16	74.00	-34.84	peak



Test Mode:	802.11b	Channel:	2437
Polarity:	Horizontal	Test Voltage:	AC 120V_60Hz

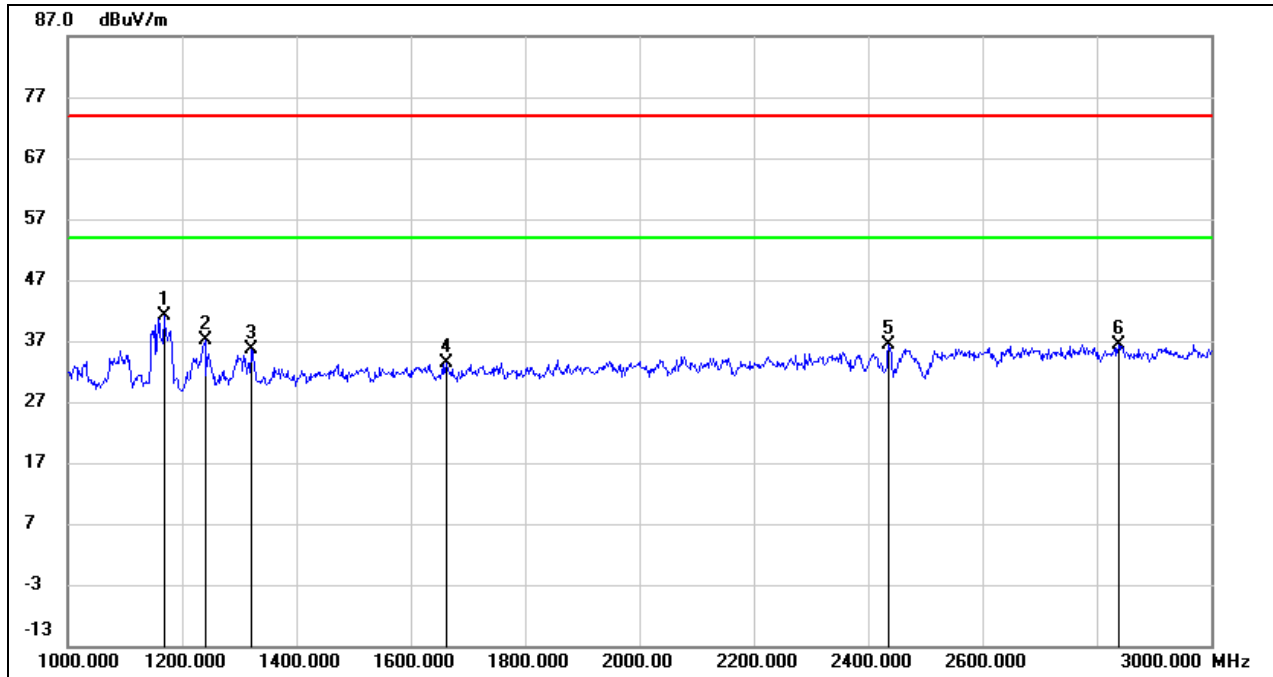

No.	Frequency (MHz)	Reading (dBuV)	Correct (dB/m)	Result (dBuV/m)	Limit (dBuV/m)	Margin (dB)	Remark
1	1168.000	55.30	-14.25	41.05	74.00	-32.95	peak
2	1240.000	51.11	-13.91	37.20	74.00	-36.80	peak
3	1322.000	49.24	-13.54	35.70	74.00	-38.30	peak
4	1662.000	45.60	-12.17	33.43	74.00	-40.57	peak
5	2437.000	45.13	-8.82	36.31	/	/	Fundamental
6	2838.000	43.77	-7.46	36.31	74.00	-37.69	peak





Test Mode:	802.11b	Channel:	2437
Polarity:	Vertical	Test Voltage:	AC 120V_60Hz

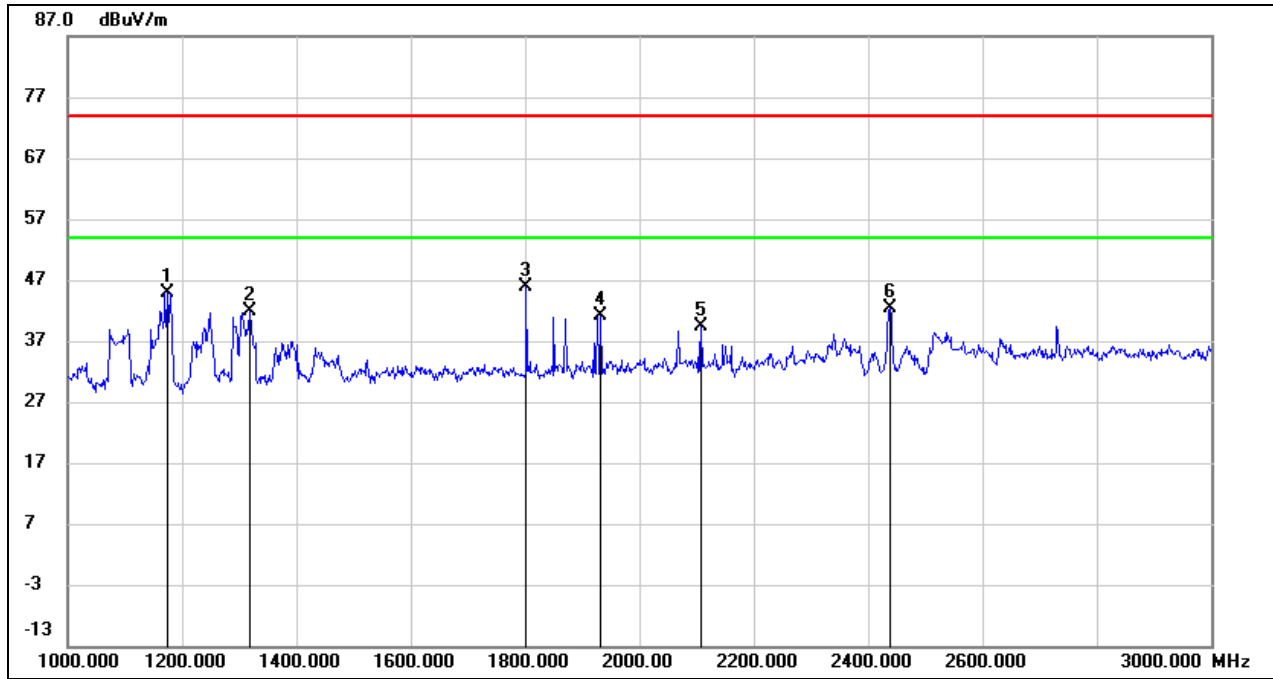

No.	Frequency (MHz)	Reading (dBuV)	Correct (dB/m)	Result (dBuV/m)	Limit (dBuV/m)	Margin (dB)	Remark
1	1174.000	59.18	-14.22	44.96	74.00	-29.04	peak
2	1318.000	55.35	-13.56	41.79	74.00	-32.21	peak
3	1802.000	57.69	-11.72	45.97	74.00	-28.03	peak
4	1932.000	52.34	-11.28	41.06	74.00	-32.94	peak
5	2108.000	49.81	-10.50	39.31	74.00	-34.69	peak
6	2437.000	51.18	-8.80	42.38	/	/	Fundamental



Test Mode:	802.11b	Channel:	2462
Polarity:	Horizontal	Test Voltage:	AC 120V_60Hz

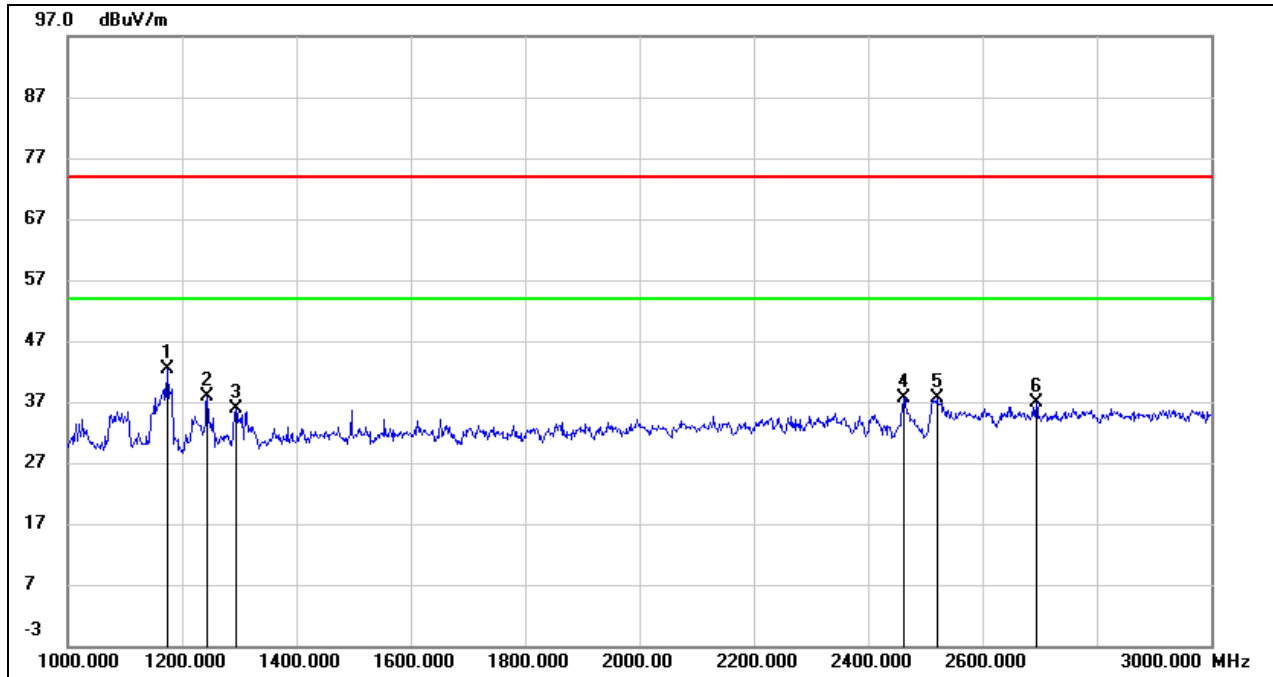

No.	Frequency (MHz)	Reading (dBuV)	Correct (dB/m)	Result (dBuV/m)	Limit (dBuV/m)	Margin (dB)	Remark
1	1174.000	56.49	-14.22	42.27	74.00	-31.73	peak
2	1244.000	51.84	-13.90	37.94	74.00	-36.06	peak
3	1294.000	49.51	-13.67	35.84	74.00	-38.16	peak
4	2462.000	46.38	-8.69	37.69	/	/	Fundamental
5	2520.000	46.10	-8.43	37.67	74.00	-36.33	peak
6	2694.000	44.71	-7.90	36.81	74.00	-37.19	peak



Test Mode:	802.11b	Channel:	2462
Polarity:	Vertical	Test Voltage:	AC 120V_60Hz

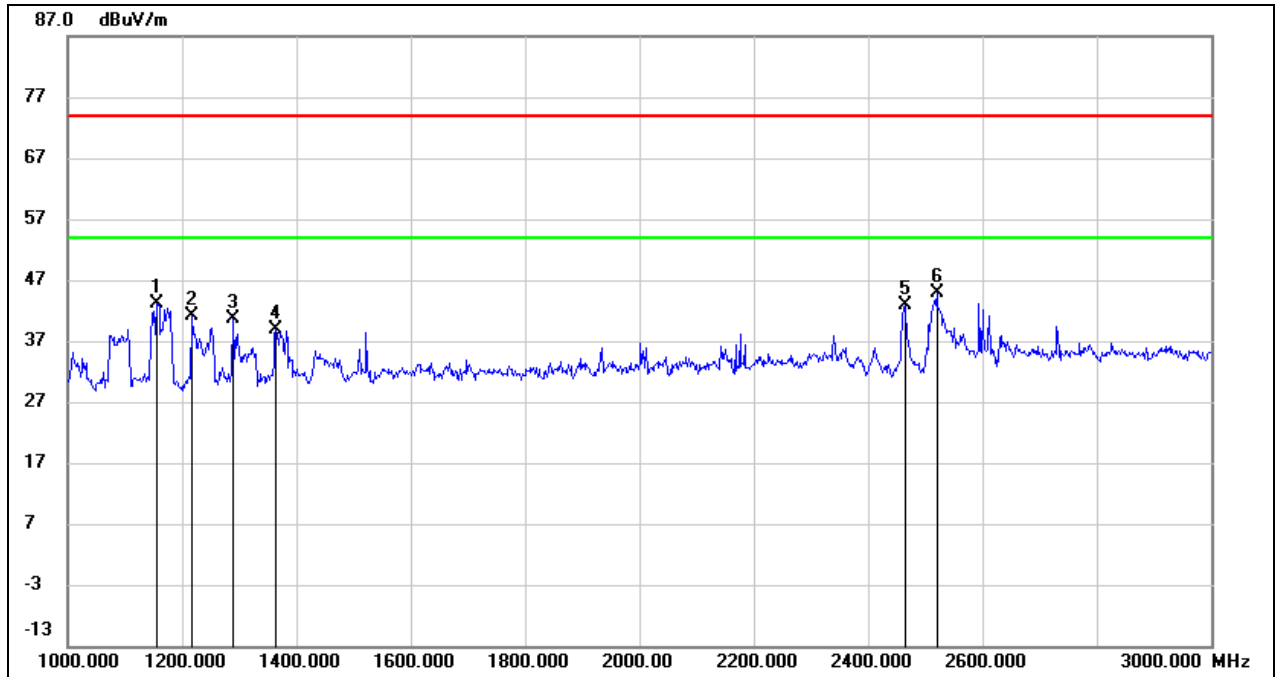

No.	Frequency (MHz)	Reading (dBuV)	Correct (dB/m)	Result (dBuV/m)	Limit (dBuV/m)	Margin (dB)	Remark
1	1156.000	57.43	-14.31	43.12	74.00	-30.88	peak
2	1216.000	55.11	-14.03	41.08	74.00	-32.92	peak
3	1288.000	54.30	-13.69	40.61	74.00	-33.39	peak
4	1364.000	52.15	-13.34	38.81	74.00	-35.19	peak
5	2462.000	51.50	-8.68	42.82	/	/	Fundamental
6	2520.000	53.20	-8.43	44.77	74.00	-29.23	peak



### 8.3. SPURIOUS EMISSIONS(3 GHZ~18 GHZ)

Test Mode:	802.11b	Channel:	2412
Polarity:	Horizontal	Test Voltage:	AC 120V_60Hz

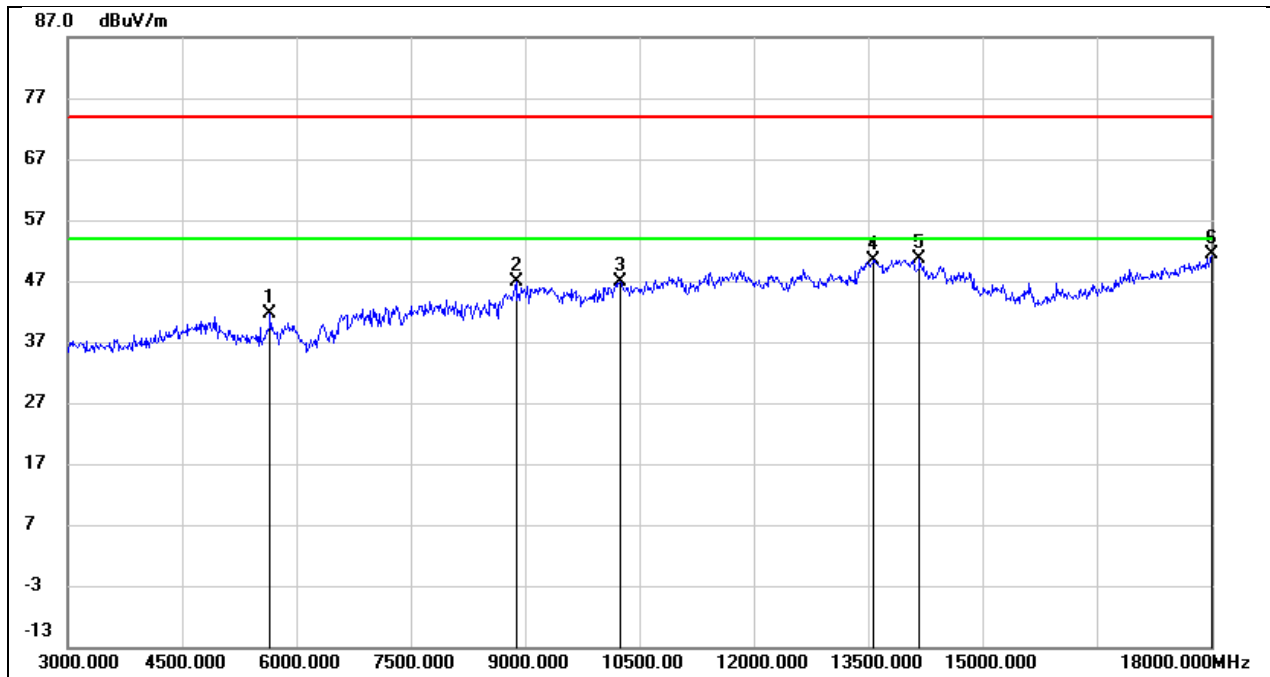

No.	Frequency (MHz)	Reading (dBuV)	Correct (dB/m)	Result (dBuV/m)	Limit (dBuV/m)	Margin (dB)	Remark
1	5655.000	40.38	1.29	41.67	74.00	-32.33	peak
2	8880.000	37.26	9.61	46.87	74.00	-27.13	peak
3	10245.000	34.46	12.48	46.94	74.00	-27.06	peak
4	13575.000	29.27	21.06	50.33	74.00	-23.67	peak
5	14175.000	29.31	21.24	50.55	74.00	-23.45	peak
6	18000.000	25.70	25.69	51.39	74.00	-22.61	peak



Test Mode:	802.11b	Channel:	2412
Polarity:	Vertical	Test Voltage:	AC 120V_60Hz

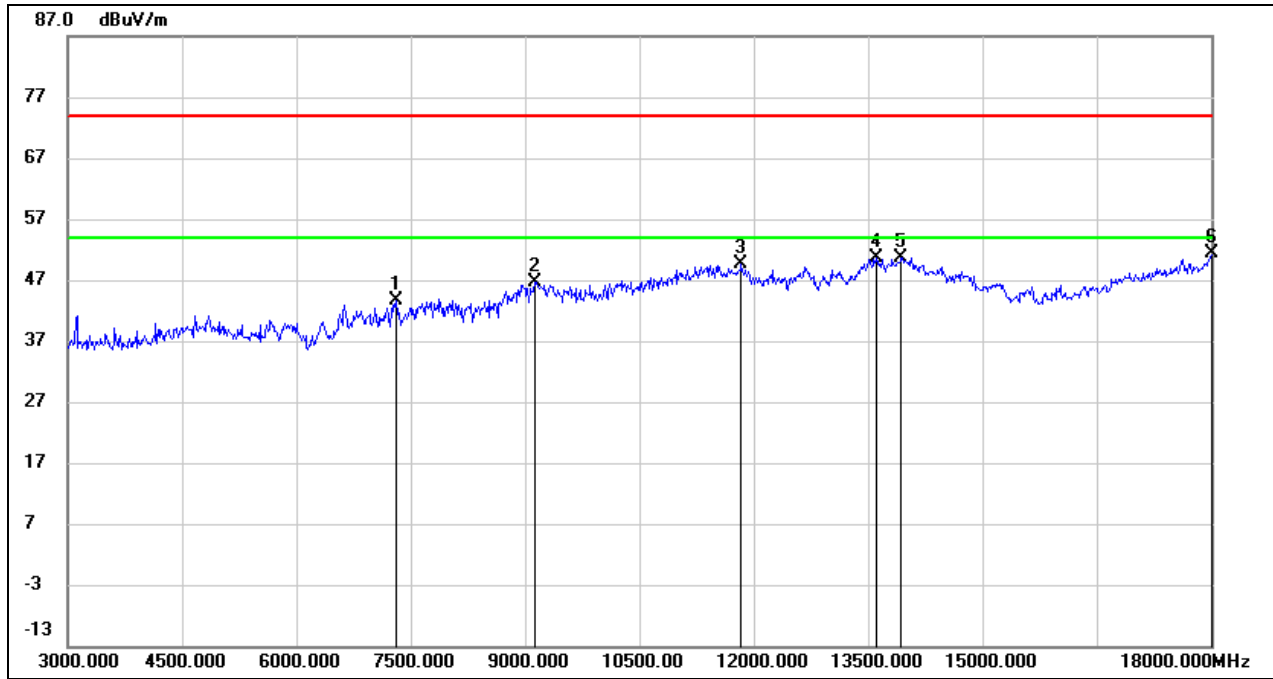

No.	Frequency (MHz)	Reading (dBuV)	Correct (dB/m)	Result (dBuV/m)	Limit (dBuV/m)	Margin (dB)	Remark
1	7305.000	37.16	6.47	43.63	74.00	-30.37	peak
2	9120.000	36.14	10.53	46.67	74.00	-27.33	peak
3	11835.000	32.16	17.51	49.67	74.00	-24.33	peak
4	13605.000	29.57	21.12	50.69	74.00	-23.31	peak
5	13935.000	28.89	21.82	50.71	74.00	-23.29	peak
6	18000.000	25.66	25.69	51.35	74.00	-22.65	peak



Test Mode:	802.11b	Channel:	2437
Polarity:	Horizontal	Test Voltage:	AC 120V_60Hz

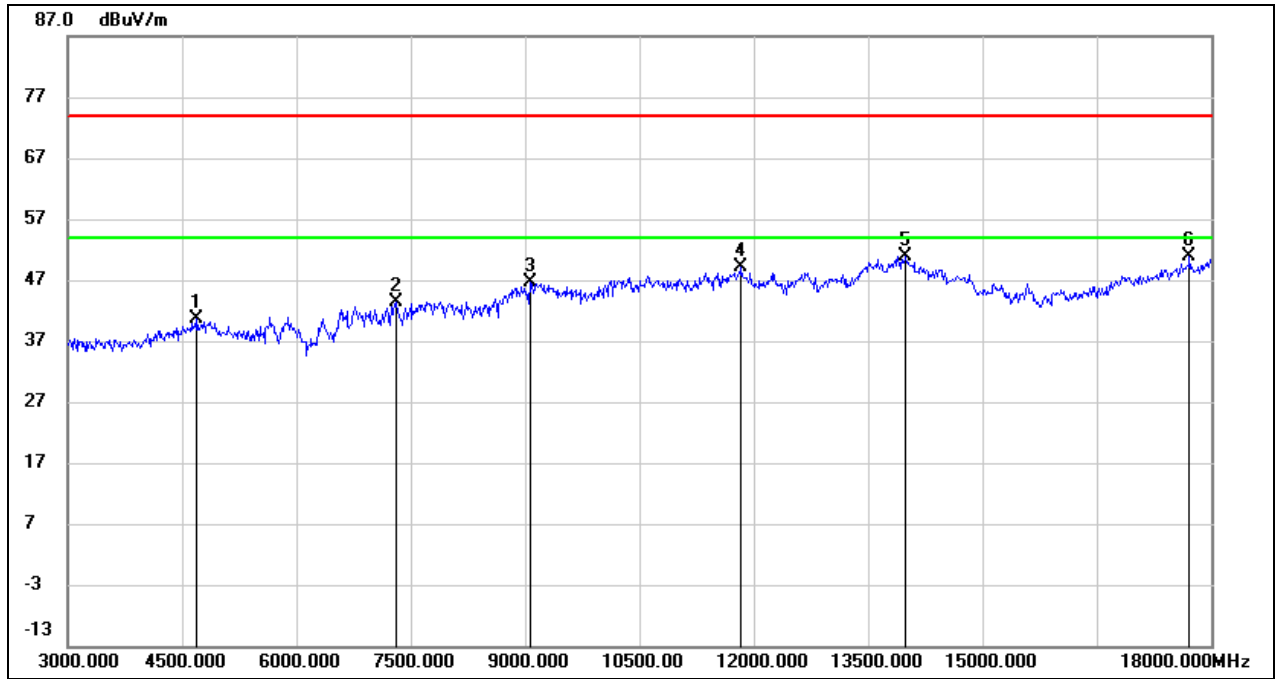

No.	Frequency (MHz)	Reading (dBuV)	Correct (dB/m)	Result (dBuV/m)	Limit (dBuV/m)	Margin (dB)	Remark
1	4695.000	41.24	-0.71	40.53	74.00	-33.47	peak
2	7305.000	36.98	6.47	43.45	74.00	-30.55	peak
3	9060.000	36.10	10.51	46.61	74.00	-27.39	peak
4	11835.000	31.60	17.51	49.11	74.00	-24.89	peak
5	13995.000	28.91	21.95	50.86	74.00	-23.14	peak
6	17715.000	26.80	24.00	50.80	74.00	-23.20	peak



Test Mode:	802.11b	Channel:	2437
Polarity:	Vertical	Test Voltage:	AC 120V_60Hz

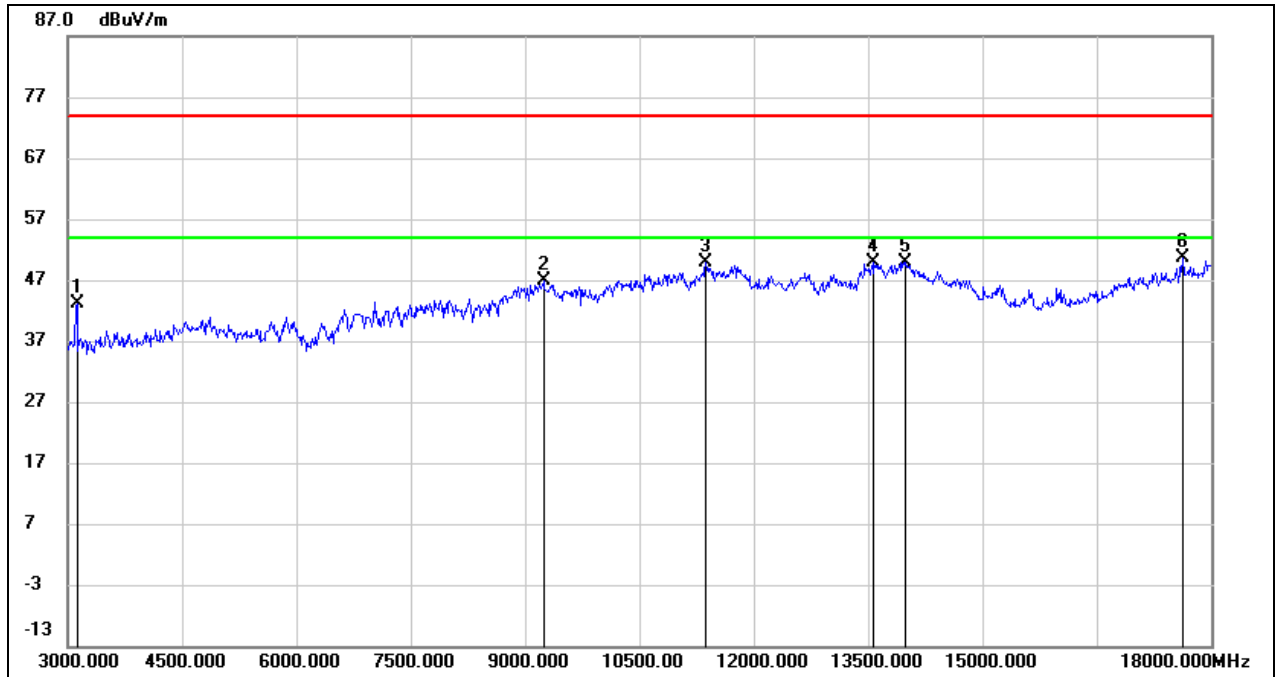

No.	Frequency (MHz)	Reading (dBuV)	Correct (dB/m)	Result (dBuV/m)	Limit (dBuV/m)	Margin (dB)	Remark
1	3120.000	48.21	-5.17	43.04	74.00	-30.96	peak
2	9240.000	36.20	10.58	46.78	74.00	-27.22	peak
3	11370.000	33.69	16.12	49.81	74.00	-24.19	peak
4	13575.000	28.80	21.06	49.86	74.00	-24.14	peak
5	13995.000	27.93	21.95	49.88	74.00	-24.12	peak
6	17625.000	27.05	23.47	50.52	74.00	-23.48	peak



Test Mode:	802.11b	Channel:	2462
Polarity:	Horizontal	Test Voltage:	AC 120V_60Hz

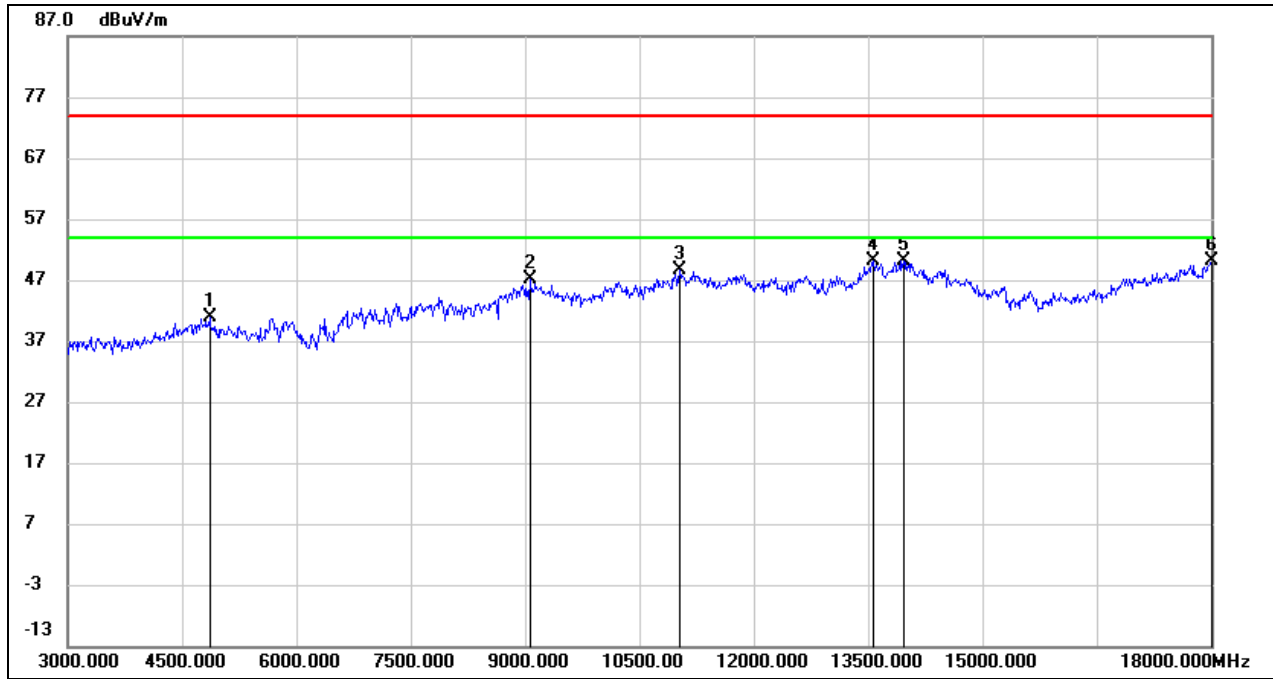

No.	Frequency (MHz)	Reading (dBuV)	Correct (dB/m)	Result (dBuV/m)	Limit (dBuV/m)	Margin (dB)	Remark
1	4860.000	40.94	-0.09	40.85	74.00	-33.15	peak
2	9060.000	36.62	10.51	47.13	74.00	-26.87	peak
3	11025.000	33.73	14.85	48.58	74.00	-25.42	peak
4	13575.000	29.07	21.06	50.13	74.00	-23.87	peak
5	13965.000	28.34	21.89	50.23	74.00	-23.77	peak
6	18000.000	24.41	25.69	50.10	74.00	-23.90	peak





Test Mode:	802.11b	Channel:	2462
Polarity:	Vertical	Test Voltage:	AC 120V_60Hz

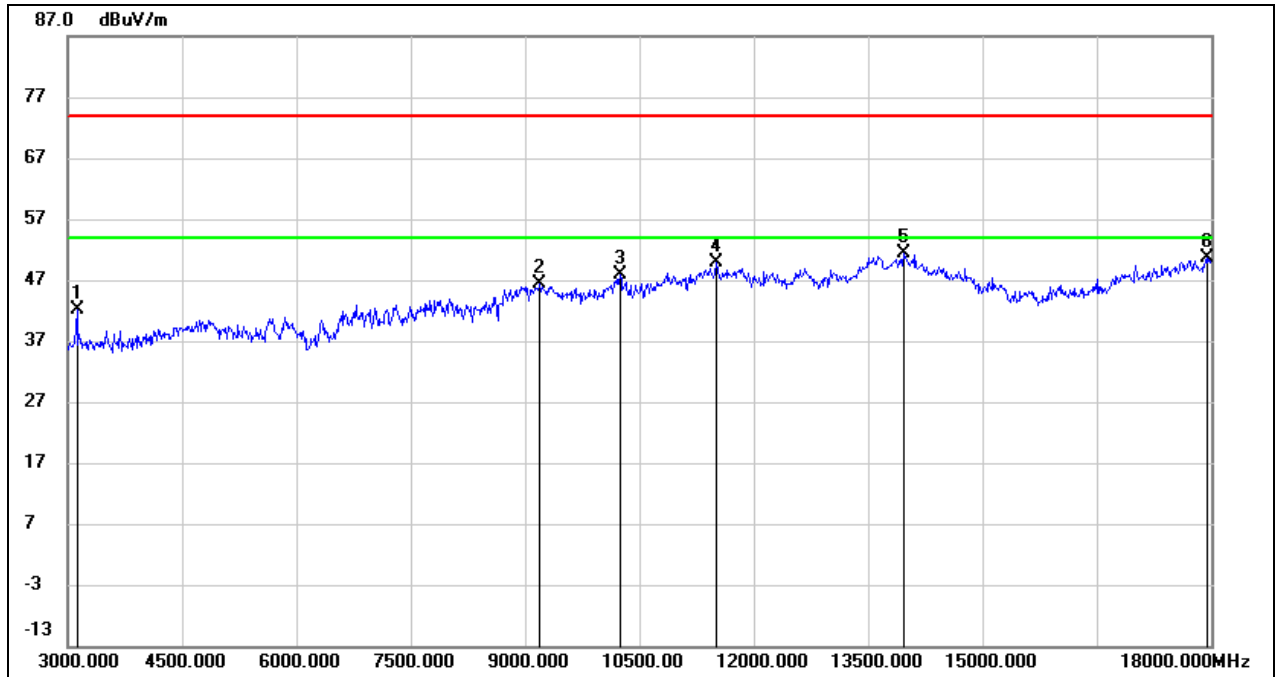

No.	Frequency (MHz)	Reading (dBuV)	Correct (dB/m)	Result (dBuV/m)	Limit (dBuV/m)	Margin (dB)	Remark
1	3120.000	47.32	-5.17	42.15	74.00	-31.85	peak
2	9195.000	35.75	10.56	46.31	74.00	-27.69	peak
3	10245.000	35.31	12.48	47.79	74.00	-26.21	peak
4	11505.000	33.18	16.61	49.79	74.00	-24.21	peak
5	13965.000	29.37	21.89	51.26	74.00	-22.74	peak
6	17940.000	25.23	25.34	50.57	74.00	-23.43	peak



Test Mode:	802.11g	Channel:	2412
Polarity:	Horizontal	Test Voltage:	AC 120V_60Hz

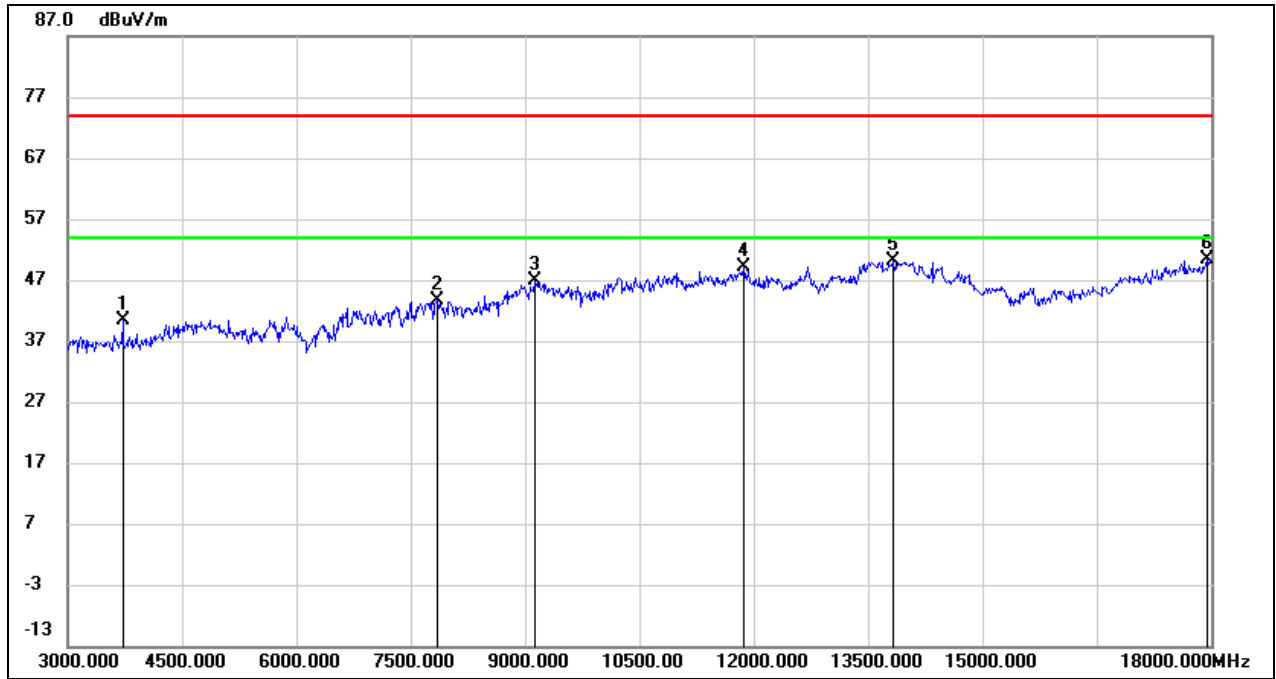

No.	Frequency (MHz)	Reading (dBuV)	Correct (dB/m)	Result (dBuV/m)	Limit (dBuV/m)	Margin (dB)	Remark
1	3720.000	44.86	-4.45	40.41	74.00	-33.59	peak
2	7845.000	37.38	6.32	43.70	74.00	-30.30	peak
3	9135.000	36.22	10.55	46.77	74.00	-27.23	peak
4	11865.000	31.65	17.59	49.24	74.00	-24.76	peak
5	13830.000	28.56	21.60	50.16	74.00	-23.84	peak
6	17940.000	25.12	25.34	50.46	74.00	-23.54	peak



Test Mode:	802.11g	Channel:	2412
Polarity:	Vertical	Test Voltage:	AC 120V_60Hz

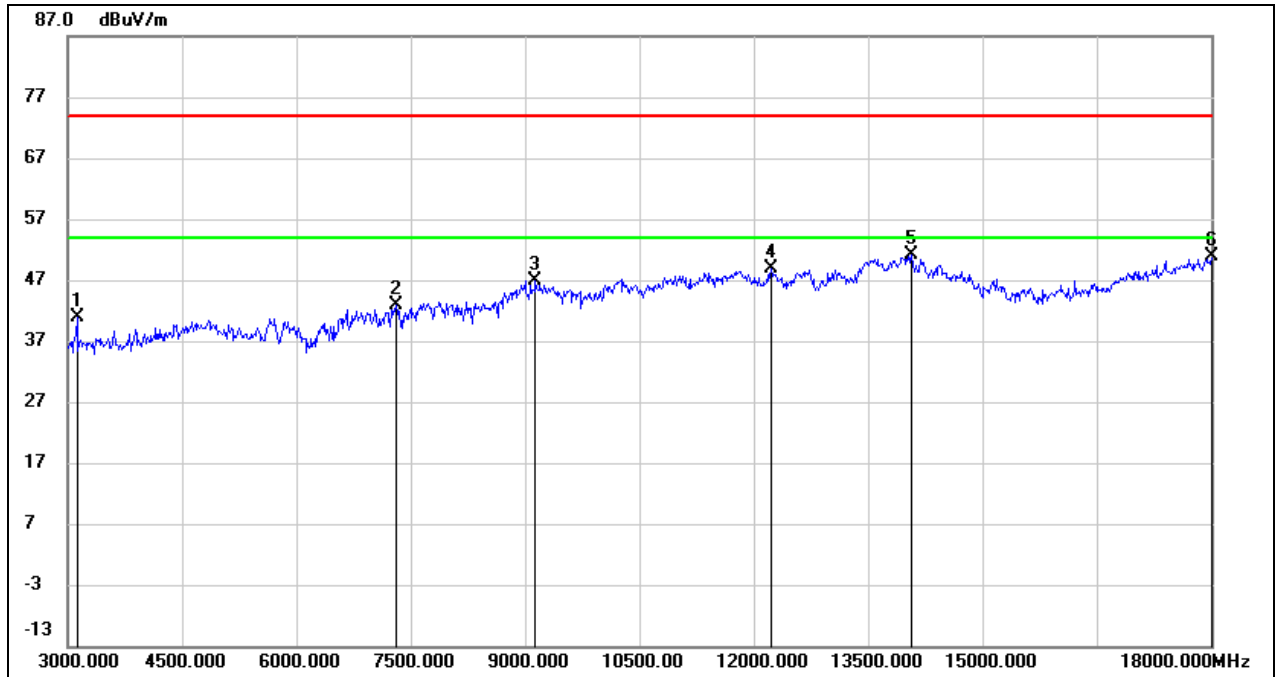

No.	Frequency (MHz)	Reading (dBuV)	Correct (dB/m)	Result (dBuV/m)	Limit (dBuV/m)	Margin (dB)	Remark
1	3120.000	46.10	-5.17	40.93	74.00	-33.07	peak
2	7305.000	36.29	6.47	42.76	74.00	-31.24	peak
3	9135.000	36.26	10.55	46.81	74.00	-27.19	peak
4	12225.000	31.15	17.79	48.94	74.00	-25.06	peak
5	14070.000	29.48	21.67	51.15	74.00	-22.85	peak
6	18000.000	25.25	25.69	50.94	74.00	-23.06	peak



Test Mode:	802.11g	Channel:	2437
Polarity:	Horizontal	Test Voltage:	AC 120V_60Hz

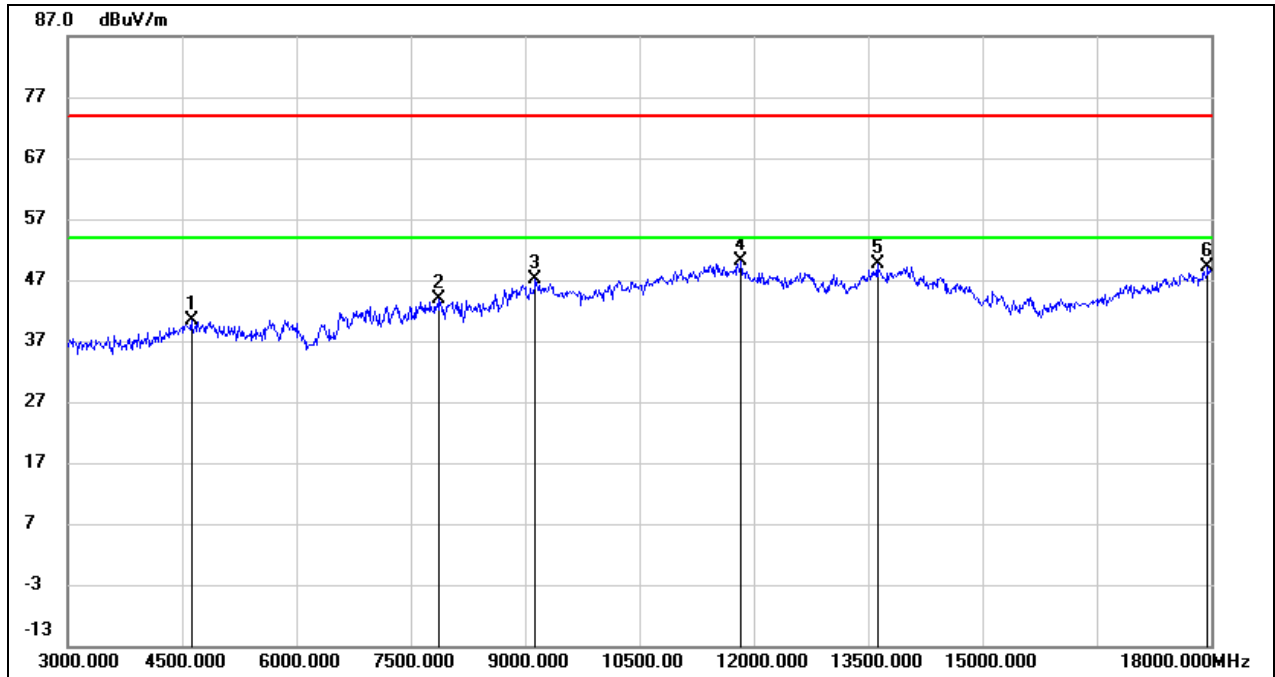

No.	Frequency (MHz)	Reading (dBuV)	Correct (dB/m)	Result (dBuV/m)	Limit (dBuV/m)	Margin (dB)	Remark
1	4620.000	41.38	-1.00	40.38	74.00	-33.62	peak
2	7875.000	37.54	6.31	43.85	74.00	-30.15	peak
3	9135.000	36.58	10.55	47.13	74.00	-26.87	peak
4	11835.000	32.62	17.51	50.13	74.00	-23.87	peak
5	13620.000	28.43	21.15	49.58	74.00	-24.42	peak
6	17955.000	23.61	25.42	49.03	74.00	-24.97	peak



Test Mode:	802.11g	Channel:	2437
Polarity:	Vertical	Test Voltage:	AC 120V_60Hz

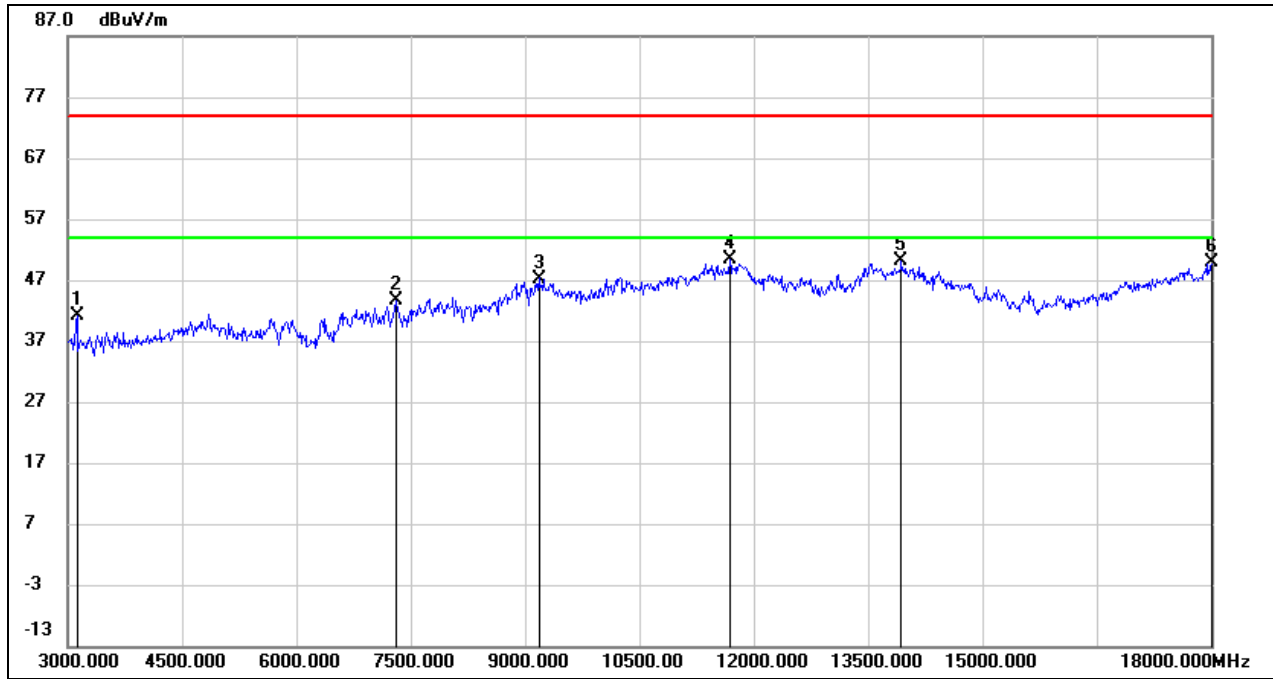

No.	Frequency (MHz)	Reading (dBuV)	Correct (dB/m)	Result (dBuV/m)	Limit (dBuV/m)	Margin (dB)	Remark
1	3120.000	46.25	-5.17	41.08	74.00	-32.92	peak
2	7305.000	37.09	6.47	43.56	74.00	-30.44	peak
3	9180.000	36.69	10.56	47.25	74.00	-26.75	peak
4	11685.000	33.27	17.10	50.37	74.00	-23.63	peak
5	13935.000	28.25	21.82	50.07	74.00	-23.93	peak
6	18000.000	24.27	25.69	49.96	74.00	-24.04	peak



Test Mode:	802.11g	Channel:	2462
Polarity:	Horizontal	Test Voltage:	AC 120V_60Hz

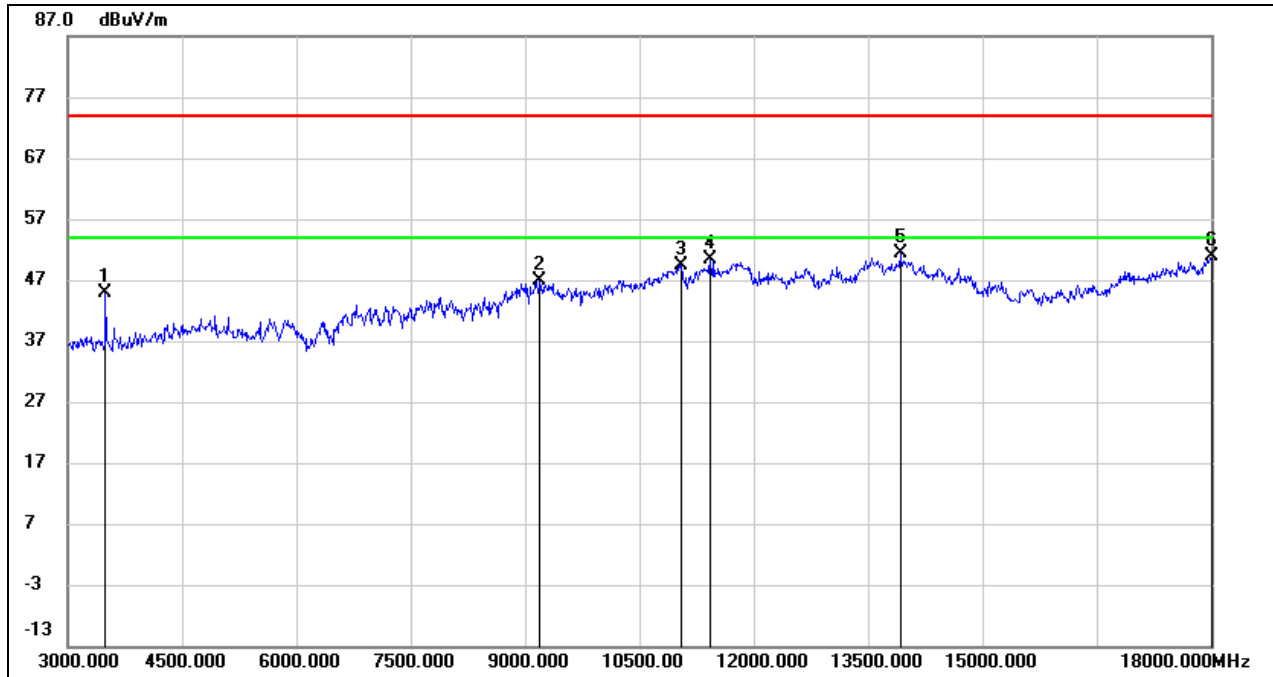

No.	Frequency (MHz)	Reading (dBuV)	Correct (dB/m)	Result (dBuV/m)	Limit (dBuV/m)	Margin (dB)	Remark
1	3495.000	49.89	-4.96	44.93	74.00	-29.07	peak
2	9195.000	36.20	10.56	46.76	74.00	-27.24	peak
3	11055.000	34.38	14.96	49.34	74.00	-24.66	peak
4	11430.000	33.94	16.34	50.28	74.00	-23.72	peak
5	13920.000	29.55	21.79	51.34	74.00	-22.66	peak
6	18000.000	25.16	25.69	50.85	74.00	-23.15	peak



Test Mode:	802.11g	Channel:	2462
Polarity:	Vertical	Test Voltage:	AC 120V_60Hz

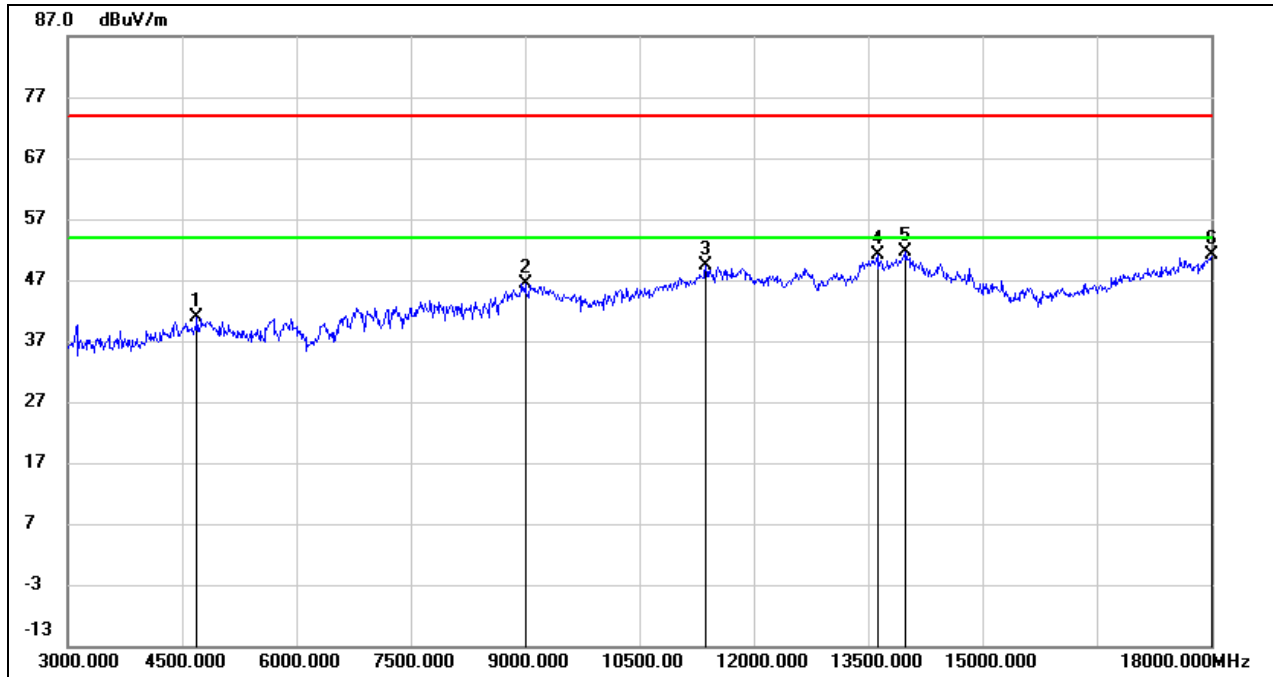

No.	Frequency (MHz)	Reading (dBuV)	Correct (dB/m)	Result (dBuV/m)	Limit (dBuV/m)	Margin (dB)	Remark
1	4695.000	41.47	-0.71	40.76	74.00	-33.24	peak
2	9000.000	36.02	10.48	46.50	74.00	-27.50	peak
3	11370.000	33.16	16.12	49.28	74.00	-24.72	peak
4	13620.000	29.87	21.15	51.02	74.00	-22.98	peak
5	13995.000	29.71	21.95	51.66	74.00	-22.34	peak
6	18000.000	25.50	25.69	51.19	74.00	-22.81	peak



Test Mode:	802.11n HT20	Channel:	2412
Polarity:	Horizontal	Test Voltage:	AC 120V_60Hz

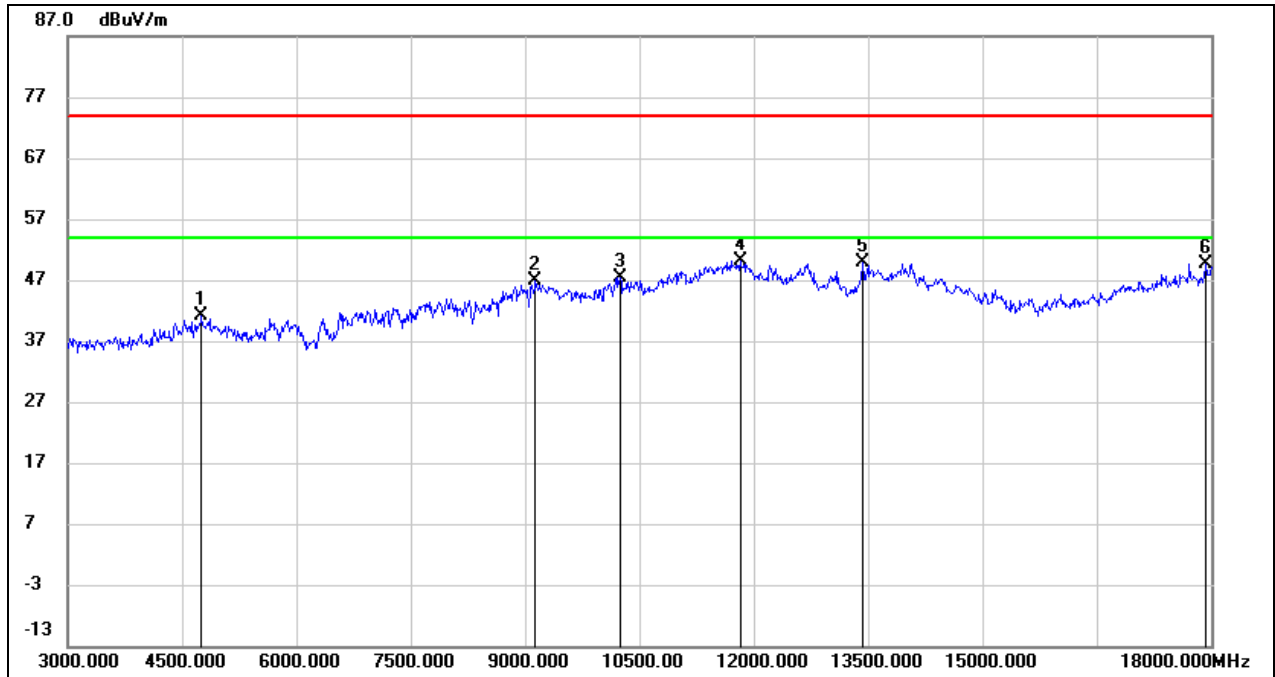

No.	Frequency (MHz)	Reading (dBuV)	Correct (dB/m)	Result (dBuV/m)	Limit (dBuV/m)	Margin (dB)	Remark
1	4755.000	41.62	-0.48	41.14	74.00	-32.86	peak
2	9135.000	36.23	10.55	46.78	74.00	-27.22	peak
3	10245.000	34.98	12.48	47.46	74.00	-26.54	peak
4	11820.000	32.70	17.47	50.17	74.00	-23.83	peak
5	13425.000	29.26	20.58	49.84	74.00	-24.16	peak
6	17925.000	24.46	25.25	49.71	74.00	-24.29	peak





Test Mode:	802.11n HT20	Channel:	2412
Polarity:	Vertical	Test Voltage:	AC 120V_60Hz

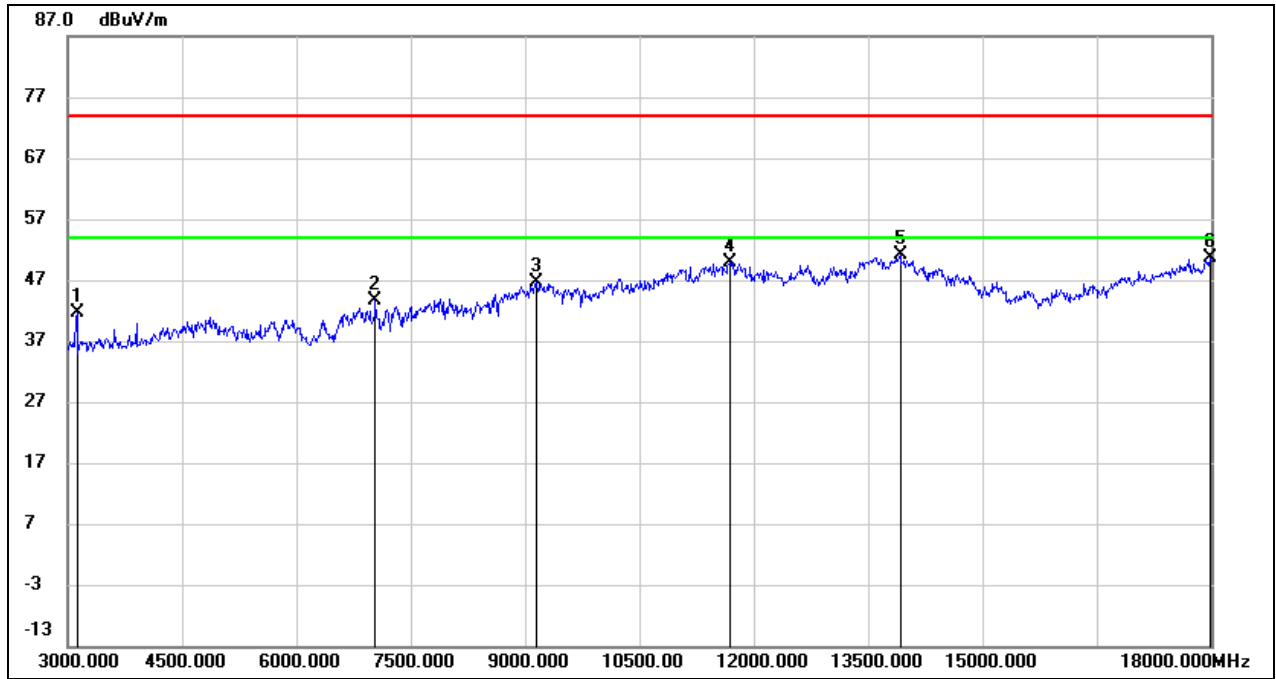

No.	Frequency (MHz)	Reading (dBuV)	Correct (dB/m)	Result (dBuV/m)	Limit (dBuV/m)	Margin (dB)	Remark
1	3120.000	46.76	-5.17	41.59	74.00	-32.41	peak
2	7035.000	36.86	6.67	43.53	74.00	-30.47	peak
3	9150.000	36.06	10.54	46.60	74.00	-27.40	peak
4	11685.000	32.85	17.10	49.95	74.00	-24.05	peak
5	13920.000	29.26	21.79	51.05	74.00	-22.95	peak
6	17985.000	25.10	25.60	50.70	74.00	-23.30	peak



Test Mode:	802.11n HT20	Channel:	2437
Polarity:	Horizontal	Test Voltage:	AC 120V_60Hz

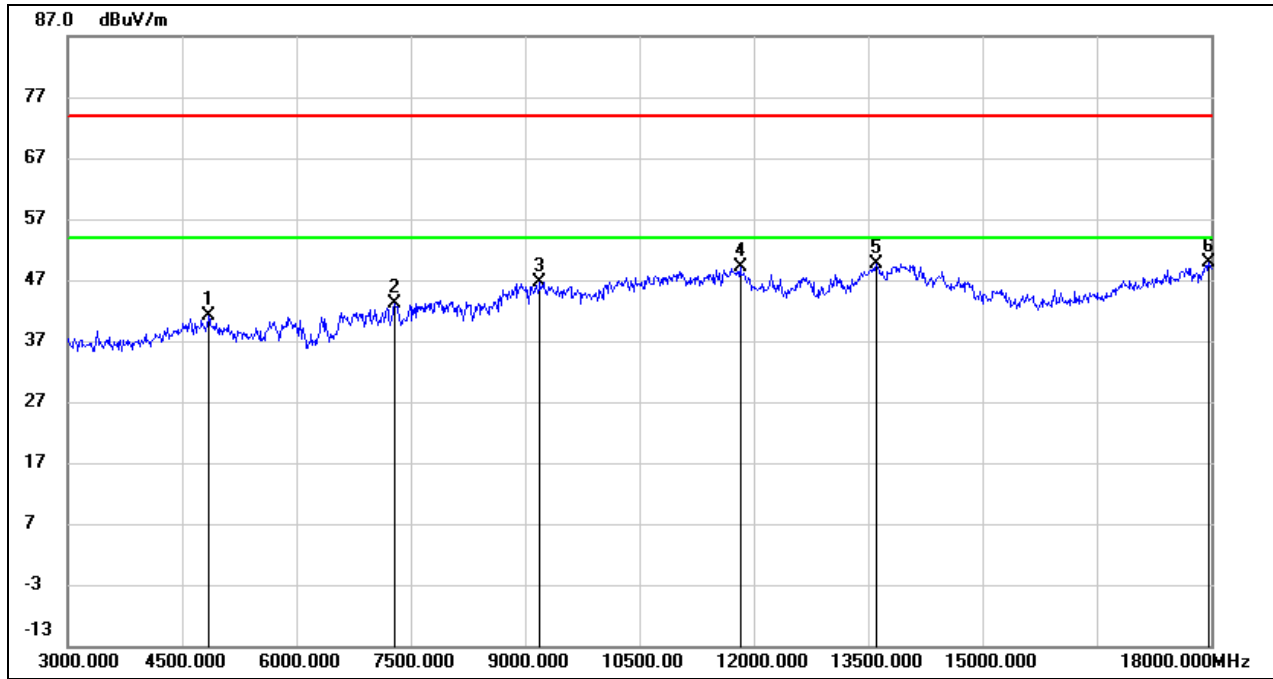

No.	Frequency (MHz)	Reading (dBuV)	Correct (dB/m)	Result (dBuV/m)	Limit (dBuV/m)	Margin (dB)	Remark
1	4845.000	41.17	-0.15	41.02	74.00	-32.98	peak
2	7290.000	36.55	6.48	43.03	74.00	-30.97	peak
3	9195.000	36.15	10.56	46.71	74.00	-27.29	peak
4	11820.000	31.58	17.47	49.05	74.00	-24.95	peak
5	13605.000	28.48	21.12	49.60	74.00	-24.40	peak
6	17970.000	24.33	25.51	49.84	74.00	-24.16	peak



Test Mode:	802.11n HT20	Channel:	2437
Polarity:	Vertical	Test Voltage:	AC 120V_60Hz

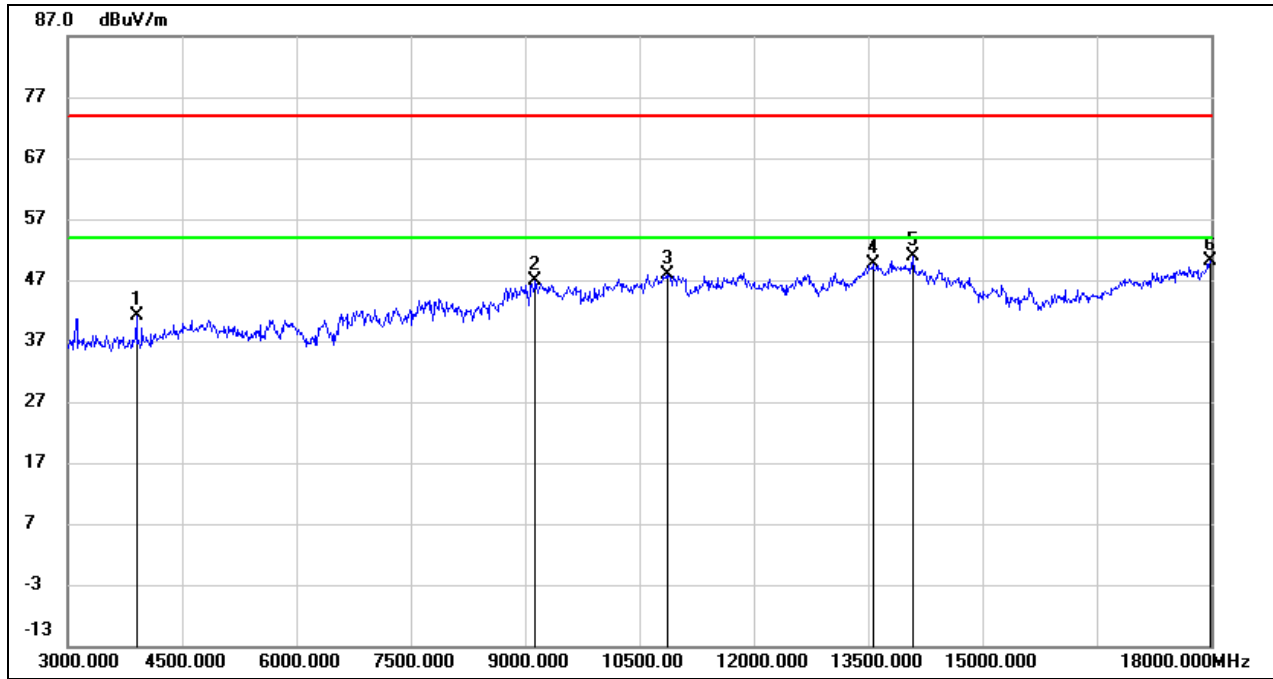

No.	Frequency (MHz)	Reading (dBuV)	Correct (dB/m)	Result (dBuV/m)	Limit (dBuV/m)	Margin (dB)	Remark
1	3900.000	45.11	-4.03	41.08	74.00	-32.92	peak
2	9135.000	36.31	10.55	46.86	74.00	-27.14	peak
3	10860.000	33.63	14.27	47.90	74.00	-26.10	peak
4	13560.000	28.51	21.04	49.55	74.00	-24.45	peak
5	14085.000	29.19	21.61	50.80	74.00	-23.20	peak
6	17985.000	24.62	25.60	50.22	74.00	-23.78	peak



Test Mode:	802.11n HT20	Channel:	2462
Polarity:	Horizontal	Test Voltage:	AC 120V_60Hz

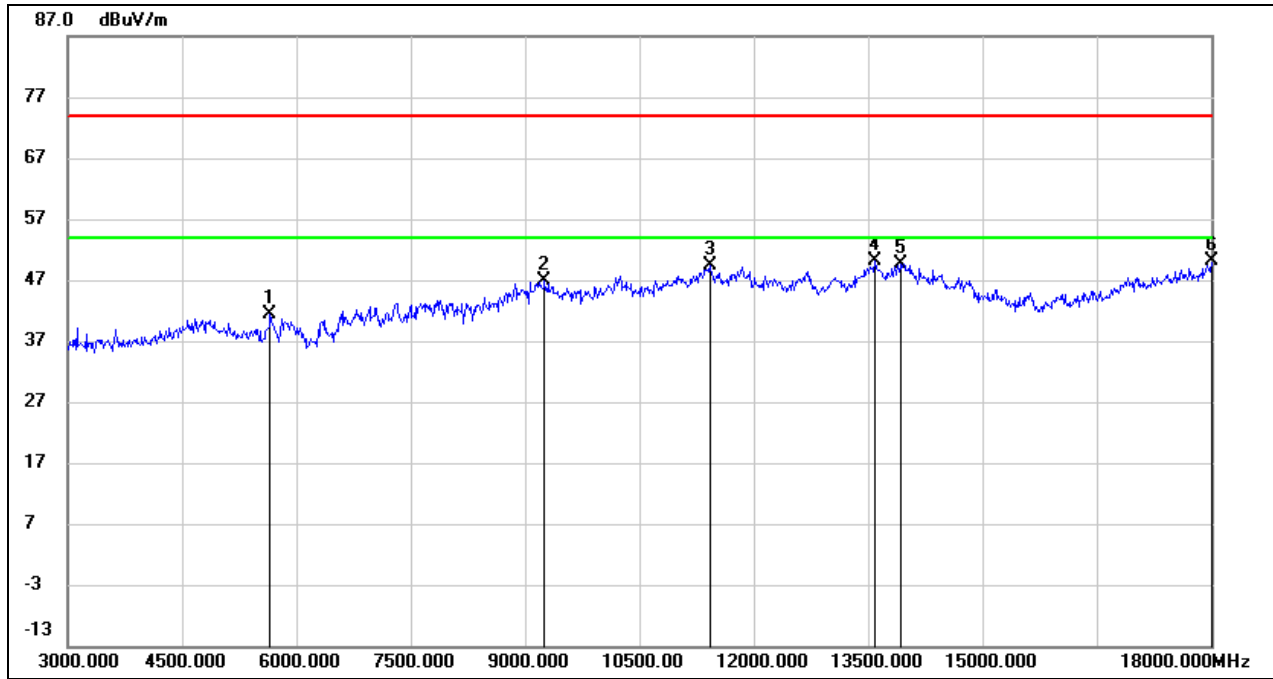

No.	Frequency (MHz)	Reading (dBuV)	Correct (dB/m)	Result (dBuV/m)	Limit (dBuV/m)	Margin (dB)	Remark
1	5655.000	39.97	1.29	41.26	74.00	-32.74	peak
2	9255.000	36.32	10.59	46.91	74.00	-27.09	peak
3	11430.000	32.98	16.34	49.32	74.00	-24.68	peak
4	13590.000	28.97	21.09	50.06	74.00	-23.94	peak
5	13920.000	27.77	21.79	49.56	74.00	-24.44	peak
6	18000.000	24.52	25.69	50.21	74.00	-23.79	peak



Test Mode:	802.11n HT20	Channel:	2462
Polarity:	Vertical	Test Voltage:	AC 120V_60Hz

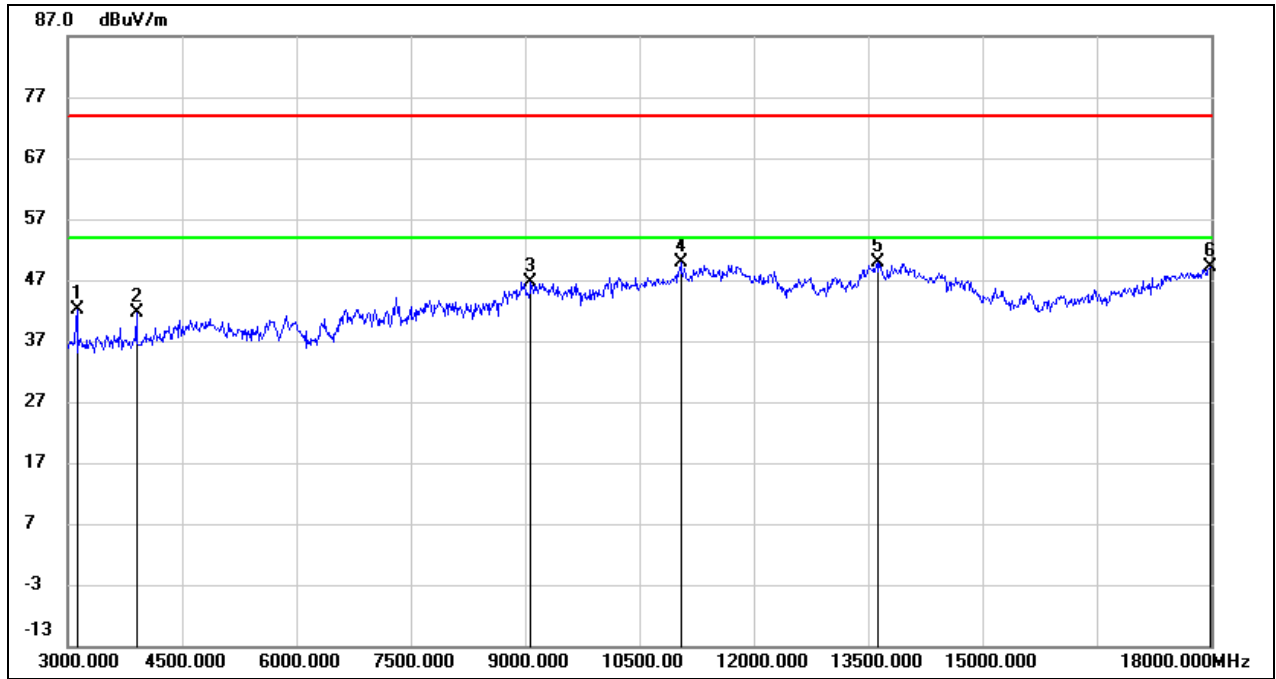

No.	Frequency (MHz)	Reading (dBuV)	Correct (dB/m)	Result (dBuV/m)	Limit (dBuV/m)	Margin (dB)	Remark
1	3120.000	47.22	-5.17	42.05	74.00	-31.95	peak
2	3900.000	45.69	-4.03	41.66	74.00	-32.34	peak
3	9075.000	36.10	10.52	46.62	74.00	-27.38	peak
4	11040.000	34.95	14.91	49.86	74.00	-24.14	peak
5	13620.000	28.65	21.15	49.80	74.00	-24.20	peak
6	17985.000	23.56	25.60	49.16	74.00	-24.84	peak



### 8.4. SPURIOUS EMISSIONS(9 KHZ~30 MHZ)

Test Mode:	802.11b	Channel:	2412
Polarity:	FACE ON	Test Voltage:	AC 120V_60Hz

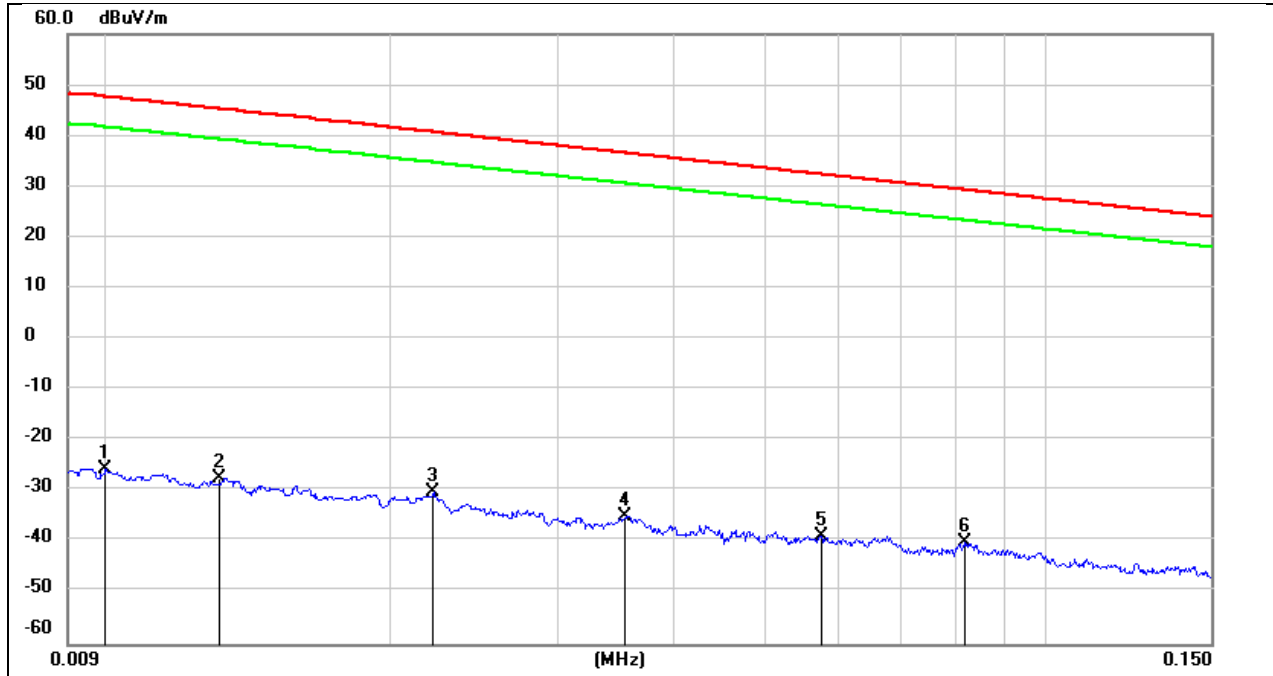

No.	Frequency (MHz)	Reading (dBuV)	Correct (dB/m)	FCC Result (dBuV/m)	FCC Limit (dBuV/m)	ISED Result (dBuA/m)	ISED Limit (dBuA/m)	Margin (dB)	Remark
1	0.0100	75.72	-101.40	-25.68	47.60	-77.18	-3.90	-73.28	peak
2	0.0131	73.97	-101.38	-27.41	45.25	-78.91	-6.25	-72.66	peak
3	0.0221	71.13	-101.35	-30.22	40.71	-81.72	-10.79	-70.93	peak
4	0.0354	66.47	-101.41	-34.94	36.62	-86.44	-14.88	-71.56	peak
5	0.0575	62.79	-101.51	-38.72	32.41	-90.22	-19.09	-71.13	peak
6	0.0819	61.52	-101.65	-40.13	29.34	-91.63	-22.16	-69.47	peak



Test Mode:	802.11b	Channel:	2412
Polarity:	FACE ON	Test Voltage:	AC 120V_60Hz

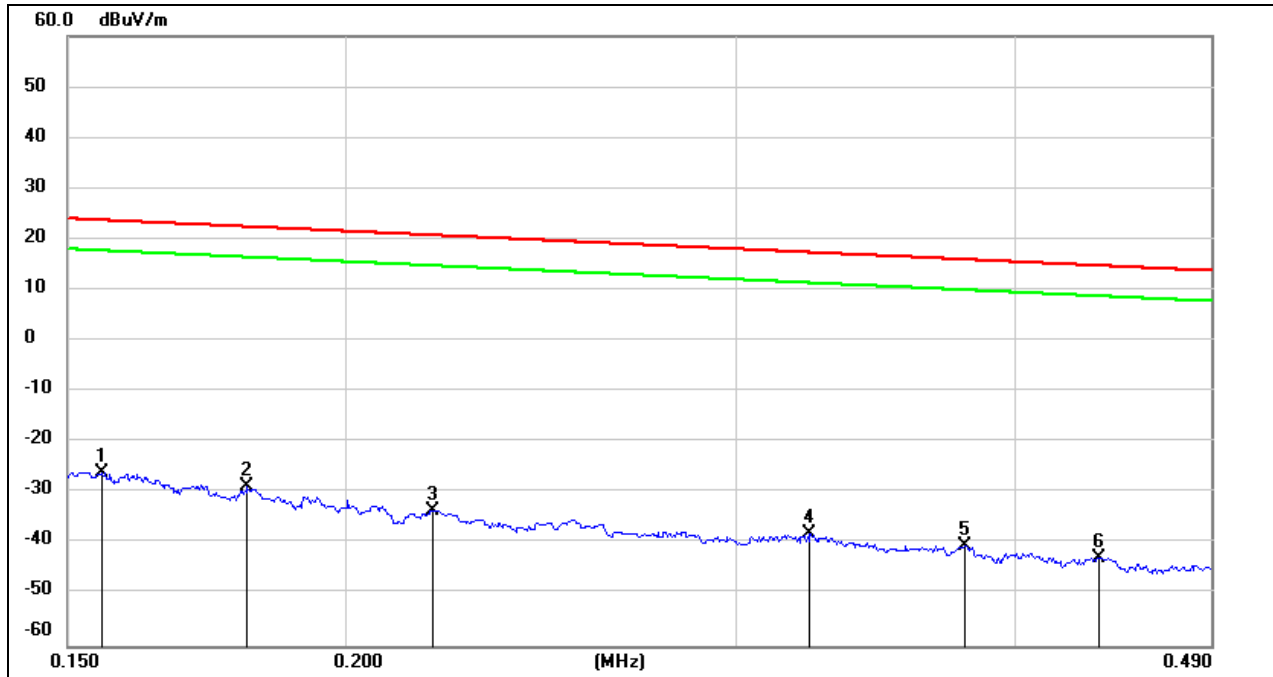

No.	Frequency (MHz)	Reading (dBuV)	Correct (dB/m)	FCC Result (dBuV/m)	FCC Limit (dBuV/m)	ISED Result (dBuA/m)	ISED Limit (dBuA/m)	Margin (dB)	Remark
1	0.1554	75.77	-101.65	-25.88	23.77	-77.38	-27.73	-49.65	peak
2	0.1806	72.93	-101.68	-28.75	22.47	-80.25	-29.03	-51.22	peak
3	0.2190	68.27	-101.75	-33.48	20.79	-84.98	-30.71	-54.27	peak
4	0.3234	63.98	-101.88	-37.90	17.41	-89.40	-34.09	-55.31	peak
5	0.3800	61.52	-101.94	-40.42	16.01	-91.92	-35.49	-56.43	peak
6	0.4364	59.36	-101.99	-42.63	14.80	-94.13	-36.70	-57.43	peak



Test Mode:	802.11b	Channel:	2412
Polarity:	FACE ON	Test Voltage:	AC 120V_60Hz

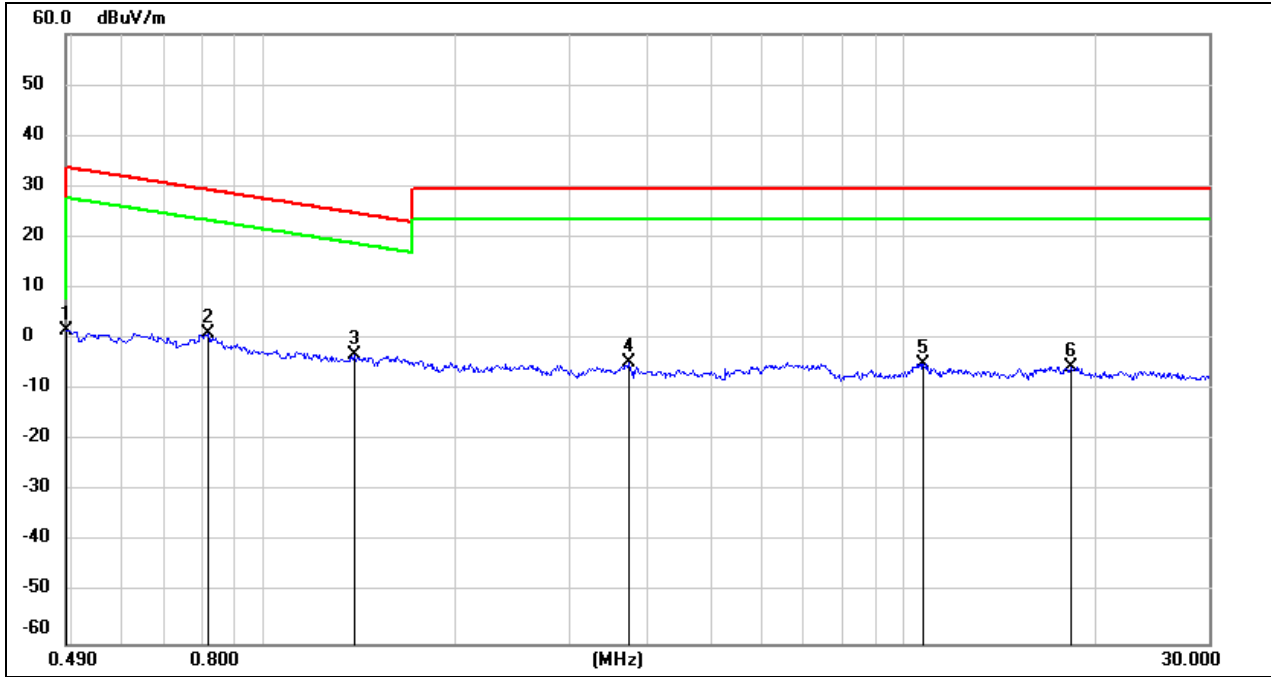

No.	Frequency (MHz)	Reading (dBuV)	Correct (dB/m)	FCC Result (dBuV/m)	FCC Limit (dBuV/m)	ISED Result (dBuA/m)	ISED Limit (dBuA/m)	Margin (dB)	Remark
1	0.4900	63.72	-62.06	1.66	13.80	-49.84	-37.70	-12.14	peak
2	0.8195	63.16	-62.16	1.00	29.33	-50.50	-22.17	-28.33	peak
3	1.3810	58.97	-62.10	-3.13	24.80	-54.63	-26.70	-27.93	peak
4	3.7100	56.70	-61.41	-4.71	29.54	-56.21	-21.96	-34.25	peak
5	10.7299	55.98	-60.83	-4.85	29.54	-56.35	-21.96	-34.39	peak
6	18.2545	55.43	-60.90	-5.47	29.54	-56.97	-21.96	-35.01	peak



**8.5. SPURIOUS EMISSIONS(18 GHZ~26 GHZ)**

Test Mode:	802.11b	Channel:	2412
Polarity:	Horizontal	Test Voltage:	AC 120V_60Hz

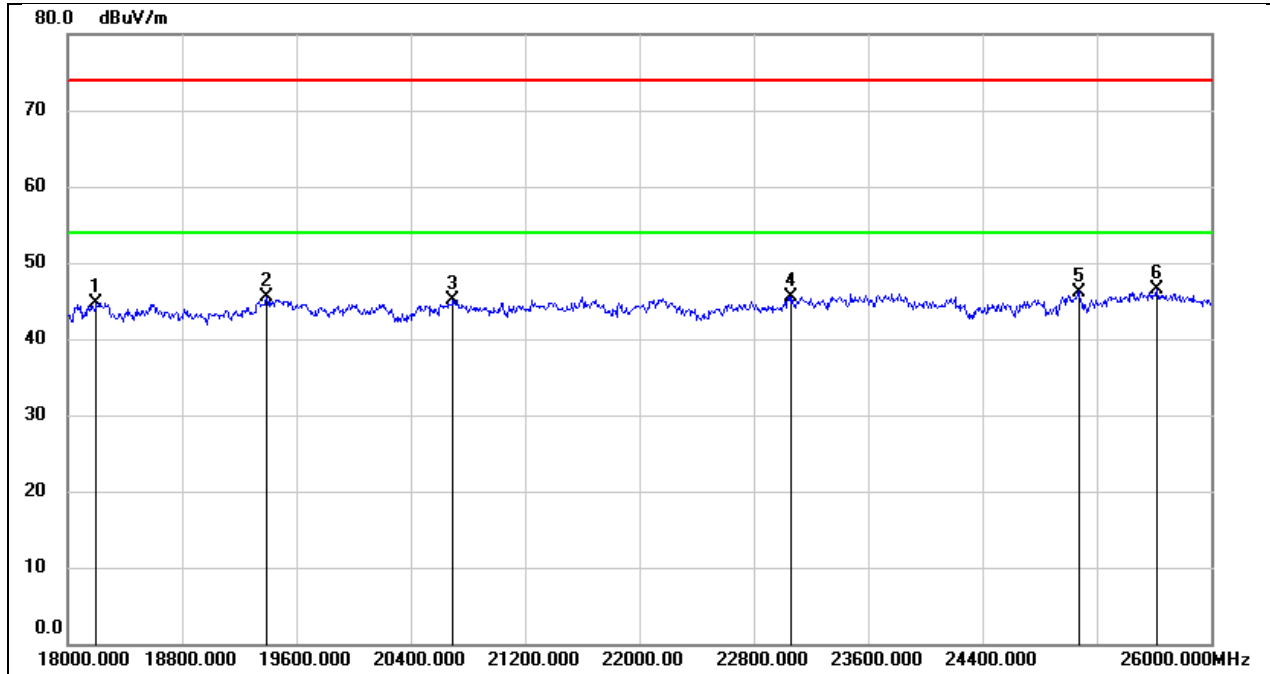

No.	Frequency (MHz)	Reading (dBuV)	Correct (dB/m)	Result (dBuV/m)	Limit (dBuV/m)	Margin (dB)	Remark
1	18200.000	50.29	-5.52	44.77	74.00	-29.23	peak
2	19392.000	51.12	-5.57	45.55	74.00	-28.45	peak
3	20696.000	50.21	-5.16	45.05	74.00	-28.95	peak
4	23064.000	48.99	-3.42	45.57	74.00	-28.43	peak
5	25072.000	48.17	-1.97	46.20	74.00	-27.80	peak
6	25616.000	47.68	-1.24	46.44	74.00	-27.56	peak



Test Mode:	802.11b	Channel:	2412
Polarity:	Vertical	Test Voltage:	AC 120V_60Hz

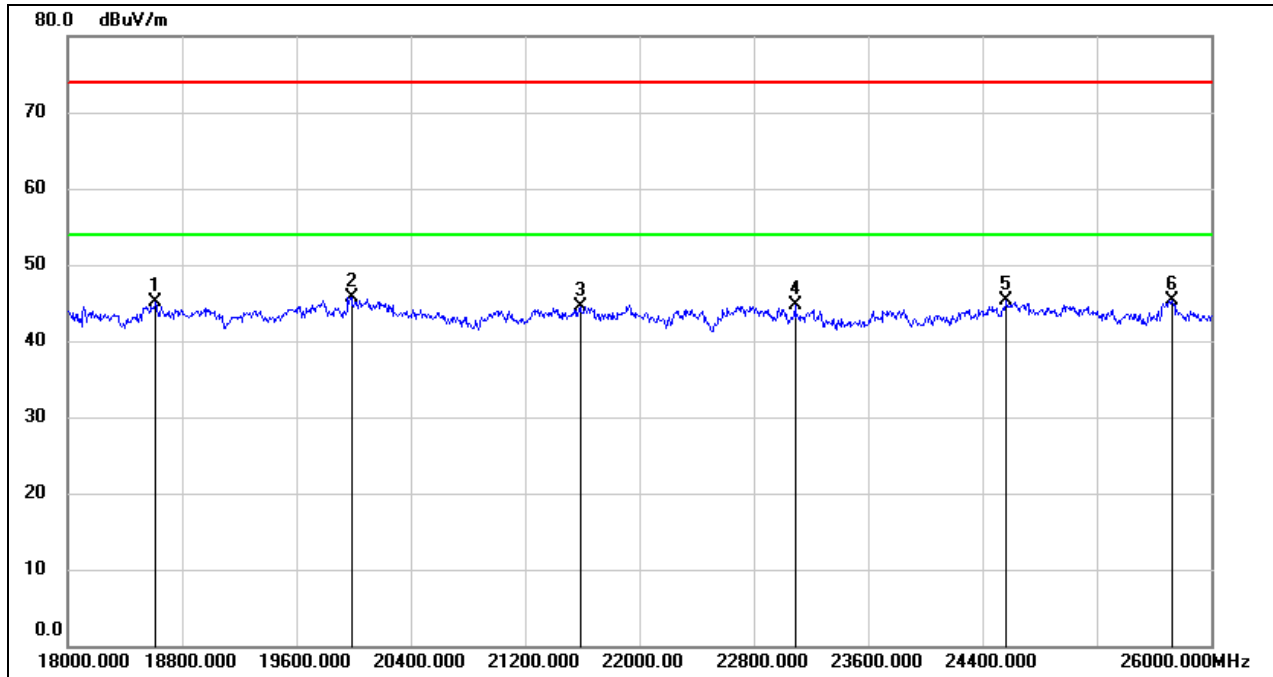

No.	Frequency (MHz)	Reading (dBuV)	Correct (dB/m)	Result (dBuV/m)	Limit (dBuV/m)	Margin (dB)	Remark
1	18616.000	50.39	-5.34	45.05	74.00	-28.95	peak
2	19984.000	51.21	-5.44	45.77	74.00	-28.23	peak
3	21584.000	49.10	-4.56	44.54	74.00	-29.46	peak
4	23088.000	48.02	-3.41	44.61	74.00	-29.39	peak
5	24568.000	47.60	-2.33	45.27	74.00	-28.73	peak
6	25728.000	46.11	-0.72	45.39	74.00	-28.61	peak

**8.6. SPURIOUS EMISSIONS(30 MHZ~1 GHZ)**

Test Mode:	802.11b	Channel:	2412
Polarity:	Horizontal	Test Voltage:	AC120V_60Hz

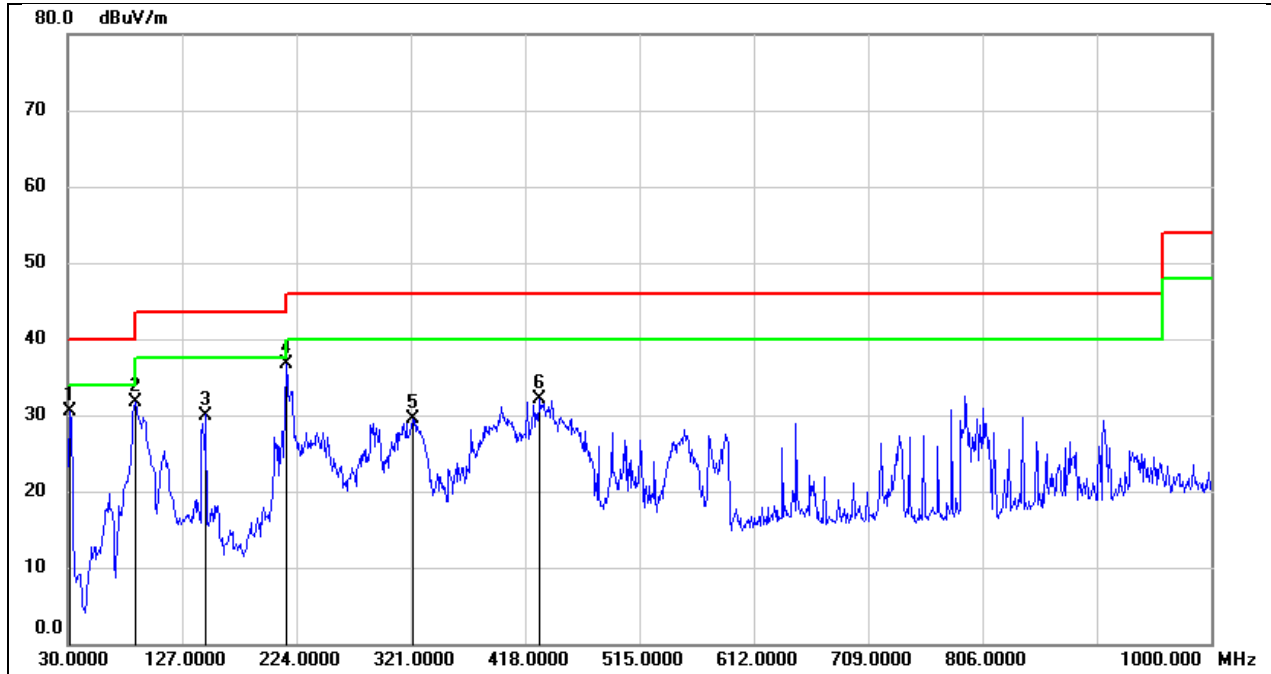

No.	Frequency (MHz)	Reading (dBuV)	Correct (dB/m)	Result (dBuV/m)	Limit (dBuV/m)	Margin (dB)	Remark
1	31.9400	49.57	-19.13	30.44	40.00	-9.56	QP
2	87.2300	53.49	-21.80	31.69	40.00	-8.31	QP
3	147.3700	48.43	-18.43	30.00	43.50	-13.50	QP
4	215.2700	54.51	-17.76	36.75	43.50	-6.75	QP
5	322.9400	44.32	-14.75	29.57	46.00	-16.43	QP
6	430.6100	44.79	-12.71	32.08	46.00	-13.92	QP



Test Mode:	802.11b	Channel:	2412
Polarity:	Vertical	Test Voltage:	AC120V_60Hz

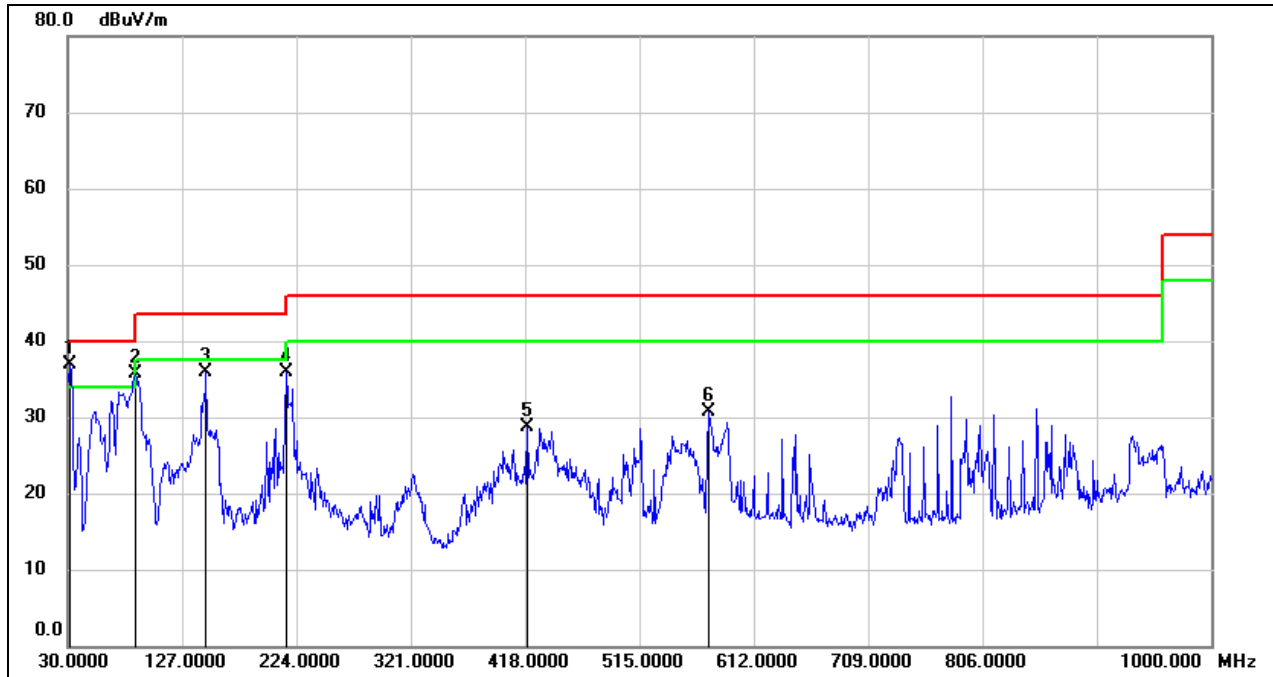

No.	Frequency (MHz)	Reading (dBuV)	Correct (dB/m)	Result (dBuV/m)	Limit (dBuV/m)	Margin (dB)	Remark
1	31.9400	55.96	-19.13	36.83	40.00	-3.17	QP
2	87.2300	57.45	-21.80	35.65	40.00	-4.35	QP
3	147.3700	54.36	-18.43	35.93	43.50	-7.57	QP
4	215.2700	53.70	-17.76	35.94	43.50	-7.56	QP
5	419.9400	41.66	-12.99	28.67	46.00	-17.33	QP
6	574.1700	40.65	-10.04	30.61	46.00	-15.39	QP



## 9. ANTENNA REQUIREMENT

### APPLICABLE REQUIREMENTS

Please refer to FCC §15.203

An intentional radiator shall be designed to ensure that no antenna other than that furnished by the responsible party shall be used with the device. The use of a permanently attached antenna or of an antenna that uses a unique coupling to the intentional radiator shall be considered sufficient to comply with the provisions of this section. The manufacturer may design the unit so that a broken antenna can be replaced by the user, but the use of a standard antenna jack or electrical connector is prohibited.

Please refer to FCC §15.247(b)(4)

The conducted output power limit specified in paragraph (b) of this section is based on the use of antennas with directional gains that do not exceed 6 dBi. Except as shown in paragraph (c) of this section, if transmitting antennas of directional gain greater than 6 dBi are used, the conducted output power from the intentional radiator shall be reduced below the stated values in paragraphs (b)(1), (b)(2), and (b)(3) of this section, as appropriate, by the amount in dB that the directional gain of the antenna exceeds 6 dBi.

### RESULTS

Complies

## 10. AC POWER LINE CONDUCTED EMISSION

### LIMITS

Please refer to CFR 47 FCC §15.207 (a) and ISED RSS-Gen Clause 8.8

FREQUENCY (MHz)	Quasi-peak	Average
0.15 -0.5	66 - 56 *	56 - 46 *
0.50 -5.0	56.00	46.00
5.0 -30.0	60.00	50.00

### TEST PROCEDURE

The EUT is put on a table of non-conducting material that is 80 cm high. The vertical conducting wall of shielding is located 40 cm to the rear of the EUT. The power line of the EUT is connected to the AC mains through a Artificial Mains Network (A.M.N.). A EMI Measurement Receiver (R&S Test Receiver ESR3) is used to test the emissions from both sides of AC line. According to the requirements in Section 6.2 of ANSI C63.10-2013. Conducted emissions from the EUT measured in the frequency range between 0.15 MHz and 30 MHz using CISPR Quasi-Peak and average detector mode. The bandwidth of EMI test receiver is set at 9 kHz.

The arrangement of the equipment is installed to meet the standards and operating in a manner, which tends to maximize its emission characteristics in a normal application.

### TEST SETUP

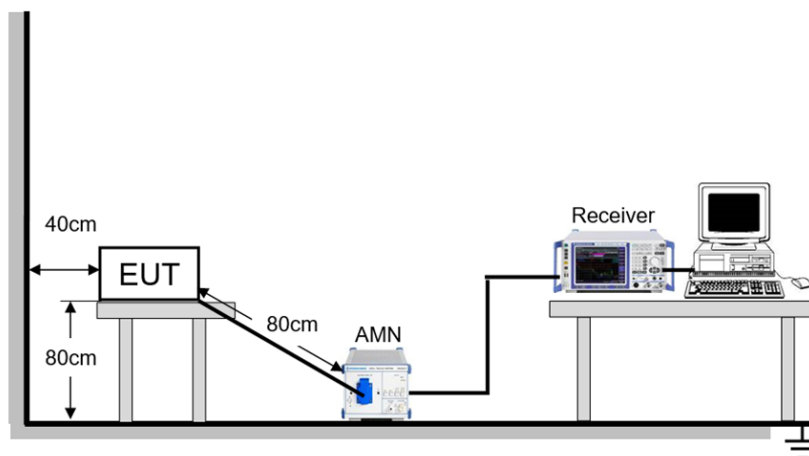



**TEST ENVIRONMENT**

Temperature	23.1°C	Relative Humidity	51.1%
Atmosphere Pressure	101kPa	Test Voltage	AC 120 V, 60 Hz

**TEST DATE / ENGINEER**

Test Date	December 16, 2022	Test By	Wite Chen
-----------	-------------------	---------	-----------

**TEST RESULTS**

Test Mode:	802.11b	Channel:	2412
Line:	Line	Test Voltage:	AC120V_60Hz

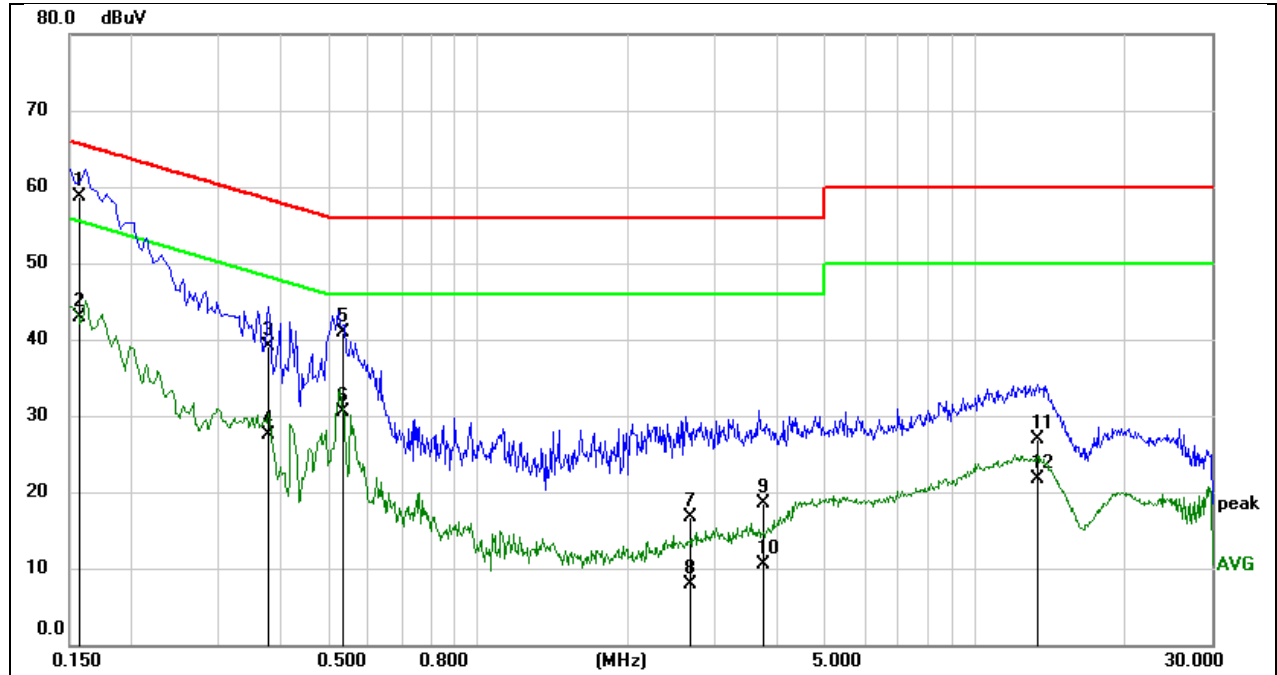

No.	Frequency (MHz)	Reading (dBuV)	Correct (dB)	Result (dBuV)	Limit (dBuV)	Margin (dB)	Remark
1	0.1578	49.21	9.59	58.80	65.58	-6.78	QP
2	0.1578	33.32	9.59	42.91	55.58	-12.67	AVG
3	0.3776	29.60	9.59	39.19	58.33	-19.14	QP
4	0.3776	17.99	9.59	27.58	48.33	-20.75	AVG
5	0.5316	31.27	9.60	40.87	56.00	-15.13	QP
6	0.5316	20.96	9.60	30.56	46.00	-15.44	AVG
7	2.6626	7.06	9.65	16.71	56.00	-39.29	QP
8	2.6626	-1.71	9.65	7.94	46.00	-38.06	AVG
9	3.7520	8.71	9.70	18.41	56.00	-37.59	QP
10	3.7520	0.86	9.70	10.56	46.00	-35.44	AVG
11	13.4203	17.09	9.76	26.85	60.00	-33.15	QP
12	13.4203	11.90	9.76	21.66	50.00	-28.34	AVG

**Note:**

1. Result = Reading + Correct Factor.
2. If QP Result complies with AV limit, AV Result is deemed to comply with AV limit.
3. Test setup: RBW: 200 Hz (9 kHz ~ 150 kHz), 9 kHz (150 kHz ~ 30 MHz).
4. Step size: 80 Hz (0.009 MHz ~ 0.15 MHz), 4 kHz (0.15 MHz ~ 30 MHz), Scan time: auto.

Note: All the modes have been tested, only the worst data was recorded in the report.





Test Mode:	802.11b	Channel:	2412
Line:	Neutral	Test Voltage:	AC120V_60Hz

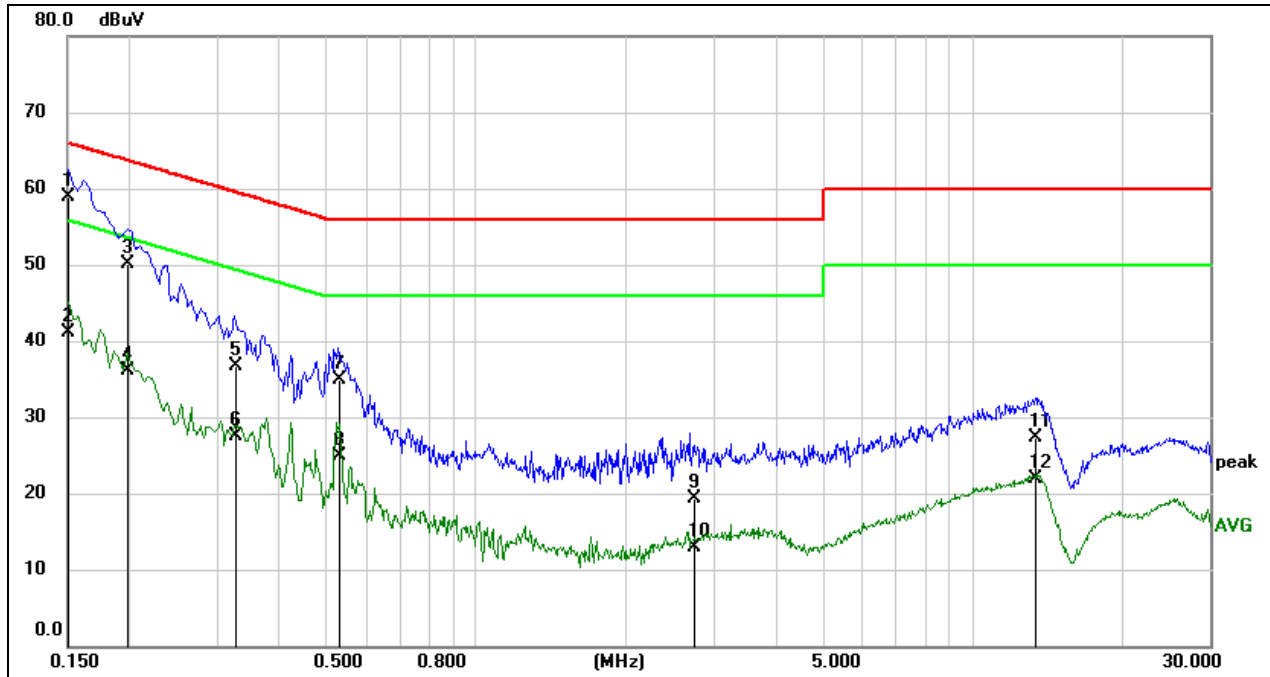

No.	Frequency (MHz)	Reading (dBuV)	Correct (dB)	Result (dBuV)	Limit (dBuV)	Margin (dB)	Remark
1	0.1503	49.22	9.59	58.81	65.98	-7.17	QP
2	0.1503	31.53	9.59	41.12	55.98	-14.86	AVG
3	0.1983	40.47	9.59	50.06	63.68	-13.62	QP
4	0.1983	26.55	9.59	36.14	53.68	-17.54	AVG
5	0.3289	27.09	9.59	36.68	59.48	-22.80	QP
6	0.3289	17.91	9.59	27.50	49.48	-21.98	AVG
7	0.5326	25.28	9.60	34.88	56.00	-21.12	QP
8	0.5326	15.24	9.60	24.84	46.00	-21.16	AVG
9	2.7496	9.60	9.66	19.26	56.00	-36.74	QP
10	2.7496	3.29	9.66	12.95	46.00	-33.05	AVG
11	13.4409	17.48	9.76	27.24	60.00	-32.76	QP
12	13.4409	12.06	9.76	21.82	50.00	-28.18	AVG

## Note:

1. Result = Reading + Correct Factor.
2. If QP Result complies with AV limit, AV Result is deemed to comply with AV limit.
3. Test setup: RBW: 200 Hz (9 kHz ~ 150 kHz), 9 kHz (150 kHz ~ 30 MHz).
4. Step size: 80 Hz (0.009 MHz ~ 0.15 MHz), 4 kHz (0.15 MHz ~ 30 MHz), Scan time: auto.

Note: All the modes have been tested, only the worst data was recorded in the report.



## 11. TEST DATA

### 11.1. APPENDIX A: DTS BANDWIDTH

#### 11.1.1. Test Result

Test Mode	Antenna	Channel	DTS BW [MHz]	FL[MHz]	FH[MHz]	Limit[MHz]	Verdict
11B	Ant1	2412	8.520	2407.960	2416.480	0.5	PASS
		2437	9.520	2432.000	2441.520	0.5	PASS
		2462	8.040	2457.960	2466.000	0.5	PASS
11G	Ant1	2412	15.320	2404.240	2419.560	0.5	PASS
		2437	15.440	2429.120	2444.560	0.5	PASS
		2462	14.200	2454.720	2468.920	0.5	PASS
11N20SISO	Ant1	2412	13.240	2405.760	2419.000	0.5	PASS
		2437	15.400	2429.080	2444.480	0.5	PASS
		2462	15.080	2454.440	2469.520	0.5	PASS

### 11.1.2. Test Graphs



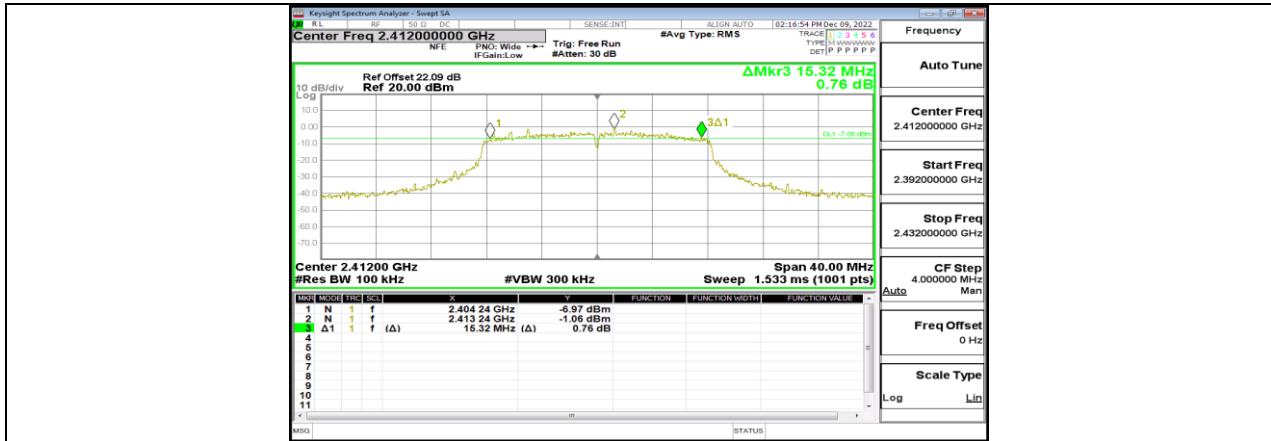

11G\_Ant1\_2412

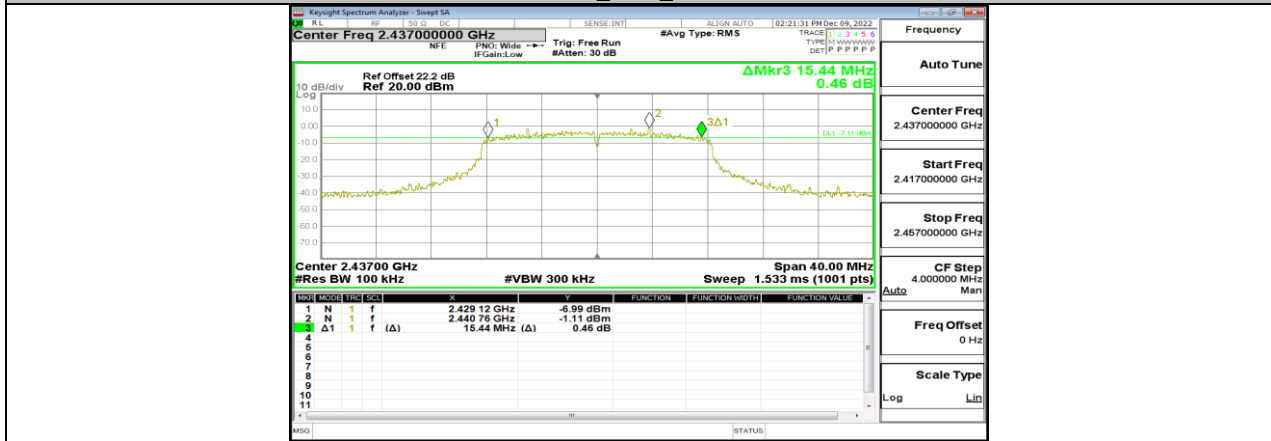

11G\_Ant1\_2437



11G\_Ant1\_2462

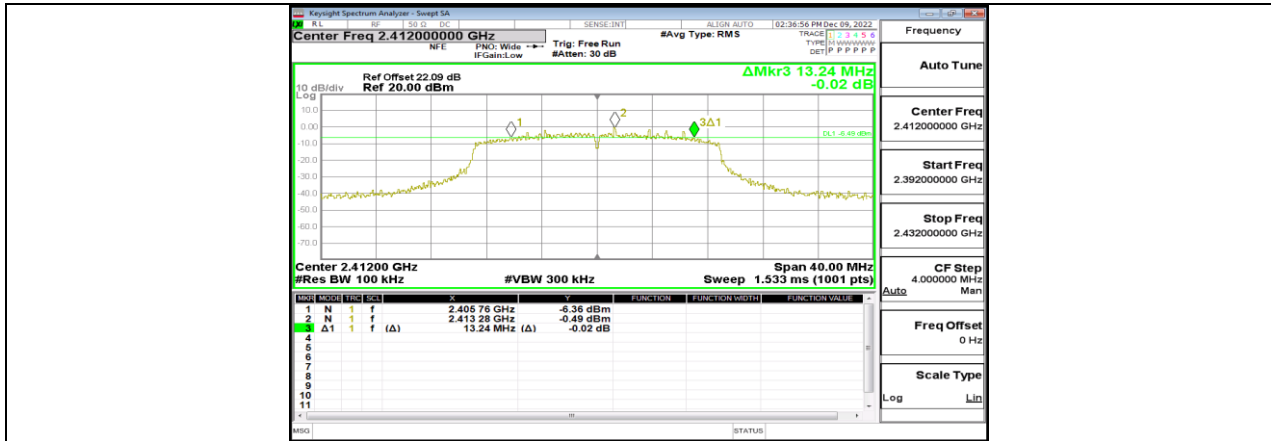

11N20SISO\_Ant1\_2412

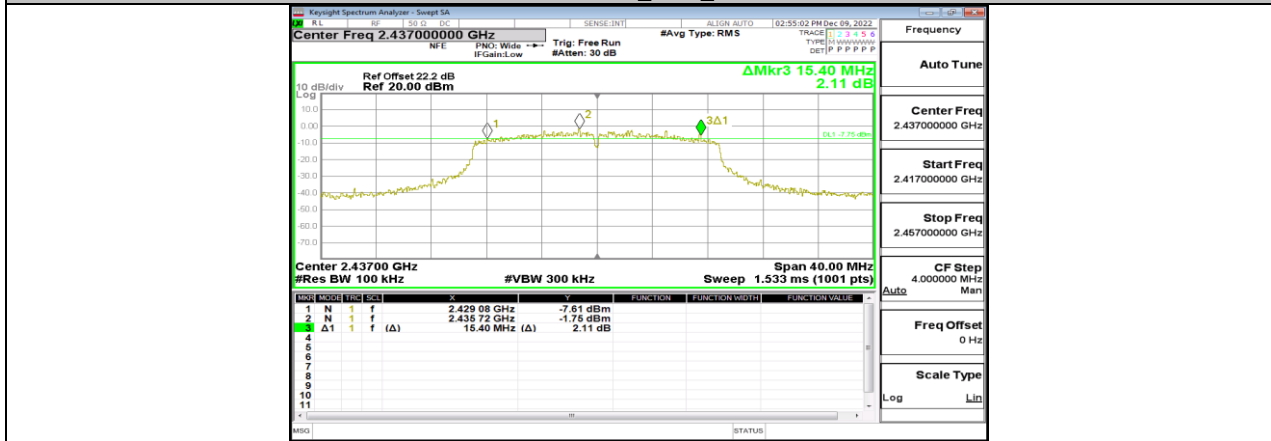

11N20SISO\_Ant1\_2437



11N20SISO\_Ant1\_2462



## 11.2. APPENDIX B: OCCUPIED CHANNEL BANDWIDTH

### 11.2.1. Test Result

Test Mode	Antenna	Channel	OCB [MHz]	FL[MHz]	FH[MHz]	Verdict
11B	Ant1	2412	14.128	2404.9456	2419.0736	PASS
		2437	14.114	2429.9474	2444.0614	PASS
		2462	14.167	2454.9376	2469.1046	PASS
11G	Ant1	2412	16.682	2403.6634	2420.3454	PASS
		2437	16.693	2428.6711	2445.3641	PASS
		2462	16.651	2453.6798	2470.3308	PASS
11N20SISO	Ant1	2412	17.754	2403.1448	2420.8988	PASS
		2437	17.740	2428.0922	2445.8322	PASS
		2462	17.693	2453.1484	2470.8414	PASS

### 11.2.2. Test Graphs



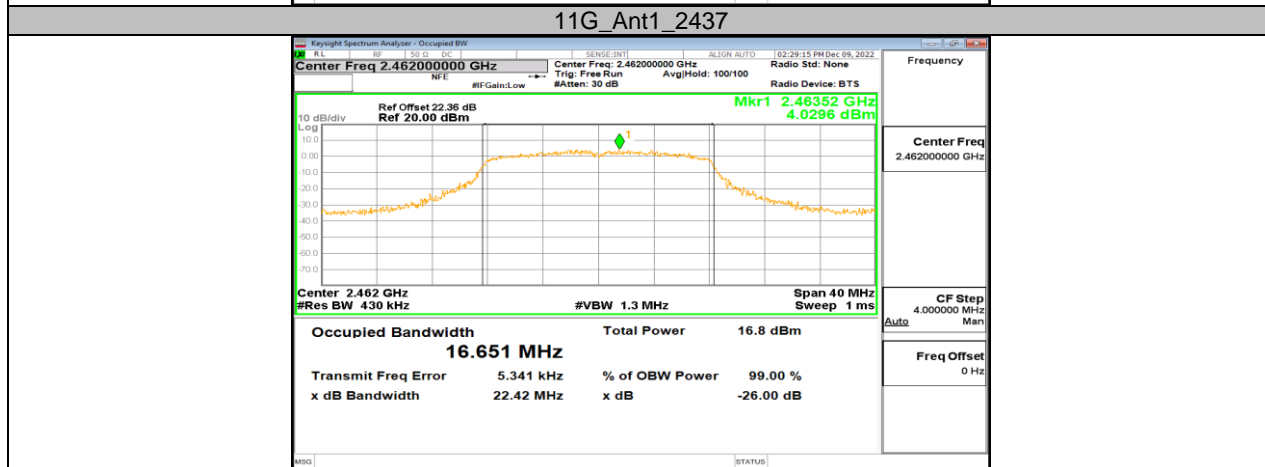
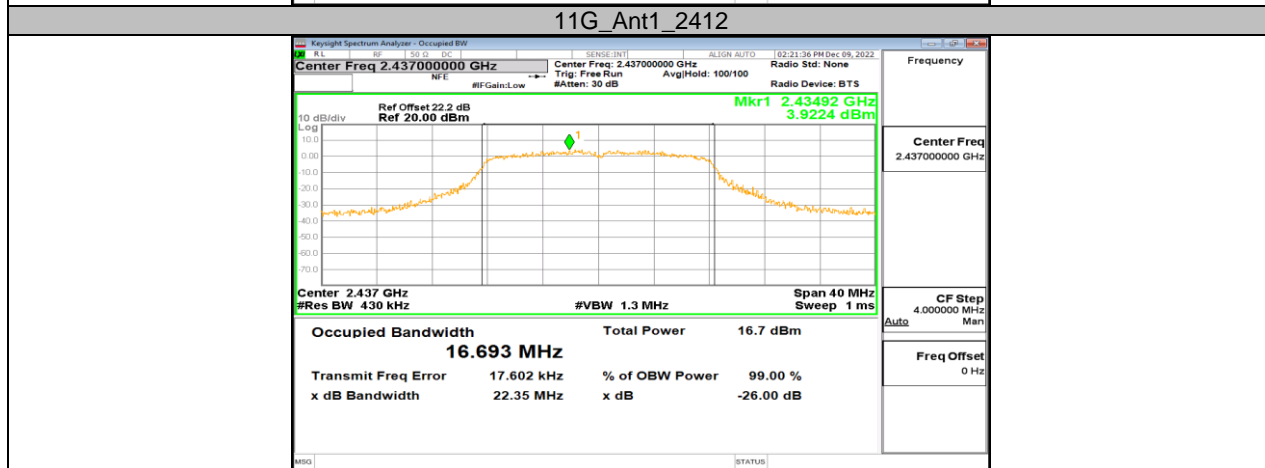
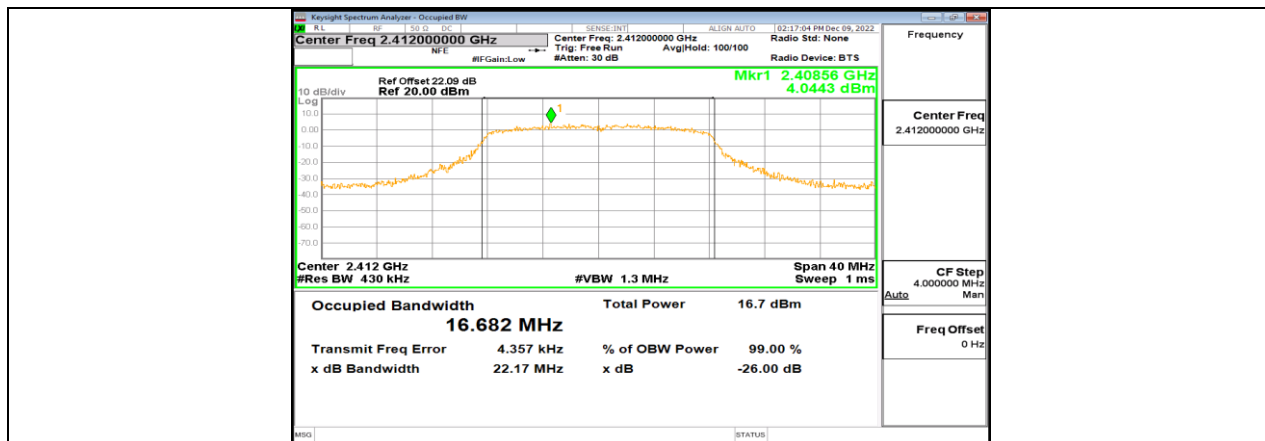



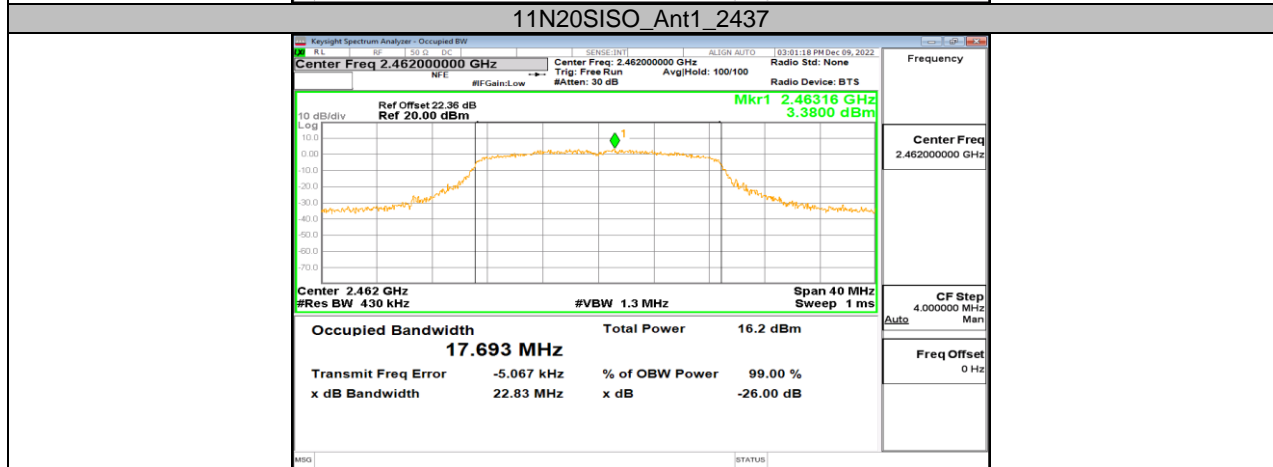
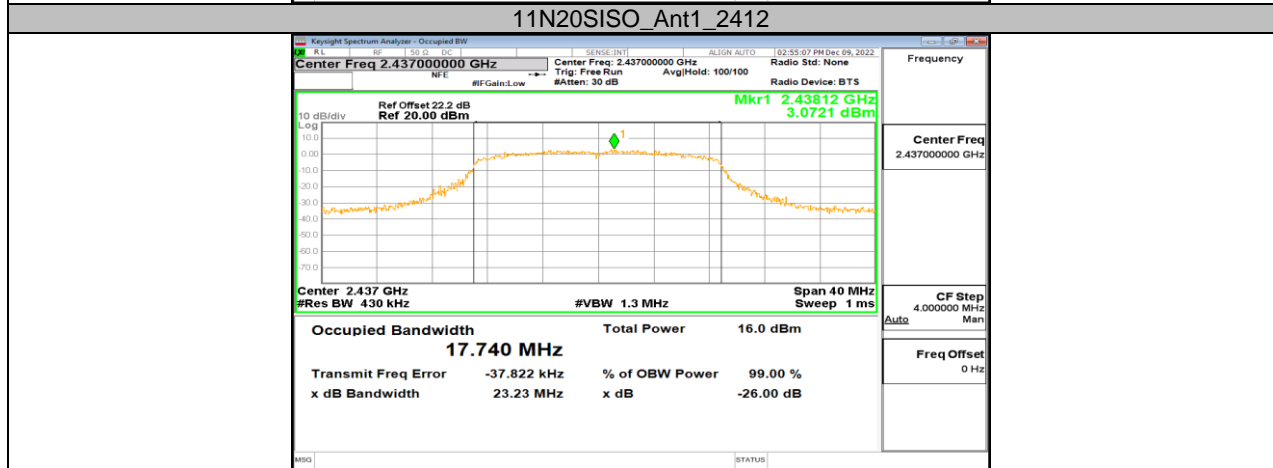
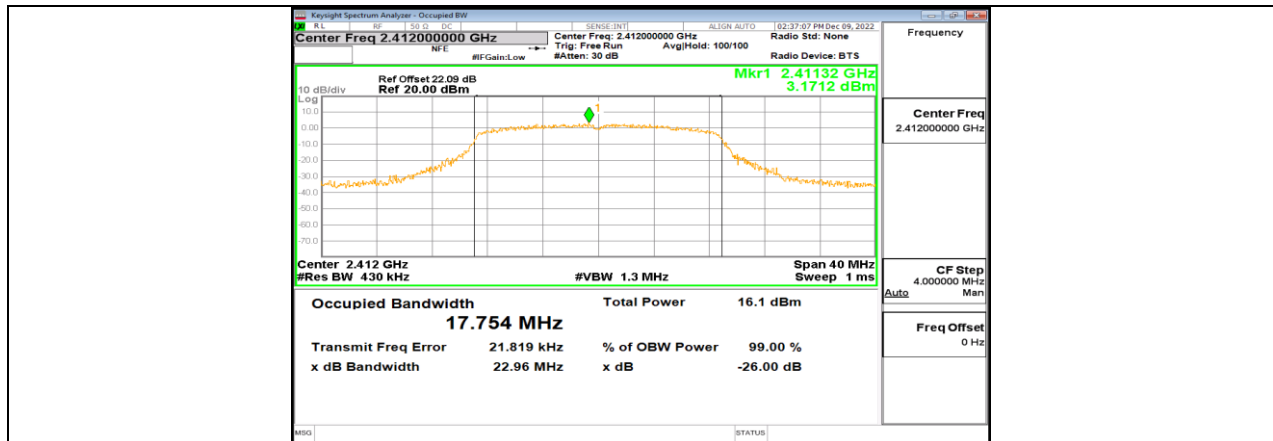

11N20SISO\_Ant1\_2462



### 11.3. APPENDIX C: MAXIMUM CONDUCTED AVG OUTPUT POWER

#### 11.3.1. Test Result

Test Mode	Antenna	Channel	Result[dBm]	Limit[dBm]	Verdict
11B	Ant1	2412	11.78	≤30.00	PASS
		2437	11.71	≤30.00	PASS
		2462	11.80	≤30.00	PASS
11G	Ant1	2412	10.55	≤30.00	PASS
		2437	10.61	≤30.00	PASS
		2462	10.63	≤30.00	PASS
11N20SISO	Ant1	2412	10.00	≤30.00	PASS
		2437	10.08	≤30.00	PASS
		2462	10.11	≤30.00	PASS

- Note: 1. Conducted Power=Meas. Level+ Correction Factor  
2. The Duty Cycle Factor (refer to section 7.5) had already compensated to the test data.



## 11.4. APPENDIX D: MAXIMUM POWER SPECTRAL DENSITY

### 11.4.1. Test Result

Test Mode	Antenna	Channel	Result[dBm/3kHz]	Limit[dBm/3kHz]	Verdict
11B	Ant1	2412	-19.05	≤8.00	PASS
		2437	-19.03	≤8.00	PASS
		2462	-19.15	≤8.00	PASS
11G	Ant1	2412	-22.39	≤8.00	PASS
		2437	-22.38	≤8.00	PASS
		2462	-22.63	≤8.00	PASS
11N20SISO	Ant1	2412	-23.07	≤8.00	PASS
		2437	-22.54	≤8.00	PASS
		2462	-22.76	≤8.00	PASS

Note: The Duty Cycle Factor (refer to section 7.5) had already compensated to the test data.

### 11.4.2. Test Graphs

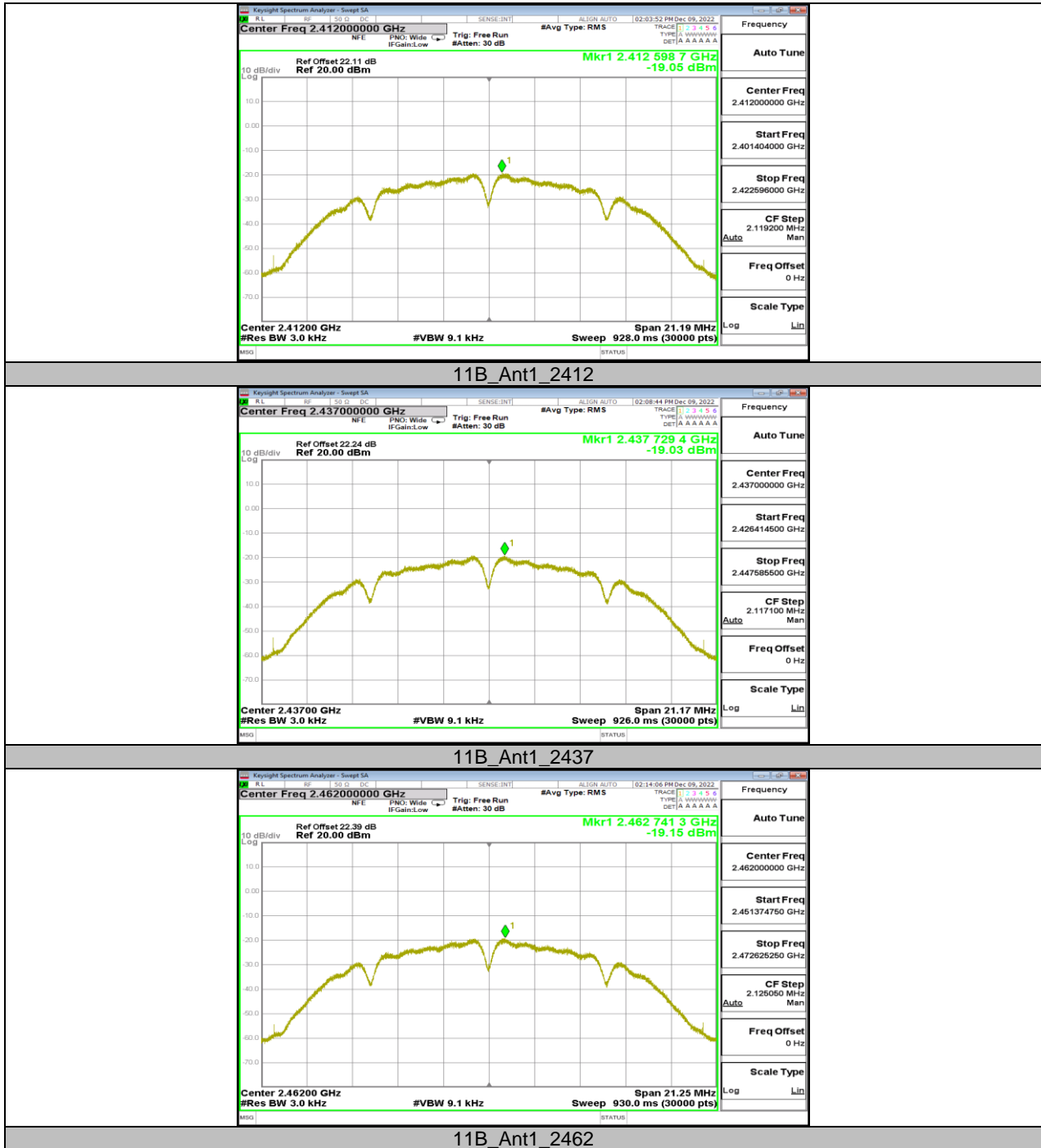

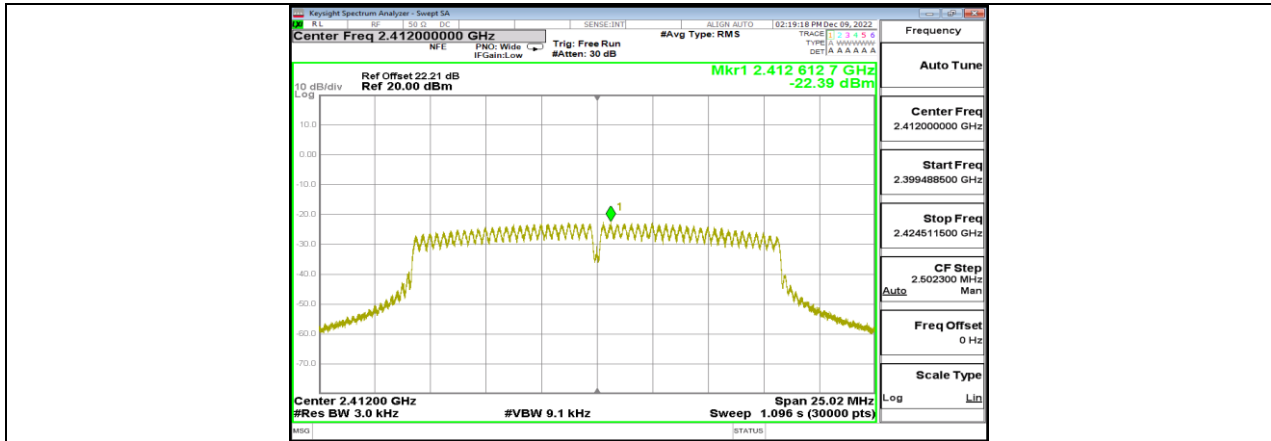

11G\_Ant1\_2412

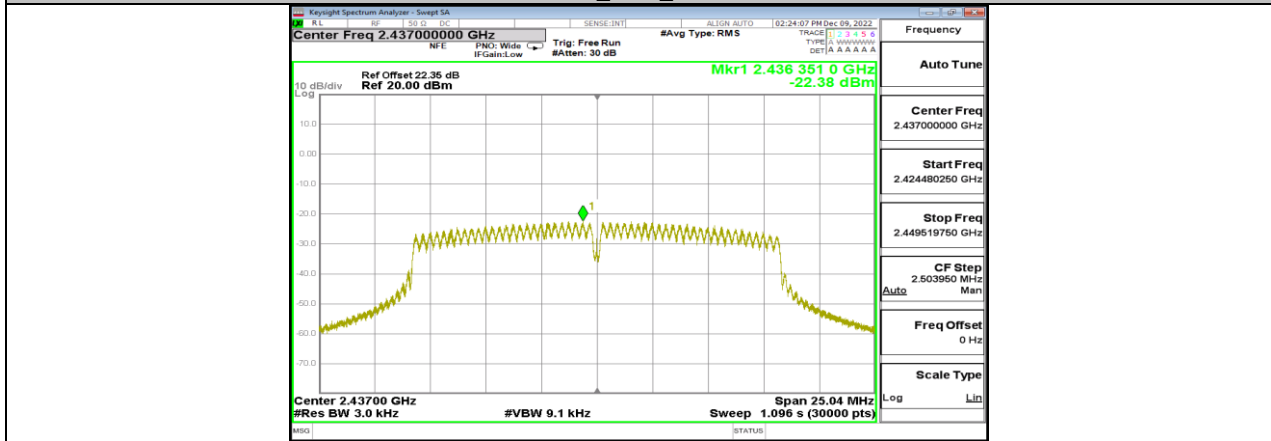

11G\_Ant1\_2437

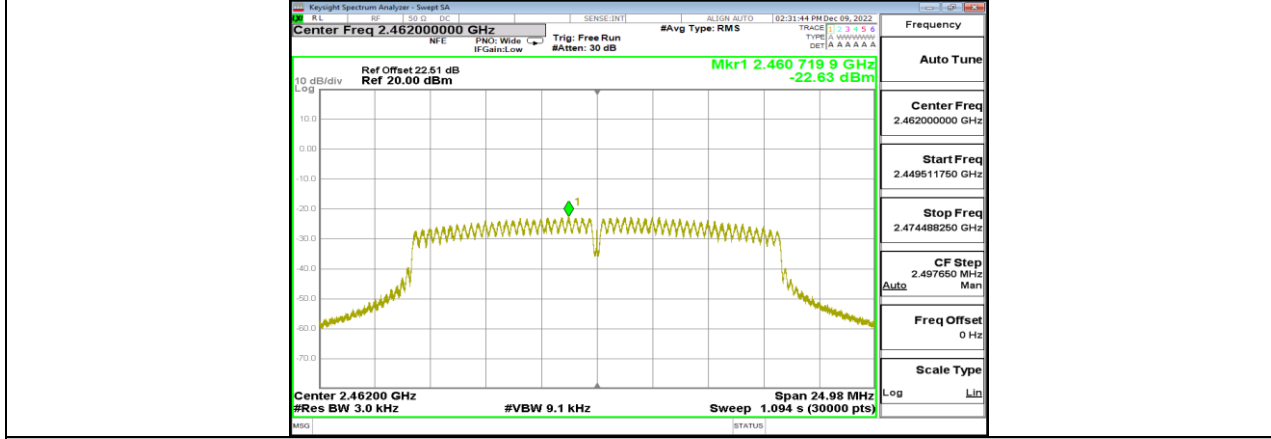

11G\_Ant1\_2462

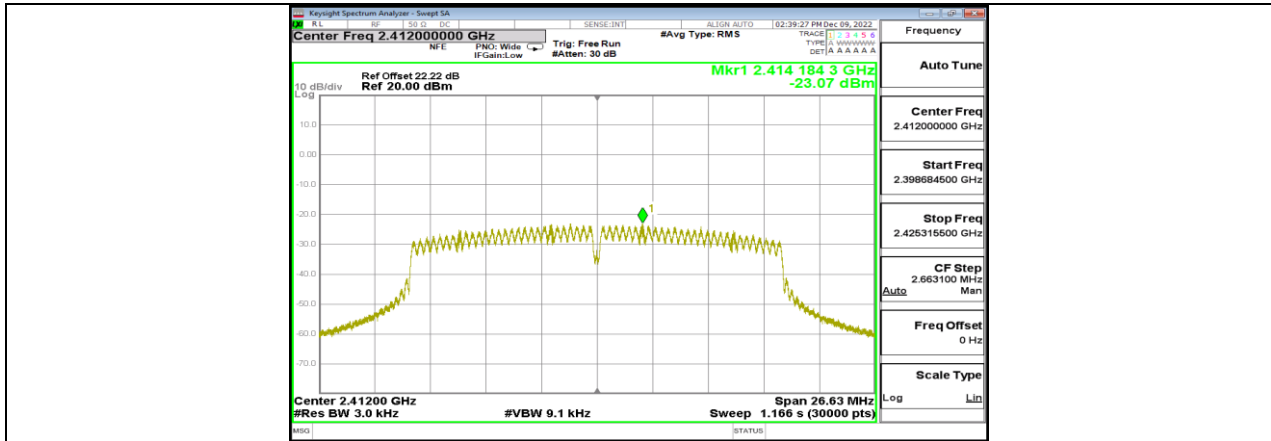

11N20SISO\_Ant1\_2412

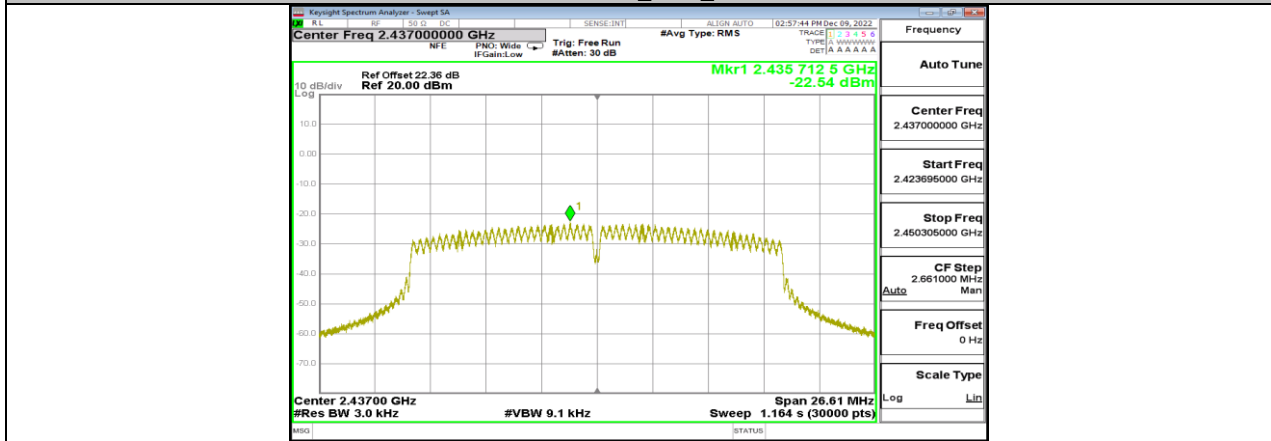

11N20SISO\_Ant1\_2437

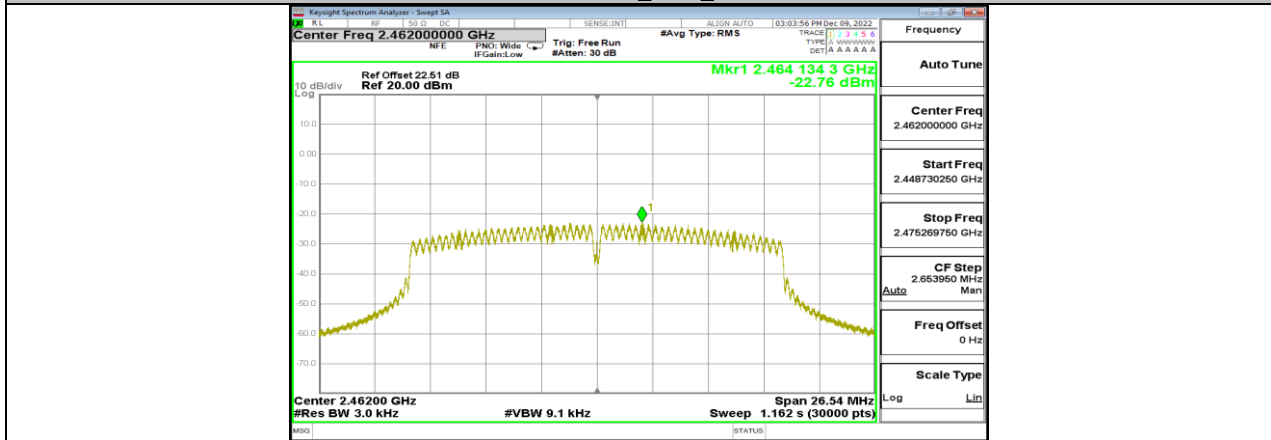

11N20SISO\_Ant1\_2462



## 11.5. APPENDIX E: BAND EDGE MEASUREMENTS

### 11.5.1. Test Result

Test Mode	Antenna	ChName	Channel	RefLevel[dBm]	Result[dBm]	Limit[dBm]	Verdict
11B	Ant1	Low	2412	3.75	-38.21	≤-26.25	PASS
		High	2462	3.64	-37.46	≤-26.36	PASS
11G	Ant1	Low	2412	-0.06	-32.66	≤-30.06	PASS
		High	2462	0.48	-37.45	≤-29.52	PASS
11N20SISO	Ant1	Low	2412	-0.49	-33.74	≤-30.49	PASS
		High	2462	-0.24	-37.26	≤-30.24	PASS

### 11.5.2. Test Graphs

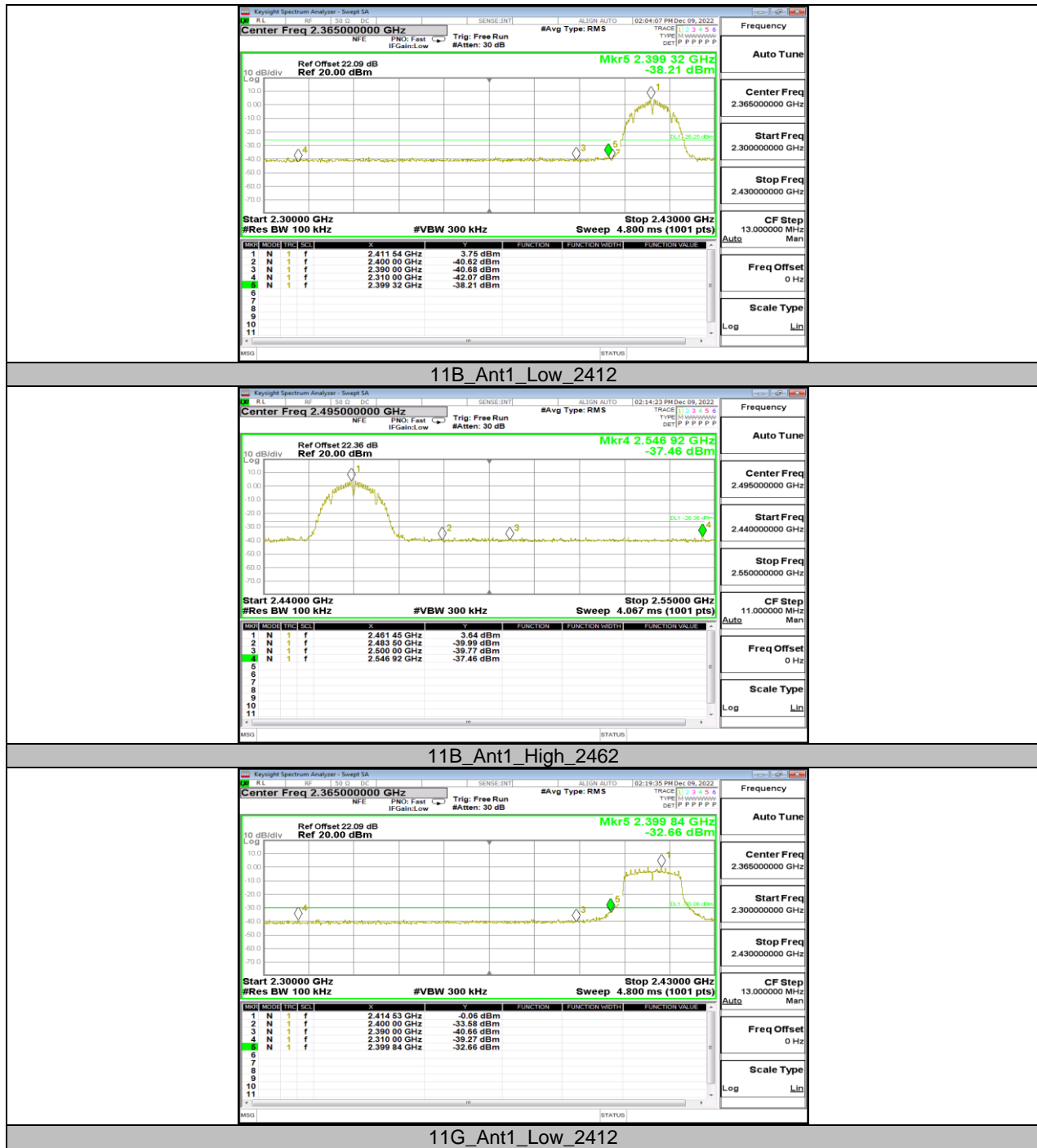



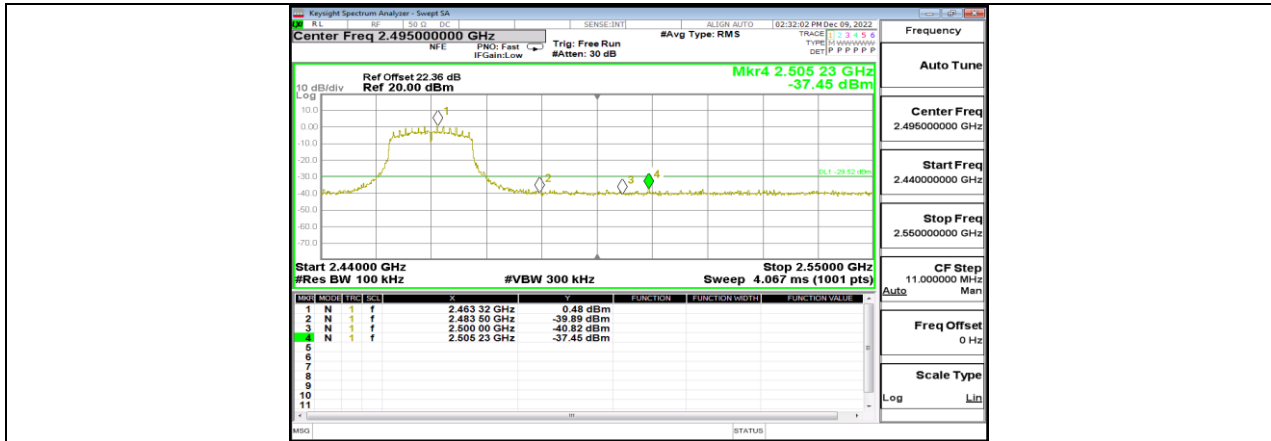

11G\_Ant1\_High\_2462

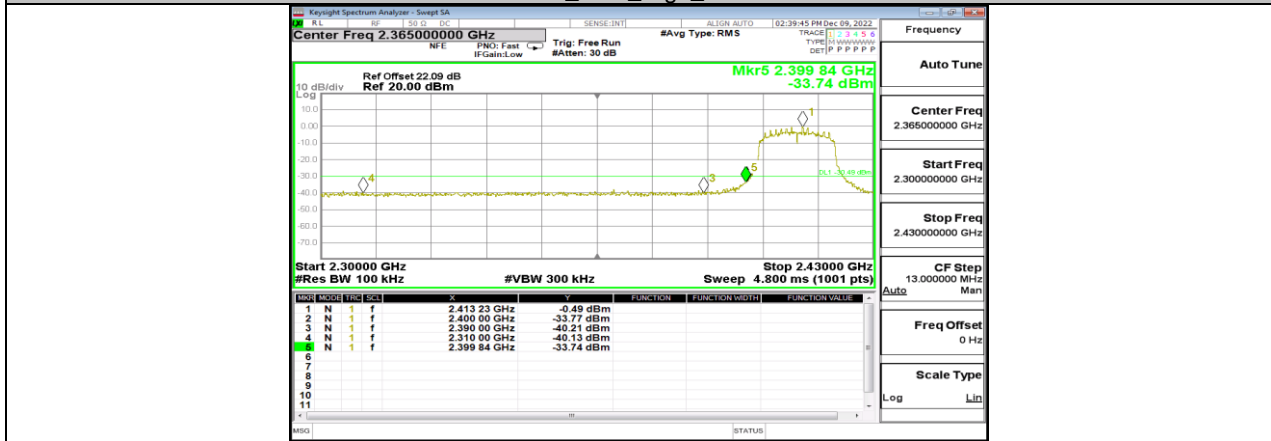

11N20SISO\_Ant1\_Low\_2412



11N20SISO\_Ant1\_High\_2462

**11.6. APPENDIX F: CONDUCTED SPURIOUS EMISSION****11.6.1. Test Result**

Test Mode	Antenna	Channel	FreqRange [Mhz]	Result [dBm]	Limit [dBm]	Verdict
11B	Ant1	2412	Reference	3.80	---	PASS
			30~1000	-49.46	≤-26.2	PASS
			1000~26500	-41.92	≤-26.2	PASS
		2437	Reference	3.54	---	PASS
			30~1000	-49.17	≤-26.46	PASS
			1000~26500	-42.43	≤-26.46	PASS
		2462	Reference	3.57	---	PASS
			30~1000	-49.82	≤-26.43	PASS
			1000~26500	-40.79	≤-26.43	PASS
11G	Ant1	2412	Reference	-0.34	---	PASS
			30~1000	-49.74	≤-30.34	PASS
			1000~26500	-41.88	≤-30.34	PASS
		2437	Reference	-0.09	---	PASS
			30~1000	-49.16	≤-30.09	PASS
			1000~26500	-41.76	≤-30.09	PASS
		2462	Reference	0.42	---	PASS
			30~1000	-49.36	≤-29.58	PASS
			1000~26500	-41.08	≤-29.58	PASS
11N20SISO	Ant1	2412	Reference	-0.20	---	PASS
			30~1000	-49.3	≤-30.2	PASS
			1000~26500	-41.66	≤-30.2	PASS
		2437	Reference	-0.59	---	PASS
			30~1000	-49.1	≤-30.59	PASS
			1000~26500	-41.37	≤-30.59	PASS
		2462	Reference	-0.37	---	PASS
			30~1000	-49.69	≤-30.37	PASS
			1000~26500	-40.85	≤-30.37	PASS



### 11.6.2. Test Graphs



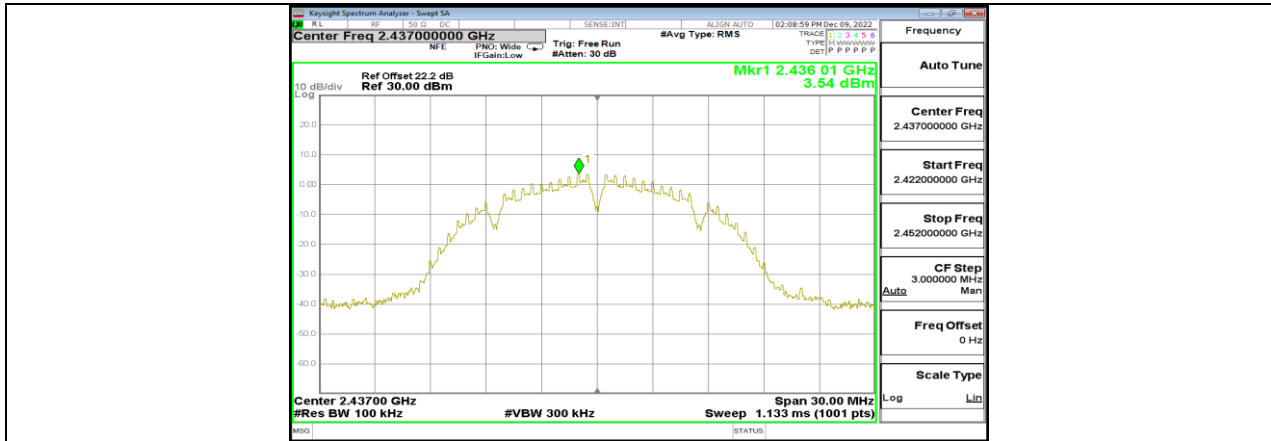

11B\_Ant1\_2437\_0~Reference

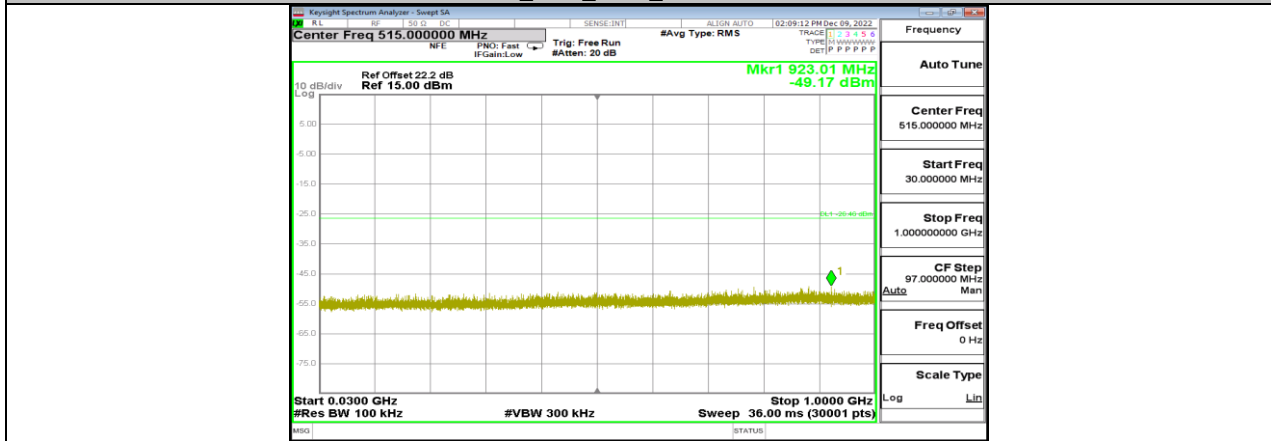

11B\_Ant1\_2437\_30~1000

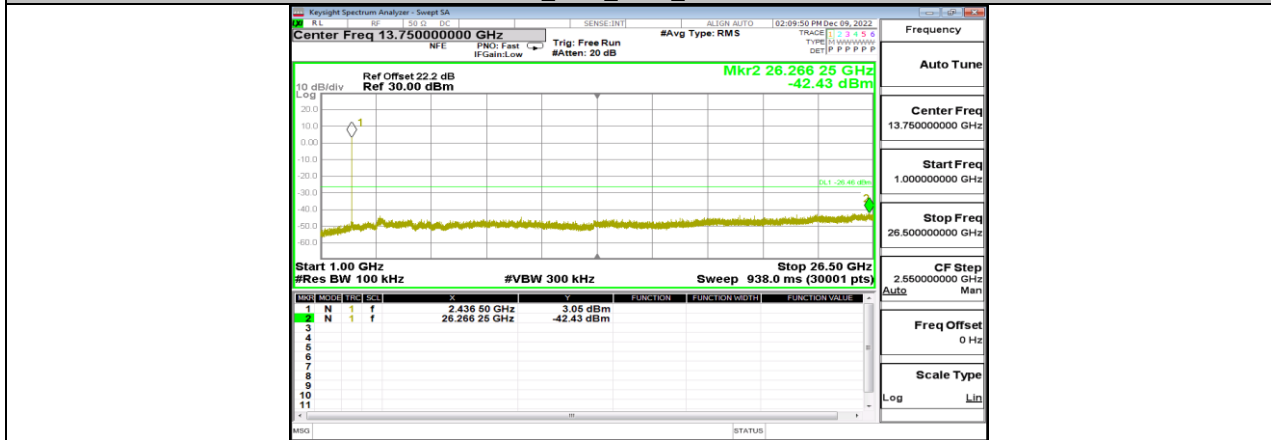

11B\_Ant1\_2437\_1000~26500