



**CFR 47 FCC PART 15 SUBPART C
ISED RSS-210 ISSUE 10**

TEST REPORT

For

ATARI COUCH CADE/PAC-MAN COUCH CADE

**FCC MODEL NUMBER: PAC-E-20640/PAC-E-22600/PAC-E-22820/ATR-E-
20650/ATR-E-22590/ATR-E-22810**

IC MODEL NUMBER: PAC-E-20640/PAC-E-22820/ATR-E-20650/ATR-E-22810

FCC ID: 2APXHCOUCH

IC: 24128-COUCH

REPORT NUMBER: 4790176660-1

ISSUE DATE: December 20, 2021

Prepared for

**WF TASTEMAKERS TRADING LIMITED (FCC)
Unit 05 and unit 06, 6th Floor, Greenfield Tower Concordia Plaza, 1 Science
Museum Road, TST East, Hong Kong**

**WF Tastemakers Trading Limited (ISED)
980 Avenue of the Americas, 3rd Floor
New York NY 10018 United States Of America (Excluding The States Of
Alaska)**

Prepared by

**UL Verification Services (Guangzhou) Co., Ltd, Song Shan Lake Branch
Building 10, Innovation Technology Park, No. 1, Li Bin Road, Song Shan Lake Hi-
Tech Development Zone Dongguan, 523808, People's Republic of China
Tel: +86 769 22038881
Fax: +86 769 33244054
Website: www.ul.com**

The results reported herein have been performed in accordance with the laboratory's terms of accreditation. This report shall not be reproduced except in full without the written approval of the Laboratory. The results in this report apply to the test sample(s) mentioned above at the time of the testing period only and are not to be used to indicate applicability to other similar products.



Revision History

<u>Rev.</u>	<u>Issue Date</u>	<u>Revisions</u>	<u>Revised By</u>
V0	12/09/2021	Initial Issue	
V1	12/20/2021	Added new series modes	Denny Huang



Summary of Test Results			
Clause	Test Items	FCC/ISED Rules	Test Results
1	20dB Bandwidth and 99% Occupied Bandwidth	CFR 47 FCC §15.215 (c) ISED RSS-Gen Clause 6.7	Pass
2	Radiated Emission	CFR 47 FCC §15.249 (a)(d)(e) ISED RSS-210 Annex B B.10 CFR 47 FCC §15.205 and §15.209 RSS-GEN Clause 8.9 RSS-GEN Clause 8.10	Pass
3	Conducted Emission Test for AC Power Port	FCC Part 15.207 RSS-GEN Clause 8.8	Pass
4	Antenna Requirement	CFR 47 FCC §15.203 RSS-GEN Clause 6.8	Pass
Note 1: This test report is only published to and used by the applicant, and it is not for evidence purpose in China.			
Note 2: The measurement result for the sample received is <Pass> according to < CFR 47 FCC PART 15 SUBPART C, ISED RSS-210 Issue 10 and ISED RSS-GEN Issue 5 > when <Accuracy Method> decision rule is applied.			



TABLE OF CONTENTS

1. ATTESTATION OF TEST RESULTS	5
2. TEST METHODOLOGY	7
3. FACILITIES AND ACCREDITATION	7
4. CALIBRATION AND UNCERTAINTY	8
4.1. <i>MEASURING INSTRUMENT CALIBRATION</i>	<i>8</i>
4.2. <i>MEASUREMENT UNCERTAINTY.....</i>	<i>8</i>
5. EQUIPMENT UNDER TEST	9
5.1. <i>DESCRIPTION OF EUT</i>	<i>9</i>
5.2. <i>MAXIMUM FIELD STRENGTH.....</i>	<i>9</i>
5.3. <i>CHANNEL LIST.....</i>	<i>9</i>
5.4. <i>DESCRIPTION OF AVAILABLE ANTENNAS</i>	<i>10</i>
5.5. <i>TEST CHANNEL CONFIGURATION.....</i>	<i>10</i>
5.6. <i>THE WORSE CASE POWER SETTING PARAMETER.....</i>	<i>10</i>
5.7. <i>TEST ENVIRONMENT</i>	<i>10</i>
5.8. <i>DESCRIPTION OF TEST SETUP.....</i>	<i>11</i>
5.9. <i>MEASURING INSTRUMENT AND SOFTWARE USED.....</i>	<i>12</i>
6. ANTENNA PORT TEST RESULTS	13
6.1. <i>ON TIME AND DUTY CYCLE.....</i>	<i>13</i>
6.2. <i>20 dB BANDWIDTH AND 99% OCCUPIED BANDWIDTH</i>	<i>15</i>
7. RADIATED TEST RESULTS.....	19
7.1. <i>LIMITS AND PROCEDURE</i>	<i>19</i>
7.2. <i>RESTRICTED BANDEDGE AND FIELD STRENGTH OF INTENTIONAL EMISSIONS</i> <i>27</i>	
7.3. <i>SPURIOUS EMISSIONS (1 ~ 3 GHz).....</i>	<i>33</i>
7.4. <i>SPURIOUS EMISSIONS (3 ~ 18 GHz).....</i>	<i>39</i>
7.5. <i>SPURIOUS EMISSIONS (18 ~ 26 GHz).....</i>	<i>45</i>
7.6. <i>SPURIOUS EMISSIONS BELOW 30 MHz</i>	<i>47</i>
7.7. <i>SPURIOUS EMISSIONS BELOW 1 GHz AND ABOVE 30 MHz.....</i>	<i>50</i>
8. AC POWER LINE CONDUCTED EMISSIONS	52
9. ANTENNA REQUIREMENTS.....	56



1. ATTESTATION OF TEST RESULTS

FCC

Applicant Information

Company Name: WF TASTEMAKERS TRADING LIMITED
Address: Unit 05 and unit 06, 6th Floor, Greenfield Tower Concordia Plaza,
1 Science Museum Road, TST East, Hong Kong

ISED

Applicant Information

Company Name: WF Tastemakers Trading Limited
Address: 980 Avenue of the Americas, 3rd Floor
New York NY 10018 United States Of America (Excluding The
States Of Alaska)

FCC

Manufacturer Information

Company Name: WF TASTEMAKERS TRADING LIMITED
Address: Unit 05 and unit 06, 6th Floor, Greenfield Tower Concordia Plaza,
1 Science Museum Road, TST East, Hong Kong

ISED

Manufacturer Information

Company Name: WF Tastemakers Trading Limited
Address: 980 Avenue of the Americas, 3rd Floor
New York NY 10018 United States Of America (Excluding The
States Of Alaska)

EUT Information

EUT Name: ATARI COUCH CADE/PAC-MAN COUCH CADE
FCC Model: PAC-E-20640/PAC-E-22600/PAC-E-22820/ATR-E-20650/ATR-E-
22590/ATR-E-22810
IC Model: PAC-E-20640/PAC-E-22820/ATR-E-20650/ATR-E-22810
Model Difference: Please refer to clause 5.1 DESCRIPTION OF EUT
Brand: ARCADE 1 UP
Sample Received Date: November 11, 2021
Sample Status: Normal
Sample ID: 4385027
Date of Tested: November 15, 2021 ~ December 9, 2021

APPLICABLE STANDARDS	
STANDARD	TEST RESULTS
CFR 47 FCC PART 15 SUBPART C	PASS
ISED RSS-210 Issue 10	PASS
ISED RSS-GEN Issue 5	PASS



Prepared By:

Denny Huang

Denny Huang
Project Engineer

Checked By:

Shawn Wen

Shawn Wen
Laboratory Leader

Approved By:

Stephen Guo

Stephen Guo
Laboratory Manager



2. TEST METHODOLOGY

The tests documented in this report were performed in accordance with KDB 414788 D01 Radiated Test Site v01r01, FCC CFR 47 Part 2, FCC CFR 47 Part 15, ANSI C63.10-2013, ISED RSS-210 Issue 10 and RSS-GEN Issue 5.

3. FACILITIES AND ACCREDITATION

Accreditation Certificate	<p>A2LA (Certificate No.: 4102.01) UL Verification Services (Guangzhou) Co., Ltd. Song Shan Lake Branch. has been assessed and proved to be in compliance with A2LA.</p> <p>FCC (FCC Designation No.: CN1187) UL Verification Services (Guangzhou) Co., Ltd. Song Shan Lake Branch. Has been recognized to perform compliance testing on equipment subject to the Commission's Declaration of Conformity (DoC) and Certification rules.</p> <p>ISED (Company No.: 21320) UL Verification Services (Guangzhou) Co., Ltd. Song Shan Lake Branch. has been registered and fully described in a report filed with ISED. The Company Number is 21320 and the test lab Conformity Assessment Body Identifier (CABID) is CN0046.</p> <p>VCCI (Registration No.: G-20019, R-20004, C-20012 and T-20011) UL Verification Services (Guangzhou) Co., Ltd. Song Shan Lake Branch. has been assessed and proved to be in compliance with VCCI, the Membership No. is 3793. Facility Name: Chamber D, the VCCI registration No. is G-20019 and R-20004 Shielding Room B , the VCCI registration No. is C-20012 and T-20011</p>
---------------------------	--

Note:

1. All tests measurement facilities use to collect the measurement data are located at Building 10, Innovation Technology Park, Song Shan Lake Hi tech Development Zone, Dongguan, 523808, China
2. The test anechoic chamber in UL Verification Services (Guangzhou) Co., Ltd. Song Shan Lake Branch had been calibrated and compared to the open field sites and the test anechoic chamber is shown to be equivalent to or worst case from the open field site.
3. For below 30MHz, lab had performed measurements at test anechoic chamber and comparing to measurements obtained on an open field site. And these measurements below 30MHz had been correlated to measurements performed on an OFS.



4. CALIBRATION AND UNCERTAINTY

4.1. MEASURING INSTRUMENT CALIBRATION

The measuring equipment utilized to perform the tests documented in this report has been calibrated in accordance with the manufacturer's recommendations and is traceable to recognized national standards.

4.2. MEASUREMENT UNCERTAINTY

Where relevant, the following measurement uncertainty levels have been estimated for tests performed on the apparatus:

Test Item	Uncertainty
Conduction emission	3.62 dB
Radiation Emission test (include Fundamental emission) (9 kHz ~ 30 MHz)	2.2 dB
Radiation Emission test (include Fundamental emission) (30 MHz ~ 1 GHz)	4.00 dB
Radiation Emission test (1 GHz ~ 26 GHz) (include Fundamental emission)	5.78 dB (1 GHz ~ 18 GHz)
	5.23 dB (18 GHz ~ 26 GHz)
Note: This uncertainty represents an expanded uncertainty expressed at approximately the 95% confidence level using a coverage factor of k=2.	

5. EQUIPMENT UNDER TEST

5.1. DESCRIPTION OF EUT

EUT Name	ATARI COUCH CADE/PAC-MAN COUCH CADE	
FCC Model	PAC-E-20640/PAC-E-22600/PAC-E-22820/ATR-E-20650/ATR-E-22590/ATR-E-22810	
IC Model	PAC-E-20640/PAC-E-22820/ATR-E-20650/ATR-E-22810	
Model Difference	<p>PAC-E-22600, PAC-E-22820, ATR-E-20650, ATR-E-22590 and ATR-E-22810 have the same technical construction including circuit diagram, PCB Layout, components and component layout, all electrical construction and mechanical construction with PAC-E-20640. The difference lies only the appearance and software. Big difference on Software is that contain with difference game, and appearance is that one is Trackball, and other is joystick.</p> <p>There is no change for the RF characteristics and setting. The RF performance is same.</p> <p>Model PAC-E-20640 is identical to Model PAC-E-22600/PAC-E-22820 except for the model number.</p> <p>Model ATR-E-20650 is identical to Model ATR-E-22590/ATR-E-22810 except for the model number.</p> <p>Pre-scan had been done for all the models listed above, only the worst data (PAC-E-20640) was recorded in the report.</p>	
Product Description	Operation Frequency	2405 MHz ~ 2475 MHz
	Modulation Type	GFSK
Battery	DC 6 V by battery or DC 5 V by USB	

5.2. MAXIMUM FIELD STRENGTH

Frequency (MHz)	Channel Number	Max Peak field strength (dB μ V/m)
2405	1[15]	71.23

5.3. CHANNEL LIST

Channel	Frequency (MHz)	Channel	Frequency (MHz)	Channel	Frequency (MHz)	Channel	Frequency (MHz)
1	2405	5	2425	9	2445	13	2465
2	2410	6	2430	10	2450	14	2470
3	2415	7	2435	11	2455	15	2475
4	2420	8	2440	12	2460	/	/

5.4. DESCRIPTION OF AVAILABLE ANTENNAS

Ant.	Frequency (MHz)	Antenna Type	Antenna Gain (dBi)
1	2405 ~ 2475	Integral antenna	1.21

Test Mode	Transmit and Receive Mode	Description
GFSK	<input checked="" type="checkbox"/> 1TX	Antenna 1 can be used as transmitting antenna.

Note: The Antenna gain was provided by customer.

5.5. TEST CHANNEL CONFIGURATION

Test Mode	Test Channel	Frequency
GFSK	CH 1, CH 8, CH 15	2405 MHz, 2440 MHz, 2475 MHz

5.6. THE WORSE CASE POWER SETTING PARAMETER

The Worst Case Power Setting Parameter under 2405 MHz ~ 2475 MHz Band				
Test Software Version		/		
Modulation Type	Transmit Antenna Number	Test Channel		
		CH 1	CH 8	CH 15
GFSK	1	Default	Default	Default

5.7. TEST ENVIRONMENT

Environment Parameter	Selected Values During Tests	
Relative Humidity	55 ~ 65 %	
Atmospheric Pressure:	1025 Pa	
Temperature	TN	22 ~ 28 °C
	VL	/
Voltage:	VN	DC 5 V
	VH	/

Note: VL= Lower Extreme Test Voltage
 VN= Nominal Voltage
 VH= Upper Extreme Test Voltage
 TN= Normal Temperature

5.8. DESCRIPTION OF TEST SETUP

SUPPORT EQUIPMENT

Item	Equipment	Brand Name	Model Name	Remarks
1	AC Adapter	/	CLV-003	Input: AC 120-240 V, 50/60 Hz Output: DC 5.0 V, 1.5 A

I/O CABLES

Cable No	Port	Connector Type	Cable Type	Cable Length(m)	Remarks
1	USB	/	Unshielded	1.0	/

ACCESSORY

Item	Equipment	Mfr/Brand	Model/Type No.	Specification	Series No.
/	/	/	/	/	/

TEST SETUP

The EUT have the engineer mode inside.
The battery was fully charged before test.

Note: Both the battery mode and adapter mode had been tested, but only the worst date was recorded in the report.

SETUP DIAGRAM FOR TEST

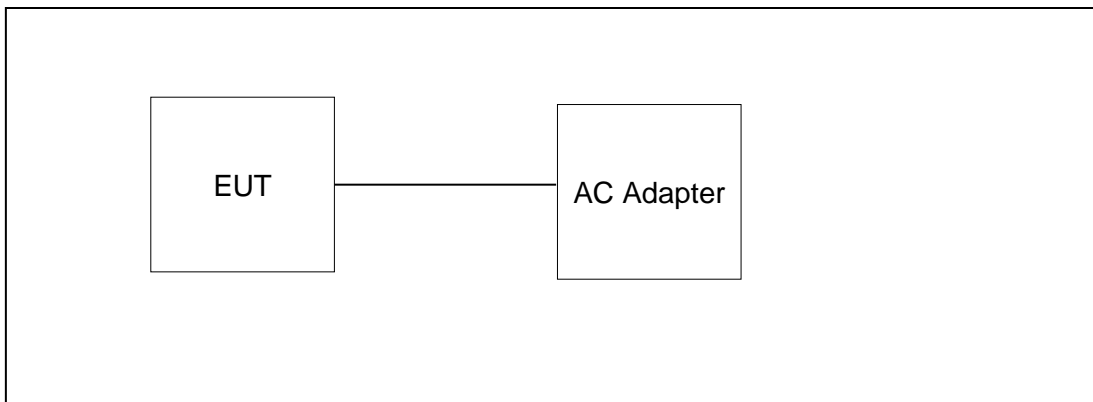

Note: Both the battery mode and adapter mode had been tested, but only the worst date was recorded in the report.

**5.9. MEASURING INSTRUMENT AND SOFTWARE USED**

Conducted Emissions					
Equipment	Manufacturer	Model No.	Serial No.	Last Cal.	Due Date
EMI Test Receiver	R&S	ESR3	101961	Oct.30, 2021	Oct.29, 2022
Artificial Mains Networks	Schwarzbeck	NSLK 8126	8126465	Oct.30, 2021	Oct.29, 2022
Software					
Description		Manufacturer	Name	Version	
Test Software for Conducted Emissions		Farad	EZ-EMC	Ver. UL-3A1	

Radiated Emissions					
Equipment	Manufacturer	Model No.	Serial No.	Last Cal.	Due Date
MXE EMI Receiver	KESIGHT	N9038A	MY56400036	Oct.30, 2021	Oct.29, 2022
Hybrid Log Periodic Antenna	TDK	HLP-3003C	130960	Aug.02, 2021	Aug.01, 2024
Preamplifier	HP	8447D	2944A09099	Oct.30, 2021	Oct.29, 2022
EMI Measurement Receiver	R&S	ESR26	101377	Oct.30, 2021	Oct.29, 2022
Horn Antenna	TDK	HRN-0118	130940	July 20, 2021	July 19, 2024
Preamplifier	TDK	PA-02-0118	TRS-305-00067	Oct.30, 2021	Oct.29, 2022
Horn Antenna	Schwarzbeck	BBHA9170	697	July 20, 2021	July 19, 2024
Preamplifier	TDK	PA-02-2	TRS-307-00003	Oct.31, 2021	Oct.30, 2022
Preamplifier	TDK	PA-02-3	TRS-308-00002	Oct.31, 2021	Oct.30, 2022
Loop antenna	Schwarzbeck	1519B	00008	Jan.17, 2019	Jan.17,2022
Preamplifier	TDK	PA-02-001-3000	TRS-302-00050	Oct.31, 2021	Oct.30, 2022
High Pass Filter	Wi	WHKX10-2700-3000-18000-40SS	23	Oct.31, 2021	Oct.30, 2022
Band Reject Filter	Wainwright	WRCJV8-2350-2400-2483.5-2533.5-40SS	4	Oct.31, 2021	Oct.30, 2022
Signal Analyzer	R&S	FSV40	101118	Oct.30, 2021	Oct.29, 2022
Software					
Description		Manufacturer	Name	Version	
Test Software for Radiated Emissions		Farad	EZ-EMC	Ver. UL-3A1	

6. ANTENNA PORT TEST RESULTS

6.1. ON TIME AND DUTY CYCLE

LIMITS

None; for reporting purposes only

PROCEDURE

KDB 558074 Zero-Span Spectrum Analyzer Method

TEST SETUP

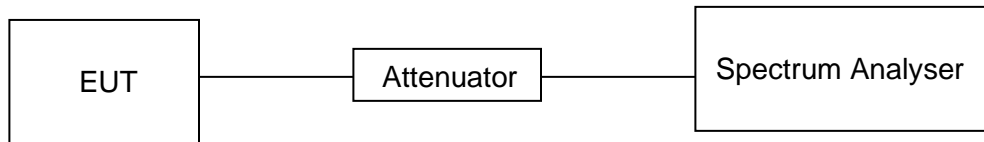

TEST ENVIRONMENT

Temperature	25.5 °C	Relative Humidity	55 %
Atmosphere Pressure	101 kPa	Test Voltage	DC 5 V

RESULTS

Mode	On Time (msec)	Period (msec)	Duty Cycle x (Linear)	Duty Cycle (%)	Duty Cycle Correction Factor (db)
GFSK	100	100	1	100	0

Note: Duty Cycle Correction Factor=20log(x).
Where: x is Duty Cycle



ON TIME AND DUTY CYCLE MID CH PLOT-1

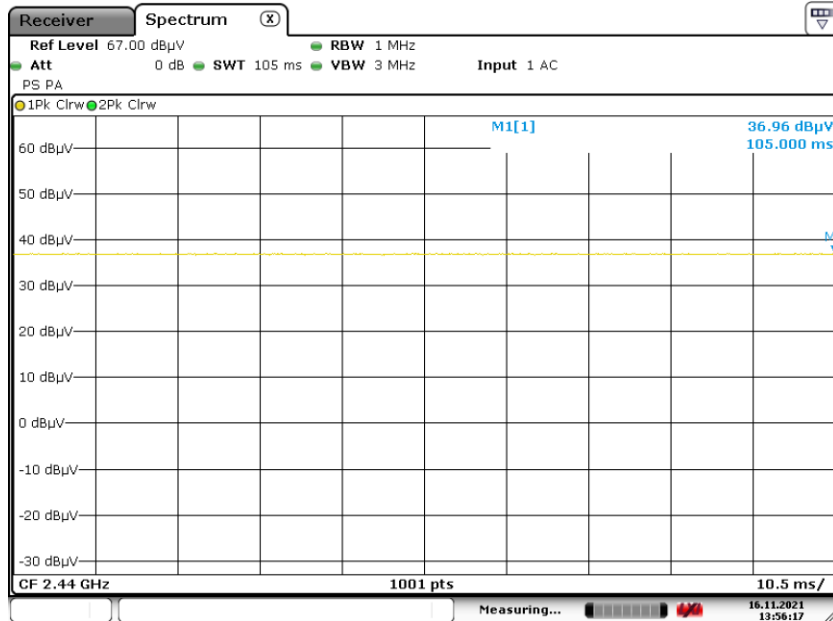

Date: 16.NOV.2021 13:56:17

ON TIME AND DUTY CYCLE MID CH PLOT-2

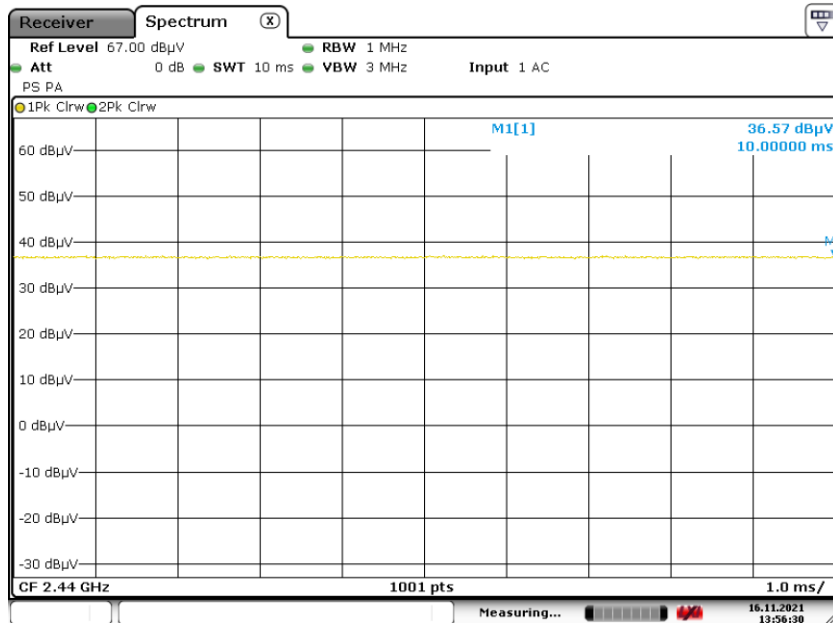

Date: 16.NOV.2021 13:56:30

Note: All the modes had been tested, but only the worst duty cycle recorded in the report.

6.2. 20 dB BANDWIDTH AND 99% OCCUPIED BANDWIDTH

LIMITS

CFR 47 FCC Part15 (15.249) Subpart C RSS-Gen Issue 5			
Section	Test Item	Limit	Frequency Range (MHz)
CFR 47 FCC §15.215 (c)	20dB Bandwidth	for reporting purposes only	2400-2483.5
ISED RSS-Gen Clause 6.7 Issue 5	99% Occupied Bandwidth	For reporting purposes only.	2400-2483.5

TEST PROCEDURE

Connect the UUT to the spectrum analyser and use the following settings:

Center Frequency	The center frequency of the channel under test
Detector	Peak
RBW	1% to 5% of the occupied bandwidth
VBW	approximately 3×RBW
Trace	Max hold
Sweep	Auto couple

Allow the trace to stabilize and measure the maximum width of the emission that is constrained by the frequencies associated with the two outermost amplitude points (upper and lower frequencies) that are attenuated by 6 dB/99% relative to the maximum level measured in the fundamental emission.

TEST SETUP

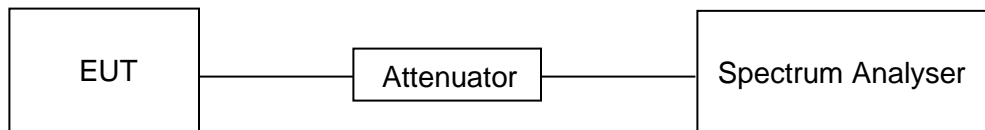

TEST ENVIRONMENT

Temperature	25.5 °C	Relative Humidity	55 %
Atmosphere Pressure	101 kPa	Test Voltage	DC 5 V



RESULTS

Frequency (MHz)	20dB bandwidth (MHz)	99% bandwidth (MHz)	Result
2405	2.56	2.32	PASS

20 dB BANDWIDTH LOW CH

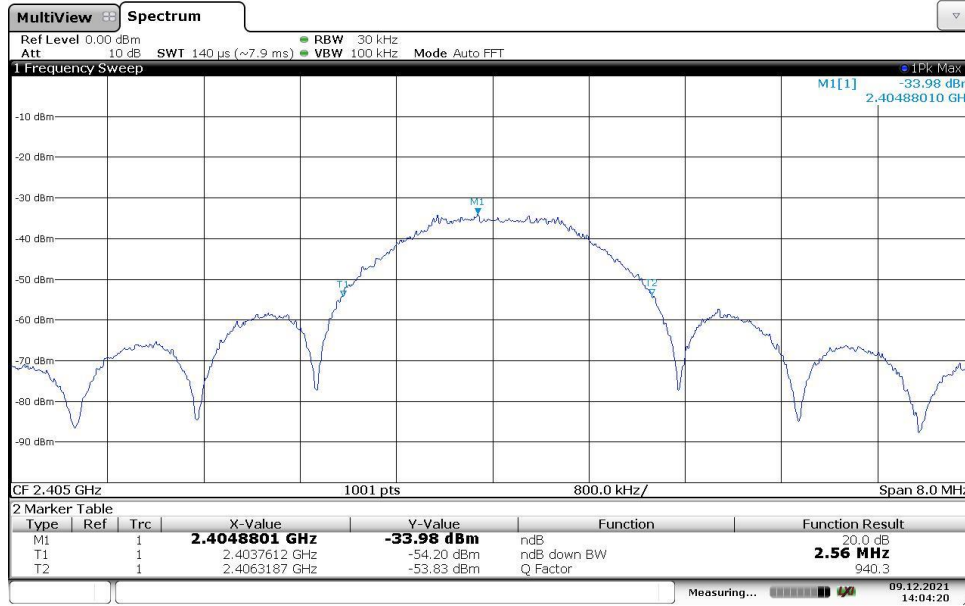

14:04:20 09.12.2021

99% OCCUPIED BANDWIDTH LOW CH



14:02:15 09.12.2021



Frequency (MHz)	20dB bandwidth (MHz)	99% bandwidth (MHz)	Result
2440	2.57	2.33	PASS

20 dB BANDWIDTH MID CH

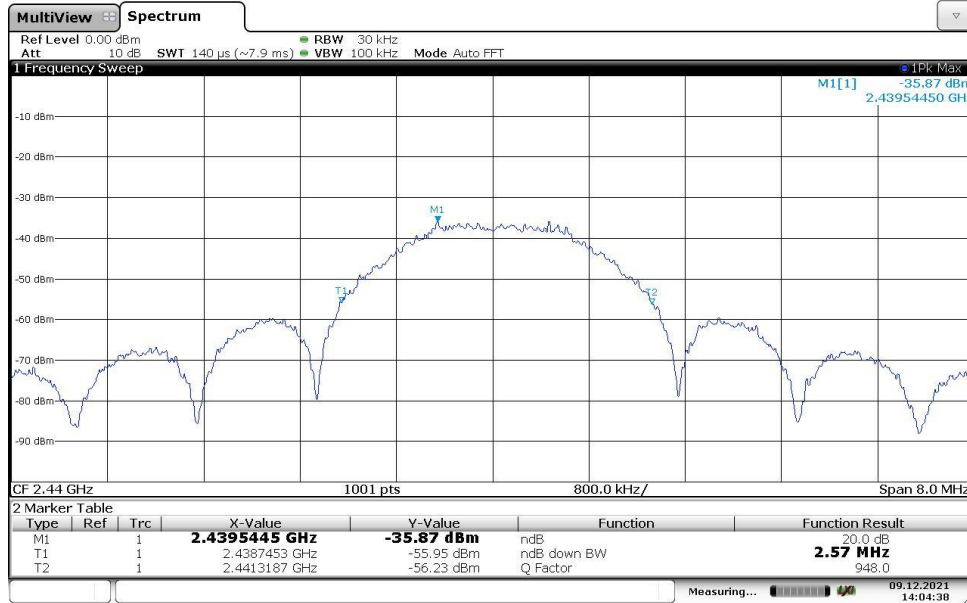

14:04:38 09.12.2021

99% OCCUPIED BANDWIDTH MID CH

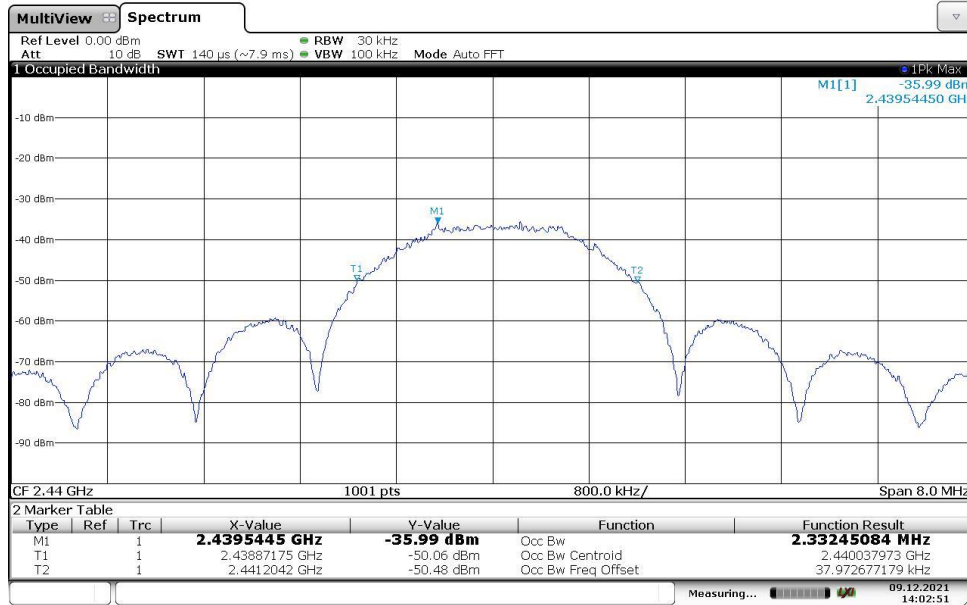

14:02:51 09.12.2021



Frequency (MHz)	20dB bandwidth (MHz)	99% bandwidth (MHz)	Result
2475	2.56	2.35	PASS

20 dB BANDWIDTH HIG CH



14:03:57 09.12.2021

99% OCCUPIED BANDWIDTH HIG CH



14:03:10 09.12.2021



7. RADIATED TEST RESULTS

7.1. LIMITS AND PROCEDURE

LIMITS

CFR 47 FCC §15.205 and §15.209

CFR 47 FCC §15.249 (a)(d)(c)(e)

ISED RSS-210 Issue 10 Annex B B.10

RSS-GEN Clause 8.9

The field strength of emissions from intentional radiators operated within these frequency bands			
Frequency (MHz)	Field strength of Fundamental	Field strength of Harmonics	Distance (m)
902 - 928	50 mV/m (94dBuV/m)	500 uV/m (54dBuV/m)	3
2400 – 2483.5	50 mV/m (94dBuV/m)	500 uV/m (54dBuV/m)	3
5725 – 5875	50 mV/m (94dBuV/m)	500 uV/m (54dBuV/m)	3

Emissions radiated outside of the specified frequency bands above 30MHz			
Frequency Range (MHz)	Field Strength Limit (uV/m) at 3 m	Field Strength Limit (dBuV/m) at 3 m	
		Quasi-Peak	
30 - 88	100	40	
88 - 216	150	43.5	
216 - 960	200	46	
Above 960	500	54	
Above 1000	500	Peak	Average
		74	54

FCC Emissions radiated outside of the specified frequency bands below 30MHz		
Frequency (MHz)	Field strength (microvolts/meter)	Measurement distance (meters)
0.009-0.490	2400/F(kHz)	300
0.490-1.705	24000/F(kHz)	30
1.705-30.0	30	30

ISED General field strength limits at frequencies below 30 MHz

Table 6 – General field strength limits at frequencies below 30 MHz

Frequency	Magnetic field strength (H-Field) (µA/m)	Measurement distance (m)
9 - 490 kHz ^{Note 1}	6.37/F (F in kHz)	300
490 - 1705 kHz	63.7/F (F in kHz)	30
1.705 - 30 MHz	0.08	30

Note 1: The emission limits for the ranges 9-90 kHz and 110-490 kHz are based on measurements employing a linear average detector.

IC Restricted bands please refer to ISED RSS-GEN Clause 8.10

Table 7 – Restricted frequency bands^{Note 1}

MHz	MHz	GHz
0.090 - 0.110	149.9 - 150.05	9.0 - 9.2
0.495 - 0.505	156.52475 - 156.52525	9.3 - 9.5
2.1735 - 2.1905	156.7 - 156.9	10.6 - 12.7
3.020 - 3.026	162.0125 - 167.17	13.25 - 13.4
4.125 - 4.128	167.72 - 173.2	14.47 - 14.5
4.17725 - 4.17775	240 - 285	15.35 - 16.2
4.20725 - 4.20775	322 - 335.4	17.7 - 21.4
5.677 - 5.683	399.9 - 410	22.01 - 23.12
6.215 - 6.218	608 - 614	23.6 - 24.0
6.26775 - 6.26825	960 - 1427	31.2 - 31.8
6.31175 - 6.31225	1435 - 1626.5	36.43 - 36.5
8.291 - 8.294	1645.5 - 1646.5	Above 38.6
8.362 - 8.366	1660 - 1710	
8.37625 - 8.38675	1718.8 - 1722.2	
8.41425 - 8.41475	2200 - 2300	
12.29 - 12.293	2310 - 2390	
12.51975 - 12.52025	2483.5 - 2500	
12.57675 - 12.57725	2655 - 2900	
13.36 - 13.41	3260 - 3267	
16.42 - 16.423	3332 - 3339	
16.69475 - 16.69525	3345.8 - 3358	
16.80425 - 16.80475	3500 - 4400	
25.5 - 25.67	4500 - 5150	
37.5 - 38.25	5350 - 5460	
73 - 74.6	7250 - 7750	
74.8 - 75.2	8025 - 8500	
108 - 138		

Note 1: Certain frequency bands listed in table 7 and in bands above 38.6 GHz are designated for licence-exempt applications. These frequency bands and the requirements that apply to related devices are set out in the 200 and 300 series of RSSs.



FCC Restricted bands of operation:

MHz	MHz	MHz	GHz
0.090-0.110	16.42-16.423	399.9-410	4.5-5.15
¹ 0.495-0.505	16.69475-16.69525	608-614	5.35-5.46
2.1735-2.1905	16.80425-16.80475	960-1240	7.25-7.75
4.125-4.128	25.5-25.67	1300-1427	8.025-8.5
4.17725-4.17775	37.5-38.25	1435-1626.5	9.0-9.2
4.20725-4.20775	73-74.6	1645.5-1646.5	9.3-9.5
6.215-6.218	74.8-75.2	1660-1710	10.6-12.7
6.26775-6.26825	108-121.94	1718.8-1722.2	13.25-13.4
6.31175-6.31225	123-138	2200-2300	14.47-14.5
8.291-8.294	149.9-150.05	2310-2390	15.35-16.2
8.362-8.366	156.52475-156.52525	2483.5-2500	17.7-21.4
8.37625-8.38675	156.7-156.9	2690-2900	22.01-23.12
8.41425-8.41475	162.0125-167.17	3260-3267	23.6-24.0
12.29-12.293	167.72-173.2	3332-3339	31.2-31.8
12.51975-12.52025	240-285	3345.8-3358	36.43-36.5
12.57675-12.57725	322-335.4	3600-4400	(²)
13.36-13.41			

Note: ¹Until February 1, 1999, this restricted band shall be 0.490-0.510 MHz.
²Above 38.6c

TEST SETUP AND PROCEDURE

Below 30MHz

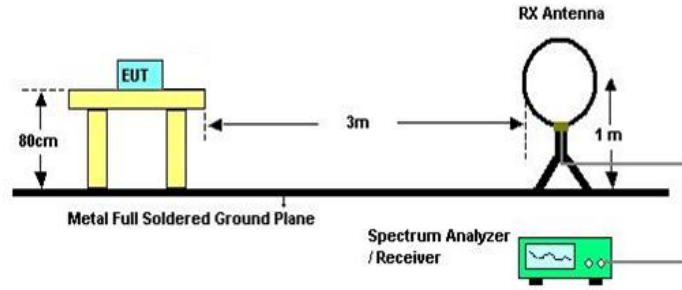

The setting of the spectrum analyser

RBW	200 Hz (From 9 kHz to 0.15 MHz)/ 9 kHz (From 0.15 MHz to 30 MHz)
VBW	200 Hz (From 9 kHz to 0.15 MHz)/ 9 kHz (From 0.15 MHz to 30 MHz)
Sweep	Auto
Detector	Peak/QP/ Average
Trace	Max hold

1. The testing follows the guidelines in ANSI C63.10-2013.
2. The EUT was arranged to its worst case and then turntable (from 0 degree to 360 degrees) to find the maximum reading. A pre-amp and a high pass filter are used for the test in order to get better signal level. Both Horizontal, Face-on and Face-off polarizations of the antenna are set to make the measurement.
3. The EUT was placed on a turntable with 80 cm above ground.
4. The EUT was set 3 meters from the interference receiving antenna, which was mounted on the top of a 1 m height antenna tower.
5. The radiated emission limits are based on measurements employing a CISPR quasi-peak detector except for the frequency bands 9-90 kHz, 110-490 kHz and above 1000 MHz. Radiated emission limits in these three bands are based on measurements employing an average detector.
6. For measurement below 1 GHz, the initial step in collecting conducted emission data is a spectrum analyzer peak detector mode pre-scanning the measurement frequency range. Significant peaks are then marked and then Quasi Peak and average detector mode re-measured. If the emission level of the EUT measured by the peak detector is 3 dB lower than the applicable limit, the peak emission level will be reported. Otherwise, the emission measurement will be repeated using the quasi-peak and average detector and reported.
7. Although these tests were performed other than open field site, adequate comparison measurements were confirmed against 30 m open field site. Therefore sufficient tests were made to demonstrate that the alternative site produces results that correlate with the ones of tests made in an open field site based on KDB 414788.
8. The limits in CFR 47, Part 15, Subpart C, paragraph 15.209 (a), are identical to those in RSS-GEN Section 8.9, Table 6, since the measurements are performed in terms of magnetic field strength and converted to electric field strength levels (as reported in the table) using the free space impedance of 377 Ω. For example, the measurement frequency X kHz resulted in a level of Y dBuV/m, which is equivalent to $Y-51.5 = Z$ dBuA/m, which has the same margin, W dB, to the corresponding RSS-GEN Table 6 limit as it has to be 15.209(a) limit.

Below 1 GHz and Above 30 MHz

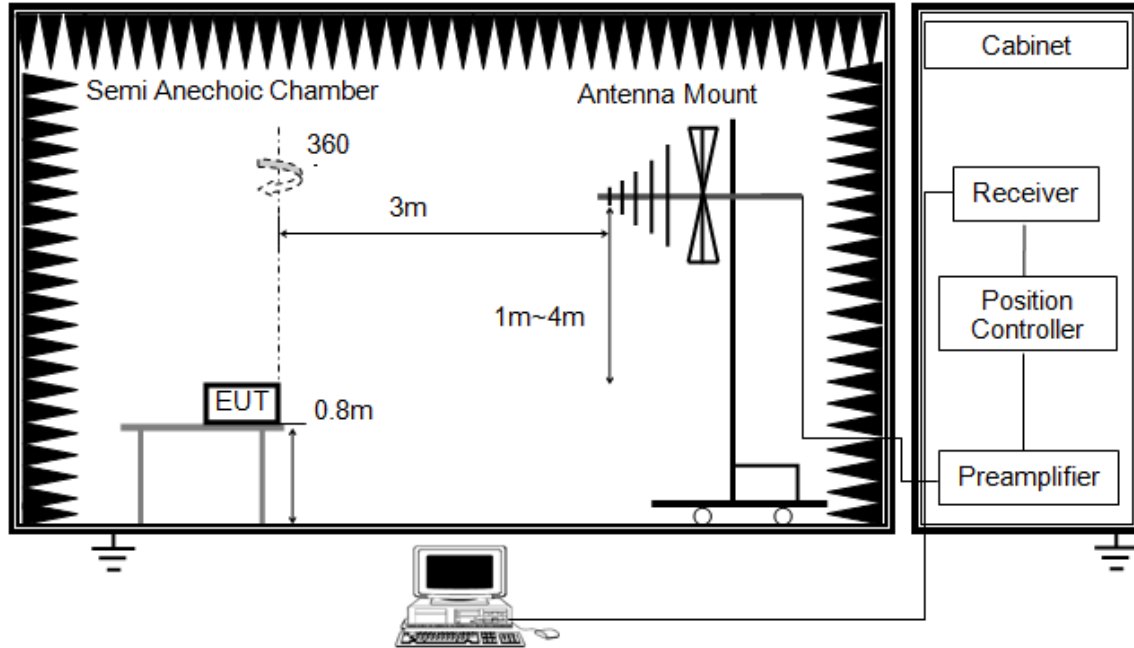

The setting of the spectrum analyser

RBW	120 kHz
VBW	300 kHz
Sweep	Auto
Detector	Peak/QP
Trace	Max hold

1. The testing follows the guidelines in ANSI C63.10-2013.
2. The EUT was arranged to its worst case and then tune the antenna tower (from 1 m to 4 m) and turntable (from 0 degree to 360 degrees) to find the maximum reading. A pre-amp and a high pass filter are used for the test in order to get better signal level. Both horizontal and vertical polarizations of the antenna are set to make the measurement.
3. The EUT was placed on a turntable with 80cm above ground.
4. The EUT was set 3 meters from the interference receiving antenna, which was mounted on the top of a variable height antenna tower.
5. The initial step in collecting conducted emission data is a spectrum analyzer peak detector mode pre-scanning the measurement frequency range. Significant peaks are then marked and then Quasi Peak detector mode re-measured

Above 1 GHz

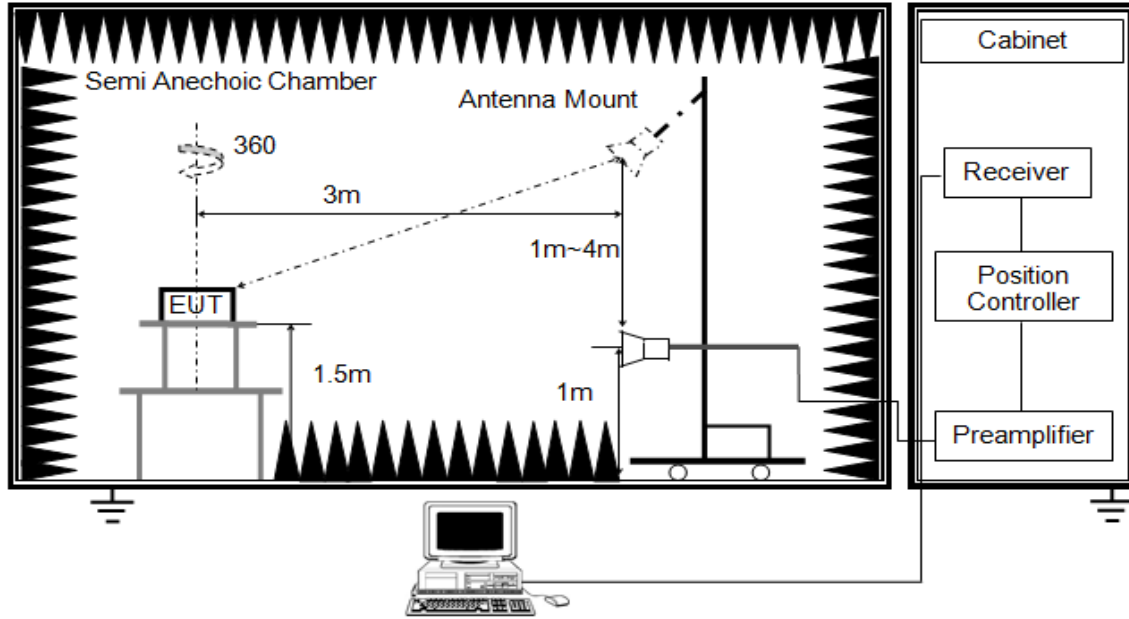

The setting of the spectrum analyser. (For Bandedge and Field strength)

RBW	\geq OBW (2 MHz)
VBW	PEAK: $\geq 3 \times$ RBW AVG: see note 6
Sweep	Auto
Detector	Peak
Trace	Max hold

The setting of the spectrum analyser. (For Spurious emissions)

RBW	1 MHz
VBW	PEAK: 3 MHz AVG: see note 5
Sweep	Auto
Detector	Peak
Trace	Max hold

1. The testing follows the guidelines in ANSI C63.10-2013.
2. The EUT was arranged to its worst case and then tune the antenna tower (1.5 m) and turntable (from 0 degree to 360 degrees) to find the maximum reading. A pre-amp and a high pass filter or band reject filter are used for the test in order to get better signal level. Both horizontal and vertical polarizations of the antenna are set to make the measurement.
3. The EUT was placed on a turntable with 150cm above ground.
4. The EUT was set 3 meters from the interference receiving antenna, which was mounted on the top of a variable height antenna tower.

5. For measurements above 1 GHz the resolution bandwidth is set to 1 MHz, then the video bandwidth is set to 3 MHz for peak measurements. Where necessary, average emission are determined by applying the Duty Cycle Correction Factor to the peak measurements. For the Duty Cycle and Correction Factor please refer to clause 6.1. ON TIME AND DUTY CYCLE.

6. For measurements Bandedge above 1 GHz, the resolution bandwidth is set to 2 MHz, then the video bandwidth is set to $\geq 3 \times \text{RBW}$ for peak measurements. This test results are worse than using 1 MHz resolution bandwidth, so if the result is pass, the test is considered to meet the standard requirements.

X axis, Y axis, Z axis positions:

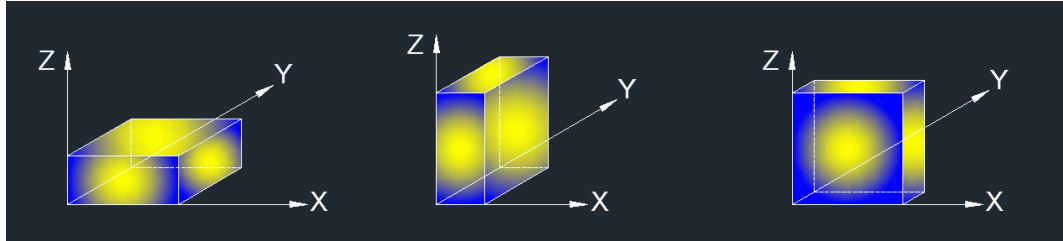

Note 1: For all radiated test, EUT in each of three orthogonal axis emissions had been tested, but only the worst case (X axis) data recorded in the report.

Note 2: The EUT was fully exercised with external accessories during the test. In the case of multiple accessory external ports, an external accessory shall be connected to one of each type of port.

TEST ENVIRONMENT

Temperature	22.3 °C	Relative Humidity	43 %
Atmosphere Pressure	101 kPa	Test Voltage	DC 5 V



7.2. RESTRICTED BANDEDGE AND FIELD STRENGTH OF INTENTIONAL EMISSIONS

RESTRICTED BANDEDGE AND FIELD STRENGTH OF INTENTIONAL EMISSIONS (LOW CHANNEL, HORIZONTAL)

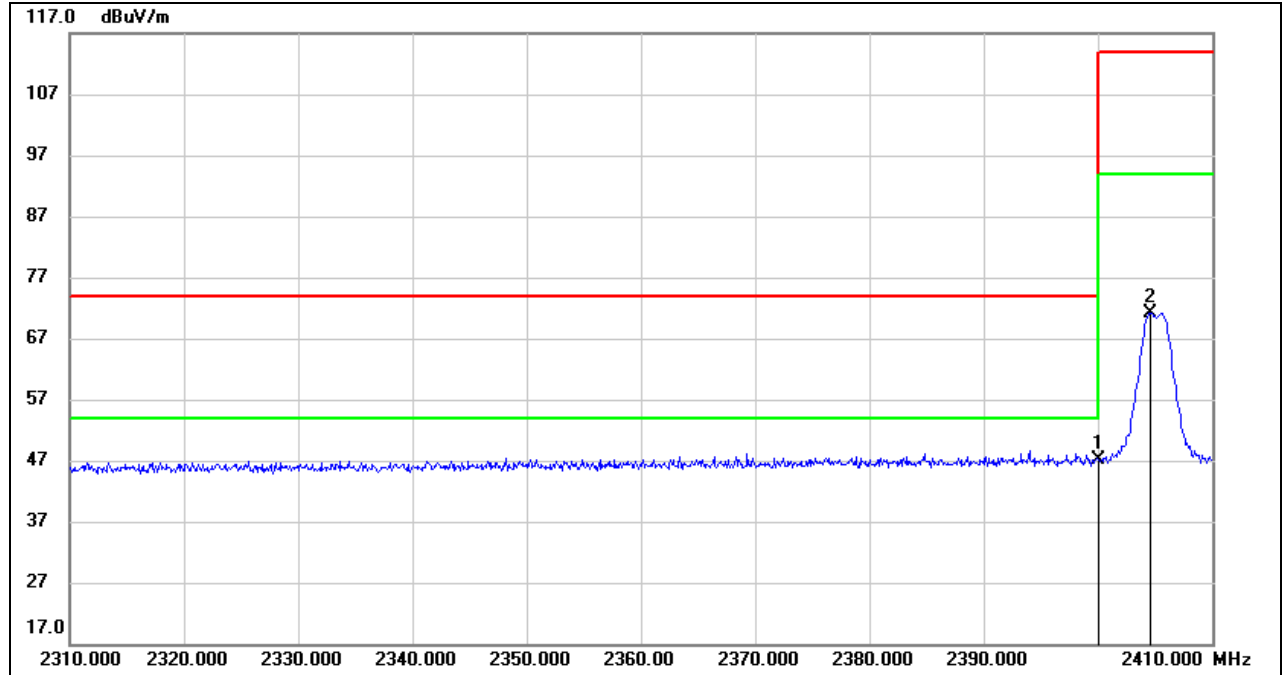

No.	Frequency (MHz)	Reading (dBuV)	Correct (dB/m)	Result (dBuV/m)	Limit (dBuV/m)	Margin (dB)	Remark
1	2400.000	14.48	32.75	47.23	74.00	-26.77	peak
2	2404.600	38.46	32.77	71.23	114.00	-42.77	peak

- Note:
1. Measurement = Reading Level + Correct Factor.
 2. If Peak Result complies with AV limit, AV Result is deemed to comply with AV limit.
 3. Peak: Peak detector.
 4. AVG Result=Peak Result + Duty Cycle Correction Factor.
 5. For the Duty Cycle and Correction Factor, please refer to clause 6.1.
 6. Only the worst case emission was recorded, if it complies with the limit, the other emissions deemed to comply with the limit.

RESTRICTED BANDEDGE AND FIELD STRENGTH OF INTENTIONAL EMISSIONS (LOW CHANNEL, VERTICAL)

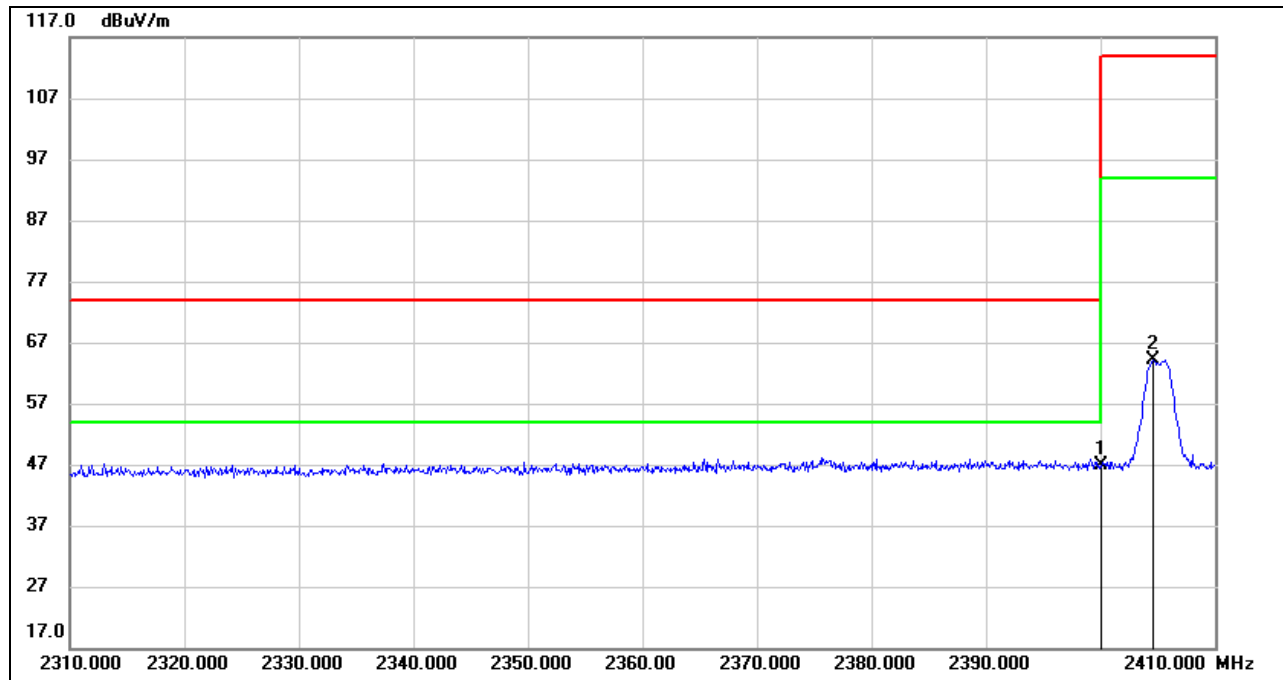

No.	Frequency (MHz)	Reading (dBuV)	Correct (dB/m)	Result (dBuV/m)	Limit (dBuV/m)	Margin (dB)	Remark
1	2400.000	14.14	32.75	46.89	74.00	-27.11	peak
2	2404.600	31.44	32.77	64.21	114.00	-49.79	peak

- Note:
1. Measurement = Reading Level + Correct Factor.
 2. If Peak Result complies with AV limit, AV Result is deemed to comply with AV limit.
 3. Peak: Peak detector.
 4. AVG Result=Peak Result + Duty Cycle Correction Factor.
 5. For the Duty Cycle and Correction Factor, please refer to clause 6.1.
 6. Only the worst case emission was recorded, if it complies with the limit, the other emissions deemed to comply with the limit.

FIELD STRENGTH OF INTENTIONAL EMISSIONS (MIDDLE CHANNEL, HORIZONTAL)

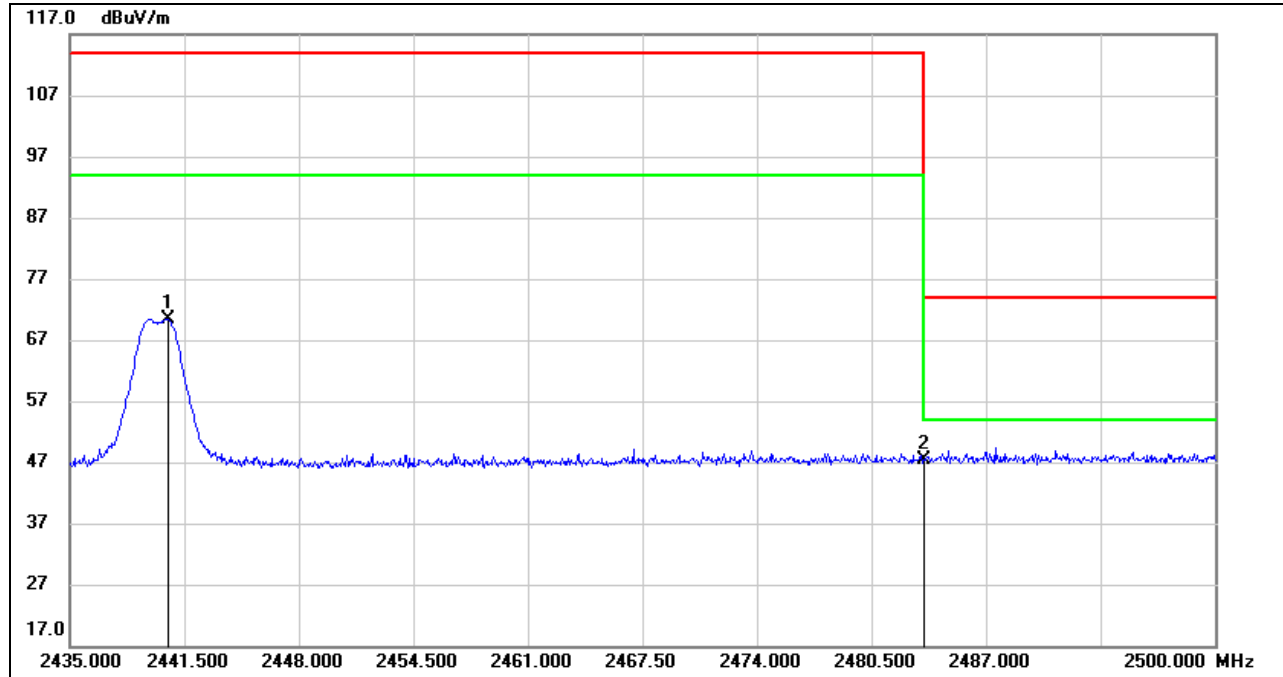

No.	Frequency (MHz)	Reading (dBuV)	Correct (dB/m)	Result (dBuV/m)	Limit (dBuV/m)	Margin (dB)	Remark
1	2440.590	37.56	32.92	70.48	114.00	-43.52	peak
2	2483.500	14.24	33.10	47.34	74.00	-26.66	peak

- Note: 1. Measurement = Reading Level + Correct Factor.
 2. If Peak Result complies with AV limit, AV Result is deemed to comply with AV limit.
 3. Peak: Peak detector.
 4. AVG Result=Peak Result + Duty Cycle Correction Factor.
 5. For the Duty Cycle and Correction Factor, please refer to clause 6.1.
 6. Only the worst case emission was recorded, if it complies with the limit, the other emissions deemed to comply with the limit.

FIELD STRENGTH OF INTENTIONAL EMISSIONS (MIDDLE CHANNEL, VERTICAL)

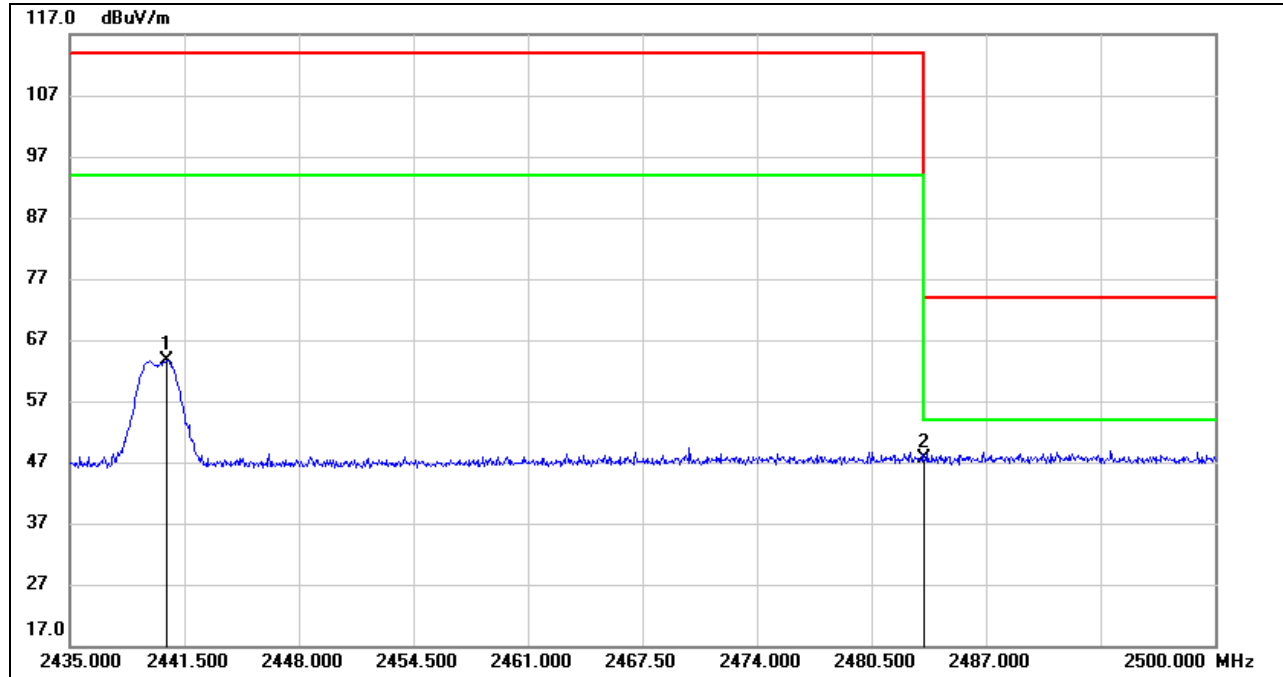

No.	Frequency (MHz)	Reading (dBuV)	Correct (dB/m)	Result (dBuV/m)	Limit (dBuV/m)	Margin (dB)	Remark
1	2440.460	30.70	32.92	63.62	114.00	-50.38	peak
2	2483.500	14.59	33.10	47.69	74.00	-26.31	peak

- Note:
1. Measurement = Reading Level + Correct Factor.
 2. If Peak Result complies with AV limit, AV Result is deemed to comply with AV limit.
 3. Peak: Peak detector.
 4. AVG Result=Peak Result + Duty Cycle Correction Factor.
 5. For the Duty Cycle and Correction Factor, please refer to clause 6.1.
 6. Only the worst case emission was recorded, if it complies with the limit, the other emissions deemed to comply with the limit.

RESTRICTED BANDEGE AND FIELD STRENGTH OF INTENTIONAL EMISSIONS (HIGH CHANNEL, HORIZONTAL)

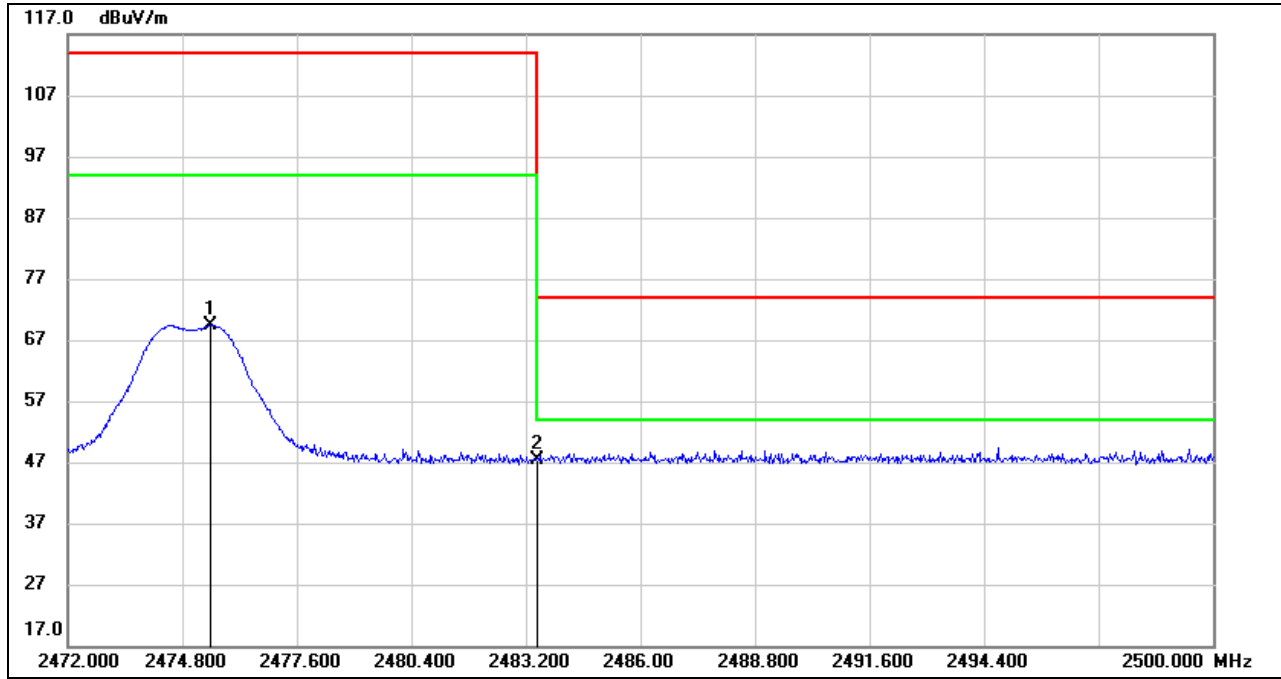

No.	Frequency (MHz)	Reading (dBuV)	Correct (dB/m)	Result (dBuV/m)	Limit (dBuV/m)	Margin (dB)	Remark
1	2475.472	36.41	33.06	69.47	114.00	-44.53	peak
2	2483.500	14.30	33.10	47.40	74.00	-26.60	peak

- Note: 1. Measurement = Reading Level + Correct Factor.
 2. If Peak Result complies with AV limit, AV Result is deemed to comply with AV limit.
 3. Peak: Peak detector.
 4. AVG Result=Peak Result + Duty Cycle Correction Factor.
 5. For the Duty Cycle and Correction Factor, please refer to clause 6.1.
 6. Only the worst case emission was recorded, if it complies with the limit, the other emissions deemed to comply with the limit.

RESTRICTED BANDEGE AND FIELD STRENGTH OF INTENTIONAL EMISSIONS (HIGH CHANNEL, VERTICAL)

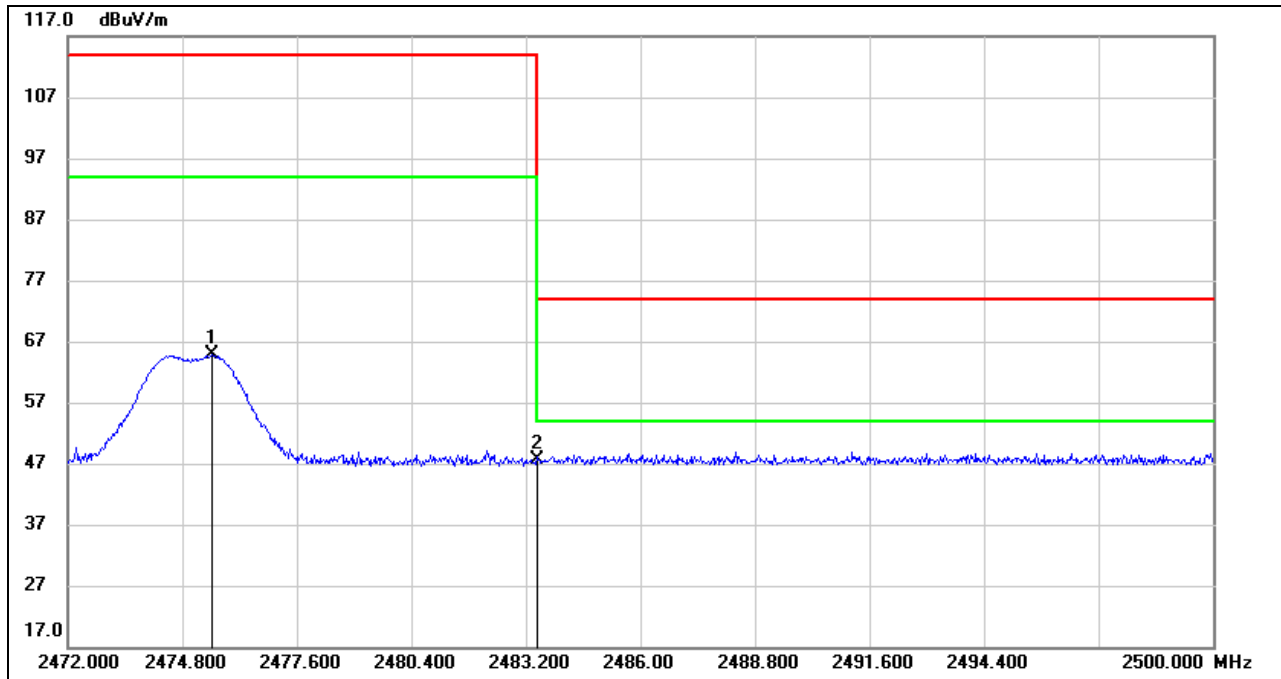

No.	Frequency (MHz)	Reading (dBuV)	Correct (dB/m)	Result (dBuV/m)	Limit (dBuV/m)	Margin (dB)	Remark
1	2475.528	31.70	33.06	64.76	114.00	-49.24	peak
2	2483.500	14.43	33.10	47.53	74.00	-26.47	peak

- Note: 1. Measurement = Reading Level + Correct Factor.
 2. If Peak Result complies with AV limit, AV Result is deemed to comply with AV limit.
 3. Peak: Peak detector.
 4. AVG Result=Peak Result + Duty Cycle Correction Factor.
 5. For the Duty Cycle and Correction Factor, please refer to clause 6.1.
 6. Only the worst case emission was recorded, if it complies with the limit, the other emissions deemed to comply with the limit.

7.3. SPURIOUS EMISSIONS (1 ~ 3 GHz)

HARMONICS AND SPURIOUS EMISSIONS (LOW CHANNEL, HORIZONTAL)

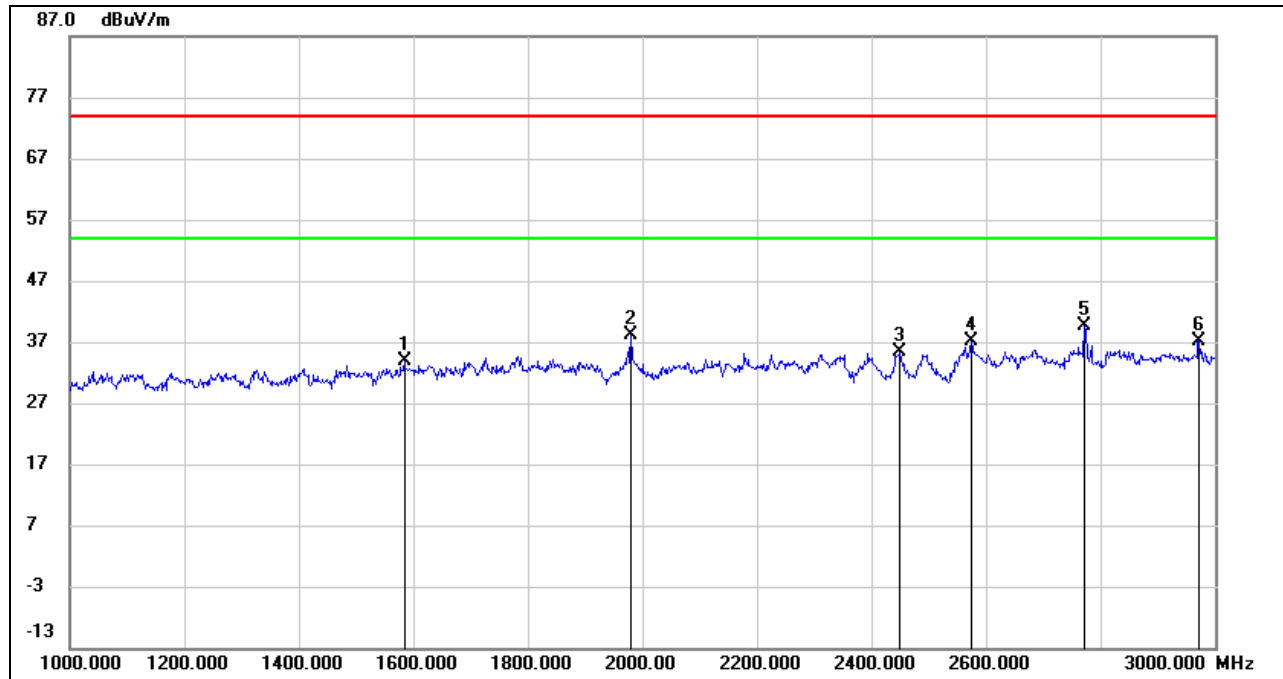

No.	Frequency (MHz)	Reading (dBuV)	Correct (dB/m)	Result (dBuV/m)	Limit (dBuV/m)	Margin (dB)	Remark
1	1584.000	45.86	-12.08	33.78	74.00	-40.22	peak
2	1980.000	49.38	-11.15	38.23	74.00	-35.77	peak
3	2450.000	44.26	-8.95	35.31	74.00	-38.69	peak
4	2574.000	45.74	-8.69	37.05	74.00	-36.95	peak
5	2772.000	47.52	-7.83	39.69	74.00	-34.31	peak
6	2972.000	44.37	-7.18	37.19	74.00	-36.81	peak

Note: 1. Peak Result = Reading Level + Correct Factor.

2. If Peak Result complies with AV limit, AV Result is deemed to comply with AV limit.
3. Peak: Peak detector.
4. Filter losses were only considered in then spurious frequency bands and the authorized band was not corrected for Band reject filter losses.
5. Proper operation of the transmitter prior to adding the filter to the measurement chain.

HARMONICS AND SPURIOUS EMISSIONS (LOW CHANNEL, VERTICAL)

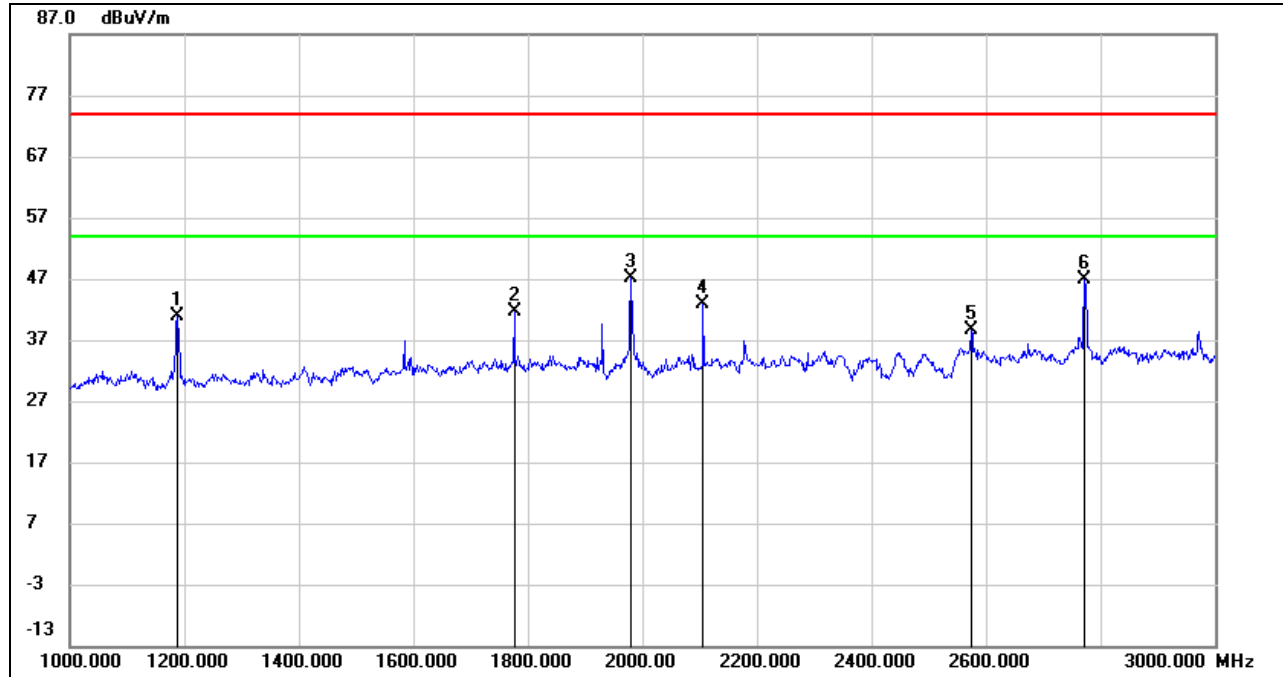

No.	Frequency (MHz)	Reading (dBuV)	Correct (dB/m)	Result (dBuV/m)	Limit (dBuV/m)	Margin (dB)	Remark
1	1188.000	54.84	-13.85	40.99	74.00	-33.01	peak
2	1776.000	52.65	-10.91	41.74	74.00	-32.26	peak
3	1980.000	58.34	-11.15	47.19	74.00	-26.81	peak
4	2106.000	53.27	-10.50	42.77	74.00	-31.23	peak
5	2574.000	47.34	-8.69	38.65	74.00	-35.35	peak
6	2772.000	54.59	-7.83	46.76	74.00	-27.24	peak

- Note: 1. Peak Result = Reading Level + Correct Factor.
 2. If Peak Result complies with AV limit, AV Result is deemed to comply with AV limit.
 3. Peak: Peak detector.
 4. Filter losses were only considered in then spurious frequency bands and the authorized band was not corrected for Band reject filter losses.
 5. Proper operation of the transmitter prior to adding the filter to the measurement chain.

HARMONICS AND SPURIOUS EMISSIONS (MID CHANNEL, HORIZONTAL)

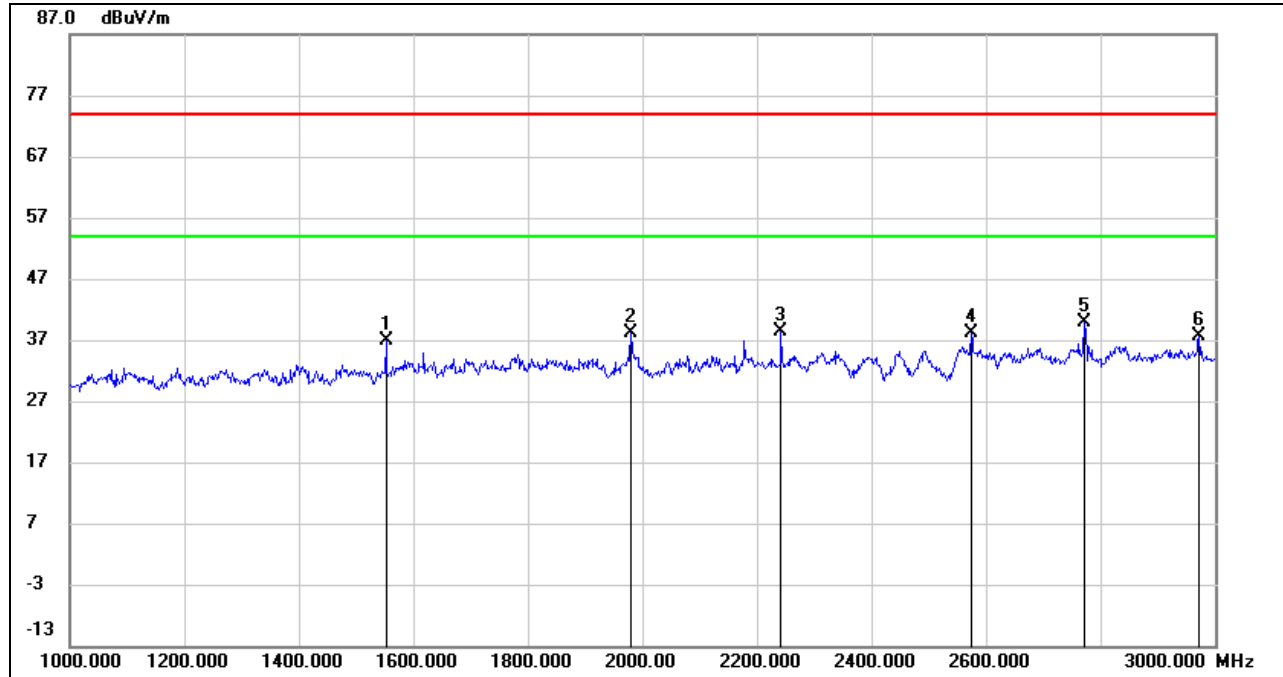

No.	Frequency (MHz)	Reading (dBuV)	Correct (dB/m)	Result (dBuV/m)	Limit (dBuV/m)	Margin (dB)	Remark
1	1552.000	49.19	-12.26	36.93	74.00	-37.07	peak
2	1980.000	49.20	-11.15	38.05	74.00	-35.95	peak
3	2242.000	48.05	-9.72	38.33	74.00	-35.67	peak
4	2574.000	46.82	-8.69	38.13	74.00	-35.87	peak
5	2772.000	47.65	-7.83	39.82	74.00	-34.18	peak
6	2972.000	44.73	-7.18	37.55	74.00	-36.45	peak

- Note: 1. Peak Result = Reading Level + Correct Factor.
 2. If Peak Result complies with AV limit, AV Result is deemed to comply with AV limit.
 3. Peak: Peak detector.
 4. Filter losses were only considered in then spurious frequency bands and the authorized band was not corrected for Band reject filter losses.
 5. Proper operation of the transmitter prior to adding the filter to the measurement chain.

HARMONICS AND SPURIOUS EMISSIONS (MID CHANNEL, VERTICAL)

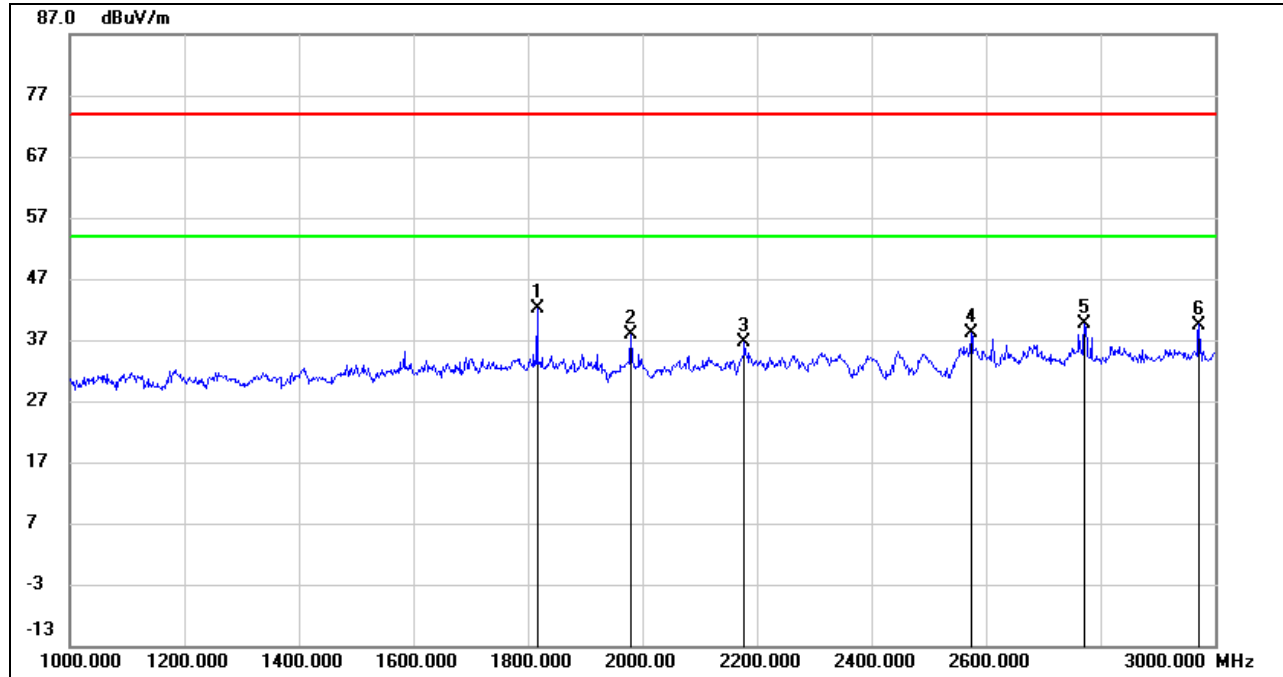

No.	Frequency (MHz)	Reading (dBuV)	Correct (dB/m)	Result (dBuV/m)	Limit (dBuV/m)	Margin (dB)	Remark
1	1816.000	52.95	-10.80	42.15	74.00	-31.85	peak
2	1980.000	49.08	-11.15	37.93	74.00	-36.07	peak
3	2178.000	46.70	-10.03	36.67	74.00	-37.33	peak
4	2574.000	46.91	-8.69	38.22	74.00	-35.78	peak
5	2772.000	47.48	-7.83	39.65	74.00	-34.35	peak
6	2972.000	46.68	-7.18	39.50	74.00	-34.50	peak

- Note: 1. Peak Result = Reading Level + Correct Factor.
 2. If Peak Result complies with AV limit, AV Result is deemed to comply with AV limit.
 3. Peak: Peak detector.
 4. Filter losses were only considered in then spurious frequency bands and the authorized band was not corrected for Band reject filter losses.
 5. Proper operation of the transmitter prior to adding the filter to the measurement chain.



HARMONICS AND SPURIOUS EMISSIONS (HIGH CHANNEL, HORIZONTAL)

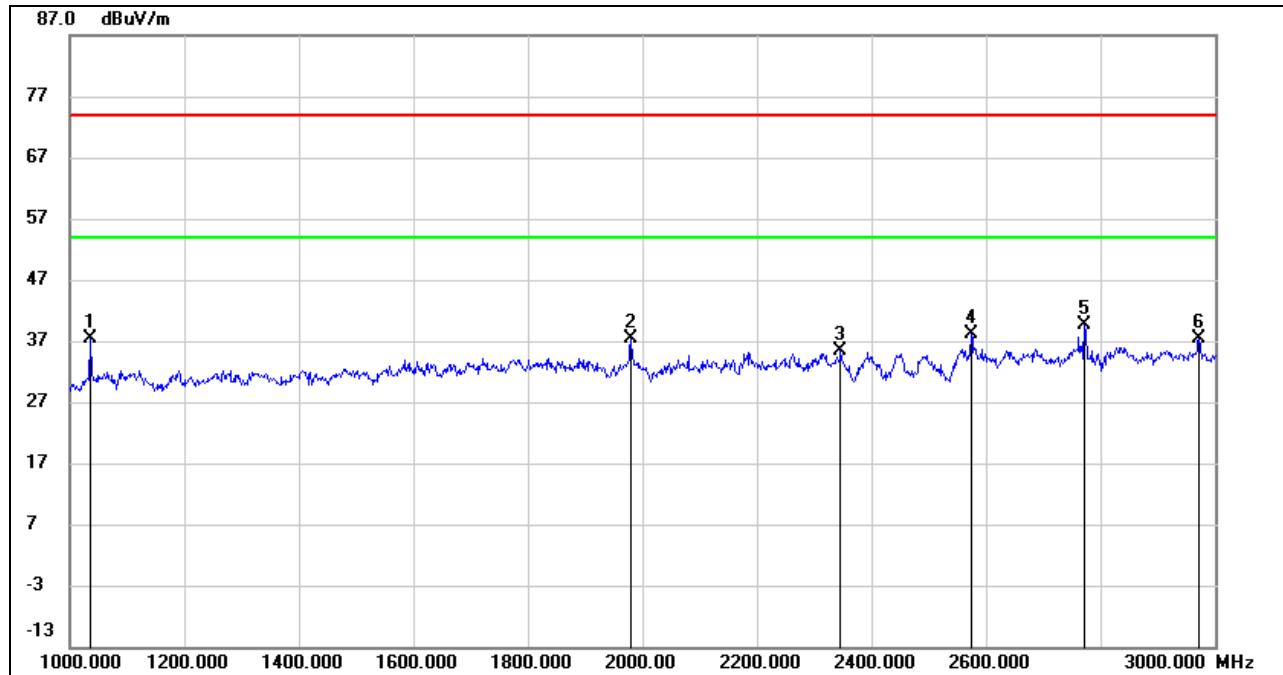

No.	Frequency (MHz)	Reading (dBuV)	Correct (dB/m)	Result (dBuV/m)	Limit (dBuV/m)	Margin (dB)	Remark
1	1036.000	52.31	-14.85	37.46	74.00	-36.54	peak
2	1980.000	48.56	-11.15	37.41	74.00	-36.59	peak
3	2346.000	44.58	-9.30	35.28	74.00	-38.72	peak
4	2574.000	46.88	-8.69	38.19	74.00	-35.81	peak
5	2772.000	47.47	-7.83	39.64	74.00	-34.36	peak
6	2972.000	44.54	-7.18	37.36	74.00	-36.64	peak

- Note: 1. Peak Result = Reading Level + Correct Factor.
2. If Peak Result complies with AV limit, AV Result is deemed to comply with AV limit.
3. Peak: Peak detector.
4. Filter losses were only considered in then spurious frequency bands and the authorized band was not corrected for Band reject filter losses.
5. Proper operation of the transmitter prior to adding the filter to the measurement chain.

HARMONICS AND SPURIOUS EMISSIONS (HIGH CHANNEL, VERTICAL)

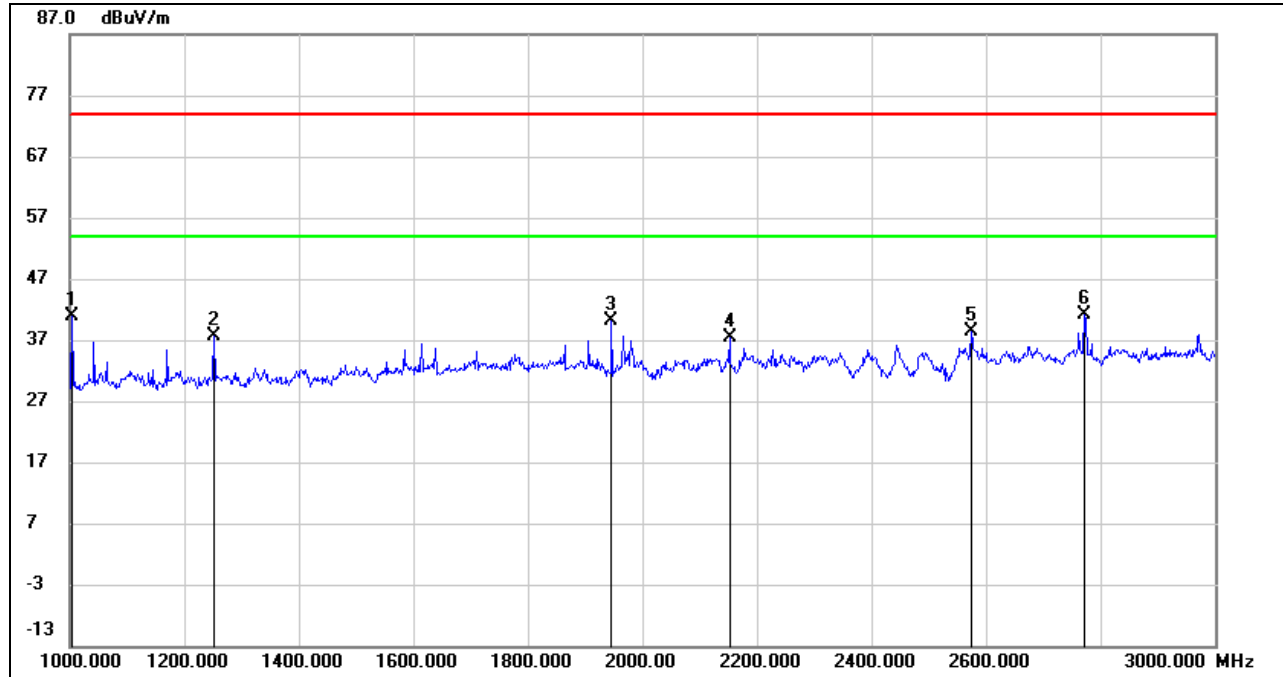

No.	Frequency (MHz)	Reading (dBuV)	Correct (dB/m)	Result (dBuV/m)	Limit (dBuV/m)	Margin (dB)	Remark
1	1004.000	55.88	-15.06	40.82	74.00	-33.18	peak
2	1252.000	51.14	-13.61	37.53	74.00	-36.47	peak
3	1946.000	51.27	-11.08	40.19	74.00	-33.81	peak
4	2152.000	47.47	-10.19	37.28	74.00	-36.72	peak
5	2574.000	47.06	-8.69	38.37	74.00	-35.63	peak
6	2772.000	49.00	-7.83	41.17	74.00	-32.83	peak

- Note: 1. Peak Result = Reading Level + Correct Factor.
 2. If Peak Result complies with AV limit, AV Result is deemed to comply with AV limit.
 3. Peak: Peak detector.
 4. Filter losses were only considered in then spurious frequency bands and the authorized band was not corrected for Band reject filter losses.
 5. Proper operation of the transmitter prior to adding the filter to the measurement chain.

7.4. SPURIOUS EMISSIONS (3 ~ 18 GHz)

HARMONICS AND SPURIOUS EMISSIONS (LOW CHANNEL, HORIZONTAL)

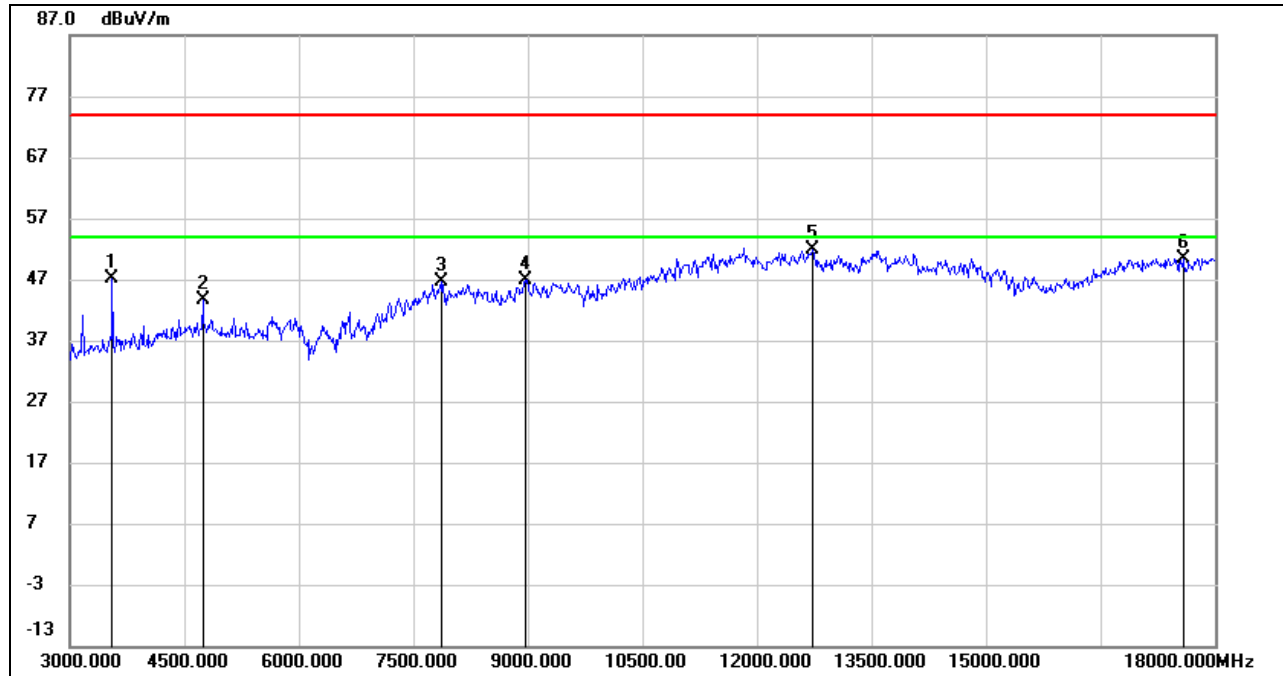

No.	Frequency (MHz)	Reading (dBuV)	Correct (dB/m)	Result (dBuV/m)	Limit (dBuV/m)	Margin (dB)	Remark
1	3555.000	52.61	-5.53	47.08	74.00	-26.92	peak
2	4740.000	44.49	-0.94	43.55	74.00	-30.45	peak
3	7875.000	39.12	7.40	46.52	74.00	-27.48	peak
4	8970.000	37.16	9.80	46.96	74.00	-27.04	peak
5	12735.000	34.88	16.92	51.80	74.00	-22.20	peak
6	17580.000	29.83	20.63	50.46	74.00	-23.54	peak

- Note: 1. Measurement = Reading Level + Correct Factor.
 2. If Peak Result complies with AV limit, AV Result is deemed to comply with AV limit.
 3. Peak: Peak detector.
 4. The High Pass filter loss factor already add into the correct factor.
 5. Proper operation of the transmitter prior to adding the filter to the measurement chain.

HARMONICS AND SPURIOUS EMISSIONS (LOW CHANNEL, VERTICAL)

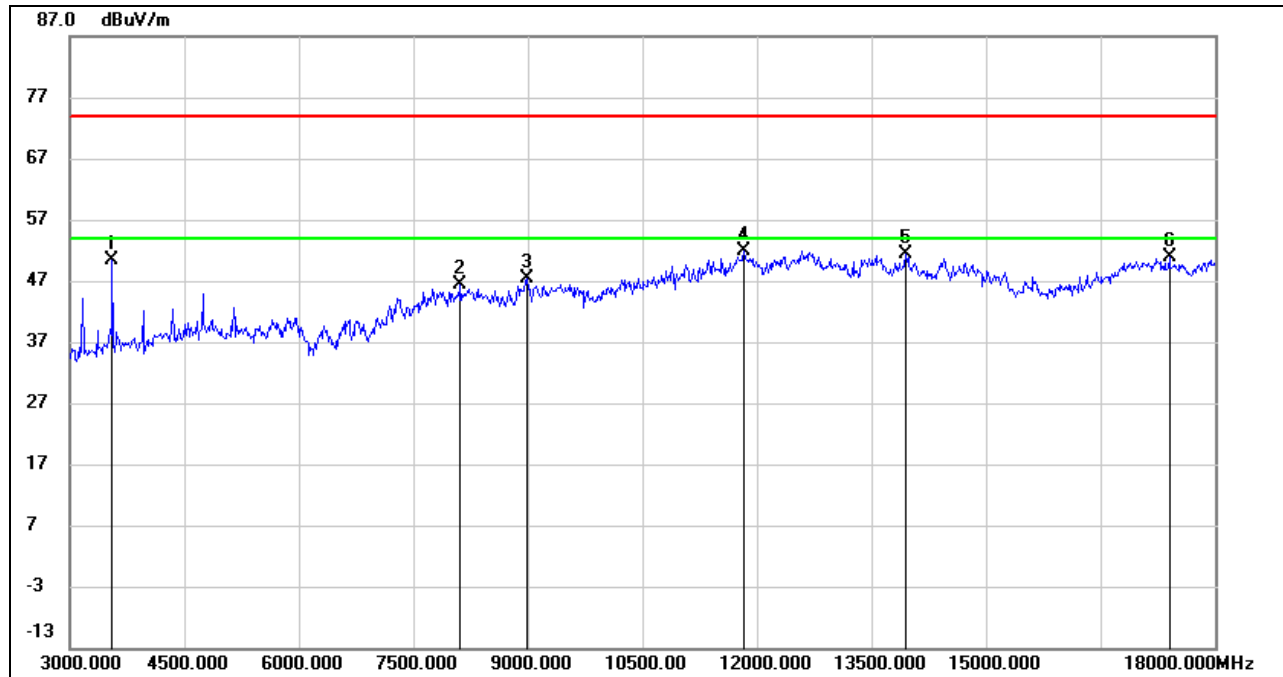

No.	Frequency (MHz)	Reading (dBuV)	Correct (dB/m)	Result (dBuV/m)	Limit (dBuV/m)	Margin (dB)	Remark
1	3555.000	55.82	-5.53	50.29	74.00	-23.71	peak
2	8115.000	38.49	8.01	46.50	74.00	-27.50	peak
3	8985.000	37.40	9.96	47.36	74.00	-26.64	peak
4	11835.000	34.70	17.29	51.99	74.00	-22.01	peak
5	13950.000	32.80	18.61	51.41	74.00	-22.59	peak
6	17400.000	31.05	19.83	50.88	74.00	-23.12	peak

- Note: 1. Measurement = Reading Level + Correct Factor.
 2. If Peak Result complies with AV limit, AV Result is deemed to comply with AV limit.
 3. Peak: Peak detector.
 4. The High Pass filter loss factor already add into the correct factor.
 5. Proper operation of the transmitter prior to adding the filter to the measurement chain.



HARMONICS AND SPURIOUS EMISSIONS (MID CHANNEL, HORIZONTAL)

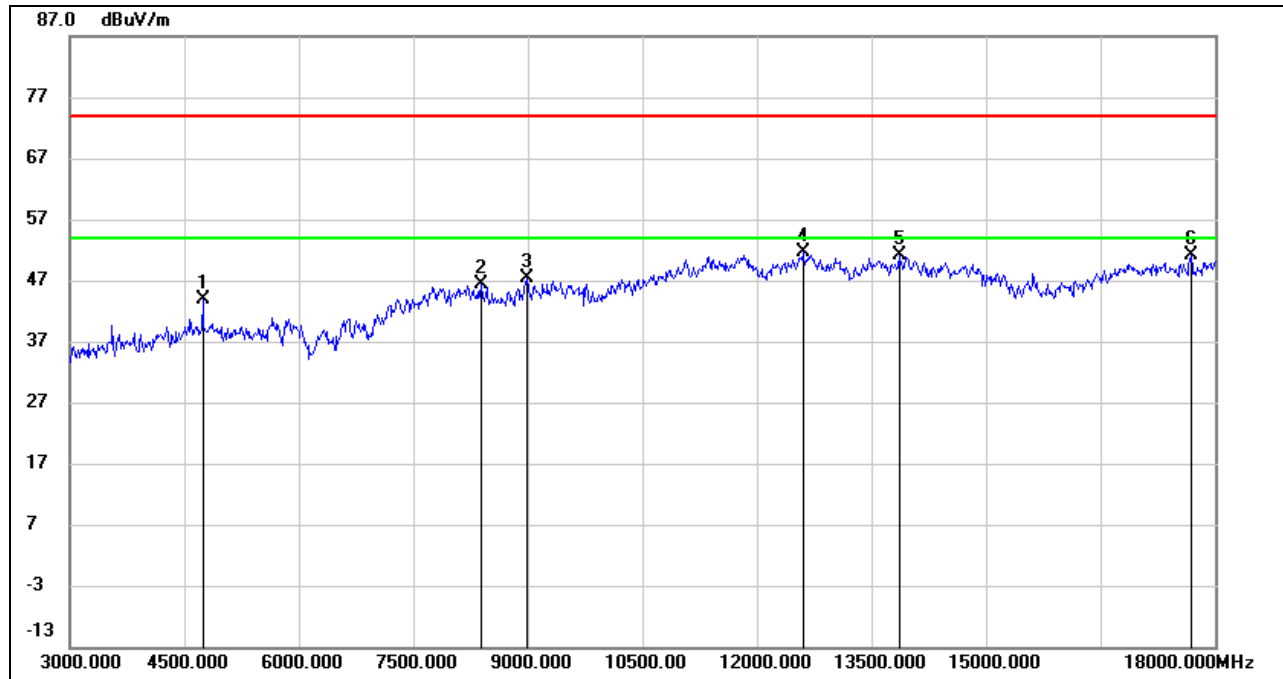

No.	Frequency (MHz)	Reading (dBuV)	Correct (dB/m)	Result (dBuV/m)	Limit (dBuV/m)	Margin (dB)	Remark
1	4740.000	44.83	-0.94	43.89	74.00	-30.11	peak
2	8385.000	38.37	7.97	46.34	74.00	-27.66	peak
3	8985.000	37.36	9.96	47.32	74.00	-26.68	peak
4	12600.000	35.01	16.63	51.64	74.00	-22.36	peak
5	13860.000	32.43	18.71	51.14	74.00	-22.86	peak
6	17685.000	29.58	21.64	51.22	74.00	-22.78	peak

- Note: 1. Measurement = Reading Level + Correct Factor.
 2. If Peak Result complies with AV limit, AV Result is deemed to comply with AV limit.
 3. Peak: Peak detector.
 4. The High Pass filter loss factor already add into the correct factor.
 5. Proper operation of the transmitter prior to adding the filter to the measurement chain.

HARMONICS AND SPURIOUS EMISSIONS (MID CHANNEL, VERTICAL)

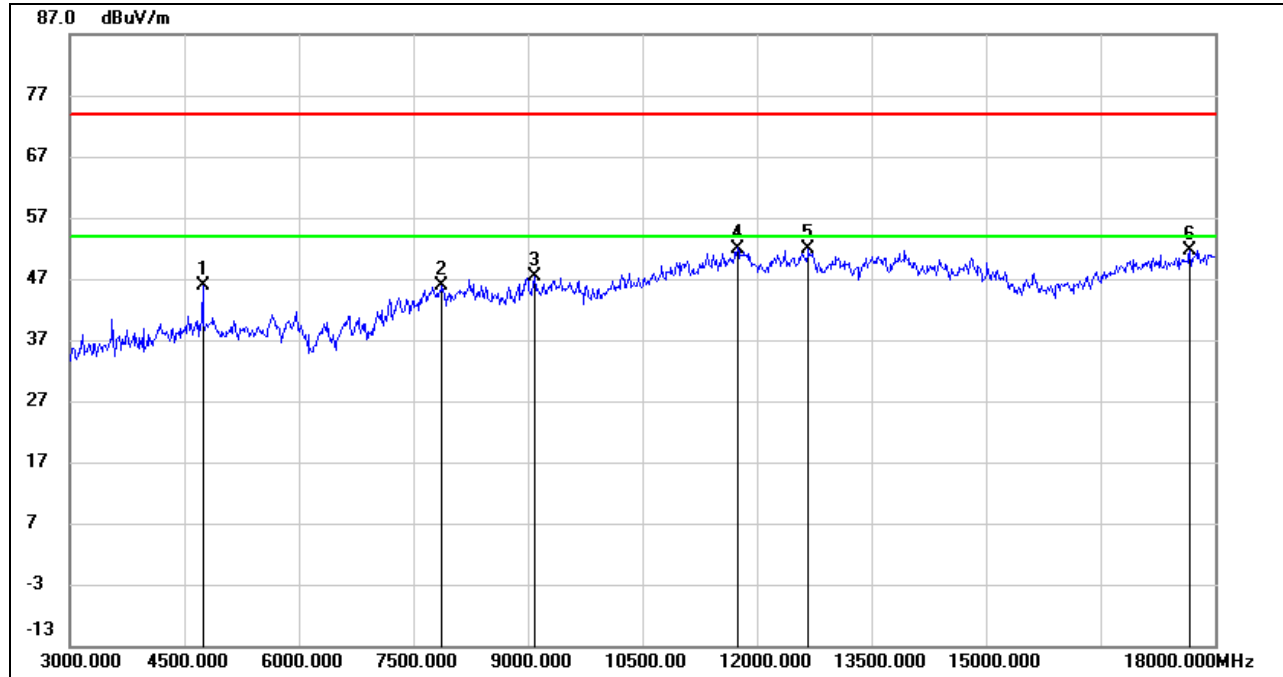

No.	Frequency (MHz)	Reading (dBuV)	Correct (dB/m)	Result (dBuV/m)	Limit (dBuV/m)	Margin (dB)	Remark
1	4740.000	46.73	-0.94	45.79	74.00	-28.21	peak
2	7875.000	38.60	7.40	46.00	74.00	-28.00	peak
3	9090.000	37.85	9.60	47.45	74.00	-26.55	peak
4	11745.000	34.93	17.07	52.00	74.00	-22.00	peak
5	12675.000	34.97	16.79	51.76	74.00	-22.24	peak
6	17670.000	30.23	21.48	51.71	74.00	-22.29	peak

- Note: 1. Measurement = Reading Level + Correct Factor.
 2. If Peak Result complies with AV limit, AV Result is deemed to comply with AV limit.
 3. Peak: Peak detector.
 4. The High Pass filter loss factor already add into the correct factor.
 5. Proper operation of the transmitter prior to adding the filter to the measurement chain.



HARMONICS AND SPURIOUS EMISSIONS (HIGH CHANNEL, HORIZONTAL)

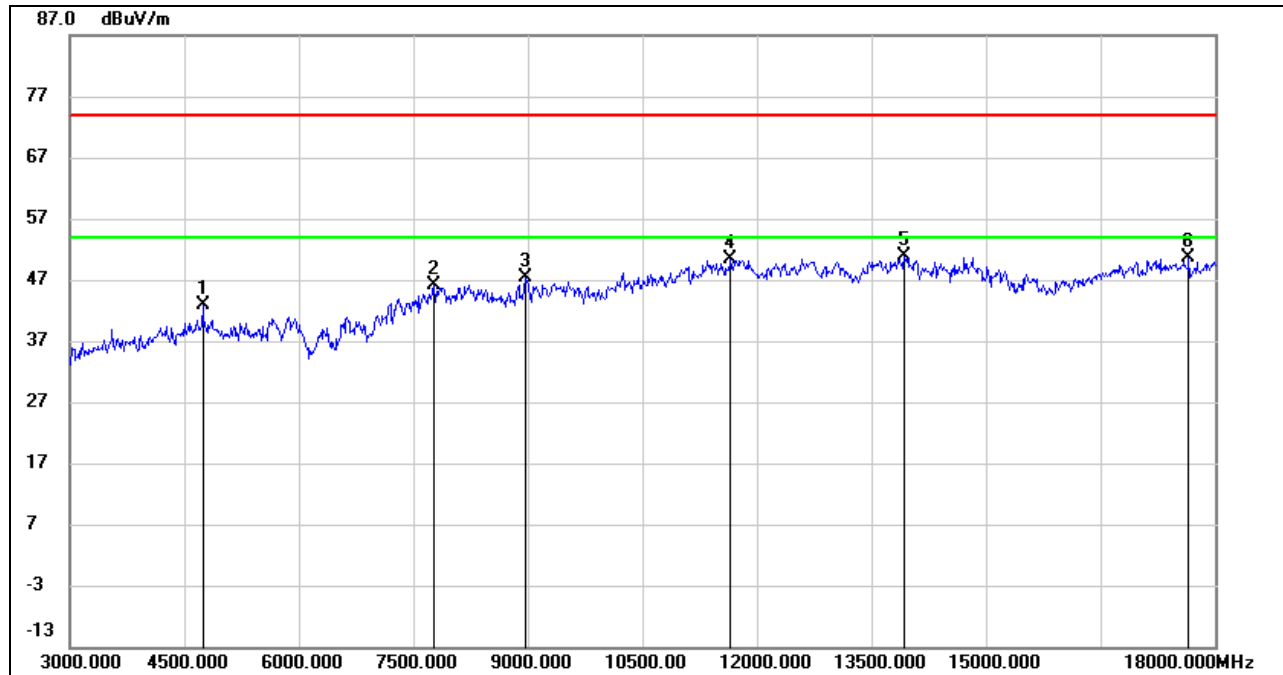

No.	Frequency (MHz)	Reading (dBuV)	Correct (dB/m)	Result (dBuV/m)	Limit (dBuV/m)	Margin (dB)	Remark
1	4740.000	43.82	-0.94	42.88	74.00	-31.12	peak
2	7770.000	38.75	7.49	46.24	74.00	-27.76	peak
3	8970.000	37.47	9.80	47.27	74.00	-26.73	peak
4	11655.000	33.78	16.58	50.36	74.00	-23.64	peak
5	13920.000	32.23	18.64	50.87	74.00	-23.13	peak
6	17655.000	29.30	21.33	50.63	74.00	-23.37	peak

- Note: 1. Measurement = Reading Level + Correct Factor.
 2. If Peak Result complies with AV limit, AV Result is deemed to comply with AV limit.
 3. Peak: Peak detector.
 4. The High Pass filter loss factor already add into the correct factor.
 5. Proper operation of the transmitter prior to adding the filter to the measurement chain.



HARMONICS AND SPURIOUS EMISSIONS (HIGH CHANNEL, VERTICAL)

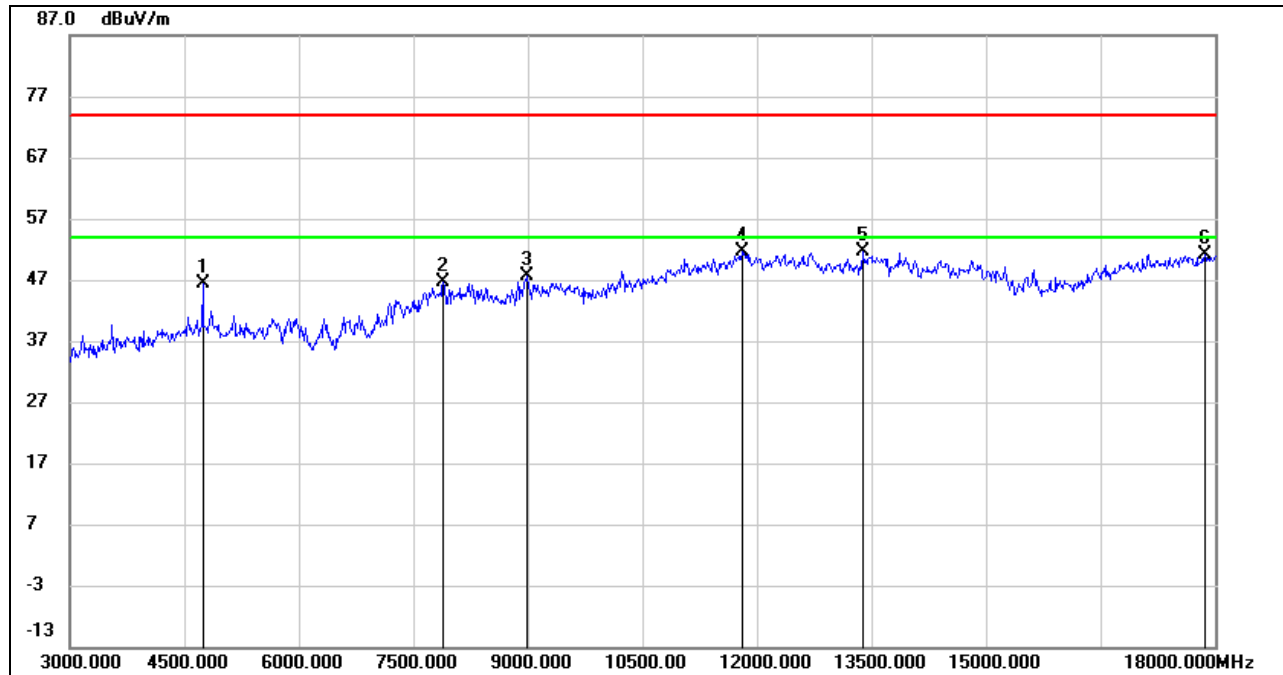

No.	Frequency (MHz)	Reading (dBuV)	Correct (dB/m)	Result (dBuV/m)	Limit (dBuV/m)	Margin (dB)	Remark
1	4740.000	47.22	-0.94	46.28	74.00	-27.72	peak
2	7890.000	39.37	7.36	46.73	74.00	-27.27	peak
3	8985.000	37.55	9.96	47.51	74.00	-26.49	peak
4	11805.000	34.21	17.34	51.55	74.00	-22.45	peak
5	13380.000	33.40	18.12	51.52	74.00	-22.48	peak
6	17865.000	28.14	23.03	51.17	74.00	-22.83	peak

- Note: 1. Measurement = Reading Level + Correct Factor.
 2. If Peak Result complies with AV limit, AV Result is deemed to comply with AV limit.
 3. Peak: Peak detector.
 4. The High Pass filter loss factor already add into the correct factor.
 5. Proper operation of the transmitter prior to adding the filter to the measurement chain.

7.5. SPURIOUS EMISSIONS (18 ~ 26 GHz)

HARMONICS AND SPURIOUS EMISSIONS (LOW CHANNEL, WORST-CASE CONFIGURATION, HORIZONTAL)

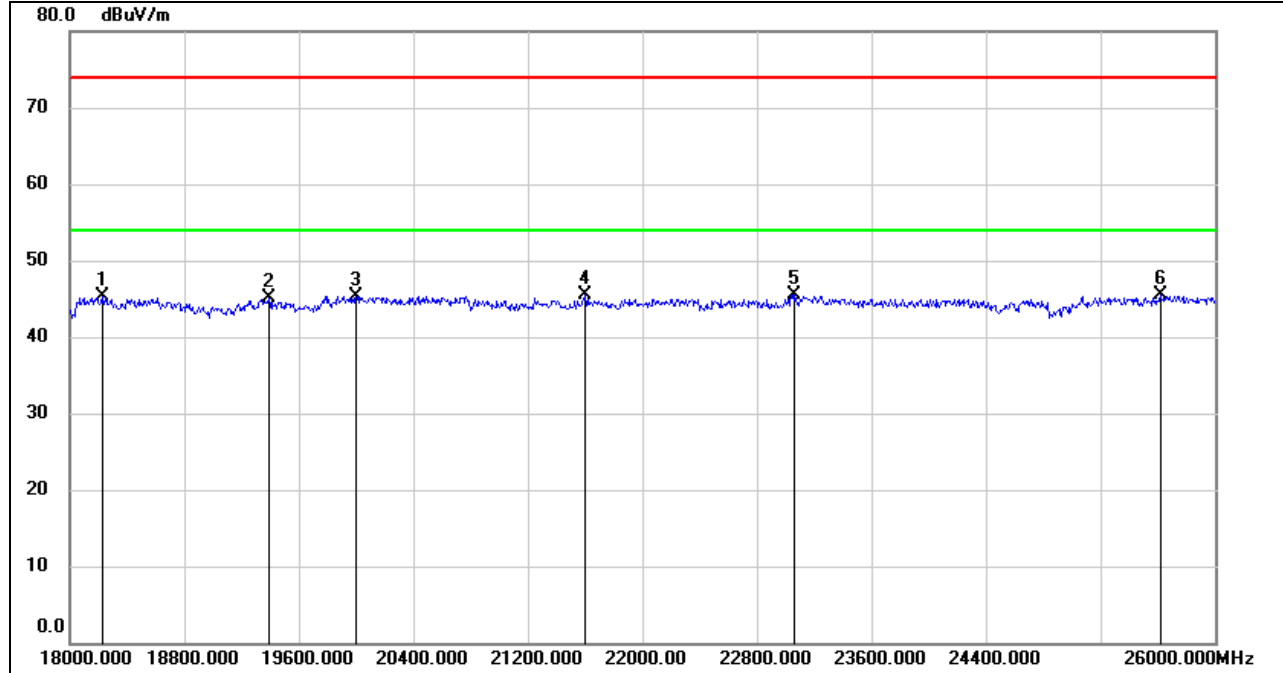

No.	Frequency (MHz)	Reading (dBuV)	Correct (dB/m)	Result (dBuV/m)	Limit (dBuV/m)	Margin (dB)	Remark
1	18224.000	50.77	-5.53	45.24	74.00	-28.76	peak
2	19392.000	50.62	-5.57	45.05	74.00	-28.95	peak
3	20000.000	50.81	-5.45	45.36	74.00	-28.64	peak
4	21600.000	50.02	-4.54	45.48	74.00	-28.52	peak
5	23064.000	48.99	-3.42	45.57	74.00	-28.43	peak
6	25616.000	46.68	-1.24	45.44	74.00	-28.56	peak

- Note: 1. Measurement = Reading Level + Correct Factor.
 2. If Peak Result complies with AV limit, AV Result is deemed to comply with AV limit.
 3. Peak: Peak detector.



HARMONICS AND SPURIOUS EMISSIONS (LOW CHANNEL, WORST-CASE CONFIGURATION, VERTICAL)

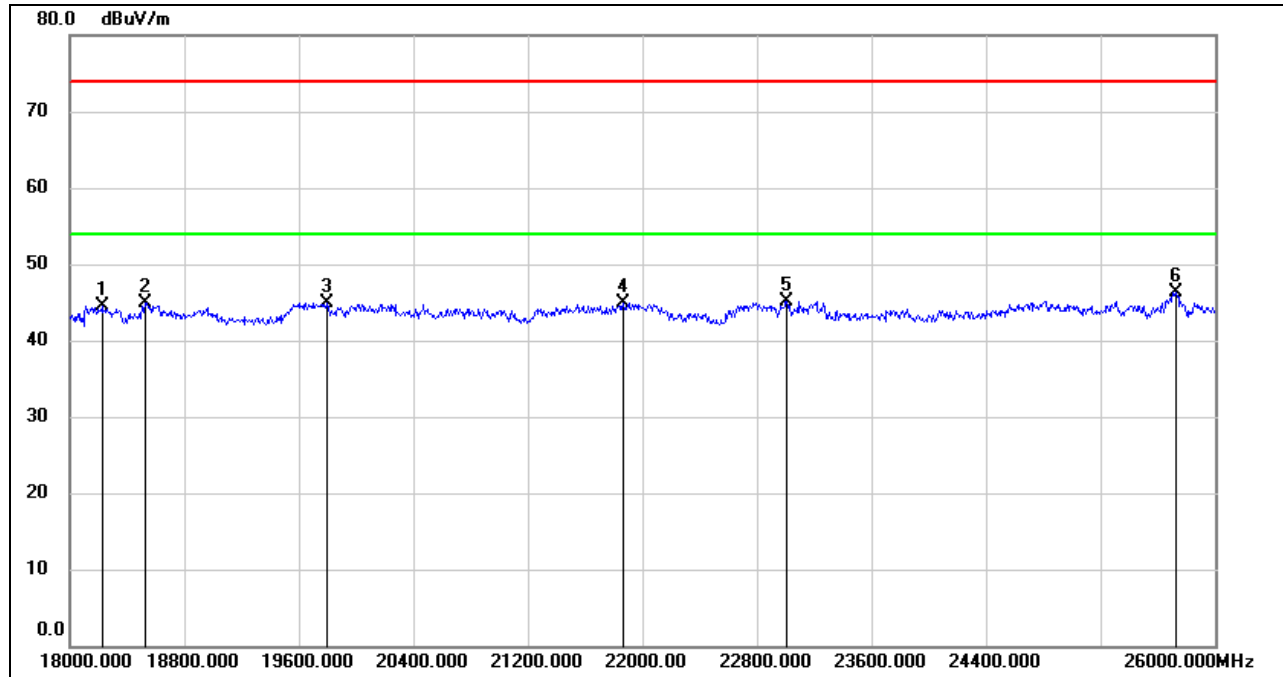

No.	Frequency (MHz)	Reading (dBuV)	Correct (dB/m)	Result (dBuV/m)	Limit (dBuV/m)	Margin (dB)	Remark
1	18224.000	50.08	-5.53	44.55	74.00	-29.45	peak
2	18528.000	50.11	-5.26	44.85	74.00	-29.15	peak
3	19792.000	50.20	-5.29	44.91	74.00	-29.09	peak
4	21864.000	49.38	-4.40	44.98	74.00	-29.02	peak
5	23008.000	48.60	-3.44	45.16	74.00	-28.84	peak
6	25728.000	47.11	-0.72	46.39	74.00	-27.61	peak

Note: 1. Measurement = Reading Level + Correct Factor.
 2. If Peak Result complies with AV limit, AV Result is deemed to comply with AV limit.
 3. Peak: Peak detector.

Note: All test modes had been tested, only the worst data record in the report.

7.6. SPURIOUS EMISSIONS BELOW 30 MHz

SPURIOUS EMISSIONS (LOW CHANNEL, LOOP ANTENNA FACE ON TO THE EUT, WORST-CASE CONFIGURATION)

9 kHz ~ 150 kHz

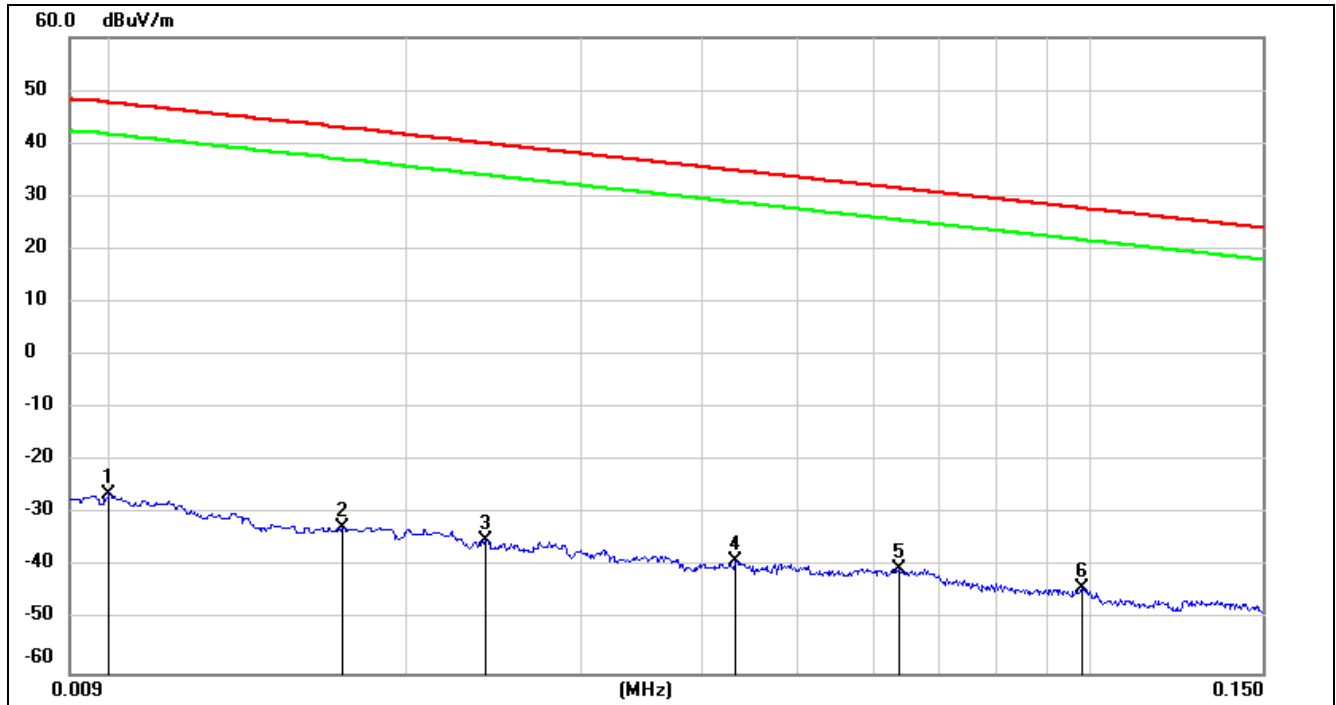

No.	Frequency (MHz)	Reading (dBuV)	Correct (dB/m)	FCC Result (dBuV/m)	FCC Limit (dBuV/m)	ISED Result (dBuA/m)	ISED Limit (dBuA/m)	Margin (dB)	Remark
1	0.0100	75.22	-101.40	-26.18	47.6	-77.68	-3.90	-73.78	peak
2	0.0171	68.88	-101.36	-32.48	42.94	-83.98	-8.56	-75.42	peak
3	0.0240	66.32	-101.36	-35.04	40	-86.54	-11.50	-75.04	peak
4	0.0432	62.57	-101.45	-38.88	34.89	-90.38	-16.61	-73.77	peak
5	0.0636	61.31	-101.54	-40.23	31.53	-91.73	-19.97	-71.76	peak
6	0.0981	57.77	-101.78	-44.01	27.77	-95.51	-23.73	-71.78	peak

Note: 1. Measurement = Reading Level + Correct Factor.

2. If Peak Result complies with AV and QP limit, AV and QP Result are deemed to comply with AV limit.

3. All 3 polarizations (Horizontal, Face-on and Face-off) of the loop antenna had been tested, but only the worst data recorded in the report.

4. $\text{dBuA/m} = \text{dBuV/m} - 20\log_{10}(120\pi) = \text{dBuV/m} - 51.5$.



150 kHz ~ 490 kHz

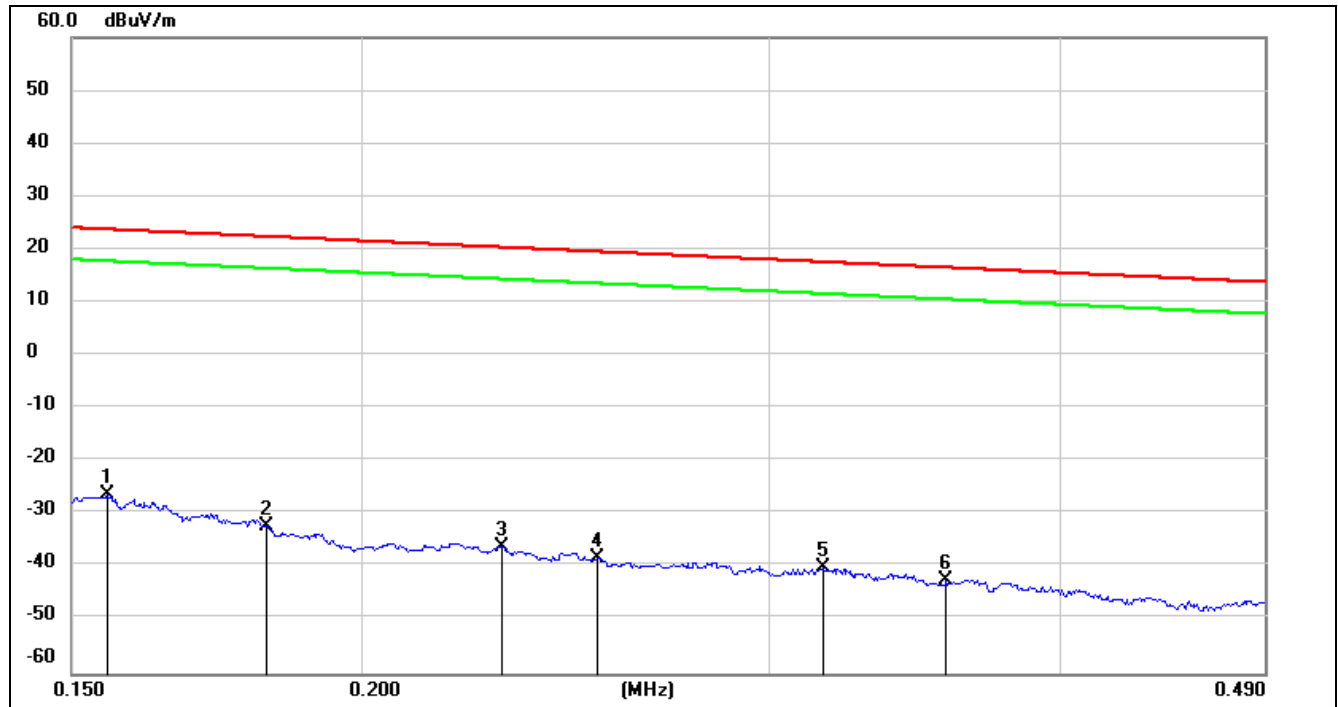

No.	Frequency (MHz)	Reading (dBuV)	Correct (dB/m)	FCC Result (dBuV/m)	FCC Limit (dBuV/m)	ISED Result (dBuA/m)	ISED Limit (dBuA/m)	Margin (dB)	Remark
1	0.1554	75.27	-101.65	-26.38	23.77	-77.88	-27.73	-50.15	peak
2	0.1819	69.49	-101.68	-32.19	22.41	-83.69	-29.09	-54.60	peak
3	0.2298	65.55	-101.77	-36.22	20.37	-87.72	-31.13	-56.59	peak
4	0.2530	63.64	-101.80	-38.16	19.54	-89.66	-31.96	-57.70	peak
5	0.3163	61.70	-101.87	-40.17	17.6	-91.67	-33.90	-57.77	peak
6	0.3573	59.58	-101.91	-42.33	16.54	-93.83	-34.96	-58.87	peak

Note: 1. Measurement = Reading Level + Correct Factor.

2. If Peak Result complies with AV and QP limit, AV and QP Result are deemed to comply with AV limit.

3. All 3 polarizations (Horizontal, Face-on and Face-off) of the loop antenna had been tested, but only the worst data recorded in the report.

4. $\text{dBuA/m} = \text{dBuV/m} - 20\log_{10}(120\pi) = \text{dBuV/m} - 51.5$.

490 kHz ~ 30 MHz

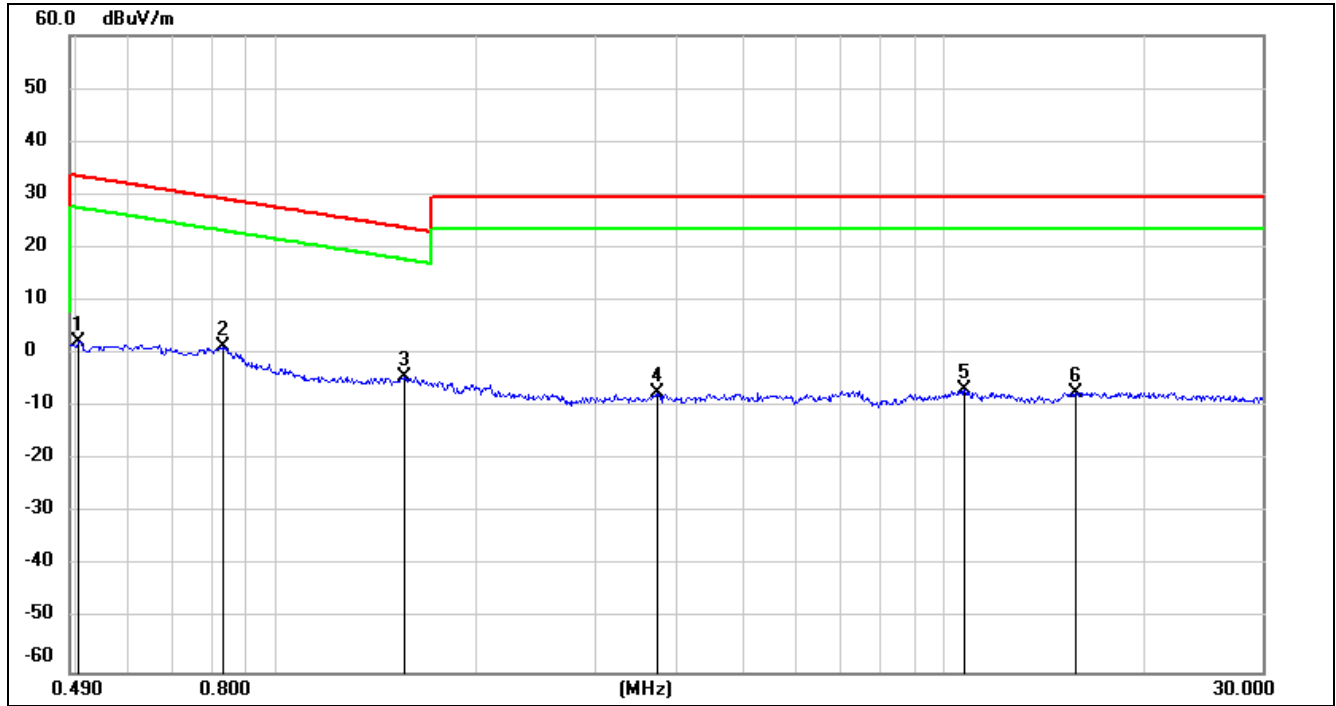

No.	Frequency (MHz)	Reading (dBuV)	Correct (dB/m)	FCC Result (dBuV/m)	FCC Limit (dBuV/m)	ISED Result (dBuA/m)	ISED Limit (dBuA/m)	Margin (dB)	Remark
1	0.5039	64.44	-62.07	2.37	33.56	-49.13	-17.94	-31.19	peak
2	0.8296	63.44	-62.17	1.27	29.23	-50.23	-22.27	-27.96	peak
3	1.5564	57.68	-62.02	-4.34	23.76	-55.84	-27.74	-28.10	peak
4	3.7100	54.20	-61.41	-7.21	29.54	-58.71	-21.96	-36.75	peak
5	10.7299	53.98	-60.83	-6.85	29.54	-58.35	-21.96	-36.39	peak
6	15.7759	53.75	-60.99	-7.24	29.54	-58.74	-21.96	-36.78	peak

Note: 1. Measurement = Reading Level + Correct Factor.

2. If Peak Result complies with AV and QP limit, AV and QP Result are deemed to comply with AV limit.

3. All 3 polarizations (Horizontal, Face-on and Face-off) of the loop antenna had been tested, but only the worst data recorded in the report.

4. $\text{dBuA/m} = \text{dBuV/m} - 20\log_{10}(120\pi) = \text{dBuV/m} - 51.5$.

Note: All test modes had been tested, only the worst data record in the report.

7.7. SPURIOUS EMISSIONS BELOW 1 GHz AND ABOVE 30 MHz

SPURIOUS EMISSIONS (LOW CHANNEL, WORST-CASE CONFIGURATION, HORIZONTAL)

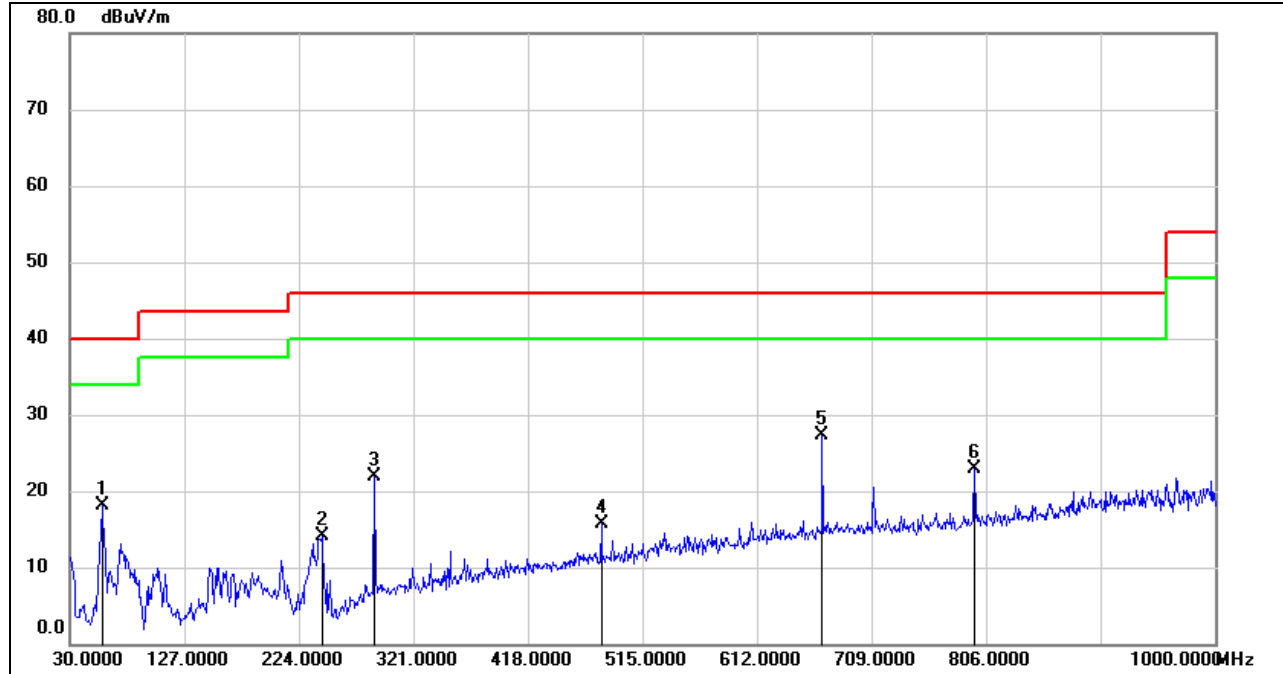

No.	Frequency (MHz)	Reading (dBuV)	Correct (dB/m)	Result (dBuV/m)	Limit (dBuV/m)	Margin (dB)	Remark
1	57.1600	38.65	-20.58	18.07	40.00	-21.93	QP
2	243.4000	33.28	-19.08	14.20	46.00	-31.80	QP
3	288.0200	37.91	-16.06	21.85	46.00	-24.15	QP
4	480.0800	27.42	-11.79	15.63	46.00	-30.37	QP
5	667.2900	35.86	-8.65	27.21	46.00	-18.79	QP
6	796.3000	30.23	-7.35	22.88	46.00	-23.12	QP

- Note: 1. Result Level = Read Level + Correct Factor.
 2. If Peak Result complies with QP limit, QP Result is deemed to comply with QP limit.
 3. Test setup: RBW: 120 kHz, VBW: 300 kHz, Sweep time: auto.

SPURIOUS EMISSIONS (LOW CHANNEL, WORST-CASE CONFIGURATION, VERTICAL)

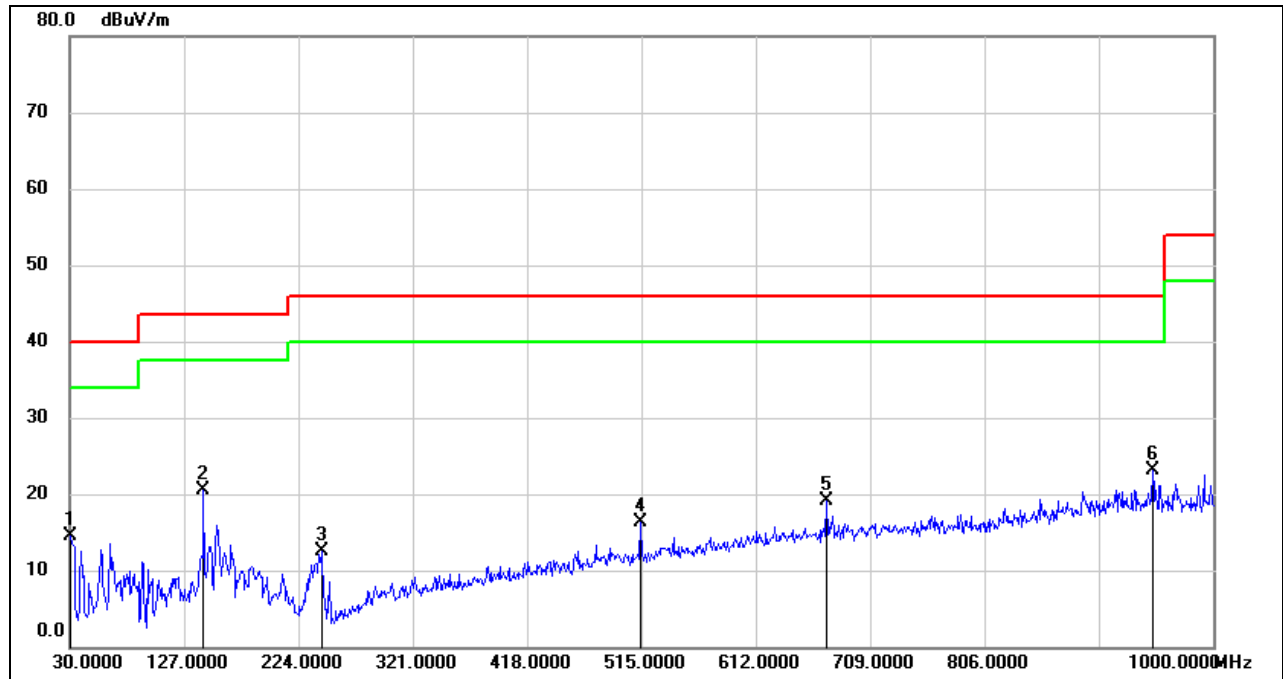

No.	Frequency (MHz)	Reading (dBuV)	Correct (dB/m)	Result (dBuV/m)	Limit (dBuV/m)	Margin (dB)	Remark
1	30.9700	33.53	-19.04	14.49	40.00	-25.51	QP
2	143.4900	39.10	-18.66	20.44	43.50	-23.06	QP
3	243.4000	31.55	-19.08	12.47	46.00	-33.53	QP
4	514.0300	27.48	-11.18	16.30	46.00	-29.70	QP
5	672.1400	27.76	-8.64	19.12	46.00	-26.88	QP
6	948.5900	27.58	-4.42	23.16	46.00	-22.84	QP

- Note: 1. Result Level = Read Level + Correct Factor.
 2. If Peak Result complies with QP limit, QP Result is deemed to comply with QP limit.
 3. Test setup: RBW: 120 kHz, VBW: 300 kHz, Sweep time: auto

Note: All the channels have been tested, only the worst data was recorded in the report.



8. AC POWER LINE CONDUCTED EMISSIONS

LIMITS

Please refer to CFR 47 FCC §15.207 (a) and ISED RSS-Gen Clause 8.8

FREQUENCY (MHz)	Quasi-peak	Average
0.15 -0.5	66 - 56 *	56 - 46 *
0.50 -5.0	56.00	46.00
5.0 -30.0	60.00	50.00

Note:

- (1) The tighter limit applies at the band edges.
- (2) The limit of " * " marked band means the limitation decreases linearly with the logarithm of the frequency in the range.

TEST SETUP AND PROCEDURE

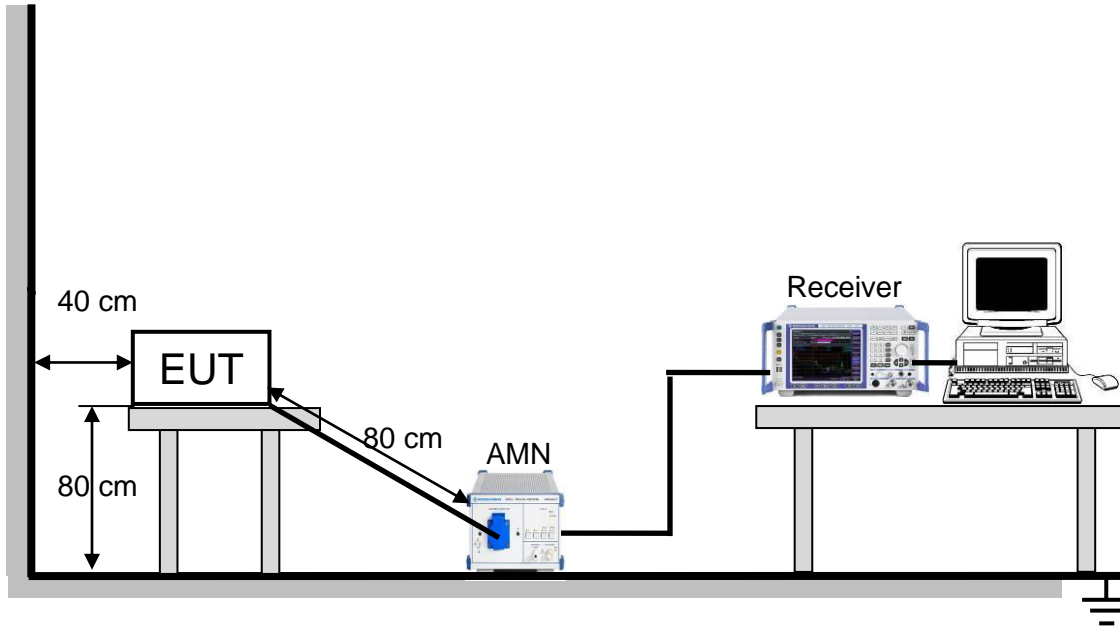

The following table is the setting of the receiver

Receiver Parameters	Setting
Attenuation	10 dB
Start Frequency	0.15 MHz
Stop Frequency	30 MHz
IF Bandwidth	9 kHz

1. The testing follows the guidelines in ANSI C63.10-2013.
2. The EUT was placed on the top of a rotating table 0.8 meters above the horizontal ground plane and being connected to the power mains through a line impedance stabilization network (LISN). All other support equipment powered from additional LISN(s). The LISN provide 50 ohm/ 50 uH of coupling impedance for the measuring instrument.
3. Interconnecting cables that hang closer than 40 cm to the ground plane shall be folded back and forth in the center forming a bundle 30 to 40 cm long.
4. I/O cables that are not connected to a peripheral shall be bundled in the center. The end of the cable may be terminated, if required, using the correct terminating impedance. The overall length shall not exceed 1 m.
5. LISN at least 80 cm from nearest part of EUT chassis.
6. Conducted emissions from the EUT measured in the frequency range between 0.15 MHz and 30MHz using CISPR Quasi-Peak and average detector mode.
7. The arrangement of the equipment is installed to meet the standards and operating in a manner, which tends to maximize its emission characteristics in a normal application.



TEST ENVIRONMENT

Temperature	24.3 °C	Relative Humidity	69.1 %
Atmosphere Pressure	101 kPa	Test Voltage	AC 120 V, 60 Hz

LINE N RESULTS (LOW CHANNEL, WORST-CASE CONFIGURATION)

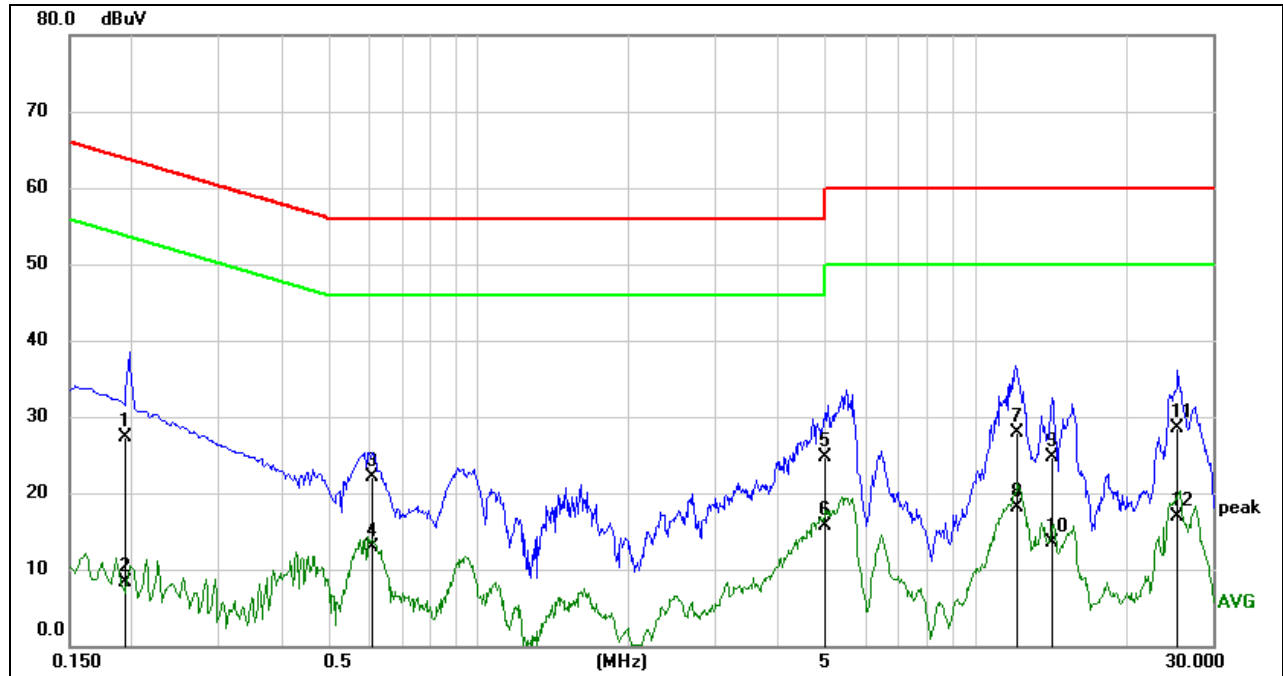

No.	Frequency (MHz)	Reading (dBuV)	Correct (dB)	Result (dBuV)	Limit (dBuV)	Margin (dB)	Remark
1	0.1941	27.74	-0.40	27.34	63.86	-36.52	QP
2	0.1941	8.61	-0.40	8.21	53.86	-45.65	AVG
3	0.6109	22.48	-0.40	22.08	56.00	-33.92	QP
4	0.6109	13.33	-0.40	12.93	46.00	-33.07	AVG
5	5.0249	25.06	-0.40	24.66	60.00	-35.34	QP
6	5.0249	16.18	-0.40	15.78	50.00	-34.22	AVG
7	12.0973	28.70	-0.88	27.82	60.00	-32.18	QP
8	12.0973	18.94	-0.88	18.06	50.00	-31.94	AVG
9	14.3182	25.73	-0.97	24.76	60.00	-35.24	QP
10	14.3182	14.50	-0.97	13.53	50.00	-36.47	AVG
11	25.5200	29.82	-1.26	28.56	60.00	-31.44	QP
12	25.5200	18.19	-1.26	16.93	50.00	-33.07	AVG

- Note: 1. Result = Reading +Correct Factor.
2. If QP Result complies with AV limit, AV Result is deemed to comply with AV limit.

LINE L RESULTS (LOW CHANNEL, WORST-CASE CONFIGURATION)

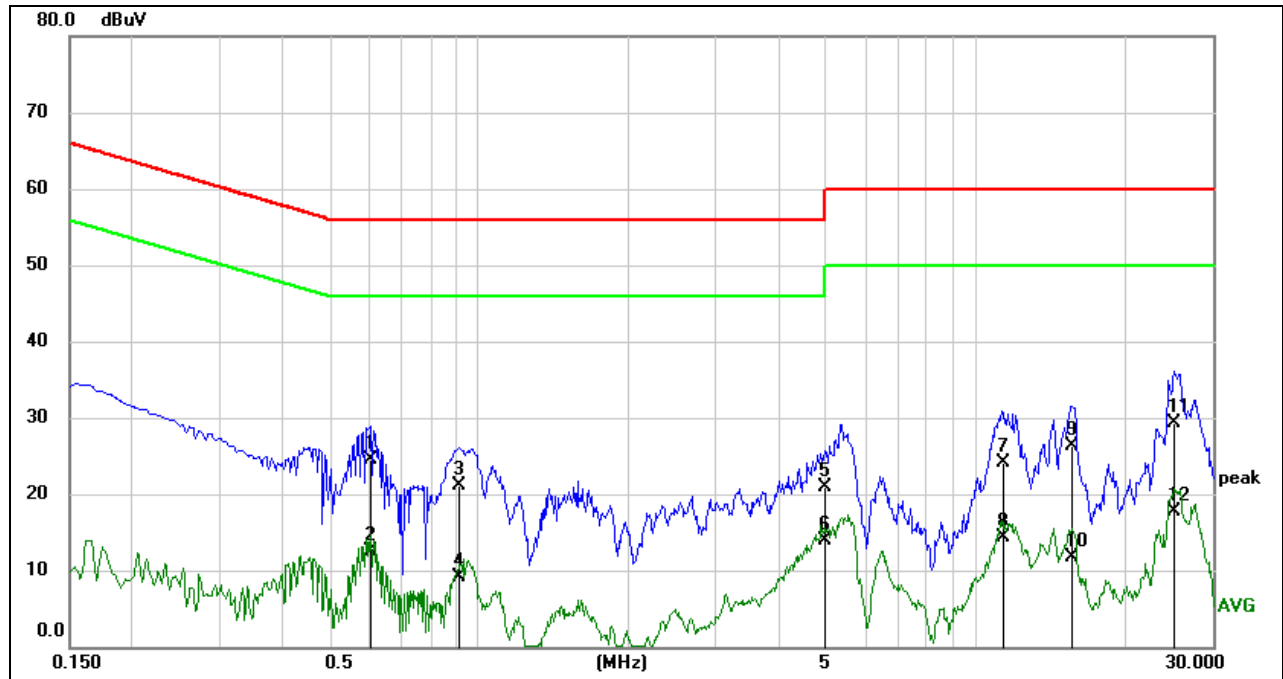

No.	Frequency (MHz)	Reading (dBuV)	Correct (dB)	Result (dBuV)	Limit (dBuV)	Margin (dB)	Remark
1	0.6035	24.94	-0.40	24.54	56.00	-31.46	QP
2	0.6035	12.93	-0.40	12.53	46.00	-33.47	AVG
3	0.9210	21.30	-0.22	21.08	56.00	-34.92	QP
4	0.9210	9.26	-0.22	9.04	46.00	-36.96	AVG
5	5.0049	21.38	-0.40	20.98	60.00	-39.02	QP
6	5.0049	14.34	-0.40	13.94	50.00	-36.06	AVG
7	11.3709	24.96	-0.85	24.11	60.00	-35.89	QP
8	11.3709	15.15	-0.85	14.30	50.00	-35.70	AVG
9	15.6598	27.38	-1.03	26.35	60.00	-33.65	QP
10	15.6598	12.79	-1.03	11.76	50.00	-38.24	AVG
11	25.0884	30.48	-1.25	29.23	60.00	-30.77	QP
12	25.0884	18.93	-1.25	17.68	50.00	-32.32	AVG

Note: 1. Result = Reading +Correct Factor.
2. If QP Result complies with AV limit, AV Result is deemed to comply with AV limit.

Note: All test modes had been tested, only the worst data record in the report.



9. ANTENNA REQUIREMENTS

APPLICABLE REQUIREMENTS

Please refer to FCC §15.203

An intentional radiator shall be designed to ensure that no antenna other than that furnished by the responsible party shall be used with the device. The use of a permanently attached antenna or of an antenna that uses a unique coupling to the intentional radiator shall be considered sufficient to comply with the provisions of this section. The manufacturer may design the unit so that a broken antenna can be replaced by the user, but the use of a standard antenna jack or electrical connector is prohibited.

Please refer to FCC §15.247(b)(4)

The conducted output power limit specified in paragraph (b) of this section is based on the use of antennas with directional gains that do not exceed 6 dBi. Except as shown in paragraph (c) of this section, if transmitting antennas of directional gain greater than 6 dBi are used, the conducted output power from the intentional radiator shall be reduced below the stated values in paragraphs (b)(1), (b)(2), and (b)(3) of this section, as appropriate, by the amount in dB that the directional gain of the antenna exceeds 6 dBi.

RESULTS

Complies

END OF REPORT