

HARMONICS AND SPURIOUS EMISSIONS (HIGH CHANNEL, VERTICAL)

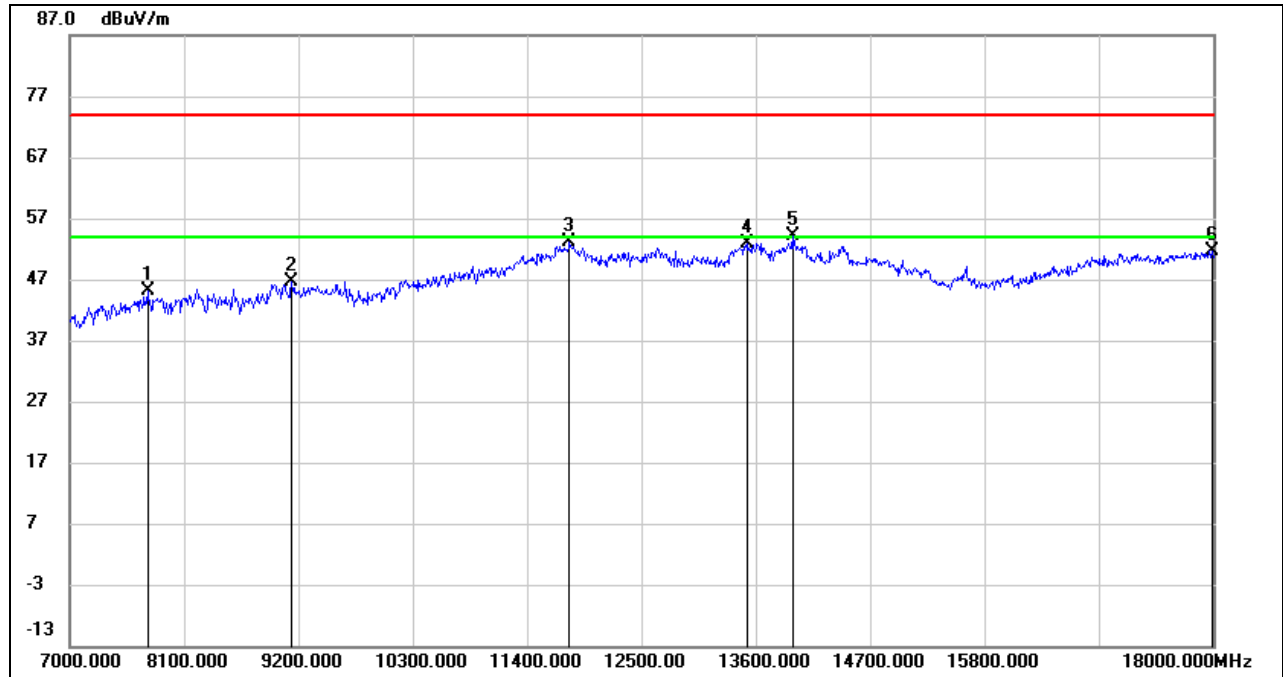

No.	Frequency (MHz)	Reading (dBuV)	Correct (dB/m)	Result (dBuV/m)	Limit (dBuV/m)	Margin (dB)	Remark
1	7753.500	39.13	5.92	45.05	74.00	-28.95	peak
2	9134.000	37.87	8.78	46.65	74.00	-27.35	peak
3	11807.000	35.79	17.22	53.01	74.00	-20.99	peak
4	13528.500	33.29	19.62	52.91	74.00	-21.09	peak
5	13952.000	33.44	20.61	54.05	74.00	-19.95	peak
6	17989.000	28.04	23.65	51.69	74.00	-22.31	peak

Note: 1. Measurement = Reading Level + Correct Factor.
 2. If Peak Result complies with AV limit, AV Result is deemed to comply with AV limit.
 3. Peak: Peak detector.
 4. Filter losses were only considered in the spurious frequency bands and the authorized band was not corrected for High Pass Filter losses.
 5. Proper operation of the transmitter prior to adding the filter to the measurement chain.
 6. Since non-restricted band peak emissions are less than the average limit, they also comply with the -27dBm/MHz (68.2dBuV/m) limit.

8.3.3. 802.11ac VHT40 MODE

UNII-1 BAND

HARMONICS AND SPURIOUS EMISSIONS (LOW CHANNEL, HORIZONTAL)

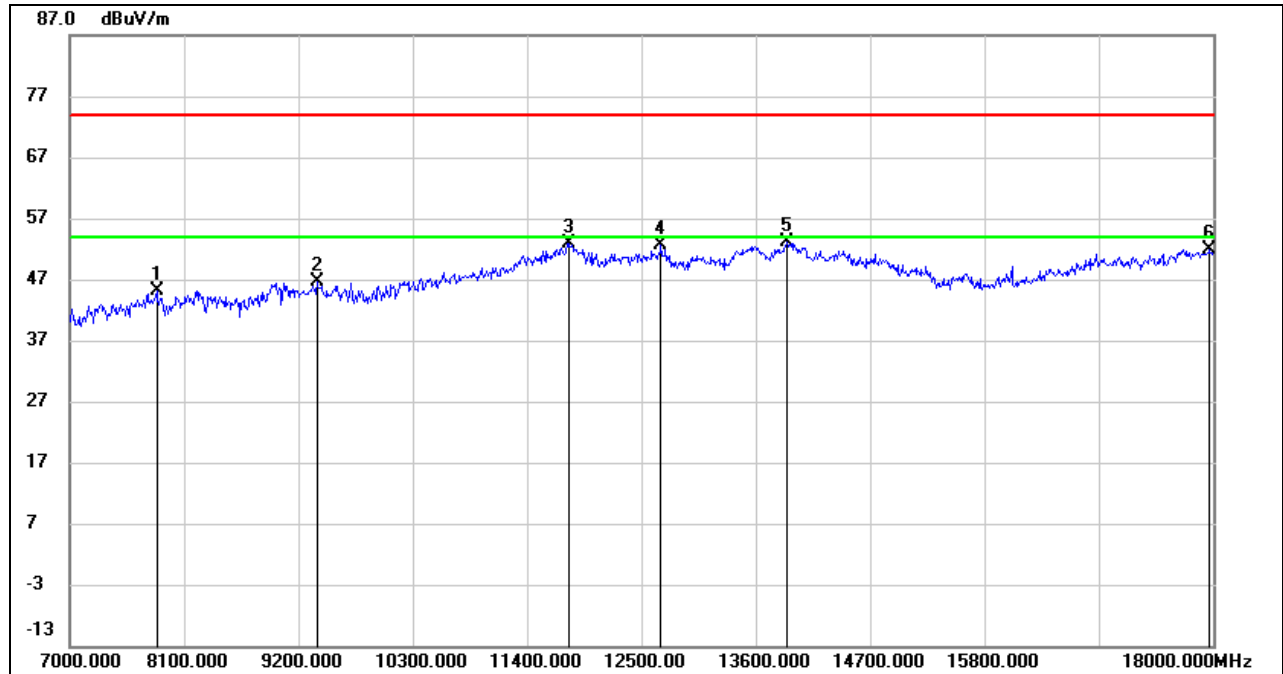

No.	Frequency (MHz)	Reading (dBuV)	Correct (dB/m)	Result (dBuV/m)	Limit (dBuV/m)	Margin (dB)	Remark
1	7836.000	39.23	5.95	45.18	74.00	-28.82	peak
2	9376.000	37.09	9.53	46.62	74.00	-27.38	peak
3	11801.500	35.61	17.22	52.83	74.00	-21.17	peak
4	12692.500	35.56	17.03	52.59	74.00	-21.41	peak
5	13902.500	32.63	20.58	53.21	74.00	-20.79	peak
6	17967.000	28.27	23.59	51.86	74.00	-22.14	peak

Note: 1. Measurement = Reading Level + Correct Factor.
 2. If Peak Result complies with AV limit, AV Result is deemed to comply with AV limit.
 3. Peak: Peak detector.
 4. Filter losses were only considered in the spurious frequency bands and the authorized band was not corrected for High Pass Filter losses.
 5. Proper operation of the transmitter prior to adding the filter to the measurement chain.
 6. Since non-restricted band peak emissions are less than the average limit, they also comply with the -27dBm/MHz (68.2dBuV/m) limit.



HARMONICS AND SPURIOUS EMISSIONS (LOW CHANNEL, VERTICAL)

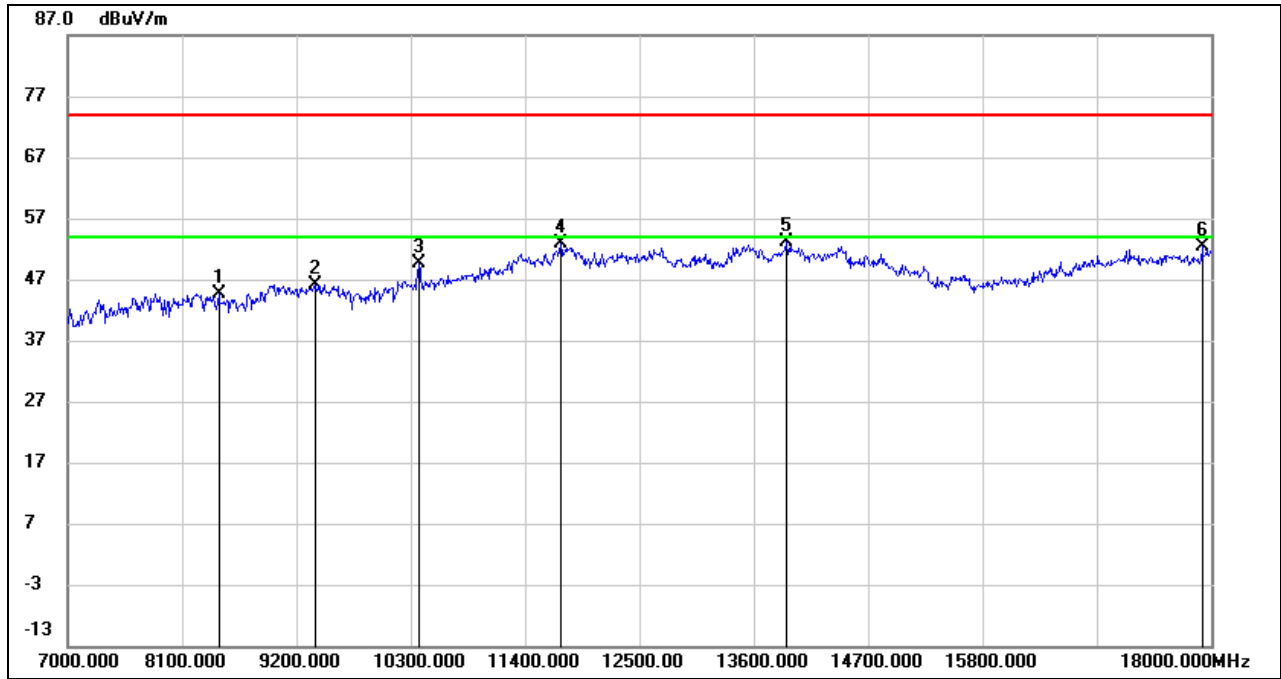

No.	Frequency (MHz)	Reading (dBuV)	Correct (dB/m)	Result (dBuV/m)	Limit (dBuV/m)	Margin (dB)	Remark
1	8457.500	38.00	6.66	44.66	74.00	-29.34	peak
2	9381.500	36.68	9.56	46.24	74.00	-27.76	peak
3	10377.000	38.13	11.38	49.51	74.00	-24.49	peak
4	11746.500	36.07	16.88	52.95	74.00	-21.05	peak
5	13919.000	32.61	20.58	53.19	74.00	-20.81	peak
6	17917.500	28.93	23.48	52.41	74.00	-21.59	peak

Note: 1. Measurement = Reading Level + Correct Factor.
 2. If Peak Result complies with AV limit, AV Result is deemed to comply with AV limit.
 3. Peak: Peak detector.
 4. Filter losses were only considered in the spurious frequency bands and the authorized band was not corrected for High Pass Filter losses.
 5. Proper operation of the transmitter prior to adding the filter to the measurement chain.
 6. Since non-restricted band peak emissions are less than the average limit, they also comply with the -27dBm/MHz (68.2dBuV/m) limit.

HARMONICS AND SPURIOUS EMISSIONS (HIGH CHANNEL, HORIZONTAL)

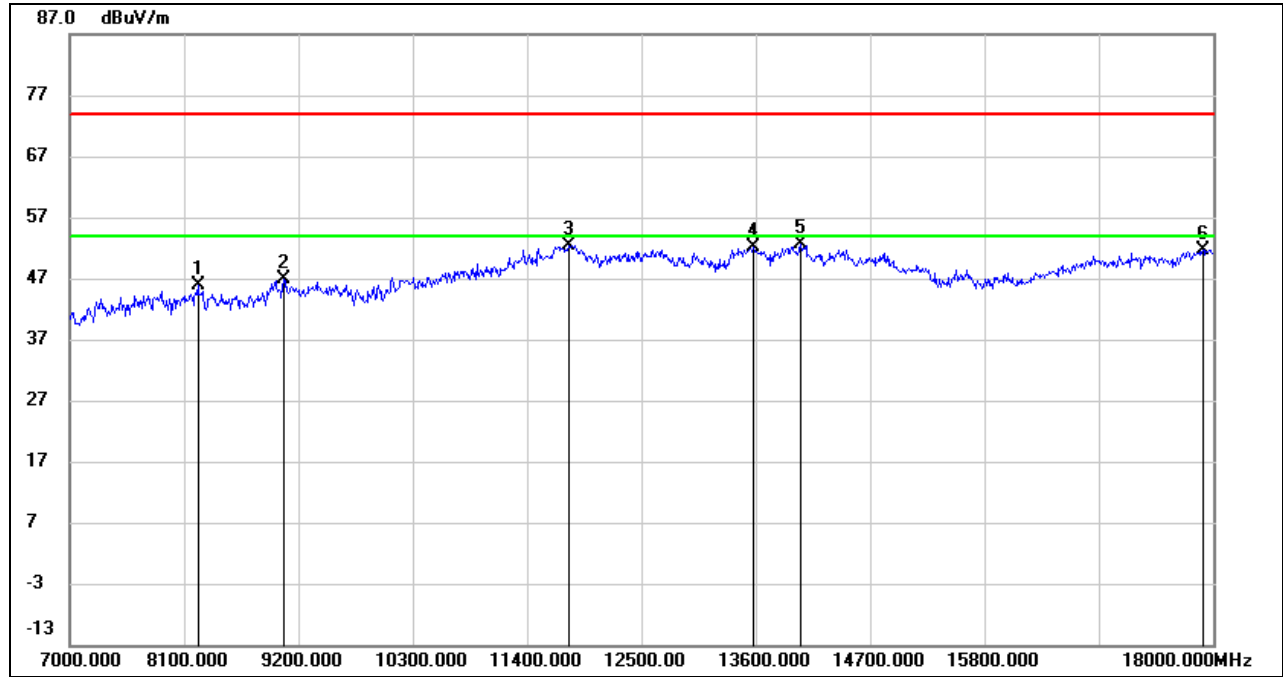

No.	Frequency (MHz)	Reading (dBuV)	Correct (dB/m)	Result (dBuV/m)	Limit (dBuV/m)	Margin (dB)	Remark
1	8232.000	38.84	7.14	45.98	74.00	-28.02	peak
2	9062.500	37.76	9.18	46.94	74.00	-27.06	peak
3	11796.000	35.27	17.19	52.46	74.00	-21.54	peak
4	13578.000	32.38	19.69	52.07	74.00	-21.93	peak
5	14029.000	32.03	20.50	52.53	74.00	-21.47	peak
6	17901.000	28.07	23.44	51.51	74.00	-22.49	peak

- Note: 1. Measurement = Reading Level + Correct Factor.
 2. If Peak Result complies with AV limit, AV Result is deemed to comply with AV limit.
 3. Peak: Peak detector.
 4. Filter losses were only considered in the spurious frequency bands and the authorized band was not corrected for High Pass Filter losses.
 5. Proper operation of the transmitter prior to adding the filter to the measurement chain.
 6. Since non-restricted band peak emissions are less than the average limit, they also comply with the -27dBm/MHz (68.2dBuV/m) limit.

HARMONICS AND SPURIOUS EMISSIONS (HIGH CHANNEL, VERTICAL)

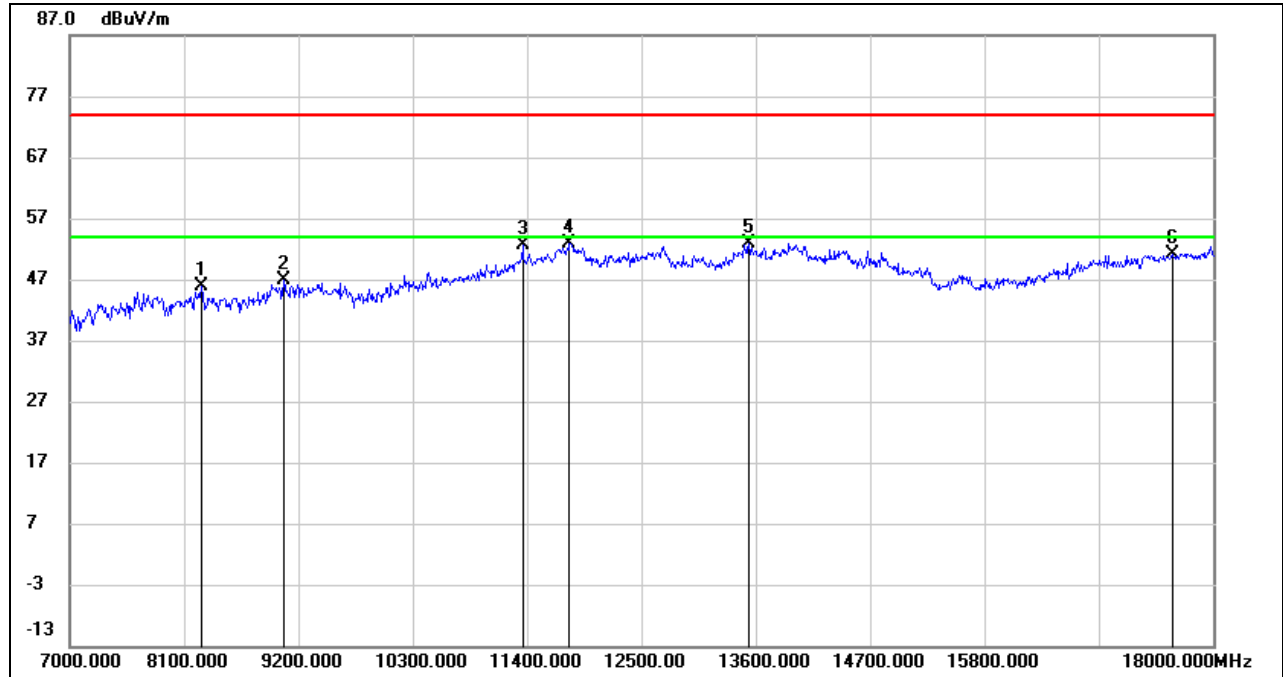

No.	Frequency (MHz)	Reading (dBuV)	Correct (dB/m)	Result (dBuV/m)	Limit (dBuV/m)	Margin (dB)	Remark
1	8270.500	38.77	7.02	45.79	74.00	-28.21	peak
2	9057.000	37.69	9.22	46.91	74.00	-27.09	peak
3	11356.000	37.59	15.04	52.63	74.00	-21.37	peak
4	11812.500	35.76	17.21	52.97	74.00	-21.03	peak
5	13534.000	33.25	19.63	52.88	74.00	-21.12	peak
6	17615.000	29.96	21.27	51.23	74.00	-22.77	peak

- Note: 1. Measurement = Reading Level + Correct Factor.
 2. If Peak Result complies with AV limit, AV Result is deemed to comply with AV limit.
 3. Peak: Peak detector.
 4. Filter losses were only considered in the spurious frequency bands and the authorized band was not corrected for High Pass Filter losses.
 5. Proper operation of the transmitter prior to adding the filter to the measurement chain.
 6. Since non-restricted band peak emissions are less than the average limit, they also comply with the -27dBm/MHz (68.2dBuV/m) limit.

UNII-2A BAND

HARMONICS AND SPURIOUS EMISSIONS (LOW CHANNEL, HORIZONTAL)

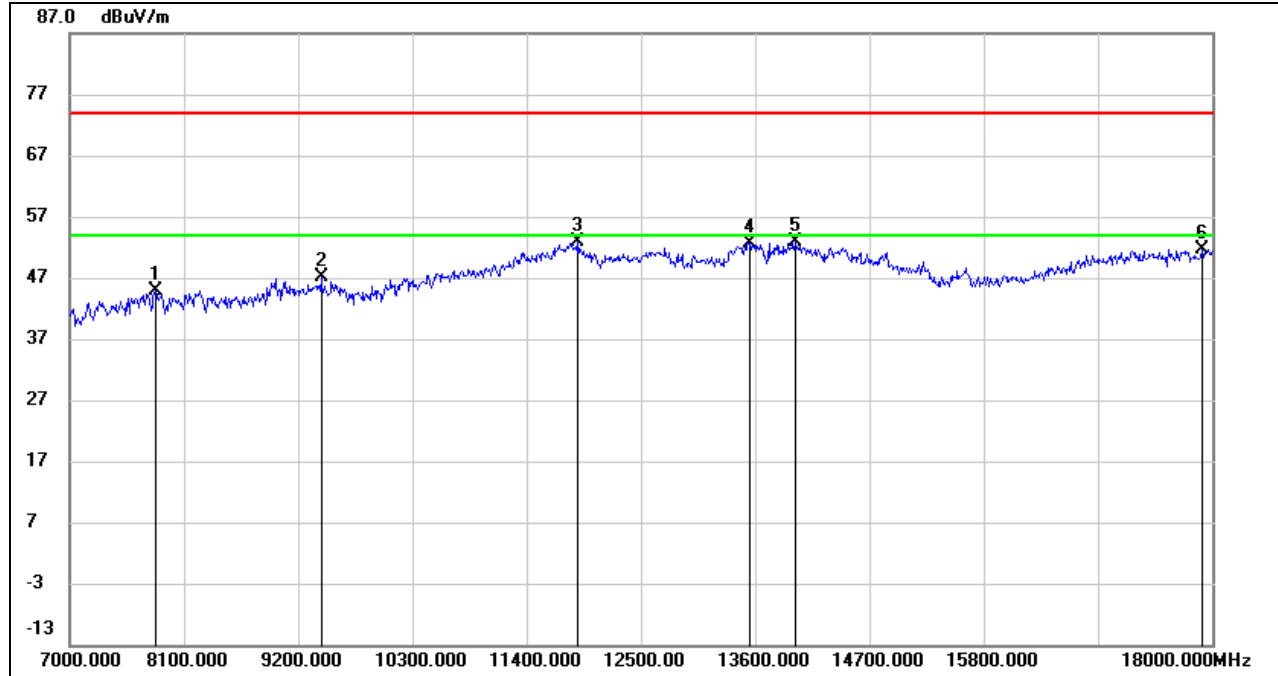

No.	Frequency (MHz)	Reading (dBuV)	Correct (dB/m)	Result (dBuV/m)	Limit (dBuV/m)	Margin (dB)	Remark
1	7825.000	38.89	5.99	44.88	74.00	-29.12	peak
2	9425.500	37.45	9.75	47.20	74.00	-26.80	peak
3	11900.500	35.61	17.16	52.77	74.00	-21.23	peak
4	13550.500	33.06	19.66	52.72	74.00	-21.28	peak
5	13985.000	32.34	20.63	52.97	74.00	-21.03	peak
6	17901.000	28.27	23.44	51.71	74.00	-22.29	peak

Note: 1. Measurement = Reading Level + Correct Factor.
 2. If Peak Result complies with AV limit, AV Result is deemed to comply with AV limit.
 3. Peak: Peak detector.
 4. Filter losses were only considered in the spurious frequency bands and the authorized band was not corrected for High Pass Filter losses.
 5. Proper operation of the transmitter prior to adding the filter to the measurement chain.
 6. Since non-restricted band peak emissions are less than the average limit, they also comply with the -27dBm/MHz (68.2dBuV/m) limit.



HARMONICS AND SPURIOUS EMISSIONS (LOW CHANNEL, VERTICAL)

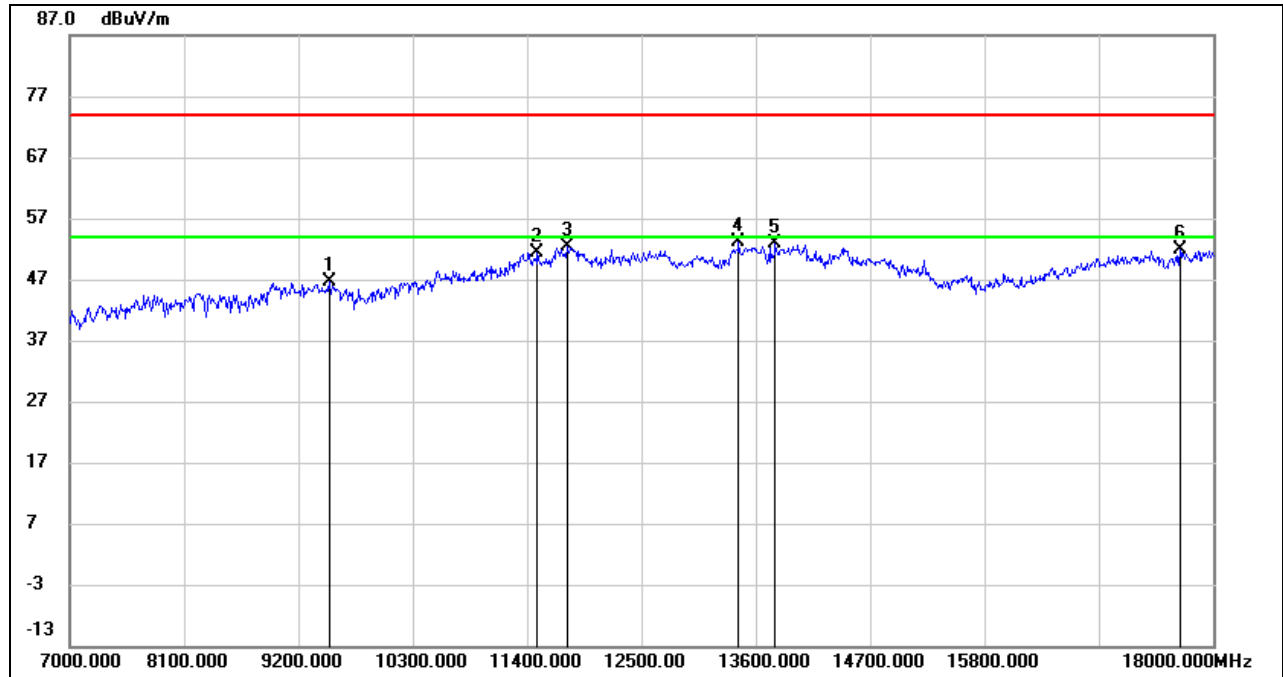

No.	Frequency (MHz)	Reading (dBuV)	Correct (dB/m)	Result (dBuV/m)	Limit (dBuV/m)	Margin (dB)	Remark
1	9502.500	36.65	9.93	46.58	74.00	-27.42	peak
2	11504.500	35.59	15.71	51.30	74.00	-22.70	peak
3	11785.000	35.37	17.12	52.49	74.00	-21.51	peak
4	13440.500	33.76	19.36	53.12	74.00	-20.88	peak
5	13787.000	32.35	20.45	52.80	74.00	-21.20	peak
6	17686.500	29.93	22.01	51.94	74.00	-22.06	peak

- Note: 1. Measurement = Reading Level + Correct Factor.
 2. If Peak Result complies with AV limit, AV Result is deemed to comply with AV limit.
 3. Peak: Peak detector.
 4. Filter losses were only considered in the spurious frequency bands and the authorized band was not corrected for High Pass Filter losses.
 5. Proper operation of the transmitter prior to adding the filter to the measurement chain.
 6. Since non-restricted band peak emissions are less than the average limit, they also comply with the -27dBm/MHz (68.2dBuV/m) limit.

HARMONICS AND SPURIOUS EMISSIONS (HIGH CHANNEL, HORIZONTAL)

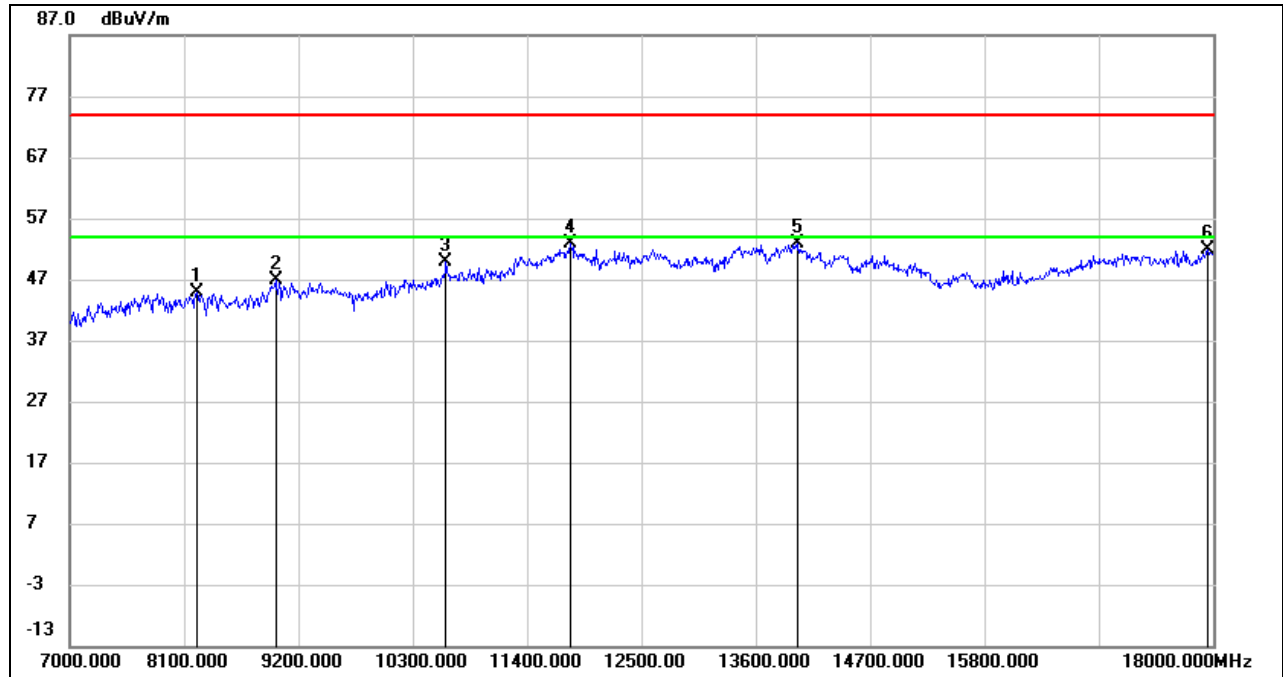

No.	Frequency (MHz)	Reading (dBuV)	Correct (dB/m)	Result (dBuV/m)	Limit (dBuV/m)	Margin (dB)	Remark
1	8221.000	37.64	7.16	44.80	74.00	-29.20	peak
2	8985.500	37.45	9.35	46.80	74.00	-27.20	peak
3	10619.000	37.59	12.30	49.89	74.00	-24.11	peak
4	11823.500	35.60	17.21	52.81	74.00	-21.19	peak
5	14007.000	32.19	20.61	52.80	74.00	-21.20	peak
6	17950.500	28.21	23.56	51.77	74.00	-22.23	peak

Note: 1. Measurement = Reading Level + Correct Factor.
 2. If Peak Result complies with AV limit, AV Result is deemed to comply with AV limit.
 3. Peak: Peak detector.
 4. Filter losses were only considered in the spurious frequency bands and the authorized band was not corrected for High Pass Filter losses.
 5. Proper operation of the transmitter prior to adding the filter to the measurement chain.
 6. Since non-restricted band peak emissions are less than the average limit, they also comply with the -27dBm/MHz (68.2dBuV/m) limit.

HARMONICS AND SPURIOUS EMISSIONS (HIGH CHANNEL, VERTICAL)

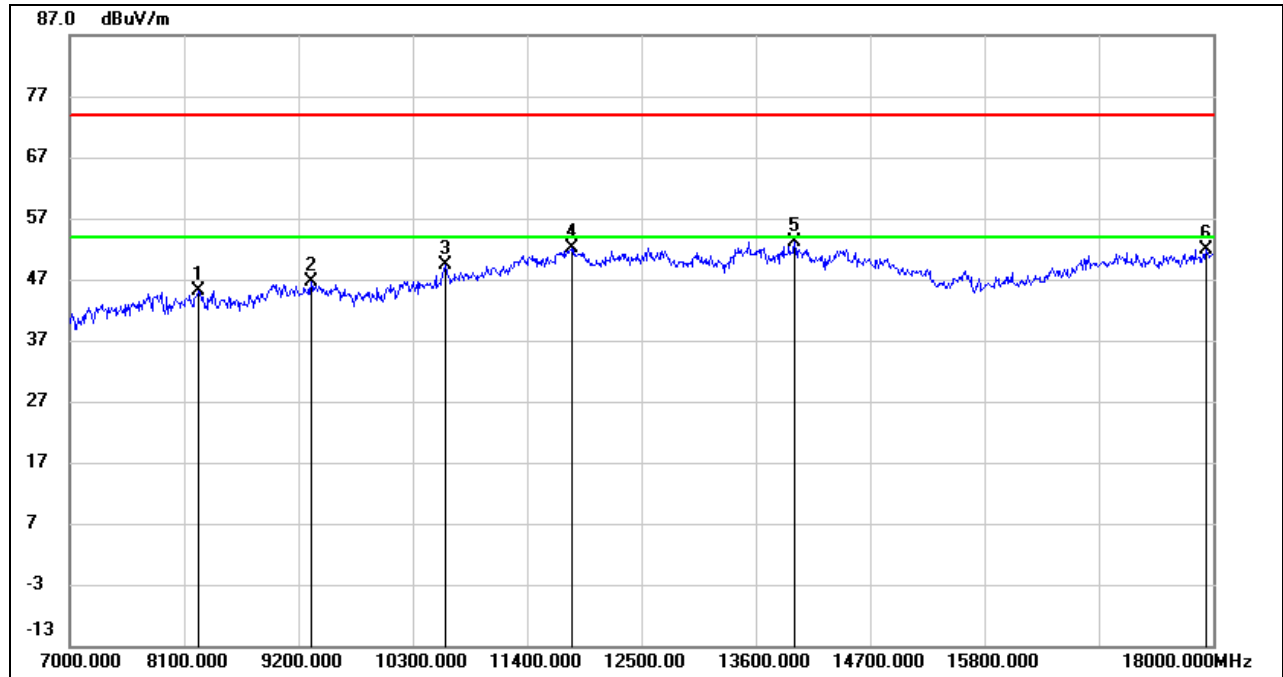

No.	Frequency (MHz)	Reading (dBuV)	Correct (dB/m)	Result (dBuV/m)	Limit (dBuV/m)	Margin (dB)	Remark
1	8243.000	37.93	7.10	45.03	74.00	-28.97	peak
2	9321.000	37.50	9.18	46.68	74.00	-27.32	peak
3	10608.000	37.15	12.27	49.42	74.00	-24.58	peak
4	11829.000	35.01	17.20	52.21	74.00	-21.79	peak
5	13979.500	32.40	20.63	53.03	74.00	-20.97	peak
6	17934.000	28.46	23.52	51.98	74.00	-22.02	peak

Note: 1. Measurement = Reading Level + Correct Factor.
 2. If Peak Result complies with AV limit, AV Result is deemed to comply with AV limit.
 3. Peak: Peak detector.
 4. Filter losses were only considered in the spurious frequency bands and the authorized band was not corrected for High Pass Filter losses.
 5. Proper operation of the transmitter prior to adding the filter to the measurement chain.
 6. Since non-restricted band peak emissions are less than the average limit, they also comply with the -27dBm/MHz (68.2dBuV/m) limit.

UNII-2C BAND

HARMONICS AND SPURIOUS EMISSIONS (LOW CHANNEL, HORIZONTAL)

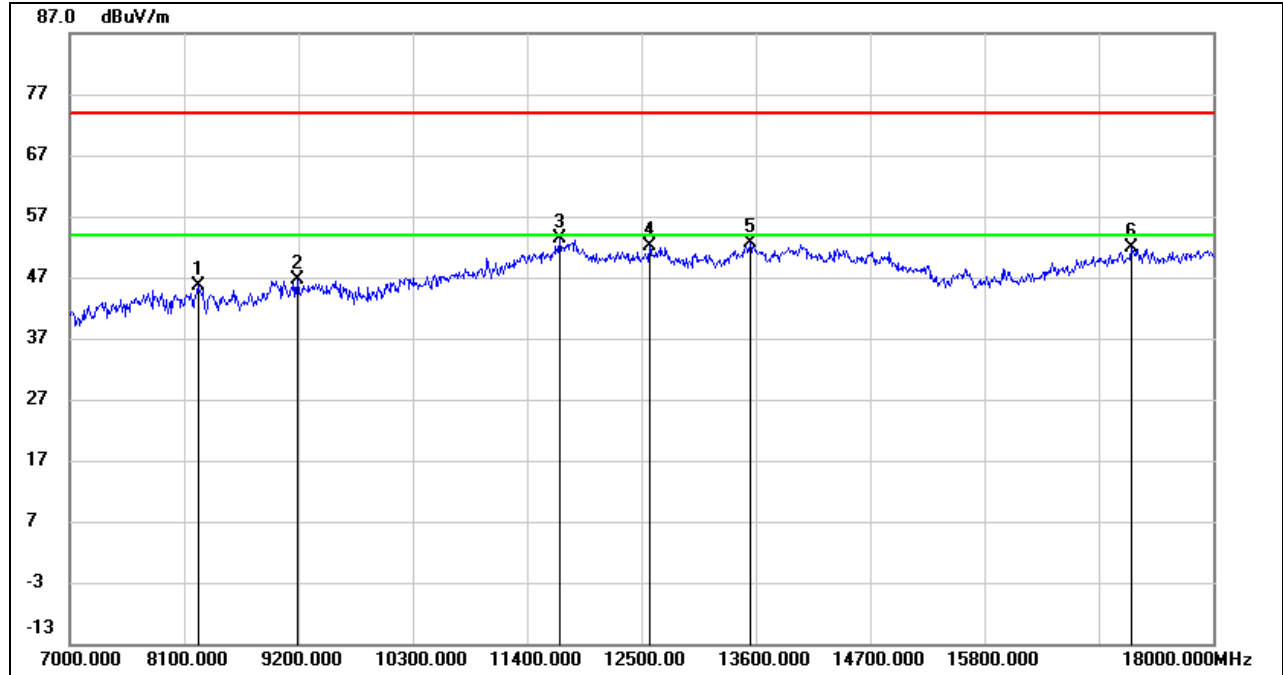

No.	Frequency (MHz)	Reading (dBuV)	Correct (dB/m)	Result (dBuV/m)	Limit (dBuV/m)	Margin (dB)	Remark
1	8232.000	38.47	7.14	45.61	74.00	-28.39	peak
2	9194.500	38.13	8.44	46.57	74.00	-27.43	peak
3	11719.000	36.58	16.71	53.29	74.00	-20.71	peak
4	12582.500	35.20	16.82	52.02	74.00	-21.98	peak
5	13545.000	33.09	19.64	52.73	74.00	-21.27	peak
6	17213.500	31.74	20.16	51.90	74.00	-22.10	peak

Note: 1. Measurement = Reading Level + Correct Factor.
 2. If Peak Result complies with AV limit, AV Result is deemed to comply with AV limit.
 3. Peak: Peak detector.
 4. Filter losses were only considered in the spurious frequency bands and the authorized band was not corrected for High Pass Filter losses.
 5. Proper operation of the transmitter prior to adding the filter to the measurement chain.
 6. Since non-restricted band peak emissions are less than the average limit, they also comply with the -27dBm/MHz (68.2dBuV/m) limit.

HARMONICS AND SPURIOUS EMISSIONS (LOW CHANNEL, VERTICAL)

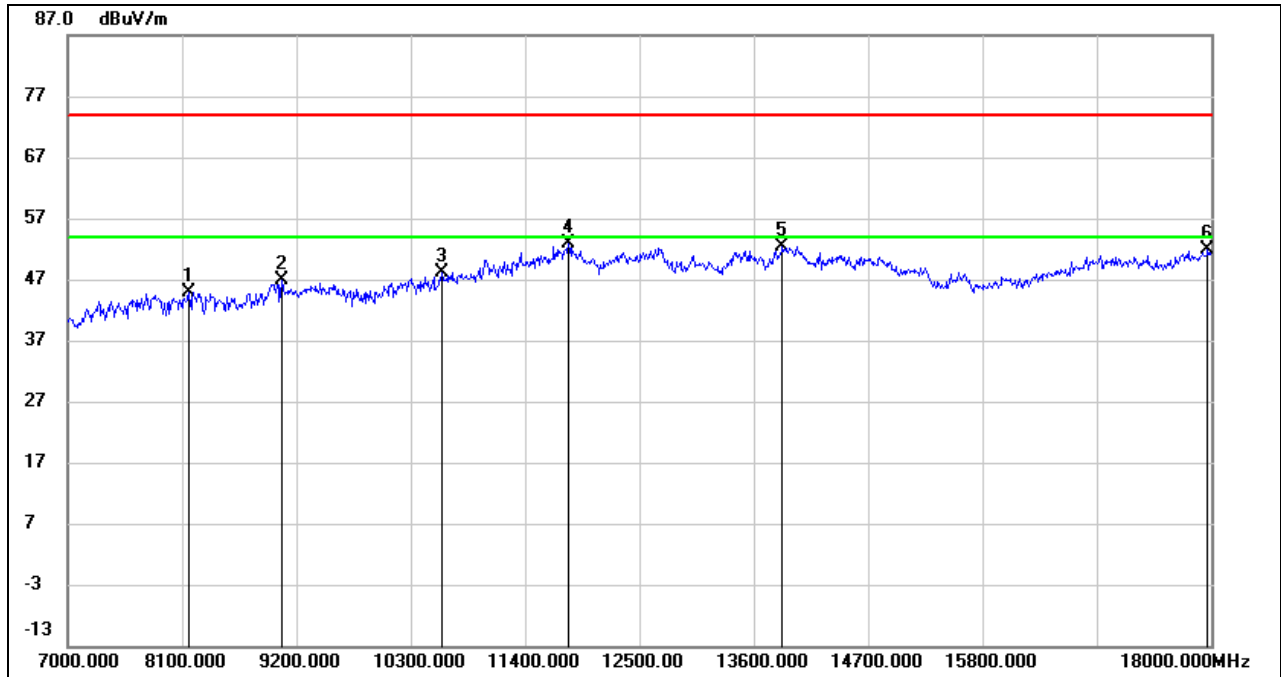

No.	Frequency (MHz)	Reading (dBuV)	Correct (dB/m)	Result (dBuV/m)	Limit (dBuV/m)	Margin (dB)	Remark
1	8166.000	38.08	6.90	44.98	74.00	-29.02	peak
2	9062.500	37.70	9.18	46.88	74.00	-27.12	peak
3	10597.000	35.91	12.25	48.16	74.00	-25.84	peak
4	11823.500	35.58	17.21	52.79	74.00	-21.21	peak
5	13880.500	31.87	20.56	52.43	74.00	-21.57	peak
6	17967.000	28.30	23.59	51.89	74.00	-22.11	peak

Note: 1. Measurement = Reading Level + Correct Factor.
 2. If Peak Result complies with AV limit, AV Result is deemed to comply with AV limit.
 3. Peak: Peak detector.
 4. Filter losses were only considered in the spurious frequency bands and the authorized band was not corrected for High Pass Filter losses.
 5. Proper operation of the transmitter prior to adding the filter to the measurement chain.
 6. Since non-restricted band peak emissions are less than the average limit, they also comply with the -27dBm/MHz (68.2dBuV/m) limit.



HARMONICS AND SPURIOUS EMISSIONS (MID CHANNEL, HORIZONTAL)

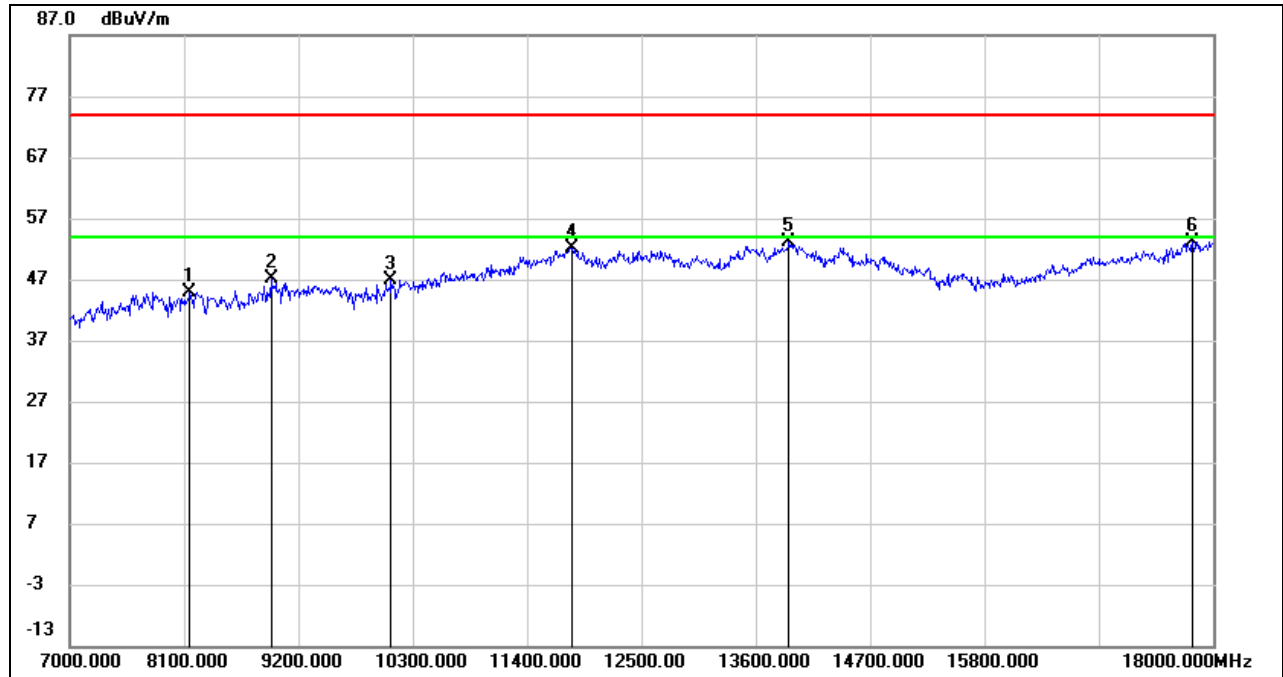

No.	Frequency (MHz)	Reading (dBuV)	Correct (dB/m)	Result (dBuV/m)	Limit (dBuV/m)	Margin (dB)	Remark
1	8160.500	38.11	6.87	44.98	74.00	-29.02	peak
2	8941.500	38.38	8.83	47.21	74.00	-26.79	peak
3	10096.500	36.17	10.76	46.93	74.00	-27.07	peak
4	11829.000	34.90	17.20	52.10	74.00	-21.90	peak
5	13919.000	32.45	20.58	53.03	74.00	-20.97	peak
6	17807.500	29.97	23.20	53.17	74.00	-20.83	peak

Note: 1. Measurement = Reading Level + Correct Factor.
 2. If Peak Result complies with AV limit, AV Result is deemed to comply with AV limit.
 3. Peak: Peak detector.
 4. Filter losses were only considered in the spurious frequency bands and the authorized band was not corrected for High Pass Filter losses.
 5. Proper operation of the transmitter prior to adding the filter to the measurement chain.
 6. Since non-restricted band peak emissions are less than the average limit, they also comply with the -27dBm/MHz (68.2dBuV/m) limit.

HARMONICS AND SPURIOUS EMISSIONS (MID CHANNEL, VERTICAL)

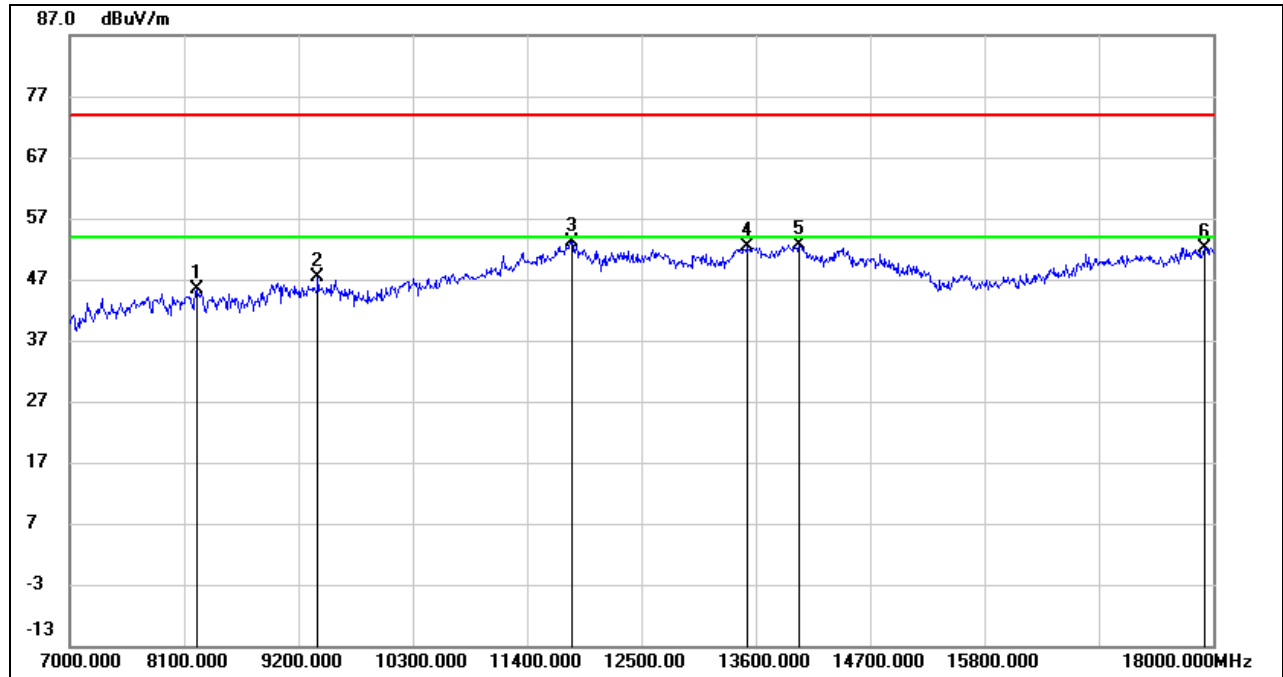

No.	Frequency (MHz)	Reading (dBuV)	Correct (dB/m)	Result (dBuV/m)	Limit (dBuV/m)	Margin (dB)	Remark
1	8221.000	38.10	7.16	45.26	74.00	-28.74	peak
2	9387.000	37.68	9.60	47.28	74.00	-26.72	peak
3	11829.000	36.03	17.20	53.23	74.00	-20.77	peak
4	13517.500	32.76	19.61	52.37	74.00	-21.63	peak
5	14018.000	32.15	20.55	52.70	74.00	-21.30	peak
6	17923.000	28.66	23.50	52.16	74.00	-21.84	peak

Note: 1. Measurement = Reading Level + Correct Factor.
 2. If Peak Result complies with AV limit, AV Result is deemed to comply with AV limit.
 3. Peak: Peak detector.
 4. Filter losses were only considered in the spurious frequency bands and the authorized band was not corrected for High Pass Filter losses.
 5. Proper operation of the transmitter prior to adding the filter to the measurement chain.
 6. Since non-restricted band peak emissions are less than the average limit, they also comply with the -27dBm/MHz (68.2dBuV/m) limit.

HARMONICS AND SPURIOUS EMISSIONS (HIGH CHANNEL, HORIZONTAL)

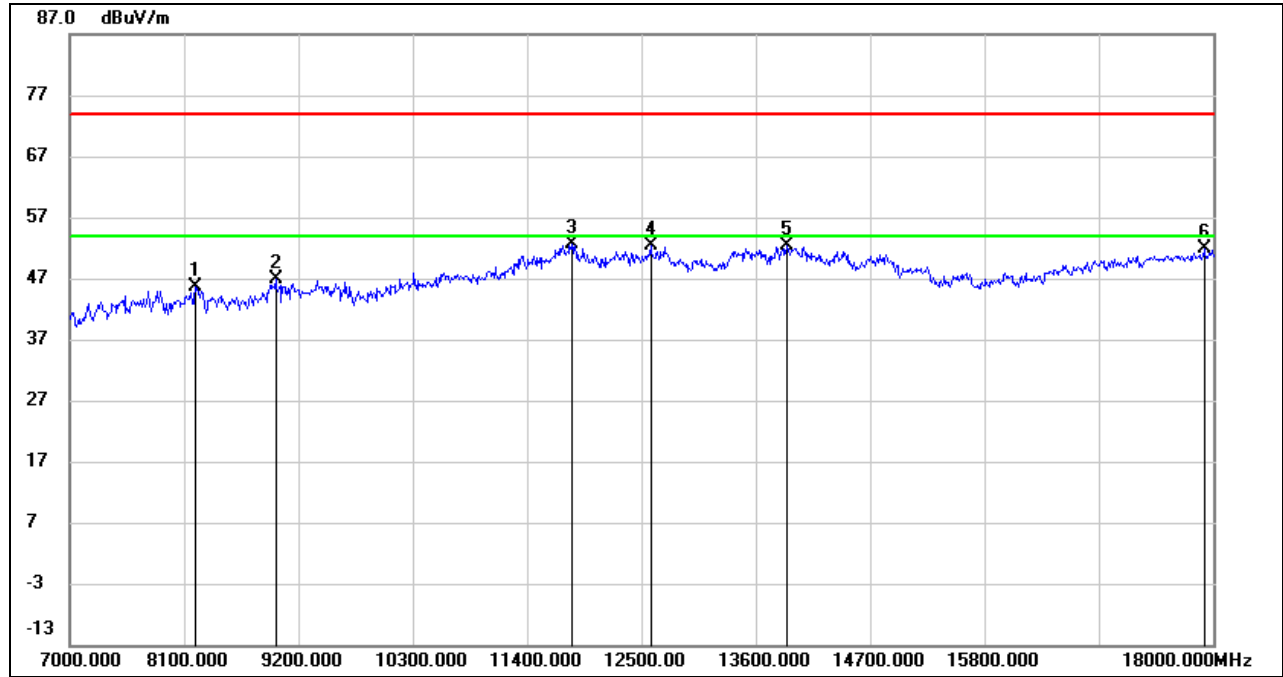

No.	Frequency (MHz)	Reading (dBuV)	Correct (dB/m)	Result (dBuV/m)	Limit (dBuV/m)	Margin (dB)	Remark
1	8210.000	38.32	7.20	45.52	74.00	-28.48	peak
2	8980.000	37.69	9.29	46.98	74.00	-27.02	peak
3	11829.000	35.40	17.20	52.60	74.00	-21.40	peak
4	12593.500	35.66	16.81	52.47	74.00	-21.53	peak
5	13897.000	31.70	20.56	52.26	74.00	-21.74	peak
6	17917.500	28.32	23.48	51.80	74.00	-22.20	peak

- Note: 1. Measurement = Reading Level + Correct Factor.
 2. If Peak Result complies with AV limit, AV Result is deemed to comply with AV limit.
 3. Peak: Peak detector.
 4. Filter losses were only considered in the spurious frequency bands and the authorized band was not corrected for High Pass Filter losses.
 5. Proper operation of the transmitter prior to adding the filter to the measurement chain.
 6. Since non-restricted band peak emissions are less than the average limit, they also comply with the -27dBm/MHz (68.2dBuV/m) limit.

HARMONICS AND SPURIOUS EMISSIONS (HIGH CHANNEL, VERTICAL)

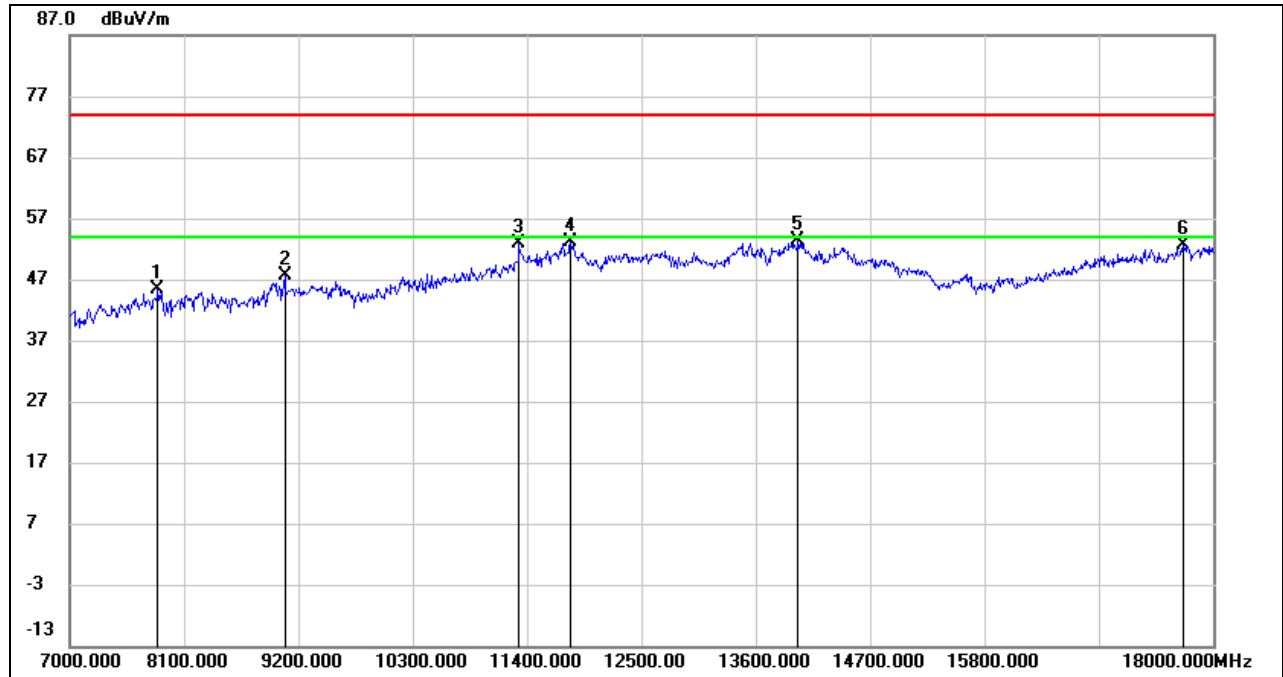

No.	Frequency (MHz)	Reading (dBuV)	Correct (dB/m)	Result (dBuV/m)	Limit (dBuV/m)	Margin (dB)	Remark
1	7852.500	39.59	5.88	45.47	74.00	-28.53	peak
2	9068.000	38.58	9.16	47.74	74.00	-26.26	peak
3	11328.500	38.12	14.87	52.99	74.00	-21.01	peak
4	11823.500	35.91	17.21	53.12	74.00	-20.88	peak
5	14012.500	32.69	20.58	53.27	74.00	-20.73	peak
6	17719.500	30.35	22.36	52.71	74.00	-21.29	peak

- Note: 1. Measurement = Reading Level + Correct Factor.
 2. If Peak Result complies with AV limit, AV Result is deemed to comply with AV limit.
 3. Peak: Peak detector.
 4. Filter losses were only considered in the spurious frequency bands and the authorized band was not corrected for High Pass Filter losses.
 5. Proper operation of the transmitter prior to adding the filter to the measurement chain.
 6. Since non-restricted band peak emissions are less than the average limit, they also comply with the -27dBm/MHz (68.2dBuV/m) limit.

STRADDLE CHANNEL 142

HARMONICS AND SPURIOUS EMISSIONS (HORIZONTAL)

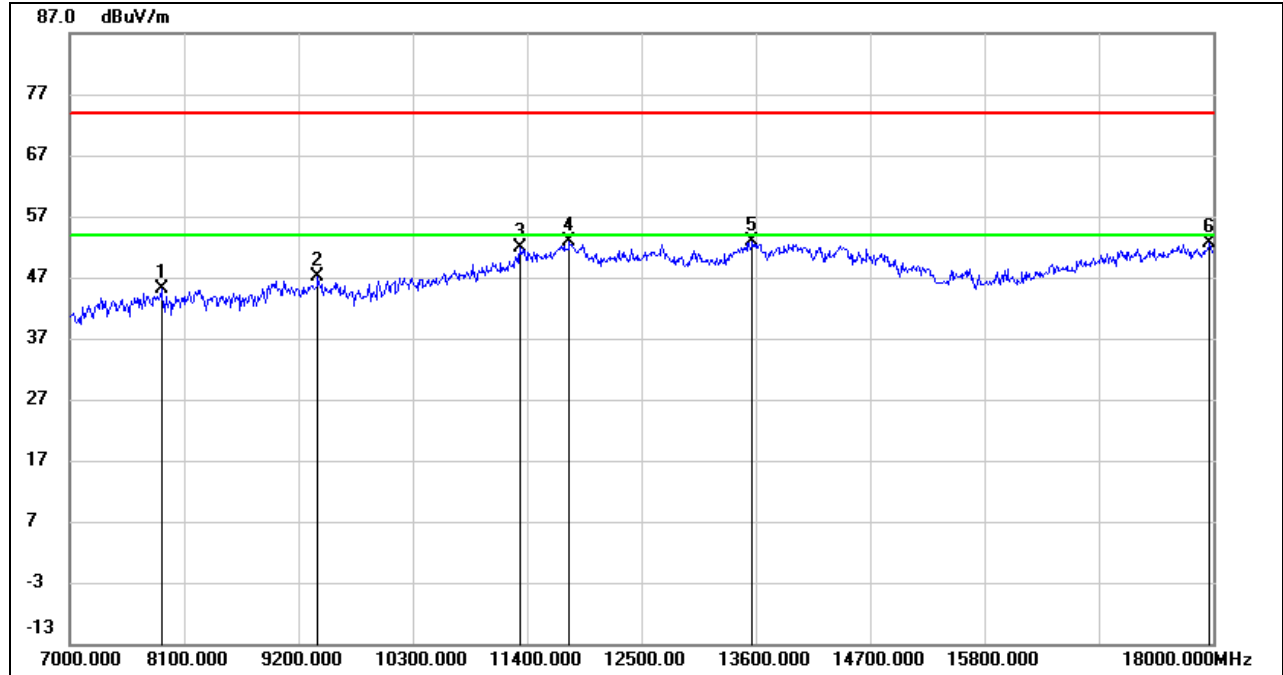

No.	Frequency (MHz)	Reading (dBuV)	Correct (dB/m)	Result (dBuV/m)	Limit (dBuV/m)	Margin (dB)	Remark
1	7885.500	39.35	5.77	45.12	74.00	-28.88	peak
2	9387.000	37.45	9.60	47.05	74.00	-26.95	peak
3	11339.500	36.96	14.93	51.89	74.00	-22.11	peak
4	11812.500	35.62	17.21	52.83	74.00	-21.17	peak
5	13572.500	33.30	19.68	52.98	74.00	-21.02	peak
6	17972.500	29.01	23.61	52.62	74.00	-21.38	peak

- Note: 1. Measurement = Reading Level + Correct Factor.
 2. If Peak Result complies with AV limit, AV Result is deemed to comply with AV limit.
 3. Peak: Peak detector.
 4. Filter losses were only considered in the spurious frequency bands and the authorized band was not corrected for High Pass Filter losses.
 5. Proper operation of the transmitter prior to adding the filter to the measurement chain.
 6. Since non-restricted band peak emissions are less than the average limit, they also comply with the -27dBm/MHz (68.2dBuV/m) limit.

HARMONICS AND SPURIOUS EMISSIONS (VERTICAL)

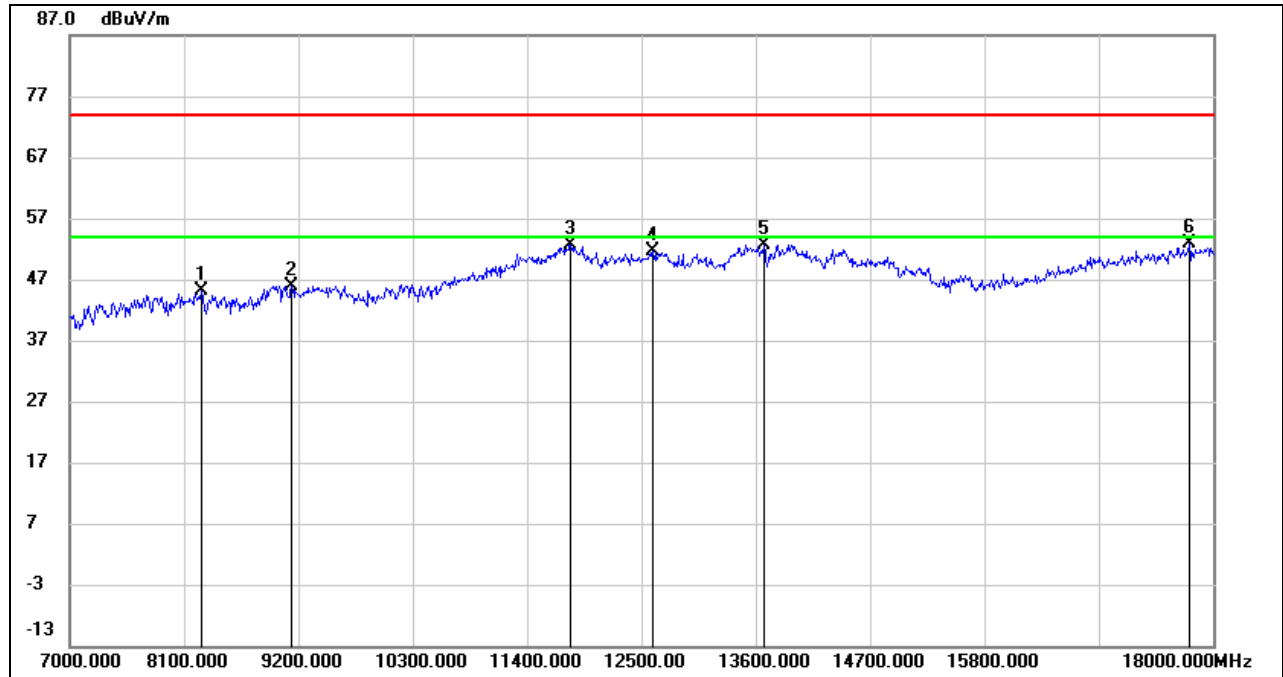

No.	Frequency (MHz)	Reading (dBuV)	Correct (dB/m)	Result (dBuV/m)	Limit (dBuV/m)	Margin (dB)	Remark
1	8265.000	37.99	7.03	45.02	74.00	-28.98	peak
2	9134.000	37.20	8.78	45.98	74.00	-28.02	peak
3	11823.500	35.52	17.21	52.73	74.00	-21.27	peak
4	12615.500	34.83	16.85	51.68	74.00	-22.32	peak
5	13677.000	32.73	20.02	52.75	74.00	-21.25	peak
6	17769.000	30.01	22.86	52.87	74.00	-21.13	peak

Note: 1. Measurement = Reading Level + Correct Factor.
 2. If Peak Result complies with AV limit, AV Result is deemed to comply with AV limit.
 3. Peak: Peak detector.
 4. Filter losses were only considered in the spurious frequency bands and the authorized band was not corrected for High Pass Filter losses.
 5. Proper operation of the transmitter prior to adding the filter to the measurement chain.
 6. Since non-restricted band peak emissions are less than the average limit, they also comply with the -27dBm/MHz (68.2dBuV/m) limit.

UNII-3 BAND

HARMONICS AND SPURIOUS EMISSIONS (LOW CHANNEL, HORIZONTAL)

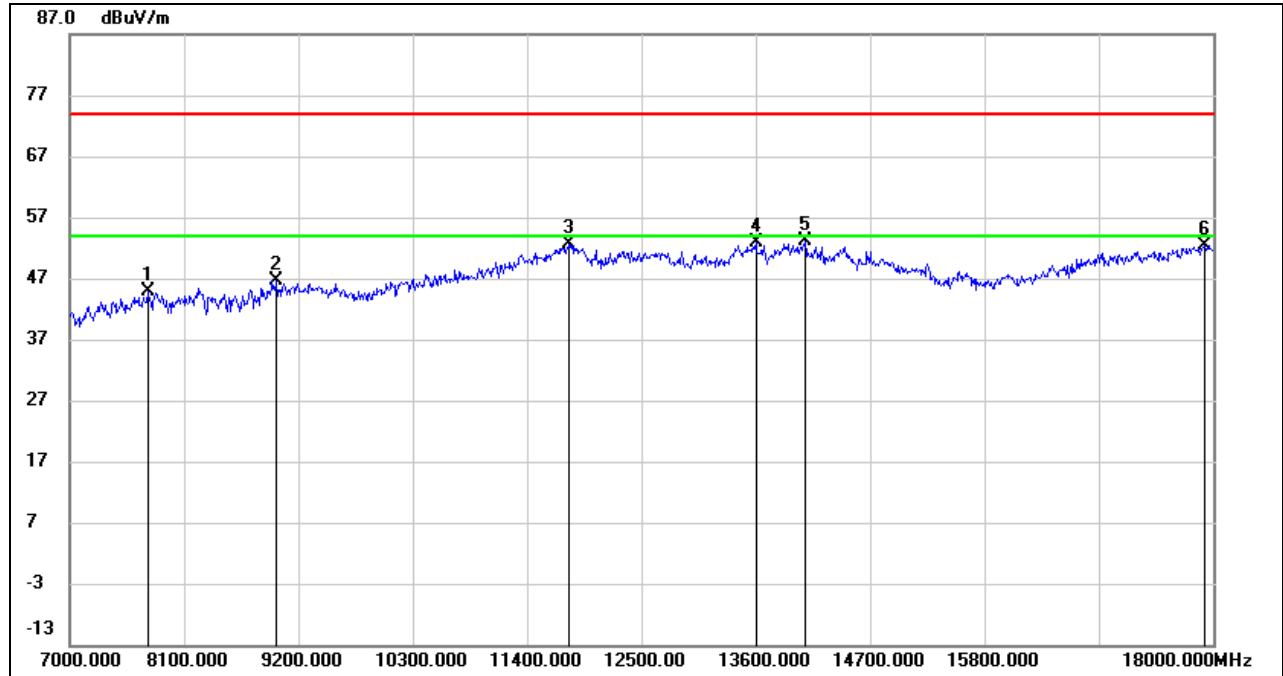

No.	Frequency (MHz)	Reading (dBuV)	Correct (dB/m)	Result (dBuV/m)	Limit (dBuV/m)	Margin (dB)	Remark
1	7753.500	39.07	5.92	44.99	74.00	-29.01	peak
2	8991.000	37.21	9.42	46.63	74.00	-27.37	peak
3	11812.500	35.38	17.21	52.59	74.00	-21.41	peak
4	13600.000	33.16	19.72	52.88	74.00	-21.12	peak
5	14073.000	32.79	20.28	53.07	74.00	-20.93	peak
6	17928.500	28.94	23.51	52.45	74.00	-21.55	peak

Note: 1. Measurement = Reading Level + Correct Factor.
 2. If Peak Result complies with AV limit, AV Result is deemed to comply with AV limit.
 3. Peak: Peak detector.
 4. Filter losses were only considered in the spurious frequency bands and the authorized band was not corrected for High Pass Filter losses.
 5. Proper operation of the transmitter prior to adding the filter to the measurement chain.
 6. Since non-restricted band peak emissions are less than the average limit, they also comply with the -27dBm/MHz (68.2dBuV/m) limit.

HARMONICS AND SPURIOUS EMISSIONS (LOW CHANNEL, VERTICAL)

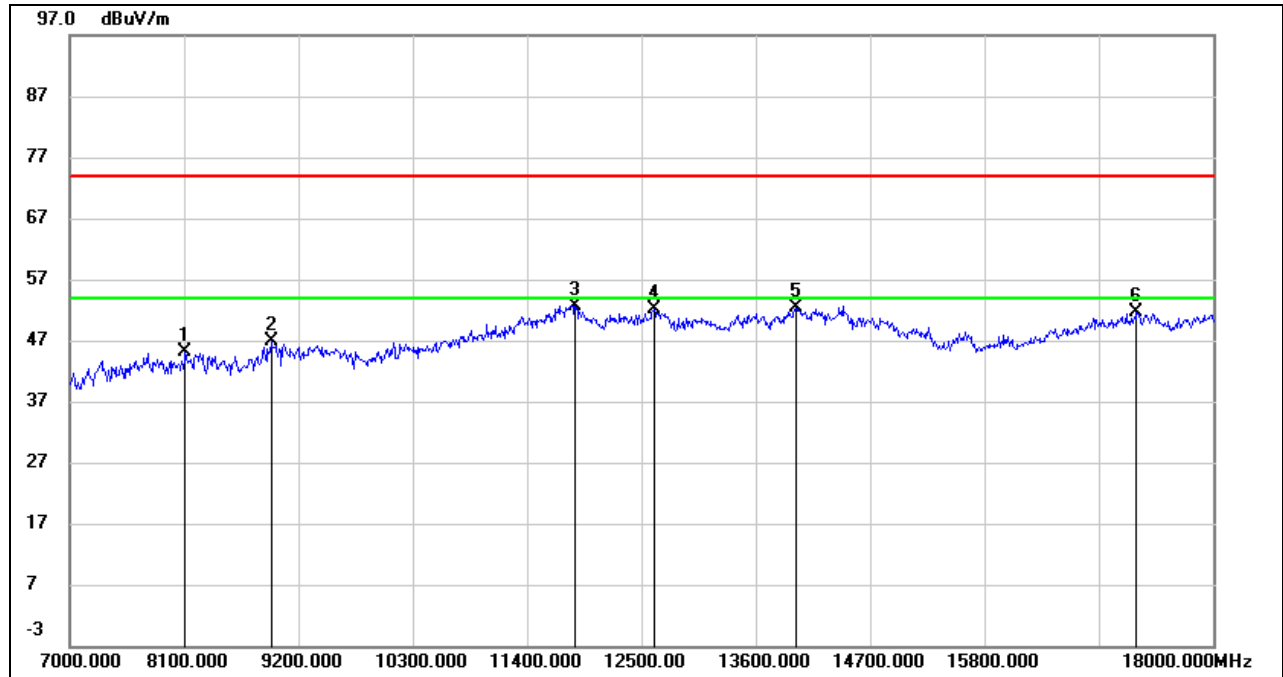

No.	Frequency (MHz)	Reading (dBuV)	Correct (dB/m)	Result (dBuV/m)	Limit (dBuV/m)	Margin (dB)	Remark
1	8116.500	38.67	6.44	45.11	74.00	-28.89	peak
2	8936.000	38.05	8.76	46.81	74.00	-27.19	peak
3	11862.000	35.52	17.19	52.71	74.00	-21.29	peak
4	12621.000	35.24	16.86	52.10	74.00	-21.90	peak
5	13985.000	31.75	20.63	52.38	74.00	-21.62	peak
6	17268.500	31.45	20.17	51.62	74.00	-22.38	peak

- Note: 1. Measurement = Reading Level + Correct Factor.
 2. If Peak Result complies with AV limit, AV Result is deemed to comply with AV limit.
 3. Peak: Peak detector.
 4. Filter losses were only considered in the spurious frequency bands and the authorized band was not corrected for High Pass Filter losses.
 5. Proper operation of the transmitter prior to adding the filter to the measurement chain.
 6. Since non-restricted band peak emissions are less than the average limit, they also comply with the -27dBm/MHz (68.2dBuV/m) limit.

HARMONICS AND SPURIOUS EMISSIONS (HIGH CHANNEL, HORIZONTAL)

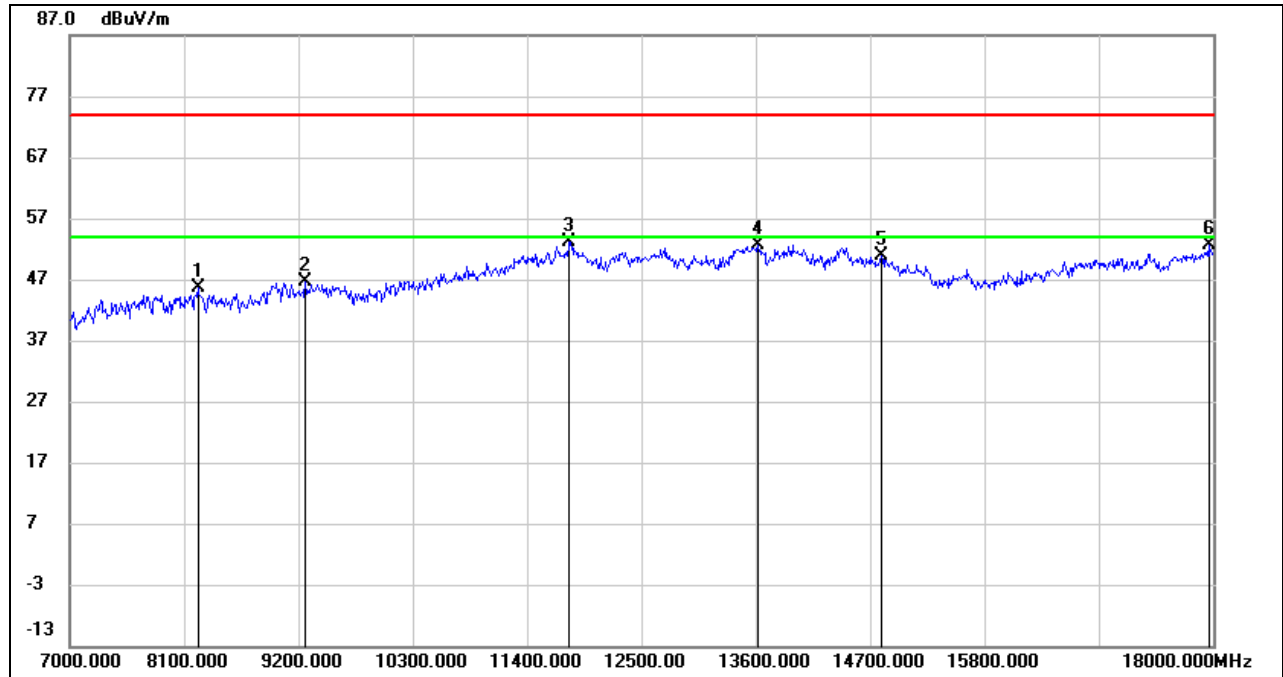

No.	Frequency (MHz)	Reading (dBuV)	Correct (dB/m)	Result (dBuV/m)	Limit (dBuV/m)	Margin (dB)	Remark
1	8237.500	38.40	7.11	45.51	74.00	-28.49	peak
2	9271.500	37.89	8.86	46.75	74.00	-27.25	peak
3	11812.500	36.02	17.21	53.23	74.00	-20.77	peak
4	13622.000	32.73	19.81	52.54	74.00	-21.46	peak
5	14815.500	33.58	17.21	50.79	74.00	-23.21	peak
6	17956.000	29.00	23.57	52.57	74.00	-21.43	peak

- Note: 1. Measurement = Reading Level + Correct Factor.
 2. If Peak Result complies with AV limit, AV Result is deemed to comply with AV limit.
 3. Peak: Peak detector.
 4. Filter losses were only considered in the spurious frequency bands and the authorized band was not corrected for High Pass Filter losses.
 5. Proper operation of the transmitter prior to adding the filter to the measurement chain.
 6. Since non-restricted band peak emissions are less than the average limit, they also comply with the -27dBm/MHz (68.2dBuV/m) limit.

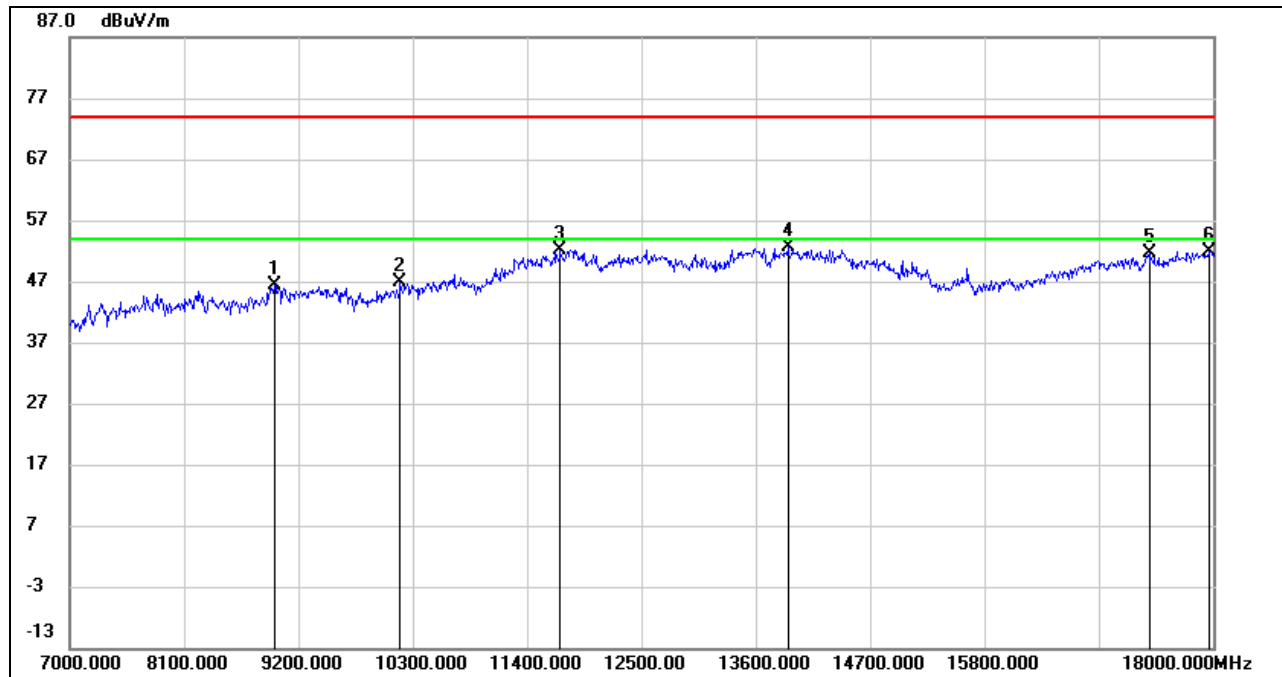
**HARMONICS AND SPURIOUS EMISSIONS (HIGH CHANNEL, VERTICAL)**

No.	Frequency (MHz)	Reading (dBuV)	Correct (dB/m)	Result (dBuV/m)	Limit (dBuV/m)	Margin (dB)	Remark
1	8969.000	37.13	9.16	46.29	74.00	-27.71	peak
2	10184.500	36.05	10.90	46.95	74.00	-27.05	peak
3	11719.000	35.49	16.71	52.20	74.00	-21.80	peak
4	13908.000	31.93	20.58	52.51	74.00	-21.49	peak
5	17389.500	31.41	20.21	51.62	74.00	-22.38	peak
6	17956.000	28.42	23.57	51.99	74.00	-22.01	peak

Note: 1. Measurement = Reading Level + Correct Factor.

2. If Peak Result complies with AV limit, AV Result is deemed to comply with AV limit.

3. Peak: Peak detector.

4. Filter losses were only considered in the spurious frequency bands and the authorized band was not corrected for High Pass Filter losses.

5. Proper operation of the transmitter prior to adding the filter to the measurement chain.

6. Since non-restricted band peak emissions are less than the average limit, they also comply with the -27dBm/MHz (68.2dBuV/m) limit.

8.3.4. 802.11ac VHT80 MODE

UNII-1 BAND

HARMONICS AND SPURIOUS EMISSIONS (LOW CHANNEL, HORIZONTAL)

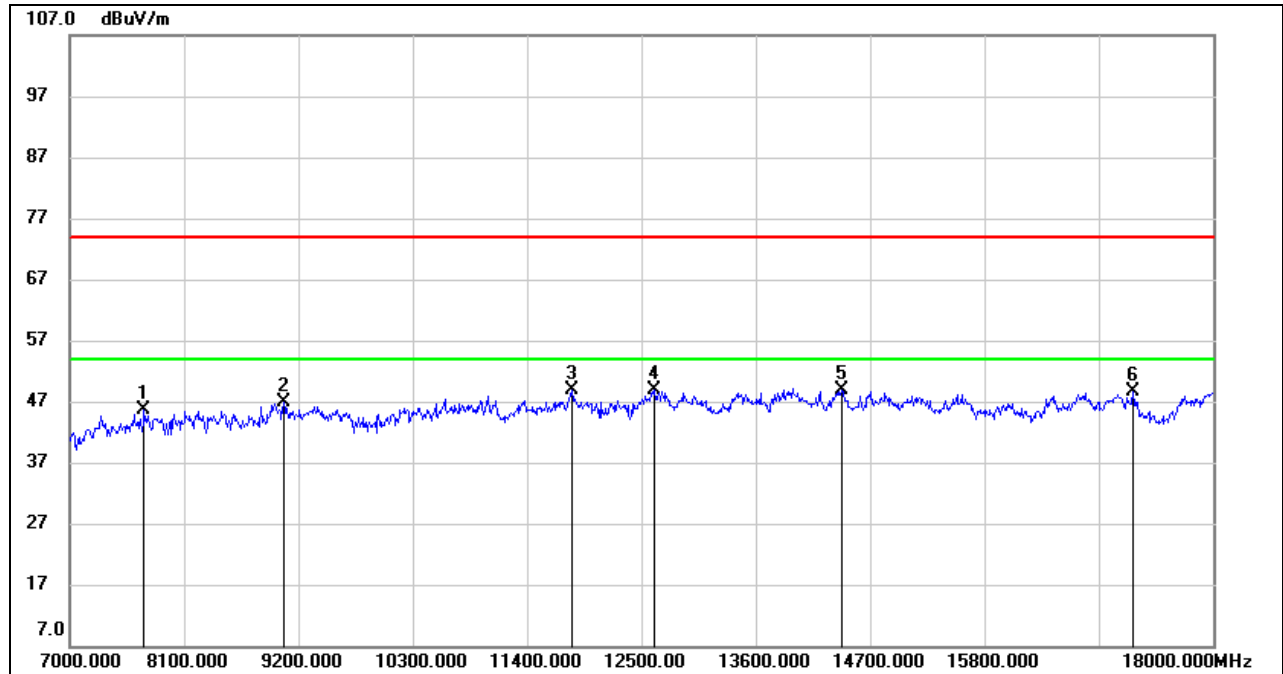

No.	Frequency (MHz)	Reading (dBuV)	Correct (dB/m)	Result (dBuV/m)	Limit (dBuV/m)	Margin (dB)	Remark
1	7715.000	39.13	6.47	45.60	74.00	-28.40	peak
2	9057.000	37.18	9.68	46.86	74.00	-27.14	peak
3	11829.000	33.51	15.47	48.98	74.00	-25.02	peak
4	12621.000	33.31	15.51	48.82	74.00	-25.18	peak
5	14425.000	30.48	18.28	48.76	74.00	-25.24	peak
6	17230.000	27.32	21.40	48.72	74.00	-25.28	peak

- Note: 1. Measurement = Reading Level + Correct Factor.
 2. If Peak Result complies with AV limit, AV Result is deemed to comply with AV limit.
 3. Peak: Peak detector.
 4. Filter losses were only considered in the spurious frequency bands and the authorized band was not corrected for High Pass Filter losses.
 5. Proper operation of the transmitter prior to adding the filter to the measurement chain.
 6. Since non-restricted band peak emissions are less than the average limit, they also comply with the -27dBm/MHz (68.2dBuV/m) limit.

HARMONICS AND SPURIOUS EMISSIONS (LOW CHANNEL, VERTICAL)

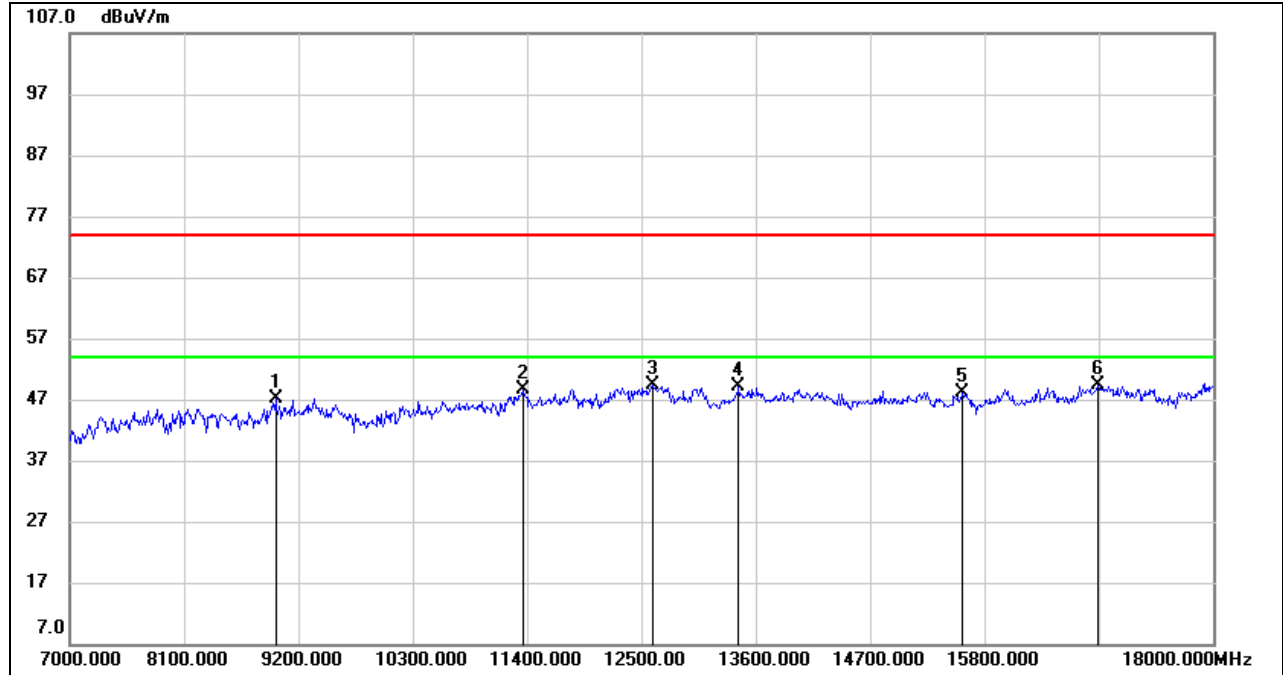

No.	Frequency (MHz)	Reading (dBuV)	Correct (dB/m)	Result (dBuV/m)	Limit (dBuV/m)	Margin (dB)	Remark
1	8980.000	37.42	9.79	47.21	74.00	-26.79	peak
2	11356.000	35.23	13.49	48.72	74.00	-25.28	peak
3	12610.000	33.77	15.49	49.26	74.00	-24.74	peak
4	13435.000	31.72	17.39	49.11	74.00	-24.89	peak
5	15591.000	30.78	17.46	48.24	74.00	-25.76	peak
6	16889.000	28.98	20.42	49.40	74.00	-24.60	peak

- Note: 1. Measurement = Reading Level + Correct Factor.
 2. If Peak Result complies with AV limit, AV Result is deemed to comply with AV limit.
 3. Peak: Peak detector.
 4. Filter losses were only considered in the spurious frequency bands and the authorized band was not corrected for High Pass Filter losses.
 5. Proper operation of the transmitter prior to adding the filter to the measurement chain.
 6. Since non-restricted band peak emissions are less than the average limit, they also comply with the -27dBm/MHz (68.2dBuV/m) limit.

UNII-2A BAND

HARMONICS AND SPURIOUS EMISSIONS (LOW CHANNEL, HORIZONTAL)

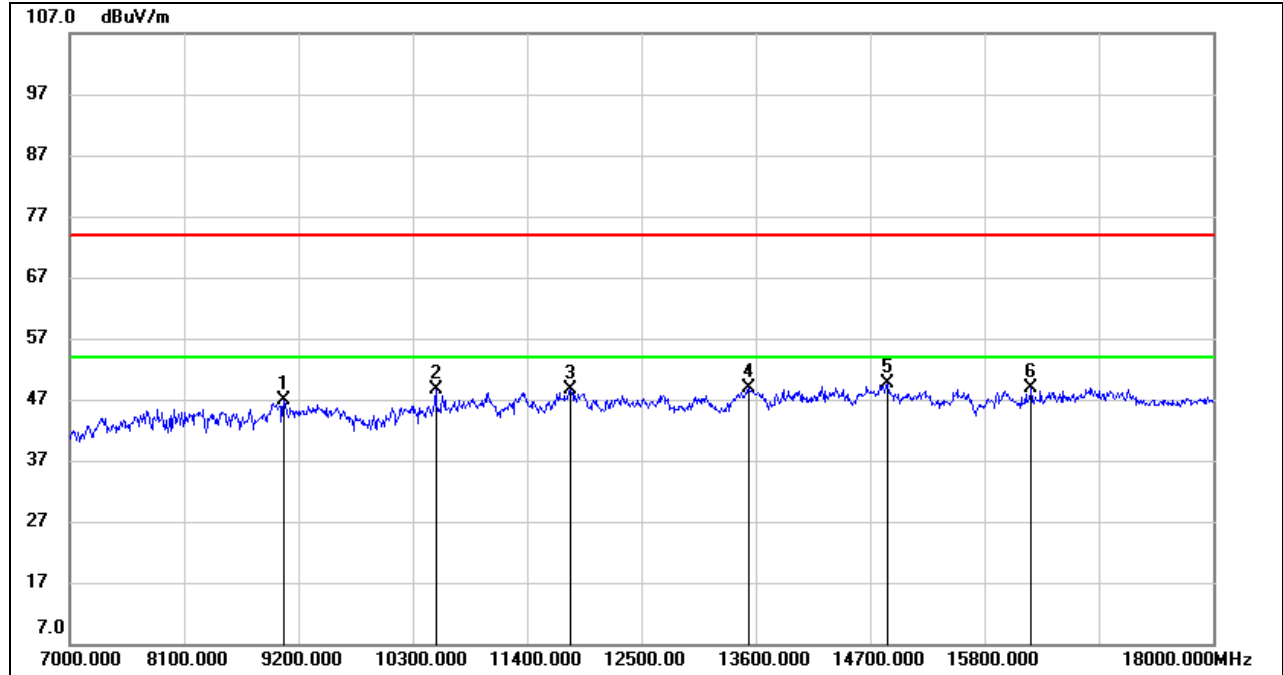

No.	Frequency (MHz)	Reading (dBuV)	Correct (dB/m)	Result (dBuV/m)	Limit (dBuV/m)	Margin (dB)	Remark
1	9057.000	37.15	9.68	46.83	74.00	-27.17	peak
2	10520.000	37.14	11.42	48.56	74.00	-25.44	peak
3	11818.000	33.14	15.47	48.61	74.00	-25.39	peak
4	13534.000	31.23	17.65	48.88	74.00	-25.12	peak
5	14865.000	31.86	17.69	49.55	74.00	-24.45	peak
6	16251.000	30.14	18.82	48.96	74.00	-25.04	peak

Note: 1. Measurement = Reading Level + Correct Factor.
 2. If Peak Result complies with AV limit, AV Result is deemed to comply with AV limit.
 3. Peak: Peak detector.
 4. Filter losses were only considered in the spurious frequency bands and the authorized band was not corrected for High Pass Filter losses.
 5. Proper operation of the transmitter prior to adding the filter to the measurement chain.
 6. Since non-restricted band peak emissions are less than the average limit, they also comply with the -27dBm/MHz (68.2dBuV/m) limit.

HARMONICS AND SPURIOUS EMISSIONS (LOW CHANNEL, VERTICAL)

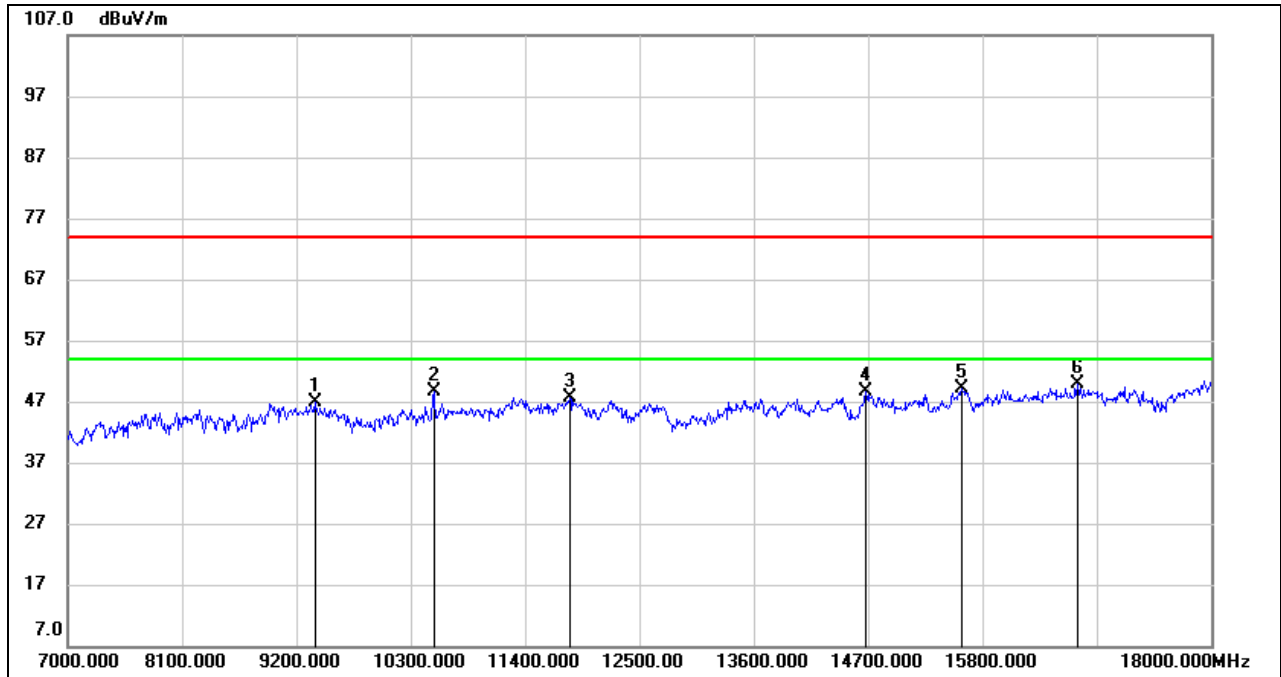

No.	Frequency (MHz)	Reading (dBuV)	Correct (dB/m)	Result (dBuV/m)	Limit (dBuV/m)	Margin (dB)	Remark
1	9376.000	37.20	9.73	46.93	74.00	-27.07	peak
2	10520.000	37.16	11.42	48.58	74.00	-25.42	peak
3	11829.000	32.27	15.47	47.74	74.00	-26.26	peak
4	14678.000	30.90	17.72	48.62	74.00	-25.38	peak
5	15602.000	31.64	17.48	49.12	74.00	-24.88	peak
6	16713.000	29.73	20.19	49.92	74.00	-24.08	peak

Note: 1. Measurement = Reading Level + Correct Factor.
 2. If Peak Result complies with AV limit, AV Result is deemed to comply with AV limit.
 3. Peak: Peak detector.
 4. Filter losses were only considered in the spurious frequency bands and the authorized band was not corrected for High Pass Filter losses.
 5. Proper operation of the transmitter prior to adding the filter to the measurement chain.
 6. Since non-restricted band peak emissions are less than the average limit, they also comply with the -27dBm/MHz (68.2dBuV/m) limit.

UNII-2C BAND

HARMONICS AND SPURIOUS EMISSIONS (LOW CHANNEL, HORIZONTAL)

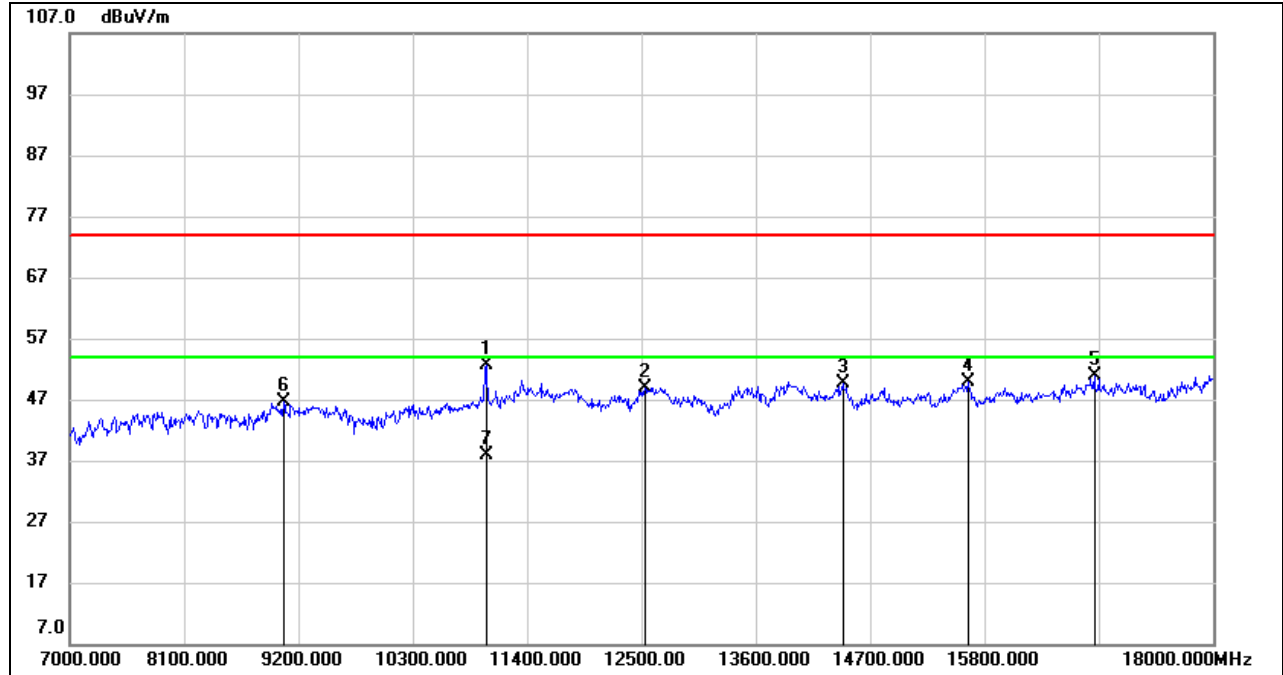

No.	Frequency (MHz)	Reading (dBuV)	Correct (dB/m)	Result (dBuV/m)	Limit (dBuV/m)	Margin (dB)	Remark
1	11004.000	40.29	12.29	52.58	74.00	-21.42	peak
2	12533.000	33.43	15.52	48.95	74.00	-25.05	peak
3	14436.000	31.39	18.26	49.65	74.00	-24.35	peak
4	15646.000	32.38	17.51	49.89	74.00	-24.11	peak
5	16856.000	30.41	20.36	50.77	74.00	-23.23	peak
6	9057.000	37.05	9.68	46.73	74.00	-27.27	peak
7	11004.000	25.61	12.29	37.90	54.00	-16.10	AVG

Note: 1. Measurement = Reading Level + Correct Factor.
 2. If Peak Result complies with AV limit, AV Result is deemed to comply with AV limit.
 3. Peak: Peak detector.
 4. Filter losses were only considered in the spurious frequency bands and the authorized band was not corrected for High Pass Filter losses.
 5. Proper operation of the transmitter prior to adding the filter to the measurement chain.
 6. Since non-restricted band peak emissions are less than the average limit, they also comply with the -27dBm/MHz (68.2dBuV/m) limit.

HARMONICS AND SPURIOUS EMISSIONS (LOW CHANNEL, VERTICAL)

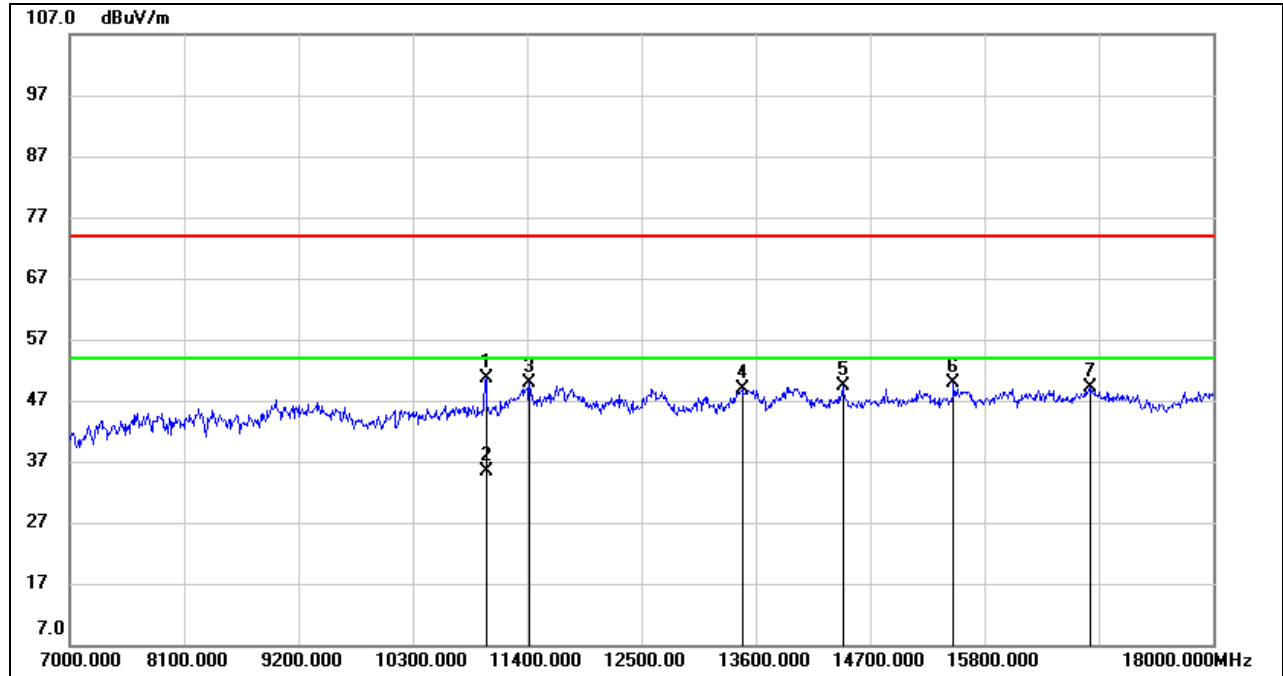

No.	Frequency (MHz)	Reading (dBuV)	Correct (dB/m)	Result (dBuV/m)	Limit (dBuV/m)	Margin (dB)	Remark
1	11004.000	38.37	12.29	50.66	74.00	-23.34	peak
2	11004.000	22.98	12.29	35.27	54.00	-18.73	AVG
3	11422.000	36.05	13.72	49.77	74.00	-24.23	peak
4	13468.000	31.28	17.49	48.77	74.00	-25.23	peak
5	14436.000	31.00	18.26	49.26	74.00	-24.74	peak
6	15503.000	32.57	17.22	49.79	74.00	-24.21	peak
7	16812.000	28.91	20.28	49.19	74.00	-24.81	peak

Note: 1. Measurement = Reading Level + Correct Factor.
 2. If Peak Result complies with AV limit, AV Result is deemed to comply with AV limit.
 3. Peak: Peak detector.
 4. Filter losses were only considered in the spurious frequency bands and the authorized band was not corrected for High Pass Filter losses.
 5. Proper operation of the transmitter prior to adding the filter to the measurement chain.
 6. Since non-restricted band peak emissions are less than the average limit, they also comply with the -27dBm/MHz (68.2dBuV/m) limit.

HARMONICS AND SPURIOUS EMISSIONS (HIGH CHANNEL, HORIZONTAL)

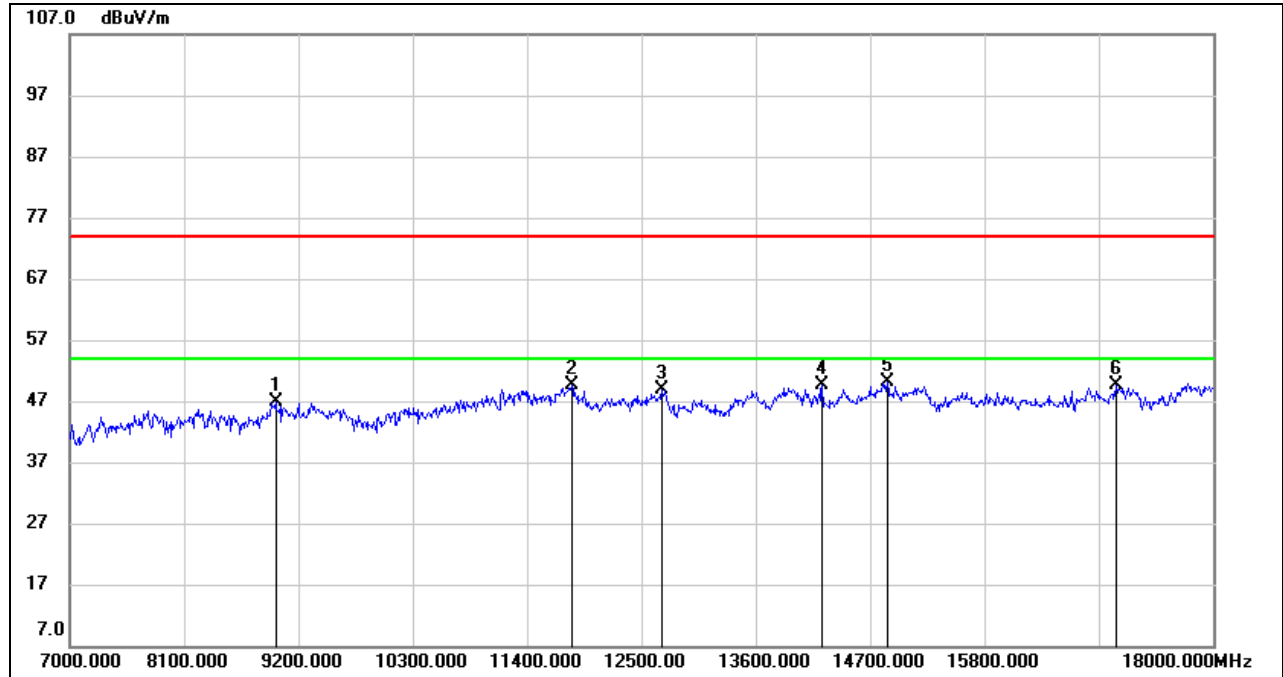

No.	Frequency (MHz)	Reading (dBuV)	Correct (dB/m)	Result (dBuV/m)	Limit (dBuV/m)	Margin (dB)	Remark
1	8980.000	36.97	9.79	46.76	74.00	-27.24	peak
2	11829.000	34.06	15.47	49.53	74.00	-24.47	peak
3	12698.000	33.24	15.67	48.91	74.00	-25.09	peak
4	14238.000	31.03	18.50	49.53	74.00	-24.47	peak
5	14865.000	32.34	17.69	50.03	74.00	-23.97	peak
6	17065.000	28.61	20.91	49.52	74.00	-24.48	peak

- Note: 1. Measurement = Reading Level + Correct Factor.
 2. If Peak Result complies with AV limit, AV Result is deemed to comply with AV limit.
 3. Peak: Peak detector.
 4. Filter losses were only considered in the spurious frequency bands and the authorized band was not corrected for High Pass Filter losses.
 5. Proper operation of the transmitter prior to adding the filter to the measurement chain.
 6. Since non-restricted band peak emissions are less than the average limit, they also comply with the -27dBm/MHz (68.2dBuV/m) limit.



HARMONICS AND SPURIOUS EMISSIONS (HIGH CHANNEL, VERTICAL)

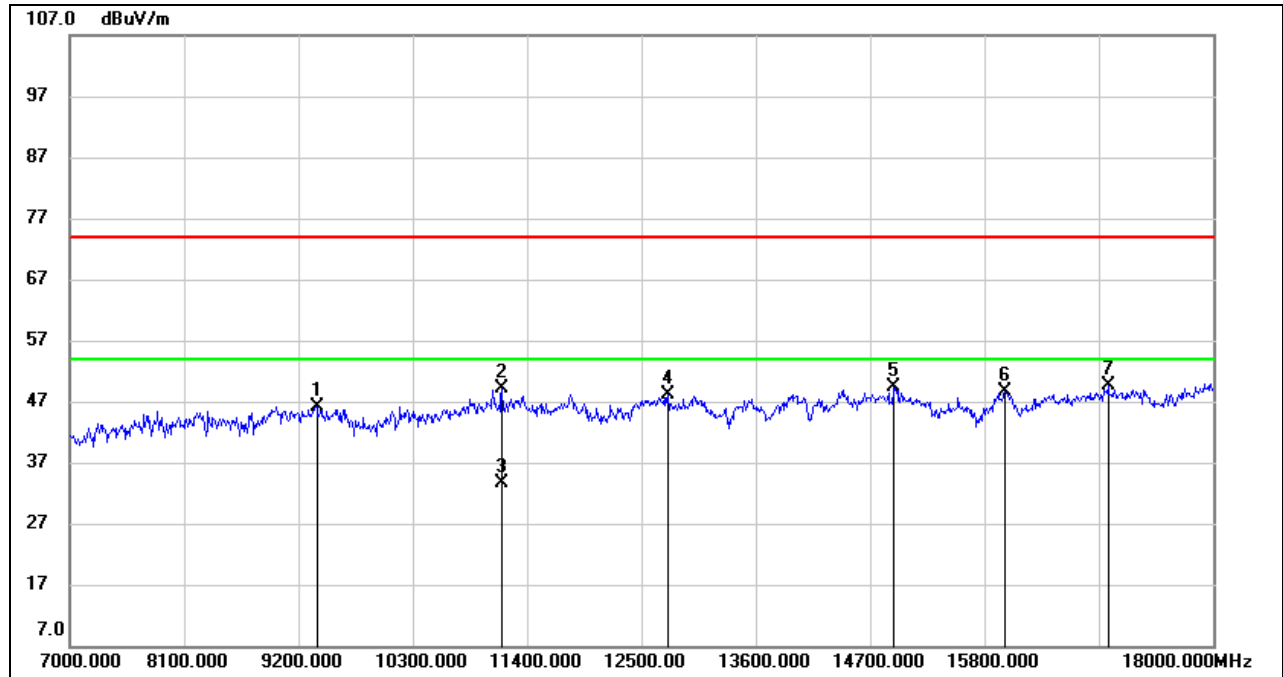

No.	Frequency (MHz)	Reading (dBuV)	Correct (dB/m)	Result (dBuV/m)	Limit (dBuV/m)	Margin (dB)	Remark
1	9376.000	36.51	9.73	46.24	74.00	-27.76	peak
2	11158.000	36.42	12.75	49.17	74.00	-24.83	peak
3	11158.000	20.89	12.75	33.64	54.00	-20.36	AVG
4	12753.000	32.25	15.77	48.02	74.00	-25.98	peak
5	14931.000	31.79	17.64	49.43	74.00	-24.57	peak
6	15998.000	30.50	18.08	48.58	74.00	-25.42	peak
7	16988.000	28.96	20.63	49.59	74.00	-24.41	peak

Note: 1. Measurement = Reading Level + Correct Factor.
 2. If Peak Result complies with AV limit, AV Result is deemed to comply with AV limit.
 3. Peak: Peak detector.
 4. Filter losses were only considered in the spurious frequency bands and the authorized band was not corrected for High Pass Filter losses.
 5. Proper operation of the transmitter prior to adding the filter to the measurement chain.
 6. Since non-restricted band peak emissions are less than the average limit, they also comply with the -27dBm/MHz (68.2dBuV/m) limit.

STRADDLE CHANNEL 138

HARMONICS AND SPURIOUS EMISSIONS (HORIZONTAL)

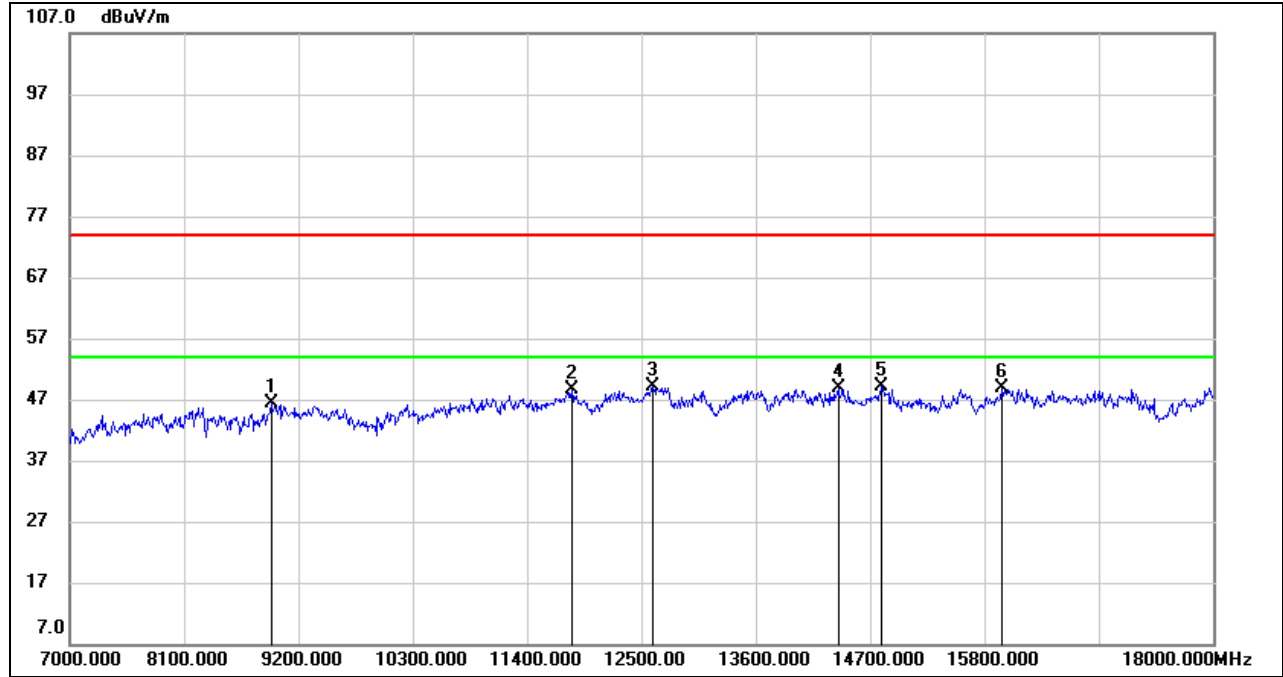

No.	Frequency (MHz)	Reading (dBuV)	Correct (dB/m)	Result (dBuV/m)	Limit (dBuV/m)	Margin (dB)	Remark
1	8936.000	37.02	9.29	46.31	74.00	-27.69	peak
2	11829.000	33.14	15.47	48.61	74.00	-25.39	peak
3	12610.000	33.59	15.49	49.08	74.00	-24.92	peak
4	14392.000	30.40	18.37	48.77	74.00	-25.23	peak
5	14810.000	31.29	17.74	49.03	74.00	-24.97	peak
6	15965.000	30.79	18.00	48.79	74.00	-25.21	peak

Note: 1. Measurement = Reading Level + Correct Factor.
 2. If Peak Result complies with AV limit, AV Result is deemed to comply with AV limit.
 3. Peak: Peak detector.
 4. Filter losses were only considered in the spurious frequency bands and the authorized band was not corrected for High Pass Filter losses.
 5. Proper operation of the transmitter prior to adding the filter to the measurement chain.
 6. Since non-restricted band peak emissions are less than the average limit, they also comply with the -27dBm/MHz (68.2dBuV/m) limit.

HARMONICS AND SPURIOUS EMISSIONS (VERTICAL)

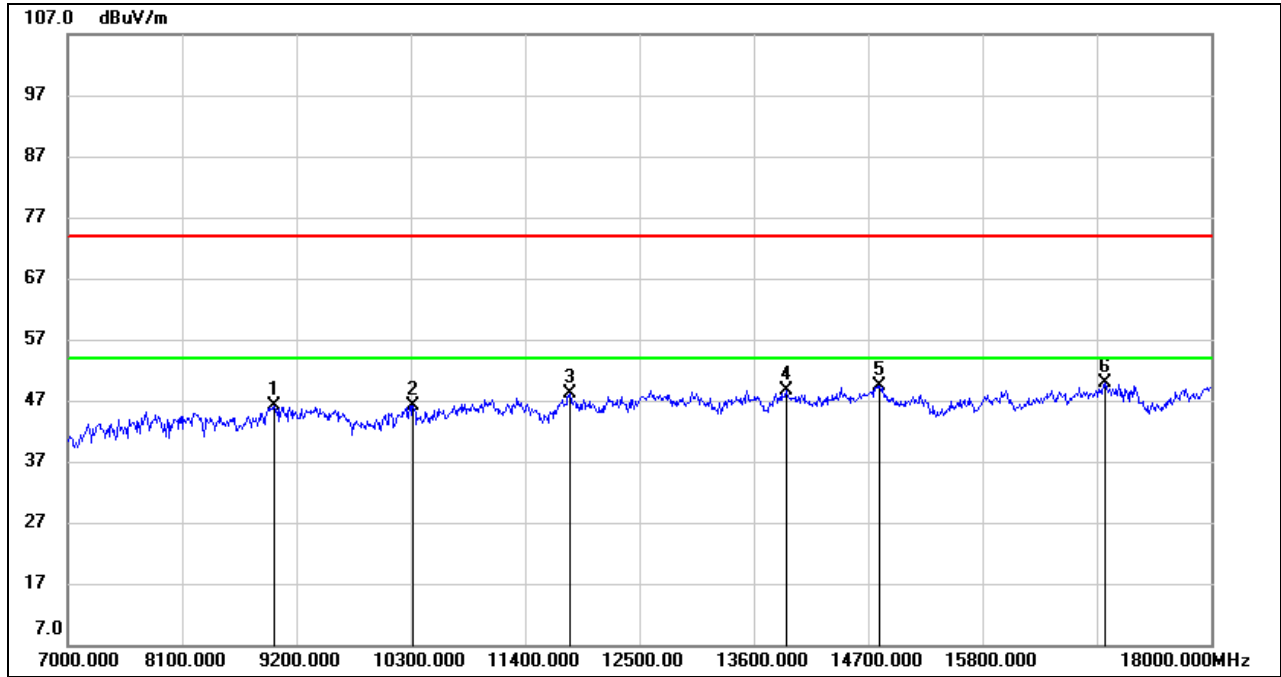

No.	Frequency (MHz)	Reading (dBuV)	Correct (dB/m)	Result (dBuV/m)	Limit (dBuV/m)	Margin (dB)	Remark
1	8991.000	36.28	9.92	46.20	74.00	-27.80	peak
2	10322.000	35.50	10.71	46.21	74.00	-27.79	peak
3	11829.000	32.70	15.47	48.17	74.00	-25.83	peak
4	13908.000	29.92	18.82	48.74	74.00	-25.26	peak
5	14810.000	31.76	17.74	49.50	74.00	-24.50	peak
6	16977.000	29.22	20.61	49.83	74.00	-24.17	peak

Note: 1. Measurement = Reading Level + Correct Factor.
 2. If Peak Result complies with AV limit, AV Result is deemed to comply with AV limit.
 3. Peak: Peak detector.
 4. Filter losses were only considered in the spurious frequency bands and the authorized band was not corrected for High Pass Filter losses.
 5. Proper operation of the transmitter prior to adding the filter to the measurement chain.
 6. Since non-restricted band peak emissions are less than the average limit, they also comply with the -27dBm/MHz (68.2dBuV/m) limit.

UNII-3 BAND

HARMONICS AND SPURIOUS EMISSIONS (LOW CHANNEL, HORIZONTAL)

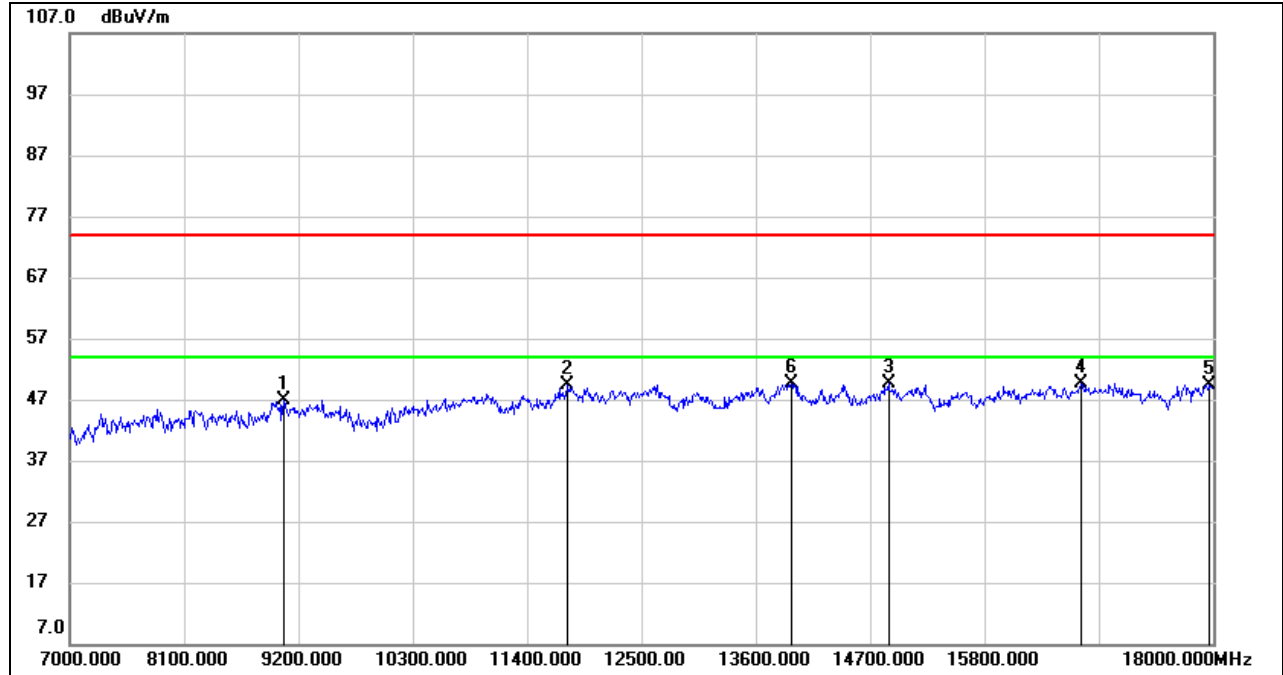

No.	Frequency (MHz)	Reading (dBuV)	Correct (dB/m)	Result (dBuV/m)	Limit (dBuV/m)	Margin (dB)	Remark
1	9057.000	37.08	9.68	46.76	74.00	-27.24	peak
2	11785.000	33.91	15.37	49.28	74.00	-24.72	peak
3	14876.000	32.00	17.67	49.67	74.00	-24.33	peak
4	16735.000	29.53	20.21	49.74	74.00	-24.26	peak
5	17956.000	26.35	22.99	49.34	74.00	-24.66	peak
6	13941.000	30.65	18.87	49.52	74.00	-24.48	peak

Note: 1. Measurement = Reading Level + Correct Factor.
 2. If Peak Result complies with AV limit, AV Result is deemed to comply with AV limit.
 3. Peak: Peak detector.
 4. Filter losses were only considered in the spurious frequency bands and the authorized band was not corrected for High Pass Filter losses.
 5. Proper operation of the transmitter prior to adding the filter to the measurement chain.
 6. Since non-restricted band peak emissions are less than the average limit, they also comply with the -27dBm/MHz (68.2dBuV/m) limit.



HARMONICS AND SPURIOUS EMISSIONS (LOW CHANNEL, VERTICAL)

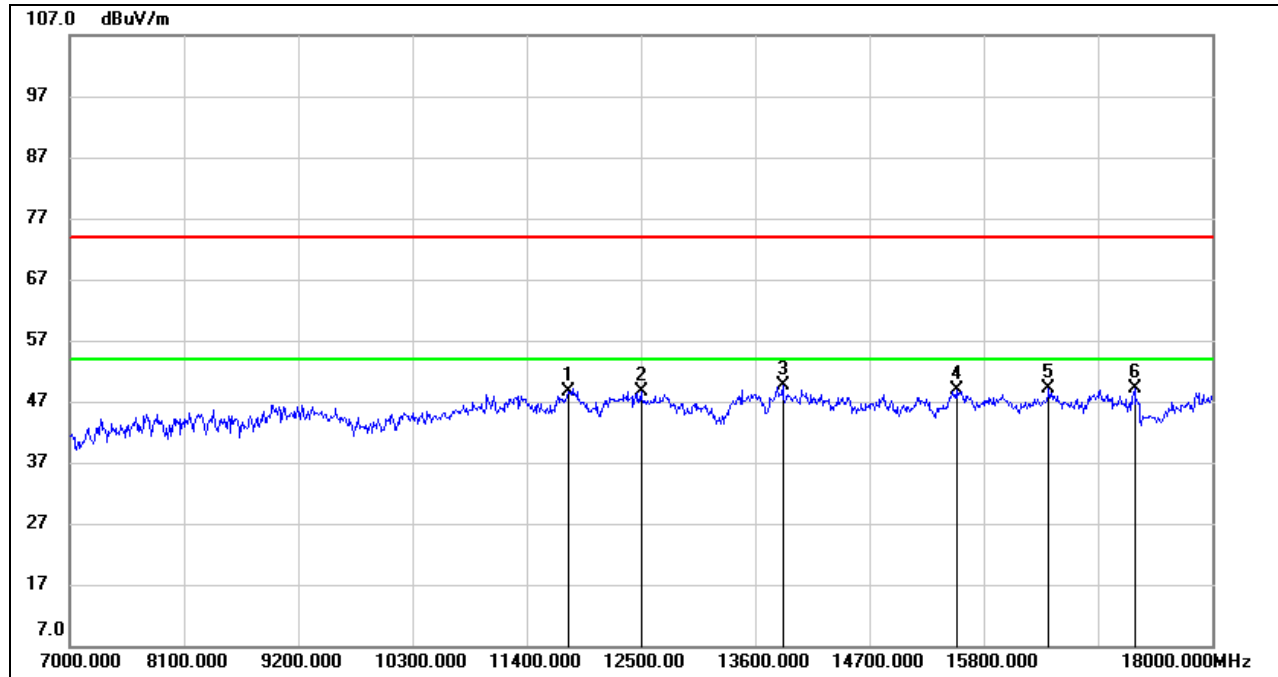

No.	Frequency (MHz)	Reading (dBuV)	Correct (dB/m)	Result (dBuV/m)	Limit (dBuV/m)	Margin (dB)	Remark
1	11807.000	33.14	15.48	48.62	74.00	-25.38	peak
2	12500.000	33.17	15.53	48.70	74.00	-25.30	peak
3	13864.000	30.82	18.76	49.58	74.00	-24.42	peak
4	15536.000	31.46	17.32	48.78	74.00	-25.22	peak
5	16427.000	29.58	19.48	49.06	74.00	-24.94	peak
6	17252.000	27.73	21.36	49.09	74.00	-24.91	peak

Note: 1. Measurement = Reading Level + Correct Factor.
 2. If Peak Result complies with AV limit, AV Result is deemed to comply with AV limit.
 3. Peak: Peak detector.
 4. Filter losses were only considered in the spurious frequency bands and the authorized band was not corrected for High Pass Filter losses.
 5. Proper operation of the transmitter prior to adding the filter to the measurement chain.
 6. Since non-restricted band peak emissions are less than the average limit, they also comply with the -27dBm/MHz (68.2dBuV/m) limit.

8.4. SPURIOUS EMISSIONS (18 GHz ~ 26 GHz)

8.4.1. 802.11 a MODE

SPURIOUS EMISSIONS (UNII-3 BAND MID CHANNEL, HORIZONTAL, WORST-CASE CONFIGURATION)

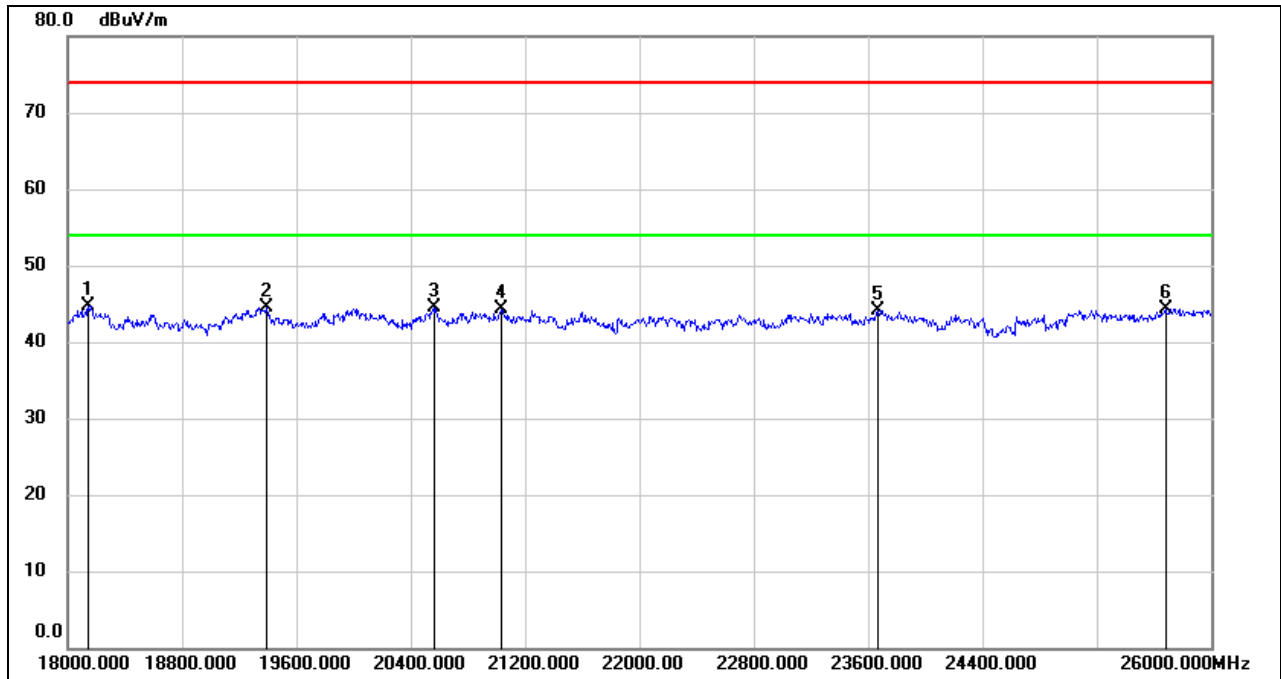

No.	Frequency (MHz)	Reading (dBuV)	Correct (dB/m)	Result (dBuV/m)	Limit (dBuV/m)	Margin (dB)	Remark
1	18144.000	50.27	-5.48	44.79	74.00	-29.21	peak
2	19392.000	50.12	-5.57	44.55	74.00	-29.45	peak
3	20560.000	49.73	-5.30	44.43	74.00	-29.57	peak
4	21032.000	49.15	-4.87	44.28	74.00	-29.72	peak
5	23664.000	47.32	-3.18	44.14	74.00	-29.86	peak
6	25680.000	45.21	-0.93	44.28	74.00	-29.72	peak

- Note: 1. Measurement = Reading Level + Correct Factor.
 2. If Peak Result complies with AV limit, AV Result is deemed to comply with AV limit.
 3. Peak: Peak detector.

SPURIOUS EMISSIONS (UNII-3 BAND MID CHANNEL, VERTICAL, WORST-CASE CONFIGURATION)

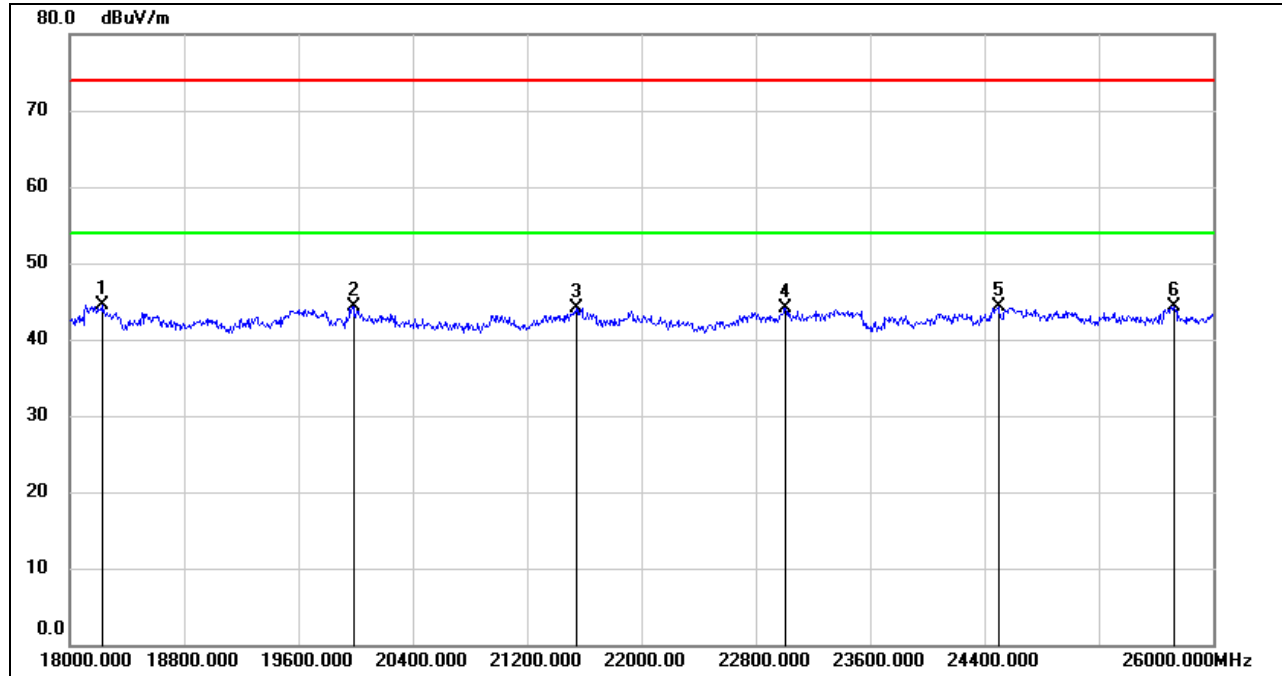

No.	Frequency (MHz)	Reading (dBuV)	Correct (dB/m)	Result (dBuV/m)	Limit (dBuV/m)	Margin (dB)	Remark
1	18224.000	50.08	-5.53	44.55	74.00	-29.45	peak
2	19984.000	49.71	-5.44	44.27	74.00	-29.73	peak
3	21544.000	48.76	-4.63	44.13	74.00	-29.87	peak
4	23008.000	47.60	-3.44	44.16	74.00	-29.84	peak
5	24496.000	46.64	-2.32	44.32	74.00	-29.68	peak
6	25728.000	45.11	-0.72	44.39	74.00	-29.61	peak

- Note: 1. Measurement = Reading Level + Correct Factor.
 2. If Peak Result complies with AV limit, AV Result is deemed to comply with AV limit.
 3. Peak: Peak detector.

Note: All the modes and channels had been tested, but only the worst data was recorded in the report.



8.5. SPURIOUS EMISSIONS (26 GHz ~ 40 GHz)

8.5.1. 802.11 a MODE

SPURIOUS EMISSIONS (UNII-3 BAND MID CHANNEL, HORIZONTAL, WORST-CASE CONFIGURATION)

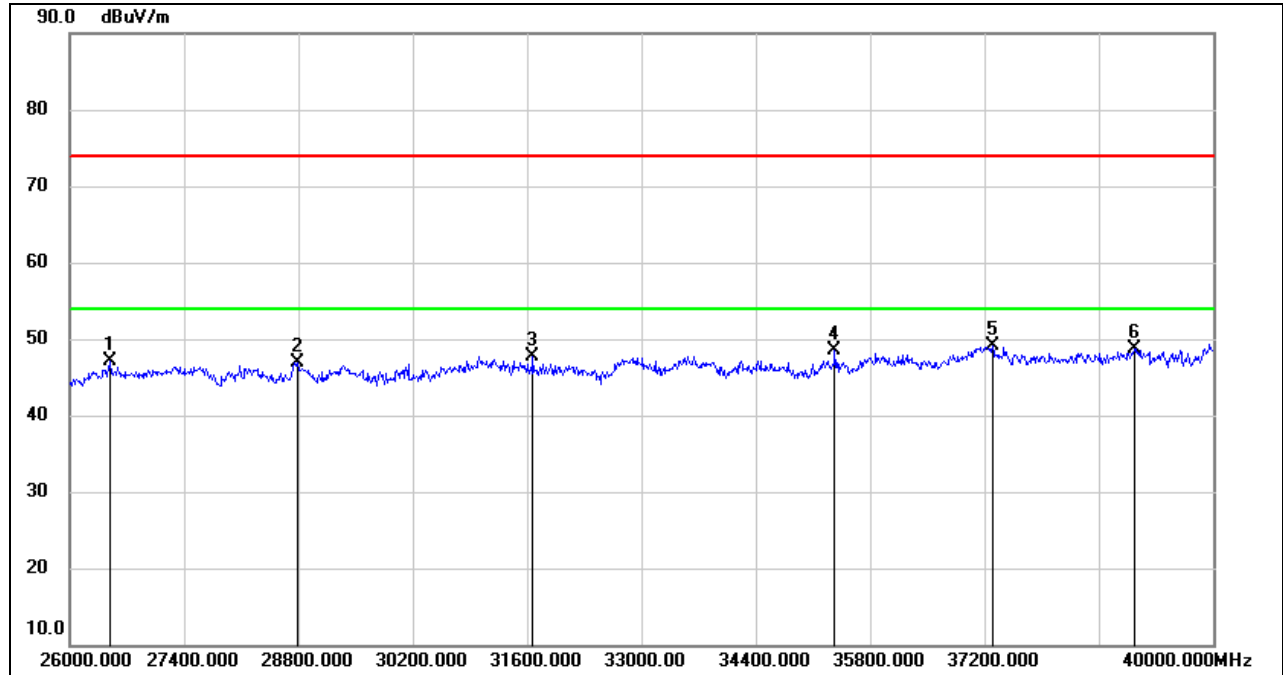

No.	Frequency (MHz)	Reading (dBuV)	Correct (dB/m)	Result (dBuV/m)	Limit (dBuV/m)	Margin (dB)	Remark
1	26490.000	51.79	-4.74	47.05	74.00	-26.95	peak
2	28786.000	47.49	-0.64	46.85	74.00	-27.15	peak
3	31670.000	48.86	-1.21	47.65	74.00	-26.35	peak
4	35366.000	45.90	2.59	48.49	74.00	-25.51	peak
5	37298.000	45.92	3.15	49.07	74.00	-24.93	peak
6	39034.000	44.31	4.33	48.64	74.00	-25.36	peak

Note: 1. Measurement = Reading Level + Correct Factor.
 2. If Peak Result complies with AV limit, AV Result is deemed to comply with AV limit.
 3. Peak: Peak detector.



SPURIOUS EMISSIONS (UNII-3 BAND MID CHANNEL, VERTICAL, WORST-CASE CONFIGURATION)

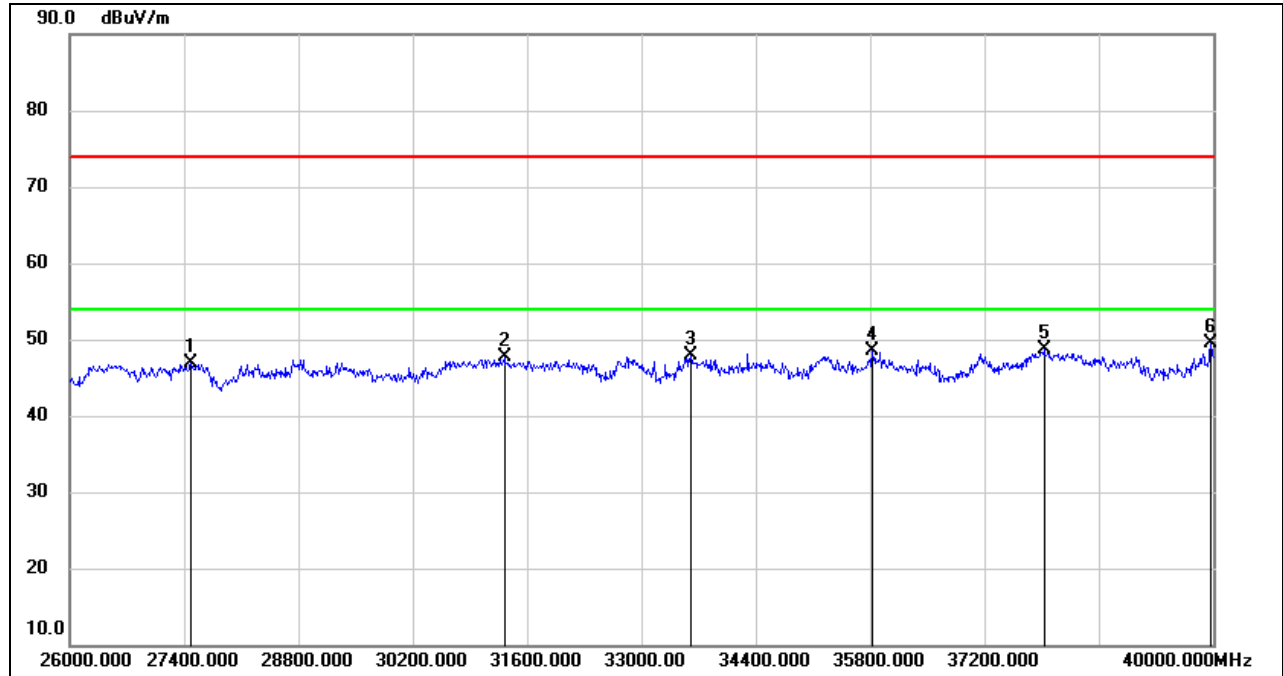

No.	Frequency (MHz)	Reading (dBuV)	Correct (dB/m)	Result (dBuV/m)	Limit (dBuV/m)	Margin (dB)	Remark
1	27484.000	50.33	-3.47	46.86	74.00	-27.14	peak
2	31320.000	48.61	-0.93	47.68	74.00	-26.32	peak
3	33602.000	47.51	0.46	47.97	74.00	-26.03	peak
4	35828.000	44.75	3.67	48.42	74.00	-25.58	peak
5	37928.000	45.26	3.38	48.64	74.00	-25.36	peak
6	39972.000	44.45	5.13	49.58	74.00	-24.42	peak

Note: 1. Measurement = Reading Level + Correct Factor.
2. If Peak Result complies with AV limit, AV Result is deemed to comply with AV limit.
3. Peak: Peak detector.

Note: All the modes and channels had been tested, but only the worst data was recorded in the report.

8.6. SPURIOUS EMISSIONS (30 MHz ~ 1 GHz)

8.6.1. 802.11 a MODE

SPURIOUS EMISSIONS (UNII-3 BAND MID CHANNEL, HORIZONTAL, WORST-CASE CONFIGURATION)

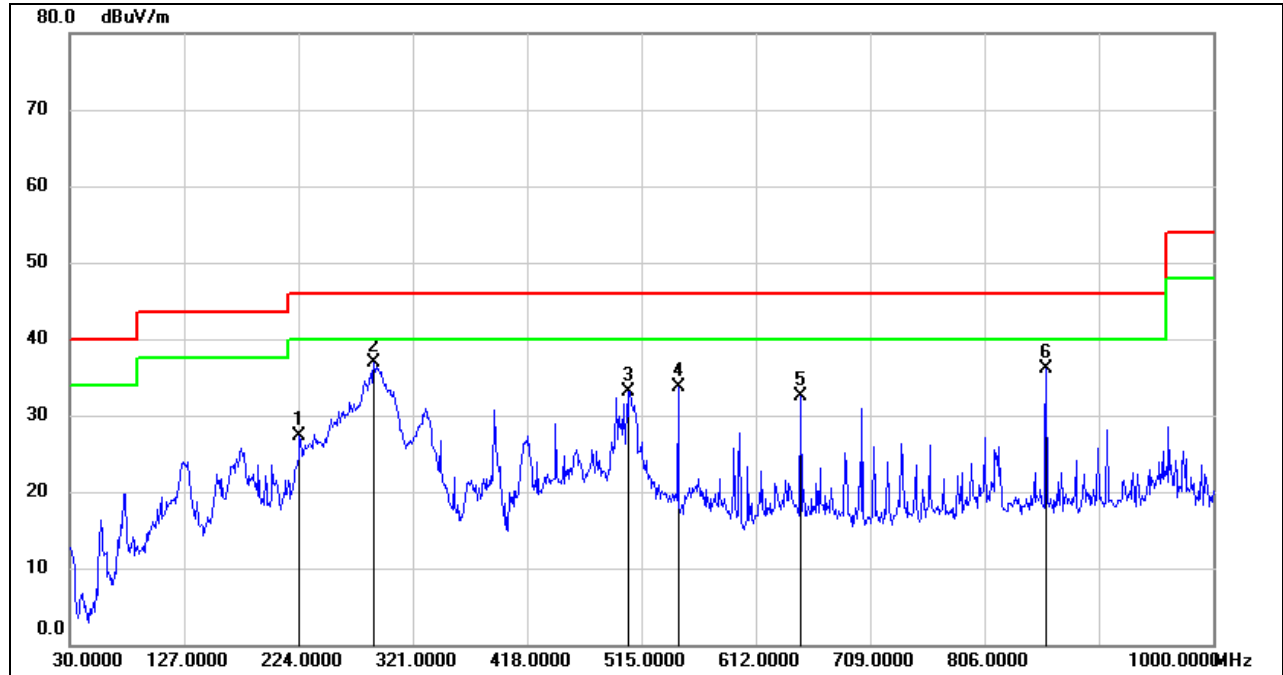

No.	Frequency (MHz)	Reading (dBuV)	Correct (dB/m)	Result (dBuV/m)	Limit (dBuV/m)	Margin (dB)	Remark
1	224.9700	45.65	-18.42	27.23	46.00	-18.77	QP
2	288.0200	52.94	-16.06	36.88	46.00	-9.12	QP
3	504.3300	44.50	-11.37	33.13	46.00	-12.87	QP
4	546.0400	44.11	-10.49	33.62	46.00	-12.38	QP
5	649.8300	41.49	-9.06	32.43	46.00	-13.57	QP
6	858.3800	42.19	-6.05	36.14	46.00	-9.86	QP

- Note: 1. Result Level = Read Level + Correct Factor.
 2. If Peak Result complies with QP limit, QP Result is deemed to comply with QP limit.
 3. Test setup: RBW: 120 kHz, VBW: 300 kHz, Sweep time: auto.

SPURIOUS EMISSIONS (UNII-3 BAND MID CHANNEL, VERTICAL, WORST-CASE CONFIGURATION)

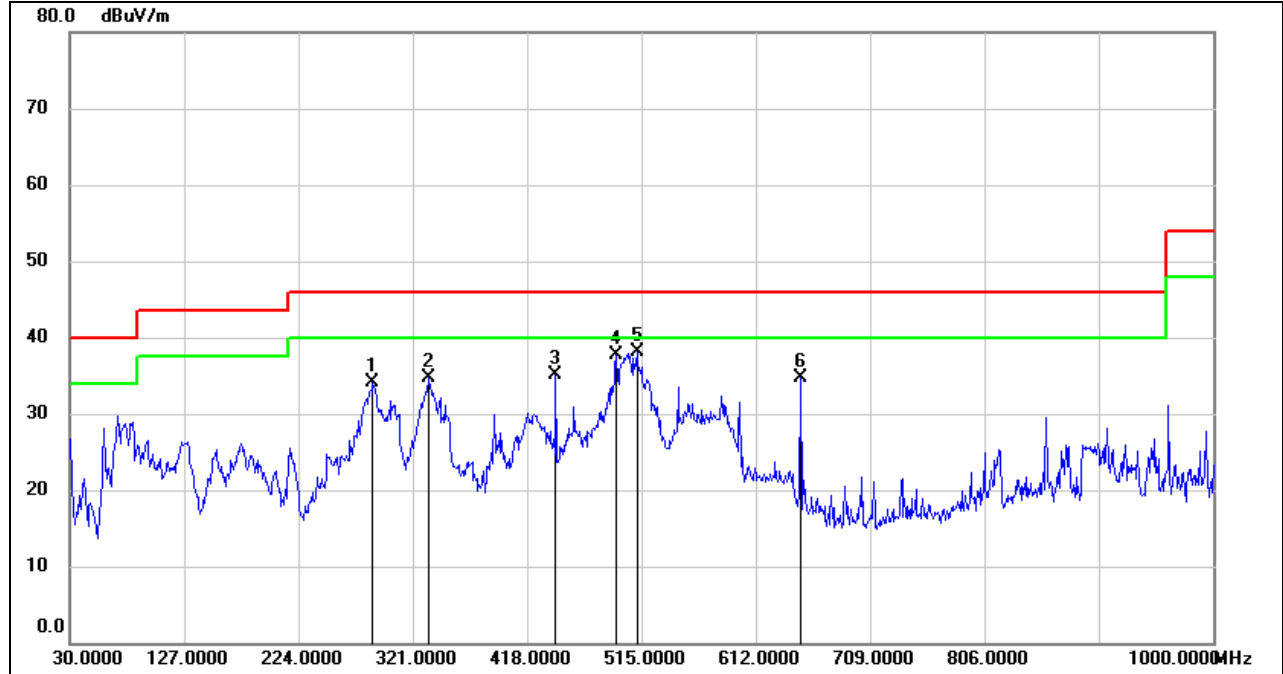

No.	Frequency (MHz)	Reading (dBuV)	Correct (dB/m)	Result (dBuV/m)	Limit (dBuV/m)	Margin (dB)	Remark
1	287.0500	50.17	-16.14	34.03	46.00	-11.97	QP
2	334.5799	49.19	-14.57	34.62	46.00	-11.38	QP
3	442.2500	47.62	-12.55	35.07	46.00	-10.93	QP
4	493.6600	49.37	-11.61	37.76	46.00	-8.24	QP
5	511.1200	49.31	-11.22	38.09	46.00	-7.91	QP
6	649.8300	43.75	-9.06	34.69	46.00	-11.31	QP

- Note: 1. Result Level = Read Level + Correct Factor.
 2. If Peak Result complies with QP limit, QP Result is deemed to comply with QP limit.
 3. Test setup: RBW: 120 kHz, VBW: 300 kHz, Sweep time: auto

Note: All the modes and channels had been tested, but only the worst data was recorded in the report.

8.7. SPURIOUS EMISSIONS BELOW 30 MHz

8.7.1. 802.11 a MODE

SPURIOUS EMISSIONS (UNII-3 BAND MID CHANNEL, LOOP ANTENNA FACE ON TO THE EUT, WORST-CASE CONFIGURATION)

9 kHz~ 150 kHz

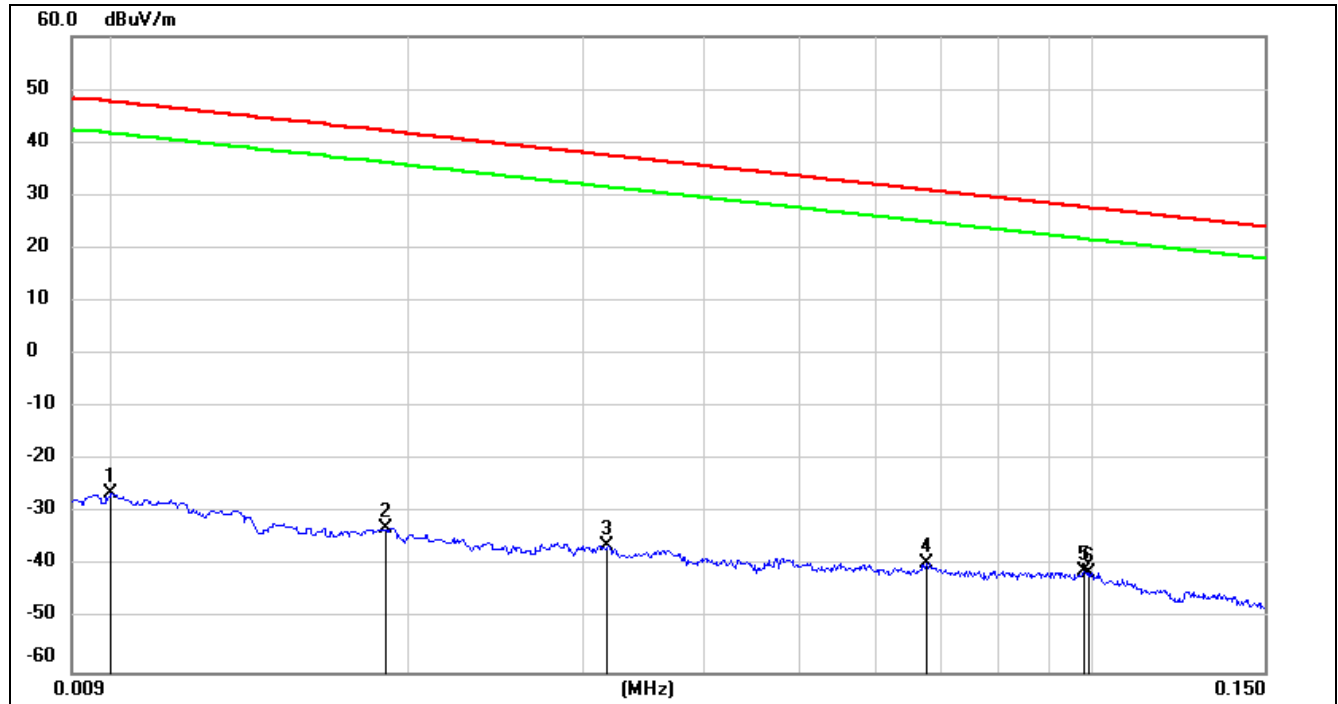

No.	Frequency (MHz)	Reading (dBuV)	Correct (dB/m)	FCC Result (dBuV/m)	FCC Limit (dBuV/m)	ISED Result (dBuA/m)	ISED Limit (dBuA/m)	Margin (dB)	Remark
1	0.0100	75.22	-101.40	-26.18	47.6	-77.68	-3.90	-73.78	peak
2	0.0189	68.49	-101.35	-32.86	42.07	-84.36	-9.43	-74.93	peak
3	0.0318	65.34	-101.40	-36.06	37.55	-87.56	-13.95	-73.61	peak
4	0.0675	62.14	-101.56	-39.42	31.02	-90.92	-20.48	-70.44	peak
5	0.0981	60.77	-101.78	-41.01	27.77	-92.51	-23.73	-68.78	peak
6	0.0994	60.70	-101.80	-41.1	27.65	-92.60	-23.85	-68.75	peak

Note: 1. Measurement = Reading Level + Correct Factor (dBuA/m= dBuV/m- 20Log10[120π] = dBuV/m- 51.5).

2. If Peak Result complies with AV and QP limit, AV and QP Result are deemed to comply with AV limit.

3. All 3 polarizations (Horizontal, Face-on and Face-off) of the loop antenna had been tested, but only the worst data recorded in the report.

150 kHz ~ 490 kHz

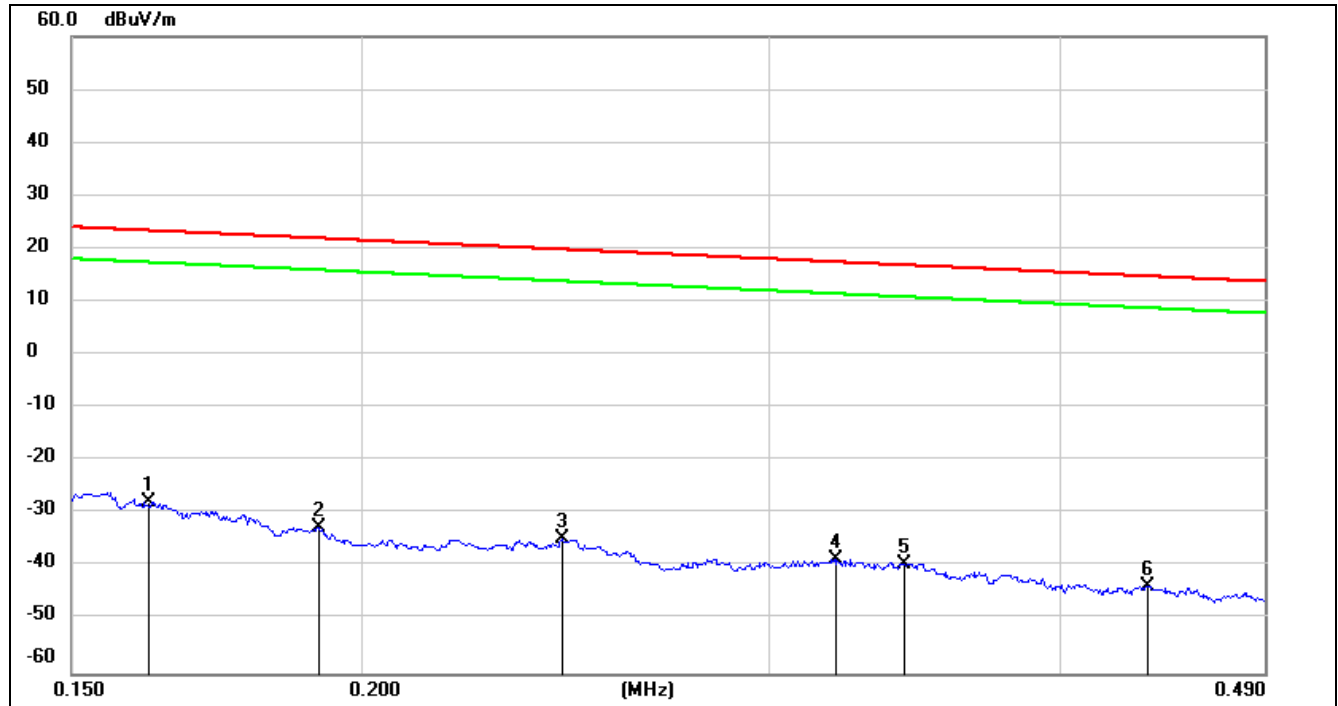

No.	Frequency (MHz)	Reading (dBuV)	Correct (dB/m)	FCC Result (dBuV/m)	FCC Limit (dBuV/m)	ISED Result (dBuA/m)	ISED Limit (dBuA/m)	Margin (dB)	Remark
1	0.1621	73.92	-101.65	-27.73	23.41	-79.23	-28.09	-51.14	peak
2	0.1917	69.04	-101.70	-32.66	21.95	-84.16	-29.55	-54.61	peak
3	0.2442	67.03	-101.79	-34.76	19.85	-86.26	-31.65	-54.61	peak
4	0.3204	63.47	-101.88	-38.41	17.49	-89.91	-34.01	-55.90	peak
5	0.3427	62.58	-101.90	-39.32	16.9	-90.82	-34.60	-56.22	peak
6	0.4364	58.36	-101.99	-43.63	14.8	-95.13	-36.70	-58.43	peak

Note: 1. Measurement = Reading Level + Correct Factor (dBuA/m= dBuV/m- 20Log10[120π] = dBuV/m- 51.5).

2. If Peak Result complies with AV and QP limit, AV and QP Result are deemed to comply with AV limit.

3. All 3 polarizations (Horizontal, Face-on and Face-off) of the loop antenna had been tested, but only the worst data recorded in the report.

490 kHz ~ 30 MHz

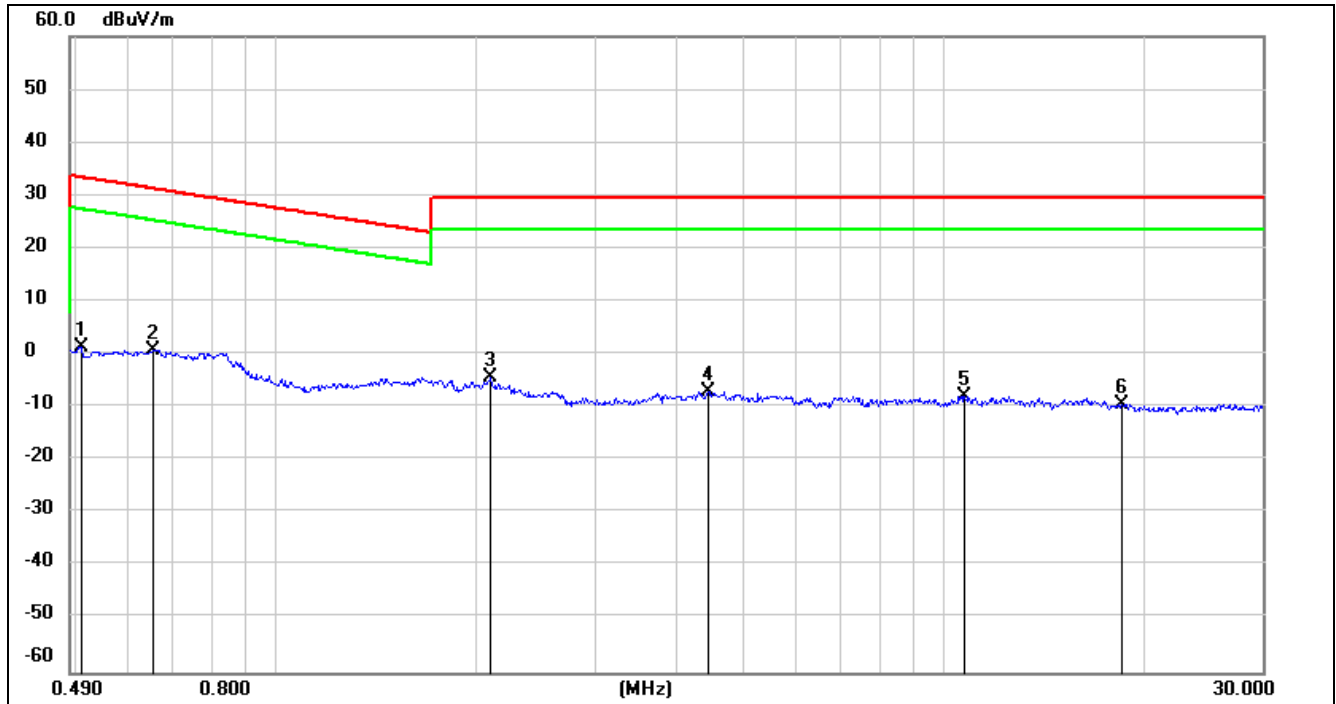

No.	Frequency (MHz)	Reading (dBuV)	Correct (dB/m)	FCC Result (dBuV/m)	FCC Limit (dBuV/m)	ISED Result (dBuA/m)	ISED Limit (dBuA/m)	Margin (dB)	Remark
1	0.5106	63.30	-62.07	1.23	33.44	-50.27	-18.06	-32.21	peak
2	0.6532	62.98	-62.10	0.88	31.3	-50.62	-20.20	-30.42	peak
3	2.0939	57.39	-61.79	-4.4	29.54	-55.90	-21.96	-33.94	peak
4	4.4443	54.29	-61.40	-7.11	29.54	-58.61	-21.96	-36.65	peak
5	10.7299	52.98	-60.83	-7.85	29.54	-59.35	-21.96	-37.39	peak
6	18.4908	51.56	-60.89	-9.33	29.54	-60.83	-21.96	-38.87	peak

Note: 1. Measurement = Reading Level + Correct Factor (dBuA/m= dBuV/m- 20Log10[120π] = dBuV/m- 51.5).

2. If Peak Result complies with AV and QP limit, AV and QP Result are deemed to comply with AV limit.

3. All 3 polarizations (Horizontal, Face-on and Face-off) of the loop antenna had been tested, but only the worst data recorded in the report.

Note: All the modes and channels had been tested, but only the worst data was recorded in the report.

9. AC POWER LINE CONDUCTED EMISSIONS

LIMITS

Please refer to CFR 47 FCC §15.207 (a) and ISED RSS-Gen Clause 8.8

FREQUENCY (MHz)	Quasi-peak	Average
0.15 -0.5	66 - 56 *	56 - 46 *
0.50 -5.0	56.00	46.00
5.0 -30.0	60.00	50.00

TEST SETUP AND PROCEDURE

Refer to ANSI C63.10-2013 clause 6.2.

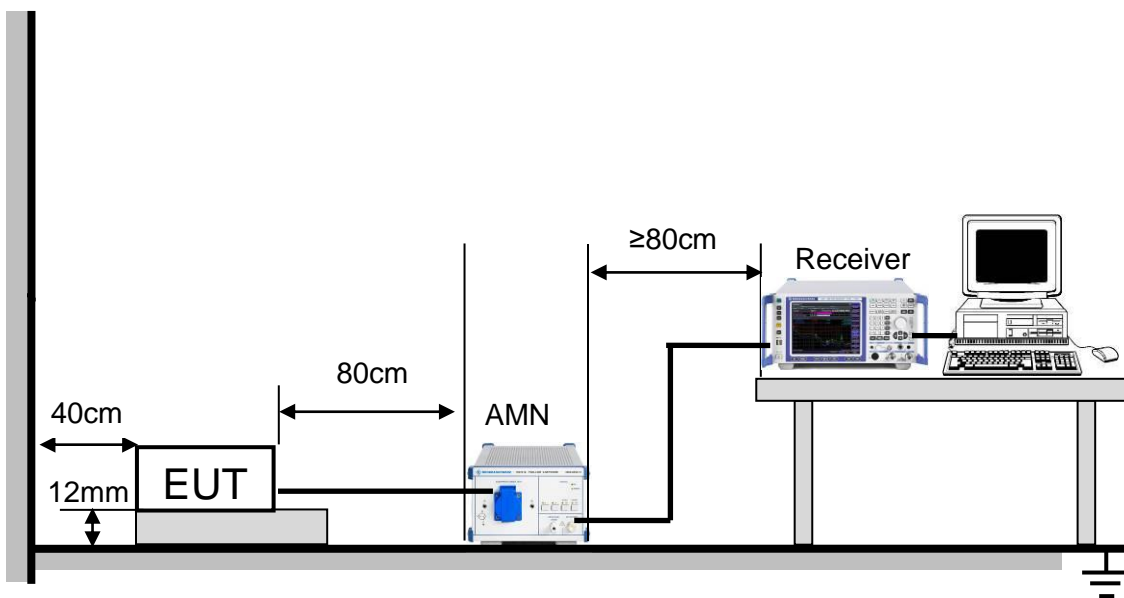

The EUT is put on a table of non-conducting material that is 12 mm high. The VERTICAL conducting wall of shielding is located 40 cm to the rear of the EUT. The power line of the EUT is connected to the AC mains through a Artificial Mains Network (A.M.N.). A EMI Measurement Receiver (R&S Test Receiver ESR3) is used to test the emissions from both sides of AC line. According to the requirements in Section 6.2 of ANSI C63.10-2013. Conducted emissions from the EUT measured in the frequency range between 0.15 MHz and 30 MHz using CISPR Quasi-Peak and average detector mode. The bandwidth of EMI test receiver is set at 9 kHz.

The arrangement of the equipment is installed to meet the standards and operating in a manner, which tends to maximize its emission characteristics in a normal application.



TEST ENVIRONMENT

Temperature	23.8 °C	Relative Humidity	68.5 %
Atmosphere Pressure	101 kPa	Test Voltage	AC 120V,60HZ

RESULTS

9.1. 802.11 a MODE

LINE L RESULTS (UNII-3 BAND MID CHANNEL, WORST-CASE CONFIGURATION)

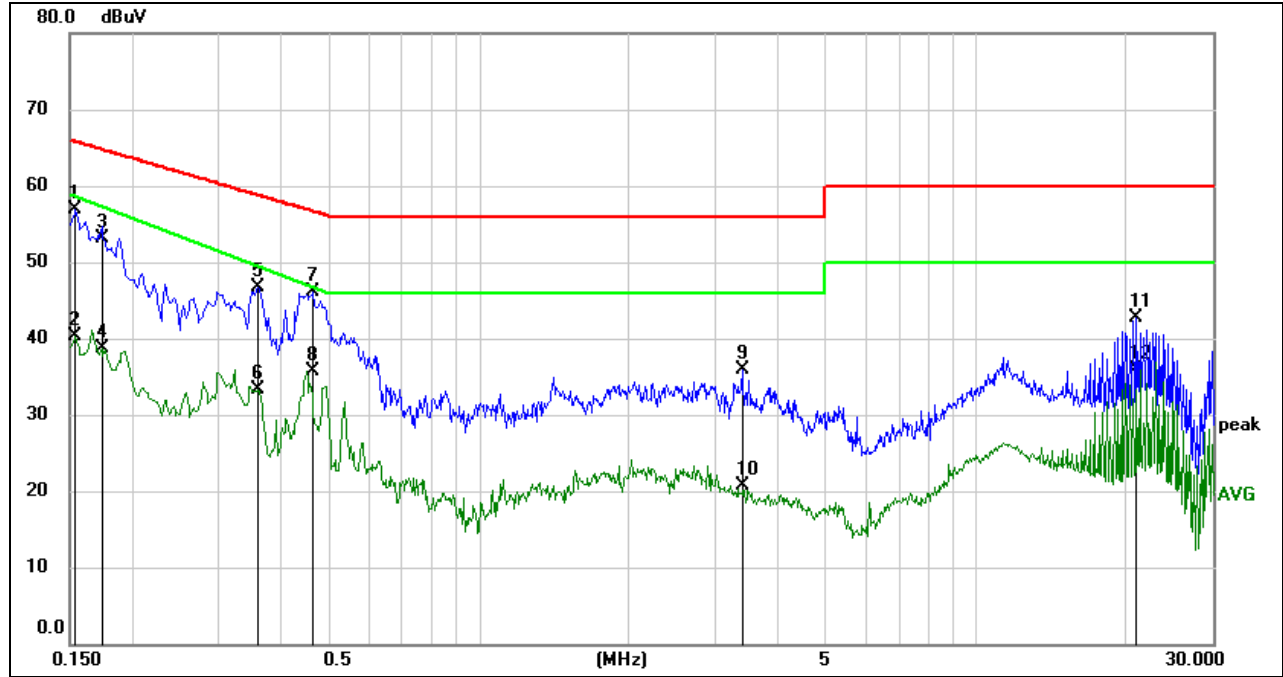

No.	Frequency (MHz)	Reading (dBuV)	Correct (dB)	Result (dBuV)	Limit (dBuV)	Margin (dB)	Remark
1	0.1539	47.29	9.59	56.88	65.79	-8.91	QP
2	0.1539	30.63	9.59	40.22	58.72	-18.50	AVG
3	0.1749	43.49	9.59	53.08	64.72	-11.64	QP
4	0.1749	29.06	9.59	38.65	57.34	-18.69	AVG
5	0.3577	37.32	9.43	46.75	58.78	-12.03	QP
6	0.3577	23.78	9.43	33.21	49.62	-16.41	AVG
7	0.4637	36.71	9.34	46.05	56.63	-10.58	QP
8	0.4639	26.42	9.34	35.76	46.81	-11.05	AVG
9	3.3814	26.23	9.61	35.84	56.00	-20.16	QP
10	3.3814	11.19	9.61	20.80	46.00	-25.20	AVG
11	21.0355	32.96	9.74	42.70	60.00	-17.30	QP
12	21.0355	26.14	9.74	35.88	50.00	-14.12	AVG

Note: 1. Result = Reading + Correct Factor.

2. If QP Result complies with AV limit, AV Result is deemed to comply with AV limit.

3. Test setup: RBW: 200 Hz (9 kHz ~ 150 kHz), 9 kHz (150 kHz ~ 30 MHz).

4. Step size: 80 Hz (0.009 MHz ~ 0.15 MHz), 4 kHz (0.15 MHz ~ 30 MHz), Scan time: auto.

LINE N RESULTS (UNII-3 BAND MID CHANNEL, WORST-CASE CONFIGURATION)

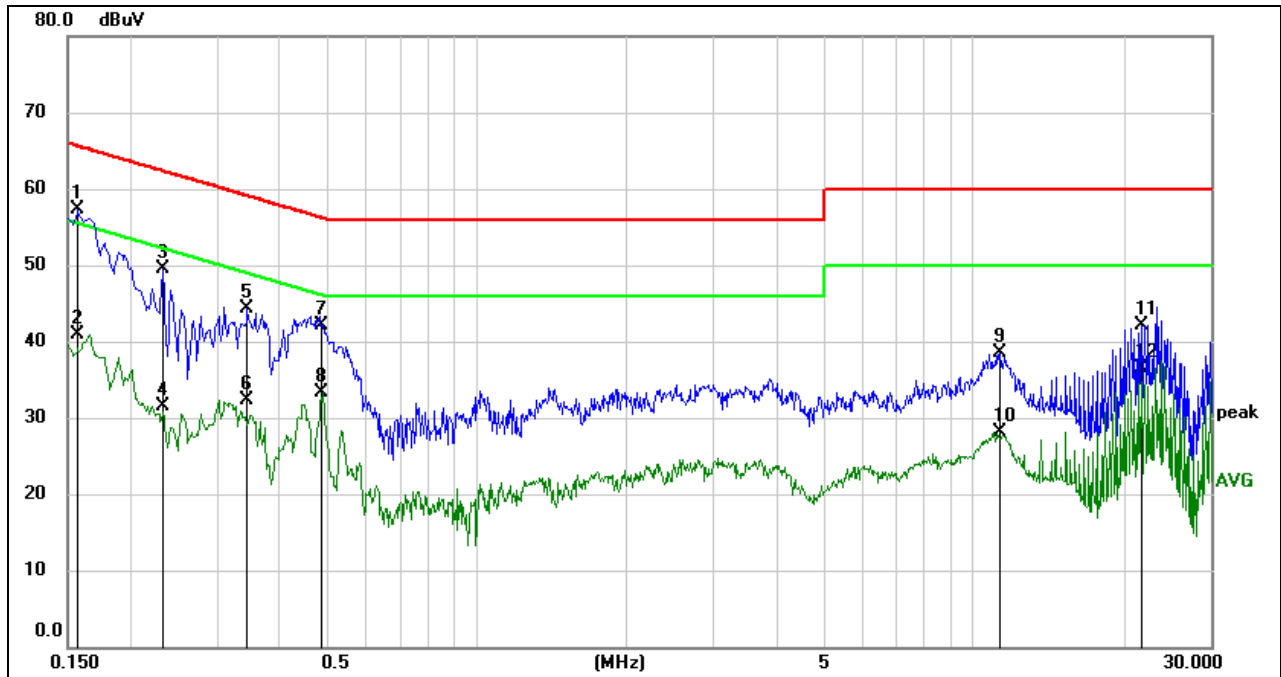

No.	Frequency (MHz)	Reading (dBuV)	Correct (dB)	Result (dBuV)	Limit (dBuV)	Margin (dB)	Remark
1	0.1580	47.75	9.51	57.26	65.57	-8.31	QP
2	0.1580	31.33	9.51	40.84	55.57	-14.73	AVG
3	0.2340	39.92	9.58	49.50	62.31	-12.81	QP
4	0.2340	21.85	9.58	31.43	52.31	-20.88	AVG
5	0.3459	34.75	9.54	44.29	59.06	-14.77	QP
6	0.3459	22.73	9.54	32.27	49.06	-16.79	AVG
7	0.4863	32.60	9.50	42.10	56.23	-14.13	QP
8	0.4863	23.90	9.50	33.40	46.23	-12.83	AVG
9	11.2659	28.91	9.64	38.55	60.00	-21.45	QP
10	11.2659	18.44	9.64	28.08	50.00	-21.92	AVG
11	21.8060	32.29	9.76	42.05	60.00	-17.95	QP
12	21.8060	26.73	9.76	36.49	50.00	-13.51	AVG

Note: 1. Result = Reading + Correct Factor.
 2. If QP Result complies with AV limit, AV Result is deemed to comply with AV limit.
 3. Test setup: RBW: 200 Hz (9 kHz ~ 150 kHz), 9 kHz (150 kHz ~ 30 MHz).
 4. Step size: 80 Hz (0.009 MHz ~ 0.15 MHz), 4 kHz (0.15 MHz ~ 30 MHz), Scan time: auto.

Note: All the modes and channels had been tested, but only the worst data was recorded in the report.

10. FREQUENCY STABILITY

LIMITS

The frequency of the carrier signal shall be maintained within band of operation.

TEST PROCEDURE

1. The EUT was placed inside an environmental chamber as the temperature in the chamber was varied between 0 °C ~ 35 °C (declared by customer).
2. The temperature was incremented by 10 °C intervals and the unit allowed to stabilize at each temperature before each measurement. The center frequency of the transmitting channel was evaluated at each temperature and the frequency deviation from the channel's center frequency was recorded.
3. The primary supply voltage is varied from 85 % to 115 % of the nominal value for non hand-carried battery and AC powered equipment. For hand-carried, battery-powered equipment, primary supply voltage is reduced to the battery operating end point which shall be specified by the manufacturer.

Connect the EUT to the spectrum analyser and use the following settings:

Center Frequency	The center frequency of the channel under test
Detector	Peak
RBW	10 kHz
VBW	$\geq 3 \times \text{RBW}$
Span	Encompass the entire emissions bandwidth (EBW) of the signal
Trace	Max hold
Sweep time	Auto

4. While maintaining a constant temperature inside the environmental chamber, turn the EUT on and record the operating frequency at startup, and at 2 minutes, 5 minutes, and 10 minutes after the EUT is energized.
5. Allow the trace to stabilize, find the peak value of the power envelope and record the frequency, then calculated the frequency drift.

TEST SETUP

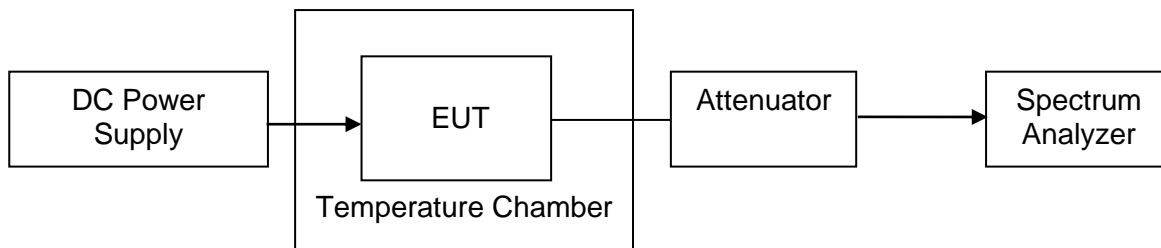



TEST ENVIRONMENT

	Normal Test Conditions	Extreme Test Conditions
Relative Humidity	20 % - 75 %	/
Atmospheric Pressure	100 kPa ~102 kPa	/
Temperature	T _N (Normal Temperature): 22 °C – 28 °C	T _L (Low Temperature): 0 °C
		T _H (High Temperature): 55 °C
Supply Voltage	V _N (Normal Voltage): AC 120 V, 60Hz	V _L (Low Voltage): AC 138 V, 60Hz
		V _H (High Voltage): AC 102 V, 60Hz

RESULTS

Please refer to Appendix G.

11. DYNAMIC FREQUENCY SELECTION

APPLICABILITY OF DFS REQUIREMENTS

A U-NII network will employ a DFS function to detect signals from radar systems and to avoid co-channel operation with these systems. This applies to the 5250-5350 MHz and/or 5470-5725 MHz bands.

Within the context of the operation of the DFS function, a U-NII device will operate in either Master Mode or Client Mode. U-NII devices operating in Client Mode can only operate in a network controlled by a U-NII device operating in Master Mode.

Table 1: Applicability of DFS Requirements Prior to Use of a Channel

Requirement	Operational Mode		
	<input type="checkbox"/> Master	<input checked="" type="checkbox"/> Client Without Radar Detection	<input type="checkbox"/> Client With Radar Detection
Non-Occupancy Period	Yes	Not required	Yes
DFS Detection Threshold	Yes	Not required	Yes
Channel Availability Check Time	Yes	Not required	Not required
U-NII Detection Bandwidth	Yes	Not required	Yes

Table 2: Applicability of DFS requirements during normal operation

Requirement	Operational Mode	
	<input type="checkbox"/> Master Device or Client with Radar Detection	<input checked="" type="checkbox"/> Client Without Radar Detection
DFS Detection Threshold	Yes	Not required
Channel Closing Transmission Time	Yes	Yes
Channel Move Time	Yes	Yes
U-NII Detection Bandwidth	Yes	Not required

Additional requirements for devices with multiple bandwidth modes	<input type="checkbox"/> Master Device or Client with Radar Detection	<input checked="" type="checkbox"/> Client Without Radar Detection
U-NII Detection Bandwidth and Statistical Performance Check	All BW modes must be tested	Not required
Channel Move Time and Channel Closing Transmission Time	Test using widest BW mode available	Test using the widest BW mode available for the link
All other tests	Any single BW mode	Not required

Note: Frequencies selected for statistical performance check should include several frequencies within the radar detection bandwidth and frequencies near the edge of the radar detection bandwidth. For 802.11 devices it is suggested to select frequencies in each of the bonded 20 MHz channels and the channel center frequency.

LIMITS

(1) DFS Detection Thresholds

Table 3: DFS Detection Thresholds for Master Devices and Client Devices With Radar Detection

Maximum Transmit Power	Value (See Notes 1, 2, and 3)
EIRP \geq 200 milliwatt	-64 dBm
EIRP < 200 milliwatt and power spectral density < 10 dBm/MHz	-62 dBm
EIRP < 200 milliwatt that do not meet the power spectral density requirement	-64 dBm

Note 1: This is the level at the input of the receiver assuming a 0 dBi receive antenna.
 Note 2: Throughout these test procedures an additional 1 dB has been added to the amplitude of the test transmission waveforms to account for variations in measurement equipment. This will ensure that the test signal is at or above the detection threshold level to trigger a DFS response.
 Note3: EIRP is based on the highest antenna gain. For MIMO devices refer to KDB Publication 662911 D01.

(2) DFS Response Requirements

Table 4: DFS Response Requirement Values

Parameter	Value
Non-occupancy period	Minimum 30 minutes
Channel Availability Check Time	60 seconds
Channel Move Time	10 seconds See Note 1.
Channel Closing Transmission Time	200 milliseconds + an aggregate of 60 milliseconds over remaining 10 second period. See Notes 1 and 2.
U-NII Detection Bandwidth	Minimum 100% of the U-NII 99% transmission power bandwidth. See Note 3.

Note 1: Channel Move Time and the Channel Closing Transmission Time should be performed with Radar Type 0. The measurement timing begins at the end of the Radar Type 0 burst.
 Note 2: The Channel Closing Transmission Time is comprised of 200 milliseconds starting at the beginning of the Channel Move Time plus any additional intermittent control signals required facilitating a Channel move (an aggregate of 60 milliseconds) during the remainder of the 10 second period. The aggregate duration of control signals will not count quiet periods in between transmissions.
 Note 3: During the U-NII Detection Bandwidth detection test, radar type 0 should be used. For each frequency step the minimum percentage of detection is 90 percent. Measurements are performed with no data traffic.

PARAMETERS OF RADAR TEST WAVEFORMS

This section provides the parameters for required test waveforms, minimum percentage of successful detections, and the minimum number of trials that must be used for determining DFS conformance. Step intervals of 0.1 microsecond for Pulse Width, 1 microsecond for PRI, 1 MHz for chirp width and 1 for the number of pulses will be utilized for the random determination of specific test waveforms.

Table 5 Short Pulse Radar Test Waveforms

Radar Type	Pulse Width (μsec)	PRI (μsec)	Number of Pulses	Minimum Percentage of Successful Detection	Minimum Number of Trials
0	1	1428	18	See Note 1	See Note 1
1	1	Test A	Roundup $\left\{ \left(\frac{1}{360} \right)^n \right\}$	60%	30
		Test B			
2	1-5	150-230	23-29	60%	30
3	6-10	200-500	16-18	60%	30
4	11-20	200-500	12-16	60%	30
Aggregate (Radar Types 1-4)				80%	120
<p>Note 1: Short Pulse Radar Type 0 should be used for the detection bandwidth test, channel move time, and channel closing time tests.</p> <p>Test A: 15 unique PRI values randomly selected from the list of 23 PRI values in Table 5a</p> <p>Test B: 15 unique PRI values randomly selected within the range of 518-3066 μsec, with a minimum increment of 1 μsec, excluding PRI values selected in Test A</p>					

A minimum of 30 unique waveforms are required for each of the Short Pulse Radar Types 2 through 4. If more than 30 waveforms are used for Short Pulse Radar Types 2 through 4, then each additional waveform must also be unique and not repeated from the previous waveforms. If more than 30 waveforms are used for Short Pulse Radar Type 1, then each additional waveform is generated with Test B and must also be unique and not repeated from the previous waveforms in Tests A or B. Test aggregate is average of the percentage of successful detections of short pulse radar types 1-4.

TEST SETUP

Setup for Client with injection at the Master

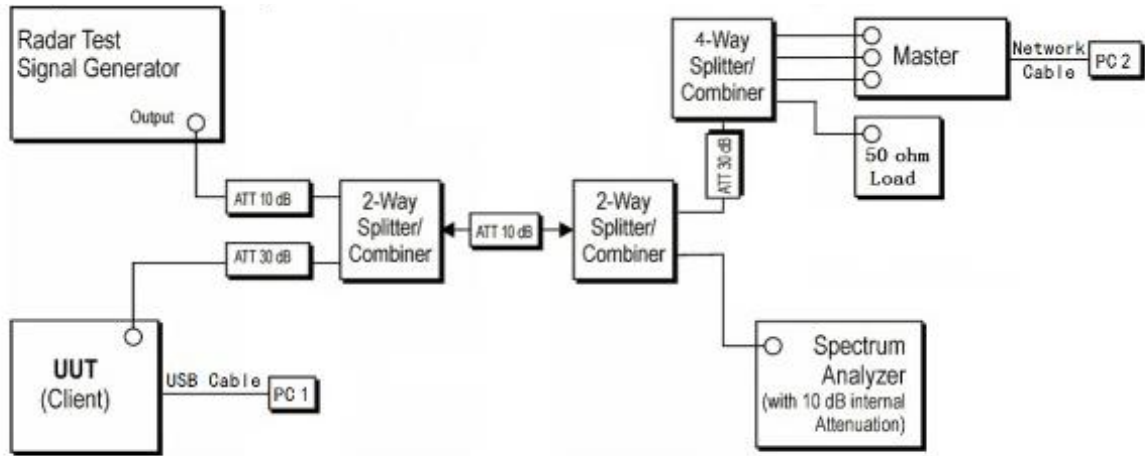

RESULTS

Please refer to Appendix E&F.



12. ANTENNA REQUIREMENTS

APPLICABLE REQUIREMENTS

Please refer to FCC §15.203

An intentional radiator shall be designed to ensure that no antenna other than that furnished by the responsible party shall be used with the device. The use of a permanently attached antenna or of an antenna that uses a unique coupling to the intentional radiator shall be considered sufficient to comply with the provisions of this section. The manufacturer may design the unit so that a broken antenna can be replaced by the user, but the use of a standard antenna jack or electrical connector is prohibited.

Please refer to FCC §15.247(b)(4)

The conducted output power limit specified in paragraph (b) of this section is based on the use of antennas with directional gains that do not exceed 6 dBi. Except as shown in paragraph (c) of this section, if transmitting antennas of directional gain greater than 6 dBi are used, the conducted output power from the intentional radiator shall be reduced below the stated values in paragraphs (b)(1), (b)(2), and (b)(3) of this section, as appropriate, by the amount in dB that the directional gain of the antenna exceeds 6 dBi.

RESULTS

Complies



13. Appendix

13.1. Appendix A1: Emission Bandwidth

13.1.1. Test Result

Test Mode	Antenna	Channel	26db EBW [MHz]	FL[MHz]	FH[MHz]	Verdict		
11A	Ant1	5180	20.120	5169.800	5189.920	PASS		
		5200	19.560	5190.160	5209.720	PASS		
		5240	19.720	5230.120	5249.840	PASS		
		5260	19.880	5250.080	5269.960	PASS		
		5280	19.600	5270.080	5289.680	PASS		
		5320	19.840	5310.160	5330.000	PASS		
		5500	20.360	5489.720	5510.080	PASS		
		5580	19.640	5570.120	5589.760	PASS		
		5700	19.600	5690.160	5709.760	PASS		
		5720	20.040	5710.000	5730.040	PASS		
		5720_UNII-2C	15	5710.000	5725	PASS		
		5720_UNII-3	5.04	5725	5730.040	PASS		
		5745	19.880	5735.120	5755.000	PASS		
		5785	19.760	5775.040	5794.800	PASS		
5825	19.840	5815.040	5834.880	PASS				
11AC20SISO	Ant1	5180	20.000	5169.960	5189.960	PASS		
		5200	20.200	5189.920	5210.120	PASS		
		5240	20.280	5229.800	5250.080	PASS		
		5260	19.960	5250.040	5270.000	PASS		
		5280	20.200	5269.840	5290.040	PASS		
		5320	20.040	5309.920	5329.960	PASS		
		5500	20.160	5489.880	5510.040	PASS		
		5580	20.080	5569.840	5589.920	PASS		
		5700	20.080	5689.840	5709.920	PASS		
		5720	20.040	5709.920	5729.960	PASS		
		5720_UNII-2C	15.08	5709.920	5725	PASS		
		5720_UNII-3	4.96	5725	5729.960	PASS		
		5745	20.240	5734.880	5755.120	PASS		
		5785	20.080	5774.840	5794.920	PASS		
5825	20.440	5814.800	5835.240	PASS				
11AC40SISO	Ant1	5190	40.160	5170.000	5210.160	PASS		
		5230	40.560	5209.680	5250.240	PASS		
		5270	40.480	5249.760	5290.240	PASS		
		5310	40.240	5289.920	5330.160	PASS		
		5510	40.080	5490.000	5530.080	PASS		
		5590	39.680	5570.160	5609.840	PASS		
		5670	40.080	5649.760	5689.840	PASS		
		5710	40.720	5689.440	5730.160	PASS		
		5710_UNII-2C	35.56	5689.440	5725	PASS		
		5710_UNII-3	5.16	5725	5730.160	PASS		
		5755	40.480	5734.680	5775.160	PASS		
		5795	40.320	5774.760	5815.080	PASS		
		11AC80SISO	Ant1	5210	80.640	5169.840	5250.480	PASS
				5290	80.960	5249.520	5330.480	PASS
5530	80.800			5489.680	5570.480	PASS		
5610	81.280			5569.520	5650.800	PASS		
5690	80.640			5649.520	5730.160	PASS		
5690_UNII-2C	75.48			5649.520	5725	PASS		
5690_UNII-3	5.16			5725	5730.160	PASS		
5775	80.800			5734.520	5815.320	PASS		

13.1.2. Test Graphs





11A_Ant1_5260

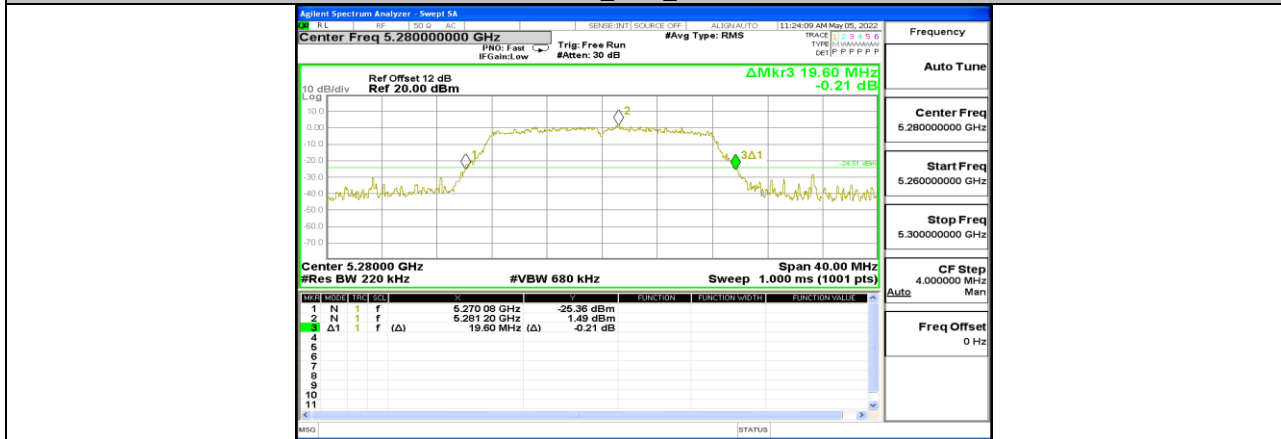

11A_Ant1_5280



11A_Ant1_5320



11A_Ant1_5500



11A_Ant1_5580



11A_Ant1_5700



11A_Ant1_5720

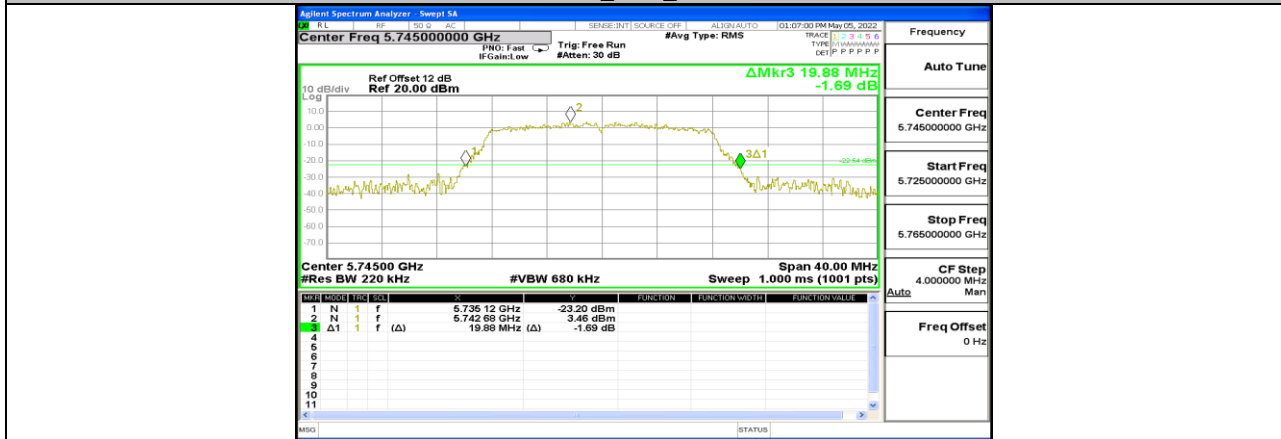

11A_Ant1_5745

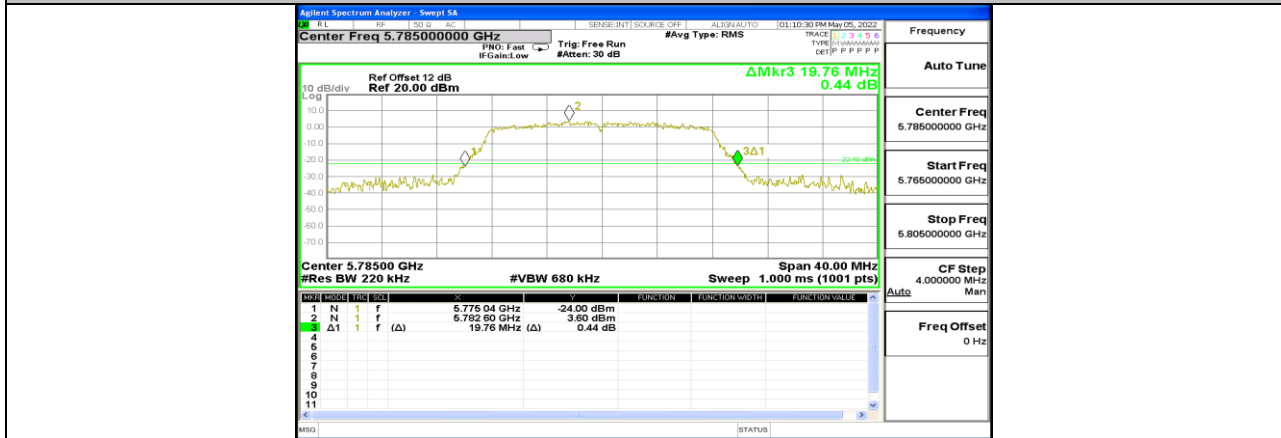

11A_Ant1_5785



11A_Ant1_5825

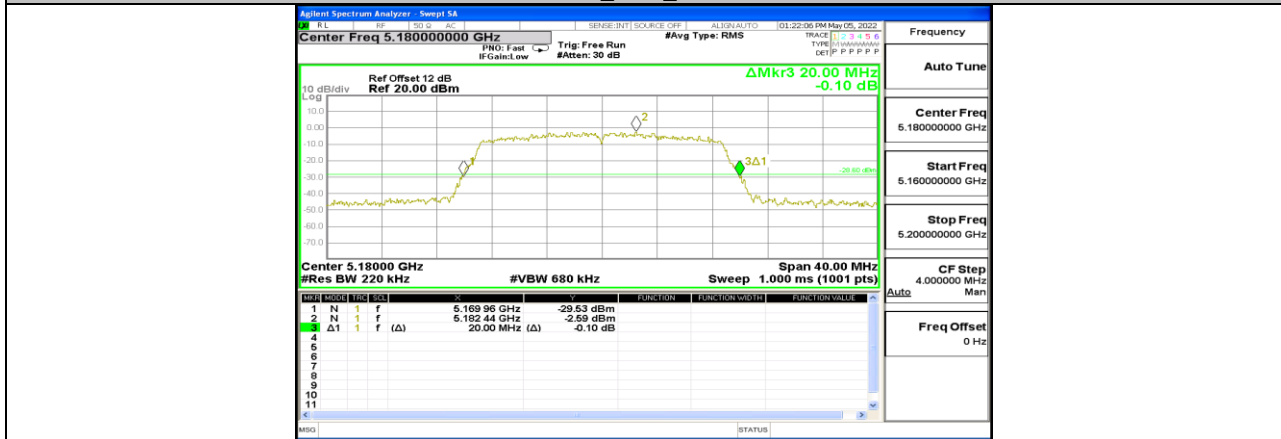

11AC20SISO_Ant1_5180

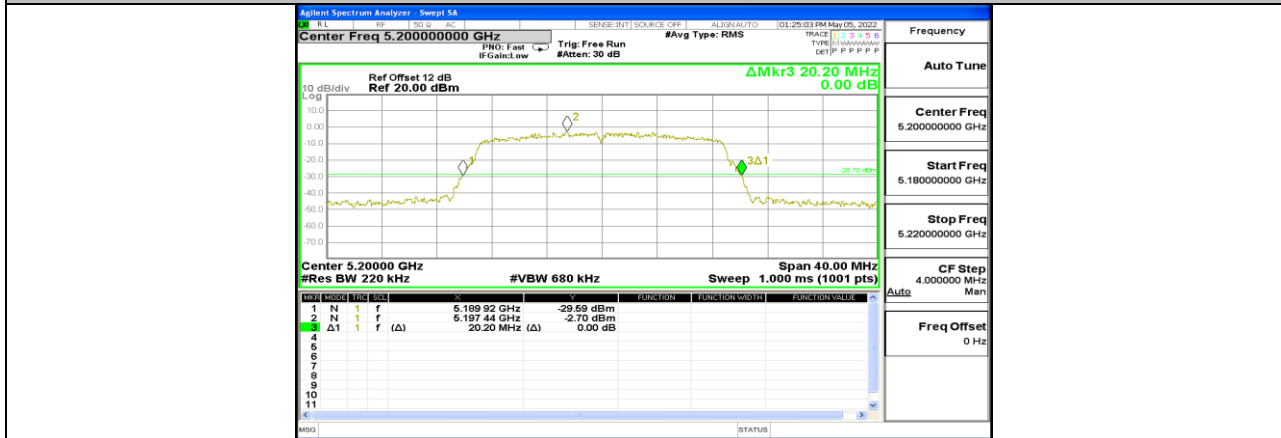

11AC20SISO_Ant1_5200



11AC20SISO_Ant1_5240

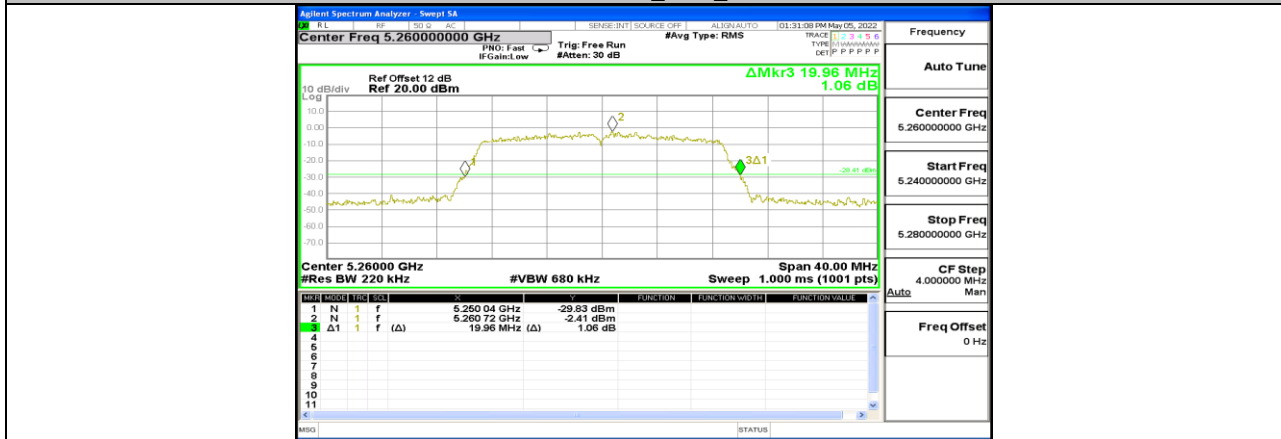

11AC20SISO_Ant1_5260

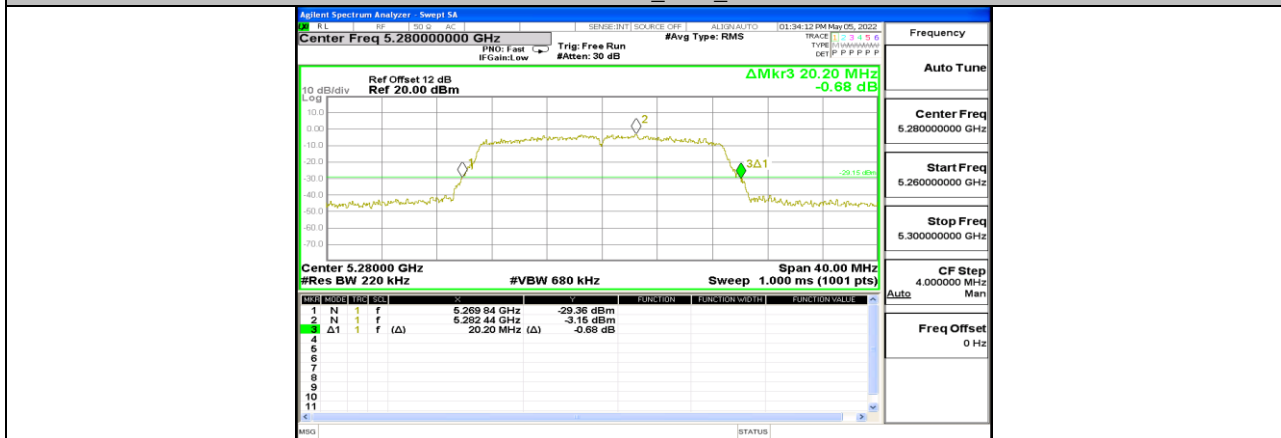

11AC20SISO_Ant1_5280



11AC20SISO_Ant1_5320

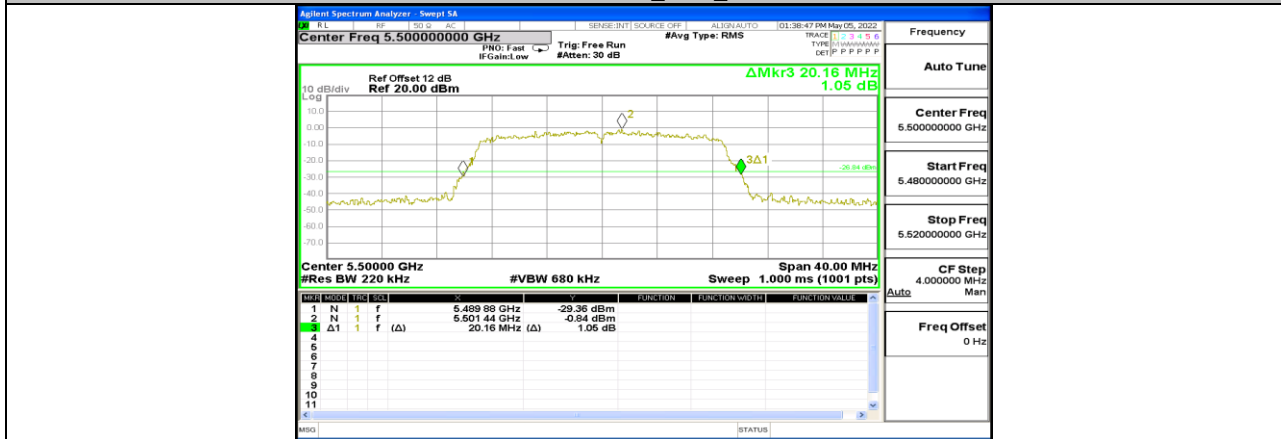

11AC20SISO_Ant1_5500



11AC20SISO_Ant1_5580



11AC20SISO_Ant1_5700

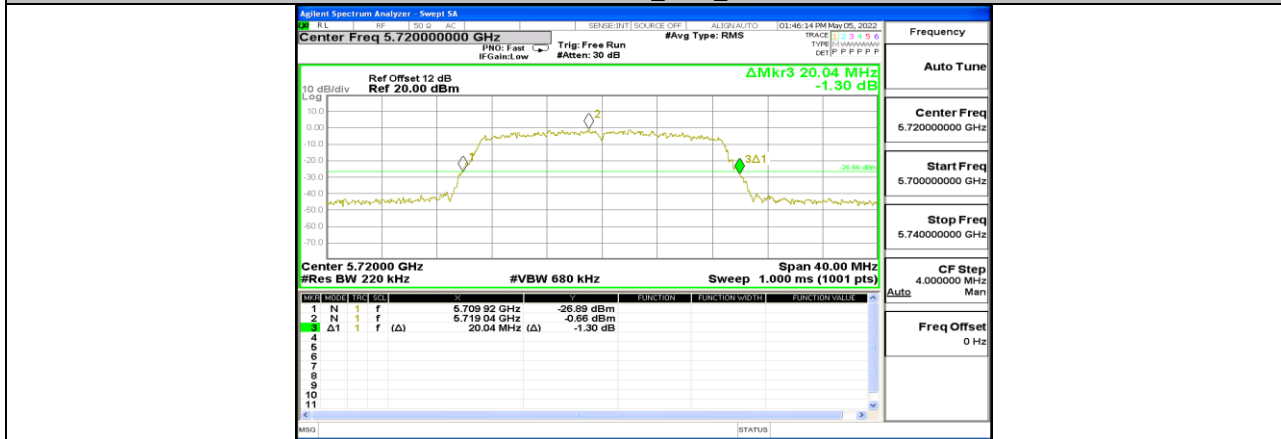

11AC20SISO_Ant1_5720



11AC20SISO_Ant1_5745



11AC20SISO_Ant1_5785

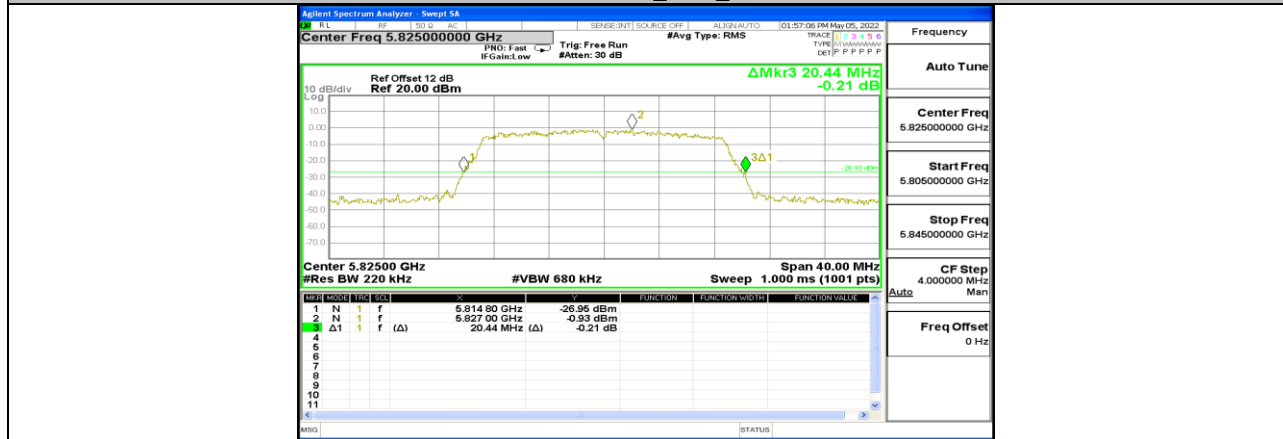

11AC20SISO_Ant1_5825

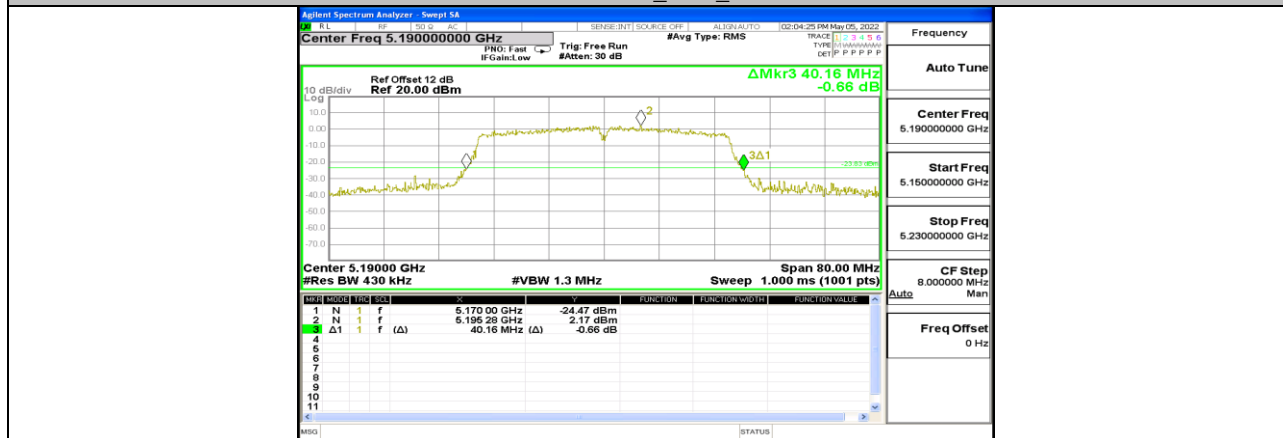

11AC40SISO_Ant1_5190



11AC40SISO_Ant1_5230

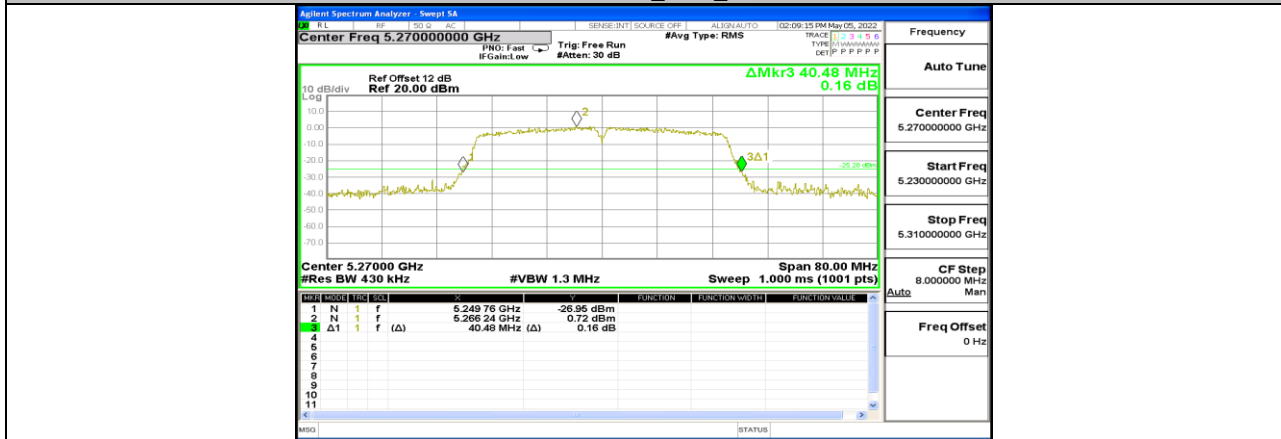

11AC40SISO_Ant1_5270

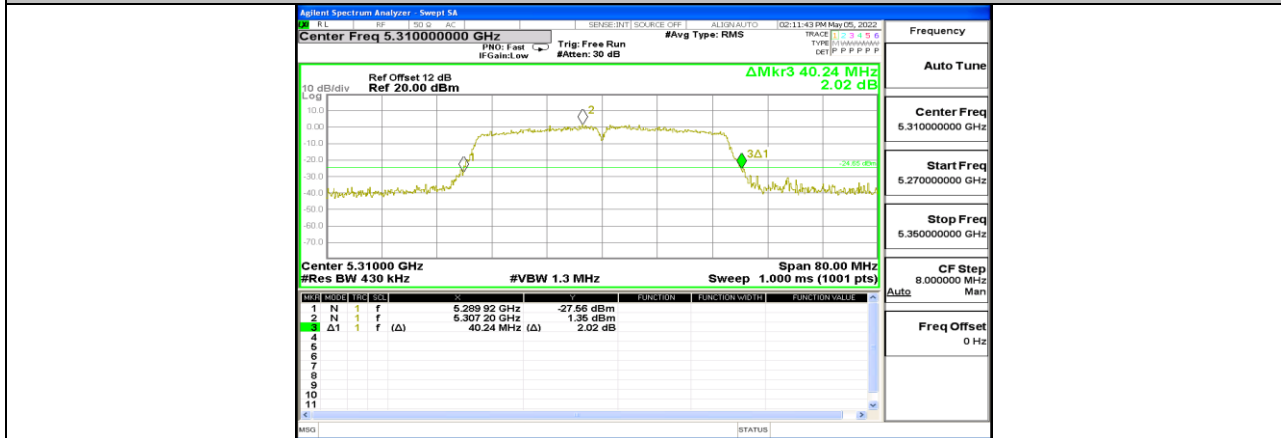

11AC40SISO_Ant1_5310

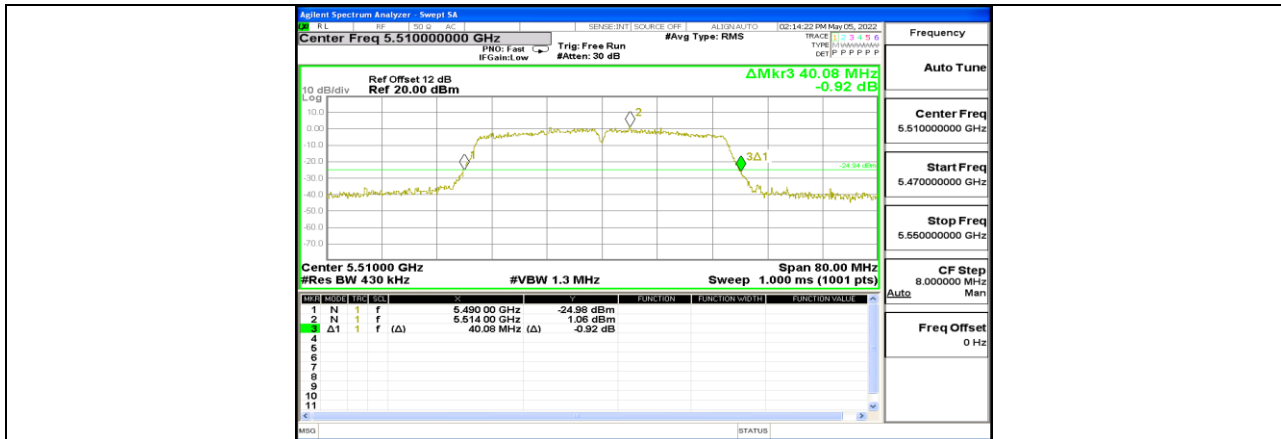

11AC40SISO_Ant1_5510



11AC40SISO_Ant1_5590

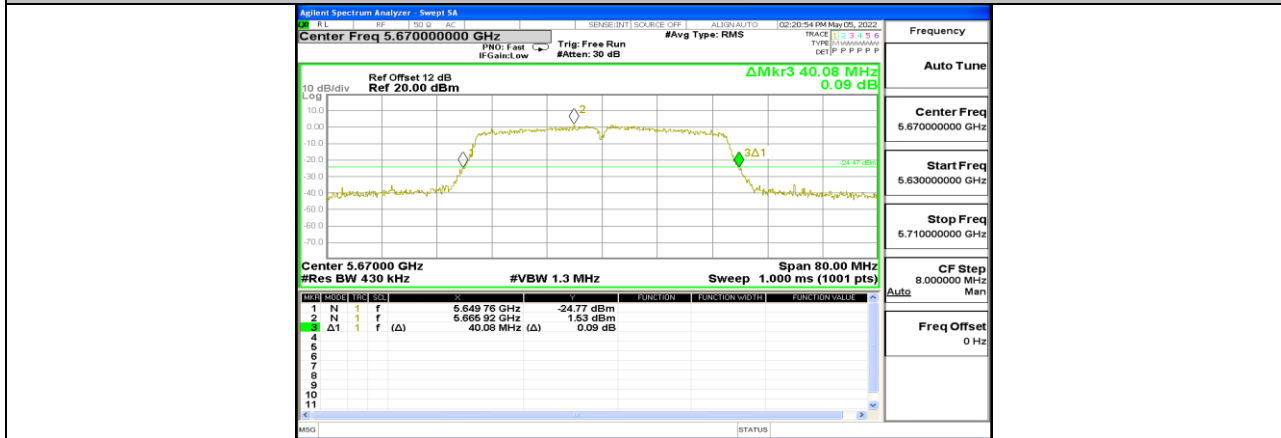

11AC40SISO_Ant1_5670



11AC40SISO_Ant1_5710

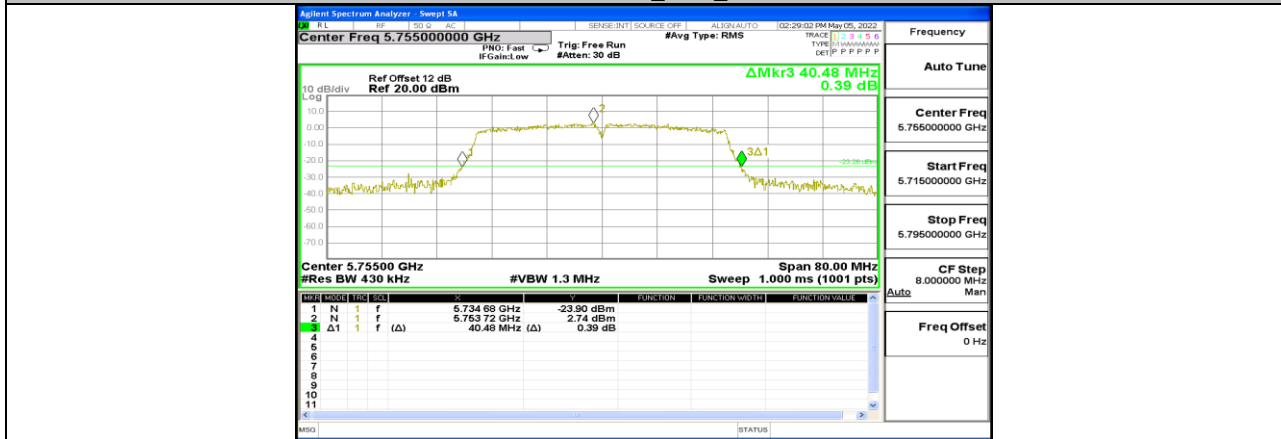

11AC40SISO_Ant1_5755



11AC40SISO_Ant1_5795