

Z (mm)	0.00	4.00	9.00	14.00	19.00	24.00	29.00
SAR (W/Kg)	0.5320	0.3664	0.2269	0.1422	0.0883	0.0553	0.0344

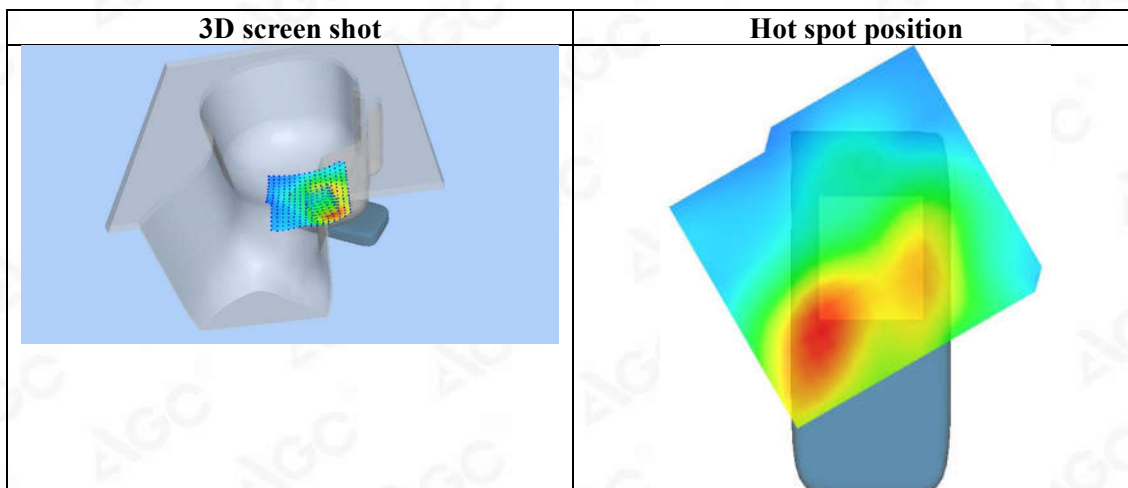

Any report having not been signed by authorized approver, or having been altered without authorization, or having not been stamped by the "Dedicated Testing/Inspection Stamp" is deemed to be invalid. Copying or excerpting portion of, or altering the content of the report is not permitted without the written authorization of AGC. The test results presented in the report apply only to the tested sample. Any objections to report issued by AGC should be submitted to AGC within 15days after the issuance of the test report. Further enquiry of validity or verification of the test report should be addressed to AGC by agc@agc-cert.com.

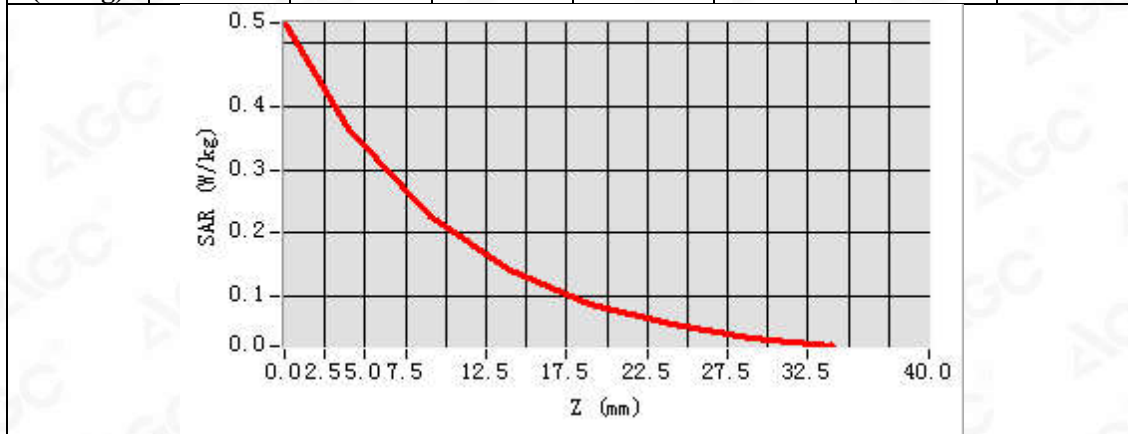

Test Laboratory: AGC Lab
LTE Band 4 Mid-Body-Back (1 RB#0)
DUT: Smart phone; Type: K58

Date: Jan. 21, 2022

Communication System: LTE; Communication System Band: LTE Band 4; Duty Cycle:1:1; Conv.F=4.57;
Frequency:1732.5 MHz; Medium parameters used: $f = 1800$ MHz; $\sigma = 1.36$ mho/m; $\epsilon_r = 40.56$; $\rho = 1000$ kg/m³ ;
Phantom section: Flat Section
Ambient temperature (°C): 21.0, Liquid temperature (°C): 20.8

SATIMO Configuration:

- Probe: SSE5; Calibrated: Aug. 17, 2021; Serial No.: SN 24/20 EP336
- Sensor-Surface: 4mm (Mechanical Surface Detection)
- Phantom: ELLI39 Phantom
- Measurement SW: OpenSAR V4_02_35

Configuration/ LTE Band 4 Mid-Body-Back/Area Scan: Measurement grid: dx=8mm, dy=8mm
Configuration/ LTE Band 4 Mid-Body-Back/Zoom Scan: Measurement grid: dx=8mm,dy=8mm, dz=5m;

Area Scan	dx=8mm dy=8mm, h= 5.00 mm
Zoom Scan	5x5x7,dx=8mm dy=8mm dz=5mm
Phantom	ELLI
Device Position	Body Back
Band	LTE Band 4
Channels	Middle
Signal	OFDM (Crest factor: 1.0)

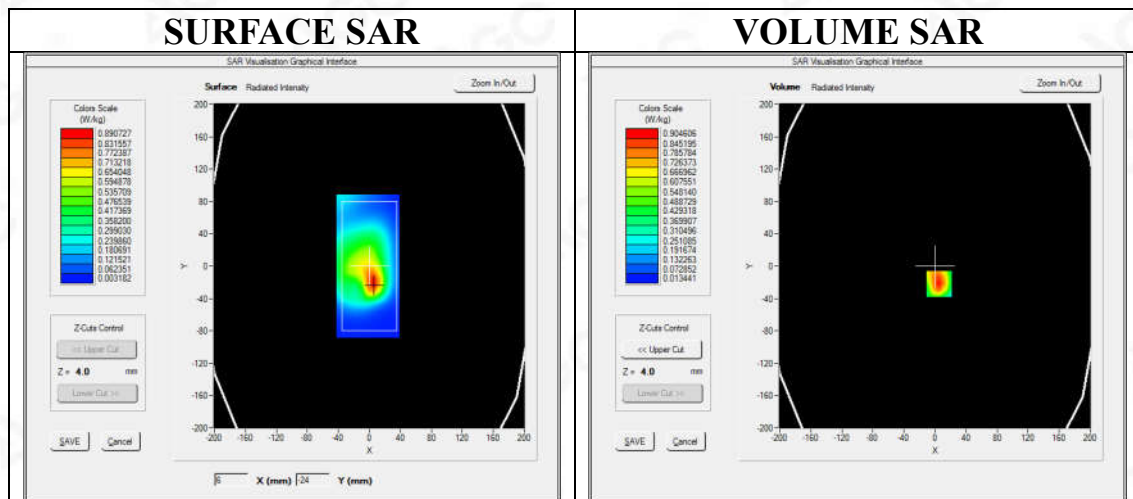

Maximum location: X=5.00, Y=-22.00
SAR Peak: 1.40 W/kg

SAR 10g (W/Kg)	0.469373
SAR 1g (W/Kg)	0.857955

Any report having not been signed by authorized approver, or having been altered without authorization, or having not been stamped by the "Dedicated Testing/Inspection Stamp" is deemed to be invalid. Copying or excerpting portion of, or altering the content of the report is not permitted without the written authorization of AGC. The test results presented in the report apply only to the tested sample. Any objections to report issued by AGC should be submitted to AGC within 15days after the issuance of the test report. Further enquiry of validity or verification of the test report should be addressed to AGC by agc@agc-cert.com.



Z (mm)	0.00	4.00	9.00	14.00	19.00	24.00	29.00
SAR (W/Kg)	1.4095	0.9046	0.5058	0.2893	0.1639	0.0928	0.0533

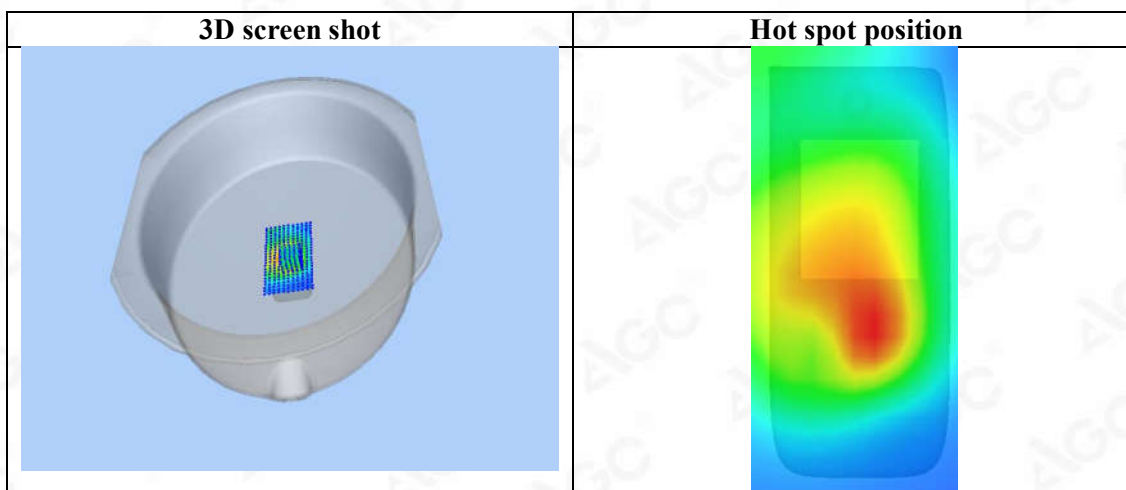
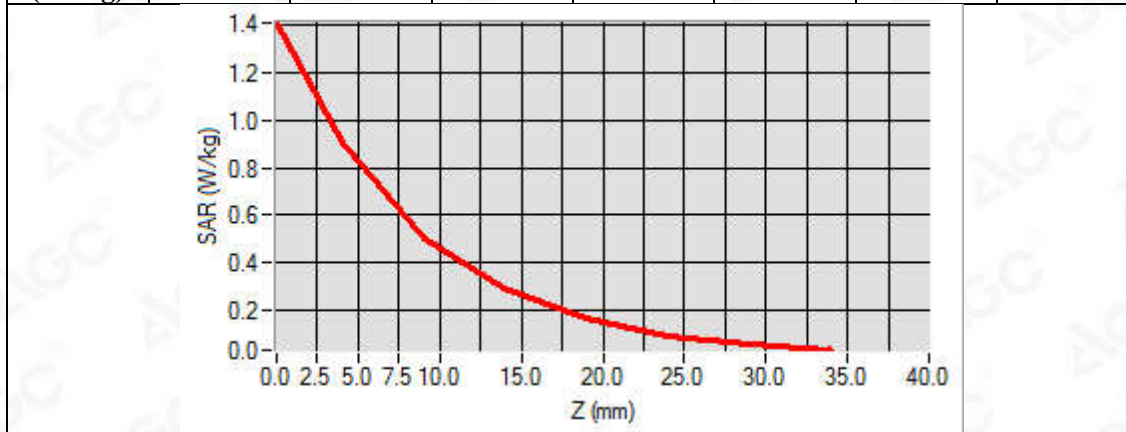

Any report having not been signed by authorized approver, or having been altered without authorization, or having not been stamped by the "Dedicated Testing/Inspection Stamp" is deemed to be invalid. Copying or excerpting portion of, or altering the content of the report is not permitted without the written authorization of AGC. The test results presented in the report apply only to the tested sample. Any objections to report issued by AGC should be submitted to AGC within 15 days after the issuance of the test report. Further enquiry of validity or verification of the test report should be addressed to AGC by agc@agc-cert.com.



Test Laboratory: AGC Lab
LTE Band 4 High-Body-Back (1 RB#0)
DUT: Smart phone; Type: K58

Date: Jan. 21, 2022

Communication System: LTE; Communication System Band: LTE Band 4; Duty Cycle:1:1; Conv.F=4.57;
Frequency:1745 MHz; Medium parameters used: $f = 1800$ MHz; $\sigma = 1.36$ mho/m; $\epsilon = 40.56$; $\rho = 1000$ kg/m³ ;
Phantom section: Flat Section
Ambient temperature (°C): 21.0, Liquid temperature (°C): 20.8

SATIMO Configuration:

- Probe: SSE5; Calibrated: Aug. 17, 2021; Serial No.: SN 24/20 EP336
- Sensor-Surface: 4mm (Mechanical Surface Detection)
- Phantom: ELLI39 Phantom
- Measurement SW: OpenSAR V4_02_35

Configuration/ LTE Band 4 High-Body-Back/Area Scan: Measurement grid: dx=8mm, dy=8mm
Configuration/ LTE Band 4 High-Body-Back/Zoom Scan: Measurement grid: dx=8mm,dy=8mm, dz=5mm;

Area Scan	dx=8mm dy=8mm, h= 5.00 mm
Zoom Scan	5x5x7,dx=8mm dy=8mm dz=5mm
Phantom	ELLI
Device Position	Body Back
Band	LTE Band 4
Channels	High
Signal	OFDM (Crest factor: 1.0)

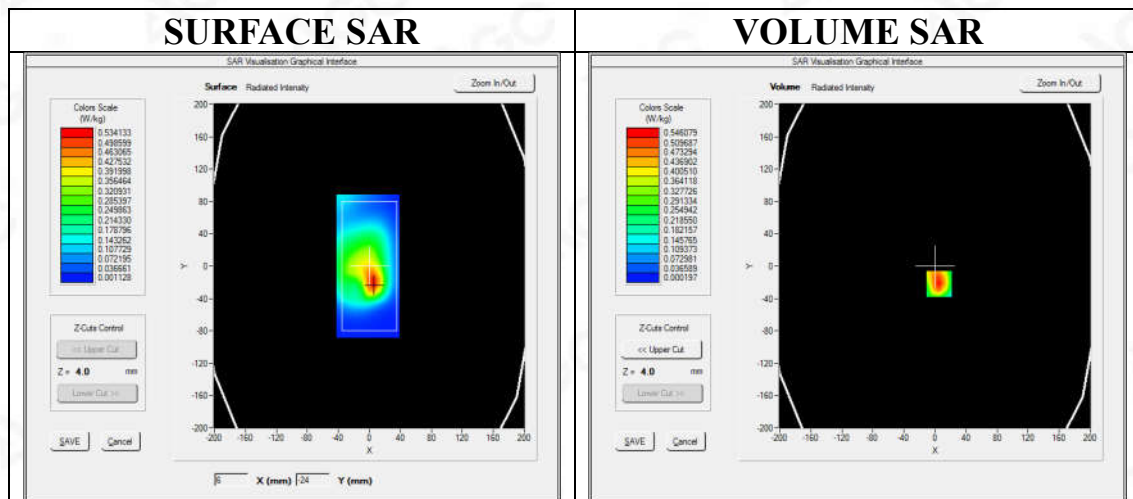

Maximum location: X=5.00, Y=-22.00
SAR Peak: 1.07 W/kg

SAR 10g (W/Kg)	0.426999
SAR 1g (W/Kg)	0.831129

Any report having not been signed by authorized approver, or having been altered without authorization, or having not been stamped by the "Dedicated Testing/Inspection Stamp" is deemed to be invalid. Copying or excerpting portion of, or altering the content of the report is not permitted without the written authorization of AGC. The test results presented in the report apply only to the tested sample. Any objections to report issued by AGC should be submitted to AGC within 15days after the issuance of the test report. Further enquiry of validity or verification of the test report should be addressed to AGC by agc@agc-cert.com.



Z (mm)	0.00	4.00	9.00	14.00	19.00	24.00	29.00
SAR (W/Kg)	1.0779	0.5461	0.1956	0.0722	0.0263	0.0099	0.0038

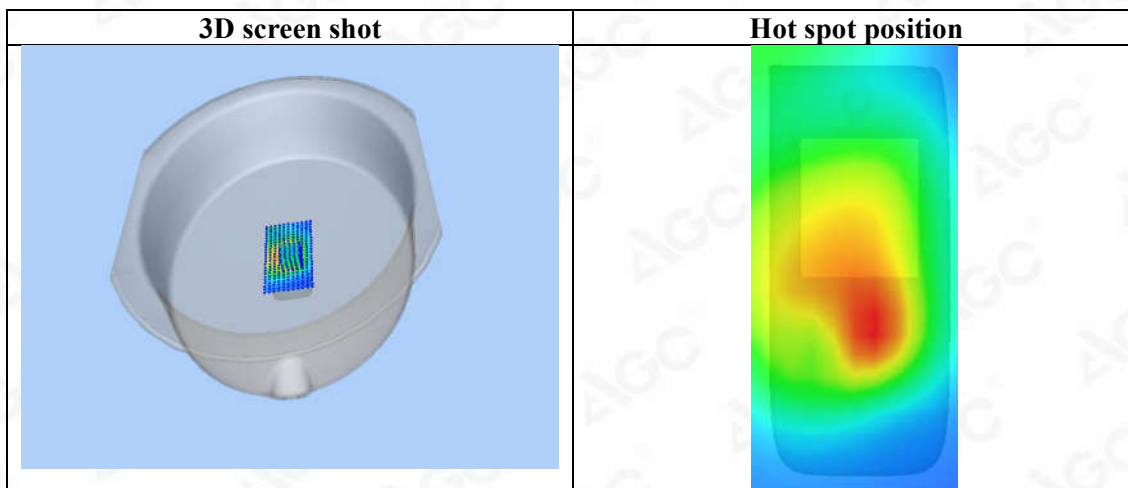
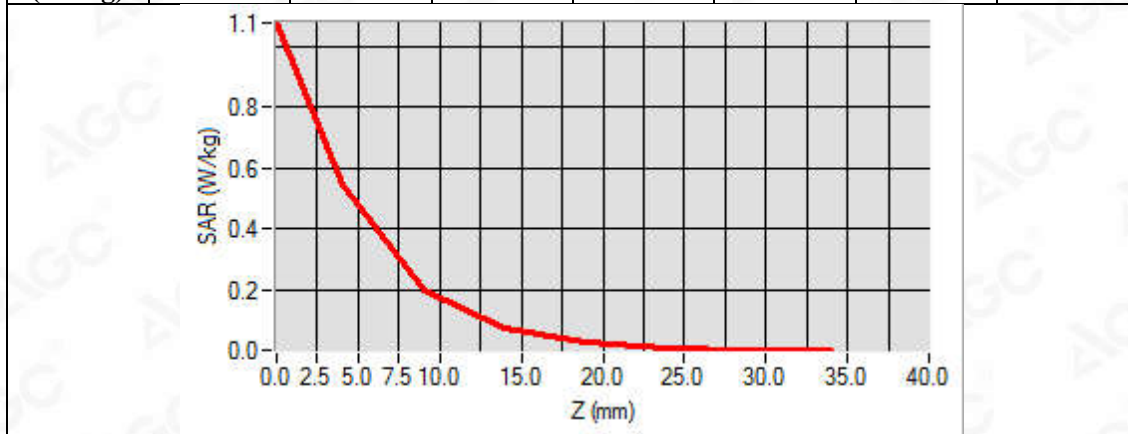

Any report having not been signed by authorized approver, or having been altered without authorization, or having not been stamped by the "Dedicated Testing/Inspection Stamp" is deemed to be invalid. Copying or excerpting portion of, or altering the content of the report is not permitted without the written authorization of AGC. The test results presented in the report apply only to the tested sample. Any objections to report issued by AGC should be submitted to AGC within 15days after the issuance of the test report. Further enquiry of validity or verification of the test report should be addressed to AGC by agc@agc-cert.com.



Test Laboratory: AGC Lab
LTE Band 5 Mid-Touch-Right (1 RB#0)
DUT: Smart phone; Type: K58

Date: Jan. 24, 2022

Communication System: LTE; Communication System Band: LTE Band 5; Duty Cycle:1:1; Conv.F=5.21
Frequency: 836.5 MHz; Medium parameters used: $f = 835$ MHz; $\sigma=0.90$ mho/m; $\epsilon_r=41.35$; $\rho= 1000$ kg/m³ ;
Phantom section: Right Section
Ambient temperature (°C): 22.0, Liquid temperature (°C): 21.8

SATIMO Configuration:

Probe: SSE5; Calibrated: Aug. 17, 2021; Serial No.: SN 24/20 EP336

- Sensor-Surface: 4mm (Mechanical Surface Detection)
- Phantom: SAM twin phantom
- Measurement SW: OpenSAR V4_02_35

Configuration/ LTE Band 5 Mid- Touch-Right /Area Scan: Measurement grid: dx=8mm, dy=8mm
Configuration/ LTE Band 5 Mid- Touch-Right /Zoom Scan: Measurement grid: dx=8mm,dy=8mm, dz=5mm;

Area Scan	dx=8mm dy=8mm, h= 5.00 mm
Zoom Scan	5x5x7,dx=8mm dy=8mm dz=5mm
Phantom	Right head
Device Position	Cheek
Band	LTE Band 5
Channels	Middle
Signal	OFDM (Crest factor: 1.0)

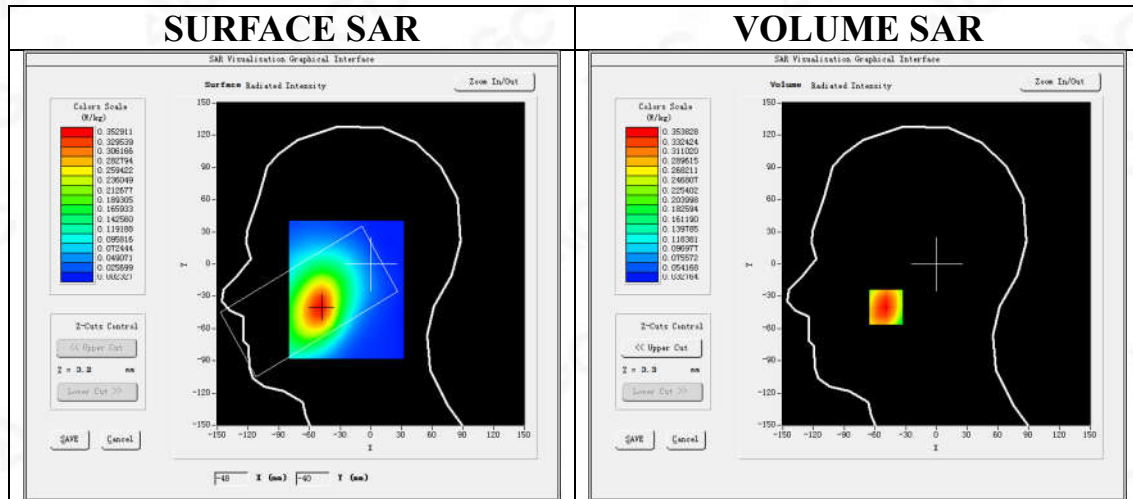

Maximum location: X=-49.00, Y=-40.00
SAR Peak: 0.45 W/kg

SAR 10g (W/Kg)	0.242092
SAR 1g (W/Kg)	0.341556

Any report having not been signed by authorized approver, or having been altered without authorization, or having not been stamped by the "Dedicated Testing/Inspection Stamp" is deemed to be invalid. Copying or excerpting portion of, or altering the content of the report is not permitted without the written authorization of AGC. The test results presented in the report apply only to the tested sample. Any objections to report issued by AGC should be submitted to AGC within 15days after the issuance of the test report. Further enquiry of validity or verification of the test report should be addressed to AGC by agc@agc-cert.com.



Z (mm)	0.00	4.00	9.00	14.00	19.00	24.00	29.00
SAR (W/Kg)	0.4520	0.3538	0.2634	0.2025	0.1544	0.1172	0.0909

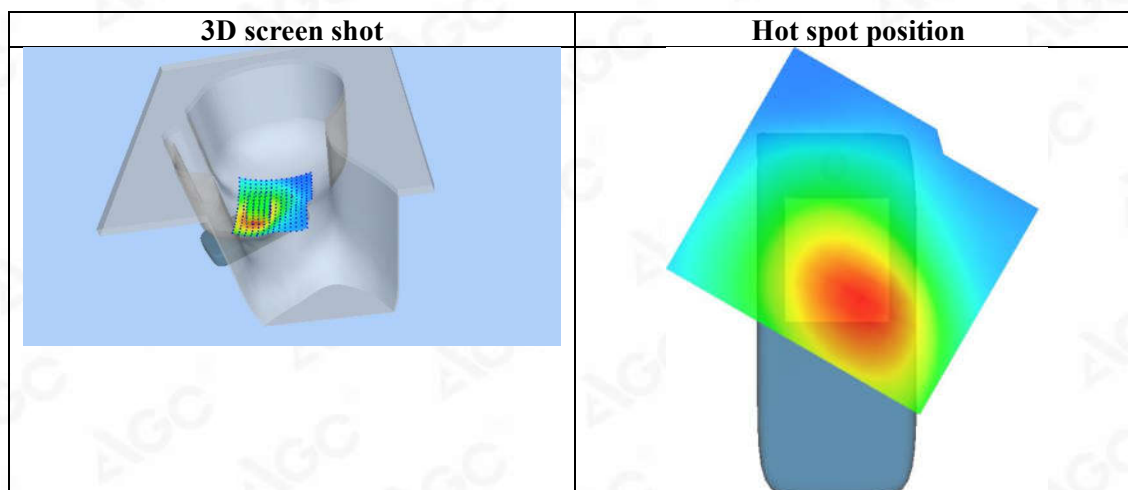
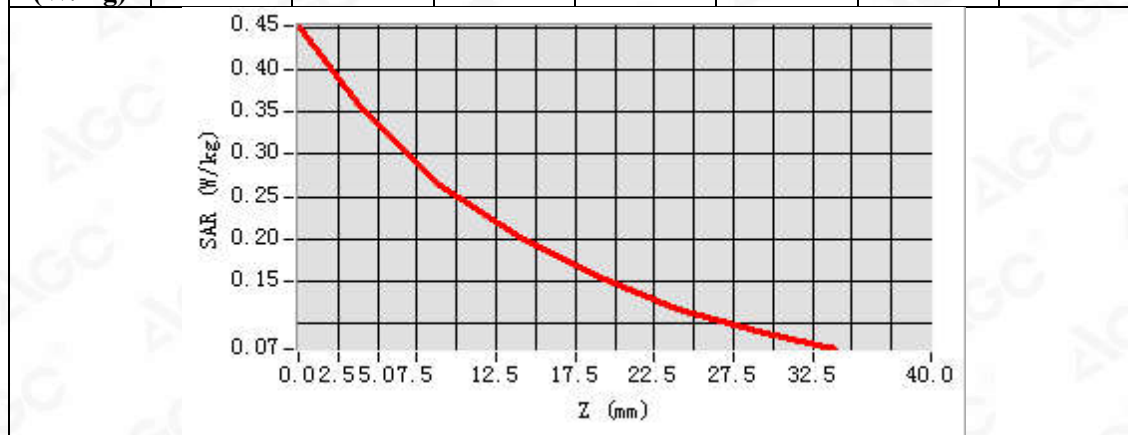

Any report having not been signed by authorized approver, or having been altered without authorization, or having not been stamped by the "Dedicated Testing/Inspection Stamp" is deemed to be invalid. Copying or excerpting portion of, or altering the content of the report is not permitted without the written authorization of AGC. The test results presented in the report apply only to the tested sample. Any objections to report issued by AGC should be submitted to AGC within 15 days after the issuance of the test report. Further enquiry of validity or verification of the test report should be addressed to AGC by agc@agc-cert.com.



Test Laboratory: AGC Lab
LTE Band 5 Mid-Body-Back (1 RB#0)
DUT: Smart phone; Type: K58

Date: Jan. 24, 2022

Communication System: LTE; Communication System Band: LTE Band 5; Duty Cycle:1:1; Conv.F=5.21
Frequency:836.5 MHz; Medium parameters used: $f = 835$ MHz; $\sigma = 0.90$ mho/m; $\epsilon_r = 41.35$; $\rho = 1000$ kg/m³ ;
Phantom section: Flat Section
Ambient temperature (°C): 22.0, Liquid temperature (°C): 21.8

SATIMO Configuration:

- Probe: SSE5; Calibrated: Aug. 17, 2021; Serial No.: SN 24/20 EP336
- Sensor-Surface: 4mm (Mechanical Surface Detection)
- Phantom: ELLI39 Phantom
- Measurement SW: OpenSAR V4_02_35

Configuration/ LTE Band 5 Mid-Body-Back/Area Scan: Measurement grid: dx=8mm, dy=8mm
Configuration/ LTE Band 5 Mid-Body-Back/Zoom Scan: Measurement grid: dx=8mm,dy=8mm, dz=5mm;

Area Scan	dx=8mm dy=8mm, h= 5.00 mm
Zoom Scan	5x5x7,dx=8mm dy=8mm dz=5mm
Phantom	ELLI
Device Position	Body Back
Band	LTE Band 5
Channels	Middle
Signal	OFDM (Crest factor: 1.0)

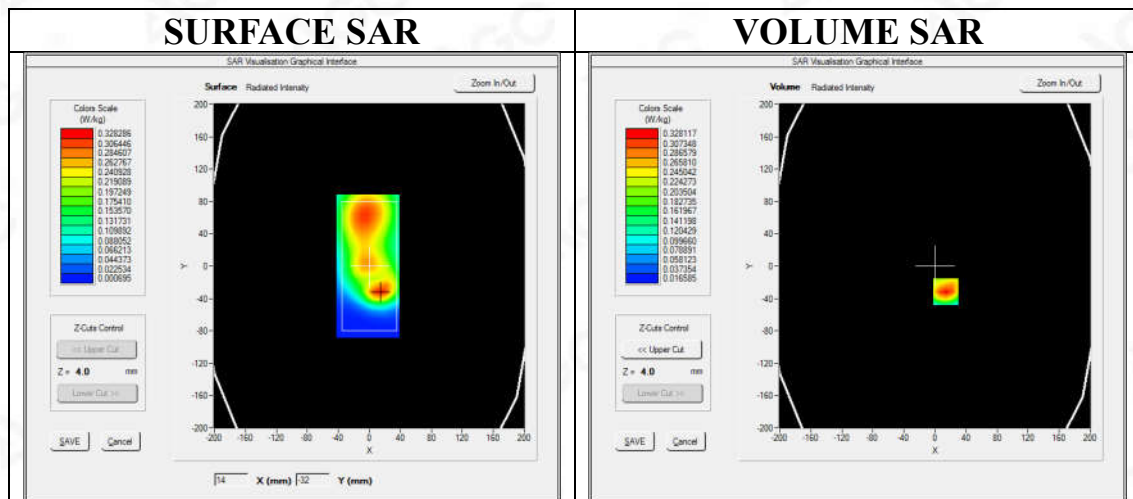

Maximum location: X=14.00, Y=-32.00

SAR Peak: 0.47 W/kg

SAR 10g (W/Kg)	0.186250
SAR 1g (W/Kg)	0.308639

Any report having not been signed by authorized approver, or having been altered without authorization, or having not been stamped by the "Dedicated Testing/Inspection Stamp" is deemed to be invalid. Copying or excerpting portion of, or altering the content of the report is not permitted without the written authorization of AGC. The test results presented in the report apply only to the tested sample. Any objections to report issued by AGC should be submitted to AGC within 15days after the issuance of the test report. Further enquiry of validity or verification of the test report should be addressed to AGC by agc@agc-cert.com.



Z (mm)	0.00	4.00	9.00	14.00	19.00	24.00	29.00
SAR (W/Kg)	0.4675	0.3281	0.2104	0.1367	0.0912	0.0621	0.0427

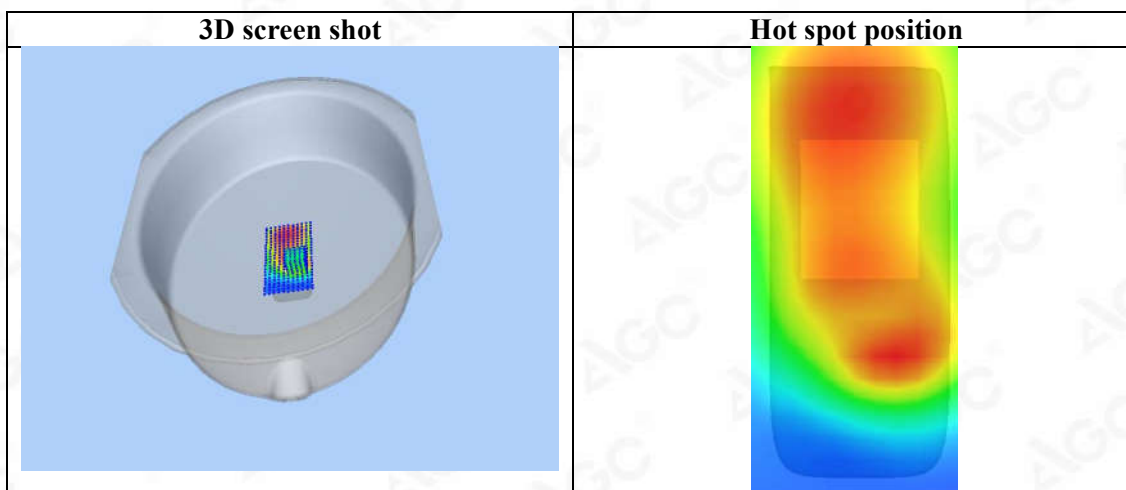
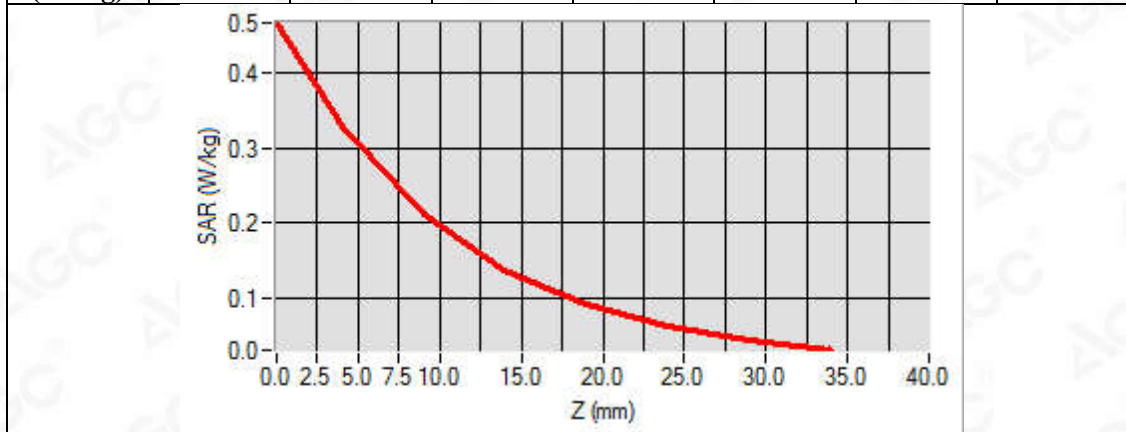

Any report having not been signed by authorized approver, or having been altered without authorization, or having not been stamped by the "Dedicated Testing/Inspection Stamp" is deemed to be invalid. Copying or excerpting portion of, or altering the content of the report is not permitted without the written authorization of AGC. The test results presented in the report apply only to the tested sample. Any objections to report issued by AGC should be submitted to AGC within 15 days after the issuance of the test report. Further enquiry of validity or verification of the test report should be addressed to AGC by agc@agc-cert.com.



Test Laboratory: AGC Lab
LTE Band 7 Mid-Touch-Left (1RB#0)
DUT: Smart phone; Type: K58

Date: Jan. 22, 2022

Communication System: LTE; Communication System Band: LTE Band 7; Duty Cycle:1:1; Conv.F=3.89
Frequency: 2535MHz; Medium parameters used: $f = 2600$ MHz; $\sigma = 1.93$ mho/m; $\epsilon_r = 38.90$; $\rho = 1000$ kg/m³ ;
Phantom section: Left Section
Ambient temperature (°C): 21.3, Liquid temperature (°C): 21.2

SATIMO Configuration:

- Probe: SSE5; Calibrated: Aug. 17, 2021; Serial No.: SN 24/20 EP336
- Sensor-Surface: 4mm (Mechanical Surface Detection)
- Phantom: SAM twin phantom
- Measurement SW: OpenSAR V4_02_35

Configuration/ LTE BAND 7 Mid-Touch-Left/Area Scan: Measurement grid: dx=8mm, y=8mm
Configuration/ LTE BAND 7 Mid-Touch-Left/Zoom Scan: Measurement grid: dx=5mm, dy=5mm, dz=5mm

Area Scan	dx=8mm dy=8mm, h= 5.00 mm
ZoomScan	7x7x7,dx=5mm dy=5mm dz=5mm
Phantom	Left head
Device Position	Cheek
Band	LTE BAND 7
Channels	Middle
Signal	OFDM (Crest factor: 1.0)

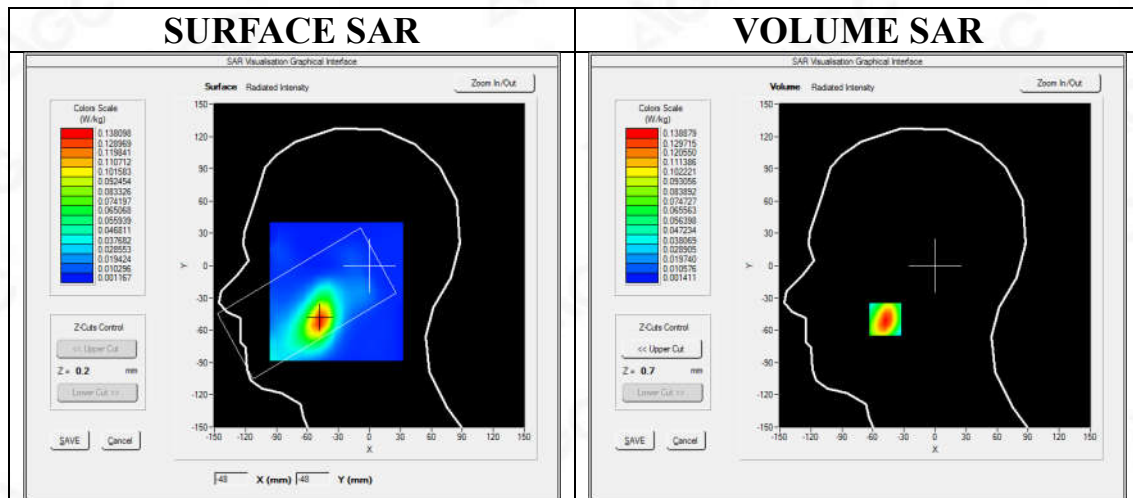

Maximum location: X=-48.00, Y=-50.00
SAR Peak: 0.22 W/kg

SAR 10g (W/Kg)	0.064119
SAR 1g (W/Kg)	0.128541

Any report having not been signed by authorized approver, or having been altered without authorization, or having not been stamped by the "Dedicated Testing/Inspection Stamp" is deemed to be invalid. Copying or excerpting portion of, or altering the content of the report is not permitted without the written authorization of AGC. The test results presented in the report apply only to the tested sample. Any objections to report issued by AGC should be submitted to AGC within 15days after the issuance of the test report. Further enquiry of validity or verification of the test report should be addressed to AGC by agc@agc-cert.com.



Z (mm)	0.00	4.00	9.00	14.00	19.00	24.00	29.00
SAR (W/Kg)	0.2235	0.1389	0.0733	0.0388	0.0201	0.0110	0.0059

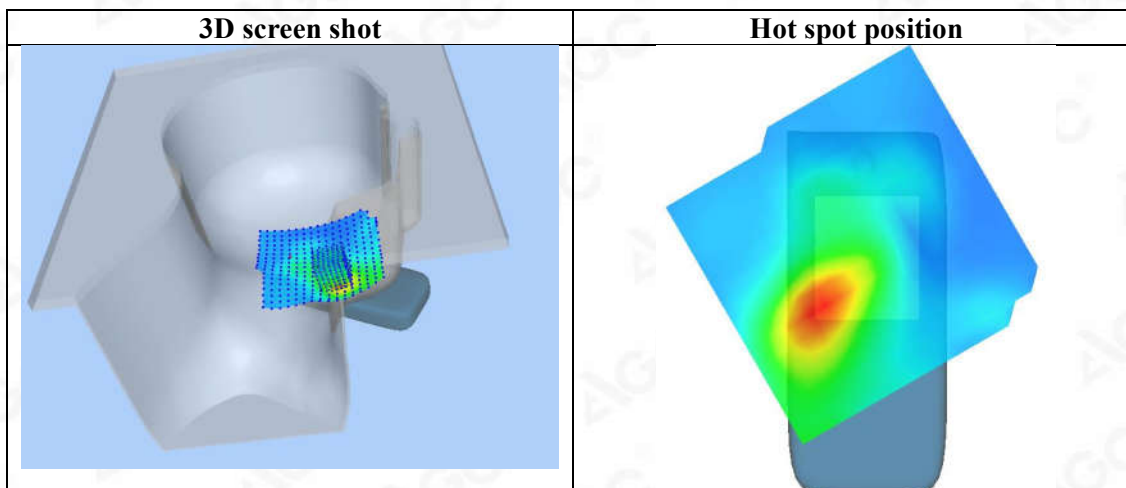
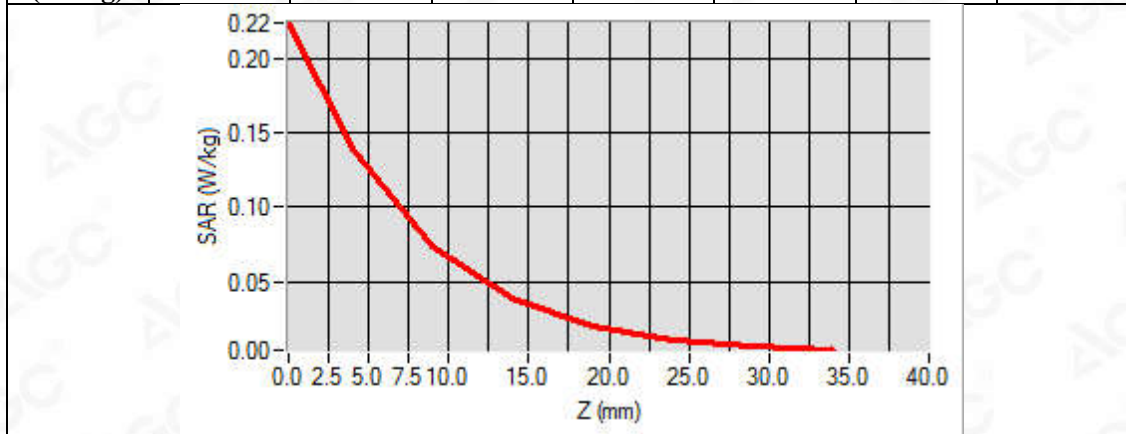

Any report having not been signed by authorized approver, or having been altered without authorization, or having not been stamped by the "Dedicated Testing/Inspection Stamp" is deemed to be invalid. Copying or excerpting portion of, or altering the content of the report is not permitted without the written authorization of AGC. The test results presented in the report apply only to the tested sample. Any objections to report issued by AGC should be submitted to AGC within 15 days after the issuance of the test report. Further enquiry of validity or verification of the test report should be addressed to AGC by agc@agc-cert.com.



Test Laboratory: AGC Lab
LTE Band 7 High-Body-Front (1RB#0)
DUT: Smart phone; Type: K58

Date: Jan. 22, 2022

Communication System: LTE; Communication System Band: LTE Band 7; Duty Cycle:1:1; Conv.F=3.89
Frequency: 2560MHz; Medium parameters used: $f = 2600$ MHz; $\sigma = 1.934$ mho/m; $\epsilon_r = 38.72$; $\rho = 1000$ kg/m³ ;
Phantom section: Flat Section
Ambient temperature (°C): 21.3, Liquid temperature (°C): 21.2

SATIMO Configuration:

- Probe: SSE5; Calibrated: Aug. 17, 2021; Serial No.: SN 24/20 EP336
- Sensor-Surface: 4mm (Mechanical Surface Detection)
- Phantom: ELLI39 Phantom
- Measurement SW: OpenSAR V4_02_35

Configuration/ LTE BAND 7 High-Body-Front /Area Scan: Measurement grid: dx=10mm, y=10mm
Configuration/ LTE BAND 7 High-Body-Front /Zoom Scan: Measurement grid: dx=5mm, dy=5mm, dz=5mm

Area Scan	dx=8mm dy=8mm, h= 5.00 mm
ZoomScan	7x7x7,dx=5mm dy=5mm dz=5mm
Phantom	ELLI
Device Position	Body Front
Band	LTE BAND 7
Channels	High
Signal	OFDM (Crest factor: 1.0)

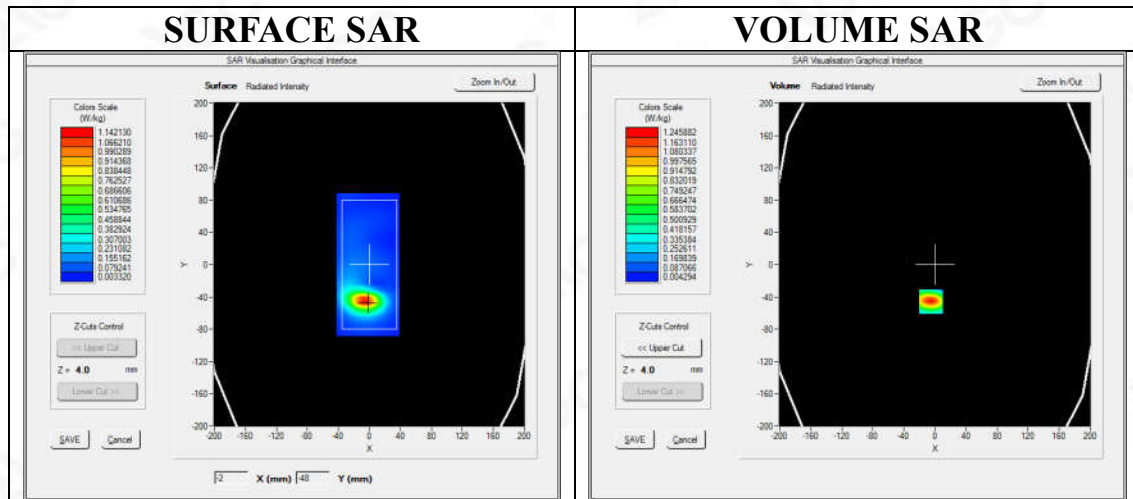

Maximum location: X=-5.00, Y=-46.00
SAR Peak: 2.11 W/kg

SAR 10g (W/Kg)	0.532079
SAR 1g (W/Kg)	1.149064

Any report having not been signed by authorized approver, or having been altered without authorization, or having not been stamped by the "Dedicated Testing/Inspection Stamp" is deemed to be invalid. Copying or excerpting portion of, or altering the content of the report is not permitted without the written authorization of AGC. The test results presented in the report apply only to the tested sample. Any objections to report issued by AGC should be submitted to AGC within 15 days after the issuance of the test report. Further enquiry of validity or verification of the test report should be addressed to AGC by agc@agc-cert.com.



Z (mm)	0.00	4.00	9.00	14.00	19.00	24.00	29.00
SAR (W/Kg)	2.0754	1.2459	0.6218	0.3065	0.1513	0.0754	0.0374

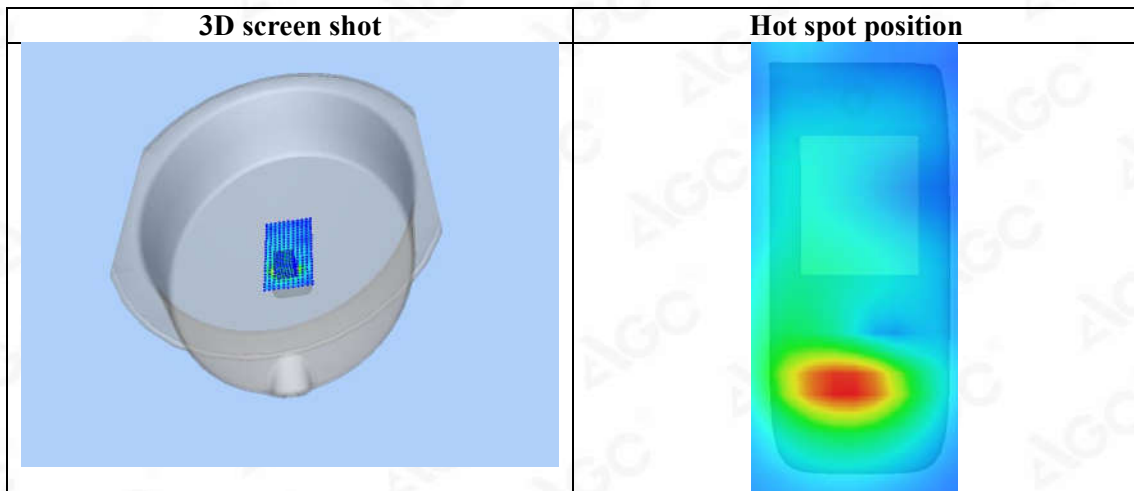
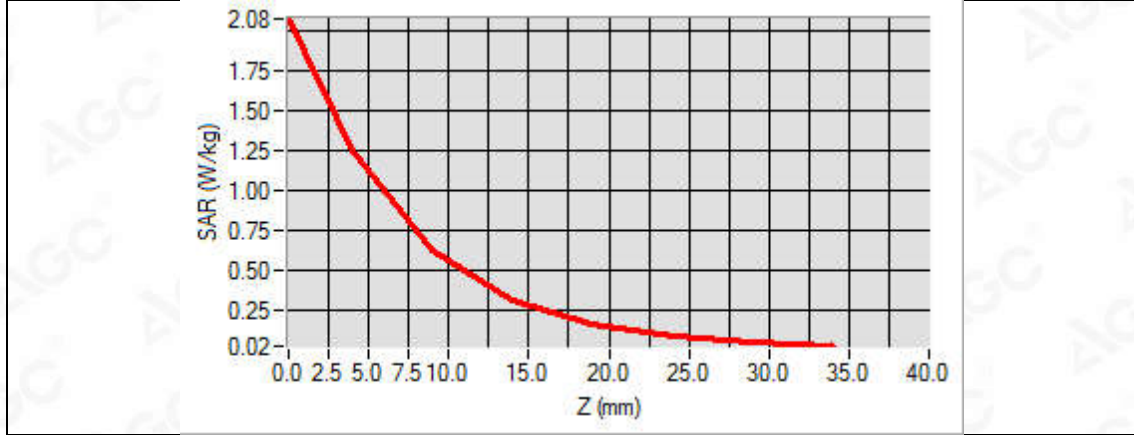

Any report having not been signed by authorized approver, or having been altered without authorization, or having not been stamped by the "Dedicated Testing/Inspection Stamp" is deemed to be invalid. Copying or excerpting portion of, or altering the content of the report is not permitted without the written authorization of AGC. The test results presented in the report apply only to the tested sample. Any objections to report issued by AGC should be submitted to AGC within 15 days after the issuance of the test report. Further enquiry of validity or verification of the test report should be addressed to AGC by agc@agc-cert.com.



Test Laboratory: AGC Lab
LTE Band 12 Mid-Touch-Right (1 RB#0)
DUT: Smart phone; Type: K58

Date: Jan. 26, 2022

Communication System: LTE; Communication System Band: LTE Band 12; Duty Cycle:1:1; Conv.F=5.35
Frequency: 707.5 MHz; Medium parameters used: $f = 750$ MHz; $\sigma = 0.88$ mho/m; $\epsilon_r = 41.89$; $\rho = 1000$ kg/m³ ;
Phantom section: Right Section
Ambient temperature (°C): 21.1, Liquid temperature (°C): 20.9

SATIMO Configuration:

- Probe: SSE5; Calibrated: Aug. 17, 2021; Serial No.: SN 24/20 EP336
- Sensor-Surface: 4mm (Mechanical Surface Detection)
- Phantom: SAM twin phantom
- Measurement SW: OpenSAR V4_02_35

Configuration/ LTE Band 12 Mid- Touch-Right /Area Scan: Measurement grid: dx=8mm, dy=8mm
Configuration/ LTE Band 12 Mid- Touch-Right /Zoom Scan: Measurement grid: dx=8mm,dy=8mm, dz=5mm;

Area Scan	dx=8mm dy=8mm, h= 5.00 mm
Zoom Scan	5x5x7,dx=8mm dy=8mm dz=5mm
Phantom	Right head
Device Position	Cheek
Band	LTE Band 12
Channels	Middle
Signal	OFDM (Crest factor: 1.0)

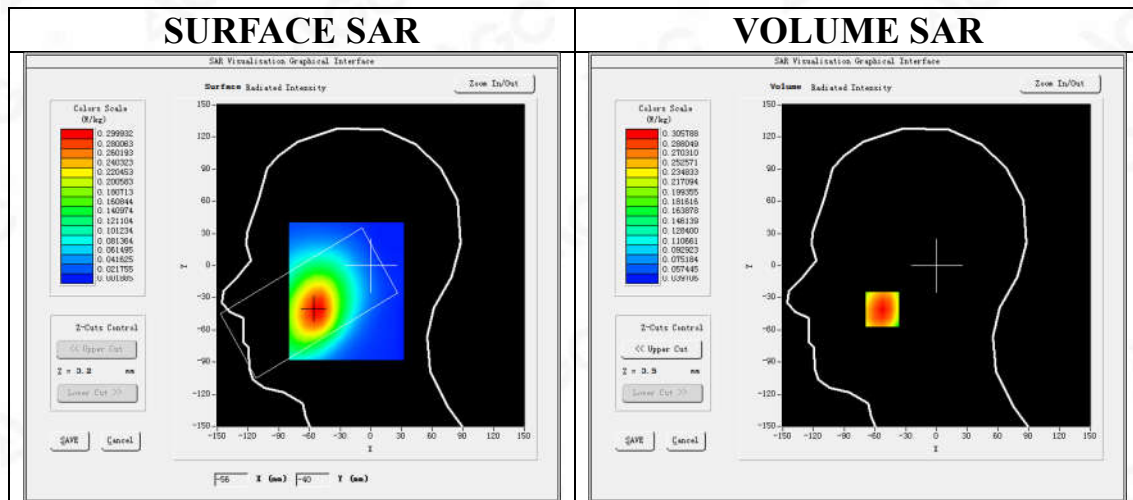

Maximum location: X=-53.00, Y=-41.00
SAR Peak: 0.37 W/kg

SAR 10g (W/Kg)	0.228036
SAR 1g (W/Kg)	0.302620

Any report having not been signed by authorized approver, or having been altered without authorization, or having not been stamped by the "Dedicated Testing/Inspection Stamp" is deemed to be invalid. Copying or excerpting portion of, or altering the content of the report is not permitted without the written authorization of AGC. The test results presented in the report apply only to the tested sample. Any objections to report issued by AGC should be submitted to AGC within 15days after the issuance of the test report. Further enquiry of validity or verification of the test report should be addressed to AGC by agc@agc-cert.com.



Z (mm)	0.00	4.00	9.00	14.00	19.00	24.00	29.00
SAR (W/Kg)	0.3644	0.3058	0.2471	0.2022	0.1615	0.1298	0.1023

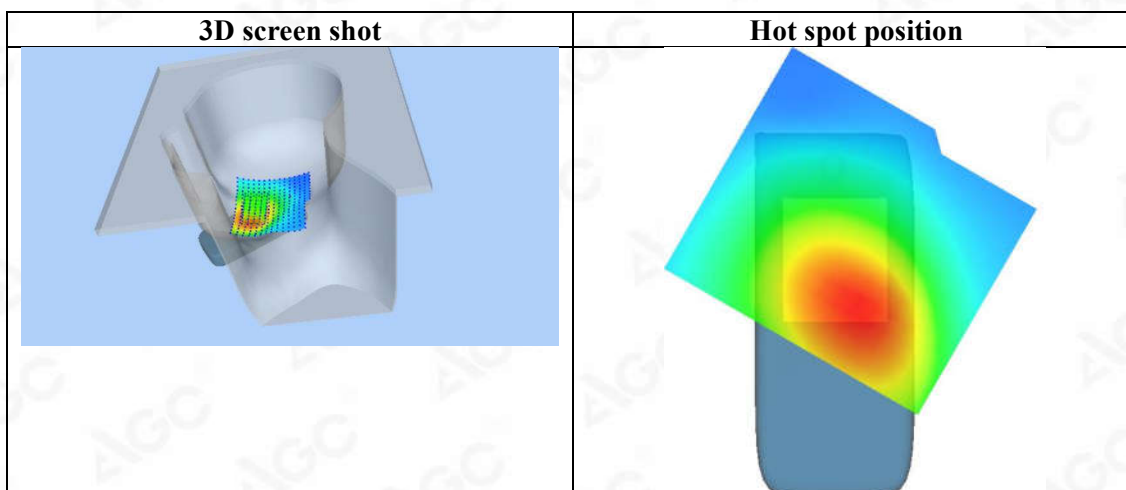
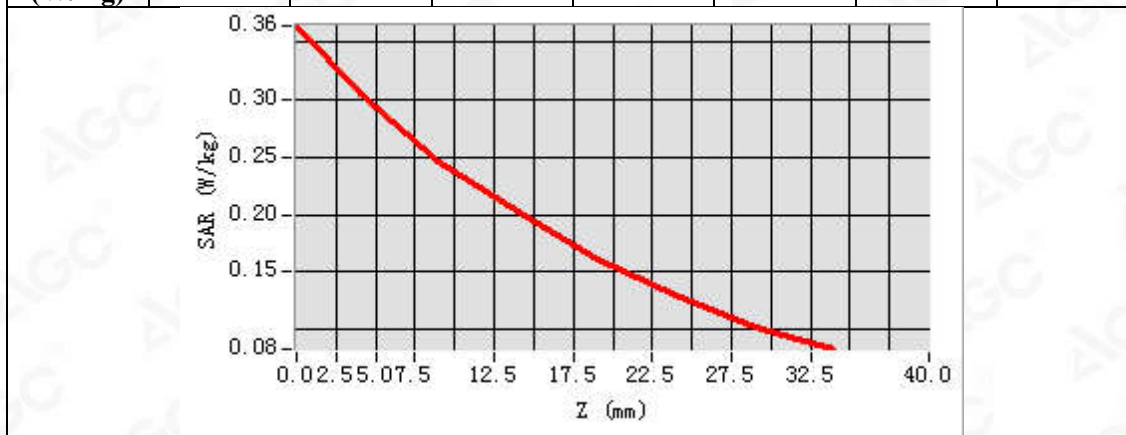

Any report having not been signed by authorized approver, or having been altered without authorization, or having not been stamped by the "Dedicated Testing/Inspection Stamp" is deemed to be invalid. Copying or excerpting portion of, or altering the content of the report is not permitted without the written authorization of AGC. The test results presented in the report apply only to the tested sample. Any objections to report issued by AGC should be submitted to AGC within 15days after the issuance of the test report. Further enquiry of validity or verification of the test report should be addressed to AGC by agc@agc-cert.com.



Test Laboratory: AGC Lab
LTE Band 12 Mid-Body-Back (1 RB#0)
DUT: Smart phone; Type: K58

Date: Jan. 26, 2022

Communication System: LTE; Communication System Band: LTE Band 12; Duty Cycle:1:1; Conv.F=5.35;
Frequency: 707.5 MHz; Medium parameters used: $f = 750$ MHz; $\sigma = 0.88$ mho/m; $\epsilon_r = 41.89$; $\rho = 1000$ kg/m³ ;
Phantom section: Flat Section
Ambient temperature (°C): 21.1, Liquid temperature (°C): 20.9

SATIMO Configuration:

- Probe: SSE5; Calibrated: Aug. 17, 2021; Serial No.: SN 24/20 EP336
- Sensor-Surface: 4mm (Mechanical Surface Detection)
- Phantom: ELLI39 Phantom
- Measurement SW: OpenSAR V4_02_35

Configuration/ LTE Band 12 Mid-Body-Back/Area Scan: Measurement grid: dx=8mm, dy=8mm
Configuration/ LTE Band 12 Mid-Body-Back/Zoom Scan: Measurement grid: dx=8mm, dy=8mm, dz=5mm;

Area Scan	dx=8mm dy=8mm, h= 5.00 mm
Zoom Scan	5x5x7,dx=8mm dy=8mm dz=5mm
Phantom	ELLI
Device Position	Body Back
Band	LTE Band 12
Channels	Middle
Signal	OFDM (Crest factor: 1.0)

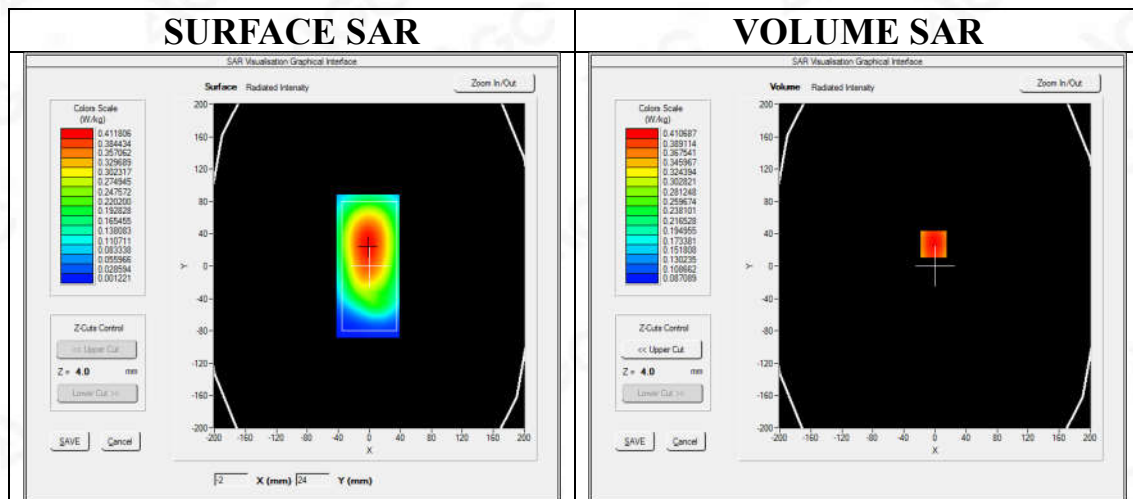

Maximum location: X=-2.00, Y=27.00
SAR Peak: 0.48 W/kg

SAR 10g (W/Kg)	0.332921
SAR 1g (W/Kg)	0.424049

Any report having not been signed by authorized approver, or having been altered without authorization, or having not been stamped by the "Dedicated Testing/Inspection Stamp" is deemed to be invalid. Copying or excerpting portion of, or altering the content of the report is not permitted without the written authorization of AGC. The test results presented in the report apply only to the tested sample. Any objections to report issued by AGC should be submitted to AGC within 15days after the issuance of the test report. Further enquiry of validity or verification of the test report should be addressed to AGC by agc@agc-cert.com.



Z (mm)	0.00	4.00	9.00	14.00	19.00	24.00	29.00
SAR (W/Kg)	0.4794	0.4107	0.3384	0.2771	0.2253	0.1805	0.1427

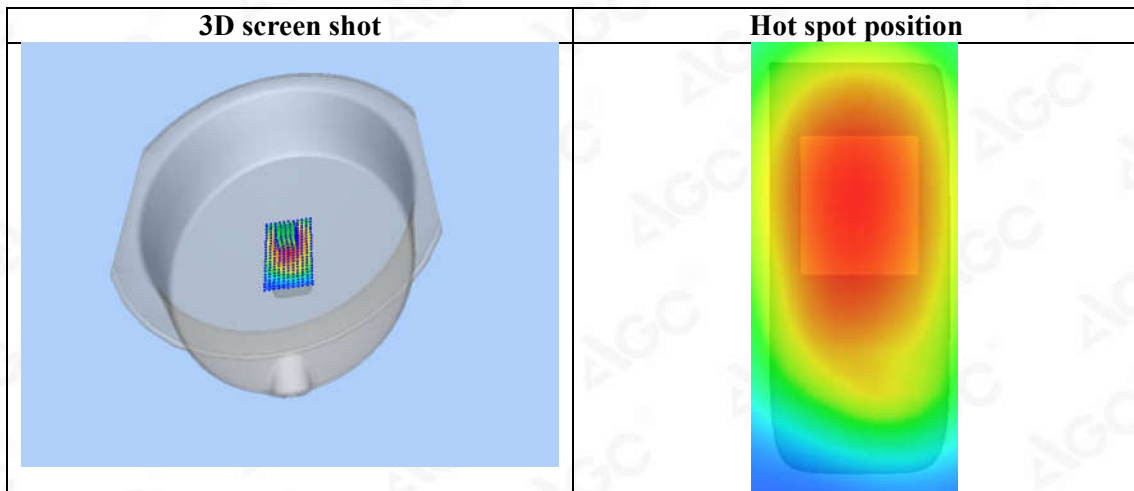
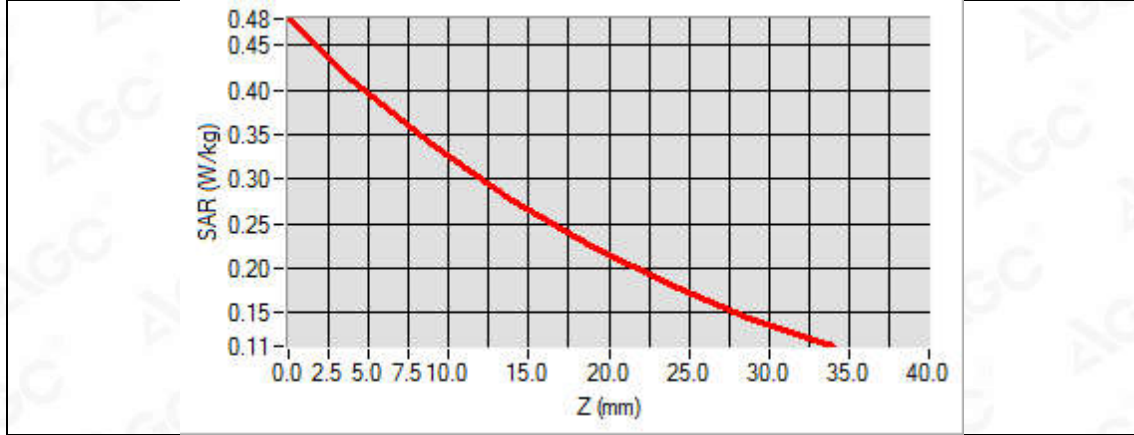

Any report having not been signed by authorized approver, or having been altered without authorization, or having not been stamped by the "Dedicated Testing/Inspection Stamp" is deemed to be invalid. Copying or excerpting portion of, or altering the content of the report is not permitted without the written authorization of AGC. The test results presented in the report apply only to the tested sample. Any objections to report issued by AGC should be submitted to AGC within 15days after the issuance of the test report. Further enquiry of validity or verification of the test report should be addressed to AGC by agc@agc-cert.com.



Test Laboratory: AGC Lab
LTE Band 17 Mid-Touch-Right (1 RB#0)
DUT: Smart phone; Type: K58

Date: Jan. 26, 2022

Communication System: LTE; Communication System Band: LTE Band 17; Duty Cycle:1:1; Conv.F=5.35
Frequency: 710 MHz; Medium parameters used: $f = 750$ MHz; $\sigma=0.89$ mho/m; $\epsilon_r = 41.67$; $\rho = 1000$ kg/m³ ;
Phantom section: Right Section
Ambient temperature (°C): 21.1, Liquid temperature (°C): 20.9

SATIMO Configuration:

- Probe: SSE5; Calibrated: Aug. 17, 2021; Serial No.: SN 24/20 EP336
- Sensor-Surface: 4mm (Mechanical Surface Detection)
- Phantom: SAM twin phantom
- Measurement SW: OpenSAR V4_02_35

Configuration/ LTE Band 17 Mid- Touch-Right /Area Scan: Measurement grid: dx=8mm, dy=8mm
Configuration/ LTE Band 17 Mid- Touch-Right /Zoom Scan: Measurement grid: dx=8mm,dy=8mm, dz=5mm;

Area Scan	dx=8mm dy=8mm, h= 5.00 mm
Zoom Scan	5x5x7,dx=8mm dy=8mm dz=5mm
Phantom	Right head
Device Position	Cheek
Band	LTE Band 17
Channels	Middle
Signal	OFDM (Crest factor: 1.0)

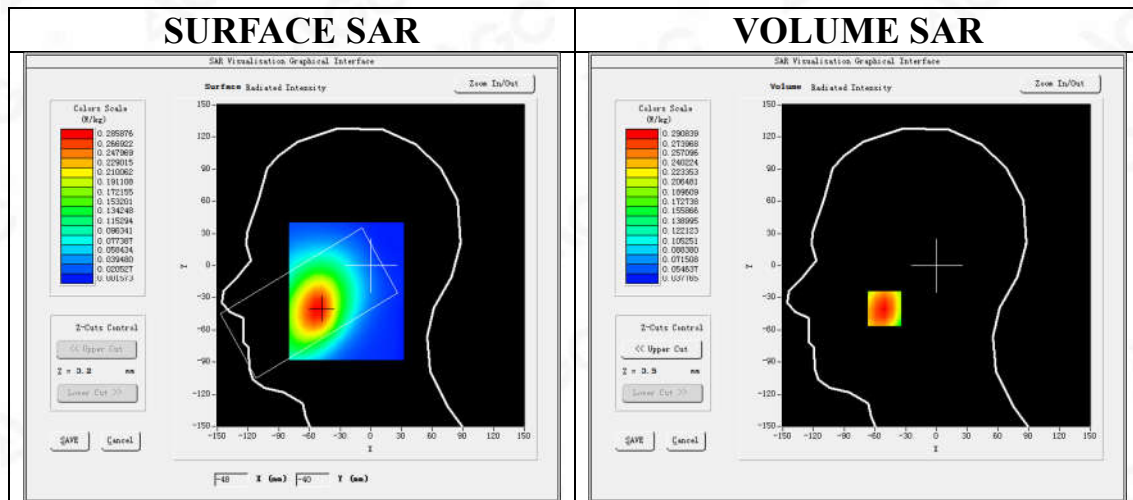

Maximum location: X=-51.00, Y=-40.00
SAR Peak: 0.36 W/kg

SAR 10g (W/Kg)	0.216516
SAR 1g (W/Kg)	0.288732

Any report having not been signed by authorized approver, or having been altered without authorization, or having not been stamped by the "Dedicated Testing/Inspection Stamp" is deemed to be invalid. Copying or excerpting portion of, or altering the content of the report is not permitted without the written authorization of AGC. The test results presented in the report apply only to the tested sample. Any objections to report issued by AGC should be submitted to AGC within 15days after the issuance of the test report. Further enquiry of validity or verification of the test report should be addressed to AGC by agc@agc-cert.com.



Z (mm)	0.00	4.00	9.00	14.00	19.00	24.00	29.00
SAR (W/Kg)	0.3547	0.2908	0.2316	0.1897	0.1538	0.1210	0.0976

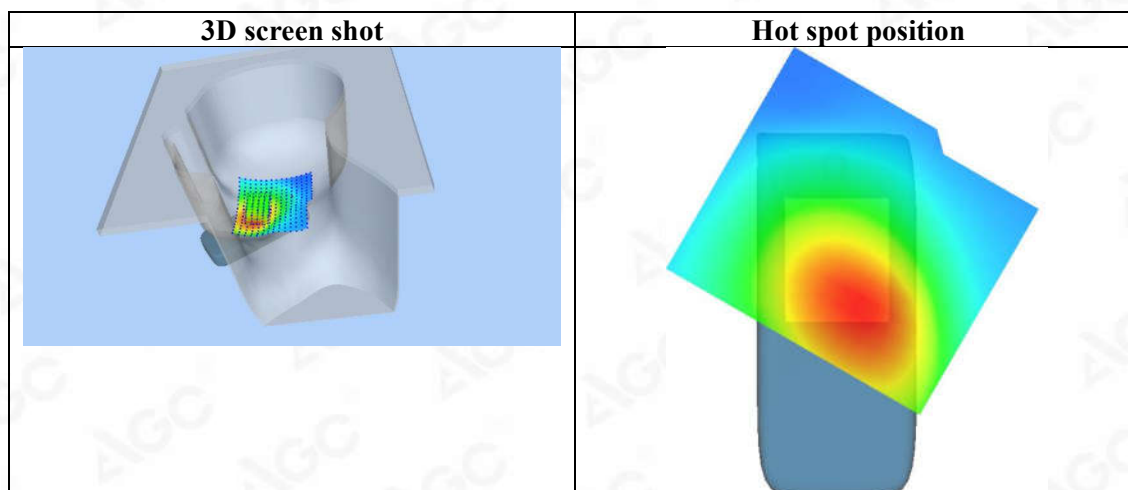
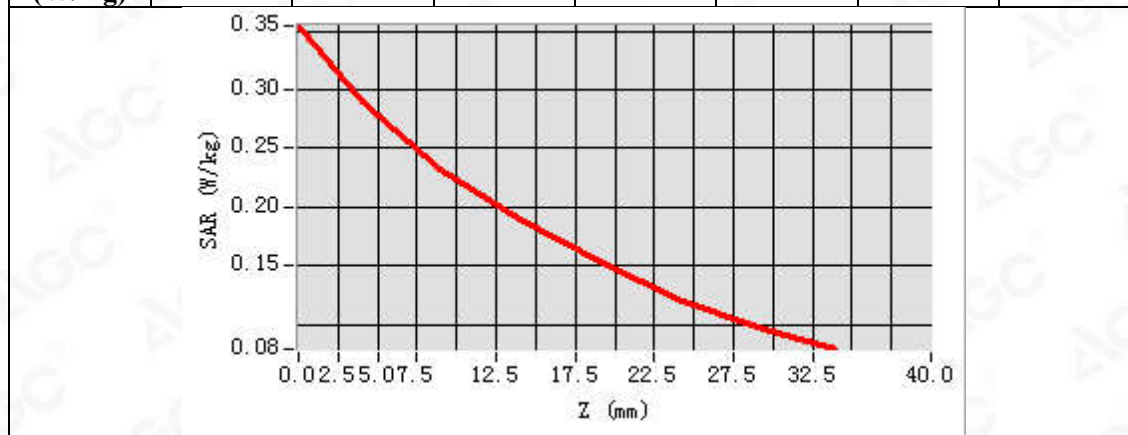

Any report having not been signed by authorized approver, or having been altered without authorization, or having not been stamped by the "Dedicated Testing/Inspection Stamp" is deemed to be invalid. Copying or excerpting portion of, or altering the content of the report is not permitted without the written authorization of AGC. The test results presented in the report apply only to the tested sample. Any objections to report issued by AGC should be submitted to AGC within 15days after the issuance of the test report. Further enquiry of validity or verification of the test report should be addressed to AGC by agc@agc-cert.com.



Test Laboratory: AGC Lab
LTE Band 17 Mid-Body-Back (1 RB#0)
DUT: Smart phone; Type: K58

Date: Jan. 26, 2022

Communication System: LTE; Communication System Band: LTE Band 17; Duty Cycle:1:1; Conv.F=5.35;
Frequency: 710 MHz; Medium parameters used: $f = 750$ MHz; $\sigma=0.89$ mho/m; $\epsilon_r = 41.67$; $\rho= 1000$ kg/m³ ;
Phantom section: Flat Section
Ambient temperature (°C): 21.1, Liquid temperature (°C): 20.9

SATIMO Configuration:

- Probe: SSE5; Calibrated: Aug. 17, 2021; Serial No.: SN 24/20 EP336
- Sensor-Surface: 4mm (Mechanical Surface Detection)
- Phantom: ELLI39 Phantom
- Measurement SW: OpenSAR V4_02_35

Configuration/ LTE Band 17 Mid-Body-Back/Area Scan: Measurement grid: dx=8mm, dy=8mm
Configuration/ LTE Band 17 Mid-Body-Back/Zoom Scan: Measurement grid: dx=8mm,dy=8mm, dz=5mm;

Area Scan	dx=8mm dy=8mm, h= 5.00 mm
Zoom Scan	5x5x7,dx=8mm dy=8mm dz=5mm
Phantom	ELLI
Device Position	Body Back
Band	LTE Band 17
Channels	Middle
Signal	OFDM (Crest factor: 1.0)

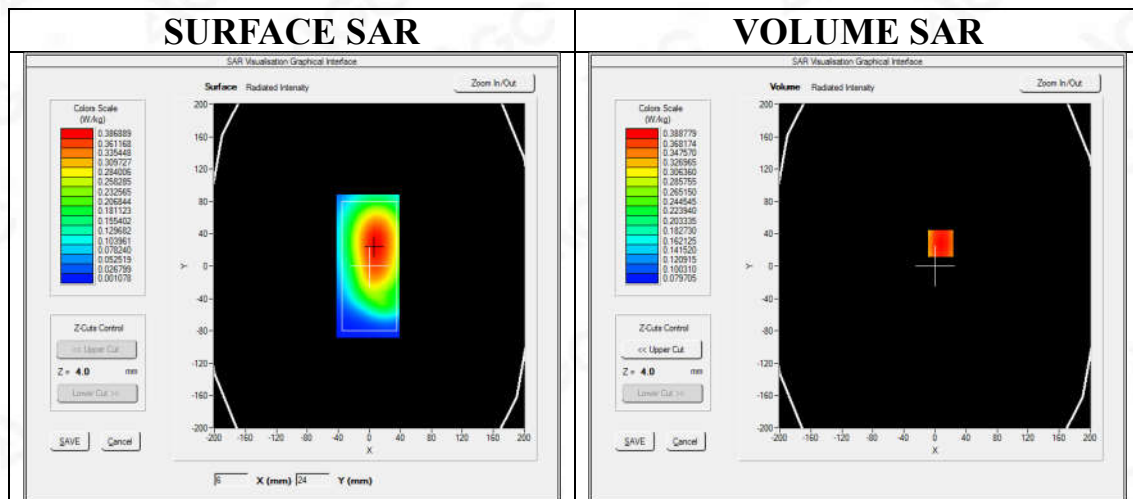

Maximum location: X=7.00, Y=28.00

SAR Peak: 0.46 W/kg

SAR 10g (W/Kg)	0.314014
SAR 1g (W/Kg)	0.400887

Any report having not been signed by authorized approver, or having been altered without authorization, or having not been stamped by the "Dedicated Testing/Inspection Stamp" is deemed to be invalid. Copying or excerpting portion of, or altering the content of the report is not permitted without the written authorization of AGC. The test results presented in the report apply only to the tested sample. Any objections to report issued by AGC should be submitted to AGC within 15days after the issuance of the test report. Further enquiry of validity or verification of the test report should be addressed to AGC by agc@agc-cert.com.



Z (mm)	0.00	4.00	9.00	14.00	19.00	24.00	29.00
SAR (W/Kg)	0.4585	0.3888	0.3182	0.2611	0.2122	0.1700	0.1346

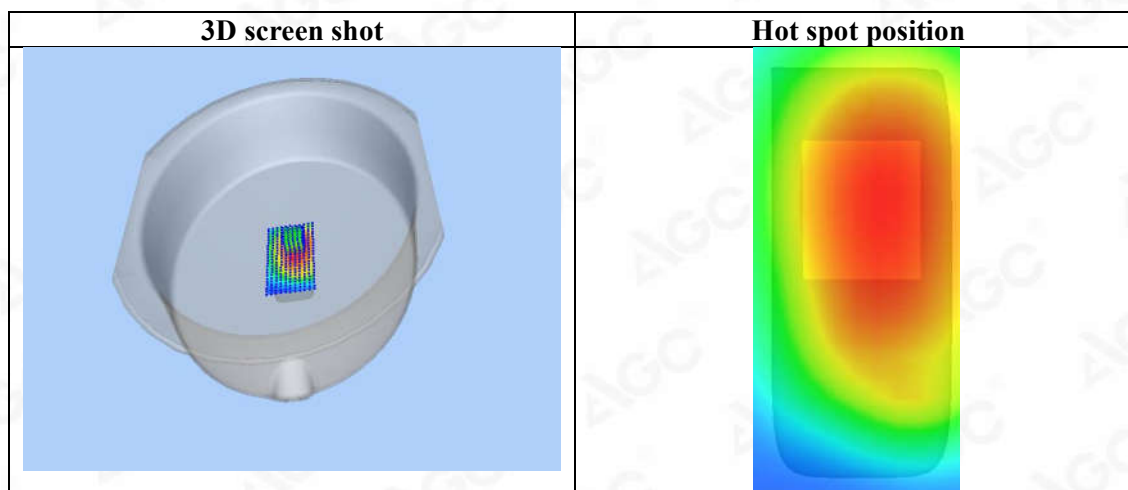
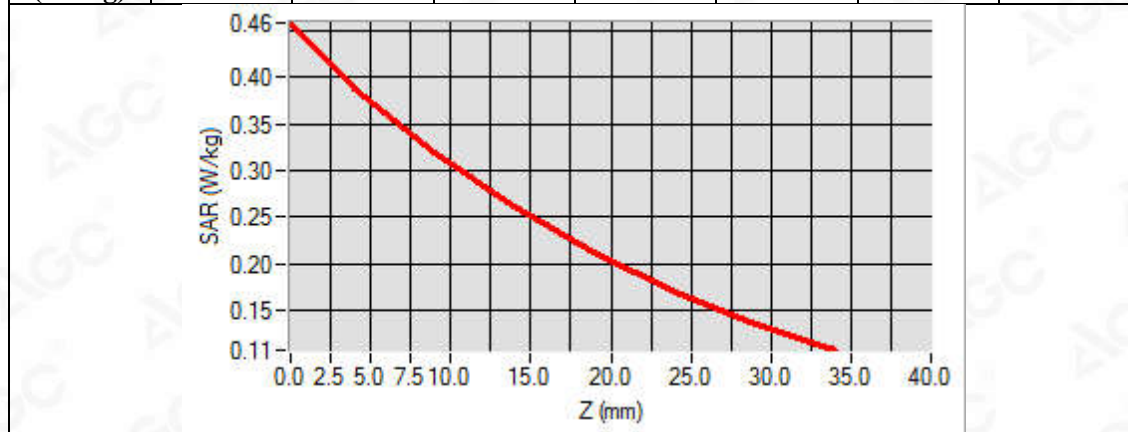

Any report having not been signed by authorized approver, or having been altered without authorization, or having not been stamped by the "Dedicated Testing/Inspection Stamp" is deemed to be invalid. Copying or excerpting portion of, or altering the content of the report is not permitted without the written authorization of AGC. The test results presented in the report apply only to the tested sample. Any objections to report issued by AGC should be submitted to AGC within 15 days after the issuance of the test report. Further enquiry of validity or verification of the test report should be addressed to AGC by agc@agc-cert.com.



WIFI MODE

Test Laboratory: AGC Lab
802.11b Mid-Touch-Left
DUT: Smart phone; Type: K58

Date: Jan. 22, 2022

Communication System: Wi-Fi; Communication System Band: 802.11b; Duty Cycle: 1:1; Conv.F=4.02;
Frequency: 2437 MHz; Medium parameters used: $f = 2450$ MHz; $\sigma = 1.78$ mho/m; $\epsilon_r = 39.16$ $\rho = 1000$ kg/m³ ;
Phantom section: Left Section
Ambient temperature (°C):21.3, Liquid temperature (°C): 21.2

SATIMO Configuration:

- Probe: SSE5; Calibrated: Aug. 17, 2021; Serial No.: SN 24/20 EP336
- Sensor-Surface: 4mm (Mechanical Surface Detection)
- Phantom: SAM twin phantom
- Measurement SW: OpenSAR V4_02_35

Configuration/802.11b Mid- Touch-Left/Area Scan: Measurement grid: dx=8mm, dy=8mm
Configuration/802.11b Mid- Touch-Left/Zoom Scan: Measurement grid: dx=5mm,dy=5mm, dz=5mm

Area Scan	dx=8mm dy=8mm, h= 5.00 mm
ZoomScan	7x7x7,dx=5mm dy=5mm dz=5mm
Phantom	Left head
Device Position	Cheek
Band	2450MHz
Channels	Middle
Signal	Crest factor: 1.0

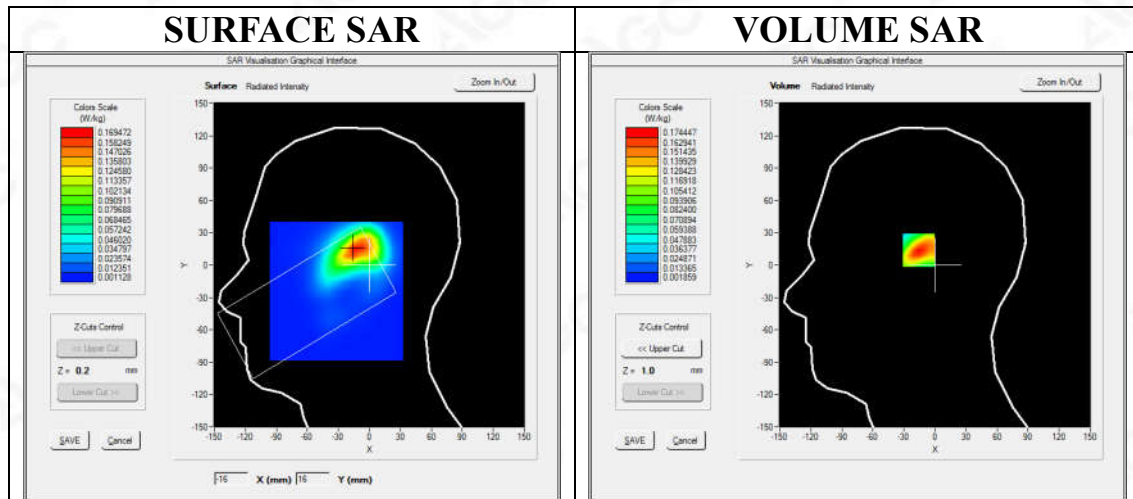

Maximum location: X=-14.00, Y=15.00

SAR Peak: 0.29 W/kg

SAR 10g (W/Kg)	0.081940
SAR 1g (W/Kg)	0.163874

Any report having not been signed by authorized approver, or having been altered without authorization, or having not been stamped by the "Dedicated Testing/Inspection Stamp" is deemed to be invalid. Copying or excerpting portion of, or altering the content of the report is not permitted without the written authorization of AGC. The test results presented in the report apply only to the tested sample. Any objections to report issued by AGC should be submitted to AGC within 15days after the issuance of the test report. Further enquiry of validity or verification of the test report should be addressed to AGC by agc@agc-cert.com.



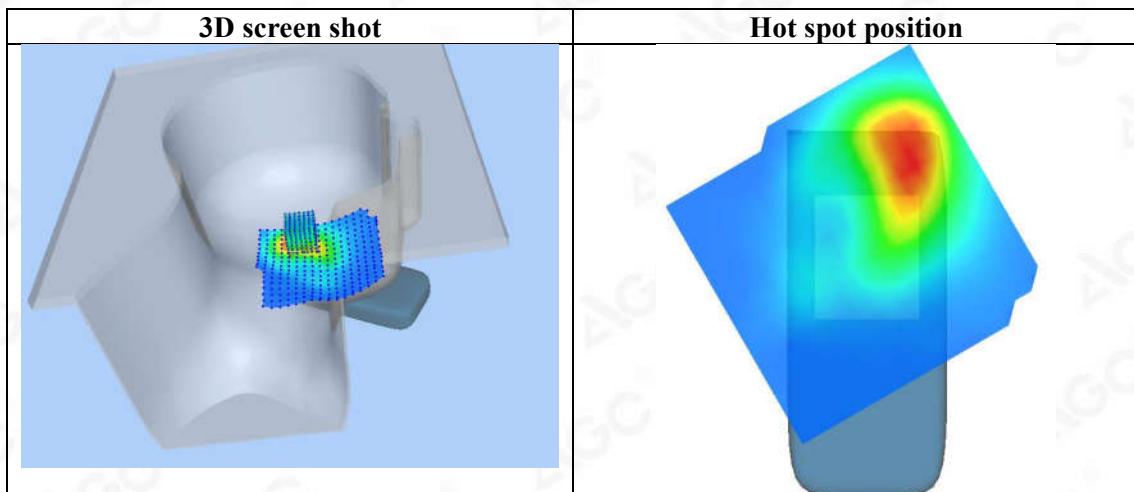
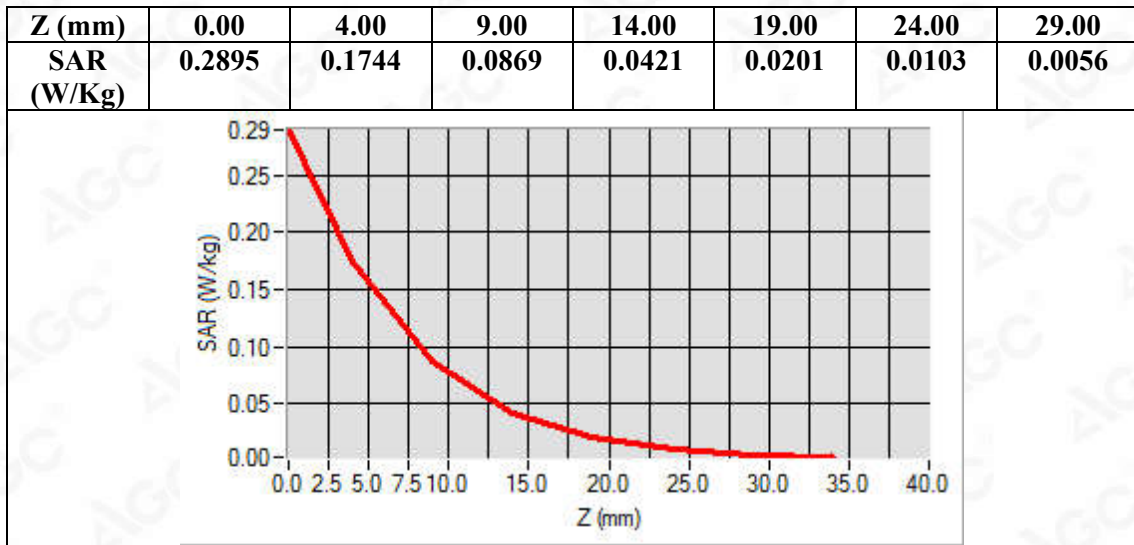

Any report having not been signed by authorized approver, or having been altered without authorization, or having not been stamped by the "Dedicated Testing/Inspection Stamp" is deemed to be invalid. Copying or excerpting portion of, or altering the content of the report is not permitted without the written authorization of AGC. The test results presented in the report apply only to the tested sample. Any objections to report issued by AGC should be submitted to AGC within 15 days after the issuance of the test report. Further enquiry of validity or verification of the test report should be addressed to AGC by agc@agc-cert.com.



Test Laboratory: AGC Lab
802.11b Mid-Body-Worn- Front
DUT: Smart phone; Type: K58

Date: Jan. 22, 2022

Communication System: Wi-Fi; Communication System Band: 802.11b; Duty Cycle: 1:1; Conv.F=4.02;
Frequency: 2437 MHz; Medium parameters used: $f = 2450$ MHz; $\sigma = 1.78$ mho/m; $\epsilon_r = 39.16$; $\rho = 1000$ kg/m³ ;
Phantom section: Flat Section
Ambient temperature (°C):21.3, Liquid temperature (°C): 21.2

SATIMO Configuration:

- Probe: SSE5; Calibrated: Aug. 17, 2021; Serial No.: SN 24/20 EP336
- Sensor-Surface: 4mm (Mechanical Surface Detection)
- Phantom: ELLI39 Phantom
- Measurement SW: OpenSAR V4_02_35

Configuration/802.11b Mid- Body- Front /Area Scan: Measurement grid: dx=8mm, dy=8mm
Configuration/802.11b Mid- Body- Front /Zoom Scan: Measurement grid: dx=5mm,dy=5mm, dz=5mm;

Area Scan	dx=8mm dy=8mm, h= 5.00 mm
ZoomScan	7x7x7,dx=5mm dy=5mm dz=5mm
Phantom	ELLI
Device Position	Body Front
Band	2450MHz
Channels	Middle
Signal	Crest factor: 1.0

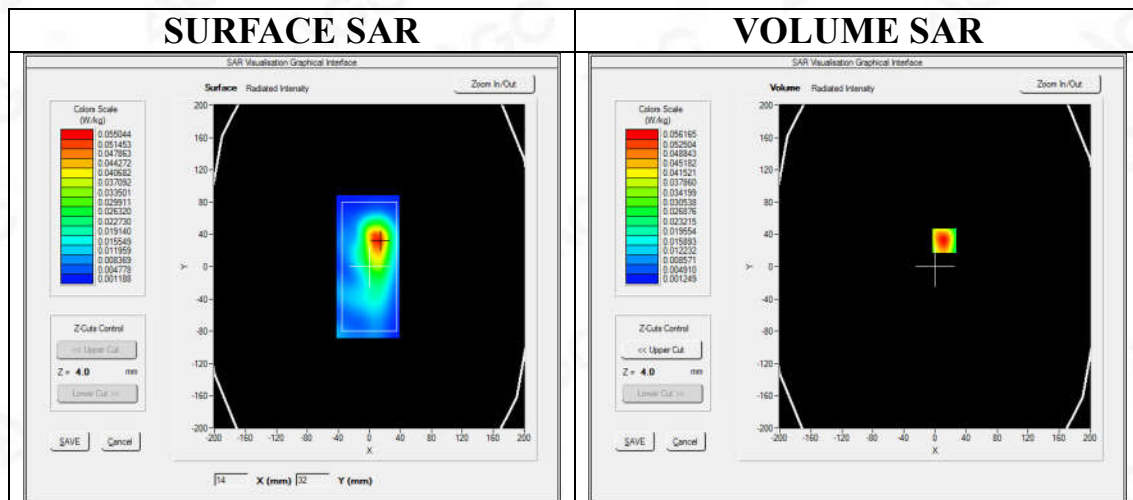

Maximum location: X=12.00, Y=32.00
SAR Peak: 0.09 W/kg

SAR 10g (W/Kg)	0.048223
SAR 1g (W/Kg)	0.083205

Any report having not been signed by authorized approver, or having been altered without authorization, or having not been stamped by the "Dedicated Testing/Inspection Stamp" is deemed to be invalid. Copying or excerpting portion of, or altering the content of the report is not permitted without the written authorization of AGC. The test results presented in the report apply only to the tested sample. Any objections to report issued by AGC should be submitted to AGC within 15days after the issuance of the test report. Further enquiry of validity or verification of the test report should be addressed to AGC by agc@agc-cert.com.



Z (mm)	0.00	4.00	9.00	14.00	19.00	24.00	29.00
SAR (W/Kg)	0.0898	0.0562	0.0301	0.0161	0.0085	0.0048	0.0025

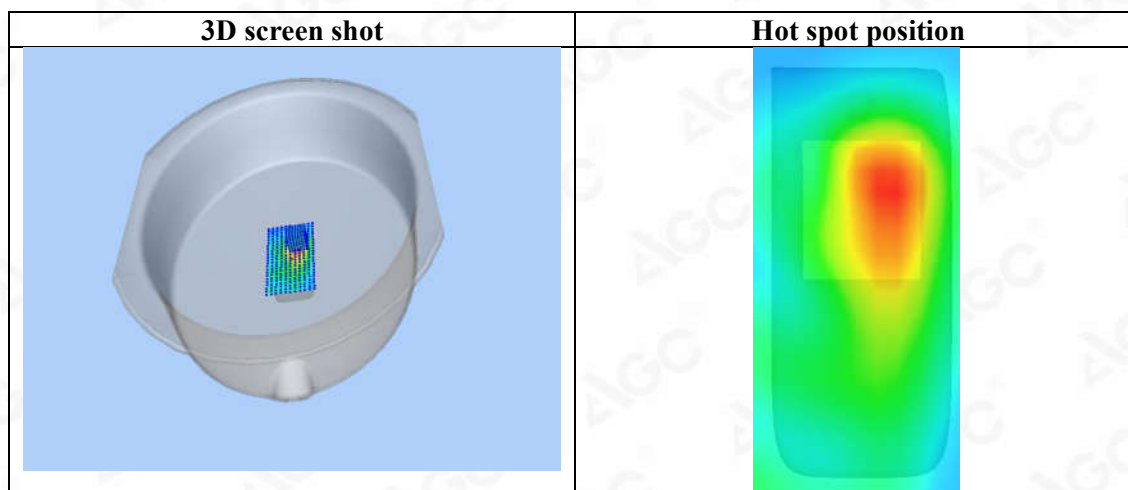
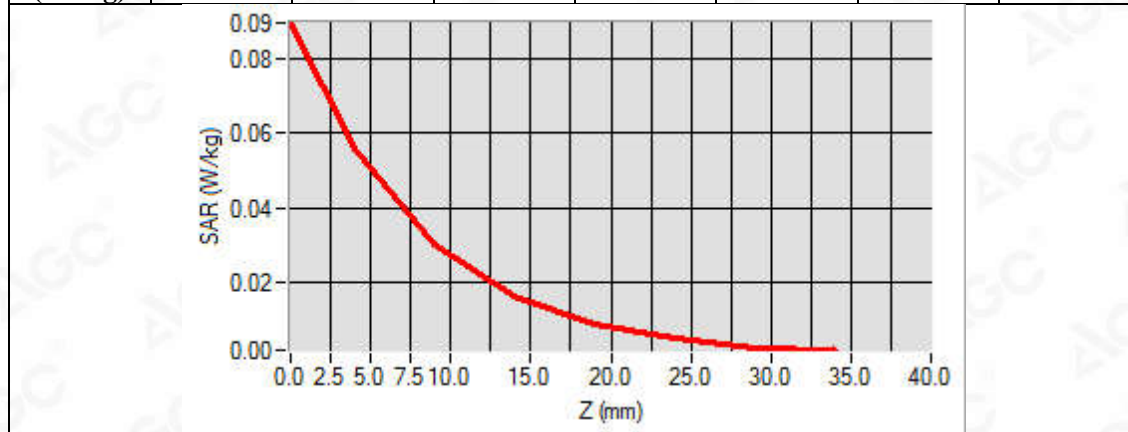

Any report having not been signed by authorized approver, or having been altered without authorization, or having not been stamped by the "Dedicated Testing/Inspection Stamp" is deemed to be invalid. Copying or excerpting portion of, or altering the content of the report is not permitted without the written authorization of AGC. The test results presented in the report apply only to the tested sample. Any objections to report issued by AGC should be submitted to AGC within 15 days after the issuance of the test report. Further enquiry of validity or verification of the test report should be addressed to AGC by agc@agc-cert.com.



Bluetooth

Test Laboratory: AGC Lab
Bluetooth Mid-Touch-Left
DUT: Smart phone; **Type:** K58

Date: Jan. 22, 2022

Communication System: BT; Communication System Band: Bluetooth; Duty Cycle: 77%; Conv.F=4.02;
Frequency: 2441 MHz; Medium parameters used: $f = 2450$ MHz; $\sigma = 1.78$ mho/m; $\epsilon_r = 39.16$ $\rho = 1000$ kg/m³ ;
Phantom section: Left Section
Ambient temperature (°C):21.3, Liquid temperature (°C): 21.2

SATIMO Configuration:

- Probe: SSE5; Calibrated: Aug. 17, 2021; Serial No.: SN 24/20 EP336
- Sensor-Surface: 4mm (Mechanical Surface Detection)
- Phantom: SAM twin phantom
- Measurement SW: OpenSAR V4_02_35

Configuration/Bluetooth Mid- Touch-Left/Area Scan: Measurement grid: dx=8mm, dy=8mm
Configuration/Bluetooth Mid- Touch-Left/Zoom Scan: Measurement grid: dx=5mm,dy=5mm, dz=5mm

Area Scan	dx=8mm dy=8mm, h= 5.00 mm
ZoomScan	7x7x7,dx=5mm dy=5mm dz=5mm
Phantom	Left head
Device Position	Cheek
Band	2450MHz
Channels	Middle
Signal	Crest factor: 1.30

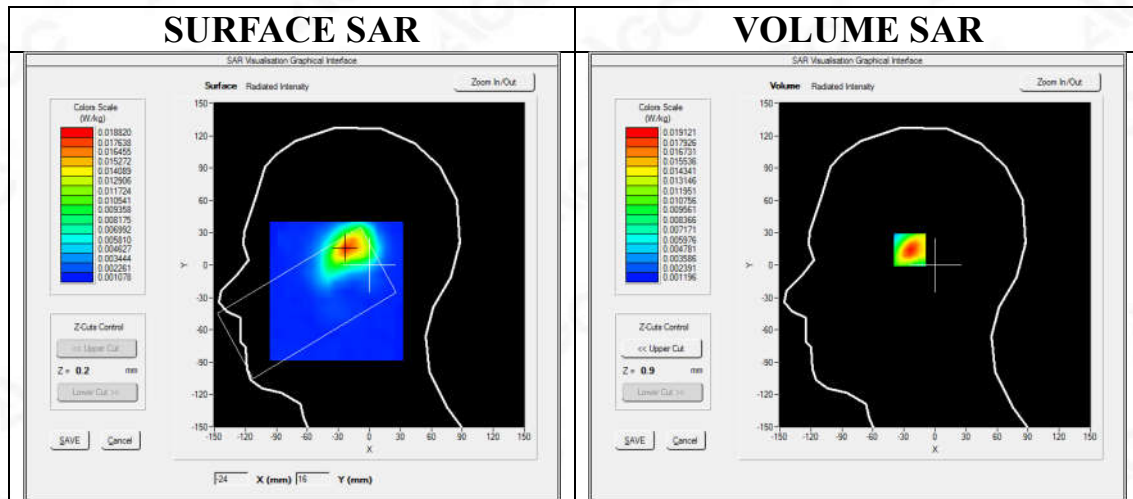

Maximum location: X=-23.00, Y=16.00

SAR Peak: 0.03 W/kg

SAR 10g (W/Kg)	0.009170
SAR 1g (W/Kg)	0.017597

Any report having not been signed by authorized approver, or having been altered without authorization, or having not been stamped by the "Dedicated Testing/Inspection Stamp" is deemed to be invalid. Copying or excerpting portion of, or altering the content of the report is not permitted without the written authorization of AGC. The test results presented in the report apply only to the tested sample. Any objections to report issued by AGC should be submitted to AGC within 15days after the issuance of the test report. Further enquiry of validity or verification of the test report should be addressed to AGC by agc@agc-cert.com.



Z (mm)	0.00	4.00	9.00	14.00	19.00	24.00	29.00
SAR (W/Kg)	0.0310	0.0191	0.0102	0.0057	0.0034	0.0023	0.0017

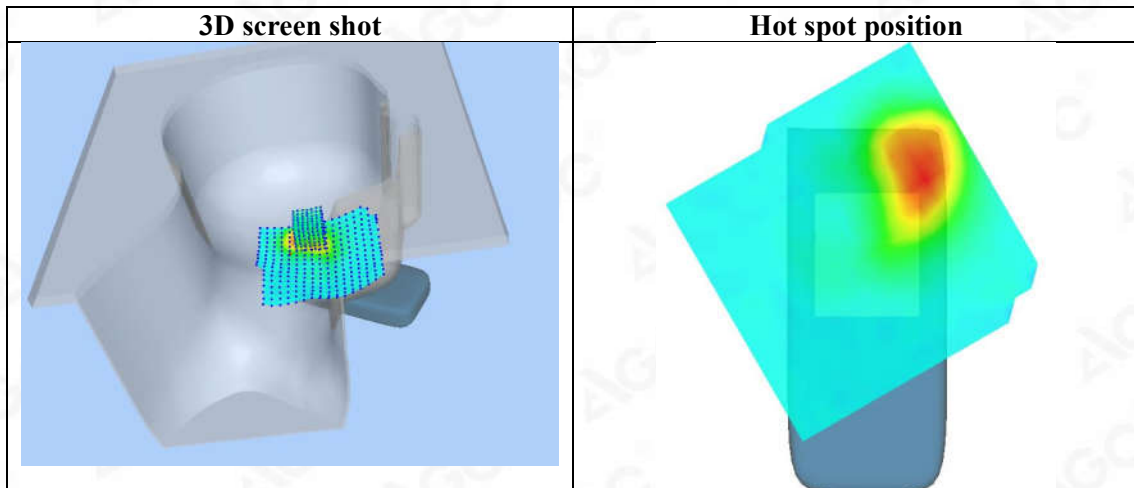
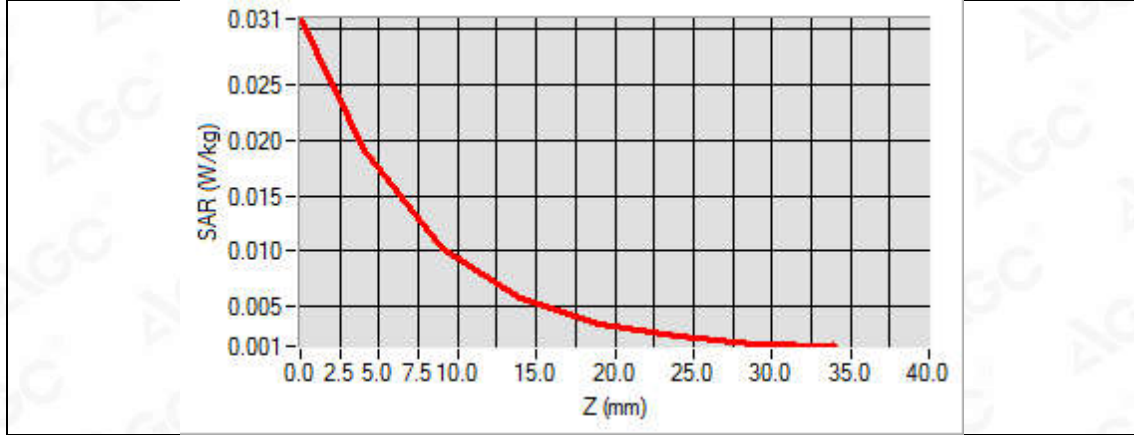

Any report having not been signed by authorized approver, or having been altered without authorization, or having not been stamped by the "Dedicated Testing/Inspection Stamp" is deemed to be invalid. Copying or excerpting portion of, or altering the content of the report is not permitted without the written authorization of AGC. The test results presented in the report apply only to the tested sample. Any objections to report issued by AGC should be submitted to AGC within 15days after the issuance of the test report. Further enquiry of validity or verification of the test report should be addressed to AGC by agc@agc-cert.com.



Test Laboratory: AGC Lab
Bluetooth Mid-Body-Worn- Back
DUT: Smart phone; Type: K58

Date: Jan. 22, 2022

Communication System: BT; Communication System Band: Bluetooth; Duty Cycle: 77%; Conv.F=4.02;
Frequency: 2441 MHz; Medium parameters used: $f = 2450$ MHz; $\sigma = 1.78$ mho/m; $\epsilon_r = 39.16$; $\rho = 1000$ kg/m³ ;
Phantom section: Flat Section
Ambient temperature (°C):21.3, Liquid temperature (°C): 21.2

SATIMO Configuration:

- Probe: SSE5; Calibrated: Aug. 17, 2021; Serial No.: SN 24/20 EP336
- Sensor-Surface: 4mm (Mechanical Surface Detection)
- Phantom: ELLI39 Phantom
- Measurement SW: OpenSAR V4_02_35

Configuration/Bluetooth Mid- Body- Back /Area Scan: Measurement grid: dx=8mm, dy=8mm
Configuration/Bluetooth Mid- Body- Back /Zoom Scan: Measurement grid: dx=5mm,dy=5mm, dz=5mm;

Area Scan	dx=8mm dy=8mm, h= 5.00 mm
ZoomScan	7x7x7,dx=5mm dy=5mm dz=5mm
Phantom	ELLI
Device Position	Body Back
Band	2450MHz
Channels	Middle
Signal	Crest factor: 1.30

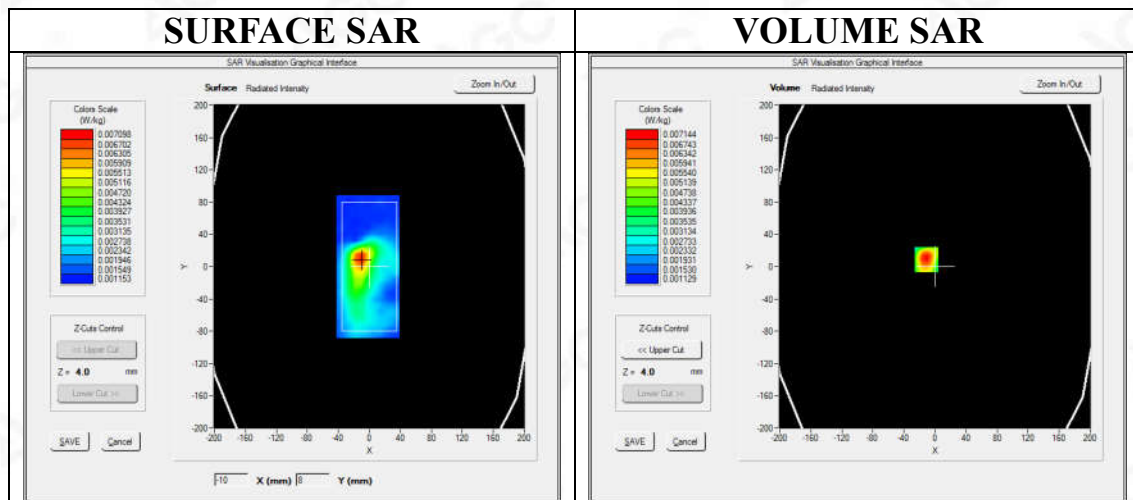

Maximum location: X=-11.00, Y=9.00
SAR Peak: 0.01 W/kg

SAR 10g (W/Kg)	0.003777
SAR 1g (W/Kg)	0.006729

Any report having not been signed by authorized approver, or having been altered without authorization, or having not been stamped by the "Dedicated Testing/Inspection Stamp" is deemed to be invalid. Copying or excerpting portion of, or altering the content of the report is not permitted without the written authorization of AGC. The test results presented in the report apply only to the tested sample. Any objections to report issued by AGC should be submitted to AGC within 15days after the issuance of the test report. Further enquiry of validity or verification of the test report should be addressed to AGC by agc@agc-cert.com.



Z (mm)	0.00	4.00	9.00	14.00	19.00	24.00	29.00
SAR (W/Kg)	0.0113	0.0071	0.0039	0.0023	0.0016	0.0013	0.0013

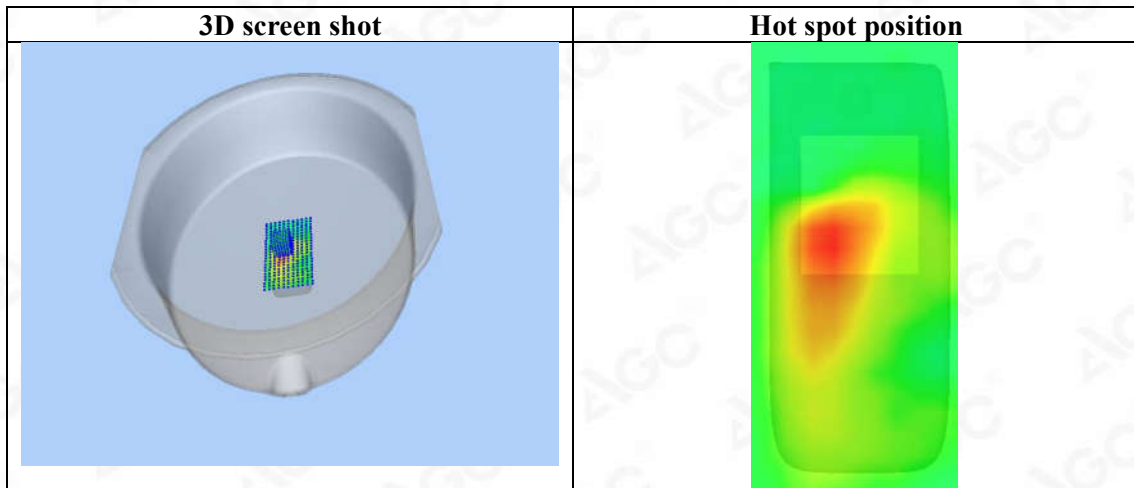
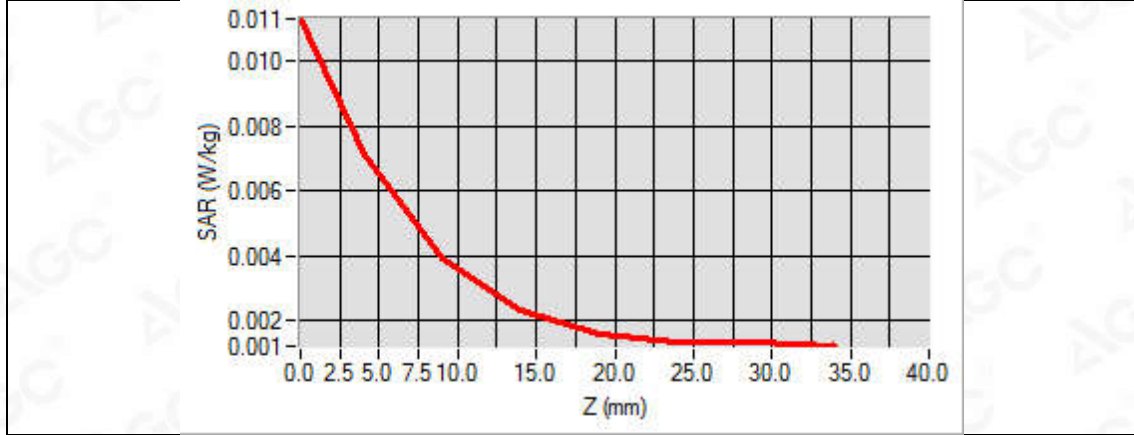

Any report having not been signed by authorized approver, or having been altered without authorization, or having not been stamped by the "Dedicated Testing/Inspection Stamp" is deemed to be invalid. Copying or excerpting portion of, or altering the content of the report is not permitted without the written authorization of AGC. The test results presented in the report apply only to the tested sample. Any objections to report issued by AGC should be submitted to AGC within 15days after the issuance of the test report. Further enquiry of validity or verification of the test report should be addressed to AGC by agc@agc-cert.com.



Repeated SAR

Test Laboratory: AGC Lab
WCDMA Band II Low-Body-Towards Grounds (RMC 12.2kbps)
DUT: Smart phone; Type: K58

Date: Jan. 21, 2022

Communication System: UMTS; Communication System Band: Band II UTRA/FDD ;Duty Cycle:1:1; Conv.F=4.57;
Frequency: 1852.4 MHz; Medium parameters used: $f = 1800$ MHz; $\sigma = 1.36$ mho/m; $\epsilon_r = 38.99$; $\rho = 1000$ kg/m³ ;
Phantom section: Flat Section
Ambient temperature (°C): 21.0, Liquid temperature (°C): 20.7

SATIMO Configuration:

- Probe: SSE5; Calibrated: Aug. 17, 2021; Serial No.: SN 24/20 EP336
- Sensor-Surface: 4mm (Mechanical Surface Detection)
- Phantom: ELLI39 Phantom
- Measurement SW: OpenSAR V4_02_35

Configuration/ WCDMA band II Low-Body-Back/Area Scan: Measurement grid: dx=8mm, dy=8mm
Configuration/ WCDMA band II Low-Body-Back/Zoom Scan: Measurement grid: dx=8mm,dy=8mm, dz=5m;

Area Scan	dx=8mm dy=8mm, h= 5.00 mm
ZoomScan	5x5x7,dx=8mm dy=8mm dz=5mm,Complete
Phantom	ELLI
Device Position	Body Back
Band	WCDMA band II
Channels	Low
Signal	CDMA (Crest factor: 1.0)

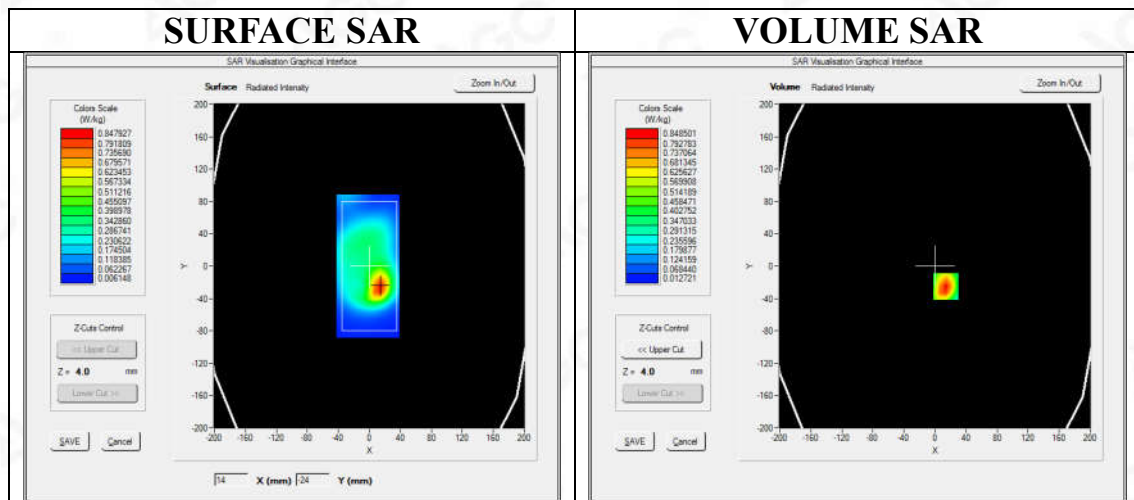

Maximum location: X=14.00, Y=-25.00

SAR Peak: 1.38 W/kg

SAR 10g (W/Kg)	0.423033
SAR 1g (W/Kg)	0.814700

Any report having not been signed by authorized approver, or having been altered without authorization, or having not been stamped by the "Dedicated Testing/Inspection Stamp" is deemed to be invalid. Copying or excerpting portion of, or altering the content of the report is not permitted without the written authorization of AGC. The test results presented in the report apply only to the tested sample. Any objections to report issued by AGC should be submitted to AGC within 15days after the issuance of the test report. Further enquiry of validity or verification of the test report should be addressed to AGC by agc@agc-cert.com.



Z (mm)	0.00	4.00	9.00	14.00	19.00	24.00	29.00
SAR (W/Kg)	1.3445	0.8485	0.4619	0.2561	0.1411	0.0785	0.0439

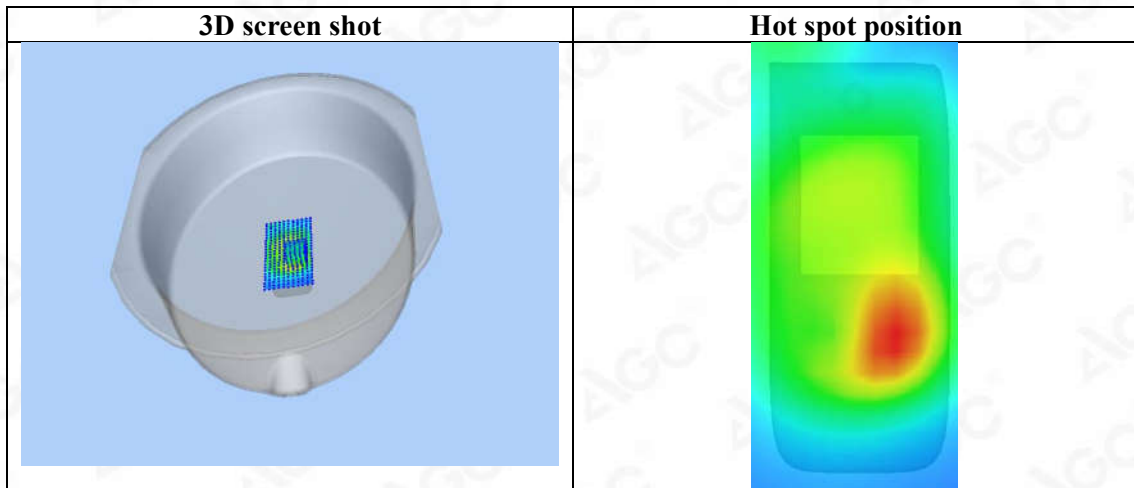
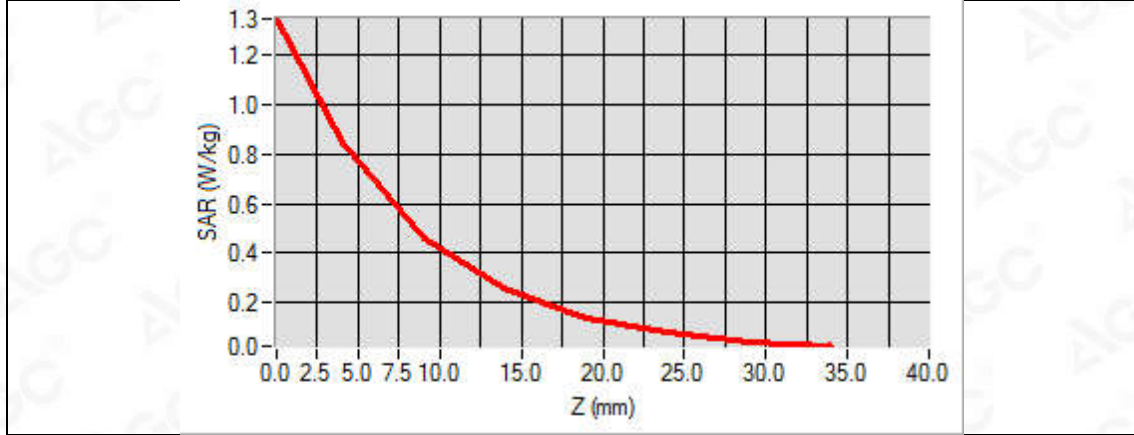

Any report having not been signed by authorized approver, or having been altered without authorization, or having not been stamped by the "Dedicated Testing/Inspection Stamp" is deemed to be invalid. Copying or excerpting portion of, or altering the content of the report is not permitted without the written authorization of AGC. The test results presented in the report apply only to the tested sample. Any objections to report issued by AGC should be submitted to AGC within 15days after the issuance of the test report. Further enquiry of validity or verification of the test report should be addressed to AGC by agc@agc-cert.com.



Test Laboratory: AGC Lab
LTE Band 2 Mid-Body-Back (1 RB#0)
DUT: Smart phone; Type: K58

Date: Jan. 25, 2022

Communication System: LTE; Communication System Band: LTE Band 2; Duty Cycle:1:1; Conv.F=4.57;
Frequency:1880MHz; Medium parameters used: $f = 1800 \text{ MHz}$; $\sigma = 1.40 \text{ mho/m}$; $\epsilon_r = 39.81$; $\rho = 1000 \text{ kg/m}^3$;
Phantom section: Flat Section
Ambient temperature ($^{\circ}\text{C}$): 21.3, Liquid temperature ($^{\circ}\text{C}$): 21.1

SATIMO Configuration:

- Probe: SSE5; Calibrated: Aug. 17, 2021; Serial No.: SN 24/20 EP336
- Sensor-Surface: 4mm (Mechanical Surface Detection)
- Phantom: ELLI39 Phantom
- Measurement SW: OpenSAR V4_02_35

Configuration/ LTE Band 2 Mid-Body-Back/Area Scan: Measurement grid: $dx=8\text{mm}, dy=8\text{mm}$
Configuration/ LTE Band 2 Mid-Body-Back/Zoom Scan: Measurement grid: $dx=8\text{mm}, dy=8\text{mm}, dz=5\text{mm}$;

Area Scan	$dx=8\text{mm}, dy=8\text{mm}, h= 5.00 \text{ mm}$
Zoom Scan	$5x5x7, dx=8\text{mm}, dy=8\text{mm}, dz=5\text{mm}$
Phantom	ELLI
Device Position	Body Back
Band	LTE Band 2
Channels	Middle
Signal	OFDM (Crest factor: 1.0)

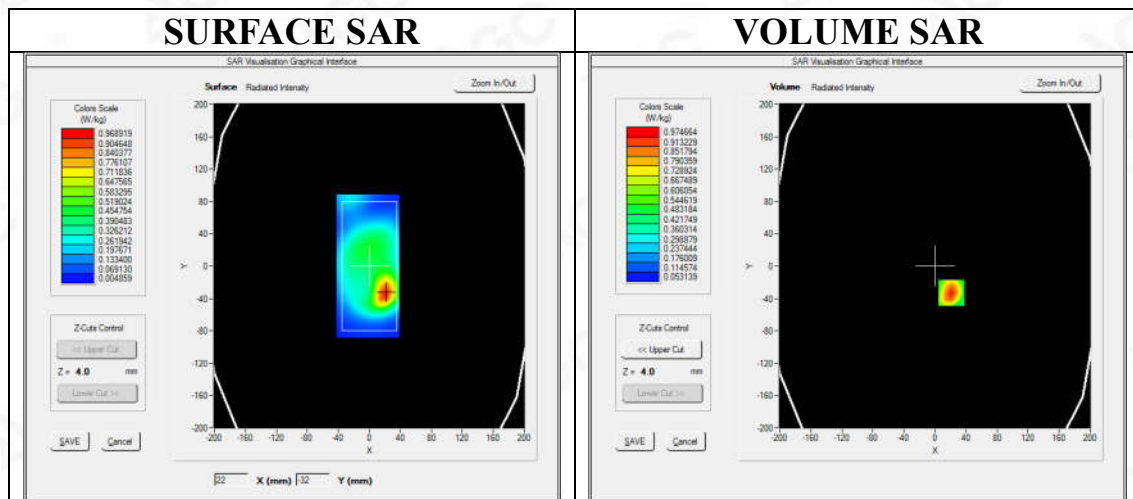

Maximum location: X=21.00, Y=-33.00

SAR Peak: 1.46 W/kg

SAR 10g (W/Kg)	0.475594
SAR 1g (W/Kg)	0.902374

Any report having not been signed by authorized approver, or having been altered without authorization, or having not been stamped by the "Dedicated Testing/Inspection Stamp" is deemed to be invalid. Copying or excerpting portion of, or altering the content of the report is not permitted without the written authorization of AGC. The test results presented in the report apply only to the tested sample. Any objections to report issued by AGC should be submitted to AGC within 15 days after the issuance of the test report. Further enquiry of validity or verification of the test report should be addressed to AGC by agc@agc-cert.com.



Z (mm)	0.00	4.00	9.00	14.00	19.00	24.00	29.00
SAR (W/Kg)	1.4769	0.9747	0.5780	0.4152	0.2462	0.1717	0.1088

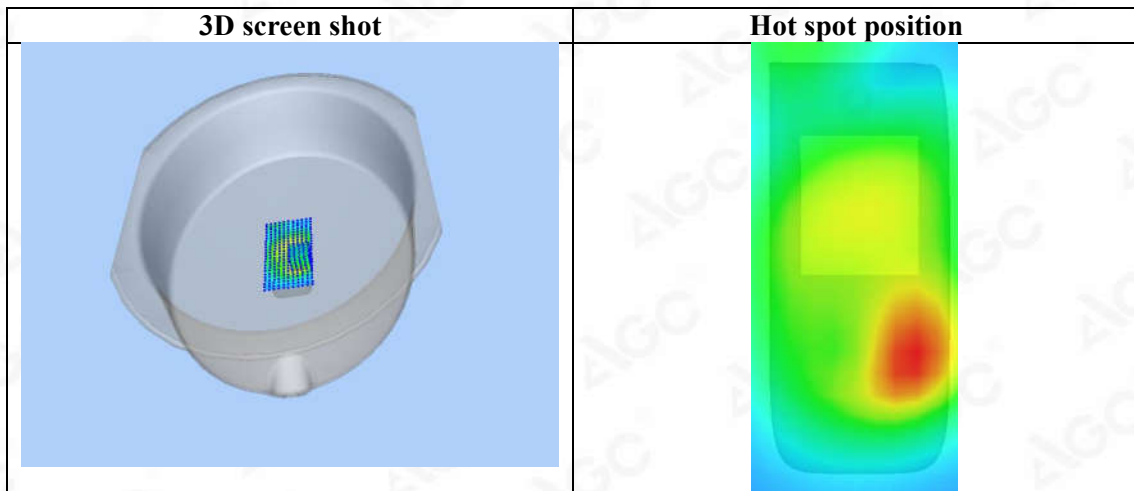
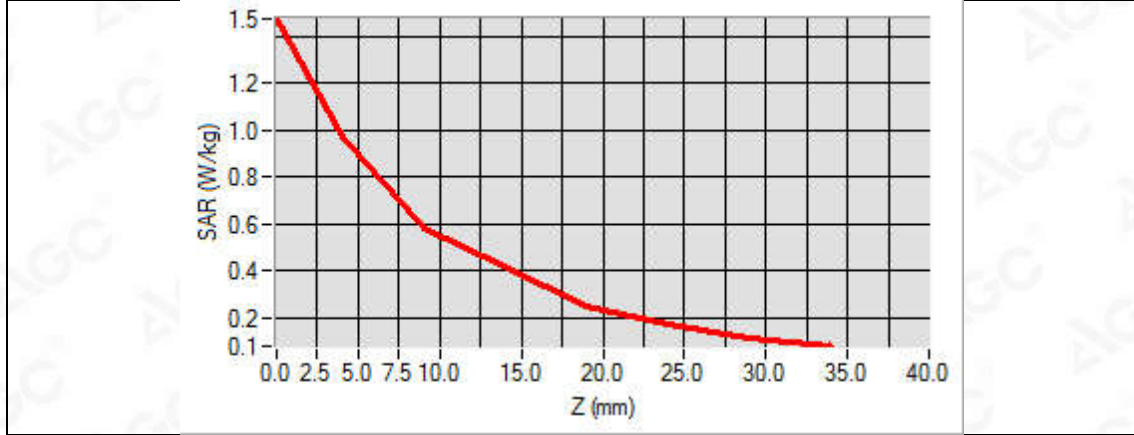

Any report having not been signed by authorized approver, or having been altered without authorization, or having not been stamped by the "Dedicated Testing/Inspection Stamp" is deemed to be invalid. Copying or excerpting portion of, or altering the content of the report is not permitted without the written authorization of AGC. The test results presented in the report apply only to the tested sample. Any objections to report issued by AGC should be submitted to AGC within 15 days after the issuance of the test report. Further enquiry of validity or verification of the test report should be addressed to AGC by agc@agc-cert.com.



Test Laboratory: AGC Lab
LTE Band 4 Mid-Body-Back (1 RB#0)
DUT: Smart phone; Type: K58

Date: Jan. 21, 2022

Communication System: LTE; Communication System Band: LTE Band 4; Duty Cycle:1:1; Conv.F=4.57;
Frequency:1732.5 MHz; Medium parameters used: $f = 1800$ MHz; $\sigma = 1.36$ mho/m; $\epsilon_r = 40.56$; $\rho = 1000$ kg/m³ ;
Phantom section: Flat Section
Ambient temperature (°C): 21.0, Liquid temperature (°C): 20.8

SATIMO Configuration:

- Probe: SSE5; Calibrated: Aug. 17, 2021; Serial No.: SN 24/20 EP336
- Sensor-Surface: 4mm (Mechanical Surface Detection)
- Phantom: ELLI39 Phantom
- Measurement SW: OpenSAR V4_02_35

Configuration/ LTE Band 4 Mid-Body-Back/Area Scan: Measurement grid: dx=8mm, dy=8mm
Configuration/ LTE Band 4 Mid-Body-Back/Zoom Scan: Measurement grid: dx=8mm,dy=8mm, dz=5mm;

Area Scan	dx=8mm dy=8mm, h= 5.00 mm
Zoom Scan	5x5x7,dx=8mm dy=8mm dz=5mm
Phantom	ELLI
Device Position	Body Back
Band	LTE Band 4
Channels	Middle
Signal	OFDM (Crest factor: 1.0)

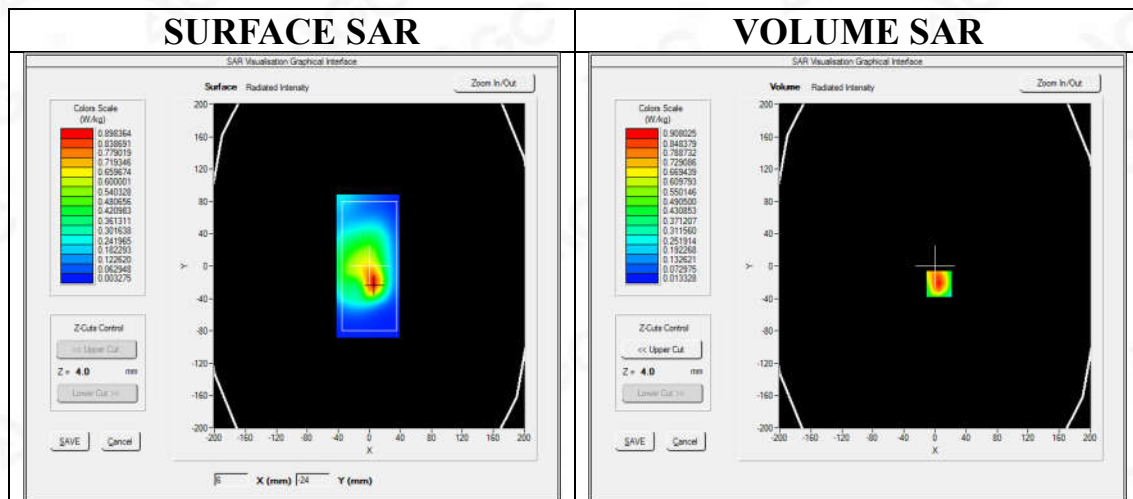

Maximum location: X=5.00, Y=-22.00
SAR Peak: 1.41 W/kg

SAR 10g (W/Kg)	0.471300
SAR 1g (W/Kg)	0.861600

Any report having not been signed by authorized approver, or having been altered without authorization, or having not been stamped by the "Dedicated Testing/Inspection Stamp" is deemed to be invalid. Copying or excerpting portion of, or altering the content of the report is not permitted without the written authorization of AGC. The test results presented in the report apply only to the tested sample. Any objections to report issued by AGC should be submitted to AGC within 15days after the issuance of the test report. Further enquiry of validity or verification of the test report should be addressed to AGC by agc@agc-cert.com.



Z (mm)	0.00	4.00	9.00	14.00	19.00	24.00	29.00
SAR (W/Kg)	1.4191	0.9080	0.5058	0.2907	0.1643	0.0932	0.0533

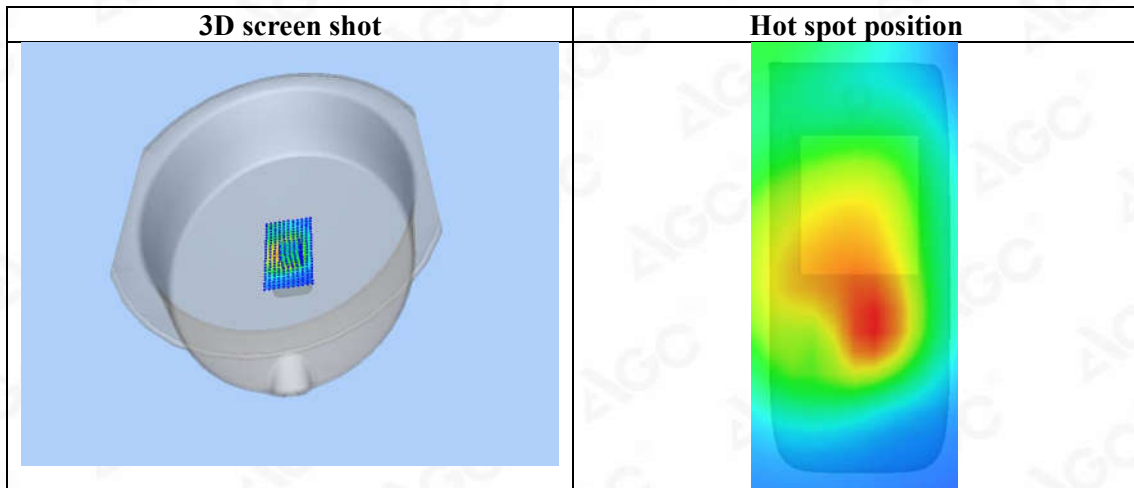
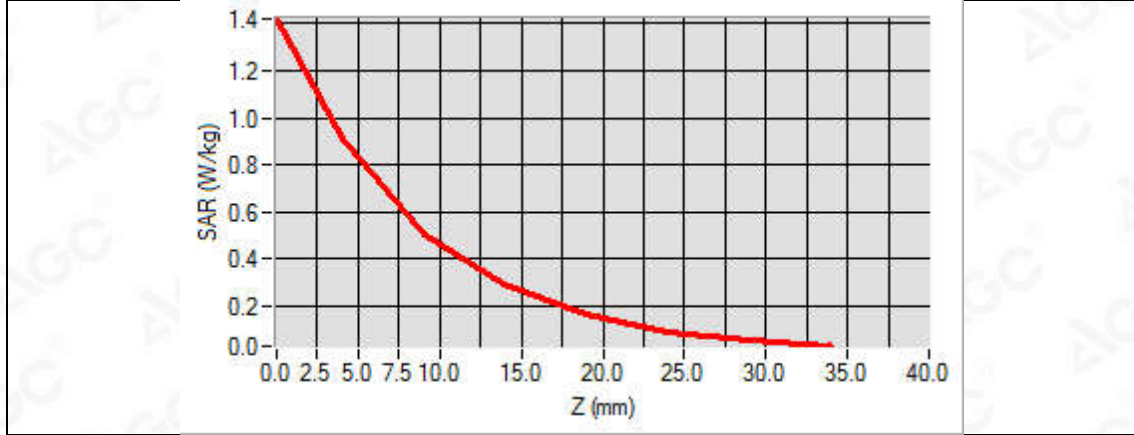

Any report having not been signed by authorized approver, or having been altered without authorization, or having not been stamped by the "Dedicated Testing/Inspection Stamp" is deemed to be invalid. Copying or excerpting portion of, or altering the content of the report is not permitted without the written authorization of AGC. The test results presented in the report apply only to the tested sample. Any objections to report issued by AGC should be submitted to AGC within 15 days after the issuance of the test report. Further enquiry of validity or verification of the test report should be addressed to AGC by agc@agc-cert.com.



Test Laboratory: AGC Lab
LTE Band 7 High-Body-Front (1RB#0)
DUT: Smart phone; Type: K58

Date: Jan. 22, 2022

Communication System: LTE; Communication System Band: LTE Band 7; Duty Cycle:1:1; Conv.F=3.89
Frequency: 2560MHz; Medium parameters used: $f = 2600$ MHz; $\sigma = 1.93$ mho/m; $\epsilon_r = 38.90$; $\rho = 1000$ kg/m³ ;
Phantom section: Flat Section
Ambient temperature (°C): 21.3, Liquid temperature (°C): 21.2

SATIMO Configuration:

- Probe: SSE5; Calibrated: Aug. 17, 2021; Serial No.: SN 24/20 EP336
- Sensor-Surface: 4mm (Mechanical Surface Detection)
- Phantom: ELLI39 Phantom
- Measurement SW: OpenSAR V4_02_35

Configuration/ LTE BAND 7 High-Body-Front /Area Scan: Measurement grid: dx=10mm, y=10mm
Configuration/ LTE BAND 7 High-Body-Front /Zoom Scan: Measurement grid: dx=5mm, dy=5mm, dz=5mm

Area Scan	dx=8mm dy=8mm, h= 5.00 mm
ZoomScan	7x7x7,dx=5mm dy=5mm dz=5mm
Phantom	ELLI
Device Position	Body Front
Band	LTE BAND 7
Channels	High
Signal	OFDM (Crest factor: 1.0)

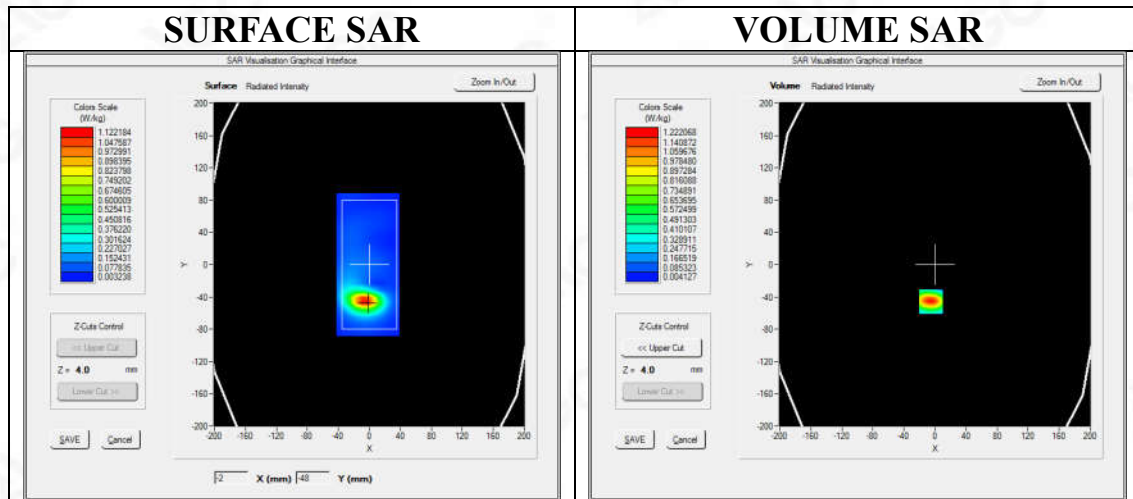

Maximum location: X=-5.00, Y=-46.00
SAR Peak: 2.08 W/kg

SAR 10g (W/Kg)	0.523536
SAR 1g (W/Kg)	1.132437

Any report having not been signed by authorized approver, or having been altered without authorization, or having not been stamped by the "Dedicated Testing/Inspection Stamp" is deemed to be invalid. Copying or excerpting portion of, or altering the content of the report is not permitted without the written authorization of AGC. The test results presented in the report apply only to the tested sample. Any objections to report issued by AGC should be submitted to AGC within 15days after the issuance of the test report. Further enquiry of validity or verification of the test report should be addressed to AGC by agc@agc-cert.com.



Z (mm)	0.00	4.00	9.00	14.00	19.00	24.00	29.00
SAR (W/Kg)	2.0444	1.2221	0.6068	0.3014	0.1488	0.0744	0.0364

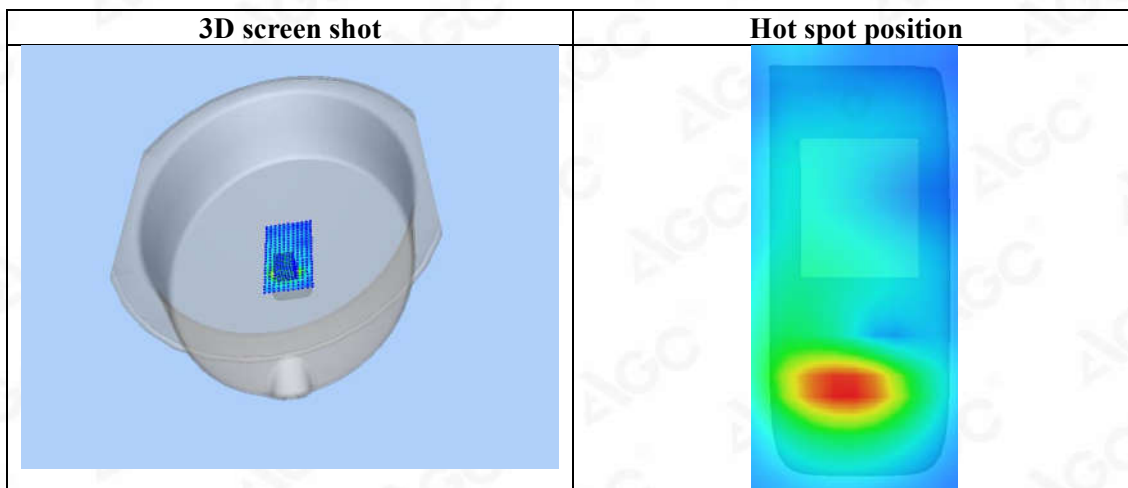
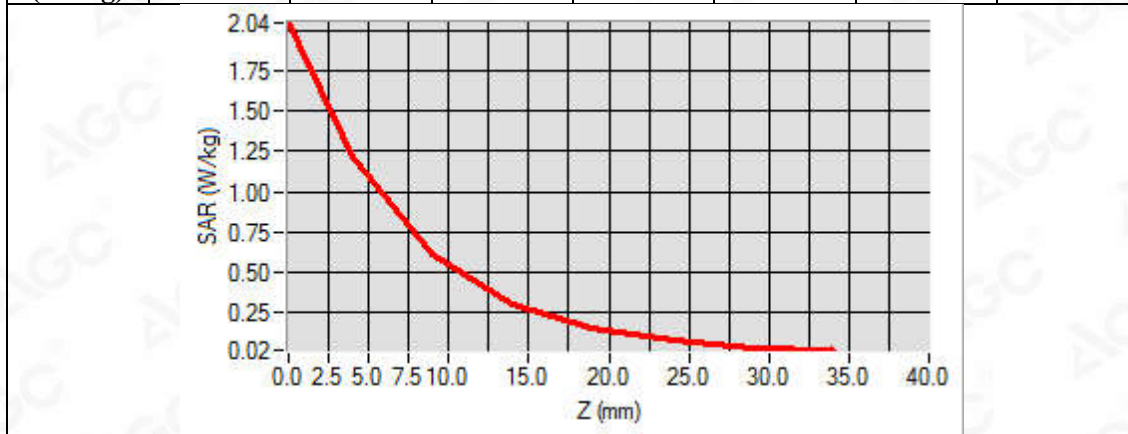

Any report having not been signed by authorized approver, or having been altered without authorization, or having not been stamped by the "Dedicated Testing/Inspection Stamp" is deemed to be invalid. Copying or excerpting portion of, or altering the content of the report is not permitted without the written authorization of AGC. The test results presented in the report apply only to the tested sample. Any objections to report issued by AGC should be submitted to AGC within 15days after the issuance of the test report. Further enquiry of validity or verification of the test report should be addressed to AGC by agc@agc-cert.com.



APPENDIX C. TEST SETUP PHOTOGRAPHS

LEFT-CHEEK TOUCH

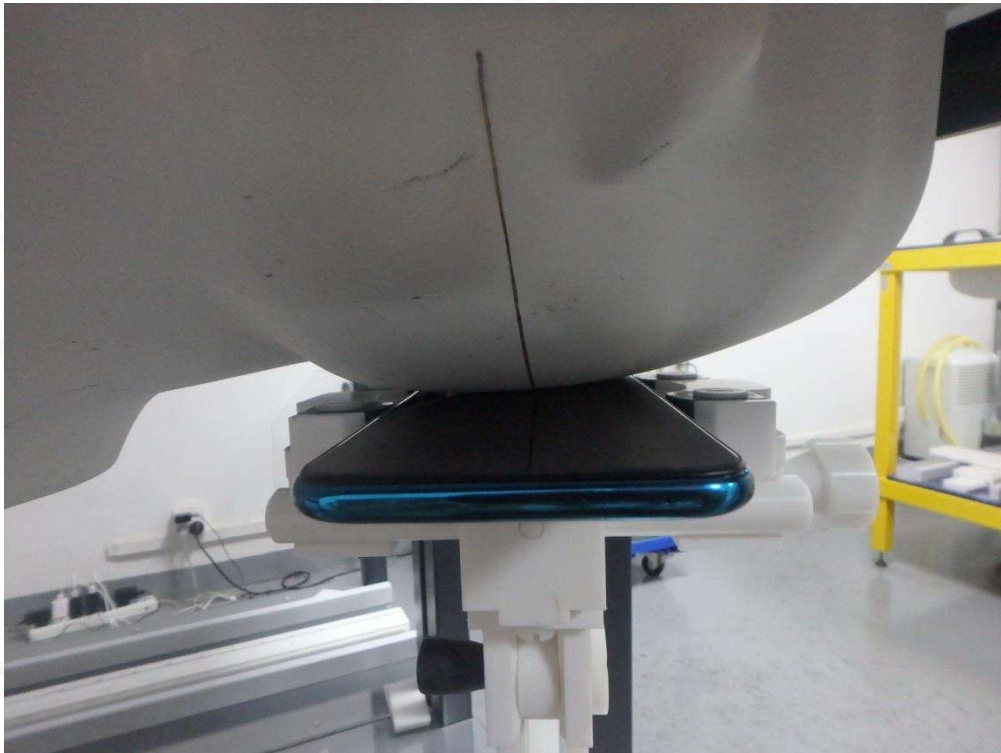

LEFT-TILT 15°

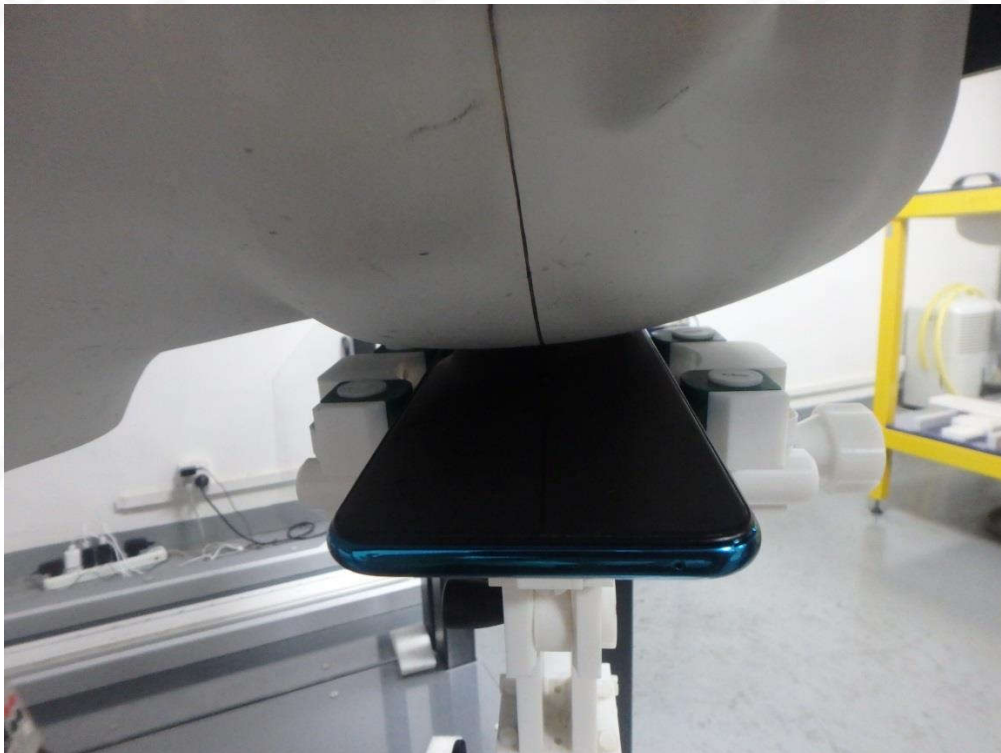

Any report having not been signed by authorized approver, or having been altered without authorization, or having not been stamped by the "Dedicated Testing/Inspection Stamp" is deemed to be invalid. Copying or excerpting portion of, or altering the content of the report is not permitted without the written authorization of AGC. The test results presented in the report apply only to the tested sample. Any objections to report issued by AGC should be submitted to AGC within 15 days after the issuance of the test report. Further enquiry of validity or verification of the test report should be addressed to AGC by agc@agc-cert.com.

Attestation of Global Compliance(Shenzhen)Co., Ltd
Attestation of Global Compliance(Shenzhen)Std & Tech Co., Ltd
Tel: +86-755 2523 4088 E-mail: agc@agc-cert.com Web: <http://cn.agc-cert.com/>



RIGHT- CHEEK TOUCH



RIGHT-TILT 15°

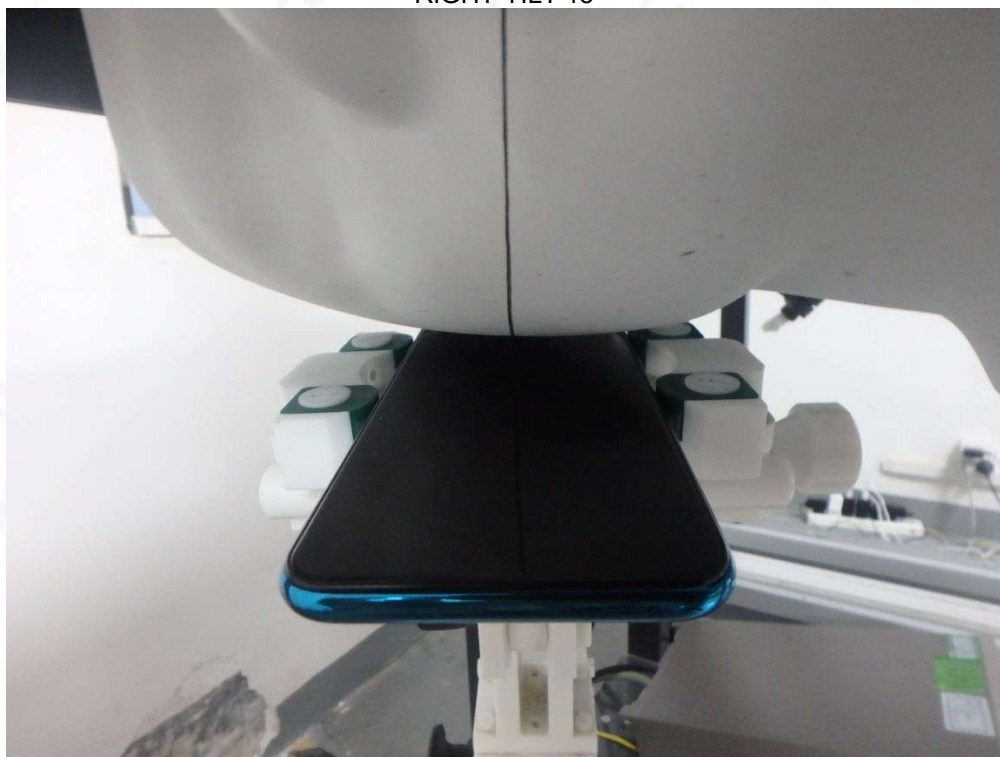

Any report having not been signed by authorized approver, or having been altered without authorization, or having not been stamped by the "Dedicated Testing/Inspection Stamp" is deemed to be invalid. Copying or excerpting portion of, or altering the content of the report is not permitted without the written authorization of AGC. The test results presented in the report apply only to the tested sample. Any objections to report issued by AGC should be submitted to AGC within 15days after the issuance of the test report. Further enquiry of validity or verification of the test report should be addressed to AGC by agc@agc-cert.com.

Attestation of Global Compliance(Shenzhen)Co., Ltd
Attestation of Global Compliance(Shenzhen)Std & Tech Co., Ltd
Tel: +86-755 2523 4088 E-mail: agc@agc-cert.com Web: <http://cn.agc-cert.com/>



Body Back 10mm

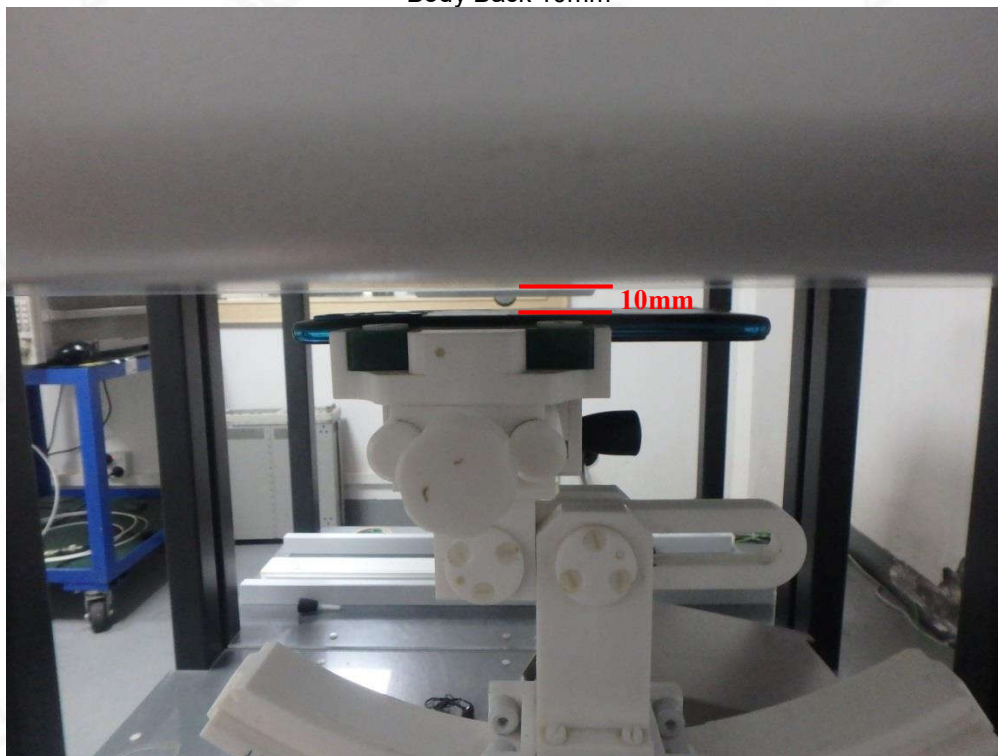

Body Front 10mm



Any report having not been signed by authorized approver, or having been altered without authorization, or having not been stamped by the "Dedicated Testing/Inspection Stamp" is deemed to be invalid. Copying or excerpting portion of, or altering the content of the report is not permitted without the written authorization of AGC. The test results presented in the report apply only to the tested sample. Any objections to report issued by AGC should be submitted to AGC within 15days after the issuance of the test report. Further enquiry of validity or verification of the test report should be addressed to AGC by agc@agc-cert.com.

Attestation of Global Compliance(Shenzhen)Co., Ltd
Attestation of Global Compliance(Shenzhen)Std & Tech Co., Ltd
Tel: +86-755 2523 4088 E-mail: agc@agc-cert.com Web: <http://cn.agc-cert.com/>



Edge 1 (Top) 10mm- Hotspot Mode



Edge 2 (Right) 10mm- Hotspot Mode



Any report having not been signed by authorized approver, or having been altered without authorization, or having not been stamped by the "Dedicated Testing/Inspection Stamp" is deemed to be invalid. Copying or excerpting portion of, or altering the content of the report is not permitted without the written authorization of AGC. The test results presented in the report apply only to the tested sample. Any objections to report issued by AGC should be submitted to AGC within 15days after the issuance of the test report. Further enquiry of validity or verification of the test report should be addressed to AGC by agc@agc-cert.com.

Attestation of Global Compliance(Shenzhen)Co., Ltd
Attestation of Global Compliance(Shenzhen)Std & Tech Co., Ltd
Tel: +86-755 2523 4088 E-mail: agc@agc-cert.com Web: <http://cn.agc-cert.com/>



Edge 3 (Bottom) 10mm- Hotspot Mode

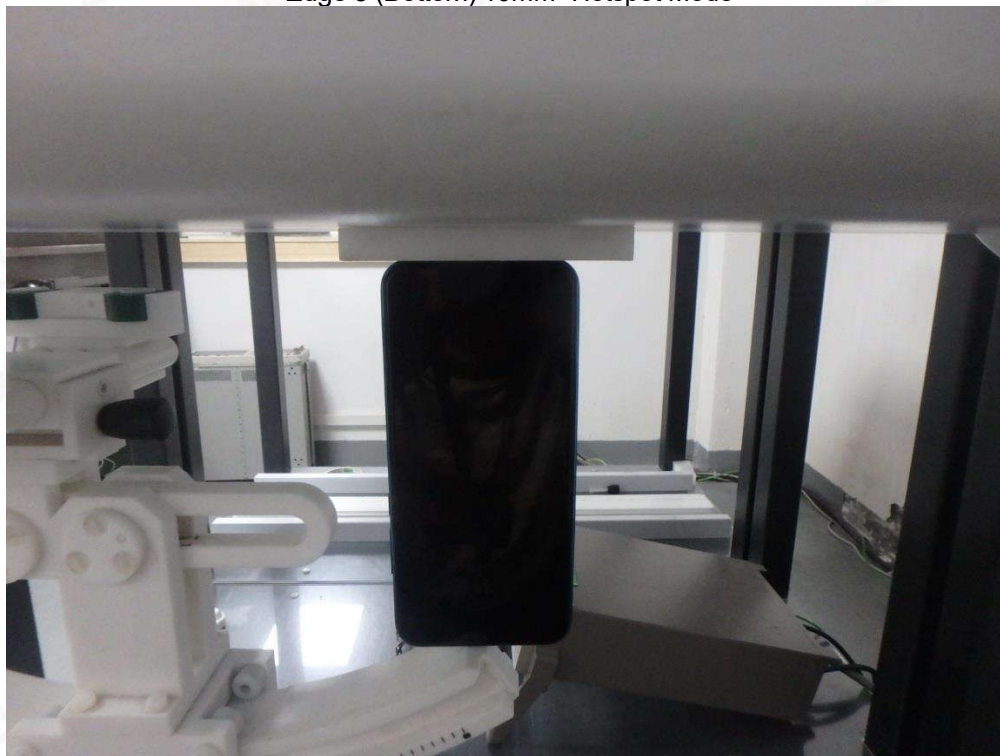

Edge 4 (Left) 10mm- Hotspot Mode

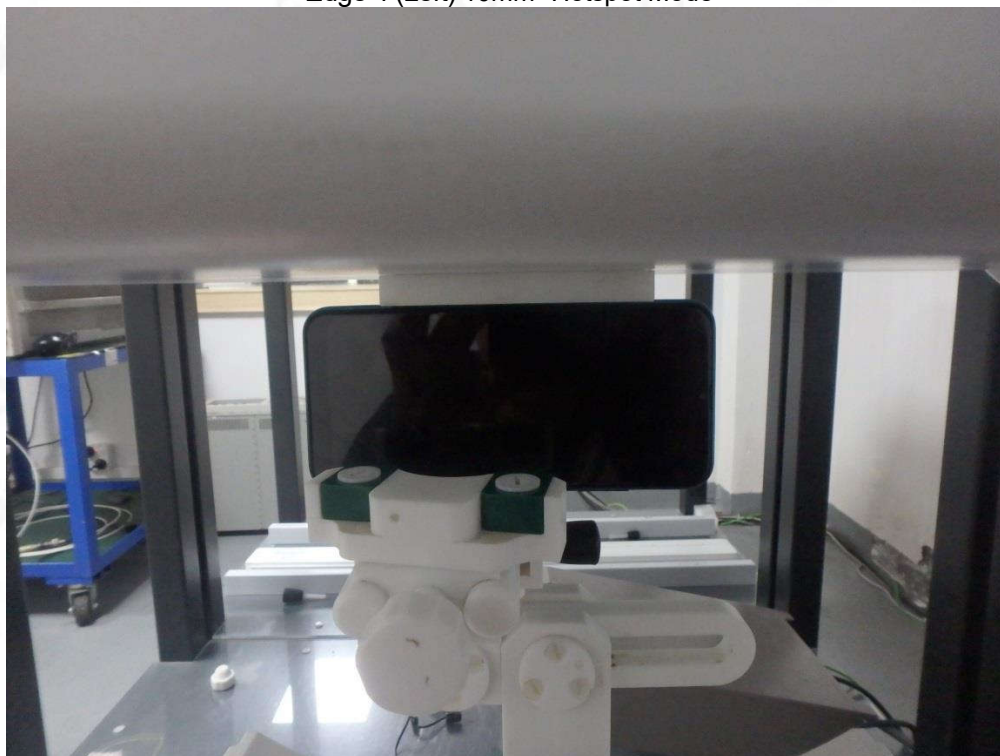

Any report having not been signed by authorized approver, or having been altered without authorization, or having not been stamped by the "Dedicated Testing/Inspection Stamp" is deemed to be invalid. Copying or excerpting portion of, or altering the content of the report is not permitted without the written authorization of AGC. The test results presented in the report apply only to the tested sample. Any objections to report issued by AGC should be submitted to AGC within 15days after the issuance of the test report. Further enquiry of validity or verification of the test report should be addressed to AGC by agc@agc-cert.com.

Attestation of Global Compliance(Shenzhen)Co., Ltd
Attestation of Global Compliance(Shenzhen)Std & Tech Co., Ltd
Tel: +86-755 2523 4088 E-mail: agc@agc-cert.com Web: <http://cn.agc-cert.com/>



DEPTH OF THE LIQUID IN THE PHANTOM—ZOOM IN

Note : The position used in the measurement were according to IEEE 1528-2013

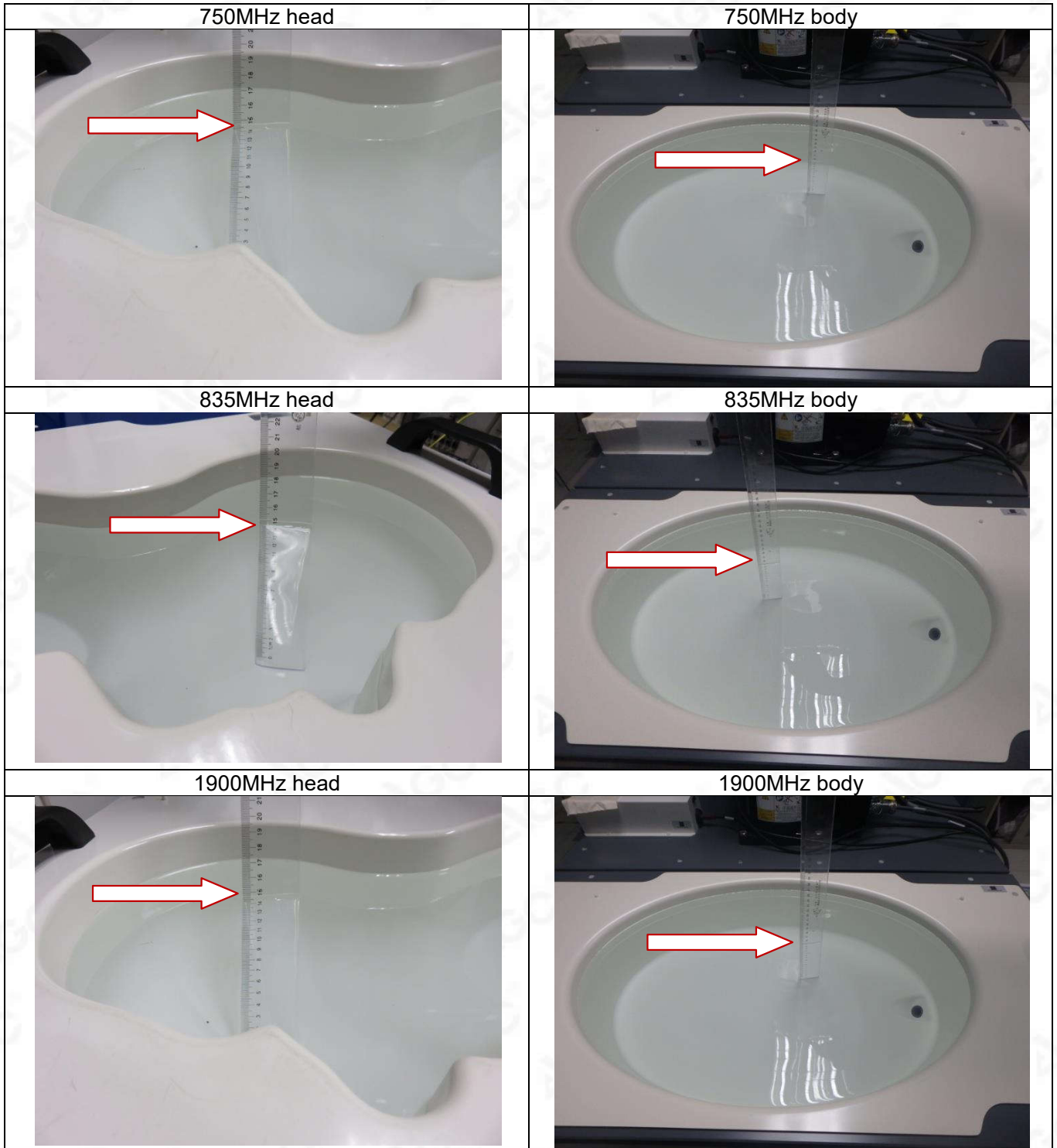

Any report having not been signed by authorized approver, or having been altered without authorization, or having not been stamped by the "Dedicated Testing/Inspection Stamp" is deemed to be invalid. Copying or excerpting portion of, or altering the content of the report is not permitted without the written authorization of AGC. The test results presented in the report apply only to the tested sample. Any objections to report issued by AGC should be submitted to AGC within 15days after the issuance of the test report. Further enquiry of validity or verification of the test report should be addressed to AGC by agc@agc-cert.com.



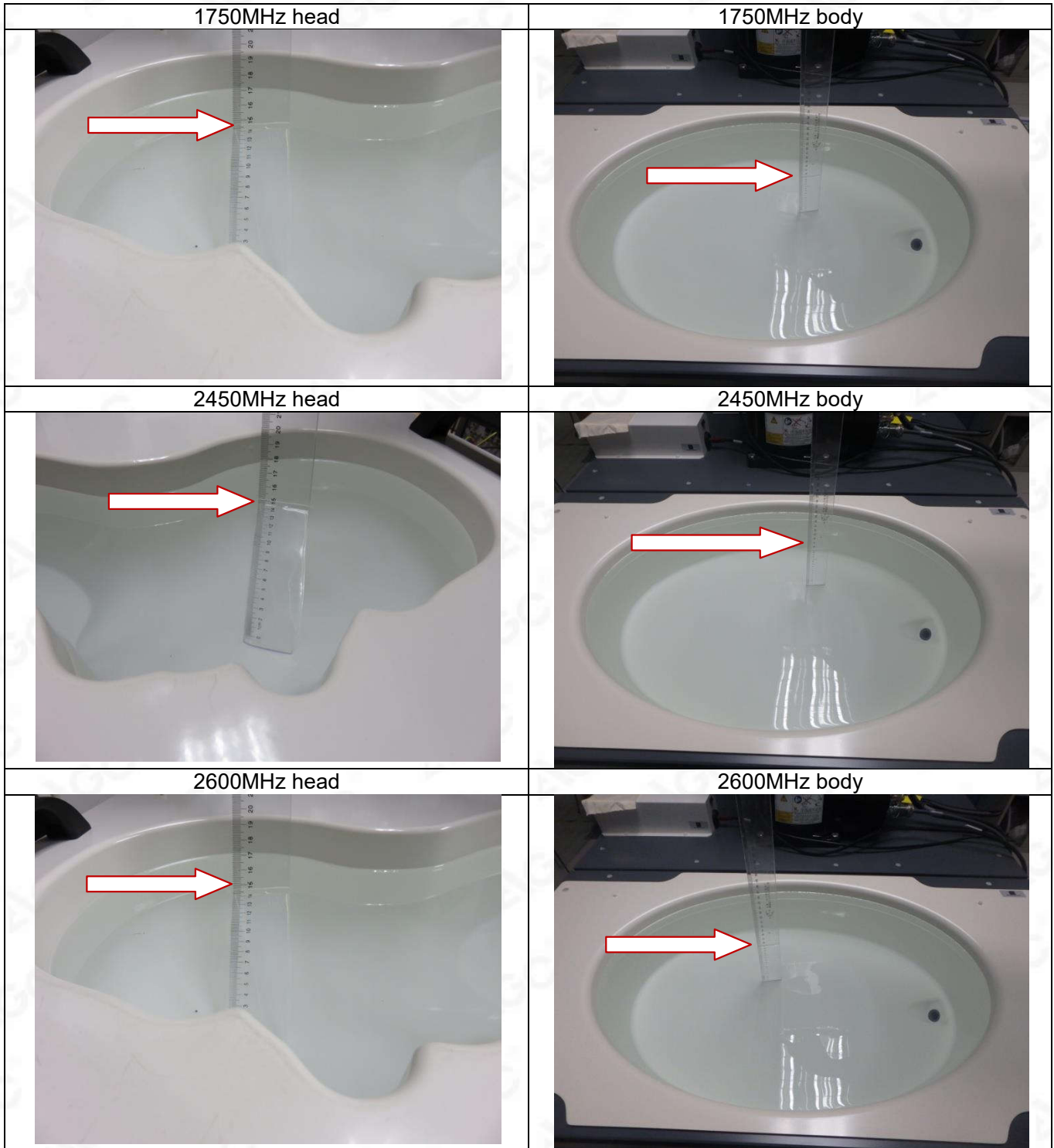

Any report having not been signed by authorized approver, or having been altered without authorization, or having not been stamped by the "Dedicated Testing/Inspection Stamp" is deemed to be invalid. Copying or excerpting portion of, or altering the content of the report is not permitted without the written authorization of AGC. The test results presented in the report apply only to the tested sample. Any objections to report issued by AGC should be submitted to AGC within 15days after the issuance of the test report. Further enquiry of validity or verification of the test report should be addressed to AGC by agc@agc-cert.com.

Attestation of Global Compliance(Shenzhen)Co., Ltd
Attestation of Global Compliance(Shenzhen)Std & Tech Co., Ltd
Tel: +86-755 2523 4088 E-mail: agc@agc-cert.com Web: http://cn.agc-cert.com/



APPENDIX D. CALIBRATION DATA

Refer to Attached files.

Any report having not been signed by authorized approver, or having been altered without authorization, or having not been stamped by the "Dedicated Testing/Inspection Stamp" is deemed to be invalid. Copying or excerpting portion of, or altering the content of the report is not permitted without the written authorization of AGC. The test results presented in the report apply only to the tested sample. Any objections to report issued by AGC should be submitted to AGC within 15 days after the issuance of the test report. Further enquiry of validity or verification of the test report should be addressed to AGC by agc@agc-cert.com.

Attestation of Global Compliance(Shenzhen)Co., Ltd
Attestation of Global Compliance(Shenzhen)Std & Tech Co., Ltd
Tel: +86-755 2523 4088 E-mail: agc@agc-cert.com Web: <http://cn.agc-cert.com/>





Conditions of Issuance of Test Reports

1. All samples and goods are accepted by the Attestation of Global Compliance (Shenzhen) Co., Ltd (the “Company”) solely for testing and reporting in accordance with the following terms and conditions. The company provides its services on the basis that such terms and conditions constitute express agreement between the company and any person, firm or company requesting its services (the “Clients”).
2. Any report issued by Company as a result of this application for testing services (the “Report”) shall be issued in confidence to the Clients and the Report will be strictly treated as such by the Company. It may not be reproduced either in its entirety or in part and it may not be used for advertising or other unauthorized purposes without the written consent of the Company. The Clients to whom the Report is issued may, however, show or send it, or a certified copy thereof prepared by the Company to its customer, supplier or other persons directly concerned. The Company will not, without the consent of the Clients, enter into any discussion or correspondence with any third party concerning the contents of the Report, unless required by the relevant governmental authorities, laws or court orders.
3. The Company shall not be called or be liable to be called to give evidence or testimony on the Report in a court of law without its prior written consent, unless required by the relevant governmental authorities, laws or court orders.
4. In the event of the improper use of the report as determined by the Company, the Company reserves the right to withdraw it, and to adopt any other additional remedies which may be appropriate.
5. Samples submitted for testing are accepted on the understanding that the Report issued cannot form the basis of, or be the instrument for, any legal action against the Company.
6. The Company will not be liable for or accept responsibility for any loss or damage however arising from the use of information contained in any of its Reports or in any communication whatsoever about its said tests or investigations.
7. Clients wishing to use the Report in court proceedings or arbitration shall inform the Company to that effect prior to submitting the sample for testing.
8. The Company is not responsible for recalling the electronic version of the original report when any revision is made to them. The Client assumes the responsibility to providing the revised version to any interested party who uses them.
9. Subject to the variable length of retention time for test data and report stored hereinto as otherwise specifically required by individual accreditation authorities, the Company will only keep the supporting test data and information of the test report for a period of six years. The data and information will be disposed of after the aforementioned retention period has elapsed. Under no circumstances shall we provide any data and information which has been disposed of after retention period. Under no circumstances shall we be liable for damage of any kind, including (but not limited to) compensatory damages, lost profits, lost data, or any form of special, incidental, indirect, consequential or punitive damages of any kind, whether based on breach of contract of warranty, tort (including negligence), product liability or otherwise, even if we are informed in advance of the possibility of such damages.

Any report having not been signed by authorized approver, or having been altered without authorization, or having not been stamped by the “Dedicated Testing/Inspection Stamp” is deemed to be invalid. Copying or excerpting portion of, or altering the content of the report is not permitted without the written authorization of AGC. The test results presented in the report apply only to the tested sample. Any objections to report issued by AGC should be submitted to AGC within 15 days after the issuance of the test report. Further enquiry of validity or verification of the test report should be addressed to AGC by agc@agc-cert.com.

