SAR Test Report

Report No.: AGC10211220101FH01

FCC ID : 2APX7K58

APPLICATION PURPOSE : Original Equipment

PRODUCT DESIGNATION : Smart phone

BRAND NAME : **KRIP**

MODEL NAME : K58

APPLICANT : KRIPTO MOBILE CORPORATION

DATE OF ISSUE : Feb. 15, 2022

STANDARD(S) : IEEE Std. 1528:2013
FCC 47 CFR Part 2§2.1093
IEEE Std C95.1™-2005
IEC 62209-1: 2016

REPORT VERSION : V1.0

Attestation of Global Compliance (Shenzhen) Co., Ltd.



Any report having not been signed by authorized approver, or having been altered without authorization, or having not been stamped by the "Dedicated Testing/Inspection Stamp" is deemed to be invalid. Copying or excerpting portion of, or altering the content of the report is not permitted without the written authorization of AGC. The test results presented in the report apply only to the tested sample. Any objections to report issued by AGC should be submitted to AGC within 15 days after the issuance of the test report. Further enquiry of validity or verification of the test report should be addressed to AGC by agc@agc-cert.com.

Attestation of Global Compliance(Shenzhen)Co., Ltd
Attestation of Global Compliance(Shenzhen)Std & Tech Co., Ltd
Tel: +86-755 2523 4088 E-mail: agc@agc-cert.com Web: <http://cn.agc-cert.com/>



Report Revise Record

Report Version	Revise Time	Issued Date	Valid Version	Notes
V1.0	/	Feb. 15, 2022	Valid	Initial Release

Any report having not been signed by authorized approver, or having been altered without authorization, or having not been stamped by the "Dedicated Testing/Inspection Stamp" is deemed to be invalid. Copying or excerpting portion of, or altering the content of the report is not permitted without the written authorization of AGC. The test results presented in the report apply only to the tested sample. Any objections to report issued by AGC should be submitted to AGC within 15days after the issuance of the test report. Further enquiry of validity or verification of the test report should be addressed to AGC by agc@agc-cert.com.

Attestation of Global Compliance(Shenzhen)Co., Ltd
Attestation of Global Compliance(Shenzhen)Std & Tech Co., Ltd
Tel: +86-755 2523 4088 E-mail: agc@agc-cert.com Web: <http://cn.agc-cert.com/>



Test Report

Applicant Name	KRIPTO MOBILE CORPORATION
Applicant Address	7236 NW 31ST STREET, MIAMI, FL 33122, United States
Manufacturer Name	KRIPTO MOBILE CORPORATION
Manufacturer Address	7236 NW 31ST STREET, MIAMI, FL 33122, United States
Factory Name	KRIPTO MOBILE CORPORATION
Factory Address	7236 NW 31ST STREET, MIAMI, FL 33122, United States
Product Designation	Smart phone
Brand Name	KRIP
Model Name	K58
EUT Voltage	DC3.85V by battery
Applicable Standard	IEEE Std. 1528:2013 FCC 47 CFR Part 2§2.1093 IEEE Std C95.1™-2005 IEC 62209-1: 2016
Test Date	Jan. 20, 2022 to Jan. 26, 2022
Report Template	AGCRT-US-4G/SAR (2021-04-20)

Note: The results of testing in this report apply to the product/system which was tested only.

Thea Huang

Prepared By _____
Thea Huang (Project Engineer) Jan. 26, 2022

Calvin Liu

Reviewed By _____
Calvin Liu (Reviewer) Feb. 15, 2022

Max Zhang

Approved By _____
Max Zhang (Authorized Officer) Feb. 15, 2022

Any report having not been signed by authorized approver, or having been altered without authorization, or having not been stamped by the "Dedicated Testing/Inspection Stamp" is deemed to be invalid. Copying or excerpting portion of, or altering the content of the report is not permitted without the written authorization of AGC. The test results presented in the report apply only to the tested sample. Any objections to report issued by AGC should be submitted to AGC within 15 days after the issuance of the test report. Further enquiry of validity or verification of the test report should be addressed to AGC by agc@agc-cert.com.



TABLE OF CONTENTS

1. SUMMARY OF MAXIMUM SAR VALUE 5

2. GENERAL INFORMATION..... 6

 2.1. EUT DESCRIPTION..... 6

3. SAR MEASUREMENT SYSTEM..... 8

 3.1. THE SATIMO SYSTEM USED FOR PERFORMING COMPLIANCE TESTS CONSISTS OF FOLLOWING ITEMS 8

 3.2. COMOSAR E-FIELD PROBE 9

 3.3. ROBOT..... 9

 3.4. VIDEO POSITIONING SYSTEM 10

 3.5. DEVICE HOLDER 10

 3.6. SAM TWIN PHANTOM..... 11

4. SAR MEASUREMENT PROCEDURE..... 12

 4.1. SPECIFIC ABSORPTION RATE (SAR)..... 12

 4.2. SAR MEASUREMENT PROCEDURE 13

 4.3. RF EXPOSURE CONDITIONS 15

5. TISSUE SIMULATING LIQUID 17

 5.1. THE COMPOSITION OF THE TISSUE SIMULATING LIQUID..... 17

 5.2. TISSUE DIELECTRIC PARAMETERS FOR HEAD AND BODY PHANTOMS 18

 5.3. TISSUE CALIBRATION RESULT 19

6. SAR SYSTEM CHECK PROCEDURE 21

 6.1. SAR SYSTEM CHECK PROCEDURES 21

 6.2. SAR SYSTEM CHECK..... 22

7. EUT TEST POSITION..... 24

 7.1. DEFINE TWO IMAGINARY LINES ON THE HANDSET..... 24

 7.2. CHEEK POSITION 25

 7.3. TILT POSITION..... 25

 7.4. BODY WORN POSITION 26

8. SAR EXPOSURE LIMITS 27

9. TEST FACILITY 28

10. TEST EQUIPMENT LIST 29

11. MEASUREMENT UNCERTAINTY 30

12. CONDUCTED POWER MEASUREMENT..... 34

13. TEST RESULTS 57

 13.1. SAR TEST RESULTS SUMMARY..... 57

APPENDIX A. SAR SYSTEM CHECK DATA 84

APPENDIX B. SAR MEASUREMENT DATA..... 116

APPENDIX C. TEST SETUP PHOTOGRAPHS..... 178

APPENDIX D. CALIBRATION DATA 185

Any report having not been signed by authorized approver, or having been altered without authorization, or having not been stamped by the "Dedicated Testing/Inspection Stamp" is deemed to be invalid. Copying or excerpting portion of, or altering the content of the report is not permitted without the written authorization of AGC. The test results presented in the report apply only to the tested sample. Any objections to report issued by AGC should be submitted to AGC within 15days after the issuance of the test report. Further enquiry of validity or verification of the test report should be addressed to AGC by agc@agc-cert.com.



1. SUMMARY OF MAXIMUM SAR VALUE

The maximum results of Specific Absorption Rate (SAR) found during testing for EUT are as follows:

Frequency Band	Highest Reported 1g-SAR(W/kg)			SAR Test Limit (W/kg)
	Head	Body-worn(with 10mm separation)	Hotspot(with 10mm separation)	
GSM 850	0.302	0.283	0.205	1.6
PCS 1900	0.551	0.635	0.522	
UMTS Band II	0.711	0.963	0.963	
UMTS Band V	0.357	0.360	0.360	
LTE Band 2	0.410	1.012	1.012	
LTE Band 4	0.358	0.903	0.903	
LTE Band 5	0.346	0.313	0.313	
LTE Band 7	0.130	1.292	1.292	
LTE Band 12	0.309	0.432	0.432	
LTE Band 17	0.313	0.434	0.434	
WIFI 2.4G	0.166	0.084	0.084	
Bluetooth(BR&EDR)	0.022	0.009	0.009	
Simultaneous Reported SAR	1.379			
SAR Test Result	PASS			

This device is compliance with Specific Absorption Rate (SAR) for general population/uncontrolled exposure limits (1.6W/kg) specified in IEEE Std. 1528:2013; FCC 47CFR § 2.1093; IEEE/ANSI C95.1:2005 and the following specific FCC Test Procedures:

- KDB 447498 D04 Interim General RF Exposure Guidance v01
- KDB 648474 D04 Handset SAR v01r03
- KDB 865664 D01 SAR Measurement 100MHz to 6GHz v01r04
- KDB 941225 D01 3G SAR Procedures v03r01
- KDB 941225 D06 Hotspot Mode v02r01
- KDB 248227 D01 802 11 Wi-Fi SAR v02r02
- KDB 941225 D05 SAR for LTE Devices v02r05

Any report having not been signed by authorized approver, or having been altered without authorization, or having not been stamped by the "Dedicated Testing/Inspection Stamp" is deemed to be invalid. Copying or excerpting portion of, or altering the content of the report is not permitted without the written authorization of AGC. The test results presented in the report apply only to the tested sample. Any objections to report issued by AGC should be submitted to AGC within 15days after the issuance of the test report. Further enquiry of validity or verification of the test report should be addressed to AGC by agc@agc-cert.com.



2. GENERAL INFORMATION

2.1. EUT Description

General Information	
Product Designation	Smart phone
Test Model	K58
Hardware Version	TH105 V2.0
Software Version	KRIP_K58_EN_11GO_HW1_V004
Device Category	Portable
RF Exposure Environment	Uncontrolled
Antenna Type	Internal
GSM and GPRS & EGPRS	
Support Band	<input checked="" type="checkbox"/> GSM 850 <input checked="" type="checkbox"/> PCS 1900 <input checked="" type="checkbox"/> GSM 900 <input checked="" type="checkbox"/> DCS 1800
GPRS & EGPRS Type	Class B
GPRS & EGPRS Class	Class 12(1Tx+4Rx, 2Tx+3Rx, 3Tx+2Rx, 4Tx+1Rx)
TX Frequency Range	GSM 850 : 820-850MHz; PCS 1900: 1850-1910MHz;
RX Frequency Range	GSM 850 : 869~894MHz; PCS 1900: 1930~1990MHz
Release Version	R99
Type of modulation	GMSK for GSM/GPRS; GMSK & 8-PSK for EGPRS
Antenna Gain	GSM850: -0.76dBi; PCS1900: 0.85dBi
Max. Average Power	GSM850: 32.20dBm; PCS1900: 30.29dBm
WCDMA	
Support Band	<input checked="" type="checkbox"/> UMTS FDD Band II <input checked="" type="checkbox"/> UMTS FDD Band V <input type="checkbox"/> UMTS FDD Band IV <input checked="" type="checkbox"/> UMTS FDD Band I <input type="checkbox"/> UMTS FDD Band III <input checked="" type="checkbox"/> UMTS FDD Band VIII
HS Type	HSPA(HSUPA/HSDPA)
TX Frequency Range	FDD Band II: 1850-1910MHz; FDD Band V: 824-849MHz
RX Frequency Range	FDD Band II: 1930-1990MHz; FDD Band V: 869-894MHz
Release Version	Rel-6
Type of modulation	HSDPA:QPSK/16QAM; HSUPA:BPSK; WCDMA:QPSK
Antenna Gain	Band II: 0.85dBi; Band V: -0.76dBi
Max. Average Power	Band II: 22.55dBm; Band V: 22.68dBm
Bluetooth	
Bluetooth Version	<input type="checkbox"/> V2.0 <input type="checkbox"/> V2.1 <input type="checkbox"/> V2.1+EDR <input type="checkbox"/> V3.0 <input type="checkbox"/> V3.0+HS <input type="checkbox"/> V4.0 <input checked="" type="checkbox"/> V4.2
Operation Frequency	2402~2480MHz
Type of modulation	BR <input checked="" type="checkbox"/> GFSK, EDR <input checked="" type="checkbox"/> $\pi/4$ -DQPSK, <input checked="" type="checkbox"/> 8DPSK BLE <input checked="" type="checkbox"/> GFSK 1Mbps <input type="checkbox"/> GFSK 2Mbps
Peak Power	5.470dBm
Antenna Gain	1.03dBi
WIFI	
WIFI Specification	<input type="checkbox"/> 802.11a <input checked="" type="checkbox"/> 802.11b <input checked="" type="checkbox"/> 802.11g <input checked="" type="checkbox"/> 802.11n(20) <input type="checkbox"/> 802.11n(40)
Operation Frequency	2412~2462MHz
Avg. Burst Power	11b: 12.06dBm, 11g: 14.63dBm, 11n(20): 14.21dBm,
Antenna Gain	1.03dBi

Any report having not been signed by authorized approver, or having been altered without authorization, or having not been stamped by the "Dedicated Testing/Inspection Stamp" is deemed to be invalid. Copying or excerpting portion of, or altering the content of the report is not permitted without the written authorization of AGC. The test results presented in the report apply only to the tested sample. Any objections to report issued by AGC should be submitted to AGC within 15 days after the issuance of the test report. Further enquiry of validity or verification of the test report should be addressed to AGC by agc@agc-cert.com.



EUT Description(Continue)

LTE	
Support Band	<input checked="" type="checkbox"/> FDD Band 2 <input checked="" type="checkbox"/> FDD Band 4 <input checked="" type="checkbox"/> FDD Band 5 <input checked="" type="checkbox"/> FDD Band 7 <input checked="" type="checkbox"/> FDD Band 12 <input checked="" type="checkbox"/> FDD Band 17 (U.S. Bands) <input checked="" type="checkbox"/> FDD Band 3 <input checked="" type="checkbox"/> FDD Band 8(Non-U.S. Bands)
TX Frequency Range	Band 2:1850-1910MHz; Band 4:1710-1755MHz;Band 5:824-849MHz; Band 7:2500-2570MHz; Band 12:699-716MHz; Band 17: 704-716MHz;
RX Frequency Range	Band 2:1930-1990MHz; Band 4:2110-2155MHz; Band 5:869-894MHz; Band 7:2620-2690MHz; Band 12: 729-746 MHz; Band 17: 734-746 MHz;
Release Version	Rel-8
Type of modulation	QPSK, 16QAM
Antenna Gain	Band 2: 0.85dBi; Band 4: 0.83dBi; Band 5: -0.76dBi; Band 7: 1.09dBi; Band 12: -0.68dBi; Band 17: -0.69dBi;
Max. Average Power	Band 2: 22.81dBm; Band 4: 23.03dBm; Band 5: 23.35dBm; Band 7:22.18dBm; Band 12: 23.34dBm; Band 17: 23.26dBm;
Accessories	
Battery	Brand name: KRIP Model No. : B58 Voltage and Capacitance: 3.85 V & 4800mAh
Earphone	Brand name: N/A Model No. : N/A

- Note:1.CMU200 can measure the average power and Peak power at the same time
2.The sample used for testing is end product.
3. The test sample has no any deviation to the test method of standard mentioned in page 1.

Product	Type
	<input checked="" type="checkbox"/> Production unit <input type="checkbox"/> Identical Prototype

Any report having not been signed by authorized approver, or having been altered without authorization, or having not been stamped by the "Dedicated Testing/Inspection Stamp" is deemed to be invalid. Copying or excerpting portion of, or altering the content of the report is not permitted without the written authorization of AGC. The test results presented in the report apply only to the tested sample. Any objections to report issued by AGC should be submitted to AGC within 15days after the issuance of the test report. Further enquiry of validity or verification of the test report should be addressed to AGC by agc@agc-cert.com.



3. SAR MEASUREMENT SYSTEM

3.1. The SATIMO system used for performing compliance tests consists of following items

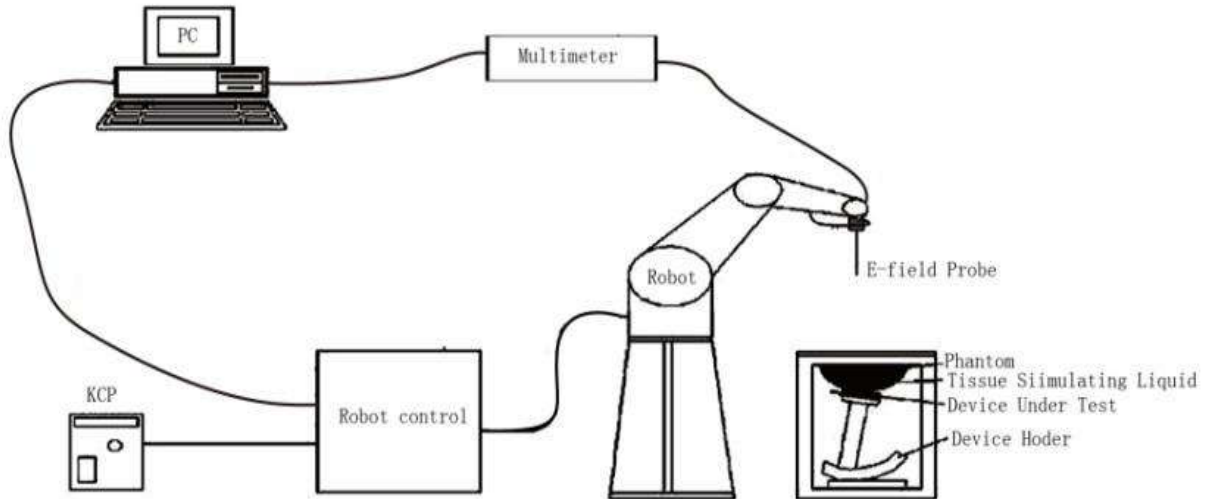

The COMOSAR system for performing compliance tests consists of the following items:

- The PC. It controls most of the bench devices and stores measurement data. A computer running WinXP and the Opensar software.
- The E-Field probe. The probe is a 3-axis system made of 3 distinct dipoles. Each dipole returns a voltage in function of the ambient electric field.
- The Keithley multimeter measures each probe dipole voltages.
- The SAM phantom simulates a human head. The measurement of the electric field is made inside the phantom.
- The liquids simulate the dielectric properties of the human head tissues.
- The network emulator controls the mobile phone under test.
- The validation dipoles are used to measure a reference SAR. They are used to periodically check the bench to make sure that there is no drift of the system characteristics over time.
- The phantom, the device holder and other accessories according to the targeted measurement.

Any report having not been signed by authorized approver, or having been altered without authorization, or having not been stamped by the "Dedicated Testing/Inspection Stamp" is deemed to be invalid. Copying or excerpting portion of, or altering the content of the report is not permitted without the written authorization of AGC. The test results presented in the report apply only to the tested sample. Any objections to report issued by AGC should be submitted to AGC within 15 days after the issuance of the test report. Further enquiry of validity or verification of the test report should be addressed to AGC by agc@agc-cert.com.

3.2. COMOSAR E-Field Probe

The SAR measurement is conducted with the dosimetric probe manufactured by SATIMO. The probe is specially designed and calibrated for use in liquid with high permittivity. The dosimetric probe has special calibration in liquid at different frequency. SATIMO conducts the probe calibration in compliance with international and national standards (e.g. IEEE 1528 and relevant KDB files.) The calibration data are in Appendix D.

Isotropic E-Field Probe Specification

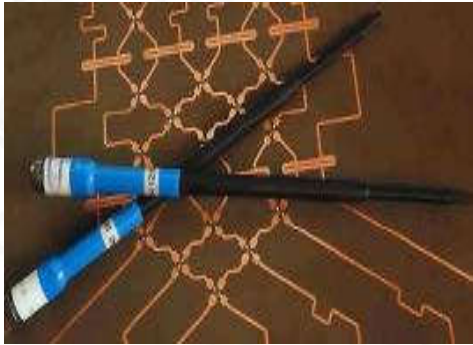
Model	SSE5	
Manufacture	MVG	
Identification No.	SN 24/20 EP336	
Frequency	0.15GHz-3GHz Linearity:±0.05dB(0.15GHz-3GHz)	
Dynamic Range	0.01W/kg-100W/kg Linearity:±0.05dB	
Dimensions	Overall length:330mm Length of individual dipoles:4.5mm Maximum external diameter:8mm Probe Tip external diameter:5mm Distance between dipoles/ probe extremity:2.7mm	
Application	High precision dosimetric measurements in any exposure scenario (e.g., very strong gradient fields). Only probe which enables compliance testing for frequencies up to 3 GHz with precision of better 30%.	

3.3. Robot

The COMOSAR system uses the KUKA robot from SATIMO SA (France). For the 6-axis controller COMOSAR system, the KUKA robot controller version from SATIMO is used.

The XL robot series have many features that are important for our application:

- High precision (repeatability 0.02 mm)
- High reliability (industrial design)
- Jerk-free straight movements
- Low ELF interference (the closed metallic construction shields against motor control fields)
- 6-axis controller



Any report having not been signed by authorized approver, or having been altered without authorization, or having not been stamped by the "Dedicated Testing/Inspection Stamp" is deemed to be invalid. Copying or excerpting portion of, or altering the content of the report is not permitted without the written authorization of AGC. The test results presented in the report apply only to the tested sample. Any objections to report issued by AGC should be submitted to AGC within 15 days after the issuance of the test report. Further enquiry of validity or verification of the test report should be addressed to AGC by agc@agc-cert.com.



3.4. Video Positioning System

The video positioning system is used in OpenSAR to check the probe. Which is composed of a camera, LED, mirror and mechanical parts. The camera is piloted by the main computer with firewire link. During the process, the actual position of the probe tip with respect to the robot arm is measured, as well as the probe length and the horizontal probe offset. The software then corrects all movements, such that the robot coordinates are valid for the probe tip. The repeatability of this process is better than 0.1 mm. If a position has been taught with an aligned probe, the same position will be reached with another aligned probe within 0.1 mm, even if the other probe has different dimensions. During probe rotations, the probe tip will keep its actual position.

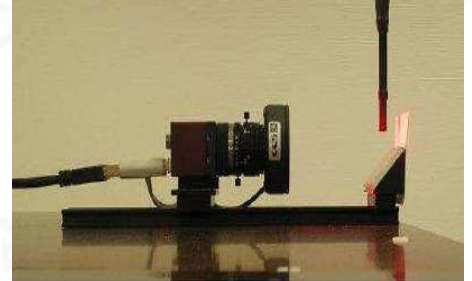

3.5. Device Holder

The COMOSAR device holder is designed to cope with different positions given in the standard. It has two scales for the device rotation (with respect to the body axis) and the device inclination (with respect to the line between the ear reference points). The rotation center for both scales is the ear reference point (EPR). Thus the device needs no repositioning when changing the angles. The COMOSAR device holder has been made out of low-loss POM material having the following dielectric parameters: relative permittivity $\epsilon_r = 3$ and loss tangent $\delta = 0.02$. The amount of dielectric material has been reduced in the closest vicinity of the device, since measurements have suggested that the influence of the clamp on the test results could thus be lowered.

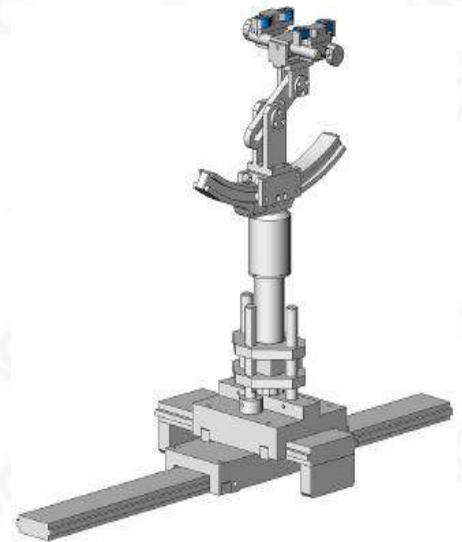

3.6. SAM Twin Phantom

The SAM twin phantom is a fiberglass shell phantom with 2mm shell thickness (except the ear region where shell thickness increases to 6mm). It has three measurement areas:

- Left head
- Right head
- Flat phantom



The bottom plate contains three pair of bolts for locking the device holder. The device holder positions are adjusted to the standard measurement positions in the three sections. A white cover is provided to tap the phantom during off-periods to prevent water evaporation and changes in the liquid parameters. On the phantom top, three reference markers are provided to identify the phantom position with respect to the robot.

ELLI39 Phantom

The Flat phantom is a fiberglass shellphantom with 2mm+/- 0.2 mm shell thickness. It has only one measurement area for Flat phantom



4. SAR MEASUREMENT PROCEDURE

4.1. Specific Absorption Rate (SAR)

SAR is related to the rate at which energy is absorbed per unit mass in object exposed to a radio field. The SAR distribution in a biological body is complicated and is usually carried out by experimental techniques or numerical modeling. The standard recommends limits for two tiers of groups, occupational/controlled and occupational/uncontrolled, based on a person's awareness and ability to exercise control over his or her exposure. In general, occupational/controlled exposure limits are higher than the limits for general population/uncontrolled.

The SAR definition is the time derivative (rate) of the incremental energy (dW) absorbed by (dissipated in) an incremental mass (dm) contained in a volume element(dv) of given mass density (ρ). The equation description is as below:

$$SAR = \frac{d}{dt} \left(\frac{dW}{dm} \right) = \frac{d}{dt} \left(\frac{dW}{\rho dV} \right)$$

SAR is expressed in units of Watts per kilogram (W/kg)

SAR can be obtained using either of the following equations:

$$SAR = \frac{\sigma E^2}{\rho}$$

$$SAR = c_h \left. \frac{dT}{dt} \right|_{t=0}$$

Where

SAR	is the specific absorption rate in watts per kilogram;
E	is the r.m.s. value of the electric field strength in the tissue in volts per meter;
σ	is the conductivity of the tissue in siemens per metre;
ρ	is the density of the tissue in kilograms per cubic metre;
c _h	is the heat capacity of the tissue in joules per kilogram and Kelvin;

$\left. \frac{dT}{dt} \right|_{t=0}$ is the initial time derivative of temperature in the tissue in kelvins per second

4.2. SAR Measurement Procedure

Step 1: Power Reference Measurement

The Power Reference Measurement and Power Drift Measurement are for monitoring the power drift of the device under test in the batch process. The minimum distance of probe sensors to surface is 2.7mm This distance cannot be smaller than the distance os sensor calibration points to probe tip as `defined in the probe properties,

Step 2: Area Scan

The Area Scan is used as a fast scan in two dimensions to find the area of high field values, before doing a fine measurement around the hot spot. The sophisticated interpolation routines implemented in SATIMO software can find the maximum locations even in relatively coarse grids. When an Area Scan has measured all reachable points, it computes the field maximal found in the scanned area, within a range of the global maximum. The range (in db) is specified in the standards for compliance testing. For example, a 2db range is required in IEEE Standard 1528 and IEC62209 standards, whereby 3db is a requirement when compliance is assessed in accordance with the ARIB standard (Japan) If one Zoom Scan follows the Area Scan, then only the absolute maximum will be taken as reference. For cases where multiple maximum are detected, the number of Zoom Scan has to be increased accordingly.

Area Scan Parameters extracted from KDB 865664 D01 SAR Measurement 100MHz to 6GHz

	≤ 3 GHz	> 3 GHz
Maximum distance from closest measurement point (geometric center of probe sensors) to phantom surface	5 ± 1 mm	$\frac{1}{2} \cdot \delta \cdot \ln(2) \pm 0.5 \text{ mm}$
Maximum probe angle from probe axis to phantom surface normal at the measurement location	30° ± 1°	20° ± 1°
Maximum area scan spatial resolution: Δx_{Area} , Δy_{Area}	≤ 2 GHz: ≤ 15 mm 2 – 3 GHz: ≤ 12 mm	3 – 4 GHz: ≤ 12 mm 4 – 6 GHz: ≤ 10 mm
	When the x or y dimension of the test device, in the measurement plane orientation, is smaller than the above, the measurement resolution must be ≤ the corresponding x or y dimension of the test device with at least one measurement point on the test device.	

Step 3: Zoom Scan

Zoom Scan are used to assess the peak spatial SAR value within a cubic average volume containing 1g abd 10g of simulated tissue. The Zoom Scan measures points(refer to table below) within a cube whose base faces are centered on the maxima found in a preceding area scan job within the same procedure. When the measurement is done, the Zoom Scan evaluates the averaged SAR for 1g and 10g and displays these values next to the job's label.



Zoom Scan Parameters extracted from KDB865664 d01 SAR Measurement 100MHz to 6GHz

Maximum zoom scan spatial resolution: Δx_{Zoom} , Δy_{Zoom}		≤ 2 GHz: ≤ 8 mm 2 – 3 GHz: ≤ 5 mm*	3 – 4 GHz: ≤ 5 mm* 4 – 6 GHz: ≤ 4 mm*
Maximum zoom scan spatial resolution, normal to phantom surface	uniform grid: $\Delta z_{Zoom}(n)$	≤ 5 mm	3 – 4 GHz: ≤ 4 mm 4 – 5 GHz: ≤ 3 mm 5 – 6 GHz: ≤ 2 mm
	graded grid	$\Delta z_{Zoom}(1)$: between 1 st two points closest to phantom surface	≤ 4 mm
		$\Delta z_{Zoom}(n>1)$: between subsequent points	$\leq 1.5 \cdot \Delta z_{Zoom}(n-1)$
Minimum zoom scan volume	x, y, z	≥ 30 mm	3 – 4 GHz: ≥ 28 mm 4 – 5 GHz: ≥ 25 mm 5 – 6 GHz: ≥ 22 mm
<p>Note: δ is the penetration depth of a plane-wave at normal incidence to the tissue medium; see draft standard IEEE P1528-2011 for details.</p> <p>* When zoom scan is required and the <u>reported</u> SAR from the <u>area scan based I-g SAR estimation</u> procedures of KDB 447498 is ≤ 1.4 W/kg, ≤ 8 mm, ≤ 7 mm and ≤ 5 mm zoom scan resolution may be applied, respectively, for 2 GHz to 3 GHz, 3 GHz to 4 GHz and 4 GHz to 6 GHz.</p>			

Step 4: Power Drift Measurement

The Power Drift Measurement measures the field at the same location as the most recent powerreference measurement within the same procedure, and with the same settings. The Power Drift Measurement gives the field difference in dB from the reading conducted within the same settings. This allows a user to monitor the power drift of the device under test within a batch process. The measurement procedure is the same as Step 1.

Any report having not been signed by authorized approver, or having been altered without authorization, or having not been stamped by the "Dedicated Testing/Inspection Stamp" is deemed to be invalid. Copying or excerpting portion of, or altering the content of the report is not permitted without the written authorization of AGC. The test results presented in the report apply only to the tested sample. Any objections to report issued by AGC should be submitted to AGC within 15days after the issuance of the test report. Further enquiry of validity or verification of the test report should be addressed to AGC by agc@agc-cert.com.



4.3. RF Exposure Conditions

Test Configuration and setting:

The EUT is a model of GSM Portable Mobile Station (MS). It supports GSM/GPRS/EGPRS, WCDMA/HSPA, LTE, BT, WIFI, and support hot spot mode.

For WWAN SAR testing, the device was controlled by using a base station emulator. Communication between the device and the emulator were established by air link. The distance between the EUT and the antenna is larger than 50cm, and the output power radiated from the emulator antenna is at least 30db smaller than the output power of EUT.

For WLAN testing, the EUT is configured with the WLAN continuous TX tool through engineering command.

Antenna Location: (the back view)

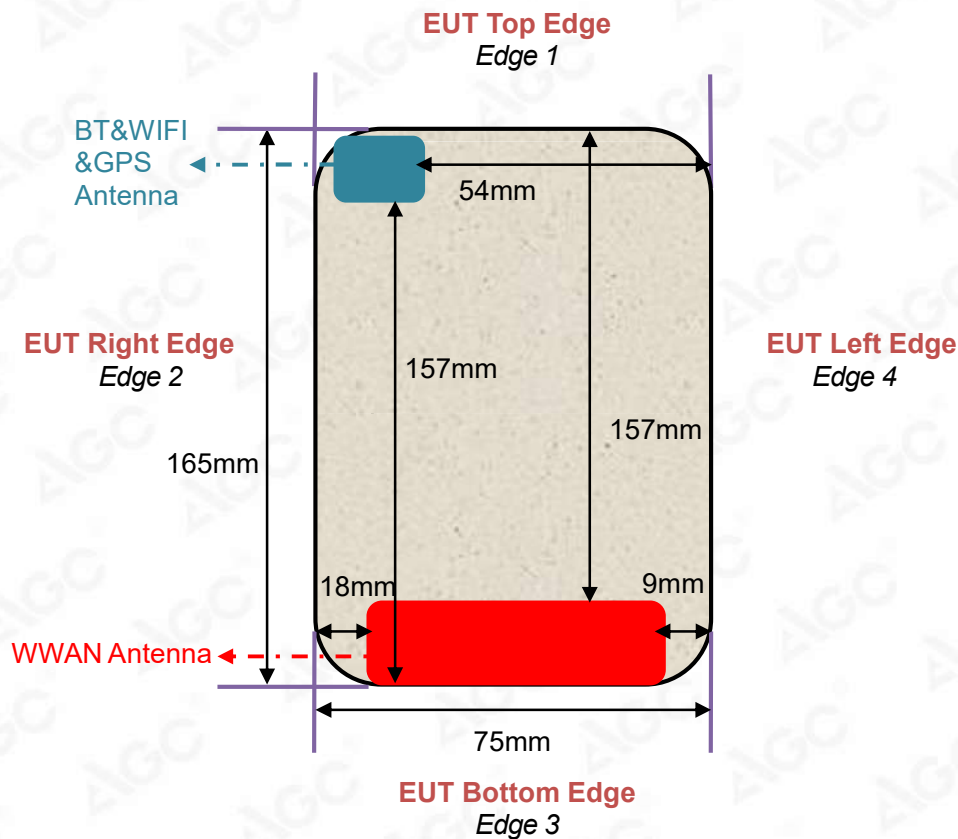

Any report having not been signed by authorized approver, or having been altered without authorization, or having not been stamped by the "Dedicated Testing/Inspection Stamp" is deemed to be invalid. Copying or excerpting portion of, or altering the content of the report is not permitted without the written authorization of AGC. The test results presented in the report apply only to the tested sample. Any objections to report issued by AGC should be submitted to AGC within 15 days after the issuance of the test report. Further enquiry of validity or verification of the test report should be addressed to AGC by agc@agc-cert.com.



For WWAN mode:

Test Configurations	Antenna to edges/surface	SAR required	Note
Head			
Left Touch		Yes	--
Left Tilt		Yes	--
Right Touch		Yes	--
Right Tilt		Yes	--
Body			
Back	<25mm	Yes	--
Front	<25mm	Yes	--
Hotspot			
Back	<25mm	Yes	--
Front	<25mm	Yes	--
Edge 1 (Top)	157mm	No	SAR is not required for the distance between the antenna and the edge is >25mm as per KDB 941225 D06 Hotspot SAR
Edge 2 (Right)	18mm	Yes	--
Edge 3 (Bottom)	1mm	Yes	--
Edge 4 (Left)	9mm	Yes	--

For WLAN mode:

Test Configurations	Antenna to edges/surface	SAR required	Note
Head			
Left Touch		Yes	--
Left Tilt		Yes	--
Right Touch		Yes	--
Right Tilt		Yes	--
Body			
Back	<25mm	Yes	--
Front	<25mm	Yes	--
Hotspot			
Back	<25mm	Yes	--
Front	<25mm	Yes	--
Edge 1 (Top)	1mm	Yes	--
Edge 2 (Right)	1mm	Yes	--
Edge 3 (Bottom)	157mm	No	SAR is not required for the distance between the antenna and the edge is >25mm as per KDB 941225 D06 Hotspot SAR
Edge 4 (Left)	54mm	No	SAR is not required for the distance between the antenna and the edge is >25mm as per KDB 941225 D06 Hotspot SAR

Any report having not been signed by authorized approver, or having been altered without authorization, or having not been stamped by the "Dedicated Testing/Inspection Stamp" is deemed to be invalid. Copying or excerpting portion of, or altering the content of the report is not permitted without the written authorization of AGC. The test results presented in the report apply only to the tested sample. Any objections to report issued by AGC should be submitted to AGC within 15 days after the issuance of the test report. Further enquiry of validity or verification of the test report should be addressed to AGC by agc@agc-cert.com.



5. TISSUE SIMULATING LIQUID

For SAR measurement of the field distribution inside the phantom, the phantom must be filled with homogeneous tissue simulating liquid to a depth of at least 15cm. For head SAR testing the liquid height from the ear reference point (ERP) of the phantom to the liquid top surface is larger than 15cm For body SAR testing, the liquid height from the center of the flat phantom to the liquid top surface is larger than 15cm. The nominal dielectric values of the tissue simulating liquids in the phantom and the tolerance of 10% are listed in 6.2

5.1. The composition of the tissue simulating liquid

Ingredient (% Weight) Frequency (MHz)	Water	Nacl	Polysorbate 20	DGBE	1,2 Propanediol	Triton X-100
750 Head	35	2	0.0	0.0	63	0.0
835 Head	50.36	1.25	48.39	0.0	0.0	0.0
1750 Head	52.64	0.36	0.0	47	0.0	0.0
1900 Head	54.9	0.18	0.0	44.92	0.0	0.0
2450 Head	71.88	0.16	0.0	7.99	0.0	19.97
2600 Head	55.242	0.306	0	44.452	0	0

Any report having not been signed by authorized approver, or having been altered without authorization, or having not been stamped by the "Dedicated Testing/Inspection Stamp" is deemed to be invalid. Copying or excerpting portion of, or altering the content of the report is not permitted without the written authorization of AGC. The test results presented in the report apply only to the tested sample. Any objections to report issued by AGC should be submitted to AGC within 15 days after the issuance of the test report. Further enquiry of validity or verification of the test report should be addressed to AGC by agc@agc-cert.com.



5.2. Tissue Dielectric Parameters for Head and Body Phantoms

The head tissue dielectric parameters recommended by the IEC 62209-1 have been incorporated in the following table. The body tissue dielectric parameters recommended by the IEC 62209-2 have been incorporated in the following table.

Target Frequency (MHz)	head		body	
	ϵ_r	σ (S/m)	ϵ_r	σ (S/m)
300	45.3	0.87	45.3	0.87
450	43.5	0.87	43.5	0.87
750	41.9	0.89	41.9	0.89
835	41.5	0.90	41.5	0.90
900	41.5	0.97	41.5	0.97
915	41.5	1.01	41.5	1.01
1450	40.5	1.20	40.5	1.20
1610	40.3	1.29	40.3	1.29
1750	40.1	1.37	40.1	1.37
1800 – 2000	40.0	1.40	40.0	1.40
2300	39.5	1.67	39.5	1.67
2450	39.2	1.80	39.2	1.80
2600	39.0	1.96	39.0	1.96
3000	38.5	2.40	38.5	2.40

(ϵ_r = relative permittivity, σ = conductivity and $\rho = 1000$ kg/m³)

Any report having not been signed by authorized approver, or having been altered without authorization, or having not been stamped by the "Dedicated Testing/Inspection Stamp" is deemed to be invalid. Copying or excerpting portion of, or altering the content of the report is not permitted without the written authorization of AGC. The test results presented in the report apply only to the tested sample. Any objections to report issued by AGC should be submitted to AGC within 15 days after the issuance of the test report. Further enquiry of validity or verification of the test report should be addressed to AGC by agc@agc-cert.com.



5.3. Tissue Calibration Result

The dielectric parameters of the liquids were verified prior to the SAR evaluation using SATIMO Dielectric Probe Kit and R&S Network Analyzer ZVL6.

Tissue Stimulant Measurement for 750MHz					
	Fr. (MHz)	Dielectric Parameters ($\pm 10\%$)		Tissue Temp [°C]	Test time
		ϵ_r 41.9 (37.71-46.09)	δ [s/m] 0.89(0.801-0.979)		
Head	704	42.05	0.87	20.9	Jan. 26, 2022
	709	41.89	0.88		
	707.5	41.89	0.88		
	710	41.67	0.89		
	711	41.67	0.89		
	750	41.44	0.90		

Tissue Stimulant Measurement for 835MHz					
	Fr. (MHz)	Dielectric Parameters ($\pm 10\%$)		Tissue Temp [°C]	Test time
		ϵ_r 41.5 (37.35-45.65)	δ [s/m] 0.90(0.81-0.99)		
Head	824.2	42.21	0.88	20.6	Jan. 20, 2022
	826.4	41.96	0.89		
	835	41.72	0.90		
	836.4	41.53	0.91		
	836.6	41.53	0.91		
	846.6	41.27	0.92		
	848.8	41.27	0.92		

Tissue Stimulant Measurement for 835MHz					
	Fr. (MHz)	Dielectric Parameters ($\pm 10\%$)		Tissue Temp [°C]	Test time
		ϵ_r 41.5 (37.35-45.65)	δ [s/m] 0.90(0.81-0.99)		
Head	829	41.69	0.88	21.8	Jan. 24, 2022
	835	41.46	0.89		
	836.5	41.35	0.90		
	844	41.08	0.91		

Tissue Stimulant Measurement for 1750MHz					
	Fr. (MHz)	Dielectric Parameters ($\pm 10\%$)		Tissue Temp [°C]	Test time
		ϵ_r 40.1 (36.09-44.11)	δ [s/m] 1.37(1.233-1.507)		
Head	1720	40.78	1.35	20.8	Jan. 21, 2022
	1732.5	40.56	1.36		
	1745	40.25	1.37		
	1750	39.94	1.38		

Any report having not been signed by authorized approver, or having been altered without authorization, or having not been stamped by the "Dedicated Testing/Inspection Stamp" is deemed to be invalid. Copying or excerpting portion of, or altering the content of the report is not permitted without the written authorization of AGC. The test results presented in the report apply only to the tested sample. Any objections to report issued by AGC should be submitted to AGC within 15 days after the issuance of the test report. Further enquiry of validity or verification of the test report should be addressed to AGC by agc@agc-cert.com.



Tissue Stimulant Measurement for 1900MHz					
	Fr. (MHz)	Dielectric Parameters ($\pm 10\%$)		Tissue Temp [°C]	Test time
		$\epsilon_r 40.00(36.00-44.00)$	$\delta [s/m] 1.40(1.26-1.54)$		
Head	1850.2	38.99	1.36	20.7	Jan. 21, 2022
	1852.4	38.99	1.36		
	1880	38.72	1.37		
	1900	38.45	1.38		
	1907.6	38.21	1.39		
	1909.8	38.21	1.39		

Tissue Stimulant Measurement for 1900MHz					
	Fr. (MHz)	Dielectric Parameters ($\pm 10\%$)		Tissue Temp [°C]	Test time
		$\epsilon_r 40.00(36.00-44.00)$	$\delta [s/m] 1.40(1.26-1.54)$		
Head	1860	39.98	1.39	21.1	Jan. 25, 2022
	1880	39.81	1.40		
	1900	39.75	1.41		

Tissue Stimulant Measurement for 2450MHz					
	Fr. (MHz)	Dielectric Parameters ($\pm 10\%$)		Tissue Temp [°C]	Test time
		$\epsilon_r 39.2(35.28-43.12)$	$\delta [s/m] 1.80(1.62-1.98)$		
Head	2402	39.74	1.76	21.2	Jan. 22, 2022
	2412	39.43	1.77		
	2437	39.16	1.78		
	2441	39.16	1.78		
	2450	38.94	1.79		
	2462	38.78	1.80		
	2480	38.52	1.81		

Tissue Stimulant Measurement for 2600MHz					
	Fr. (MHz)	Dielectric Parameters ($\pm 10\%$)		Tissue Temp [°C]	Test time
		$\epsilon_r 39(35.1-42.9)$	$\delta [s/m] 1.96(1.764-2.156)$		
Head	2510	39.06	1.92	21.2	Jan. 22, 2022
	2535	38.90	1.93		
	2560	38.72	1.94		
	2600	38.56	1.95		

Any report having not been signed by authorized approver, or having been altered without authorization, or having not been stamped by the "Dedicated Testing/Inspection Stamp" is deemed to be invalid. Copying or excerpting portion of, or altering the content of the report is not permitted without the written authorization of AGC. The test results presented in the report apply only to the tested sample. Any objections to report issued by AGC should be submitted to AGC within 15 days after the issuance of the test report. Further enquiry of validity or verification of the test report should be addressed to AGC by agc@agc-cert.com.



6. SAR SYSTEM CHECK PROCEDURE

6.1. SAR System Check Procedures

SAR system check is required to confirm measurement accuracy, according to the tissue dielectric media, probe calibration points and other system operating parameters required for measuring the SAR of a test device. The system verification must be performed for each frequency band and within the valid range of each probe calibration point required for testing the device. The same SAR probe(s) and tissue-equivalent media combinations used with each specific SAR system for system verification must be used for device testing. When multiple probe calibration points are required to cover substantially large transmission bands, independent system verifications are required for each probe calibration point. A system verification must be performed before each series of SAR measurements using the same probe calibration point and tissue-equivalent medium. Additional system verification should be considered according to the conditions of the tissue-equivalent medium and measured tissue dielectric parameters, typically every three to four days when the liquid parameters are remeasured or sooner when marginal liquid parameters are used at the beginning of a series of measurements.

Each SATIMO system is equipped with one or more system check kits. These units, together with the predefined measurement procedures within the SATIMO software, enable the user to conduct the system check and system validation. System kit includes a dipole, and dipole device holder.

The system check verifies that the system operates within its specifications. It's performed daily or before every SAR measurement. The system check uses normal SAR measurement in the flat section of the phantom with a matched dipole at a specified distance. The system check setup is shown as below.

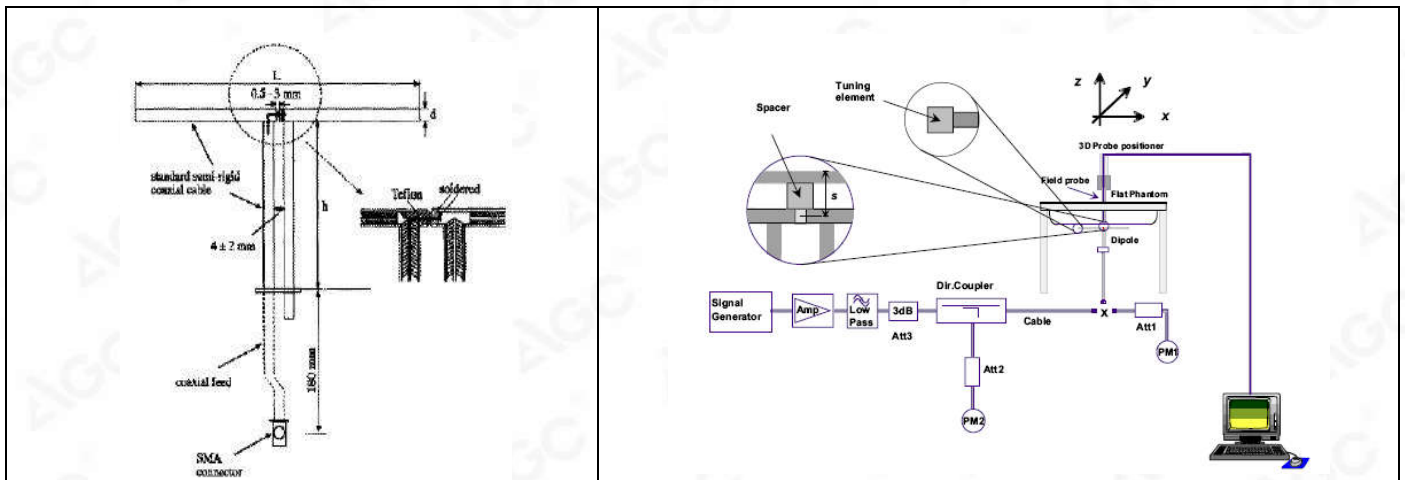

Any report having not been signed by authorized approver, or having been altered without authorization, or having not been stamped by the "Dedicated Testing/Inspection Stamp" is deemed to be invalid. Copying or excerpting portion of, or altering the content of the report is not permitted without the written authorization of AGC. The test results presented in the report apply only to the tested sample. Any objections to report issued by AGC should be submitted to AGC within 15 days after the issuance of the test report. Further enquiry of validity or verification of the test report should be addressed to AGC by agc@agc-cert.com.

6.2. SAR System Check

6.2.1. Dipoles

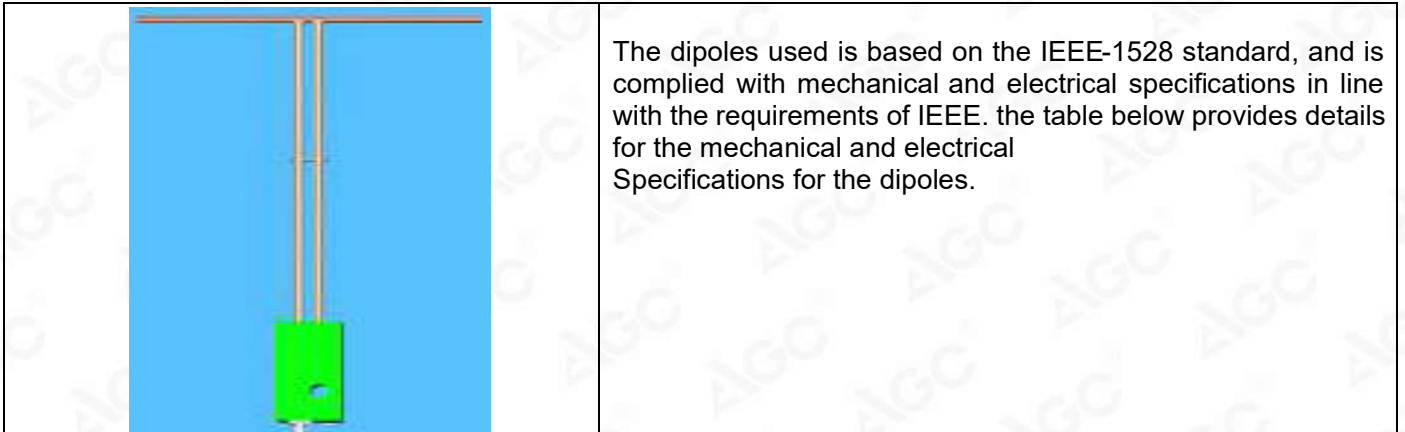

Frequency	L (mm)	h (mm)	d (mm)
750MHz	176	100	6.35
835MHz	161.0	89.8	3.6
1800MHz	71.6	41.7	3.6
1900MHz	68	39.5	3.6
2450MHz	51.5	30.4	3.6
2600MHz	48.5	28.8	3.6

Any report having not been signed by authorized approver, or having been altered without authorization, or having not been stamped by the "Dedicated Testing/Inspection Stamp" is deemed to be invalid. Copying or excerpting portion of, or altering the content of the report is not permitted without the written authorization of AGC. The test results presented in the report apply only to the tested sample. Any objections to report issued by AGC should be submitted to AGC within 15days after the issuance of the test report. Further enquiry of validity or verification of the test report should be addressed to AGC by agc@agc-cert.com.



6.2.2. System Check Result

System Performance Check at 750MHz&835MHz &1800MHz &1900MHz &2450MHz&2600MHz for Head								
Validation Kit: SN47/14 DIP 0G750-340& SN29/15 DIP 0G835-383& SN46/11 DIP 1G800-186& SN 46/11 DIP 1G900-187& SN46/11 DIP 2G450-189& SN 47/14 DIP 2G600-342								
Frequency [MHz]	Target Value(W/kg)		Reference Result ($\pm 10\%$)		Tested Value(W/kg)		Tissue Temp. [°C]	Test time
	1g	10g	1g	10g	1g	10g		
750	8.31	5.45	7.479-9.141	4.905-5.995	8.82	5.51	20.9	Jan. 26, 2022
835	9.85	6.27	8.865-10.835	5.643-6.897	10.36	6.54	20.6	Jan. 20, 2022
835	9.85	6.27	8.865-10.835	5.643-6.897	9.04	6.03	21.8	Jan. 24, 2022
1800	39.07	20.29	35.163-42.977	18.261-22.319	40.43	20.38	20.8	Jan. 21, 2022
1900	40.25	20.50	36.225-44.275	18.45-22.55	43.65	21.60	20.7	Jan. 21, 2022
1900	40.25	20.50	36.225-44.275	18.45-22.55	39.63	20.23	21.1	Jan. 25, 2022
2450	53.97	24.01	48.573-59.367	21.609-26.411	54.21	24.33	21.2	Jan. 22, 2022
2600	56.86	24.84	51.174-62.546	22.356-27.324	54.26	24.28	21.2	Jan. 22, 2022
750	8.31	5.45	7.479-9.141	4.905-5.995	8.74	5.65	20.9	Jan. 26, 2022
835	9.85	6.27	8.865-10.835	5.643-6.897	10.45	6.71	20.6	Jan. 20, 2022
835	9.85	6.27	8.865-10.835	5.643-6.897	9.99	6.29	21.8	Jan. 24, 2022
1800	39.07	20.29	35.163-42.977	18.261-22.319	37.26	18.93	20.8	Jan. 21, 2022
1900	40.25	20.50	36.225-44.275	18.45-22.55	41.37	20.53	20.7	Jan. 21, 2022
1900	40.25	20.50	36.225-44.275	18.45-22.55	40.87	20.77	21.1	Jan. 25, 2022
2450	53.97	24.01	48.573-59.367	21.609-26.411	55.35	24.75	21.2	Jan. 22, 2022
2600	56.86	24.84	51.174-62.546	22.356-27.324	53.46	23.96	21.2	Jan. 22, 2022

Note:

(1) We use a CW signal of 18dBm for system check, and then all SAR value are normalized to 1W forward power. The result must be within $\pm 10\%$ of target value.

Any report having not been signed by authorized approver, or having been altered without authorization, or having not been stamped by the "Dedicated Testing/Inspection Stamp" is deemed to be invalid. Copying or excerpting portion of, or altering the content of the report is not permitted without the written authorization of AGC. The test results presented in the report apply only to the tested sample. Any objections to report issued by AGC should be submitted to AGC within 15days after the issuance of the test report. Further enquiry of validity or verification of the test report should be addressed to AGC by agc@agc-cert.com.



7. EUT TEST POSITION

This EUT was tested in **Right Cheek, Right Tilted, Left Cheek, Left Tilted, Body back, Body front and 4 edges.**

7.1. Define Two Imaginary Lines on the Handset

- (1) The vertical centerline passes through two points on the front side of the handset: the midpoint of the width w_t of the handset at the level of the acoustic output, and the midpoint of the width w_b of the handset.
- (2) The horizontal line is perpendicular to the vertical centerline and passes through the center of the acoustic output. The horizontal line is also tangential to the face of the handset at point A.
- (3) The two lines intersect at point A. Note that for many handsets, point A coincides with the center of the acoustic output; however, the acoustic output may be located elsewhere on the horizontal line. Also note that the vertical centerline is not necessarily to the front face of the handset, especially for clamshell handsets, handsets with flip covers, and other irregularly shaped handsets.

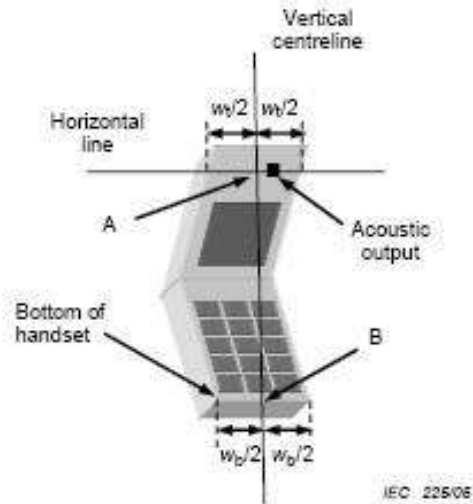
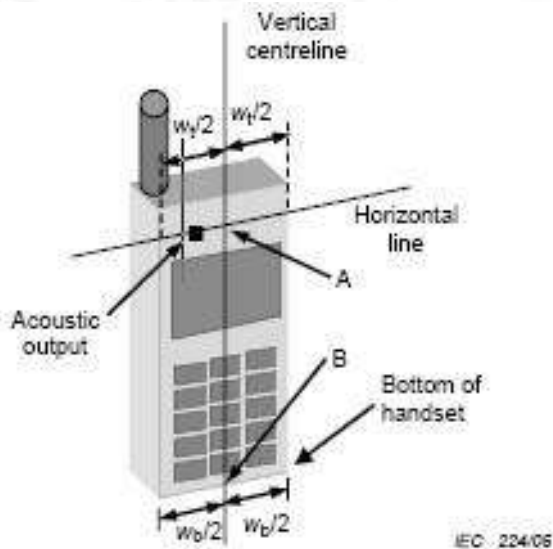

Any report having not been signed by authorized approver, or having been altered without authorization, or having not been stamped by the "Dedicated Testing/Inspection Stamp" is deemed to be invalid. Copying or excerpting portion of, or altering the content of the report is not permitted without the written authorization of AGC. The test results presented in the report apply only to the tested sample. Any objections to report issued by AGC should be submitted to AGC within 15 days after the issuance of the test report. Further enquiry of validity or verification of the test report should be addressed to AGC by agc@agc-cert.com.

7.2. Cheek Position

- (1) To position the device with the vertical center line of the body of the device and the horizontal line crossing the center piece in a plane parallel to the sagittal plane of the phantom. While maintaining the device in this plane, align the vertical center line with the reference plane containing the ear and mouth reference point (M: Mouth, RE: Right Ear, and LE: Left Ear) and align the center of the ear piece with the line RE-LE.
- (2) To move the device towards the phantom with the ear piece aligned with the the line LE-RE until the phone touched the ear. While maintaining the device in the reference plane and maintaining the phone contact with ear, move the bottom of the phone until any point on the front side is in contact with the cheek of the phantom or until contact with the ear is lost



7.3. Tilt Position

- (1) To position the device in the “cheek” position described above.
- (2) While maintaining the device in the reference plane described above and pivoting against the ear, moves it outward away from the mouth by an angle of 15 degrees or until with the ear is lost.



Any report having not been signed by authorized approver, or having been altered without authorization, or having not been stamped by the "Dedicated Testing/Inspection Stamp" is deemed to be invalid. Copying or excerpting portion of, or altering the content of the report is not permitted without the written authorization of AGC. The test results presented in the report apply only to the tested sample. Any objections to report issued by AGC should be submitted to AGC within 15days after the issuance of the test report. Further enquiry of validity or verification of the test report should be addressed to AGC by agc@agc-cert.com.

7.4. Body Worn Position

- (1) To position the EUT parallel to the phantom surface.
- (2) To adjust the EUT parallel to the flat phantom.
- (3) To adjust the distance between the EUT surface and the flat phantom to **10mm**.

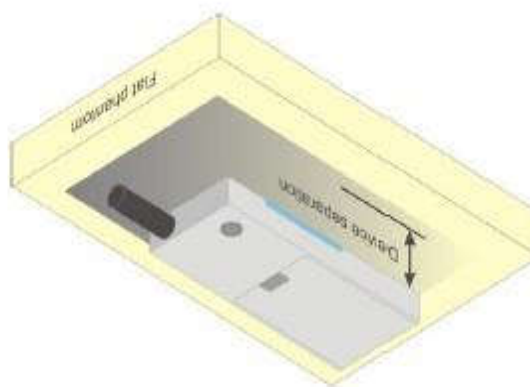
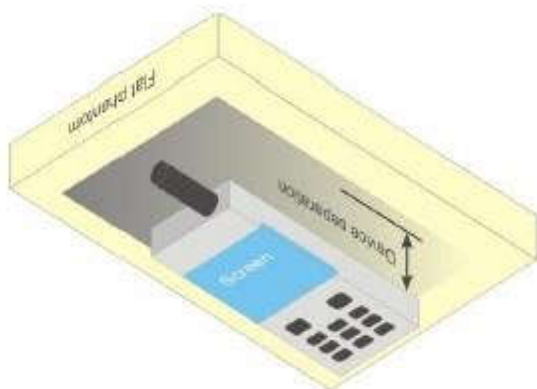

Any report having not been signed by authorized approver, or having been altered without authorization, or having not been stamped by the "Dedicated Testing/Inspection Stamp" is deemed to be invalid. Copying or excerpting portion of, or altering the content of the report is not permitted without the written authorization of AGC. The test results presented in the report apply only to the tested sample. Any objections to report issued by AGC should be submitted to AGC within 15 days after the issuance of the test report. Further enquiry of validity or verification of the test report should be addressed to AGC by agc@agc-cert.com.

Attestation of Global Compliance(Shenzhen)Co., Ltd
Attestation of Global Compliance(Shenzhen)Std & Tech Co., Ltd
Tel: +86-755 2523 4088 E-mail: agc@agc-cert.com Web: <http://cn.agc-cert.com/>



8. SAR EXPOSURE LIMITS

Limits for General Population/Uncontrolled Exposure (W/kg)

Type Exposure	Uncontrolled Environment Limit (W/kg)
Spatial Peak SAR (1g cube tissue for brain or body)	1.60
Spatial Average SAR (Whole body)	0.08
Spatial Peak SAR (Limbs)	4.0

Any report having not been signed by authorized approver, or having been altered without authorization, or having not been stamped by the "Dedicated Testing/Inspection Stamp" is deemed to be invalid. Copying or excerpting portion of, or altering the content of the report is not permitted without the written authorization of AGC. The test results presented in the report apply only to the tested sample. Any objections to report issued by AGC should be submitted to AGC within 15 days after the issuance of the test report. Further enquiry of validity or verification of the test report should be addressed to AGC by agc@agc-cert.com.

Attestation of Global Compliance(Shenzhen)Co., Ltd
Attestation of Global Compliance(Shenzhen)Std & Tech Co., Ltd
Tel: +86-755 2523 4088 E-mail: agc@agc-cert.com Web: <http://cn.agc-cert.com/>



9. TEST FACILITY

Test Site	Attestation of Global Compliance (Shenzhen) Co., Ltd
Location	1-2/F, Building 19, Junfeng Industrial Park, Chongqing Road, Heping Community, Fuhai Street, Bao'an District, Shenzhen, Guangdong, China
Designation Number	CN1259
FCC Test Firm Registration Number	975832
A2LA Cert. No.	5054.02
Description	Attestation of Global Compliance(Shenzhen) Co., Ltd is accredited by A2LA

Any report having not been signed by authorized approver, or having been altered without authorization, or having not been stamped by the "Dedicated Testing/Inspection Stamp" is deemed to be invalid. Copying or excerpting portion of, or altering the content of the report is not permitted without the written authorization of AGC. The test results presented in the report apply only to the tested sample. Any objections to report issued by AGC should be submitted to AGC within 15days after the issuance of the test report. Further enquiry of validity or verification of the test report should be addressed to AGC by agc@agc-cert.com.

Attestation of Global Compliance(Shenzhen)Co., Ltd
Attestation of Global Compliance(Shenzhen)Std & Tech Co., Ltd
Tel: +86-755 2523 4088 E-mail: agc@agc-cert.com Web: <http://cn.agc-cert.com/>



10. TEST EQUIPMENT LIST

Equipment description	Manufacturer/ Model	Identification No.	Software version	Current calibration date	Next calibration date
SAR Probe	MVG	SN 24/20 EP336	N/A	Aug. 17, 2021	Aug. 16, 2022
Phantom	SATIMO	SN_4511_SAM90	N/A	Validated. No cal required.	Validated. No cal required.
Phantom	SATIMO	SN_2316_ELLI39	N/A	Validated. No cal required.	Validated. No cal required.
Liquid	SATIMO	N/A	N/A	Validated. No cal required.	Validated. No cal required.
Comm Tester	Agilent-8960	GB46310822	A.13.07	Aug. 18,2021	Aug. 17,2022
Comm Tester	R&S- CMW500	121209	V3.7.40	Aug. 18,2021	Aug. 17,2022
Multimeter	Keithley 2000	4114939	N/A	Aug. 18,2021	Aug. 17,2022
SAR Software	MVG-OpenSAR	N/A	OpenSAR V4_02_35	N/A	N/A
Dipole	SATIMO SID750	SN47/14 DIP 0G750-340	N/A	Apr. 26,2019	Apr. 25,2022
Dipole	SATIMO SID835	SN29/15 DIP 0G835-383	N/A	Apr. 26,2019	Apr. 25,2022
Dipole	SATIMO SID1800	SN46/11 DIP 1G800-186	N/A	Apr. 26,2019	Apr. 25,2022
Dipole	SATIMO SID1900	SN 46/11 DIP 1G900-187	N/A	Apr. 26,2019	Apr. 25,2022
Dipole	SATIMO SID2450	SN46/11 DIP 2G450-189	N/A	Apr. 26,2019	Apr. 25,2022
Dipole	SATIMO SID2600	SN 47/14 DIP 2G600-342	N/A	Apr. 26,2019	Apr. 25,2022
Signal Generator	Agilent-E4438C	US41461365	V5.03	Aug. 18,2021	Aug. 17,2022
Vector Analyzer	Agilent / E4440A	MY44303916	N/A	Mar. 21,2021	Mar. 20,2022
Network Analyzer	Rhode & Schwarz ZVL6	SN101443	3.2	Oct. 28,2021	Oct. 27,2022
Attenuator	Warison /WATT-6SR1211	S/N:WRJ34AYM2F1	N/A	June 09,2021	June 08,2022
Attenuator	Mini-circuits / VAT-10+	31405	N/A	June 09,2021	June 08,2022
Amplifier	AS0104-55_55	1004793	N/A	June 10,2021	June 09,2022
Directional Couple	Werlatone/ C5571-10	SN99463	N/A	May 15,2020	May 14,2022
Directional Couple	Werlatone/ C6026-10	SN99482	N/A	May 15,2020	May 14,2022
Power Sensor	NRP-Z21	1137.6000.02	N/A	Sep. 07,2021	Sep. 06,2022
Power Sensor	NRP-Z23	100323	N/A	Feb. 17,2021	Feb. 16,2022
Power Viewer	R&S	V2.3.1.0	N/A	N/A	N/A
Calibration standard parts for network sub - port	R&S/ ZV-Z132	N/A	V2.3.1.0	Dec. 07, 2021	Dec. 06, 2022

Note: Per KDB 865664 Dipole SAR Validation, AGC Lab has adopted 3 years calibration intervals. On annual basis, every measurement dipole has been evaluated and is in compliance with the following criteria:

1. There is no physical damage on the dipole;
2. System validation with specific dipole is within 10% of calibrated value;
3. Return-loss is within 20% of calibrated measurement;
4. Impedance is within 5Ω of calibrated measurement.

Any report having not been signed by authorized approver, or having been altered without authorization, or having not been stamped by the "Dedicated Testing/Inspection Stamp" is deemed to be invalid. Copying or excerpting portion of, or altering the content of the report is not permitted without the written authorization of AGC. The test results presented in the report apply only to the tested sample. Any objections to report issued by AGC should be submitted to AGC within 15days after the issuance of the test report. Further enquiry of validity or verification of the test report should be addressed to AGC by agc@agc-cert.com.



11. MEASUREMENT UNCERTAINTY

SATIMO Uncertainty- SN 24/20 EP336									
Measurement uncertainty for DUT averaged over 1 gram / 10 gram.									
Uncertainty Component	Sec.	Tol (+-%)	Prob. Dist.	Div.	Ci (1g)	Ci (10g)	1g Ui (+-%)	10g Ui (+-%)	vi
Measurement System									
Probe calibration	E.2.1	7.000	N	1	1	1	7.000	7.000	∞
Axial Isotropy	E.2.2	0.150	R	$\sqrt{3}$	$\sqrt{0.5}$	$\sqrt{0.5}$	0.061	0.061	∞
Hemispherical Isotropy	E.2.2	0.150	R	$\sqrt{3}$	$\sqrt{0.5}$	$\sqrt{0.5}$	0.061	0.061	∞
Boundary effect	E.2.3	1.000	R	$\sqrt{3}$	1	1	0.577	0.577	∞
Linearity	E.2.4	0.610	R	$\sqrt{3}$	1	1	0.352	0.352	∞
System detection limits	E.2.4	1.000	R	$\sqrt{3}$	1	1	0.577	0.577	∞
Modulation response	E.2.5	3.000	R	$\sqrt{3}$	1	1	1.732	1.732	∞
Readout Electronics	E.2.6	0.021	N	1	1	1	0.021	0.021	∞
Response Time	E.2.7	0.000	R	$\sqrt{3}$	1	1	0.000	0.000	∞
Integration Time	E.2.8	1.400	R	$\sqrt{3}$	1	1	0.808	0.808	∞
RF ambient conditions-Noise	E.6.1	3.000	R	$\sqrt{3}$	1	1	1.732	1.732	∞
RF ambient conditions-reflections	E.6.1	3.000	R	$\sqrt{3}$	1	1	1.732	1.732	∞
Probe positioner mechanical tolerance	E.6.2	1.400	R	$\sqrt{3}$	1	1	0.808	0.808	∞
Probe positioning with respect to phantom shell	E.6.3	1.400	R	$\sqrt{3}$	1	1	0.808	0.808	∞
Extrapolation, interpolation, and integrations algorithms for max. SAR evaluation	E.5	2.300	R	$\sqrt{3}$	1	1	1.328	1.328	∞
Test sample Related									
Test sample positioning	E.4.2	2.6	N	1	1	1	2.600	2.600	∞
Device holder uncertainty	E.4.1	3	N	1	1	1	3.000	3.000	∞
Output power variation—SAR drift measurement	E.2.9	5	R	$\sqrt{3}$	1	1	2.887	2.887	∞
SAR scaling	E.6.5	5	R	$\sqrt{3}$	1	1	2.887	2.887	∞
Phantom and tissue parameters									
Phantom shell uncertainty—shape, thickness, and permittivity	E.3.1	4	R	$\sqrt{3}$	1	1	2.309	2.309	∞
Uncertainty in SAR correction for deviations in permittivity and conductivity	E.3.2	1.9	N	1	1	0.84	1.900	1.596	∞
Liquid conductivity measurement	E.3.3	2.5	R	$\sqrt{3}$	0.78	0.71	1.126	1.025	∞
Liquid permittivity measurement	E.3.3	4	N	1	0.78	0.71	3.120	2.840	M
Liquid conductivity—temperature uncertainty	E.3.4	2.5	R	$\sqrt{3}$	0.23	0.26	0.332	0.375	∞
Liquid permittivity—temperature uncertainty	E.3.4	5	N	1	0.23	0.26	1.150	1.300	M
Combined Standard			RSS				10.519	10.334	

Any report having not been signed by authorized approver, or having been altered without authorization, or having not been stamped by the "Dedicated Testing/Inspection Stamp" is deemed to be invalid. Copying or excerpting portion of, or altering the content of the report is not permitted without the written authorization of AGC. The test results presented in the report apply only to the tested sample. Any objections to report issued by AGC should be submitted to AGC within 15 days after the issuance of the test report. Further enquiry of validity or verification of the test report should be addressed to AGC by agc@agc-cert.com.

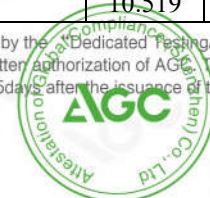

Uncertainty									
Expanded Uncertainty (95% Confidence interval)			K=2				21.039	20.668	

Any report having not been signed by authorized approver, or having been altered without authorization, or having not been stamped by the "Dedicated Testing/Inspection Stamp" is deemed to be invalid. Copying or excerpting portion of, or altering the content of the report is not permitted without the written authorization of AGC. The test results presented in the report apply only to the tested sample. Any objections to report issued by AGC should be submitted to AGC within 15 days after the issuance of the test report. Further enquiry of validity or verification of the test report should be addressed to AGC by agc@agc-cert.com.

Attestation of Global Compliance(Shenzhen)Co., Ltd
Attestation of Global Compliance(Shenzhen)Std & Tech Co., Ltd
Tel: +86-755 2523 4088 E-mail: agc@agc-cert.com Web: http://cn.agc-cert.com/



SATIMO Uncertainty- SN 24/20 EP336									
System Validation uncertainty for DUT averaged over 1 gram / 10 gram.									
Uncertainty Component	Sec.	Tol (+-%)	Prob. Dist.	Div.	Ci (1g)	Ci (10g)	1g Ui (+-%)	10g Ui (+-%)	vi
Measurement System									
Probe calibration	E.2.1	7.000	N	1	1	1	7.000	7.000	∞
Axial Isotropy	E.2.2	0.150	R	$\sqrt{3}$	1	1	0.087	0.087	∞
Hemispherical Isotropy	E.2.2	0.150	R	$\sqrt{3}$	0	0	0.000	0.000	∞
Boundary effect	E.2.3	1.000	R	$\sqrt{3}$	1	1	0.577	0.577	∞
Linearity	E.2.4	0.610	R	$\sqrt{3}$	1	1	0.352	0.352	∞
System detection limits	E.2.4	1.0	R	$\sqrt{3}$	1	1	0.58	0.58	∞
Modulation response	E.2.5	3.0	R	$\sqrt{3}$	0	0	0.00	0.00	∞
Readout Electronics	E.2.6	0.021	N	1	1	1	0.021	0.021	∞
Response Time	E.2.7	0.0	R	$\sqrt{3}$	0	0	0.00	0.00	∞
Integration Time	E.2.8	1.4	R	$\sqrt{3}$	0	0	0.00	0.00	∞
RF ambient conditions-Noise	E.6.1	3.0	R	$\sqrt{3}$	1	1	1.73	1.73	∞
RF ambient conditions-reflections	E.6.1	3.0	R	$\sqrt{3}$	1	1	1.73	1.73	∞
Probe positioner mechanical tolerance	E.6.2	1.4	R	$\sqrt{3}$	1	1	0.81	0.81	∞
Probe positioning with respect to phantom shell	E.6.3	1.4	R	$\sqrt{3}$	1	1	0.81	0.81	∞
Extrapolation, interpolation, and integrations algorithms for max. SAR evaluation	E.5	2.3	R	$\sqrt{3}$	1	1	1.33	1.33	∞
System validation source									
Deviation of experimental dipole from numerical dipole	E.6.4	5.0	N	1	1	1	5.00	5.00	∞
Input power and SAR drift measurement	8,6.6.4	5.0	R	$\sqrt{3}$	1	1	2.89	2.89	∞
Dipole axis to liquid distance	8,E.6.6	2.0	R	$\sqrt{3}$	1	1	1.15	1.15	∞
Phantom and set-up									
Phantom shell uncertainty—shape, thickness, and permittivity	E.3.1	4.0	R	$\sqrt{3}$	1	1	2.31	2.31	∞
Uncertainty in SAR correction for deviations in permittivity and conductivity	E.3.2	1.9	N	1	1	0.84	1.90	1.60	∞
Liquid conductivity (temperature uncertainty)	E.3.3	2.5	R	$\sqrt{3}$	0.78	0.71	1.13	1.02	∞
Liquid conductivity (measured)	E.3.3	4	N	1	0.78	0.71	3.12	2.84	M
Liquid permittivity (temperature uncertainty)	E.3.4	2.5	R	$\sqrt{3}$	0.23	0.26	0.33	0.38	∞
Liquid permittivity (measured)	E.3.4	5	N	1	0.23	0.26	1.15	1.30	M
Combined Standard Uncertainty			RSS				10.452	10.266	
Expanded Uncertainty (95% Confidence interval)			K=2				20.904	20.531	

Any report having not been signed by authorized approver, or having been altered without authorization, or having not been stamped by the "Dedicated Testing/Inspection Stamp" is deemed to be invalid. Copying or excerpting portion of, or altering the content of the report is not permitted without the written authorization of AGC. The test results presented in the report apply only to the tested sample. Any objections to report issued by AGC should be submitted to AGC within 15 days after the issuance of the test report. Further enquiry of validity or verification of the test report should be addressed to AGC by agc@agc-cert.com.



SATIMO Uncertainty- SN 24/20 EP336									
System Check uncertainty for DUT averaged over 1 gram / 10 gram.									
Uncertainty Component	Sec.	Tol (+-%)	Prob. Dist.	Div.	Ci (1g)	Ci (10g)	1g Ui (+-%)	10g Ui (+-%)	vi
Measurement System									
Probe calibration drift	E.2.1.3	0.5	N	1	1	1	0.50	0.50	∞
Axial Isotropy	E.2.2	0.150	R	$\sqrt{3}$	0	0	0.00	0.00	∞
Hemispherical Isotropy	E.2.2	0.150	R	$\sqrt{3}$	0	0	0.00	0.00	∞
Boundary effect	E.2.3	1.000	R	$\sqrt{3}$	0	0	0.00	0.00	∞
Linearity	E.2.4	0.610	R	$\sqrt{3}$	0	0	0.00	0.00	∞
System detection limits	E.2.4	1.0	R	$\sqrt{3}$	0	0	0.00	0.00	∞
Modulation response	E.2.5	3.0	R	$\sqrt{3}$	0	0	0.00	0.00	∞
Readout Electronics	E.2.6	0.021	N	1	0	0	0.00	0.00	∞
Response Time	E.2.7	0	R	$\sqrt{3}$	0	0	0.00	0.00	∞
Integration Time	E.2.8	1.4	R	$\sqrt{3}$	0	0	0.00	0.00	∞
RF ambient conditions-Noise	E.6.1	3.0	R	$\sqrt{3}$	0	0	0.00	0.00	∞
RF ambient conditions-reflections	E.6.1	3.0	R	$\sqrt{3}$	0	0	0.00	0.00	∞
Probe positioner mechanical tolerance	E.6.2	1.4	R	$\sqrt{3}$	1	1	0.81	0.81	∞
Probe positioning with respect to phantom shell	E.6.3	1.4	R	$\sqrt{3}$	1	1	0.81	0.81	∞
Extrapolation, interpolation, and integrations algorithms for max. SAR evaluation	E.5	2.3	R	$\sqrt{3}$	0	0	0.00	0.00	∞
System check source (dipole)									
Deviation of experimental dipoles	E.6.4	2.0	N	1	1	1	2.00	2.00	∞
Input power and SAR drift measurement	8,6.6.4	5.0	R	$\sqrt{3}$	1	1	2.89	2.89	∞
Dipole axis to liquid distance	8,E.6.6	2.0	R	$\sqrt{3}$	1	1	1.15	1.15	∞
Phantom and tissue parameters									
Phantom shell uncertainty—shape, thickness, and permittivity	E.3.1	4	R	$\sqrt{3}$	1	1	2.31	2.31	∞
Uncertainty in SAR correction for deviations in permittivity and conductivity	E.3.2	1.9	N	1	1	0.84	1.90	1.60	∞
Liquid conductivity measurement	E.3.3	2.5	R	$\sqrt{3}$	0.78	0.71	1.13	1.02	∞
Liquid permittivity measurement	E.3.3	4	N	1	0.78	0.71	3.12	2.84	M
Liquid conductivity—temperature uncertainty	E.3.4	2.5	R	$\sqrt{3}$	0.23	0.26	0.33	0.38	∞
Liquid permittivity—temperature uncertainty	E.3.4	5	N	1	0.23	0.26	1.15	1.30	M
Combined Standard Uncertainty			RSS				5.562	5.203	
Expanded Uncertainty (95% Confidence interval)			K=2				11.124	10.406	

Any report having not been signed by authorized approver, or having been altered without authorization, or having not been stamped by the "Dedicated Testing/Inspection Stamp" is deemed to be invalid. Copying or excerpting portion of, or altering the content of the report is not permitted without the written authorization of AGC. The test results presented in the report apply only to the tested sample. Any objections to report issued by AGC should be submitted to AGC within 15days after the issuance of the test report. Further enquiry of validity or verification of the test report should be addressed to AGC by agc@agc-cert.com.



12. CONDUCTED POWER MEASUREMENT GSM BAND

Mode	Frequency(MHz)	Avg. Burst Power(dBm)	Duty cycle Factor(dBm)	Frame Power(dBm)
Maximum Power <1>				
GSM 850	824.2	32.07	-9	23.07
	836.6	32.01	-9	23.01
	848.8	32.20	-9	23.20
GPRS 850 (1 Slot)	824.2	31.73	-9	22.73
	836.6	31.57	-9	22.57
	848.8	31.66	-9	22.66
GPRS 850 (2 Slot)	824.2	30.48	-6	24.48
	836.6	30.23	-6	24.23
	848.8	30.44	-6	24.44
GPRS 850 (3 Slot)	824.2	29.14	-4.26	24.88
	836.6	29.06	-4.26	24.80
	848.8	29.30	-4.26	25.04
GPRS 850 (4 Slot)	824.2	27.25	-3	24.25
	836.6	27.02	-3	24.02
	848.8	27.46	-3	24.46
EGPRS 850 (1 Slot)	824.2	26.85	-9	17.85
	836.6	26.75	-9	17.75
	848.8	26.58	-9	17.58
EGPRS 850 (2 Slot)	824.2	25.04	-6	19.04
	836.6	25.21	-6	19.21
	848.8	25.42	-6	19.42
EGPRS 850 (3 Slot)	824.2	23.07	-4.26	18.81
	836.6	23.04	-4.26	18.78
	848.8	23.11	-4.26	18.85
EGPRS 850 (4 Slot)	824.2	21.50	-3	18.50
	836.6	21.62	-3	18.62
	848.8	21.79	-3	18.79

Any report having not been signed by authorized approver, or having been altered without authorization, or having not been stamped by the "Dedicated Testing/Inspection Stamp" is deemed to be invalid. Copying or excerpting portion of, or altering the content of the report is not permitted without the written authorization of AGC. The test results presented in the report apply only to the tested sample. Any objections to report issued by AGC should be submitted to AGC within 15days after the issuance of the test report. Further enquiry of validity or verification of the test report should be addressed to AGC by agc@agc-cert.com.



GSM BAND CONTINUE

Mode	Frequency(MHz)	Avg. Burst Power(dBm)	Duty cycle Factor(dBm)	Frame Power(dBm)
Maximum Power <1>				
PCS1900	1850.2	30.29	-9	21.29
	1880	30.20	-9	21.20
	1909.8	30.05	-9	21.05
GPRS1900 (1 Slot)	1850.2	29.91	-9	20.91
	1880	29.64	-9	20.64
	1909.8	29.46	-9	20.46
GPRS1900 (2 Slot)	1850.2	27.73	-6	21.73
	1880	27.79	-6	21.79
	1909.8	27.98	-6	21.98
GPRS1900 (3 Slot)	1850.2	26.58	-4.26	22.32
	1880	26.50	-4.26	22.24
	1909.8	26.66	-4.26	22.40
GPRS1900 (4 Slot)	1850.2	25.75	-3	22.75
	1880	25.77	-3	22.77
	1909.8	25.66	-3	22.66
EGPRS1900 (1 Slot)	1850.2	25.12	-9	16.12
	1880	25.10	-9	16.10
	1909.8	25.07	-9	16.07
EGPRS1900 (2 Slot)	1850.2	24.79	-6	18.79
	1880	24.97	-6	18.97
	1909.8	24.89	-6	18.89
EGPRS1900 (3 Slot)	1850.2	22.95	-4.26	18.69
	1880	22.88	-4.26	18.62
	1909.8	22.95	-4.26	18.69
EGPRS1900 (4 Slot)	1850.2	21.95	-3	18.95
	1880	21.67	-3	18.67
	1909.8	21.91	-3	18.91

Note 1:

The Frame Power (Source-based time-averaged Power) is scaled the maximum burst average power based on time slots. The calculated methods are show as following:

- Frame Power = Max burst power (1 Up Slot) – 9 dB
- Frame Power = Max burst power (2 Up Slot) – 6 dB
- Frame Power = Max burst power (3 Up Slot) – 4.26 dB
- Frame Power = Max burst power (4 Up Slot) – 3 dB

Note 2:

SAR is not required for GPRS (1 Slot) Mode because its output power is less than of Voice Mode



**UMTS BAND
HSDPA Setup Configuration:**

- The EUT was connected to Base Station Agilent-8960 referred to the Setup Configuration.
- The RF path losses were compensated into the measurements.
- A call was established between EUT and Based Station with following setting:
 - (1) Set Gain Factors(β_c and β_d) parameters set according to each
 - (2) Set RMC 12.2Kbps+HSDPA mode.
 - (3) Set Cell Power=-86dBm
 - (4) Set HS-DSCH Configuration Type to FRC (H-set 1, QPSK)
 - (5) Select HSDPA Uplink Parameters
 - (6) Set Delta ACK, Delta NACK and Delta CQI=8
 - (7) Set Ack - Nack Repetition Factor to 3
 - (8) Set CQI Feedback Cycle (k) to 4ms
 - (9) Set CQI Repetition Factor to 2
 - (10) Power Ctrl Mode=All Up bits
- The transmitted maximum output power was recorded.

Table C.10.2.4: β values for transmitter characteristics tests with HS-DPCCH

Sub-test	β_c (Note5)	β_d	β_d (SF)	β_c/β_d	β_{HS} (Note1, Note 2)	CM (dB) (Note 3)	MPR (dB) (Note 3)
1	2/15	15/15	64	2/15	4/15	0.0	0.0
2	12/15(Note 4)	15/15(Note 4)	64	12/15(Note 4)	24/15	1.0	0.0
3	15/15	8/15	64	15/8	30/15	1.5	0.5
4	15/15	4/15	64	15/4	30/15	1.5	0.5

Note 1: $\Delta ACK, \Delta NACK$ and $\Delta CQI = 30/15$ with $\beta_{hs} = 30/15 * \beta_c$.

Note 2: For the HS-DPCCH power mask requirement test in clause 5.2C, 5.7A, and the Error Vector Magnitude (EVM) with HS-DPCCH test in clause 5.13.1A, and HSDPA EVM with phase discontinuity in clause 5.13.1AA, ΔACK and $\Delta NACK = 30/15$ with $\beta_{hs} = 30/15 * \beta_c$, and $\Delta CQI = 24/15$ with $\beta_{hs} = 24/15 * \beta_c$.

Note 3: CM = 1 for $\beta_c/\beta_d = 12/15, \beta_c/\beta_d = 15/8, \beta_c/\beta_d = 15/4$. For all other combinations of DPDCH, DPCCH and HS-DPCCH the MPR is based on the relative CM difference. This is applicable for only UEs that support HSDPA in release 6 and later releases.

Note 4: For subtest 2 the c/d ratio of 12/15 for the TFC during the measurement period (TF1, TF0) is achieved by setting the signalled gain factors for the reference TFC (TF1, TF1) to $c = 11/15$ and $d = 15/15$.

Any report having not been signed by authorized approver, or having been altered without authorization, or having not been stamped by the "Dedicated Testing/Inspection Stamp" is deemed to be invalid. Copying or excerpting portion of, or altering the content of the report is not permitted without the written authorization of AGC. The test results presented in the report apply only to the tested sample. Any objections to report issued by AGC should be submitted to AGC within 15days after the issuance of the test report. Further enquiry of validity or verification of the test report should be addressed to AGC by agc@agc-cert.com.



HSUPA Setup Configuration:

- The EUT was connected to Base Station Agilent-8960 referred to the Setup Configuration.
- The RF path losses were compensated into the measurements.
- A call was established between EUT and Base Station with following setting * :
 - (1) Call Configs = 5.2B, 5.9B, 5.10B, and 5.13.2B with QPSK
 - (2) Set the Gain Factors (β_c and β_d) and parameters (AG Index) were set according to each specific sub-test in the following table, C11.1.3, quoted from the TS 34.121
 - (3) Set Cell Power = -86 dBm
 - (4) Set Channel Type = 12.2k + HSPA
 - (5) Set UE Target Power
 - (6) Power Ctrl Mode= Alternating bits
 - (7) Set and observe the E-TFCI
 - (8) Confirm that E-TFCI is equal to the target E-TFCI of 75 for sub-test 1, and other subtest's E-TFCI
- The transmitted maximum output power was recorded.

Table C.11.1.3: β values for transmitter characteristics tests with HS-DPCCH and E-DCH

Sub-test	β_c	β_d	β_d (SF)	β_c/β_d	β_{HS} (Note 1)	β_{ec}	β_{ed} (Note 4) (Note 5)	β_{ed} (SF)	β_{ed} (Code s)	CM (dB) (Note 2)	MPR (dB) (Note 2) (Note 6)	AG Index (Note 5)	E-TF CI
1	11/15 (Note 3)	15/15 (Note 3)	64	11/15 (Note 3)	22/15	209/225	1309/225	4	1	1.0	0.0	20	75
2	6/15	15/15	64	6/15	12/15	12/15	94/75	4	1	3.0	2.0	12	67
3	15/15	9/15	64	15/9	30/15	30/15	β_{ed1} : 47/15 β_{ed2} : 47/15	4 4	2	2.0	1.0	15	92
4	2/15	15/15	64	2/15	4/15	2/15	56/75	4	1	3.0	2.0	17	71
5	15/15	0	-	-	5/15	5/15	47/15	4	1	1.0	0.0	12	67

Note 1: For sub-test 1 to 4, ΔACK , $\Delta NACK$ and $\Delta CQI = 30/15$ with $\beta_{hs} = 30/15 * \beta_c$. For sub-test 5, ΔACK , $\Delta NACK$ and $\Delta CQI = 5/15$ with $\beta_{hs} = 5/15 * \beta_c$.

Note 2: CM = 1 for $\beta_c/\beta_d = 12/15$, $hs/c = 24/15$. For all other combinations of DPDCH, DPCCH, HS-DPCCH, E-DPDCH and E-DPCCH the MPR is based on the relative CM difference.

Note 3: For subtest 1 the c/d ratio of 11/15 for the TFC during the measurement period (TF1, TF0) is achieved by setting the signalled gain factors for the reference TFC (TF1, TF1) to $c = 10/15$ and $d = 15/15$.

Note 4: In case of testing by UE using E-DPDCH Physical Layer category 1, Sub-test 3 is omitted according to TS25.306 Table 5.1g.

Note 5: β_{ed} cannot be set directly; it is set by Absolute Grant Value.

Note 6: For subtests 2, 3 and 4, UE may perform E-DPDCH power scaling at max power which could results in slightly smaller MPR values.



UMTS BAND II

Mode	Frequency (MHz)	Avg. Burst Power (dBm)
WCDMA 1900 RMC	1852.4	22.55
	1880	21.88
	1907.6	22.33
WCDMA 1900 AMR	1852.4	22.05
	1880	22.00
	1907.6	21.77
HSDPA Subtest 1	1852.4	21.20
	1880	21.07
	1907.6	20.82
HSDPA Subtest 2	1852.4	20.15
	1880	19.85
	1907.6	20.78
HSDPA Subtest 3	1852.4	20.01
	1880	20.09
	1907.6	20.01
HSDPA Subtest 4	1852.4	20.17
	1880	20.53
	1907.6	20.75
HSUPA Subtest 1	1852.4	20.46
	1880	20.19
	1907.6	20.29
HSUPA Subtest 2	1852.4	21.65
	1880	21.73
	1907.6	21.30
HSUPA Subtest 3	1852.4	21.04
	1880	20.95
	1907.6	21.04
HSUPA Subtest 4	1852.4	21.28
	1880	22.01
	1907.6	22.03
HSUPA Subtest 5	1852.4	20.96
	1880	21.66
	1907.6	21.77

Any report having not been signed by authorized approver, or having been altered without authorization, or having not been stamped by the "Dedicated Testing/Inspection Stamp" is deemed to be invalid. Copying or excerpting portion of, or altering the content of the report is not permitted without the written authorization of AGC. The test results presented in the report apply only to the tested sample. Any objections to report issued by AGC should be submitted to AGC within 15 days after the issuance of the test report. Further enquiry of validity or verification of the test report should be addressed to AGC by agc@agc-cert.com.



UMTS BAND V

Mode	Frequency (MHz)	Avg. Burst Power (dBm)
WCDMA 850 RMC	826.4	22.68
	836.4	21.97
	846.6	22.18
WCDMA 850 AMR	826.4	22.04
	836.4	22.02
	846.6	21.94
HSDPA Subtest 1	826.4	21.06
	836.4	21.07
	846.6	20.99
HSDPA Subtest 2	826.4	20.22
	836.4	20.13
	846.6	20.68
HSDPA Subtest 3	826.4	19.88
	836.4	19.91
	846.6	20.25
HSDPA Subtest 4	826.4	20.01
	836.4	20.59
	846.6	20.86
HSUPA Subtest 1	826.4	20.52
	836.4	20.21
	846.6	20.49
HSUPA Subtest 2	826.4	21.38
	836.4	21.64
	846.6	21.16
HSUPA Subtest 3	826.4	21.36
	836.4	20.97
	846.6	21.16
HSUPA Subtest 4	826.4	21.32
	836.4	22.12
	846.6	22.30
HSUPA Subtest 5	826.4	20.99
	836.4	21.57
	846.6	21.81

Any report having not been signed by authorized approver, or having been altered without authorization, or having not been stamped by the "Dedicated Testing/Inspection Stamp" is deemed to be invalid. Copying or excerpting portion of, or altering the content of the report is not permitted without the written authorization of AGC. The test results presented in the report apply only to the tested sample. Any objections to report issued by AGC should be submitted to AGC within 15 days after the issuance of the test report. Further enquiry of validity or verification of the test report should be addressed to AGC by agc@agc-cert.com.



According to 3GPP 25.101 sub-clause 6.2.2 , the maximum output power is allowed to be reduced by following the table.

Table 6.1aA: UE maximum output power with HS-DPCCH and E-DCH

UE Transmit Channel Configuration	CM(db)	MPR(db)
For all combinations of ,DPDCH,DPCCH HS-DPDCH,E-DPDCH and E-DPCCH	$0 \leq CM \leq 3.5$	MAX(CM-1,0)

Note: CM=1 for $\beta_o/\beta_d=12/15$, $\beta_{hs}/\beta_c=24/15$. For all other combinations of DPDCH, DPCCH, HS-DPCCH, E-DPDCH and E-DPCCH the MPR is based on the relative CM difference.

The device supports MPR to solve linearity issues (ACLR or SEM) due to the higher peak-to average ratios (PAR) of the HSUPA signal. This prevents saturating the full range of the TX DAC inside of device and provides a reduced power output to the RF transceiver chip according to the Cubic Metric (a function of the combinations of DPDCH, DPCCH, HS-DPCCH, E-DPDCH and E-DPCCH).

When E-DPDCH channels are present the beta gains on those channels are reduced firsts to try to get the power under the allowed limit. If the beta gains are lowered as far as possible, then a hard limiting is applied at the maximum allowed level.

The SW currently recalculates the cubic metric every time the beta gains on the E-DPDCH are reduced. The cubic metric will likely get lower each time this is done .However, there is no reported reduction of maximum output power in the HSUPA mode since the device also provides a compensation for the power back-off by increasing the gain of TX_AG in the transceiver (PA) device.

The end effect is that the DUT output power is identical to the case where there is no MPR in the device.

Any report having not been signed by authorized approver, or having been altered without authorization, or having not been stamped by the "Dedicated Testing/Inspection Stamp" is deemed to be invalid. Copying or excerpting portion of, or altering the content of the report is not permitted without the written authorization of AGC. The test results presented in the report apply only to the tested sample. Any objections to report issued by AGC should be submitted to AGC within 15days after the issuance of the test report. Further enquiry of validity or verification of the test report should be addressed to AGC by agc@agc-cert.com.



LTE Band

Conducted Power of LTE Band 2(dBm)							
Bandwidth	Modulation	RB size	RB offset	Target MPR	Channel	Channel	Channel
					18607	18900	19193
1.4MHz	QPSK	1	0	0	22.66	22.26	22.55
			3	0	22.57	22.18	22.62
			5	0	22.61	22.28	22.6
		3	0	0	22.71	22.25	22.63
			2	0	22.61	22.39	22.62
			3	0	22.61	22.42	22.64
	6	0	1	21.39	21.17	21.58	
	16QAM	1	0	1	22.29	21.13	22.48
			3	1	22.24	21.12	22.46
			5	1	22.3	20.96	22.46
		3	0	1	21.56	21.21	21.78
			2	1	21.56	21.21	21.89
			3	1	21.56	21.08	21.82
	6	0	2	20.81	20.52	21.05	
Bandwidth	Modulation	RB size	RB offset	Target MPR	Channel	Channel	Channel
					18615	18900	19185
3MHz	QPSK	1	0	0	22.48	22.31	22.44
			7	0	22.47	22.28	22.53
			14	0	22.33	22.35	22.58
		8	0	1	21.55	21.23	21.59
			4	1	21.55	21.23	21.6
			7	1	21.34	21.25	21.58
	15	0	1	21.5	21.27	21.65	
	16QAM	1	0	1	21.78	21.97	21.7
			7	1	21.83	21.96	21.63
			14	1	21.69	21.88	21.66
		8	0	2	20.83	20.41	20.9
			4	2	20.83	20.41	20.9
			7	2	20.61	20.33	20.93
	15	0	2	20.75	20.45	20.82	

Any report having not been signed by authorized approver, or having been altered without authorization, or having not been stamped by the "Dedicated Testing/Inspection Stamp" is deemed to be invalid. Copying or excerpting portion of, or altering the content of the report is not permitted without the written authorization of AGC. The test results presented in the report apply only to the tested sample. Any objections to report issued by AGC should be submitted to AGC within 15days after the issuance of the test report. Further enquiry of validity or verification of the test report should be addressed to AGC by agc@agc-cert.com.



Conducted Power of LTE Band 2(dBm)								
Bandwidth	Modulation	RB size	RB offset	Target MPR	Channel	Channel	Channel	
					18625	18900	19175	
5MHz	QPSK	1	0	0	22.52	22.49	22.59	
			13	0	22.4	22.37	22.49	
			24	0	22.33	22.44	22.53	
		12	0	1	21.58	21.33	21.6	
			6	1	21.58	21.34	21.59	
			13	1	21.44	21.25	21.61	
		25	0	1	21.22	21.27	21.63	
		16QAM	1	0	1	20.82	21.56	21.32
				13	1	20.76	21.54	21.44
	24			1	20.8	21.6	21.35	
	12		0	2	20.59	20.51	20.63	
			6	2	20.58	20.52	20.63	
			13	2	20.43	20.34	20.63	
	25	0	2	20.55	20.32	20.76		
	Bandwidth	Modulation	RB size	RB offset	Target MPR	Channel	Channel	Channel
18650						18900	19150	
10MHz	QPSK	1	0	0	22.53	22.37	22.59	
			25	0	22.3	22.41	22.55	
			49	0	22.38	22.47	22.64	
		25	0	1	21.37	21.29	21.51	
			13	1	21.37	21.29	21.52	
			25	1	21.3	21.16	21.59	
		50	0	1	21.3	21.17	21.55	
		16QAM	1	0	1	22	22.07	21.31
				25	1	21.98	22.07	21.4
	49			1	21.85	22.14	21.4	
	25		0	2	20.48	20.32	20.84	
			13	2	20.49	20.33	20.85	
			25	2	20.44	20.35	20.9	
	50		0	2	20.48	20.4	20.69	

Any report having not been signed by authorized approver, or having been altered without authorization, or having not been stamped by the "Dedicated Testing/Inspection Stamp" is deemed to be invalid. Copying or excerpting portion of, or altering the content of the report is not permitted without the written authorization of AGC. The test results presented in the report apply only to the tested sample. Any objections to report issued by AGC should be submitted to AGC within 15 days after the issuance of the test report. Further enquiry of validity or verification of the test report should be addressed to AGC by agc@agc-cert.com.



Conducted Power of LTE Band 2(dBm)								
Bandwidth	Modulation	RB size	RB offset	Target MPR	Channel	Channel	Channel	
					18675	18900	19125	
15MHz	QPSK	1	0	0	22.51	22.34	22.38	
			38	0	22.35	22.27	22.66	
			74	0	22.26	22.39	22.56	
		36	0	1	21.46	21.36	21.39	
			18	1	21.45	21.37	21.39	
			39	1	21.46	21.37	21.39	
		75	0	1	21.41	21.19	21.46	
		16QAM	1	0	1	22.07	21.5	22.08
				38	1	22.1	21.61	22.14
	74			1	21.9	22.16	22.26	
	36		0	2	20.47	20.38	20.81	
			18	2	20.55	20.39	20.82	
			39	2	20.56	20.39	20.64	
	75	0	2	20.46	20.46	20.6		
	Bandwidth	Modulation	RB size	RB offset	Target MPR	Channel	Channel	Channel
18700						18900	19100	
20MHz	QPSK	1	0	0	22.81	22.52	22.37	
			50	0	22.57	22.49	22.53	
			99	0	22.56	22.55	22.67	
		50	0	1	21.45	21.46	21.48	
			25	1	21.44	21.46	21.49	
			50	1	21.28	21.37	21.6	
		100	0	1	21.25	21.36	21.68	
		16QAM	1	0	1	21.78	21.23	22.1
				50	1	21.7	21.33	22.26
	99			1	21.63	21.38	22.38	
	50		0	2	20.5	20.44	20.59	
			25	2	20.5	20.45	20.59	
			50	2	20.4	20.58	20.71	
	100		0	2	20.59	20.47	20.61	

Any report having not been signed by authorized approver, or having been altered without authorization, or having not been stamped by the "Dedicated Testing/Inspection Stamp" is deemed to be invalid. Copying or excerpting portion of, or altering the content of the report is not permitted without the written authorization of AGC. The test results presented in the report apply only to the tested sample. Any objections to report issued by AGC should be submitted to AGC within 15 days after the issuance of the test report. Further enquiry of validity or verification of the test report should be addressed to AGC by agc@agc-cert.com.



Conducted Power of LTE Band 4(dBm)									
Bandwidth	Modulation	RB size	RB offset	Target MPR	Channel	Channel	Channel		
					19957	20175	20393		
1.4MHz	QPSK	1	0	0	22.62	22.5	22.72		
			3	0	22.78	22.52	22.62		
			5	0	22.72	22.55	22.66		
		3	0	0	22.64	22.56	22.61		
			2	0	22.64	22.55	22.6		
			3	0	22.67	22.57	22.58		
		6	0	1	22.81	21.6	21.33		
		16QAM	1	0	1	22.62	22.44	21.82	
				3	1	22.62	22.51	21.84	
	5			1	22.63	22.35	21.77		
	3		0	1	21.97	21.55	21.43		
			2	1	21.97	21.68	21.43		
			3	1	21.93	21.58	21.56		
	6		0	2	20.95	20.79	20.79		
	Bandwidth		Modulation	RB size	RB offset	Target MPR	Channel	Channel	Channel
							19965	20175	20385
	3MHz	QPSK	1	0	0	22.53	22.49	22.74	
				7	0	22.64	22.6	22.65	
14				0	22.65	22.5	22.8		
8			0	1	21.71	21.39	21.52		
			4	1	21.71	21.39	21.52		
			7	1	21.61	21.45	21.45		
15			0	1	21.74	21.51	21.41		
16QAM			1	0	1	22.01	22.44	21.85	
				7	1	22.03	22.46	21.85	
		14		1	22.03	22.46	21.79		
		8	0	2	20.98	20.68	20.81		
			4	2	20.98	20.68	20.95		
			7	2	21.02	20.75	20.86		
		15	0	2	20.94	20.85	20.7		

Any report having not been signed by authorized approver, or having been altered without authorization, or having not been stamped by the "Dedicated Testing/Inspection Stamp" is deemed to be invalid. Copying or excerpting portion of, or altering the content of the report is not permitted without the written authorization of AGC. The test results presented in the report apply only to the tested sample. Any objections to report issued by AGC should be submitted to AGC within 15days after the issuance of the test report. Further enquiry of validity or verification of the test report should be addressed to AGC by agc@agc-cert.com.



Conducted Power of LTE Band 4(dBm)								
Bandwidth	Modulation	RB size	RB offset	Target MPR	Channel	Channel	Channel	
					19975	20175	20375	
5MHz	QPSK	1	0	0	22.69	22.65	22.34	
			13	0	22.67	22.67	22.4	
			24	0	22.66	22.61	22.36	
		12	0	1	21.64	21.4	21.56	
			6	1	21.65	21.4	21.56	
			13	1	21.66	21.49	21.59	
		25	0	1	21.67	21.54	21.43	
		16QAM	1	0	1	21.23	21.82	21.06
				13	1	21.11	21.87	21.01
	24			1	21.12	21.83	21	
	12		0	2	20.84	20.65	20.36	
			6	2	20.85	20.66	20.5	
			13	2	20.87	20.74	20.45	
	25	0	2	20.87	20.55	20.6		
	Bandwidth	Modulation	RB size	RB offset	Target MPR	Channel	Channel	Channel
20000						20175	20350	
10MHz	QPSK	1	0	0	22.55	22.74	22.76	
			25	0	22.62	22.66	22.74	
			49	0	22.6	22.71	22.82	
		25	0	1	21.58	21.31	21.7	
			13	1	21.58	21.46	21.71	
			25	1	21.5	21.5	21.57	
		50	0	1	21.66	21.47	21.58	
		16QAM	1	0	1	22.1	21.87	21.22
				25	1	22	21.85	21.24
	49			1	22.02	21.75	21.38	
	25		0	2	20.83	20.79	20.63	
			13	2	20.84	20.79	20.64	
			25	2	20.72	20.78	20.64	
	50		0	2	20.65	20.86	20.63	

Any report having not been signed by authorized approver, or having been altered without authorization, or having not been stamped by the "Dedicated Testing/Inspection Stamp" is deemed to be invalid. Copying or excerpting portion of, or altering the content of the report is not permitted without the written authorization of AGC. The test results presented in the report apply only to the tested sample. Any objections to report issued by AGC should be submitted to AGC within 15 days after the issuance of the test report. Further enquiry of validity or verification of the test report should be addressed to AGC by agc@agc-cert.com.



Conducted Power of LTE Band 4(dBm)								
Bandwidth	Modulation	RB size	RB offset	Target MPR	Channel	Channel	Channel	
					20025	20175	20325	
15MHz	QPSK	1	0	0	22.7	22.69	22.61	
			38	0	22.65	22.62	22.79	
			74	0	22.68	22.6	22.73	
		36	0	1	21.48	21.54	21.66	
			18	1	21.47	21.55	21.79	
			39	1	21.46	21.55	21.66	
		75	0	1	21.61	21.41	21.6	
		16QAM	1	0	1	22.45	21.82	22.09
				38	1	22.33	21.83	22.2
	74			1	22.36	21.81	22.07	
	36		0	2	20.77	20.71	20.61	
			18	2	20.76	20.72	20.62	
			39	2	20.77	20.73	20.61	
	75	0	2	20.69	20.63	20.61		
	Bandwidth	Modulation	RB size	RB offset	Target MPR	Channel	Channel	Channel
20050						20175	20300	
20MHz	QPSK	1	0	0	23.02	23.03	22.74	
			50	0	22.78	22.69	22.56	
			99	0	22.93	22.8	22.68	
		50	0	1	21.76	21.69	21.42	
			25	1	21.76	21.69	21.43	
			50	1	21.44	21.42	21.47	
		100	0	1	21.75	21.53	21.52	
		16QAM	1	0	1	21.79	21.86	22.37
				50	1	21.78	21.84	22.69
	99			1	21.66	21.71	22.41	
	50		0	2	20.84	20.66	20.59	
			25	2	20.85	20.67	20.61	
			50	2	20.78	20.68	20.65	
	100		0	2	20.66	20.63	20.83	

Any report having not been signed by authorized approver, or having been altered without authorization, or having not been stamped by the "Dedicated Testing/Inspection Stamp" is deemed to be invalid. Copying or excerpting portion of, or altering the content of the report is not permitted without the written authorization of AGC. The test results presented in the report apply only to the tested sample. Any objections to report issued by AGC should be submitted to AGC within 15days after the issuance of the test report. Further enquiry of validity or verification of the test report should be addressed to AGC by agc@agc-cert.com.



Conducted Power of LTE Band 5(dBm)									
Bandwidth	Modulation	RB size	RB offset	Target MPR	Channel	Channel	Channel		
					20407	20525	20643		
1.4MHz	QPSK	1	0	0	23.04	22.99	23.18		
			3	0	23.08	23	23.22		
			5	0	23.06	23.06	23.2		
		3	0	0	22.92	23.03	23.11		
			2	0	23.03	23.02	23.09		
			3	0	23.07	23	23.03		
		6	0	1	21.85	21.98	21.91		
		16QAM	1	0	1	22.77	22.8	21.75	
				3	1	22.64	22.69	21.93	
	5			1	22.76	22.66	21.65		
	3		0	1	22.3	22.06	21.78		
			2	1	22.29	22.06	21.68		
			3	1	22.35	22.04	21.69		
	6		0	2	21.38	21.37	21.58		
	Bandwidth		Modulation	RB size	RB offset	Target MPR	Channel	Channel	Channel
							20415	20525	20635
	3MHz	QPSK	1	0	0	22.8	23.02	23.22	
				7	0	23	23.05	23.14	
14				0	23.06	23.03	23.19		
8			0	1	21.97	21.97	22.11		
			4	1	21.97	21.97	22.11		
			7	1	21.9	21.92	21.96		
15			0	1	21.93	22	21.91		
16QAM			1	0	1	22.2	22.75	21.95	
				7	1	22.17	22.77	21.97	
		14		1	22.25	22.71	21.83		
		8	0	2	21.22	21.15	21.24		
			4	2	21.37	21.16	21.25		
			7	2	21.31	21.4	21.34		
		15	0	2	21.13	21.44	21.13		

Any report having not been signed by authorized approver, or having been altered without authorization, or having not been stamped by the "Dedicated Testing/Inspection Stamp" is deemed to be invalid. Copying or excerpting portion of, or altering the content of the report is not permitted without the written authorization of AGC. The test results presented in the report apply only to the tested sample. Any objections to report issued by AGC should be submitted to AGC within 15 days after the issuance of the test report. Further enquiry of validity or verification of the test report should be addressed to AGC by agc@agc-cert.com.



Conducted Power of LTE Band 5(dBm)								
Bandwidth	Modulation	RB size	RB offset	Target MPR	Channel	Channel	Channel	
					20425	20525	20625	
5MHz	QPSK	1	0	0	22.89	23.08	23.21	
			13	0	22.88	23.22	23.02	
			24	0	22.93	23.2	23.08	
		12	0	1	21.87	22.03	22.16	
			6	1	21.87	22.03	22.16	
			13	1	21.99	21.93	22.14	
		25	0	1	21.97	22.04	22.05	
		16QAM	1	0	1	21.49	22.15	21.75
				13	1	21.47	22.25	21.77
	24			1	21.54	22.43	21.59	
	12		0	2	21.12	21	21.31	
			6	2	21.13	21.02	21.31	
			13	2	21.1	21.36	20.92	
	25	0	2	21.09	21.29	21.23		
	Bandwidth	Modulation	RB size	RB offset	Target MPR	Channel	Channel	Channel
20450						20525	20600	
10MHz	QPSK	1	0	0	23.01	23.35	23.25	
			25	0	23	23.19	23	
			49	0	23.07	23.31	23.05	
		25	0	1	21.88	22.03	22.26	
			13	1	21.88	22.03	22.16	
			25	1	21.94	22.18	22.11	
		50	0	1	22.04	22.06	22.19	
		16QAM	1	0	1	22.38	22.37	21.89
				25	1	22.31	22.33	22.11
	49			1	22.32	22.27	21.71	
	25		0	2	21.18	21.44	21.19	
			13	2	21.18	21.29	21.21	
			25	2	21.04	21.41	21.32	
	50		0	2	21.37	21.42	21.4	

Any report having not been signed by authorized approver, or having been altered without authorization, or having not been stamped by the "Dedicated Testing/Inspection Stamp" is deemed to be invalid. Copying or excerpting portion of, or altering the content of the report is not permitted without the written authorization of AGC. The test results presented in the report apply only to the tested sample. Any objections to report issued by AGC should be submitted to AGC within 15days after the issuance of the test report. Further enquiry of validity or verification of the test report should be addressed to AGC by agc@agc-cert.com.



Conducted Power of LTE Band 7 (dBm)							
Bandwidth	Modulation	RB size	RB offset	Target MPR	Channel	Channel	Channel
					20775	21100	21425
5MHz	QPSK	1	0	0	22.03	22.18	21.76
			12	0	22.07	22.03	21.86
			24	0	21.99	22.13	21.71
		12	0	1	21.02	21.01	20.87
			6	1	21.01	21.01	20.87
			13	1	21.1	20.98	20.9
	25	0	1	20.91	20.98	20.93	
	16QAM	1	0	1	20.26	21.22	20.62
			12	1	20.5	21.26	20.63
			24	1	20.52	21.08	20.67
		12	0	2	19.96	20.2	19.99
			6	2	19.96	20.21	19.94
			13	2	20.04	20.19	20.04
	25	0	2	20.15	20.08	20.11	
	Bandwidth	Modulation	RB size	RB offset	Target MPR	Channel	Channel
20800						21100	21400
10MHz	QPSK	1	0	0	21.42	21.73	21.74
			24	0	21.19	21.72	21.6
			49	0	21.45	21.7	21.95
		25	0	1	20.75	20.6	20.43
			12	1	20.75	20.6	20.43
			25	1	20.59	20.62	20.49
	50	0	1	20.5	20.52	20.61	
	16QAM	1	0	1	20.83	20.99	20.46
			24	1	20.82	20.83	20.5
			49	1	20.86	20.84	20.5
		25	0	2	19.63	19.91	19.86
			12	2	19.64	19.92	19.87
			25	2	19.64	19.84	19.91
	50	0	2	19.8	19.88	19.64	

Any report having not been signed by authorized approver, or having been altered without authorization, or having not been stamped by the "Dedicated Testing/Inspection Stamp" is deemed to be invalid. Copying or excerpting portion of, or altering the content of the report is not permitted without the written authorization of AGC. The test results presented in the report apply only to the tested sample. Any objections to report issued by AGC should be submitted to AGC within 15days after the issuance of the test report. Further enquiry of validity or verification of the test report should be addressed to AGC by agc@agc-cert.com.



Conducted Power of LTE Band 7 (dBm)

Bandwidth	Modulation	RB size	RB offset	Target MPR	Channel	Channel	Channel
					20825	21100	21375
15MHz	QPSK	1	0	0	21.76	21.84	21.61
			37	0	21.66	21.77	21.65
			74	0	21.57	21.58	21.63
		37	0	1	20.77	20.62	20.51
			16	1	20.78	20.62	20.51
			35	1	20.63	20.62	20.51
	75	0	1	20.59	20.66	20.66	
	16QAM	1	0	1	21.06	21.09	21.35
			37	1	21.22	21.12	21.3
			74	1	21.33	21.15	21.41
		37	0	2	19.76	19.76	19.8
			16	2	19.88	19.77	19.81
			35	2	19.77	19.77	19.81
	75	0	2	19.99	19.73	19.71	
Bandwidth	Modulation	RB size	RB offset	Target MPR	Channel	Channel	Channel
					20850	21100	21350
20MHz	QPSK	1	0	0	21.79	22.17	21.69
			49	0	21.77	22.04	21.58
			99	0	21.87	22	21.65
		50	0	1	20.7	20.75	20.56
			25	1	20.7	20.75	20.56
			49	1	20.86	20.5	20.4
	100	0	1	20.65	20.62	20.59	
	16QAM	1	0	1	20.58	21.12	21.46
			49	1	20.69	21.17	21.39
			99	1	20.73	21.01	21.48
		50	0	2	19.81	19.86	19.73
			25	2	19.81	19.87	19.74
			49	2	19.78	19.82	19.76
	100	0	2	19.81	19.69	19.81	

Any report having not been signed by authorized approver, or having been altered without authorization, or having not been stamped by the "Dedicated Testing/Inspection Stamp" is deemed to be invalid. Copying or excerpting portion of, or altering the content of the report is not permitted without the written authorization of AGC. The test results presented in the report apply only to the tested sample. Any objections to report issued by AGC should be submitted to AGC within 15days after the issuance of the test report. Further enquiry of validity or verification of the test report should be addressed to AGC by agc@agc-cert.com.



Conducted Power of LTE Band 12(dBm)								
Bandwidth	Modulation	RB size	RB offset	Target MPR	Channel	Channel	Channel	
					23017	23095	23173	
1.4MHz	QPSK	1	0	0	23.25	23.2	23.09	
			3	0	23.11	23.34	23.03	
			5	0	23.27	23.27	23.07	
		3	0	0	23.28	23.19	23.14	
			2	0	23.24	23.18	23.13	
			3	0	23.2	23.18	23.02	
		6	0	1	21.31	22.07	21.96	
		16QAM	1	0	1	22.54	22.23	21.83
				3	1	22.56	22.27	22.02
	5			1	22.6	22.33	21.94	
	3		0	1	22.36	22.14	21.99	
			2	1	22.2	22.29	21.98	
	3		1	22.32	22.32	22.09		
	6	0	2	21.11	21.5	21.34		
	Bandwidth	Modulation	RB size	RB offset	Target MPR	Channel	Channel	Channel
23025						23095	23165	
3MHz	QPSK	1	0	0	23.24	23.08	23.13	
			7	0	23.11	23.21	23.21	
			14	0	23.14	23.21	23.12	
		8	0	1	22.04	22.06	21.9	
			4	1	22.03	22.06	21.9	
			7	1	22.23	22.12	21.97	
		15	0	1	22.18	22.02	22.01	
		16QAM	1	0	1	22.29	22.68	21.92
				7	1	22.3	22.84	21.66
	14			1	22.2	22.76	21.97	
	8		0	2	21.19	21.03	21.55	
			4	2	21.19	21.04	21.56	
			7	2	21.46	21.46	21.29	
	15		0	2	21.22	21.49	21.47	

Any report having not been signed by authorized approver, or having been altered without authorization, or having not been stamped by the "Dedicated Testing/Inspection Stamp" is deemed to be invalid. Copying or excerpting portion of, or altering the content of the report is not permitted without the written authorization of AGC. The test results presented in the report apply only to the tested sample. Any objections to report issued by AGC should be submitted to AGC within 15days after the issuance of the test report. Further enquiry of validity or verification of the test report should be addressed to AGC by agc@agc-cert.com.



Conducted Power of LTE Band 12(dBm)								
Bandwidth	Modulation	RB size	RB offset	Target MPR	Channel	Channel	Channel	
					23035	23095	23155	
5MHz	QPSK	1	0	0	23.26	23.09	23.06	
			13	0	23.09	23.29	23.04	
			24	0	23.06	23.23	22.91	
		12	0	1	22.31	22.11	22.13	
			6	1	22.31	22.11	22.13	
			13	1	22.09	22.14	21.97	
		25	0	1	22.06	21.99	21.83	
		16QAM	1	0	1	21.31	22.06	21.66
				13	1	21.28	22.13	21.6
	24			1	21.37	22.19	21.75	
	12		0	2	21.05	21	21.23	
			6	2	21.06	21.01	21.23	
			13	2	21.32	21.45	21.2	
	25	0	2	21.47	21.33	21.34		
	Bandwidth	Modulation	RB size	RB offset	Target MPR	Channel	Channel	Channel
23060						23095	23130	
10MHz	QPSK	1	0	0	23.17	23.32	23.17	
			25	0	23.04	23.28	23.31	
			49	0	22.99	23.28	23.28	
		25	0	1	22.35	22.08	22.09	
			13	1	22.35	22.08	22.09	
			25	1	22.19	22.17	21.94	
		50	0	1	21.99	21.95	21.9	
		16QAM	1	0	1	22.1	22.22	21.75
				25	1	22.14	22.32	21.68
	49			1	22.18	22.4	21.85	
	25		0	2	21.25	21	21.39	
			13	2	21.25	21.01	21.4	
			25	2	20.94	21.58	21.44	
	50		0	2	21.14	21.54	21.43	

Any report having not been signed by authorized approver, or having been altered without authorization, or having not been stamped by the "Dedicated Testing/Inspection Stamp" is deemed to be invalid. Copying or excerpting portion of, or altering the content of the report is not permitted without the written authorization of AGC. The test results presented in the report apply only to the tested sample. Any objections to report issued by AGC should be submitted to AGC within 15days after the issuance of the test report. Further enquiry of validity or verification of the test report should be addressed to AGC by agc@agc-cert.com.



Conducted Power of LTE Band 17(dBm)									
Bandwidth	Modulation	RB size	RB offset	Target MPR	Channel	Channel	Channel		
					23755	23790	23825		
5MHz	QPSK	1	0	0	23.14	23.06	22.96		
			13	0	22.93	23.08	23.03		
			24	0	23.07	23.18	22.91		
		12	0	1	21.98	21.91	21.95		
			6	1	21.98	21.91	21.95		
			13	1	22	21.89	21.82		
		25	0	1	22.09	21.94	22		
		16QAM	1	0	1	21.36	22.17	21.7	
				13	1	21.33	22.13	21.48	
	24			1	21.39	22.12	21.65		
	12		0	2	20.99	21.44	21.26		
			6	2	21	21.45	21.24		
			13	2	21.42	21.44	21.23		
	25		0	2	21.14	21.37	21.24		
	Bandwidth		Modulation	RB size	RB offset	Target MPR	Channel	Channel	Channel
							23780	23790	23800
	10MHz	QPSK	1	0	0	23	22.96	23.06	
				25	0	23.03	23.02	23.13	
49				0	23	22.95	23.26		
25			0	1	22.04	21.84	21.86		
			13	1	21.91	21.84	21.86		
			25	1	21.95	21.96	21.78		
50			0	1	21.93	21.92	22.05		
16QAM			1	0	1	22.08	22.25	21.75	
				25	1	22.16	22.14	21.68	
		49		1	21.97	22.14	21.85		
		25	0	2	20.96	21.45	21.39		
			13	2	20.97	21.46	21.4		
			25	2	21.27	21.43	21.44		
		50	0	2	21.34	21.47	21.29		

Any report having not been signed by authorized approver, or having been altered without authorization, or having not been stamped by the "Dedicated Testing/Inspection Stamp" is deemed to be invalid. Copying or excerpting portion of, or altering the content of the report is not permitted without the written authorization of AGC. The test results presented in the report apply only to the tested sample. Any objections to report issued by AGC should be submitted to AGC within 15days after the issuance of the test report. Further enquiry of validity or verification of the test report should be addressed to AGC by agc@agc-cert.com.



The following tests were conducted according to the test requirements outlined in section 6.2 of the 3GPP TS36.101 specification.

UE Power Class: 3 (23 +/- 2dBm). The allowed Maximum Power Reduction (MPR) for the maximum output power due to higher order modulation and transmit bandwidth configuration (resource blocks) is specified in Table 6.2.33-1 of the 3GPP TS36.101.

Table 6.2.33-1 Maximum Power Reduction (MPR) for Power class3

Modulation	Maximum Power Reduction (MPR) for Power[RB]						MPR(dB)
	1.4MHz	3MHz	5MHz	10MHz	15MHz	20MHz	
QPSK	>5	>4	>8	>12	>16	>18	≤1
16QAM	≤5	≤4	≤8	≤12	≤16	≤18	≤1
16QAM	>5	>4	>8	>12	>16	>18	≤2

The allowed A-MPR values specified below in Table 6.2.43-1 of 3GPP TS36.101 are in addition to the allowed MPR requirements. All the measurements below were performed with A-MPR disabled, by using Network Signaling Value of "NS_01".3

Any report having not been signed by authorized approver, or having been altered without authorization, or having not been stamped by the "Dedicated Testing/Inspection Stamp" is deemed to be invalid. Copying or excerpting portion of, or altering the content of the report is not permitted without the written authorization of AGC. The test results presented in the report apply only to the tested sample. Any objections to report issued by AGC should be submitted to AGC within 15days after the issuance of the test report. Further enquiry of validity or verification of the test report should be addressed to AGC by agc@agc-cert.com.



Table 6.2.4.3-1: Additional Maximum Power Reduction (A-MPR) / Spectrum Emission requirements

Network Signaling value	Requirements (sub-clause)	E-UTRA Band	Channel bandwidth (MHz)	Resources Blocks (N_{RB})	A-MPR (dB)
NS_01	6.6.2.1.1	Table 5.2-1	1,4,3,5,10,15,20	Table 5.4.2-1	N/A
NS_03	6.6.2.2.3.1	2,4,10, 23, 25,35,36	3	>5	≤ 1
			5	>6	≤ 1
			10	>6	≤ 1
			15	>8	≤ 1
			20	>10	≤ 1
NS_04	6.6.2.2.3.2	41	5	>6	≤ 1
			10, 15, 20	Table 6.2.4.3-4	
NS_05	6.6.3.3.3.1	1	10,15,20	≥ 50	≤ 1
NS_06	6.6.2.2.3.3	12, 13, 14, 17	1.4, 3, 5, 10	Table 5.4.2-1	N/A
NS_07	6.6.2.2.3.3 6.6.3.3.3.2	13	10	Table 6.2.4.3-2	Table 6.2.4.3-2
NS_08	6.6.3.3.3.3	19	10, 15	> 44	≤ 3
NS_09	6.6.3.3.3.4	21	10, 15	> 40	≤ 1
				> 55	≤ 2
				Table 6.2.4.3-3	
NS_10		20	15, 20	Table 6.2.4.3-3	Table 6.2.4.3-3
NS_11	6.6.2.2.1 6.6.3.3.13	231	1.4, 3, 5, 10,15,20	Table 6.2.4.3-5	Table 6.2.4.3-5
NS_12	6.6.3.3.5	26	1.4, 3, 5	Table 6.2.4.3-6	Table 6.2.4.3-6
NS_13	6.6.3.3.6	26	5	Table 6.2.4.3-7	Table 6.2.4.3-7
NS_14	6.6.3.3.7	26	10, 15	Table 6.2.4.3-8	Table 6.2.4.3-8
NS_15	6.6.3.3.8	26	1.4, 3, 5, 10, 15	Table 6.2.4.3-9 Table 6.2.4.3-10	Table 6.2.4.3-9, Table 6.2.4.3-10
NS_16	6.6.3.3.9	27	3, 5, 10	Table 6.2.4.3-11, Table 6.2.4.3-12, Table 6.2.4.3-13	
NS_17	6.6.3.3.10 6.6.3.3.11	28 28	5, 10	Table 5.4.2-1	N/A
			5	≥ 2	≤ 1
NS_18			10, 15, 20	≥ 1	≤ 4
NS_19			10, 15, 20	Table 6.2.4.3-15	Table 6.2.4.3-15
NS_20			5, 10, 15, 20	Table 6.2.4.3-14	Table 6.2.4.3-14
...					
NS_20	-	-	-	-	-

Any report having not been signed by authorized approver, or having been altered without authorization, or having not been stamped by the "Dedicated Testing/Inspection Stamp" is deemed to be invalid. Copying or excerpting portion of, or altering the content of the report is not permitted without the written authorization of AGC. The test results presented in the report apply only to the tested sample. Any objections to report issued by AGC should be submitted to AGC within 15 days after the issuance of the test report. Further enquiry of validity or verification of the test report should be addressed to AGC by agc@agc-cert.com.



WIFI

Mode	Data Rate (Mbps)	Channel	Frequency(MHz)	Avg. Burst Power(dBm)
802.11b	1	01	2412	10.48
		06	2437	12.06
		11	2462	10.56
802.11g	6	01	2412	12.27
		06	2437	14.63
		11	2462	12.49
802.11n(20)	6.5	01	2412	11.35
		06	2437	14.21
		11	2462	11.72

Bluetooth_V4.2(BR/EDR)

Modulation	Channel	Frequency(MHz)	Peak Power (dBm)
GFSK	0	2402	4.19
	39	2441	3.83
	78	2480	1.59
π /4-DQPSK	0	2402	5.11
	39	2441	4.31
	78	2480	2.13
8-DPSK	0	2402	5.47
	39	2441	4.62
	78	2480	2.23

Bluetooth_V4.2(BLE)

Modulation	Channel	Frequency(MHz)	Peak Power (dBm)
GFSK	0	2402	-2.81
	19	2440	-2.58
	39	2480	-4.51

Any report having not been signed by authorized approver, or having been altered without authorization, or having not been stamped by the "Dedicated Testing/Inspection Stamp" is deemed to be invalid. Copying or excerpting portion of, or altering the content of the report is not permitted without the written authorization of AGC. The test results presented in the report apply only to the tested sample. Any objections to report issued by AGC should be submitted to AGC within 15days after the issuance of the test report. Further enquiry of validity or verification of the test report should be addressed to AGC by agc@agc-cert.com.



13. TEST RESULTS

13.1. SAR Test Results Summary

13.1.1. Test position and configuration

Head SAR was performed with the device configured in the positions according to IEEE 1528-2013, Body-worn and 4 Edges SAR was performed with the device 10mm from the phantom.

13.1.2. Operation Mode

1. Per KDB 447498 D04 v01 ,for each exposure position, if the highest 1-g SAR is ≤ 0.8 W/kg, testing for low and high channel is optional.
2. Per KDB 865664 D01 v01r04,for each frequency band, if the measured SAR is ≥ 0.8 W/kg, testing for repeated SAR measurement is required , that the highest measured SAR is only to be tested. When the SAR results are near the limit, the following procedures are required for each device to verify these types of SAR measurement related variation concerns by repeating the highest measured SAR configuration in each frequency band.
 - (1) When the original highest measured SAR is ≥ 0.8 W/kg, repeat that measurement once.
 - (2) Perform a second repeated measurement only if the ratio of largest to smallest SAR forthe original and first repeated measurements is >1.20 or when the original or repeated measurement is ≥ 1.45 W/kg.
 - (3) Perform a third repeated measurement only if the original, first and second repeated measurement is ≥ 1.5 W/kg and ratio of largest to smallest SAR for the original, first and second measurement is ≥ 1.20 .
3. Body-worn exposure conditions are intended to voice call operations, therefore GSM voice call mode is selected to be test.
4. Per KDB 648474 D04 v01r03,when the reported SAR for a body-worn accessory measured without a headset connected to the handset is ≤ 1.2 W/kg, SAR testing with a headset connected is not required.
5. Per KDB 248227 D01v02r02,for 2.4GHz 802.11g/n SAR testing is not required when the highest reported SAR for DSSS is adjusted by the ratio of OFDM to DSSS specified maximum output power and the adjusted SAR is ≤ 1.2 W/kg.
6. Per KDB 941225 D06 V02r01, When the same wireless mode transmission configurations for voice and data are required for SAR measurements, the more conservative configuration with a smaller separation distance should be tested for the overlapping SAR configurations.
7. Maximum Scaling SAR in order to calculate the Maximum SAR values to test under the standard Peak Power, Calculation method is as follows:
Maximum Scaling SAR =tested SAR (Max.) \times [maximum turn-up power (mw)/ maximum measurement output power(mw)]
8. Proximity sensor, just for avoiding the wrong operation in the phone screen when call, and has no influence on output power or SAR result
9. Per KDB 941225 D05v02r05, start with the largest channel bandwidth and measure SAR for QPSK with 1RB allocation using the RB offset and required test channel combination with highest maximum output power for RB offsets at the upper edge, middle and lower edge of each required test channel.
10. Per KDB 941125 D05v02r05, 50% RB allocation for QPSK SAR testing follows 1RB QPSK allocation procedure.
11. Per KDB 941125 D05v02r05. For QPSK with 100% RB allocation. SAR is not required when the highest maximum output power for 100% RB allocation is less than the highest maximum output power in 50% and

Any report having not been signed by authorized approver, or having been altered without authorization, or having not been stamped by the "Dedicated Testing/Inspection Stamp" is deemed to be invalid. Copying or excerpting portion of, or altering the content of the report is not permitted without the written authorization of AGC. The test results presented in the report apply only to the tested sample. Any objections to report issued by AGC should be submitted to AGC within 15days after the issuance of the test report. Further enquiry of validity or verification of the test report should be addressed to AGC by agc@agc-cert.com.



1RB allocation and the highest reported SAR is >1.45 W/kg, the remaining required test channels must also be tested.

12. Per KDB 941125 D05v02r05. 16QAM output power for each RB allocation configuration is not 1/2 dB higher than the same configuration in QPSK and the reported SAR for the QPSK configuration is ≤ 1.45 W/kg, Per KDB 941225 D05v02r05, 16QAM SAR testing is not required.
13. Per KDB 941125 D05v02r05. Smaller bandwidth output power for each RB allocation configuration is $>$ not 1/2 dB higher than the same configuration in the largest supported bandwidth, and the reported SAR for the largest supported bandwidth is ≤ 1.45 W/kg. Per KDB 941125 D05v02r05, smaller bandwidth SAR testing is not required.

Any report having not been signed by authorized approver, or having been altered without authorization, or having not been stamped by the "Dedicated Testing/Inspection Stamp" is deemed to be invalid. Copying or excerpting portion of, or altering the content of the report is not permitted without the written authorization of AGC. The test results presented in the report apply only to the tested sample. Any objections to report issued by AGC should be submitted to AGC within 15days after the issuance of the test report. Further enquiry of validity or verification of the test report should be addressed to AGC by agc@agc-cert.com.



13.1.3. Test Result

SAR MEASUREMENT									
Depth of Liquid (cm):>15					Relative Humidity (%): 54.3				
Product: Smart phone									
Test Mode: GSM850 with GMSK modulation									
Position	Mode	Ch.	Fr. (MHz)	Power Drift ($\pm 5\%$)	SAR (1g) (W/kg)	Max. Tune-up Power (dBm)	Meas. output Power (dBm)	Scaled SAR (W/kg)	Limit (W/kg)
SIM 1 Card									
Left Cheek	voice	190	836.6	0.05	0.245	32.20	32.01	0.256	1.6
Left Tilt	voice	190	836.6	-0.09	0.109	32.20	32.01	0.114	1.6
Right Cheek	voice	190	836.6	0.02	0.289	32.20	32.01	0.302	1.6
Right Tilt	voice	190	836.6	-0.04	0.107	32.20	32.01	0.112	1.6
Body back	voice	190	836.6	0.08	0.271	32.20	32.01	0.283	1.6
Body front	voice	190	836.6	-0.03	0.178	32.20	32.01	0.186	1.6
Body back	GPRS-3 slot	190	836.6	-0.07	0.194	29.30	29.06	0.205	1.6
Body front	GPRS-3 slot	190	836.6	0.04	0.142	29.30	29.06	0.150	1.6
Edge 2(Right)	GPRS-3 slot	190	836.6	0.08	0.138	29.30	29.06	0.146	1.6
Edge 3(Bottom)	GPRS-3 slot	190	836.6	-0.05	0.085	29.30	29.06	0.090	1.6
Edge 4(Left)	GPRS-3 slot	190	836.6	-0.03	0.076	29.30	29.06	0.080	1.6

Note:

- When the 1-g Reported SAR is ≤ 0.8 W/kg, testing for low and high channel is optional. Refer to KDB 447498.
- The test separation for body back, body front and 4 Edges is 10mm of all above table.

Any report having not been signed by authorized approver, or having been altered without authorization, or having not been stamped by the "Dedicated Testing/Inspection Stamp" is deemed to be invalid. Copying or excerpting portion of, or altering the content of the report is not permitted without the written authorization of AGC. The test results presented in the report apply only to the tested sample. Any objections to report issued by AGC should be submitted to AGC within 15days after the issuance of the test report. Further enquiry of validity or verification of the test report should be addressed to AGC by agc@agc-cert.com.



SAR MEASUREMENT									
Depth of Liquid (cm):>15					Relative Humidity (%): 52.6				
Product: Smart phone									
Test Mode: PCS1900 with GMSK modulation									
Position	Mode	Ch.	Fr. (MHz)	Power Drift (<±5%)	SAR (1g) (W/kg)	Max. Tune-up Power (dBm)	Meas. output Power (dBm)	Scaled SAR (W/kg)	Limit (W/kg)
SIM 1 Card									
Left Cheek	voice	661	1880.0	0.03	0.538	30.30	30.20	0.551	1.6
Left Tilt	voice	661	1880.0	-0.06	0.130	30.30	30.20	0.133	1.6
Right Cheek	voice	661	1880.0	0.09	0.222	30.30	30.20	0.227	1.6
Right Tilt	voice	661	1880.0	-0.05	0.126	30.30	30.20	0.129	1.6
Body back	voice	661	1880.0	0.08	0.621	30.30	30.20	0.635	1.6
Body front	voice	661	1880.0	-0.07	0.508	30.30	30.20	0.520	1.6
Body back	GPRS-4 slot	661	1880	-0.04	0.518	25.80	25.77	0.522	1.6
Body front	GPRS-4 slot	661	1880.0	0.08	0.446	25.80	25.77	0.449	1.6
Edge 2(Right)	GPRS-4 slot	661	1880.0	-0.02	0.110	25.80	25.77	0.111	1.6
Edge 3(Bottom)	GPRS-4 slot	661	1880.0	-0.05	0.379	25.80	25.77	0.382	1.6
Edge 4(Left)	GPRS-4 slot	661	1880.0	0.01	0.183	25.80	25.77	0.184	1.6

Note:

- When the 1-g Reported SAR is ≤ 0.8 W/kg, testing for low and high channel is optional. Refer to KDB 447498.
- The test separation for body back, body front and 4 Edges is 10mm of all above table.

Any report having not been signed by authorized approver, or having been altered without authorization, or having not been stamped by the "Dedicated Testing/Inspection Stamp" is deemed to be invalid. Copying or excerpting portion of, or altering the content of the report is not permitted without the written authorization of AGC. The test results presented in the report apply only to the tested sample. Any objections to report issued by AGC should be submitted to AGC within 15days after the issuance of the test report. Further enquiry of validity or verification of the test report should be addressed to AGC by agc@agc-cert.com.



SAR MEASUREMENT									
Depth of Liquid (cm):>15					Relative Humidity (%): 52.6				
Product: Smart phone									
Test Mode: WCDMA Band II with QPSK modulation									
Position	Mode	Ch.	Fr. (MHz)	Power Drift ($\pm 5\%$)	SAR (1g) (W/kg)	Max. Tune-up Power (dBm)	Meas. output Power (dBm)	Scaled SAR (W/kg)	Limit (W/kg)
Left Cheek	RMC 12.2kbps	9400	1880	0.13	0.602	22.60	21.88	0.711	1.6
Left Tilt	RMC 12.2kbps	9400	1880	-0.04	0.179	22.60	21.88	0.211	1.6
Right Cheek	RMC 12.2kbps	9400	1880	0.11	0.366	22.60	21.88	0.432	1.6
Right Tilt	RMC 12.2kbps	9400	1880	-0.05	0.171	22.60	21.88	0.202	1.6
Body back	RMC 12.2kbps	9262	1852.4	0.18	0.818	22.60	22.55	0.827	1.6
Body back	RMC 12.2kbps	9400	1880	-0.17	0.816	22.60	21.88	0.963	1.6
Body back	RMC 12.2kbps	9538	1907.6	0.13	0.815	22.60	22.33	0.867	1.6
Body front	RMC 12.2kbps	9400	1880	0.16	0.731	22.60	21.88	0.863	1.6
Edge 2(Right)	RMC 12.2kbps	9400	1880	-0.09	0.179	22.60	21.88	0.211	1.6
Edge 3(Bottom)	RMC 12.2kbps	9400	1880	0.15	0.652	22.60	21.88	0.770	1.6
Edge 4(Left)	RMC 12.2kbps	9400	1880	-0.04	0.296	22.60	21.88	0.349	1.6

Note:

- When the 1-g Reported SAR is ≤ 0.8 W/kg, testing for low and high channel is optional. Refer to KDB 447498.
- The test separation for body back, body front and 4 Edges is 10mm of all above table.

Any report having not been signed by authorized approver, or having been altered without authorization, or having not been stamped by the "Dedicated Testing/Inspection Stamp" is deemed to be invalid. Copying or excerpting portion of, or altering the content of the report is not permitted without the written authorization of AGC. The test results presented in the report apply only to the tested sample. Any objections to report issued by AGC should be submitted to AGC within 15days after the issuance of the test report. Further enquiry of validity or verification of the test report should be addressed to AGC by agc@agc-cert.com.



SAR MEASUREMENT									
Depth of Liquid (cm):>15					Relative Humidity (%): 54.3				
Product: Smart phone									
Test Mode: WCDMA Band V with QPSK modulation									
Position	Mode	Ch.	Fr. (MHz)	Power Drift ($\pm 5\%$)	SAR (1g) (W/kg)	Max. Tune-up Power (dBm)	Meas. output Power (dBm)	Scaled SAR (W/kg)	Limit (W/kg)
Left Cheek	RMC 12.2kbps	4183	836.4	-0.09	0.252	22.70	21.97	0.298	1.6
Left Tilt	RMC 12.2kbps	4183	836.4	0.05	0.143	22.70	21.97	0.169	1.6
Right Cheek	RMC 12.2kbps	4183	836.4	-0.01	0.302	22.70	21.97	0.357	1.6
Right Tilt	RMC 12.2kbps	4183	836.4	0.03	0.116	22.70	21.97	0.137	1.6
Body back	RMC 12.2kbps	4183	836.4	-0.06	0.304	22.70	21.97	0.360	1.6
Body front	RMC 12.2kbps	4183	836.4	0.04	0.195	22.70	21.97	0.231	1.6
Edge 2(Right)	RMC 12.2kbps	4183	836.4	0.05	0.180	22.70	21.97	0.213	1.6
Edge 3(Bottom)	RMC 12.2kbps	4183	836.4	-0.07	0.097	22.70	21.97	0.115	1.6
Edge 4(Left)	RMC 12.2kbps	4183	836.4	0.02	0.103	22.70	21.97	0.122	1.6

Note:

- When the 1-g Reported SAR is ≤ 0.8 W/kg, testing for low and high channel is optional. Refer to KDB 447498.
- The test separation for body back, body front and 4 Edges is 10mm of all above table.

Any report having not been signed by authorized approver, or having been altered without authorization, or having not been stamped by the "Dedicated Testing/Inspection Stamp" is deemed to be invalid. Copying or excerpting portion of, or altering the content of the report is not permitted without the written authorization of AGC. The test results presented in the report apply only to the tested sample. Any objections to report issued by AGC should be submitted to AGC within 15days after the issuance of the test report. Further enquiry of validity or verification of the test report should be addressed to AGC by agc@agc-cert.com.



SAR MEASUREMENT												
Depth of Liquid (cm):>15						Relative Humidity (%): 52.8						
Product: Smart phone												
Test Mode: LTE Band 2												
BM MHz	MOD	Position	Test Mode		Ch.	Freq. (MHz)	Power Drift (<±5%)	SAR (1g) (W/kg)	Max. Tune up Power (dBm)	Meas. output Power (dBm)	Scaled SAR (W/kg)	Limit (W/kg)
			UL RB Allocation	UL RB START								
20	QPSK	Left Cheek	1	0	18900	1880	0.05	0.329	22.90	22.52	0.359	1.6
		Left Tilt	1	0	18900	1880	-0.08	0.163	22.90	22.52	0.178	1.6
		Right Cheek	1	0	18900	1880	0.02	0.376	22.90	22.52	0.410	1.6
		Right Tilt	1	0	18900	1880	-0.06	0.220	22.90	22.52	0.240	1.6
		Body back	1	0	18700	1860	0.11	0.897	22.90	22.81	0.916	1.6
		Body back	1	0	18900	1880	-0.18	0.903	22.90	22.52	0.986	1.6
		Body back	1	0	19100	1900	0.16	0.896	22.90	22.37	1.012	1.6
		Body front	1	0	18900	1880	-0.14	0.712	22.90	22.52	0.777	1.6
		Edge 2(Right)	1	0	18900	1880	0.08	0.291	22.90	22.52	0.318	1.6
		Edge 3(Bottom)	1	0	18900	1880	-0.10	0.668	22.90	22.52	0.729	1.6
Edge 4(Left)	1	0	18900	1880	-0.07	0.468	22.90	22.52	0.511	1.6		

Note:

- When the 1-g Reported SAR is ≤ 0.8 W/kg, testing for low and high channel is optional. Refer to KDB 447498.
- The test separation for body back, body front and 4 Edges is 10mm of all above table.

Any report having not been signed by authorized approver, or having been altered without authorization, or having not been stamped by the "Dedicated Testing/Inspection Stamp" is deemed to be invalid. Copying or excerpting portion of, or altering the content of the report is not permitted without the written authorization of AGC. The test results presented in the report apply only to the tested sample. Any objections to report issued by AGC should be submitted to AGC within 15days after the issuance of the test report. Further enquiry of validity or verification of the test report should be addressed to AGC by agc@agc-cert.com.



SAR MEASUREMENT												
Depth of Liquid (cm):>15						Relative Humidity (%): 52.6						
Product: Smart phone												
Test Mode: LTE Band 4												
BM MHz	MOD	Position	Test Mode		Ch.	Freq. (MHz)	Power Drift (<±5%)	SAR (1g) (W/kg)	Max. Tuneup Power (dBm)	Meas. output Power (dBm)	Scaled SAR (W/kg)	Limit (W/kg)
			UL RB Allocation	UL RB START								
20	QPSK	Left Cheek	1	0	20175	1732.5	0.01	0.352	23.10	23.03	0.358	1.6
		Left Tilt	1	0	20175	1732.5	-0.02	0.166	23.10	23.03	0.169	1.6
		Right Cheek	1	0	20175	1732.5	0.05	0.323	23.10	23.03	0.328	1.6
		Right Tilt	1	0	20175	1732.5	-0.09	0.127	23.10	23.03	0.129	1.6
		Body back	1	0	20050	1720	0.11	0.848	23.10	23.02	0.864	1.6
		Body back	1	0	20175	1732.5	-0.04	0.858	23.10	23.03	0.872	1.6
		Body back	1	0	20300	1745	0.05	0.831	23.10	22.74	0.903	1.6
		Body front	1	0	20175	1732.5	-0.17	0.743	23.10	23.03	0.755	1.6
		Edge 2(Right)	1	0	20175	1732.5	0.08	0.196	23.10	23.03	0.199	1.6
		Edge 3(Bottom)	1	0	20175	1732.5	-0.10	0.622	23.10	23.03	0.632	1.6
		Edge 4(Left)	1	0	20175	1732.5	0.08	0.348	23.10	23.03	0.354	1.6

Note:

- When the 1-g Reported SAR is ≤ 0.8 W/kg, testing for low and high channel is optional. Refer to KDB 447498.
- The test separation for body back, body front and 4 Edges is 10mm of all above table.

Any report having not been signed by authorized approver, or having been altered without authorization, or having not been stamped by the "Dedicated Testing/Inspection Stamp" is deemed to be invalid. Copying or excerpting portion of, or altering the content of the report is not permitted without the written authorization of AGC. The test results presented in the report apply only to the tested sample. Any objections to report issued by AGC should be submitted to AGC within 15days after the issuance of the test report. Further enquiry of validity or verification of the test report should be addressed to AGC by agc@agc-cert.com.



SAR MEASUREMENT												
Depth of Liquid (cm):>15						Relative Humidity (%): 54.7						
Product: Smart phone												
Test Mode: LTE Band 5												
BM MHz	MOD	Position	Test Mode		Ch.	Freq. (MHz)	Power Drift ($\pm 5\%$)	SAR (1g) (W/kg)	Max. Tuneup Power (dBm)	Meas. output Power (dBm)	Scaled SAR (W/kg)	Limit (W/kg)
			UL RB Allocation	UL RB START								
10	QPSK	Left Cheek	1	0	20525	836.5	-0.09	0.295	23.40	23.35	0.298	1.6
		Left Tilt	1	0	20525	836.5	0.05	0.143	23.40	23.35	0.145	1.6
		Right Cheek	1	0	20525	836.5	-0.03	0.342	23.40	23.35	0.346	1.6
		Right Tilt	1	0	20525	836.5	0.07	0.172	23.40	23.35	0.174	1.6
		Body back	1	0	20525	836.5	-0.05	0.309	23.40	23.35	0.313	1.6
		Body front	1	0	20525	836.5	0.06	0.228	23.40	23.35	0.231	1.6
		Edge 2(Right)	1	0	20525	836.5	0.08	0.216	23.40	23.35	0.219	1.6
		Edge 3(Bottom)	1	0	20525	836.5	-0.02	0.083	23.40	23.35	0.084	1.6
		Edge 4(Left)	1	0	20525	836.5	0.04	0.107	23.40	23.35	0.108	1.6

Note:

- When the 1-g Reported SAR is ≤ 0.8 W/kg, testing for low and high channel is optional. Refer to KDB 447498.
- The test separation for body back, body front and 4 Edges is 10mm of all above table.

Any report having not been signed by authorized approver, or having been altered without authorization, or having not been stamped by the "Dedicated Testing/Inspection Stamp" is deemed to be invalid. Copying or excerpting portion of, or altering the content of the report is not permitted without the written authorization of AGC. The test results presented in the report apply only to the tested sample. Any objections to report issued by AGC should be submitted to AGC within 15days after the issuance of the test report. Further enquiry of validity or verification of the test report should be addressed to AGC by agc@agc-cert.com.



SAR MEASUREMENT												
Depth of Liquid (cm):>15						Relative Humidity (%): 50.8						
Product: Smart phone												
Test Mode: LTE Band 7												
BM MHz	MOD	Position	Test Mode		Ch.	Freq. (MHz)	Power Drift (<±5%)	SAR (1g) (W/kg)	Max. Tuneup Power (dBm)	Meas. output Power (dBm)	Scaled SAR (W/kg)	Limit (W/kg)
			UL RB Allocation	UL RB START								
20	QPSK	Left Cheek	1	0	21100	2535	0.11	0.129	22.20	22.17	0.130	1.6
		Left Tilt	1	0	21100	2535	-0.05	0.067	22.20	22.17	0.067	1.6
		Right Cheek	1	0	21100	2535	0.08	0.071	22.20	22.17	0.071	1.6
		Right Tilt	1	0	21100	2535	-0.04	0.102	22.20	22.17	0.103	1.6
		Body back	1	0	20850	2510	0.02	0.902	22.20	21.79	0.991	1.6
		Body back	1	0	21100	2535	-0.16	0.920	22.20	22.17	0.926	1.6
		Body back	1	0	21350	2560	0.19	0.935	22.20	21.69	1.052	1.6
		Body front	1	0	20850	2510	-0.08	1.113	22.20	21.79	1.223	1.6
		Body front	1	0	21100	2535	0.13	1.128	22.20	22.17	1.136	1.6
		Body front	1	0	21350	2560	-0.12	1.149	22.20	21.69	1.292	1.6
		Body front+Ear.	1	0	21350	2560	0.09	1.075	22.20	21.69	1.209	1.6
		Edge 2(Right)	1	0	21100	2535	-0.08	0.050	22.20	22.17	0.050	1.6
		Edge 3(Bottom)	1	0	21100	2535	0.17	0.715	22.20	22.17	0.720	1.6
		Edge 4(Left)	1	0	21100	2535	0.05	0.131	22.20	22.17	0.132	1.6

Note:

- When the 1-g Reported SAR is ≤ 0.8 W/kg, testing for low and high channel is optional. Refer to KDB 447498.
- The test separation for body back, body front and 4 Edges is 10mm of all above table.

Any report having not been signed by authorized approver, or having been altered without authorization, or having not been stamped by the "Dedicated Testing/Inspection Stamp" is deemed to be invalid. Copying or excerpting portion of, or altering the content of the report is not permitted without the written authorization of AGC. The test results presented in the report apply only to the tested sample. Any objections to report issued by AGC should be submitted to AGC within 15days after the issuance of the test report. Further enquiry of validity or verification of the test report should be addressed to AGC by agc@agc-cert.com.



SAR MEASUREMENT												
Depth of Liquid (cm):>15						Relative Humidity (%): 51.1						
Product: Smart phone												
Test Mode: LTE Band 12												
BM MHz	MOD	Position	Test Mode		Ch.	Freq. (MHz)	Power Drift (<±5%)	SAR (1g) (W/kg)	Max. Tuneup Power (dBm)	Meas. output Power (dBm)	Scaled SAR (W/kg)	Limit (W/kg)
			UL RB Allocation	UL RB START								
10	QPSK	Left Cheek	1	0	23095	707.5	0.08	0.264	23.40	23.32	0.269	1.6
		Left Tilt	1	0	23095	707.5	-0.12	0.144	23.40	23.32	0.147	1.6
		Right Cheek	1	0	23095	707.5	0.15	0.303	23.40	23.32	0.309	1.6
		Right Tilt	1	0	23095	707.5	-0.06	0.157	23.40	23.32	0.160	1.6
		Body back	1	0	23095	707.5	0.03	0.424	23.40	23.32	0.432	1.6
		Body front	1	0	23095	707.5	-0.19	0.276	23.40	23.32	0.281	1.6
		Edge 2(Right)	1	0	23095	707.5	-0.11	0.246	23.40	23.32	0.251	1.6
		Edge 3(Bottom)	1	0	23095	707.5	0.07	0.022	23.40	23.32	0.022	1.6
		Edge 4(Left)	1	0	23095	707.5	-0.05	0.225	23.40	23.32	0.229	1.6

Note:

- When the 1-g Reported SAR is ≤ 0.8 W/kg, testing for low and high channel is optional. Refer to KDB 447498.
- The test separation for body back, body front and 4 Edges is 10mm of all above table.

Any report having not been signed by authorized approver, or having been altered without authorization, or having not been stamped by the "Dedicated Testing/Inspection Stamp" is deemed to be invalid. Copying or excerpting portion of, or altering the content of the report is not permitted without the written authorization of AGC. The test results presented in the report apply only to the tested sample. Any objections to report issued by AGC should be submitted to AGC within 15days after the issuance of the test report. Further enquiry of validity or verification of the test report should be addressed to AGC by agc@agc-cert.com.



SAR MEASUREMENT												
Depth of Liquid (cm):>15						Relative Humidity (%): 51.1						
Product: Smart phone												
Test Mode: LTE Band 17												
BM MHz	MOD	Position	Test Mode		Ch.	Freq. (MHz)	Power Drift (<±5%)	SAR (1g) (W/kg)	Max. Tuneup Power (dBm)	Meas. output Power (dBm)	Scaled SAR (W/kg)	Limit (W/kg)
			UL RB Allocation	UL RB START								
10	QPSK	Left Cheek	1	0	23790	710	0.14	0.245	23.30	22.96	0.265	1.6
		Left Tilt	1	0	23790	710	-0.08	0.148	23.30	22.96	0.160	1.6
		Right Cheek	1	0	23790	710	-0.05	0.289	23.30	22.96	0.313	1.6
		Right Tilt	1	0	23790	710	0.12	0.161	23.30	22.96	0.174	1.6
		Body back	1	0	23790	710	-0.16	0.401	23.30	22.96	0.434	1.6
		Body front	1	0	23790	710	0.09	0.267	23.30	22.96	0.289	1.6
		Edge 2(Right)	1	0	23790	710	0.07	0.192	23.30	22.96	0.208	1.6
		Edge 3(Bottom)	1	0	23790	710	-0.06	0.076	23.30	22.96	0.082	1.6
		Edge 4(Left)	1	0	23790	710	0.02	0.130	23.30	22.96	0.141	1.6

Note:

- When the 1-g Reported SAR is ≤ 0.8 W/kg, testing for low and high channel is optional. Refer to KDB 447498.
- The test separation for body back, body front and 4 Edges is 10mm of all above table.

Any report having not been signed by authorized approver, or having been altered without authorization, or having not been stamped by the "Dedicated Testing/Inspection Stamp" is deemed to be invalid. Copying or excerpting portion of, or altering the content of the report is not permitted without the written authorization of AGC. The test results presented in the report apply only to the tested sample. Any objections to report issued by AGC should be submitted to AGC within 15days after the issuance of the test report. Further enquiry of validity or verification of the test report should be addressed to AGC by agc@agc-cert.com.



SAR Test Exclusion Consideration

According to KDB 447498 D04 Appendix B, Standalone SAR test exclusion is as follow:
This method shall only be used at separation distances from 0.5 cm to 40 cm and at frequencies from 0.3 GHz to 6 GHz (inclusive). P_{th} is given by Formula

$$P_{th} \text{ (mW)} = \begin{cases} ERP_{20 \text{ cm}}(d/20 \text{ cm})^x & d \leq 20 \text{ cm} \\ ERP_{20 \text{ cm}} & 20 \text{ cm} < d \leq 40 \text{ cm} \end{cases}$$

Where

$$x = -\log_{10} \left(\frac{60}{ERP_{20 \text{ cm}} \sqrt{f}} \right) \text{ and } f \text{ is in GHz;}$$

and

$$ERP_{20 \text{ cm}} \text{ (mW)} = \begin{cases} 2040f & 0.3 \text{ GHz} \leq f < 1.5 \text{ GHz} \\ 3060 & 1.5 \text{ GHz} \leq f \leq 6 \text{ GHz} \end{cases}$$

d = the separation distance (cm);

Technology	f(GHz)	d(cm)	ERP _{20CM} (mW)	√f(GHz)	x	P _{th} (mW)	Max Power including Tune-up Tolerance		SAR required
							dBm	mW	
WIFI	2.437	0.5	3060	1.561	1.901	2.756	14.63	29.040	Yes
BT(BR&EDR)	2.402	0.5	3060	1.550	1.898	2.788	5.5	3.55	Yes
BT(BLE)	2.440	0.5	3060	1.562	1.901	2.753	-2.5	0.56	No

Conclusion

There is need to test standalone WIFI SAR, BT(BR&EDR) SAR and need to evaluate simultaneous transmission

SAR MEASUREMENT									
Depth of Liquid (cm):>15					Relative Humidity (%): 50.8				
Product: Smart phone									
Test Mode:802.11b									
Position	Mode	Ch.	Fr. (MHz)	Power Drift (<±5%)	SAR (1g) (W/kg)	Max. Tune-up Power (dBm)	Meas. output Power (dBm)	Scaled SAR (W/kg)	Limit (W/kg)
Left Cheek	DTS	6	2437	0.08	0.164	12.10	12.06	0.166	1.6
Left Tilt	DTS	6	2437	-0.02	0.143	12.10	12.06	0.144	1.6
Right Cheek	DTS	6	2437	0.03	0.099	12.10	12.06	0.100	1.6
Right Tilt	DTS	6	2437	-0.06	0.073	12.10	12.06	0.074	1.6
Body back	DTS	6	2437	0.09	0.076	12.10	12.06	0.077	1.6
Body front	DTS	6	2437	-0.05	0.083	12.10	12.06	0.084	1.6
Edge 1 (Top)	DTS	6	2437	0.04	0.027	12.10	12.06	0.027	1.6
Edge 2(Right)	DTS	6	2437	-0.02	0.044	12.10	12.06	0.044	1.6

Note:

- All of above "DTS" means data transmitters.
- The test separation for body back, body front and 4 Edges is 10mm of all above table.

Any report having not been signed by authorized approver, or having been altered without authorization, or having not been stamped by the "Dedicated Testing/Inspection Stamp" is deemed to be invalid. Copying or excerpting portion of, or altering the content of the report is not permitted without the written authorization of AGC. The test results presented in the report apply only to the tested sample. Any objections to report issued by AGC should be submitted to AGC within 15days after the issuance of the test report. Further enquiry of validity or verification of the test report should be addressed to AGC by agc@agc-cert.com.



SAR MEASUREMENT								
Depth of Liquid (cm):>15				Relative Humidity (%): 50.8				
Product: Smart phone								
Test Mode: Bluetooth(BR&EDR)								
Position	Ch.	Fr. (MHz)	Power Drift (<±5%)	SAR (1g) (W/kg)	Max. Tune-up Power (dBm)	Meas. output Power (dBm)	Scaled SAR (W/kg)	Limit (W/kg)
Left Cheek	39	2441	0.02	0.018	5.50	4.62	0.022	1.6
Left Tilt	39	2441	-0.08	0.016	5.50	4.62	0.020	1.6
Right Cheek	39	2441	0.05	0.009	5.50	4.62	0.011	1.6
Right Tilt	39	2441	-0.06	0.008	5.50	4.62	0.010	1.6
Body back	39	2441	0.04	0.007	5.50	4.62	0.009	1.6
Body front	39	2441	-0.09	0.006	5.50	4.62	0.007	1.6
Edge 1 (Top)	39	2441	-0.03	0.003	5.50	4.62	0.004	1.6
Edge 2(Right)	39	2441	0.07	0.005	5.50	4.62	0.006	1.6

Note:

- When the 1-g Reported SAR is ≤ 0.8 W/kg, testing for low and high channel is optional. Refer to KDB 447498.
- The test separation for body back, body front and 4 Edges is 10mm of all above table.

Any report having not been signed by authorized approver, or having been altered without authorization, or having not been stamped by the "Dedicated Testing/Inspection Stamp" is deemed to be invalid. Copying or excerpting portion of, or altering the content of the report is not permitted without the written authorization of AGC. The test results presented in the report apply only to the tested sample. Any objections to report issued by AGC should be submitted to AGC within 15days after the issuance of the test report. Further enquiry of validity or verification of the test report should be addressed to AGC by agc@agc-cert.com.



Repeated SAR											
Product: Smart phone											
Test Mode: WCDMA Band II& LTE Band 2& LTE Band 4& LTE Band 7											
Position	Mode		Ch.	Fr. (MHz)	Power Drift (<±5%)	Once SAR (1g) (W/kg)	Power Drift (<±5%)	Twice SAR (1g) (W/kg)	Power Drift (<±5%)	Third SAR (1g) (W/kg)	Limit W/kg
Body back	RMC 12.2kbps		9262	1852.4	0.11	0.815	--	--	--	--	1.6
Position	Mode		Ch.	Fr. (MHz)	Power Drift (<±5%)	Once SAR (1g) (W/kg)	Power Drift (<±5%)	Twice SAR (1g) (W/kg)	Power Drift (<±5%)	Third SAR (1g) (W/kg)	Limit W/kg
	UL RB Allocation	UL RB START									
Body back	1	0	18900	1880	-0.15	0.902	--	--	--	--	1.6
Body back	1	0	20175	1732.5	0.10	0.862	--	--	--	--	1.6
Body front	1	0	21350	2560	0.08	1.132	--	--	--	--	1.6

The second repeated SAR judge reference									
Product: Smart phone									
Band	Position	Mode		Ch.	Fr. (MHz)	Original SAR (1g) (W/kg)	First SAR (1g) (W/kg)	Ratio	Limit
WCDMA Band II	Body back	RMC 12.2kbps		9262	1852.4	0.818	0.815	1.004	<1.2
Band	Position	Mode		Ch.	Fr. (MHz)	Original SAR (1g) (W/kg)	First SAR (1g) (W/kg)	Ratio	Limit
		UL RB Allocation	UL RB START						
LTE Band 2	Body back	1	0	18900	1880	0.903	0.902	1.001	<1.2
LTE Band 4	Body back	1	0	20175	1732.5	0.858	0.862	0.995	<1.2
LTE Band 7	Body front	1	0	21350	2560	1.149	1.132	1.015	<1.2

Any report having not been signed by authorized approver, or having been altered without authorization, or having not been stamped by the "Dedicated Testing/Inspection Stamp" is deemed to be invalid. Copying or excerpting portion of, or altering the content of the report is not permitted without the written authorization of AGC. The test results presented in the report apply only to the tested sample. Any objections to report issued by AGC should be submitted to AGC within 15days after the issuance of the test report. Further enquiry of validity or verification of the test report should be addressed to AGC by agc@agc-cert.com.



Simultaneous Multi-band Transmission Evaluation:
Application Simultaneous Transmission information:

NO	Simultaneous state	Portable Handset		
		Head	Body-worn	Hotspot
1	GSM(voice)+ WLAN 2.4GHz (data)	Yes	Yes	-
2	GSM(voice)+ Bluetooth(BR&EDR) (data)	Yes	Yes	-
3	GSM (Data) + WLAN 2.4GHz (data)	-	Yes	Yes
4	GSM (Data) + Bluetooth(BR&EDR) (data)	-	Yes	Yes
5	WCDMA+ WLAN 2.4GHz (data)	Yes	Yes	Yes
6	WCDMA+ Bluetooth(BR&EDR) (data)	Yes	Yes	Yes
7	LTE + WLAN 2.4GHz (data)	Yes	Yes	Yes
8	LTE + Bluetooth(BR&EDR) (data)	Yes	Yes	Yes

NOTE:

1. WIFI and BT share the same antenna, and cannot transmit simultaneously.
2. Simultaneous with every transmitter must be the same test position.
3. KDB 447498 D04, for handsets the test separation distance is determined by the smallest distance between the outer surface of the device and the user; which is 0mm for head SAR and 10mm for body-worn SAR.
4. When the sum of SAR is larger than the limit, SAR test exclusion is determined by the SAR to peak location separation ratio. The simultaneous transmitting antennas in each operating mode and exposure condition combination must be considered one pair at a time to determine the SAR to peak location separation ratio to qualify for test exclusion. The ratio is determined by $(SAR_1 + SAR_2)1.5/R_i$, rounded to two decimal digits, and must be ≤ 0.04 for all antenna pairs in the configuration to qualify for 1-g SAR test exclusion.
5. According to KDB 447498 D04 Appendix E, When the standalone 1g SAR test exclusion is applied, the standalone 1g SAR must be estimated according to the following equation, with $P_{ant} < P_{th}$, where P_{ant} is maximum time-averaged power or effective radiated power (ERP), whichever is greater, and P_{th} is defined in Formula (B.2).

$$SAR_{est} = 1.6 \cdot P_{ant} / P_{th} [W/kg]$$

For BT(BLE)head :Estimated 1g SAR = $SAR_{lim} \times [(P_{ant h}(mW) / P_{th}(mW))] = 1.6 \cdot (0.56/2.753) = 0.325 W/kg$

For BT(BLE) body:Estimated 1g SAR = $SAR_{lim} \times [(P_{ant h}(mW) / P_{th}(mW))] = 1.6 \cdot (0.56/10.283) = 0.087 W/kg$

	GSM&WCDMA<E SAR (W/kg)	Estimated 1g BT(BLE) SAR (W/kg)	Simultaneous SAR BT(BLE)+WWAN
Head	0.711	0.325	1.036
Body	1.292	0.087	1.379

Any report having not been signed by authorized approver, or having been altered without authorization, or having not been stamped by the "Dedicated Testing/Inspection Stamp" is deemed to be invalid. Copying or excerpting portion of, or altering the content of the report is not permitted without the written authorization of AGC. The test results presented in the report apply only to the tested sample. Any objections to report issued by AGC should be submitted to AGC within 15days after the issuance of the test report. Further enquiry of validity or verification of the test report should be addressed to AGC by agc@agc-cert.com.



Sum of the SAR for GSM 850 & Wi-Fi & BT:

RF Exposure Conditions	Test Position	Simultaneous Transmission Scenario			Σ1-g SAR (W/kg)	SPLSR (Yes/No)
		GSM 850	Wi-Fi DTS Band	Bluetooth(BR&EDR)		
Head (voice)	Left Touch	0.256	0.166		0.422	No
	Left Tilt	0.114	0.144		0.258	No
	Right Touch	0.302	0.100		0.402	No
	Right Tilt	0.112	0.074		0.186	No
Head (voice)	Left Touch	0.256		0.022	0.278	No
	Left Tilt	0.114		0.020	0.134	No
	Right Touch	0.302		0.011	0.313	No
	Right Tilt	0.112		0.010	0.122	No
Body-worn (voice)	Rear	0.283	0.077		0.360	No
		0.283		0.009	0.292	No
	Front	0.186	0.084		0.270	No
		0.186		0.007	0.193	No
Body-worn (Data)	Rear	0.205		0.009	0.214	No
		0.205	0.077		0.282	No
	Front	0.150		0.007	0.157	No
		0.150	0.084		0.234	No
	Edge 2	0.146	0.044		0.190	No
	Edge 2	0.146		0.006	0.152	No

Note:

- According to KDB 447498 D01 General RF Exposure Guidance, when the simultaneous transmission SAR is less than 1.6 W/kg, SPLSR assessment is not required.
- SPLSR mean is “The SAR to Peak Location Separation Ratio “

Any report having not been signed by authorized approver, or having been altered without authorization, or having not been stamped by the “Dedicated Testing/Inspection Stamp” is deemed to be invalid. Copying or excerpting portion of, or altering the content of the report is not permitted without the written authorization of AGC. The test results presented in the report apply only to the tested sample. Any objections to report issued by AGC should be submitted to AGC within 15 days after the issuance of the test report. Further enquiry of validity or verification of the test report should be addressed to AGC by agc@agc-cert.com.



Sum of the SAR for GSM 1900 & Wi-Fi & BT:

RF Exposure Conditions	Test Position	Simultaneous Transmission Scenario			Σ1-g SAR (W/kg)	SPLSR (Yes/No)
		PCS 1900	Wi-Fi DTS Band	Bluetooth(BR&EDR)		
Head (voice)	Left Touch	0.551	0.166		0.717	No
	Left Tilt	0.133	0.144		0.277	No
	Right Touch	0.227	0.100		0.327	No
	Right Tilt	0.129	0.074		0.203	No
Head (voice)	Left Touch	0.551		0.022	0.573	No
	Left Tilt	0.133		0.020	0.153	No
	Right Touch	0.227		0.011	0.238	No
	Right Tilt	0.129		0.010	0.139	No
Body-worn (voice)	Rear	0.635	0.077		0.712	No
		0.635		0.009	0.644	No
	Front	0.520	0.084		0.604	No
		0.520		0.007	0.527	No
Body-worn (Data)	Rear	0.522		0.009	0.531	No
		0.522	0.077		0.599	No
	Front	0.449		0.007	0.456	No
		0.449	0.084		0.533	No
	Edge 2	0.111	0.044		0.155	No
	Edge 2	0.111		0.006	0.117	No

Note:

- According to KDB 447498 D01 General RF Exposure Guidance, when the simultaneous transmission SAR is less than 1.6 W/kg, SPLSR assessment is not required.
- SPLSR mean is “The SAR to Peak Location Separation Ratio “

Any report having not been signed by authorized approver, or having been altered without authorization, or having not been stamped by the “Dedicated Testing/Inspection Stamp” is deemed to be invalid. Copying or excerpting portion of, or altering the content of the report is not permitted without the written authorization of AGC. The test results presented in the report apply only to the tested sample. Any objections to report issued by AGC should be submitted to AGC within 15 days after the issuance of the test report. Further enquiry of validity or verification of the test report should be addressed to AGC by agc@agc-cert.com.



Sum of the SAR for WCDMA Band II & Wi-Fi & BT:

RF Exposure Conditions	Test Position	Simultaneous Transmission Scenario			Σ1-g SAR (W/kg)	SPLSR (Yes/No)
		WCDMA Band II	Wi-Fi DTS Band	Bluetooth(BR&EDR)		
Head	Left Touch	0.711	0.166		0.877	No
	Left Tilt	0.211	0.144		0.355	No
	Right Touch	0.432	0.100		0.532	No
	Right Tilt	0.202	0.074		0.276	No
Head	Left Touch	0.711		0.022	0.733	No
	Left Tilt	0.211		0.020	0.231	No
	Right Touch	0.432		0.011	0.443	No
	Right Tilt	0.202		0.010	0.212	No
Body-worn	Rear	0.963	0.077		1.040	No
	Front	0.863	0.084		0.947	No
	Edge 2	0.211	0.044		0.255	No
	Rear	0.963		0.009	0.972	No
	Front	0.863		0.007	0.870	No
	Edge 2	0.211		0.006	0.217	No

Note:

- According to KDB 447498 D01 General RF Exposure Guidance, when the simultaneous transmission SAR is less than 1.6 W/kg, SPLSR assessment is not required.
- SPLSR mean is “The SAR to Peak Location Separation Ratio “

Any report having not been signed by authorized approver, or having been altered without authorization, or having not been stamped by the “Dedicated Testing/Inspection Stamp” is deemed to be invalid. Copying or excerpting portion of, or altering the content of the report is not permitted without the written authorization of AGC. The test results presented in the report apply only to the tested sample. Any objections to report issued by AGC should be submitted to AGC within 15 days after the issuance of the test report. Further enquiry of validity or verification of the test report should be addressed to AGC by agc@agc-cert.com.



Sum of the SAR for WCDMA Band V & Wi-Fi & BT:

RF Exposure Conditions	Test Position	Simultaneous Transmission Scenario			Σ1-g SAR (W/kg)	SPLSR (Yes/No)
		WCDMA Band V	Wi-Fi DTS Band	Bluetooth(BR&EDR)		
Head	Left Touch	0.298	0.166		0.464	No
	Left Tilt	0.169	0.144		0.313	No
	Right Touch	0.357	0.100		0.457	No
	Right Tilt	0.137	0.074		0.211	No
Head	Left Touch	0.298		0.022	0.320	No
	Left Tilt	0.169		0.020	0.189	No
	Right Touch	0.357		0.011	0.368	No
	Right Tilt	0.137		0.010	0.147	No
Body-worn	Rear	0.360	0.077		0.437	No
	Front	0.231	0.084		0.315	No
	Edge 2	0.213	0.044		0.257	No
	Rear	0.360		0.009	0.369	No
	Front	0.231		0.007	0.238	No
	Edge 2	0.213		0.006	0.219	No

Note:

- According to KDB 447498 D01 General RF Exposure Guidance, when the simultaneous transmission SAR is less than 1.6 W/kg, SPLSR assessment is not required.
- SPLSR mean is “The SAR to Peak Location Separation Ratio “

Any report having not been signed by authorized approver, or having been altered without authorization, or having not been stamped by the “Dedicated Testing/Inspection Stamp” is deemed to be invalid. Copying or excerpting portion of, or altering the content of the report is not permitted without the written authorization of AGC. The test results presented in the report apply only to the tested sample. Any objections to report issued by AGC should be submitted to AGC within 15 days after the issuance of the test report. Further enquiry of validity or verification of the test report should be addressed to AGC by agc@agc-cert.com.



Sum of the SAR for LTE Band 2 & Wi-Fi & BT:

RF Exposure Conditions	Test Position	Simultaneous Transmission Scenario			Σ1-g SAR (W/kg)	SPLSR (Yes/No)
		LTE Band 2	Wi-Fi DTS Band	Bluetooth(BR&EDR)		
Head	Left Touch	0.359	0.166		0.525	No
	Left Tilt	0.178	0.144		0.322	No
	Right Touch	0.410	0.100		0.510	No
	Right Tilt	0.240	0.074		0.314	No
Head	Left Touch	0.359		0.022	0.381	No
	Left Tilt	0.178		0.020	0.198	No
	Right Touch	0.410		0.011	0.421	No
	Right Tilt	0.240		0.010	0.250	No
Body-worn	Rear	1.012	0.077		1.089	No
	Front	0.777	0.084		0.861	No
	Edge 2	0.318	0.044		0.362	No
	Rear	1.012		0.009	1.021	No
	Front	0.777		0.007	0.784	No
	Edge 2	0.318		0.006	0.324	No

Note:

- According to KDB 447498 D01 General RF Exposure Guidance, when the simultaneous transmission SAR is less than 1.6 W/kg, SPLSR assessment is not required.
- SPLSR mean is “The SAR to Peak Location Separation Ratio “

Any report having not been signed by authorized approver, or having been altered without authorization, or having not been stamped by the “Dedicated Testing/Inspection Stamp” is deemed to be invalid. Copying or excerpting portion of, or altering the content of the report is not permitted without the written authorization of AGC. The test results presented in the report apply only to the tested sample. Any objections to report issued by AGC should be submitted to AGC within 15 days after the issuance of the test report. Further enquiry of validity or verification of the test report should be addressed to AGC by agc@agc-cert.com.



Sum of the SAR for LTE Band 4 & Wi-Fi & BT:

RF Exposure Conditions	Test Position	Simultaneous Transmission Scenario			Σ1-g SAR (W/kg)	SPLSR (Yes/No)
		LTE Band 4	Wi-Fi DTS Band	Bluetooth(BR&EDR)		
Head	Left Touch	0.358	0.166		0.524	No
	Left Tilt	0.169	0.144		0.313	No
	Right Touch	0.328	0.100		0.428	No
	Right Tilt	0.129	0.074		0.203	No
Head	Left Touch	0.358		0.022	0.380	No
	Left Tilt	0.169		0.020	0.189	No
	Right Touch	0.328		0.011	0.339	No
	Right Tilt	0.129		0.010	0.139	No
Body-worn	Rear	0.903	0.077		0.980	No
	Front	0.755	0.084		0.839	No
	Edge 2	0.199	0.044		0.243	No
	Rear	0.903		0.009	0.912	No
	Front	0.755		0.007	0.762	No
	Edge 2	0.199		0.006	0.205	No

Note:

- According to KDB 447498 D01 General RF Exposure Guidance, when the simultaneous transmission SAR is less than 1.6 W/kg, SPLSR assessment is not required.
- SPLSR mean is “The SAR to Peak Location Separation Ratio “

Any report having not been signed by authorized approver, or having been altered without authorization, or having not been stamped by the “Dedicated Testing/Inspection Stamp” is deemed to be invalid. Copying or excerpting portion of, or altering the content of the report is not permitted without the written authorization of AGC. The test results presented in the report apply only to the tested sample. Any objections to report issued by AGC should be submitted to AGC within 15 days after the issuance of the test report. Further enquiry of validity or verification of the test report should be addressed to AGC by agc@agc-cert.com.



Sum of the SAR for LTE Band 5 & Wi-Fi & BT:

RF Exposure Conditions	Test Position	Simultaneous Transmission Scenario			Σ1-g SAR (W/kg)	SPLSR (Yes/No)
		LTE Band 5	Wi-Fi DTS Band	Bluetooth(BR&EDR)		
Head	Left Touch	0.298	0.166		0.464	No
	Left Tilt	0.145	0.144		0.289	No
	Right Touch	0.346	0.100		0.446	No
	Right Tilt	0.174	0.074		0.248	No
Head	Left Touch	0.298		0.022	0.320	No
	Left Tilt	0.145		0.020	0.165	No
	Right Touch	0.346		0.011	0.357	No
	Right Tilt	0.174		0.010	0.184	No
Body-worn	Rear	0.313	0.077		0.390	No
	Front	0.231	0.084		0.315	No
	Edge 2	0.219	0.044		0.263	No
	Rear	0.313		0.009	0.322	No
	Front	0.231		0.007	0.238	No
	Edge 2	0.219		0.006	0.225	No

Note:

- According to KDB 447498 D01 General RF Exposure Guidance, when the simultaneous transmission SAR is less than 1.6 W/kg, SPLSR assessment is not required.
- SPLSR mean is “The SAR to Peak Location Separation Ratio “

Any report having not been signed by authorized approver, or having been altered without authorization, or having not been stamped by the “Dedicated Testing/Inspection Stamp” is deemed to be invalid. Copying or excerpting portion of, or altering the content of the report is not permitted without the written authorization of AGC. The test results presented in the report apply only to the tested sample. Any objections to report issued by AGC should be submitted to AGC within 15 days after the issuance of the test report. Further enquiry of validity or verification of the test report should be addressed to AGC by agc@agc-cert.com.



Sum of the SAR for LTE Band 7 & Wi-Fi & BT:

RF Exposure Conditions	Test Position	Simultaneous Transmission Scenario			Σ1-g SAR (W/kg)	SPLSR (Yes/No)
		LTE Band 7	Wi-Fi DTS Band	Bluetooth(BR&EDR)		
Head	Left Touch	0.130	0.166		0.296	No
	Left Tilt	0.067	0.144		0.211	No
	Right Touch	0.071	0.100		0.171	No
	Right Tilt	0.103	0.074		0.177	No
Head	Left Touch	0.130		0.022	0.152	No
	Left Tilt	0.067		0.020	0.087	No
	Right Touch	0.071		0.011	0.082	No
	Right Tilt	0.103		0.010	0.113	No
Body-worn	Rear	1.052	0.077		1.129	No
	Front	1.292	0.084		1.376	No
	Edge 2	0.050	0.044		0.094	No
	Rear	1.052		0.009	1.061	No
	Front	1.292		0.007	1.299	No
	Edge 2	0.050		0.006	0.056	No

Note:

- According to KDB 447498 D01 General RF Exposure Guidance, when the simultaneous transmission SAR is less than 1.6 W/kg, SPLSR assessment is not required.
- SPLSR mean is “The SAR to Peak Location Separation Ratio “

Any report having not been signed by authorized approver, or having been altered without authorization, or having not been stamped by the “Dedicated Testing/Inspection Stamp” is deemed to be invalid. Copying or excerpting portion of, or altering the content of the report is not permitted without the written authorization of AGC. The test results presented in the report apply only to the tested sample. Any objections to report issued by AGC should be submitted to AGC within 15 days after the issuance of the test report. Further enquiry of validity or verification of the test report should be addressed to AGC by agc@agc-cert.com.



Sum of the SAR for LTE Band 12 & Wi-Fi & BT:

RF Exposure Conditions	Test Position	Simultaneous Transmission Scenario			Σ1-g SAR (W/kg)	SPLSR (Yes/No)
		LTE Band 12	Wi-Fi DTS Band	Bluetooth(BR&EDR)		
Head	Left Touch	0.269	0.166		0.435	No
	Left Tilt	0.147	0.144		0.291	No
	Right Touch	0.309	0.100		0.409	No
	Right Tilt	0.160	0.074		0.234	No
Head	Left Touch	0.269		0.022	0.291	No
	Left Tilt	0.147		0.020	0.167	No
	Right Touch	0.309		0.011	0.320	No
	Right Tilt	0.160		0.010	0.170	No
Body-worn	Rear	0.432	0.077		0.509	No
	Front	0.281	0.084		0.365	No
	Edge 2	0.251	0.044		0.295	No
	Rear	0.432		0.009	0.441	No
	Front	0.281		0.007	0.288	No
	Edge 2	0.251		0.006	0.257	No

Note:

- According to KDB 447498 D01 General RF Exposure Guidance, when the simultaneous transmission SAR is less than 1.6 W/kg, SPLSR assessment is not required.
- SPLSR mean is “The SAR to Peak Location Separation Ratio “

Any report having not been signed by authorized approver, or having been altered without authorization, or having not been stamped by the “Dedicated Testing/Inspection Stamp” is deemed to be invalid. Copying or excerpting portion of, or altering the content of the report is not permitted without the written authorization of AGC. The test results presented in the report apply only to the tested sample. Any objections to report issued by AGC should be submitted to AGC within 15 days after the issuance of the test report. Further enquiry of validity or verification of the test report should be addressed to AGC by agc@agc-cert.com.



Sum of the SAR for LTE Band 17 & Wi-Fi & BT:

RF Exposure Conditions	Test Position	Simultaneous Transmission Scenario			Σ1-g SAR (W/kg)	SPLSR (Yes/No)
		LTE Band 17	Wi-Fi DTS Band	Bluetooth(BR&EDR)		
Head	Left Touch	0.265	0.166		0.431	No
	Left Tilt	0.160	0.144		0.304	No
	Right Touch	0.313	0.100		0.413	No
	Right Tilt	0.174	0.074		0.248	No
Head	Left Touch	0.265		0.022	0.287	No
	Left Tilt	0.160		0.020	0.180	No
	Right Touch	0.313		0.011	0.324	No
	Right Tilt	0.174		0.010	0.184	No
Body-worn	Rear	0.434	0.077		0.511	No
	Front	0.289	0.084		0.373	No
	Edge 2	0.208	0.044		0.252	No
	Rear	0.434		0.009	0.443	No
	Front	0.289		0.007	0.296	No
	Edge 2	0.208		0.006	0.214	No

Note:

- According to KDB 447498 D01 General RF Exposure Guidance, when the simultaneous transmission SAR is less than 1.6 W/kg, SPLSR assessment is not required.
- SPLSR mean is “The SAR to Peak Location Separation Ratio “

Any report having not been signed by authorized approver, or having been altered without authorization, or having not been stamped by the “Dedicated Testing/Inspection Stamp” is deemed to be invalid. Copying or excerpting portion of, or altering the content of the report is not permitted without the written authorization of AGC. The test results presented in the report apply only to the tested sample. Any objections to report issued by AGC should be submitted to AGC within 15 days after the issuance of the test report. Further enquiry of validity or verification of the test report should be addressed to AGC by agc@agc-cert.com.



APPENDIX A. SAR SYSTEM CHECK DATA

Test Laboratory: AGC Lab

Date: Jan. 26, 2022

System Check Head 750 MHz

DUT: Dipole 750 MHz Type: SID 750

Communication System CW; Communication System Band: D750 (750.0 MHz); Duty Cycle: 1:1; Conv.F=5.35
Frequency: 750 MHz; Medium parameters used: $f = 750$ MHz; $\sigma = 0.90$ mho/m; $\epsilon_r = 41.44$; $\rho = 1000$ kg/m³ ;
Phantom section: Flat Section; Input Power=18dBm
Ambient temperature (°C):21.1, Liquid temperature (°C): 20.9

SATIMO Configuration:

- Probe: SSE5; Calibrated: Aug. 17, 2021; Serial No.: SN 24/20 EP336
- Sensor-Surface: 4mm (Mechanical Surface Detection)
- Phantom: SAM twin phantom
- Measurement SW: OpenSAR V4_02_35

Configuration/System Check 750MHz Head/Area Scan: Measurement grid: dx=8mm, dy=8mm

Configuration/System Check 750MHz Head/Zoom Scan: Measurement grid: dx=8mm,dy=8mm, dz=5mm

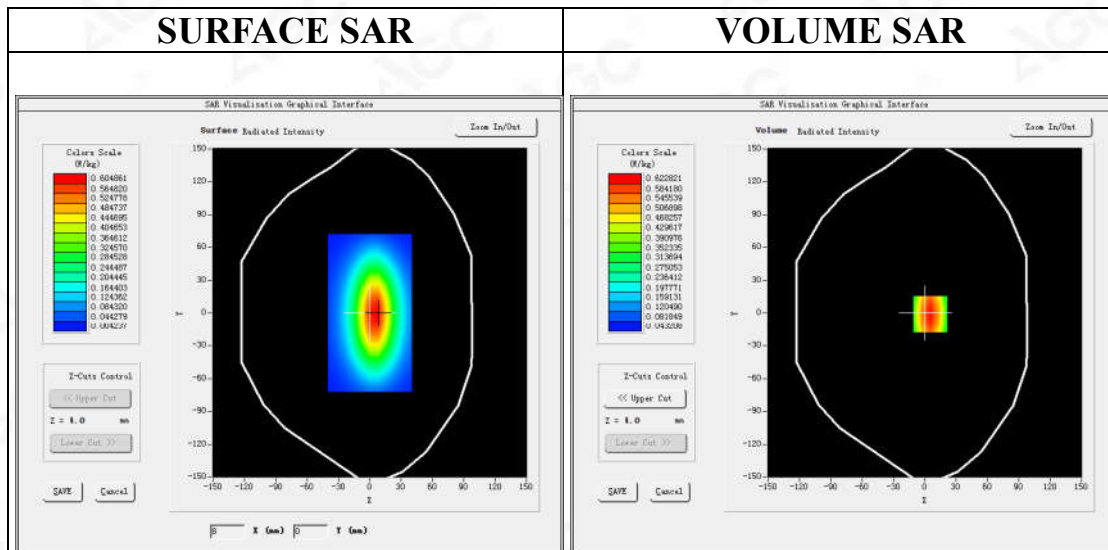

Maximum location: X=5.00, Y=-1.00

SAR Peak: 0.89 W/kg

SAR 10g (W/Kg)	0.347610
SAR 1g (W/Kg)	0.556741

Any report having not been signed by authorized approver, or having been altered without authorization, or having not been stamped by the "Dedicated Testing/Inspection Stamp" is deemed to be invalid. Copying or excerpting portion of, or altering the content of the report is not permitted without the written authorization of AGC. The test results presented in the report apply only to the tested sample. Any objections to report issued by AGC should be submitted to AGC within 15days after the issuance of the test report. Further enquiry of validity or verification of the test report should be addressed to AGC by agc@agc-cert.com.

Attestation of Global Compliance(Shenzhen)Co., Ltd

Attestation of Global Compliance(Shenzhen)Std & Tech Co., Ltd

Tel: +86-755 2523 4088 E-mail: agc@agc-cert.com Web: http://cn.agc-cert.com/



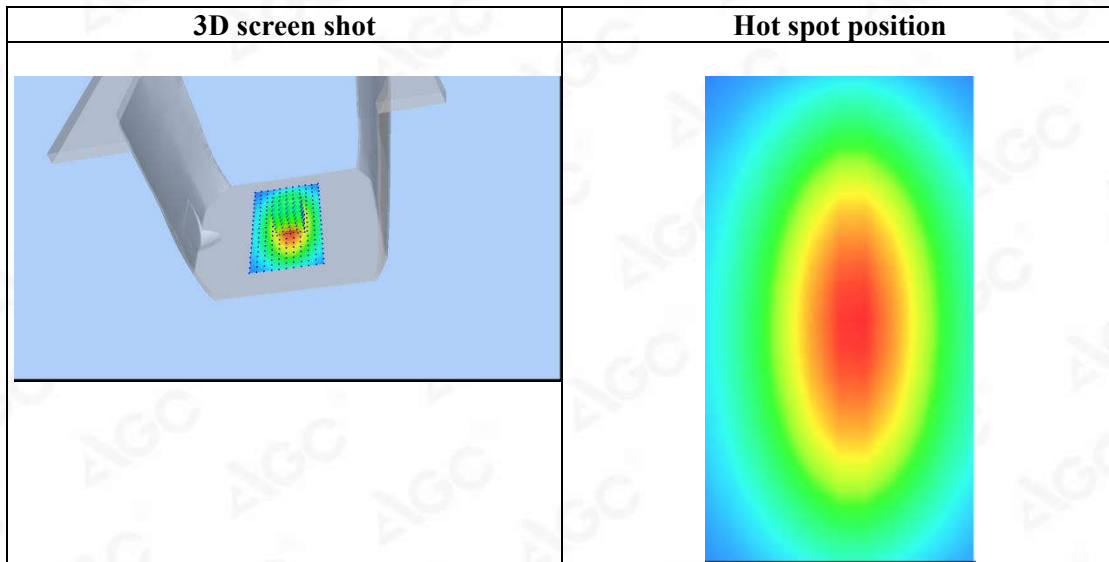
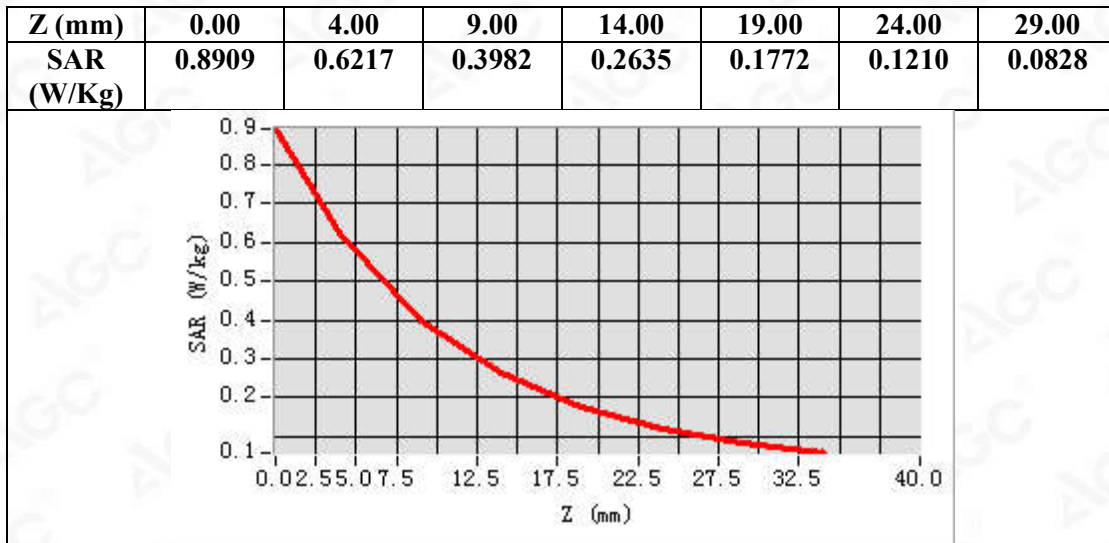

Any report having not been signed by authorized approver, or having been altered without authorization, or having not been stamped by the "Dedicated Testing/Inspection Stamp" is deemed to be invalid. Copying or excerpting portion of, or altering the content of the report is not permitted without the written authorization of AGC. The test results presented in the report apply only to the tested sample. Any objections to report issued by AGC should be submitted to AGC within 15 days after the issuance of the test report. Further enquiry of validity or verification of the test report should be addressed to AGC by agc@agc-cert.com.



Test Laboratory: AGC Lab
System Check Head 835 MHz
DUT: Dipole 835 MHz Type: SID 835

Date: Jan. 20, 2022

Communication System CW; Communication System Band: D835 (835.0 MHz); Duty Cycle: 1:1; Conv.F=5.21
Frequency: 835 MHz; Medium parameters used: $f = 835$ MHz; $\sigma=0.90$ mho/m; $\epsilon_r=41.72$; $\rho= 1000$ kg/m³ ;
Phantom section: Flat Section; Input Power=18dBm
Ambient temperature (°C):20.8, Liquid temperature (°C): 20.6

SATIMO Configuration:

- Probe: SSE5; Calibrated: Aug. 17, 2021; Serial No.: SN 24/20 EP336
- Sensor-Surface: 4mm (Mechanical Surface Detection)
- Phantom: SAM twin phantom
- Measurement SW: OpenSAR V4_02_35

Configuration/System Check 835MHz Head/Area Scan: Measurement grid: dx=8mm, dy=8mm
Configuration/System Check 835MHz Head/Zoom Scan: Measurement grid: dx=8mm,dy=8mm, dz=5mm

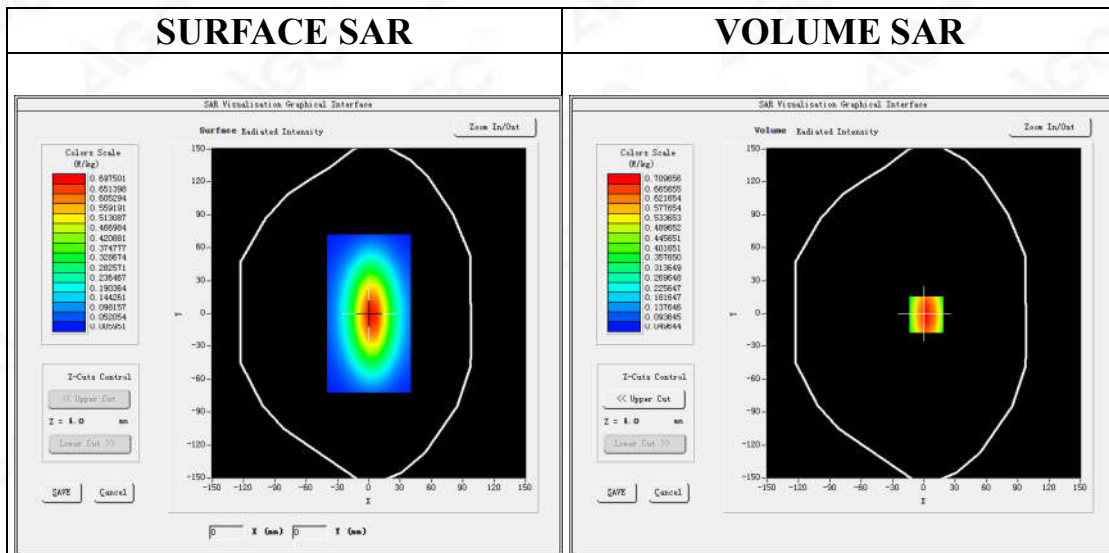

Maximum location: X=2.00, Y=-1.00
SAR Peak: 1.01 W/kg

SAR 10g (W/Kg)	0.412779
SAR 1g (W/Kg)	0.653794

Any report having not been signed by authorized approver, or having been altered without authorization, or having not been stamped by the "Dedicated Testing/Inspection Stamp" is deemed to be invalid. Copying or excerpting portion of, or altering the content of the report is not permitted without the written authorization of AGC. The test results presented in the report apply only to the tested sample. Any objections to report issued by AGC should be submitted to AGC within 15days after the issuance of the test report. Further enquiry of validity or verification of the test report should be addressed to AGC by agc@agc-cert.com.



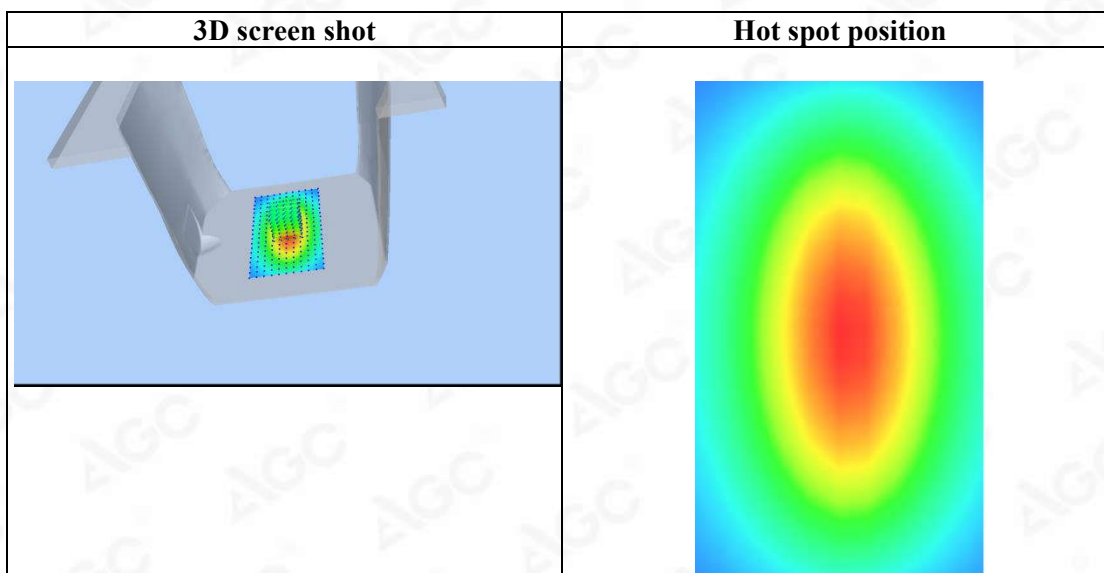
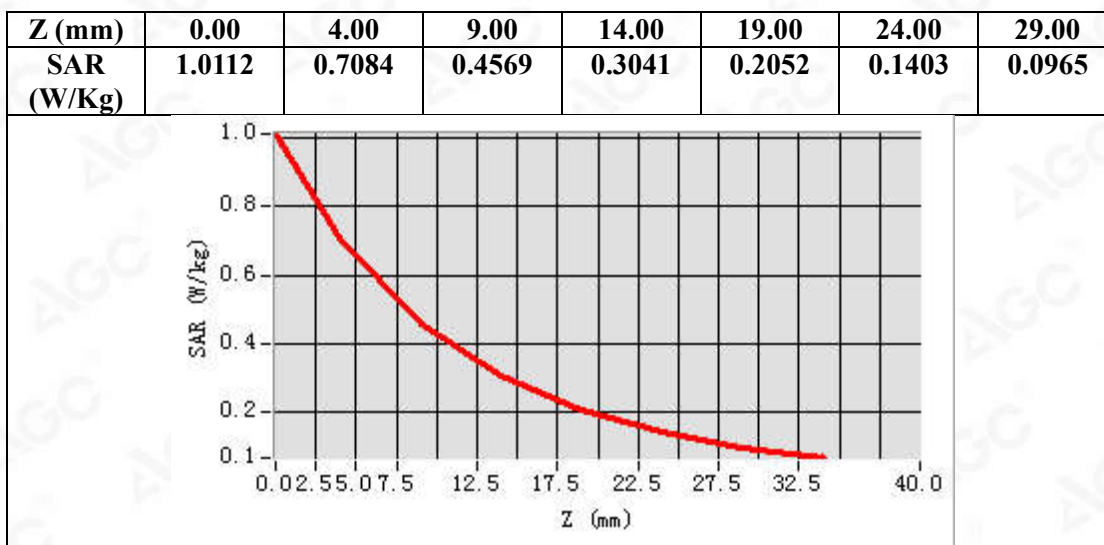

Any report having not been signed by authorized approver, or having been altered without authorization, or having not been stamped by the "Dedicated Testing/Inspection Stamp" is deemed to be invalid. Copying or excerpting portion of, or altering the content of the report is not permitted without the written authorization of AGC. The test results presented in the report apply only to the tested sample. Any objections to report issued by AGC should be submitted to AGC within 15 days after the issuance of the test report. Further enquiry of validity or verification of the test report should be addressed to AGC by agc@agc-cert.com.



Test Laboratory: AGC Lab
System Check Head 835 MHz
DUT: Dipole 835 MHz Type: SID 835

Date: Jan. 24, 2022

Communication System CW; Communication System Band: D835 (835.0 MHz); Duty Cycle: 1:1; Conv.F=5.21
Frequency: 835 MHz; Medium parameters used: $f = 835$ MHz; $\sigma=0.89$ mho/m; $\epsilon_r=41.46$; $\rho= 1000$ kg/m³ ;
Phantom section: Flat Section; Input Power=18dBm
Ambient temperature (°C):22.0, Liquid temperature (°C): 21.8

SATIMO Configuration:

- Probe: SSE5; Calibrated: Aug. 17, 2021; Serial No.: SN 24/20 EP336
- Sensor-Surface: 4mm (Mechanical Surface Detection)
- Phantom: SAM twin phantom
- Measurement SW: OpenSAR V4_02_35

Configuration/System Check 835MHz Head/Area Scan: Measurement grid: dx=8mm, dy=8mm

Configuration/System Check 835MHz Head/Zoom Scan: Measurement grid: dx=8mm,dy=8mm, dz=5mm

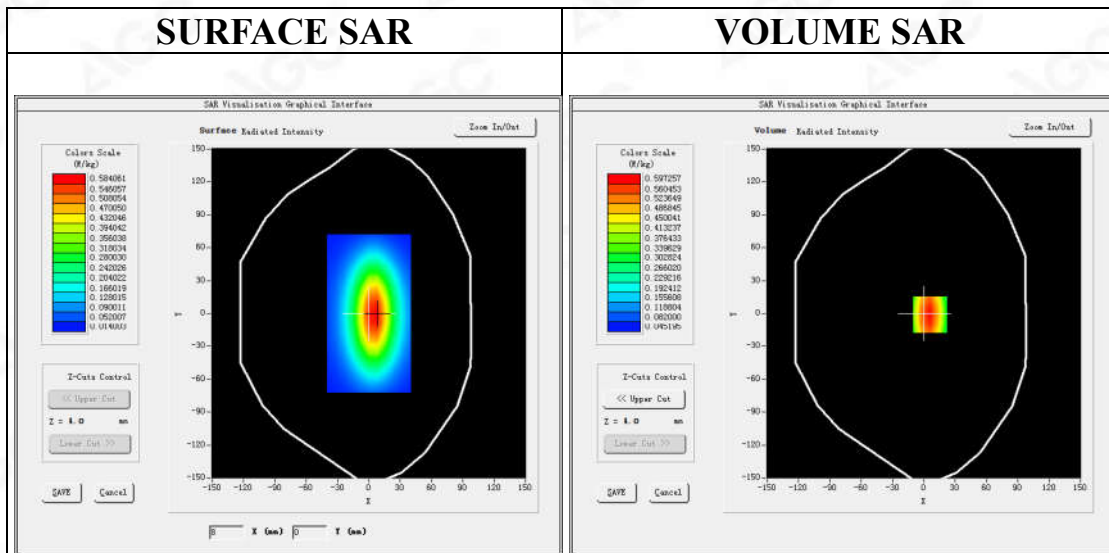

Maximum location: X=6.00, Y=-1.00
SAR Peak: 0.85 W/kg

SAR 10g (W/Kg)	0.380672
SAR 1g (W/Kg)	0.570323

Any report having not been signed by authorized approver, or having been altered without authorization, or having not been stamped by the "Dedicated Testing/Inspection Stamp" is deemed to be invalid. Copying or excerpting portion of, or altering the content of the report is not permitted without the written authorization of AGC. The test results presented in the report apply only to the tested sample. Any objections to report issued by AGC should be submitted to AGC within 15days after the issuance of the test report. Further enquiry of validity or verification of the test report should be addressed to AGC by agc@agc-cert.com.



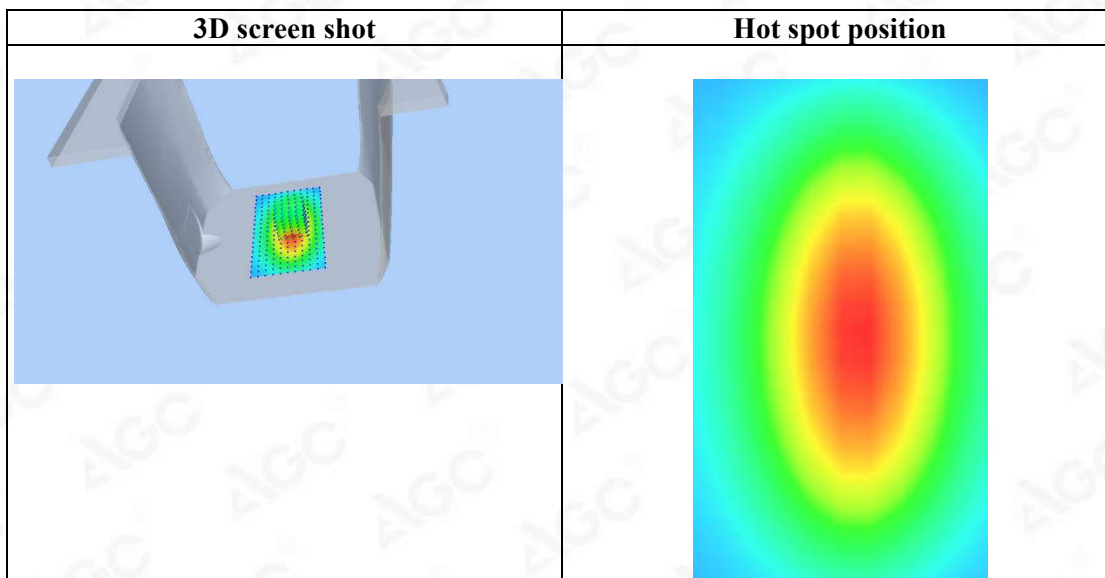
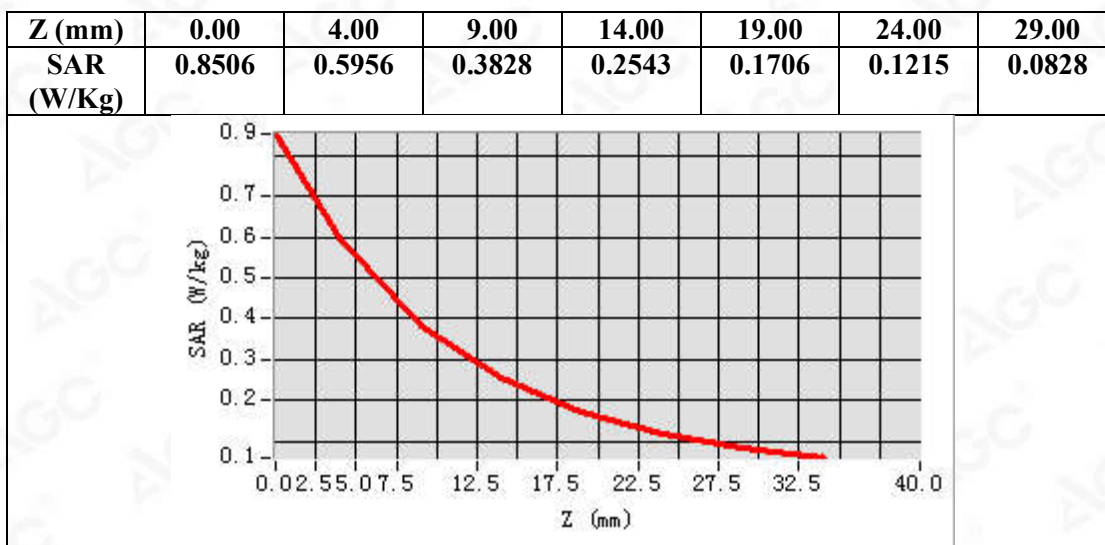

Any report having not been signed by authorized approver, or having been altered without authorization, or having not been stamped by the "Dedicated Testing/Inspection Stamp" is deemed to be invalid. Copying or excerpting portion of, or altering the content of the report is not permitted without the written authorization of AGC. The test results presented in the report apply only to the tested sample. Any objections to report issued by AGC should be submitted to AGC within 15 days after the issuance of the test report. Further enquiry of validity or verification of the test report should be addressed to AGC by agc@agc-cert.com.



Test Laboratory: AGC Lab
System Check Head 1750MHz
DUT: Dipole 1800 MHz; Type: SID 1800

Date: Jan. 21, 2022

Communication System: CW; Communication System Band: D1700 (1750.0 MHz); Duty Cycle:1:1; Conv.F=4.94
Frequency: 1750 MHz; Medium parameters used: $f = 1750\text{MHz}$; $\sigma = 1.38 \text{ mho/m}$; $\epsilon_r = 39.94$; $\rho = 1000 \text{ kg/m}^3$;
Phantom section: Flat Section; Input Power=18dBm
Ambient temperature ($^{\circ}\text{C}$): 21.0, Liquid temperature ($^{\circ}\text{C}$): 20.8

SATIMO Configuration:

Probe: SSE5; Calibrated: Aug. 17, 2021; Serial No.: SN 24/20 EP336

- Sensor-Surface: 4mm (Mechanical Surface Detection)
- Phantom: SAM twin phantom
- Measurement SW: OpenSAR V4_02_35

Configuration/System Check 1750MHz Head/Area Scan: Measurement grid: dx=8mm,dy=8mm

Configuration/System Check 1750MHz Head/Zoom Scan: Measurement grid: dx=8mm,dy=8mm, dz=5mm

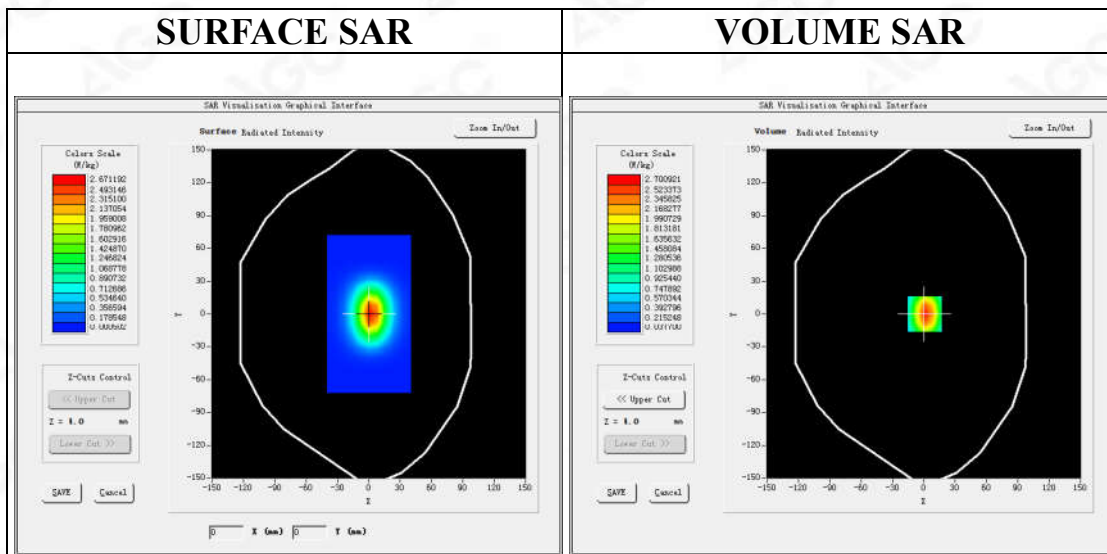

Maximum location: X=1.00, Y=0.00
SAR Peak: 4.41 W/kg

SAR 10g (W/Kg)	1.285661
SAR 1g (W/Kg)	2.551216

Any report having not been signed by authorized approver, or having been altered without authorization, or having not been stamped by the "Dedicated Testing/Inspection Stamp" is deemed to be invalid. Copying or excerpting portion of, or altering the content of the report is not permitted without the written authorization of AGC. The test results presented in the report apply only to the tested sample. Any objections to report issued by AGC should be submitted to AGC within 15days after the issuance of the test report. Further enquiry of validity or verification of the test report should be addressed to AGC by agc@agc-cert.com.



Z (mm)	0.00	4.00	9.00	14.00	19.00	24.00	29.00
SAR (W/Kg)	4.4166	2.7014	1.4128	0.7701	0.4306	0.2432	0.1364

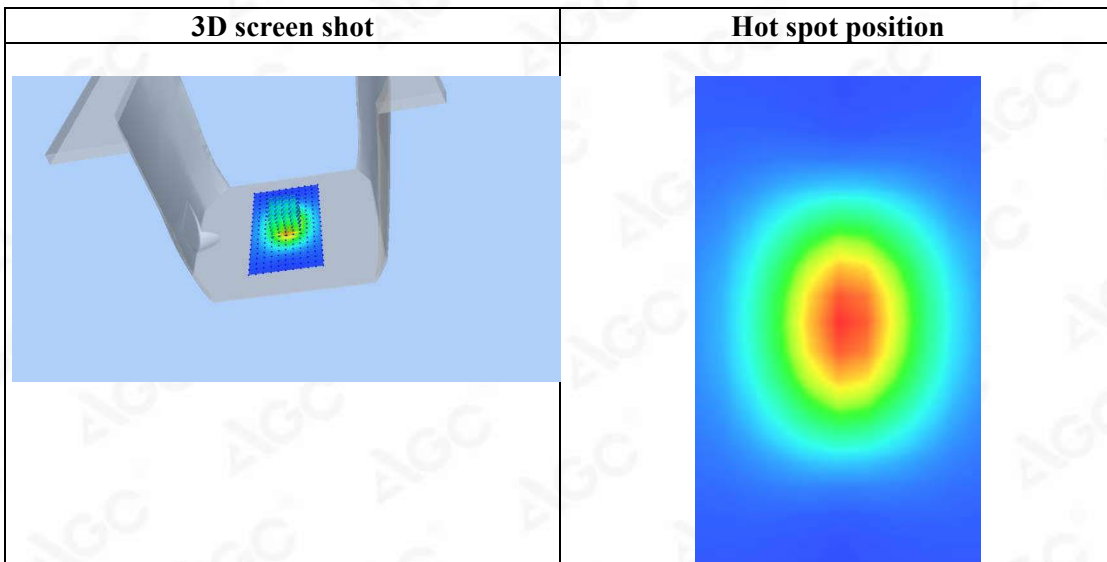
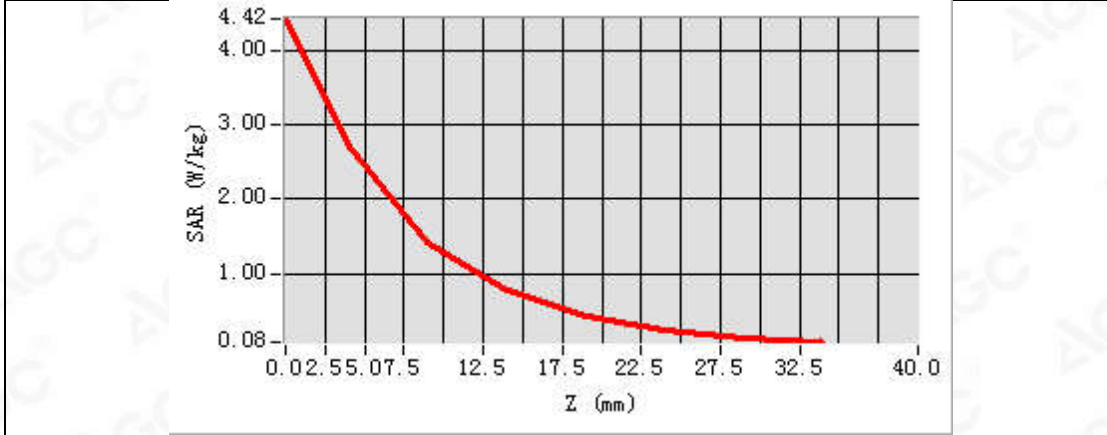

Any report having not been signed by authorized approver, or having been altered without authorization, or having not been stamped by the "Dedicated Testing/Inspection Stamp" is deemed to be invalid. Copying or excerpting portion of, or altering the content of the report is not permitted without the written authorization of AGC. The test results presented in the report apply only to the tested sample. Any objections to report issued by AGC should be submitted to AGC within 15 days after the issuance of the test report. Further enquiry of validity or verification of the test report should be addressed to AGC by agc@agc-cert.com.



Test Laboratory: AGC Lab
System Check Head 1900MHz
DUT: Dipole 1900 MHz; Type: SID 1900

Date: Jan. 21, 2022

Communication System: CW; Communication System Band: D1900 (1900.0 MHz); Duty Cycle:1:1; Conv.F=4.57
Frequency: 1900 MHz; Medium parameters used: $f = 1800$ MHz; $\sigma = 1.38$ mho/m; $\epsilon_r = 38.45$; $\rho = 1000$ kg/m³ ;
Phantom section: Flat Section; Input Power=18dBm
Ambient temperature (°C):21.0, Liquid temperature (°C): 20.7

SATIMO Configuration:

Probe: SSE5; Calibrated: Aug. 17, 2021; Serial No.: SN 24/20 EP336

- Sensor-Surface: 4mm (Mechanical Surface Detection)
- Phantom: SAM twin phantom
- Measurement SW: OpenSAR V4_02_35

Configuration/System Check 1900MHz Head/Area Scan: Measurement grid: dx=8mm, dy=8mm

Configuration/System Check 1900MHz Head/Zoom Scan: Measurement grid: dx=8mm,dy=8mm, dz=5mm

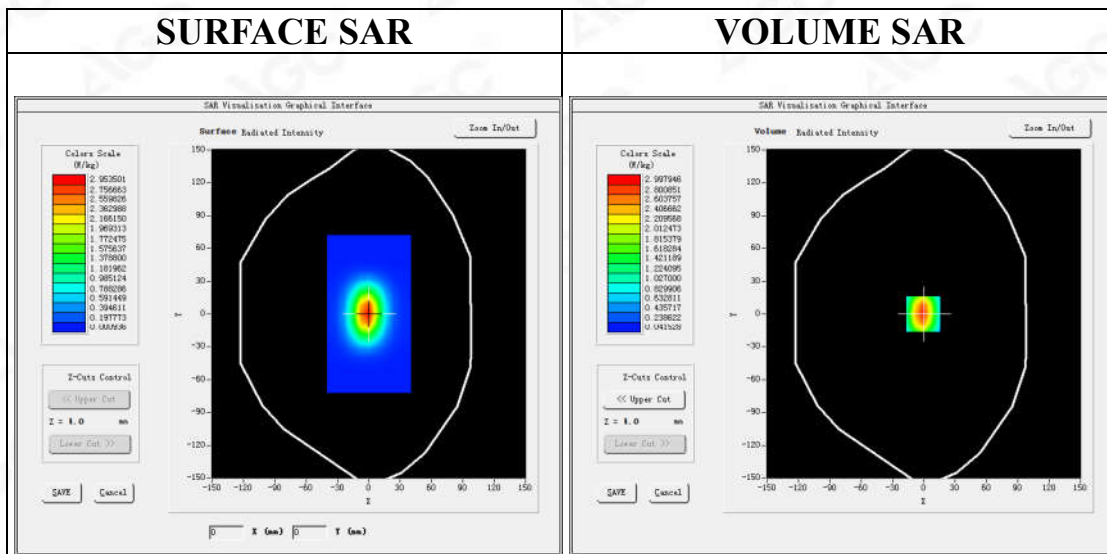

Maximum location: X=-1.00, Y=0.00

SAR Peak: 4.87 W/kg

SAR 10g (W/Kg)	1.363125
SAR 1g (W/Kg)	2.754152

Any report having not been signed by authorized approver, or having been altered without authorization, or having not been stamped by the "Dedicated Testing/Inspection Stamp" is deemed to be invalid. Copying or excerpting portion of, or altering the content of the report is not permitted without the written authorization of AGC. The test results presented in the report apply only to the tested sample. Any objections to report issued by AGC should be submitted to AGC within 15days after the issuance of the test report. Further enquiry of validity or verification of the test report should be addressed to AGC by agc@agc-cert.com.



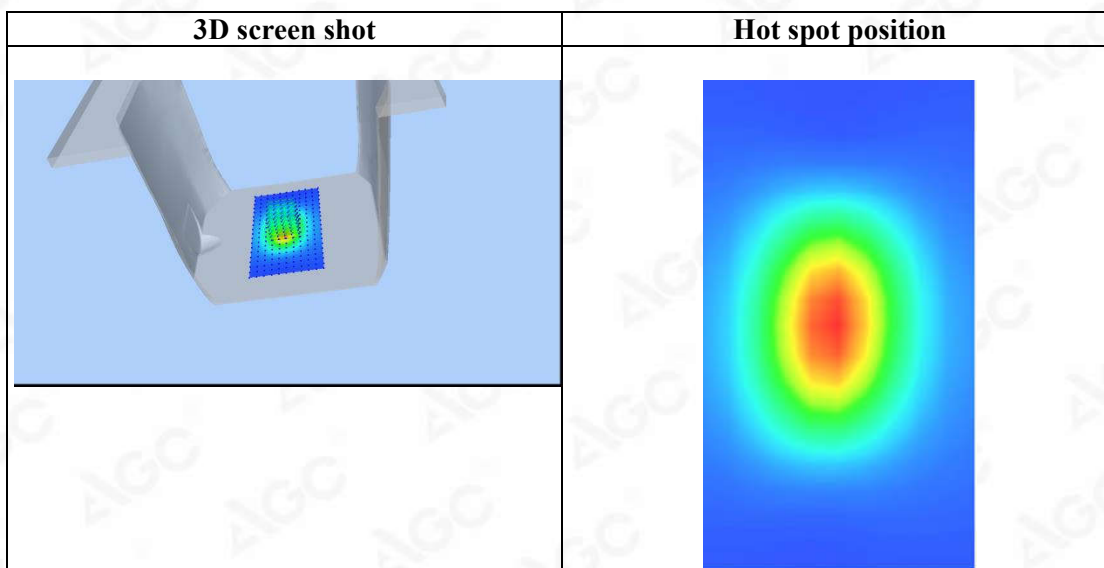
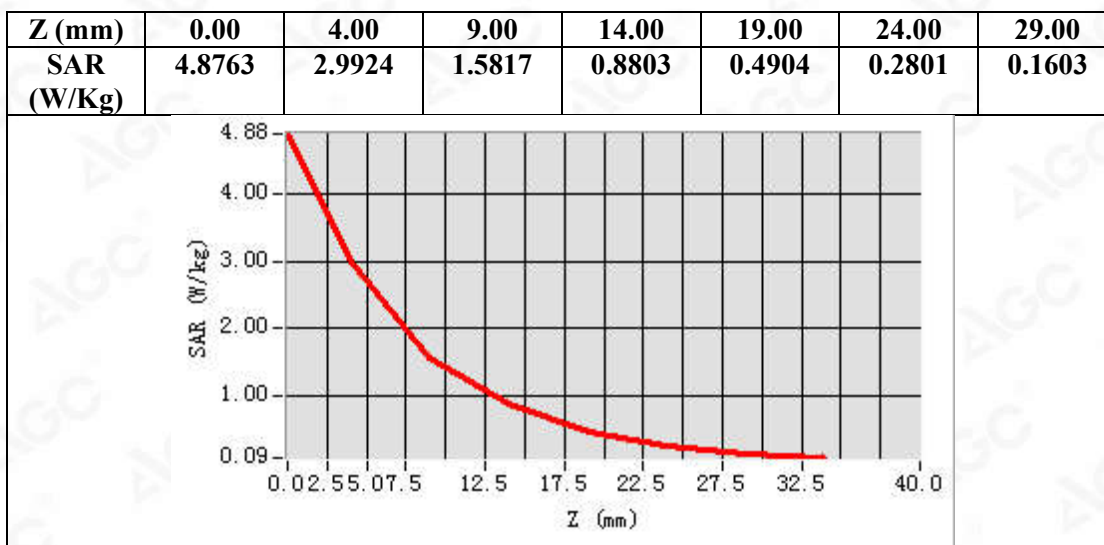

Any report having not been signed by authorized approver, or having been altered without authorization, or having not been stamped by the "Dedicated Testing/Inspection Stamp" is deemed to be invalid. Copying or excerpting portion of, or altering the content of the report is not permitted without the written authorization of AGC. The test results presented in the report apply only to the tested sample. Any objections to report issued by AGC should be submitted to AGC within 15days after the issuance of the test report. Further enquiry of validity or verification of the test report should be addressed to AGC by agc@agc-cert.com.



Test Laboratory: AGC Lab
System Check Head 1900MHz
DUT: Dipole 1900 MHz; Type: SID 1900

Date: Jan. 25, 2022

Communication System: CW; Communication System Band: D1900 (1900.0 MHz); Duty Cycle:1:1; Conv.F=4.57
Frequency: 1900 MHz; Medium parameters used: $f = 1800$ MHz; $\sigma = 1.41$ mho/m; $\epsilon_r = 39.75$; $\rho = 1000$ kg/m³ ;
Phantom section: Flat Section; Input Power=18dBm
Ambient temperature (°C):21.3, Liquid temperature (°C): 21.1

SATIMO Configuration:

- Probe: SSE5; Calibrated: Aug. 17, 2021; Serial No.: SN 24/20 EP336
- Sensor-Surface: 4mm (Mechanical Surface Detection)
- Phantom: SAM twin phantom
- Measurement SW: OpenSAR V4_02_35

Configuration/System Check 1900MHz Head/Area Scan: Measurement grid: dx=8mm, dy=8mm

Configuration/System Check 1900MHz Head/Zoom Scan: Measurement grid: dx=8mm,dy=8mm, dz=5mm

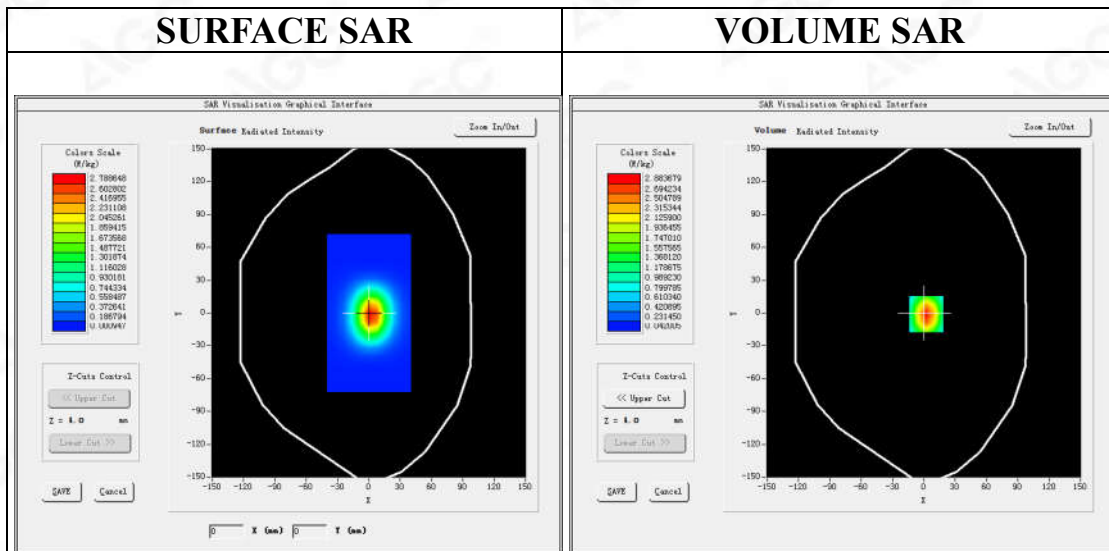

Maximum location: X=2.00, Y=-1.00
SAR Peak: 4.60 W/kg

SAR 10g (W/Kg)	1.276732
SAR 1g (W/Kg)	2.500765

Any report having not been signed by authorized approver, or having been altered without authorization, or having not been stamped by the "Dedicated Testing/Inspection Stamp" is deemed to be invalid. Copying or excerpting portion of, or altering the content of the report is not permitted without the written authorization of AGC. The test results presented in the report apply only to the tested sample. Any objections to report issued by AGC should be submitted to AGC within 15days after the issuance of the test report. Further enquiry of validity or verification of the test report should be addressed to AGC by agc@agc-cert.com.



Z (mm)	0.00	4.00	9.00	14.00	19.00	24.00	29.00
SAR (W/Kg)	4.6255	2.8817	1.5505	0.8648	0.4912	0.2863	0.1618

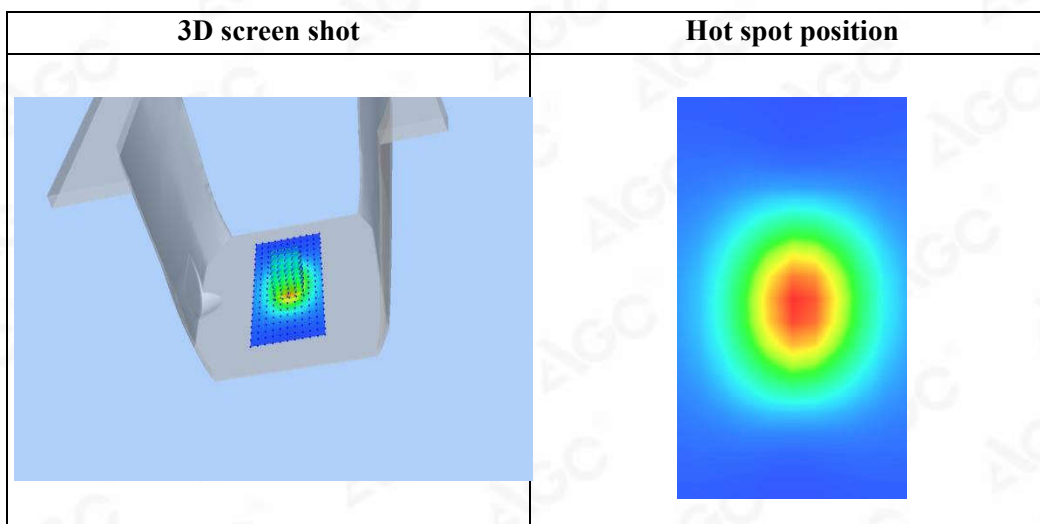
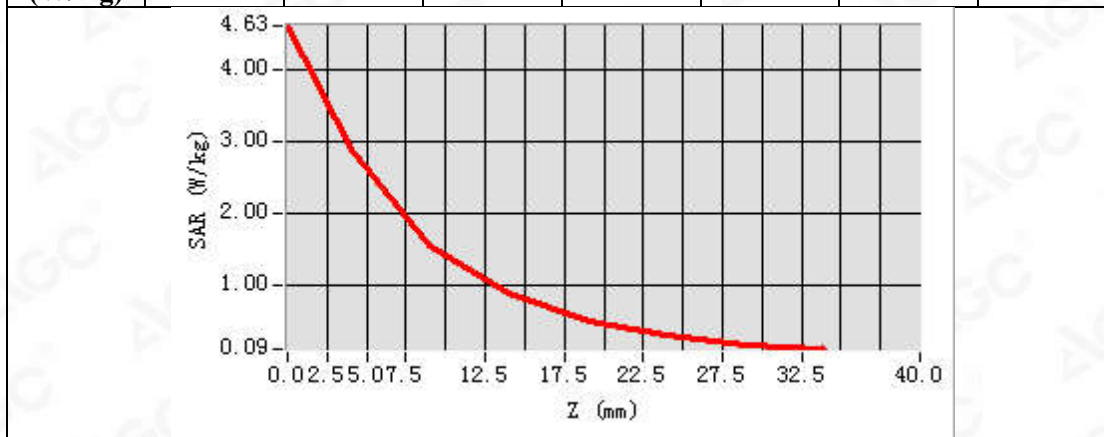

Any report having not been signed by authorized approver, or having been altered without authorization, or having not been stamped by the "Dedicated Testing/Inspection Stamp" is deemed to be invalid. Copying or excerpting portion of, or altering the content of the report is not permitted without the written authorization of AGC. The test results presented in the report apply only to the tested sample. Any objections to report issued by AGC should be submitted to AGC within 15days after the issuance of the test report. Further enquiry of validity or verification of the test report should be addressed to AGC by agc@agc-cert.com.



Test Laboratory: AGC Lab
System Check Head 2450 MHz
DUT: Dipole 2450 MHz Type: SID 2450

Date: Jan. 22, 2022

Communication System CW; Communication System Band: D2450 (2450.0 MHz); Duty Cycle: 1:1; Conv.F=4.02
Frequency: 2450 MHz; Medium parameters used: $f = 2450$ MHz; $\sigma = 1.79$ mho/m; $\epsilon_r = 38.94$; $\rho = 1000$ kg/m³ ;
Phantom section: Flat Section; Input Power=18dBm
Ambient temperature (°C):21.3, Liquid temperature (°C): 21.2

SATIMO Configuration

- Probe: SSE5; Calibrated: Aug. 17, 2021; Serial No.: SN 24/20 EP336
- Sensor-Surface: 4mm (Mechanical Surface Detection)
- Phantom: SAM twin phantom
- Measurement SW: OpenSAR V4_02_35

Configuration/System Check 2450MHz Head/Area Scan: Measurement grid: dx=8mm, dy=8mm

Configuration/System Check 2450MHz Head/Zoom Scan: Measurement grid: dx=5mm,dy=5mm, dz=5mm

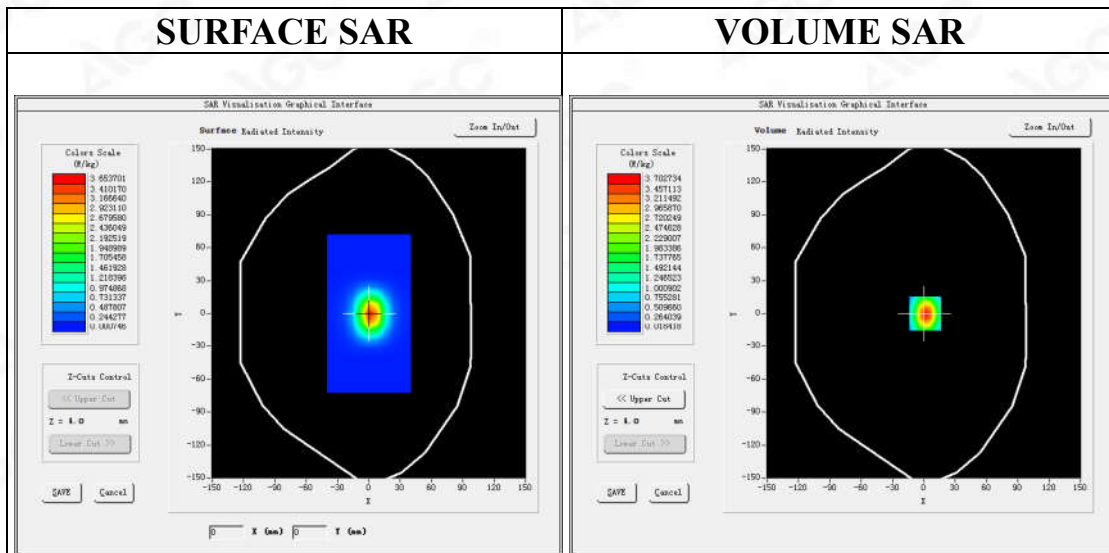

Maximum location: X=1.00, Y=0.00

SAR Peak: 6.40 W/kg

SAR 10g (W/Kg)	1.535260
SAR 1g (W/Kg)	3.420708

Any report having not been signed by authorized approver, or having been altered without authorization, or having not been stamped by the "Dedicated Testing/Inspection Stamp" is deemed to be invalid. Copying or excerpting portion of, or altering the content of the report is not permitted without the written authorization of AGC. The test results presented in the report apply only to the tested sample. Any objections to report issued by AGC should be submitted to AGC within 15days after the issuance of the test report. Further enquiry of validity or verification of the test report should be addressed to AGC by agc@agc-cert.com.



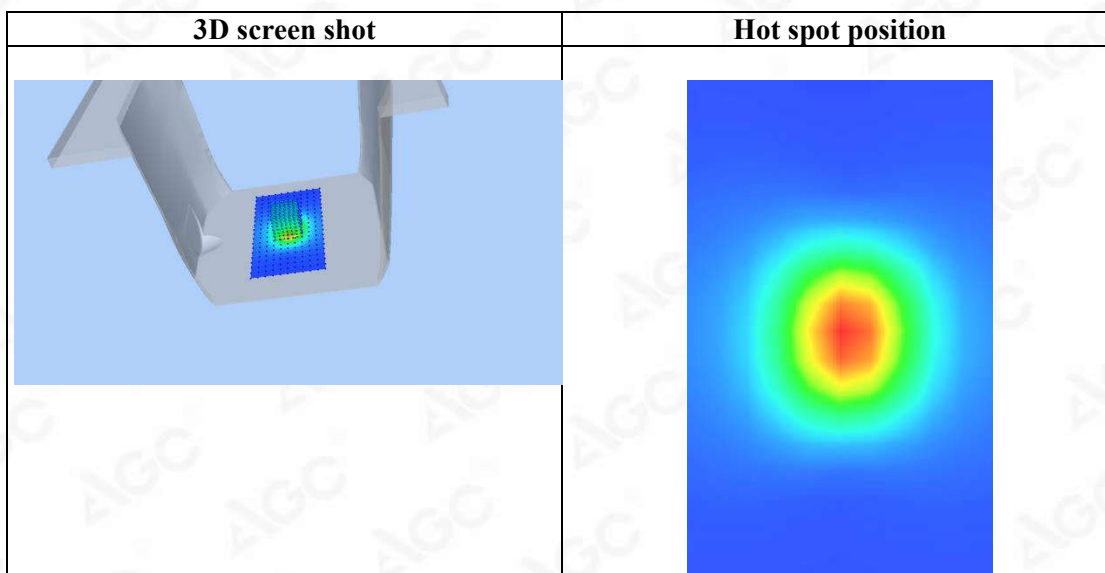
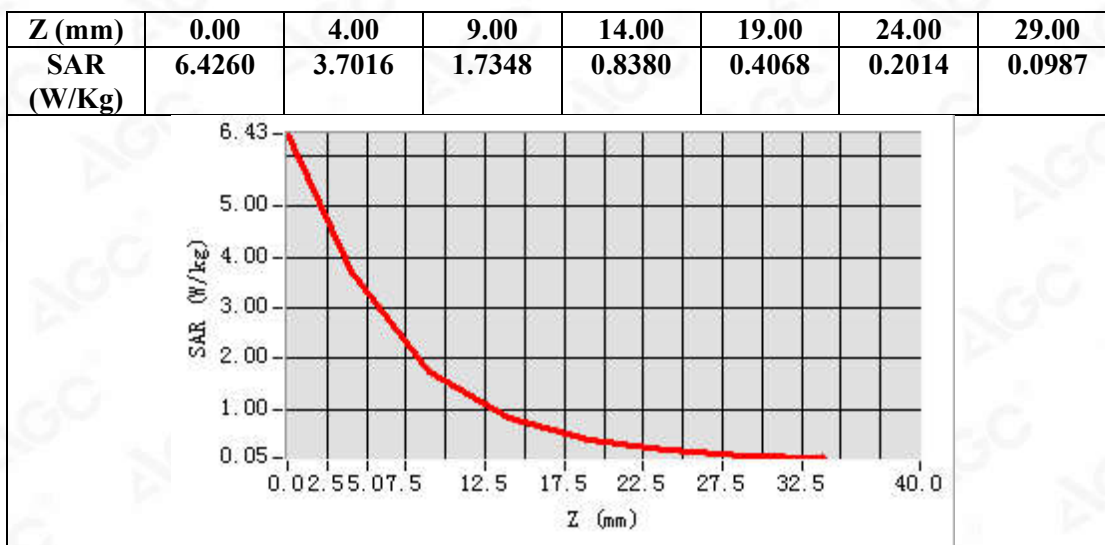

Any report having not been signed by authorized approver, or having been altered without authorization, or having not been stamped by the "Dedicated Testing/Inspection Stamp" is deemed to be invalid. Copying or excerpting portion of, or altering the content of the report is not permitted without the written authorization of AGC. The test results presented in the report apply only to the tested sample. Any objections to report issued by AGC should be submitted to AGC within 15days after the issuance of the test report. Further enquiry of validity or verification of the test report should be addressed to AGC by agc@agc-cert.com.



Test Laboratory: AGC Lab
System Check Head 2600MHz
DUT: Dipole 2600 MHz; Type: SID 2600

Date: Jan. 22, 2022

Communication System: CW; Communication System Band: D2600 (2600.0 MHz); Duty Cycle: 1:1; Conv.F=3.89
Frequency:2600 MHz; Medium parameters used: $f = 2600$ MHz; $\sigma = 1.95$ mho/m; $\epsilon_r = 38.56$; $\rho = 1000$ kg/m³ ;
Phantom section: Flat Section; Input Power=18dBm
Ambient temperature (°C): 21.3, Liquid temperature (°C): 21.2

SATIMO Configuration:

- Probe: SSE5; Calibrated: Aug. 17, 2021; Serial No.: SN 24/20 EP336
- Sensor-Surface: 4mm (Mechanical Surface Detection)
- Phantom: SAM twin phantom
- Measurement SW: OpenSAR V4_02_35

Configuration/System Check 2600 Head/Area Scan: Measurement grid: dx=8mm,dy=8mm

Configuration/System Check 2600 Head/Zoom Scan: Measurement grid: dx=5mm,dy=5mm, dz=5mm

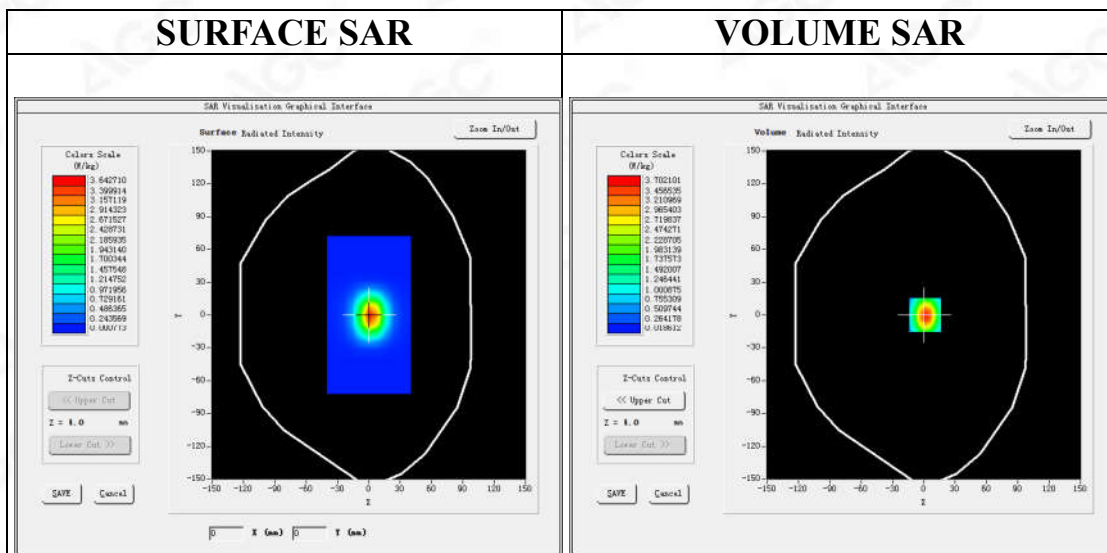

Maximum location: X=1.00, Y=0.00

SAR Peak: 6.40 W/kg

SAR 10g (W/Kg)	1.531706
SAR 1g (W/Kg)	3.423273

Any report having not been signed by authorized approver, or having been altered without authorization, or having not been stamped by the "Dedicated Testing/Inspection Stamp" is deemed to be invalid. Copying or excerpting portion of, or altering the content of the report is not permitted without the written authorization of AGC. The test results presented in the report apply only to the tested sample. Any objections to report issued by AGC should be submitted to AGC within 15days after the issuance of the test report. Further enquiry of validity or verification of the test report should be addressed to AGC by agc@agc-cert.com.



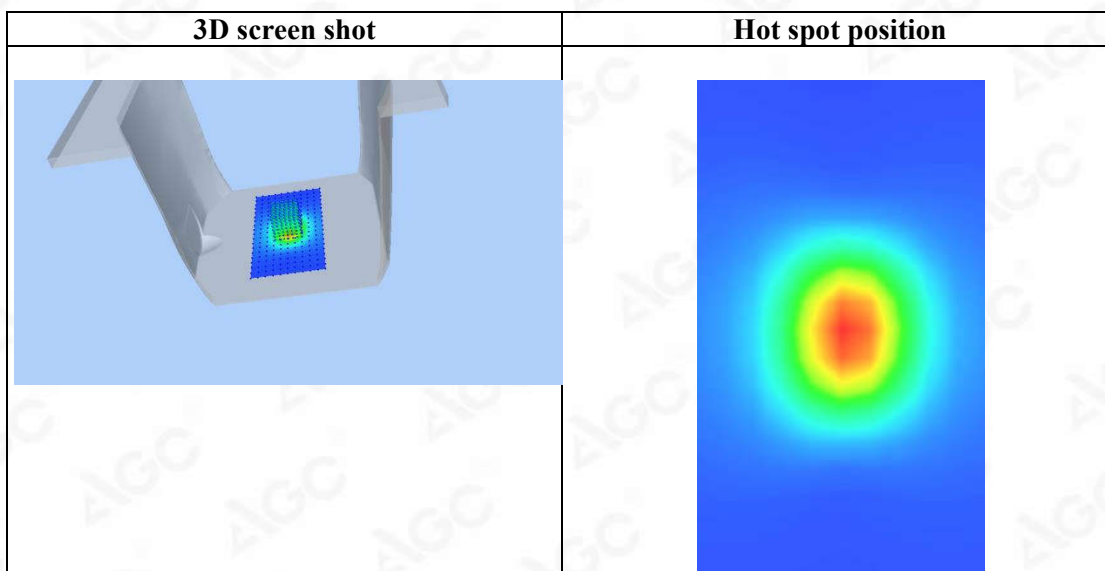
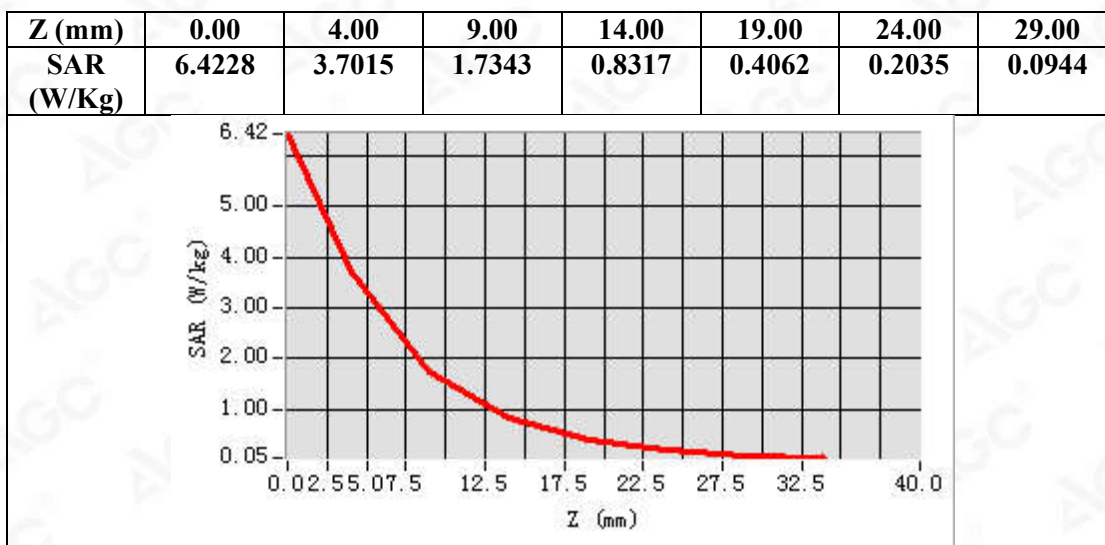

Any report having not been signed by authorized approver, or having been altered without authorization, or having not been stamped by the "Dedicated Testing/Inspection Stamp" is deemed to be invalid. Copying or excerpting portion of, or altering the content of the report is not permitted without the written authorization of AGC. The test results presented in the report apply only to the tested sample. Any objections to report issued by AGC should be submitted to AGC within 15days after the issuance of the test report. Further enquiry of validity or verification of the test report should be addressed to AGC by agc@agc-cert.com.



Test Laboratory: AGC Lab
System Check Head 750 MHz
DUT: Dipole 750 MHz Type: SID 750

Date: Jan. 26, 2022

Communication System CW; Communication System Band: D750 (750.0 MHz); Duty Cycle: 1:1; Conv.F=5.35
Frequency: 750 MHz; Medium parameters used: $f = 750$ MHz; $\sigma=0.90$ mho/m; $\epsilon_r=41.44$; $\rho= 1000$ kg/m³ ;
Phantom section: Flat Section; Input Power=18dBm
Ambient temperature (°C):21.1, Liquid temperature (°C): 20.9

SATIMO Configuration:

- Probe: SSE5; Calibrated: Aug. 17, 2021; Serial No.: SN 24/20 EP336
- Sensor-Surface: 4mm (Mechanical Surface Detection)
- Phantom: ELLI39 Phantom
- Measurement SW: OpenSAR V4_02_35

Configuration/System Check 750MHz Head/Area Scan: Measurement grid: dx=8mm, dy=8mm

Configuration/System Check 750MHz Head/Zoom Scan: Measurement grid: dx=8mm,dy=8mm, dz=5mm

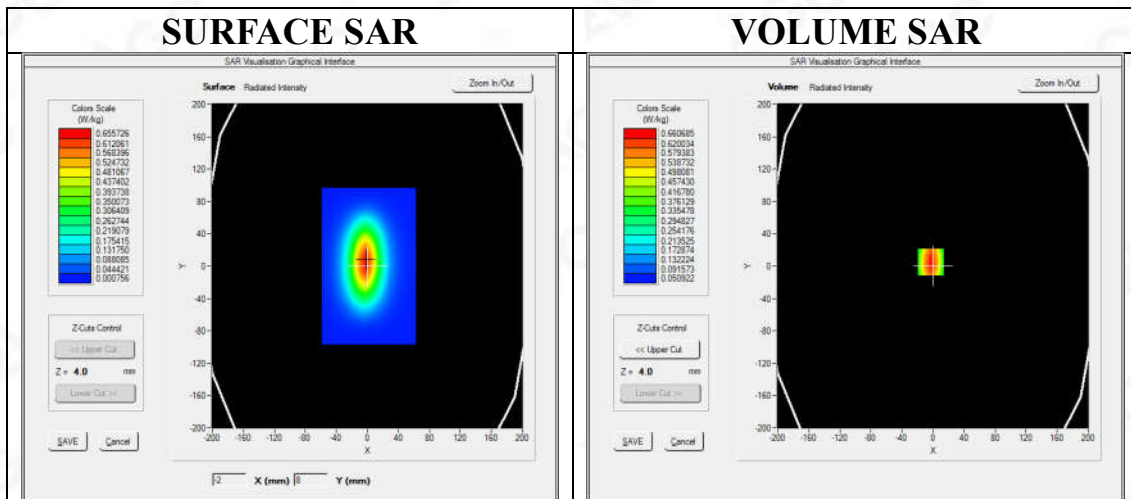

Maximum location: X=-3.00, Y=5.00
SAR Peak: 0.93 W/kg

SAR 10g (W/Kg)	0.356473
SAR 1g (W/Kg)	0.551246

Any report having not been signed by authorized approver, or having been altered without authorization, or having not been stamped by the "Dedicated Testing/Inspection Stamp" is deemed to be invalid. Copying or excerpting portion of, or altering the content of the report is not permitted without the written authorization of AGC. The test results presented in the report apply only to the tested sample. Any objections to report issued by AGC should be submitted to AGC within 15days after the issuance of the test report. Further enquiry of validity or verification of the test report should be addressed to AGC by agc@agc-cert.com.



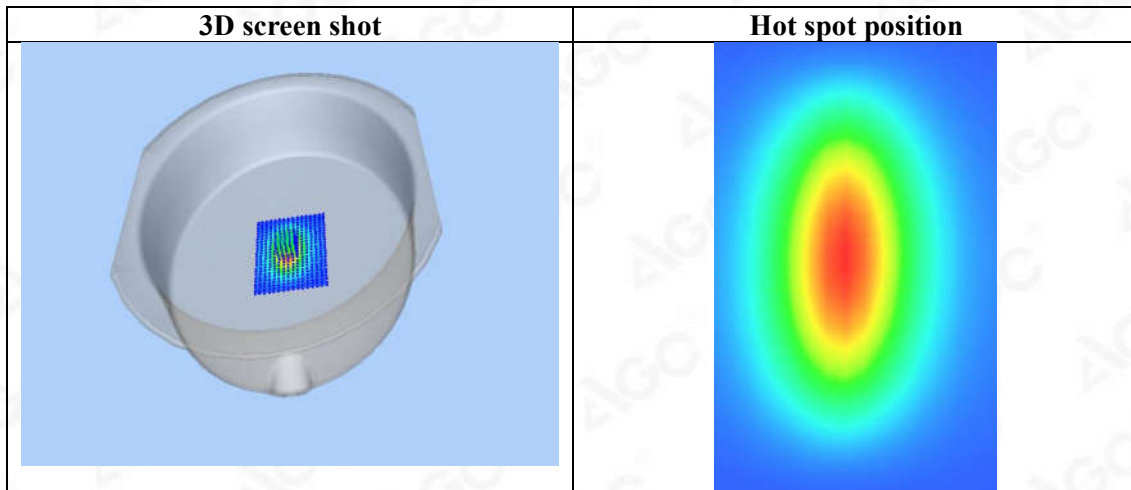
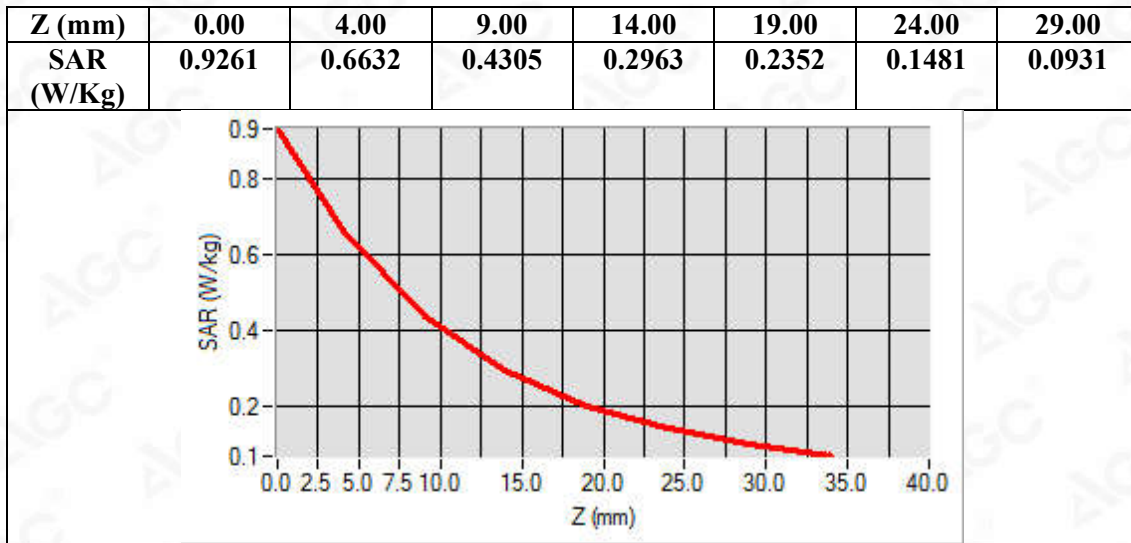

Any report having not been signed by authorized approver, or having been altered without authorization, or having not been stamped by the "Dedicated Testing/Inspection Stamp" is deemed to be invalid. Copying or excerpting portion of, or altering the content of the report is not permitted without the written authorization of AGC. The test results presented in the report apply only to the tested sample. Any objections to report issued by AGC should be submitted to AGC within 15 days after the issuance of the test report. Further enquiry of validity or verification of the test report should be addressed to AGC by agc@agc-cert.com.



Test Laboratory: AGC Lab
System Check Head 835 MHz
DUT: Dipole 835 MHz Type: SID 835

Date: Jan. 20, 2022

Communication System CW; Communication System Band: D835 (835.0 MHz); Duty Cycle: 1:1; Conv.F=5.21
Frequency: 835 MHz; Medium parameters used: $f = 835$ MHz; $\sigma=0.90$ mho/m; $\epsilon_r=41.72$; $\rho= 1000$ kg/m³ ;
Phantom section: Flat Section; Input Power=18dBm
Ambient temperature (°C):20.8, Liquid temperature (°C): 20.6

SATIMO Configuration:

- Probe: SSE5; Calibrated: Aug. 17, 2021; Serial No.: SN 24/20 EP336
- Sensor-Surface: 4mm (Mechanical Surface Detection)
- Phantom: ELLI39 Phantom
- Measurement SW: OpenSAR V4_02_35

Configuration/System Check 835MHz Head/Area Scan: Measurement grid: dx=8mm, dy=8mm

Configuration/System Check 835MHz Head/Zoom Scan: Measurement grid: dx=8mm,dy=8mm, dz=5mm

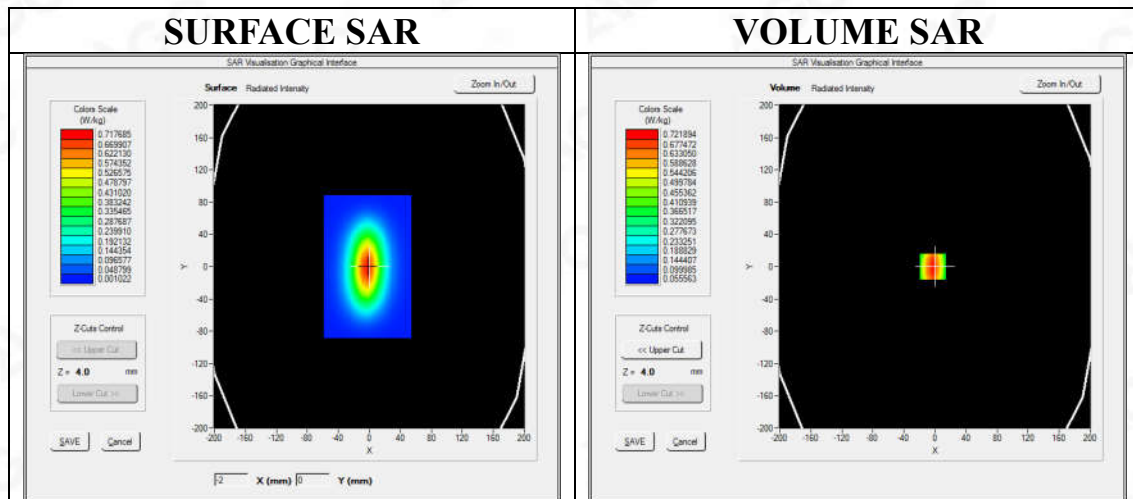

Maximum location: X=-3.00, Y=0.00
SAR Peak: 1.01 W/kg

SAR 10g (W/Kg)	0.423441
SAR 1g (W/Kg)	0.659215

Any report having not been signed by authorized approver, or having been altered without authorization, or having not been stamped by the "Dedicated Testing/Inspection Stamp" is deemed to be invalid. Copying or excerpting portion of, or altering the content of the report is not permitted without the written authorization of AGC. The test results presented in the report apply only to the tested sample. Any objections to report issued by AGC should be submitted to AGC within 15days after the issuance of the test report. Further enquiry of validity or verification of the test report should be addressed to AGC by agc@agc-cert.com.



Z (mm)	0.00	4.00	9.00	14.00	19.00	24.00	29.00
SAR (W/Kg)	1.0122	0.7217	0.4745	0.3216	0.2225	0.1536	0.1054

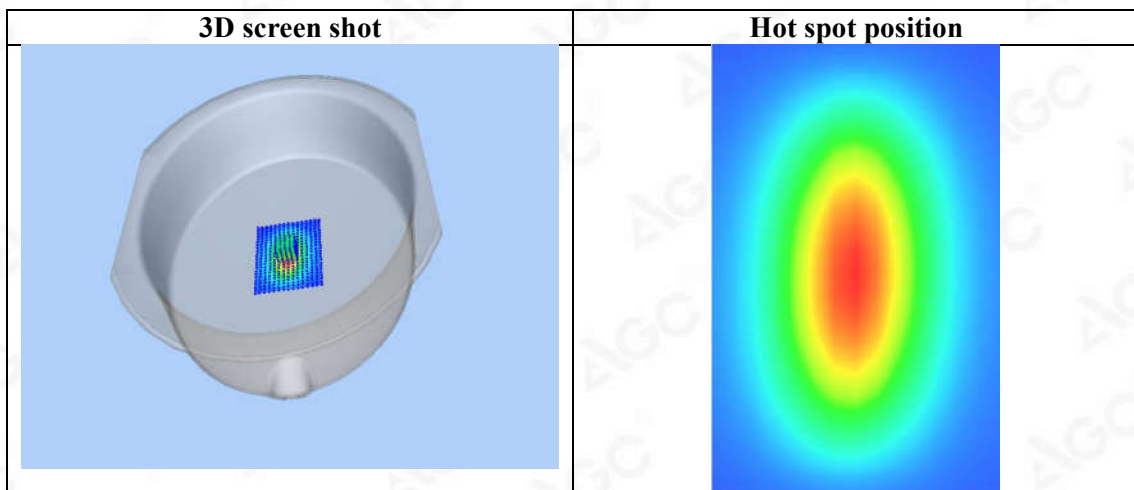
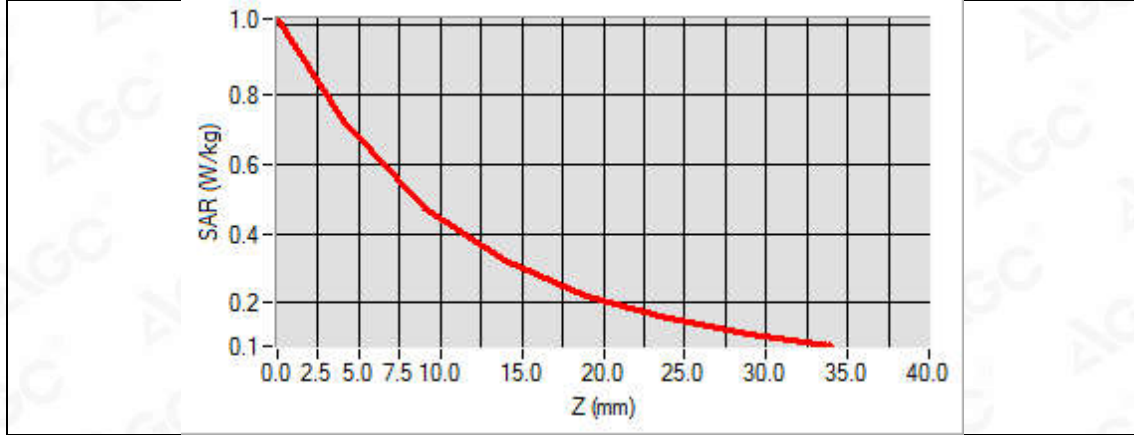

Any report having not been signed by authorized approver, or having been altered without authorization, or having not been stamped by the "Dedicated Testing/Inspection Stamp" is deemed to be invalid. Copying or excerpting portion of, or altering the content of the report is not permitted without the written authorization of AGC. The test results presented in the report apply only to the tested sample. Any objections to report issued by AGC should be submitted to AGC within 15days after the issuance of the test report. Further enquiry of validity or verification of the test report should be addressed to AGC by agc@agc-cert.com.



Test Laboratory: AGC Lab
System Check Head 835 MHz
DUT: Dipole 835 MHz Type: SID 835

Date: Jan. 24, 2022

Communication System CW; Communication System Band: D835 (835.0 MHz); Duty Cycle: 1:1; Conv.F=5.21
Frequency: 835 MHz; Medium parameters used: $f = 835$ MHz; $\sigma=0.89$ mho/m; $\epsilon_r=41.46$; $\rho= 1000$ kg/m³ ;
Phantom section: Flat Section; Input Power=18dBm
Ambient temperature (°C):22.0, Liquid temperature (°C): 21.8

SATIMO Configuration:

- Probe: SSE5; Calibrated: Aug. 17, 2021; Serial No.: SN 24/20 EP336
- Sensor-Surface: 4mm (Mechanical Surface Detection)
- Phantom: ELLI39 Phantom
- Measurement SW: OpenSAR V4_02_35

Configuration/System Check 835MHz Head/Area Scan: Measurement grid: dx=8mm, dy=8mm

Configuration/System Check 835MHz Head/Zoom Scan: Measurement grid: dx=8mm,dy=8mm, dz=5mm

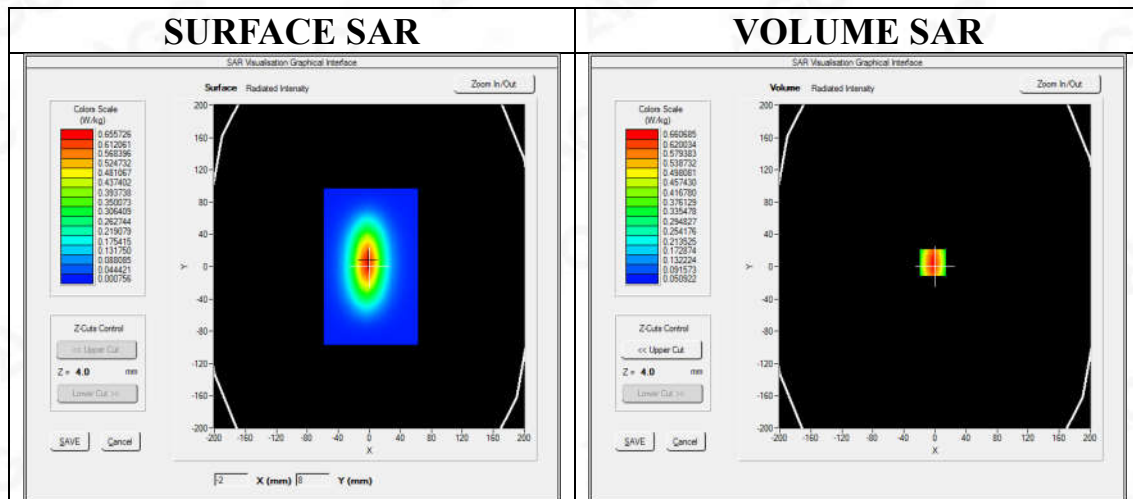

Maximum location: X=-3.00, Y=5.00
SAR Peak: 0.93 W/kg

SAR 10g (W/Kg)	0.396752
SAR 1g (W/Kg)	0.630463

Any report having not been signed by authorized approver, or having been altered without authorization, or having not been stamped by the "Dedicated Testing/Inspection Stamp" is deemed to be invalid. Copying or excerpting portion of, or altering the content of the report is not permitted without the written authorization of AGC. The test results presented in the report apply only to the tested sample. Any objections to report issued by AGC should be submitted to AGC within 15days after the issuance of the test report. Further enquiry of validity or verification of the test report should be addressed to AGC by agc@agc-cert.com.



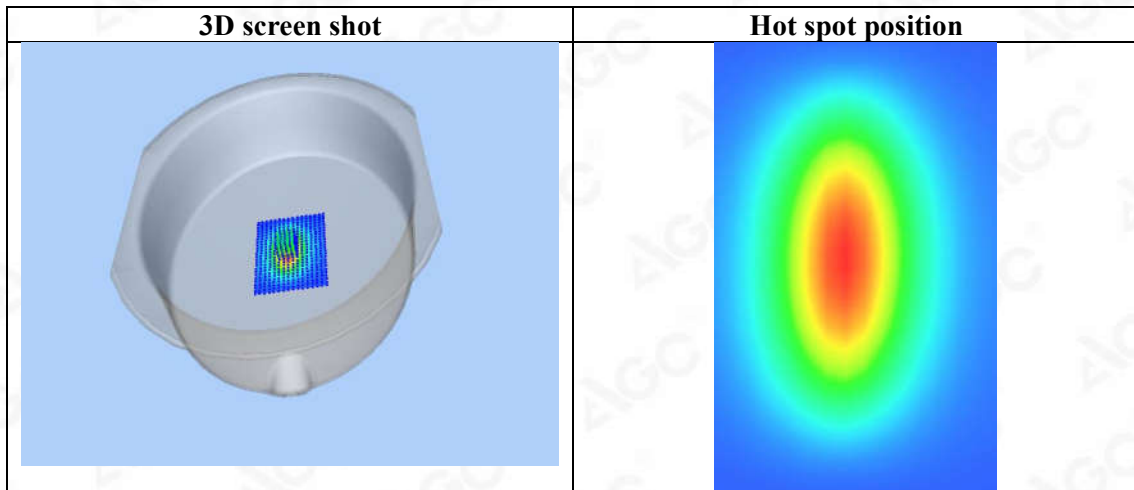
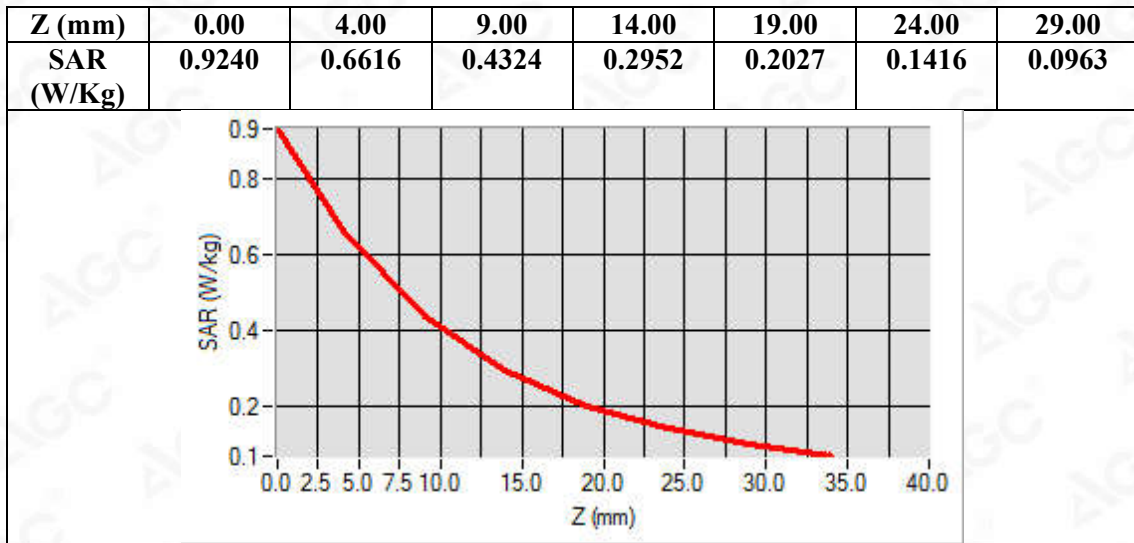

Any report having not been signed by authorized approver, or having been altered without authorization, or having not been stamped by the "Dedicated Testing/Inspection Stamp" is deemed to be invalid. Copying or excerpting portion of, or altering the content of the report is not permitted without the written authorization of AGC. The test results presented in the report apply only to the tested sample. Any objections to report issued by AGC should be submitted to AGC within 15 days after the issuance of the test report. Further enquiry of validity or verification of the test report should be addressed to AGC by agc@agc-cert.com.



Test Laboratory: AGC Lab
System Check Head 1750MHz
DUT: Dipole 1800 MHz; Type: SID 1800

Date: Jan. 21, 2022

Communication System: CW; Communication System Band: D1700 (1750.0 MHz); Duty Cycle:1:1; Conv.F=4.94
Frequency: 1750 MHz; Medium parameters used: $f = 1750\text{MHz}$; $\sigma = 1.38 \text{ mho/m}$; $\epsilon_r = 39.94$; $\rho = 1000 \text{ kg/m}^3$;
Phantom section: Flat Section; Input Power=18dBm
Ambient temperature ($^{\circ}\text{C}$): 21.0, Liquid temperature ($^{\circ}\text{C}$): 20.8

SATIMO Configuration:

Probe: SSE5; Calibrated: Aug. 17, 2021; Serial No.: SN 24/20 EP336

- Sensor-Surface: 4mm (Mechanical Surface Detection)
- Phantom: ELLI39 Phantom
- Measurement SW: OpenSAR V4_02_35

Configuration/System Check 1750MHz Head/Area Scan: Measurement grid: dx=8mm,dy=8mm

Configuration/System Check 1750MHz Head/Zoom Scan: Measurement grid: dx=8mm,dy=8mm, dz=5mm

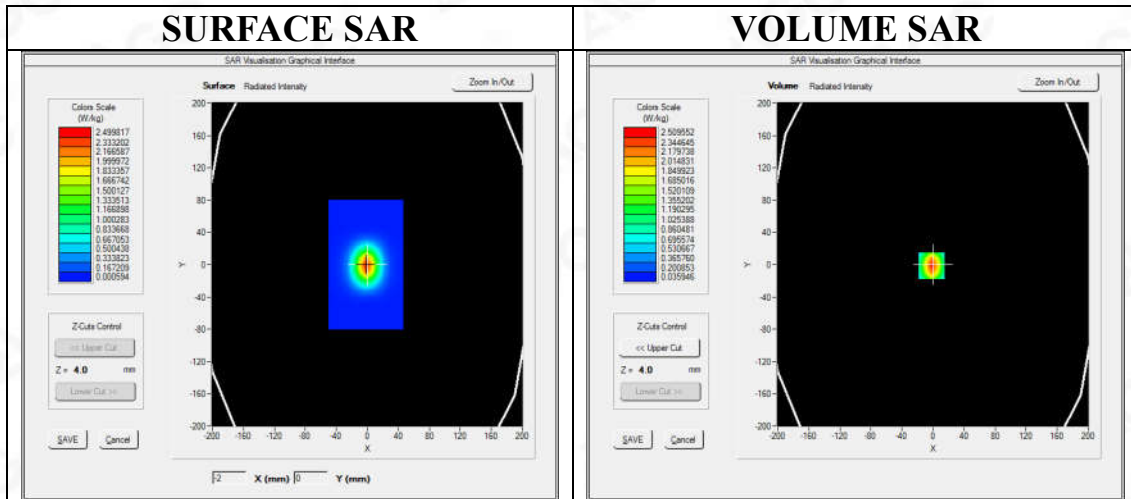

Maximum location: X=-2.00, Y=-1.00
SAR Peak: 4.01 W/kg

SAR 10g (W/Kg)	1.194174
SAR 1g (W/Kg)	2.350810

Any report having not been signed by authorized approver, or having been altered without authorization, or having not been stamped by the "Dedicated Testing/Inspection Stamp" is deemed to be invalid. Copying or excerpting portion of, or altering the content of the report is not permitted without the written authorization of AGC. The test results presented in the report apply only to the tested sample. Any objections to report issued by AGC should be submitted to AGC within 15days after the issuance of the test report. Further enquiry of validity or verification of the test report should be addressed to AGC by agc@agc-cert.com.



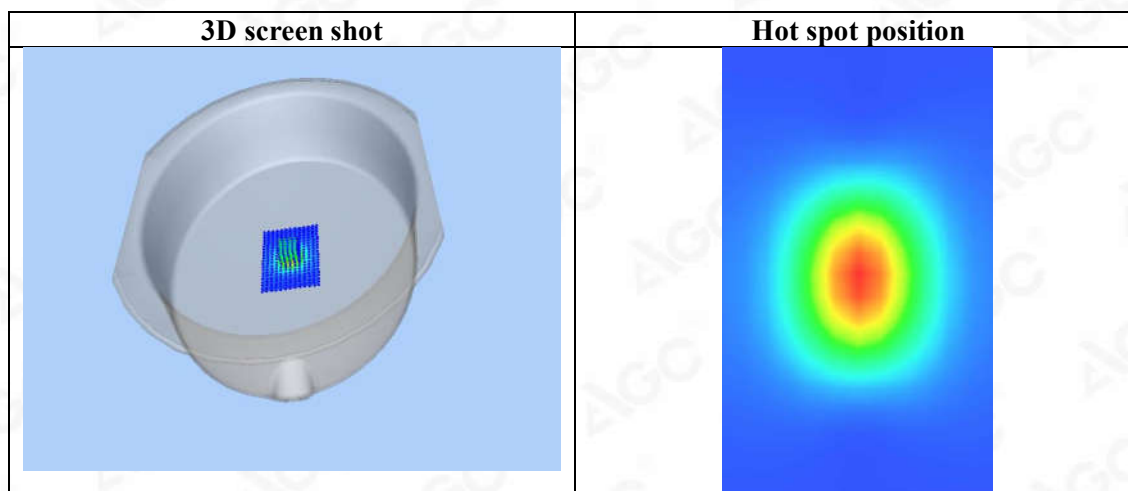
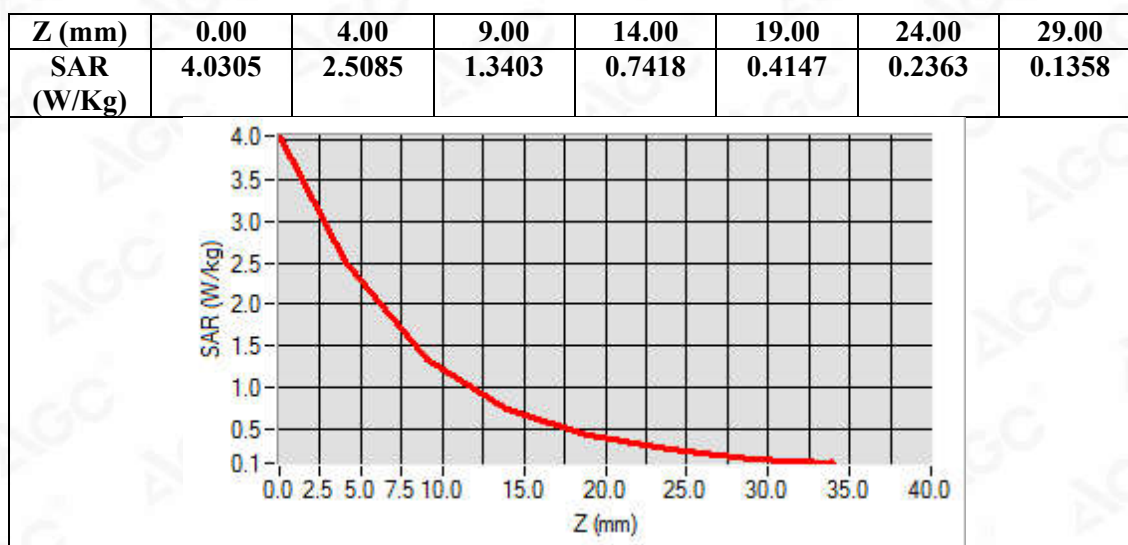

Any report having not been signed by authorized approver, or having been altered without authorization, or having not been stamped by the "Dedicated Testing/Inspection Stamp" is deemed to be invalid. Copying or excerpting portion of, or altering the content of the report is not permitted without the written authorization of AGC. The test results presented in the report apply only to the tested sample. Any objections to report issued by AGC should be submitted to AGC within 15 days after the issuance of the test report. Further enquiry of validity or verification of the test report should be addressed to AGC by agc@agc-cert.com.



Test Laboratory: AGC Lab
System Check Head 1900MHz
DUT: Dipole 1900 MHz; Type: SID 1900

Date: Jan. 21, 2022

Communication System: CW; Communication System Band: D1900 (1900.0 MHz); Duty Cycle:1:1; Conv.F=4.57
Frequency: 1900 MHz; Medium parameters used: $f = 1800$ MHz; $\sigma = 1.38$ mho/m; $\epsilon_r = 38.45$; $\rho = 1000$ kg/m³ ;
Phantom section: Flat Section; Input Power=18dBm
Ambient temperature (°C):21.0, Liquid temperature (°C): 20.7

SATIMO Configuration:

Probe: SSE5; Calibrated: Aug. 17, 2021; Serial No.: SN 24/20 EP336

- Sensor-Surface: 4mm (Mechanical Surface Detection)
- Phantom: ELLI39 Phantom
- Measurement SW: OpenSAR V4_02_35

Configuration/System Check 1900MHz Head/Area Scan: Measurement grid: dx=8mm, dy=8mm

Configuration/System Check 1900MHz Head/Zoom Scan: Measurement grid: dx=8mm,dy=8mm, dz=5mm

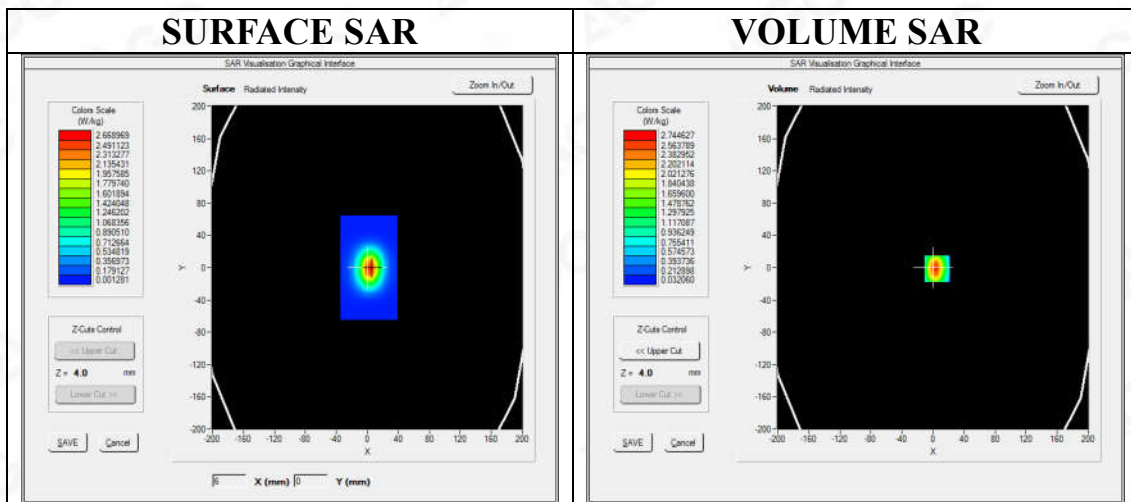

Maximum location: X=5.00, Y=-1.00

SAR Peak: 4.48 W/kg

SAR 10g (W/Kg)	1.295557
SAR 1g (W/Kg)	2.610458

Any report having not been signed by authorized approver, or having been altered without authorization, or having not been stamped by the "Dedicated Testing/Inspection Stamp" is deemed to be invalid. Copying or excerpting portion of, or altering the content of the report is not permitted without the written authorization of AGC. The test results presented in the report apply only to the tested sample. Any objections to report issued by AGC should be submitted to AGC within 15days after the issuance of the test report. Further enquiry of validity or verification of the test report should be addressed to AGC by agc@agc-cert.com.



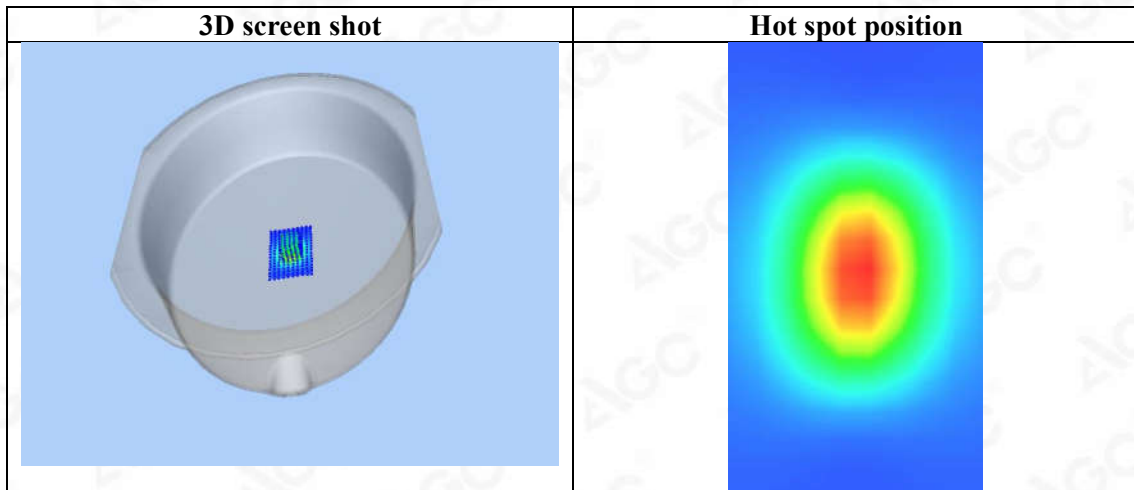
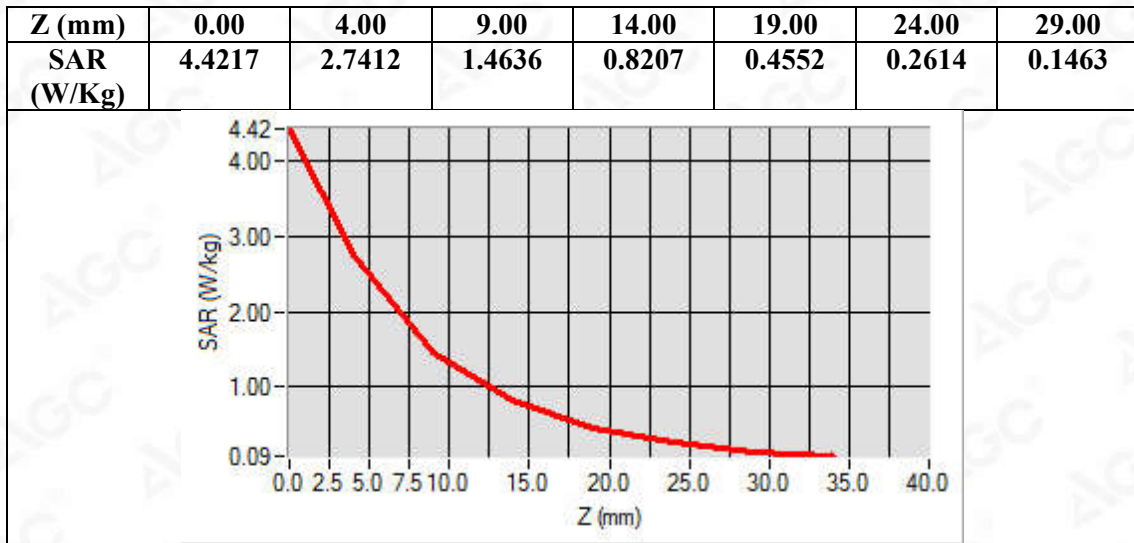

Any report having not been signed by authorized approver, or having been altered without authorization, or having not been stamped by the "Dedicated Testing/Inspection Stamp" is deemed to be invalid. Copying or excerpting portion of, or altering the content of the report is not permitted without the written authorization of AGC. The test results presented in the report apply only to the tested sample. Any objections to report issued by AGC should be submitted to AGC within 15 days after the issuance of the test report. Further enquiry of validity or verification of the test report should be addressed to AGC by agc@agc-cert.com.



Test Laboratory: AGC Lab
System Check Head 1900MHz
DUT: Dipole 1900 MHz; Type: SID 1900

Date: Jan. 25, 2022

Communication System: CW; Communication System Band: D1900 (1900.0 MHz); Duty Cycle:1:1; Conv.F=4.57
Frequency: 1900 MHz; Medium parameters used: $f = 1800$ MHz; $\sigma = 1.41$ mho/m; $\epsilon_r = 39.75$; $\rho = 1000$ kg/m³ ;
Phantom section: Flat Section; Input Power=18dBm
Ambient temperature (°C):21.3, Liquid temperature (°C): 21.1

SATIMO Configuration:

- Probe: SSE5; Calibrated: Aug. 17, 2021; Serial No.: SN 24/20 EP336
- Sensor-Surface: 4mm (Mechanical Surface Detection)
- Phantom: ELLI39 Phantom
- Measurement SW: OpenSAR V4_02_35

Configuration/System Check 1900MHz Head/Area Scan: Measurement grid: dx=8mm, dy=8mm

Configuration/System Check 1900MHz Head/Zoom Scan: Measurement grid: dx=8mm,dy=8mm, dz=5mm

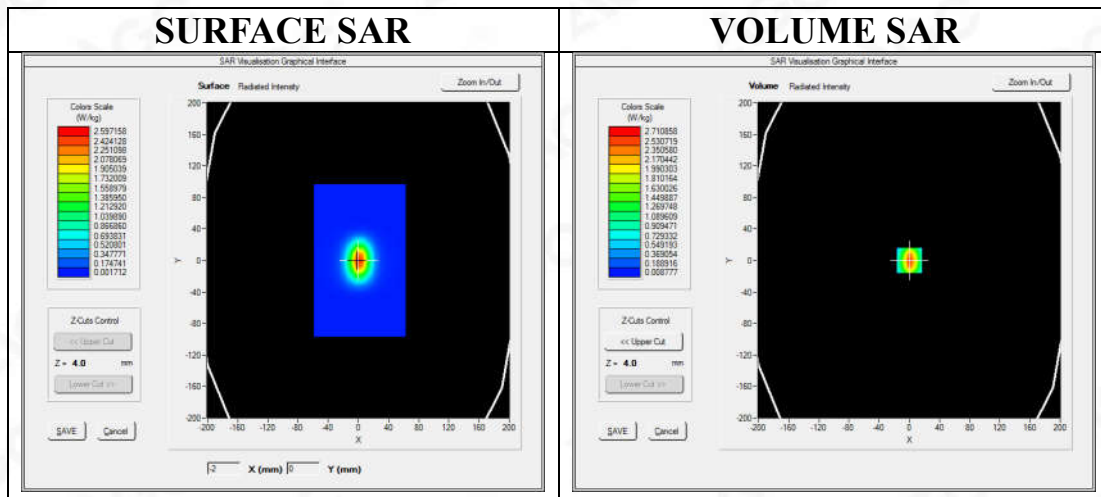

Maximum location: X=0.00, Y=0.00
SAR Peak: 5.01 W/kg

SAR 10g (W/Kg)	1.310220
SAR 1g (W/Kg)	2.578474

Any report having not been signed by authorized approver, or having been altered without authorization, or having not been stamped by the "Dedicated Testing/Inspection Stamp" is deemed to be invalid. Copying or excerpting portion of, or altering the content of the report is not permitted without the written authorization of AGC. The test results presented in the report apply only to the tested sample. Any objections to report issued by AGC should be submitted to AGC within 15days after the issuance of the test report. Further enquiry of validity or verification of the test report should be addressed to AGC by agc@agc-cert.com.



Z (mm)	0.00	4.00	9.00	14.00	19.00	24.00	29.00
SAR (W/Kg)	5.0706	2.7114	1.1032	0.4715	0.2004	0.0930	0.0400

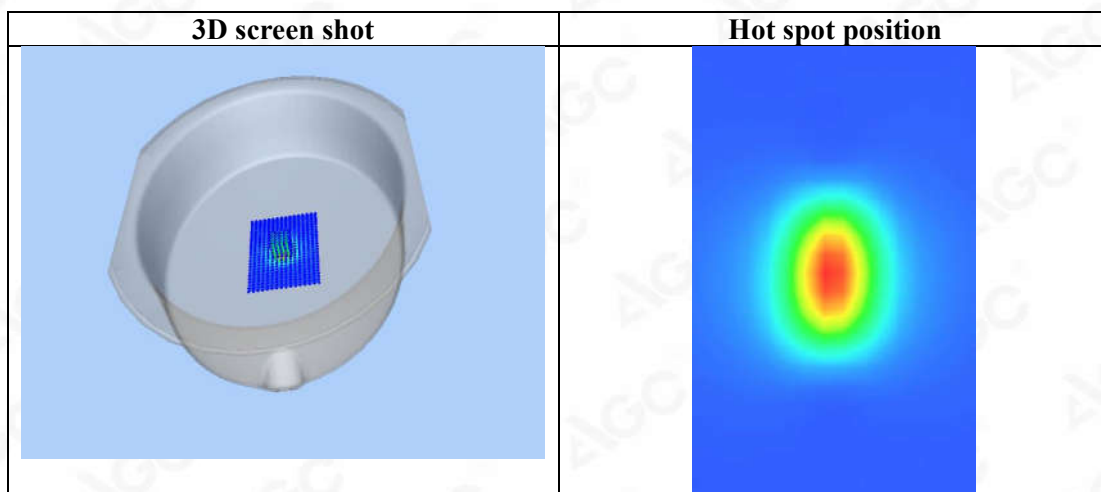
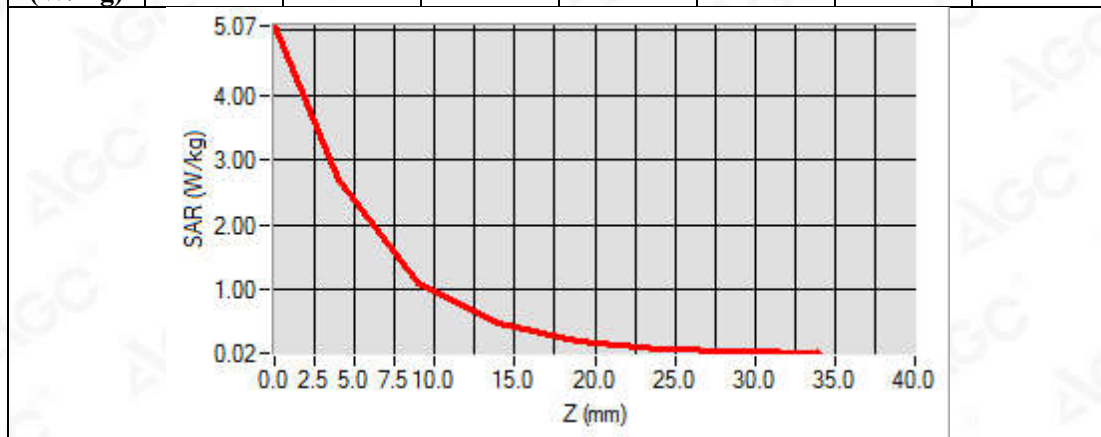

Any report having not been signed by authorized approver, or having been altered without authorization, or having not been stamped by the "Dedicated Testing/Inspection Stamp" is deemed to be invalid. Copying or excerpting portion of, or altering the content of the report is not permitted without the written authorization of AGC. The test results presented in the report apply only to the tested sample. Any objections to report issued by AGC should be submitted to AGC within 15 days after the issuance of the test report. Further enquiry of validity or verification of the test report should be addressed to AGC by agc@agc-cert.com.



Test Laboratory: AGC Lab
System Check Head 2450 MHz
DUT: Dipole 2450 MHz Type: SID 2450

Date: Jan. 22, 2022

Communication System CW; Communication System Band: D2450 (2450.0 MHz); Duty Cycle: 1:1; Conv.F=4.02
Frequency: 2450 MHz; Medium parameters used: $f = 2450$ MHz; $\sigma = 1.79$ mho/m; $\epsilon_r = 38.94$; $\rho = 1000$ kg/m³ ;
Phantom section: Flat Section; Input Power=18dBm
Ambient temperature (°C):21.3, Liquid temperature (°C): 21.2

SATIMO Configuration

- Probe: SSE5; Calibrated: Aug. 17, 2021; Serial No.: SN 24/20 EP336
- Sensor-Surface: 4mm (Mechanical Surface Detection)
- Phantom: ELLI39 Phantom
- Measurement SW: OpenSAR V4_02_35

Configuration/System Check 2450MHz Head/Area Scan: Measurement grid: dx=8mm, dy=8mm

Configuration/System Check 2450MHz Head/Zoom Scan: Measurement grid: dx=5mm,dy=5mm, dz=5mm

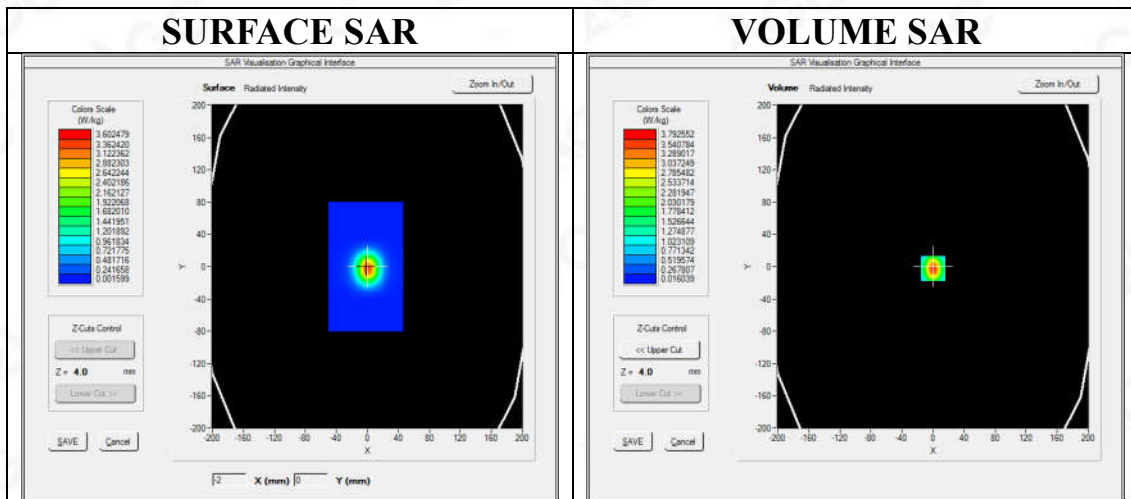

Maximum location: X=0.00, Y=-2.00
SAR Peak: 6.61 W/kg

SAR 10g (W/Kg)	1.561377
SAR 1g (W/Kg)	3.492563

Any report having not been signed by authorized approver, or having been altered without authorization, or having not been stamped by the "Dedicated Testing/Inspection Stamp" is deemed to be invalid. Copying or excerpting portion of, or altering the content of the report is not permitted without the written authorization of AGC. The test results presented in the report apply only to the tested sample. Any objections to report issued by AGC should be submitted to AGC within 15days after the issuance of the test report. Further enquiry of validity or verification of the test report should be addressed to AGC by agc@agc-cert.com.



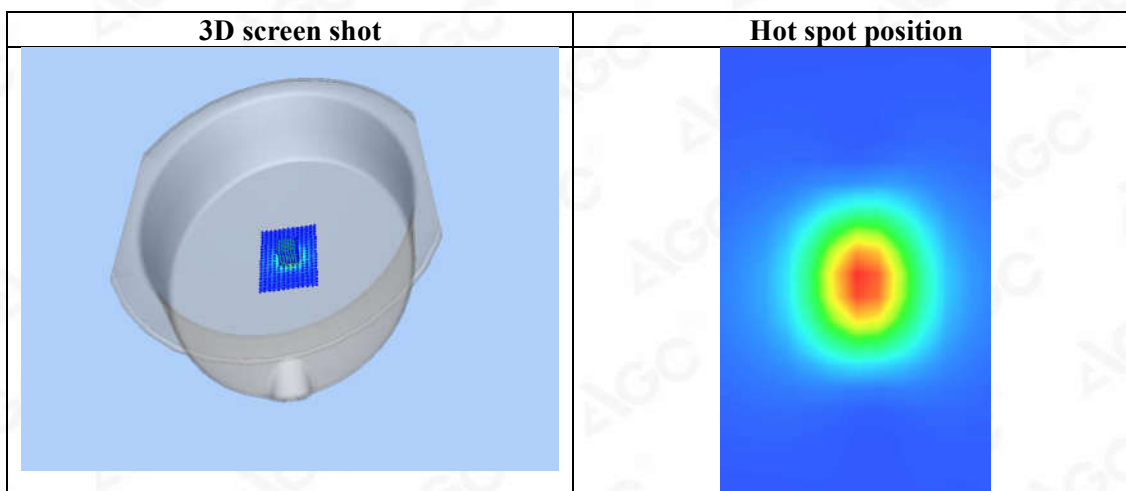
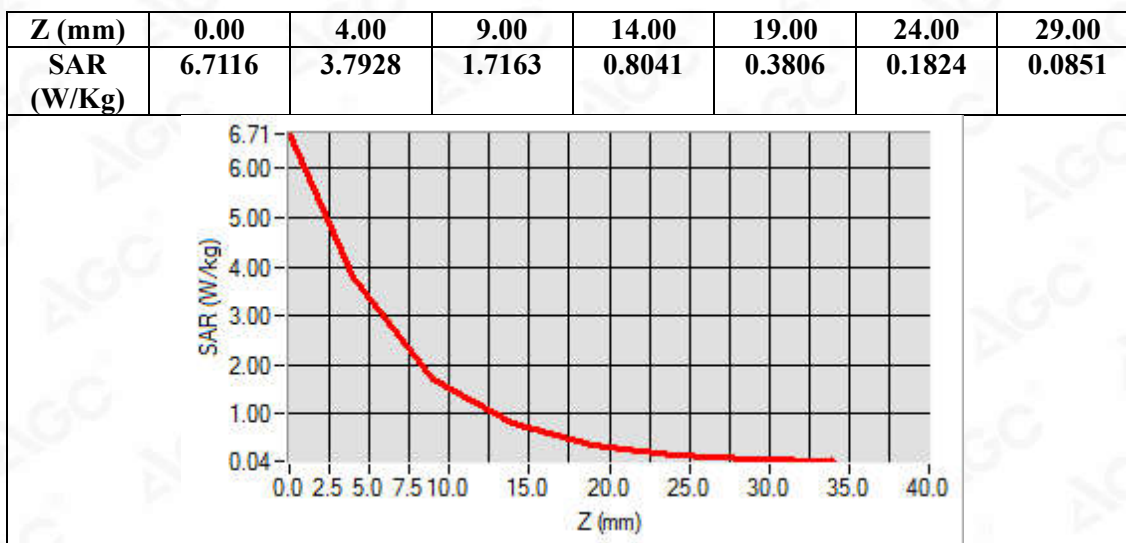

Any report having not been signed by authorized approver, or having been altered without authorization, or having not been stamped by the "Dedicated Testing/Inspection Stamp" is deemed to be invalid. Copying or excerpting portion of, or altering the content of the report is not permitted without the written authorization of AGC. The test results presented in the report apply only to the tested sample. Any objections to report issued by AGC should be submitted to AGC within 15 days after the issuance of the test report. Further enquiry of validity or verification of the test report should be addressed to AGC by agc@agc-cert.com.



Test Laboratory: AGC Lab
System Check Head 2600MHz
DUT: Dipole 2600 MHz; Type: SID 2600

Date: Jan. 22, 2022

Communication System: CW; Communication System Band: D2600 (2600.0 MHz); Duty Cycle: 1:1; Conv.F=3.89
Frequency:2600 MHz; Medium parameters used: $f = 2600$ MHz; $\sigma = 1.95$ mho/m; $\epsilon_r = 38.56$; $\rho = 1000$ kg/m³ ;
Phantom section: Flat Section; Input Power=18dBm
Ambient temperature (°C): 21.3, Liquid temperature (°C): 21.2

SATIMO Configuration:

- Probe: SSE5; Calibrated: Aug. 17, 2021; Serial No.: SN 24/20 EP336
- Sensor-Surface: 4mm (Mechanical Surface Detection)
- Phantom: ELLI39 Phantom
- Measurement SW: OpenSAR V4_02_35

Configuration/System Check 2600 Head/Area Scan: Measurement grid: dx=8mm,dy=8mm

Configuration/System Check 2600 Head/Zoom Scan: Measurement grid: dx=5mm,dy=5mm, dz=5mm

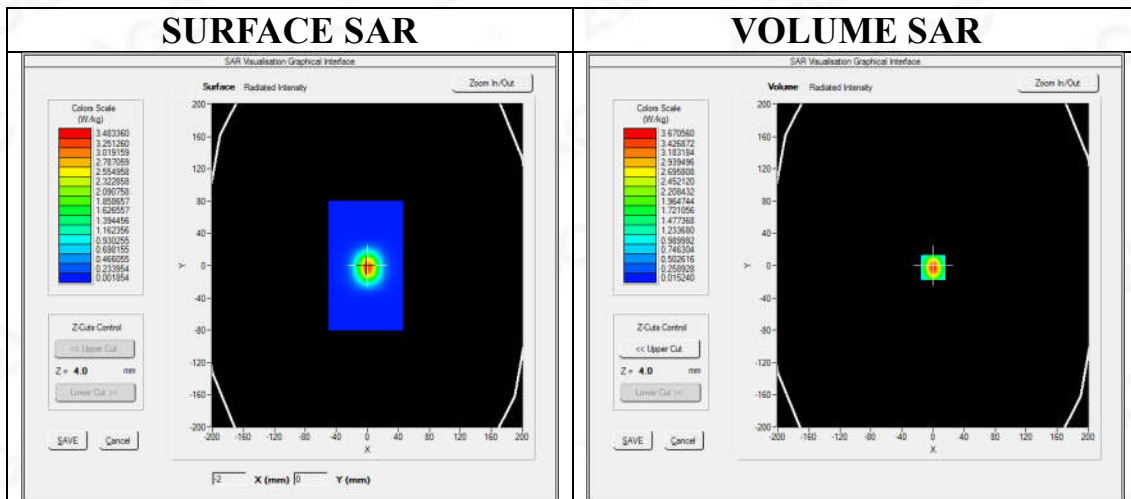

Maximum location: X=0.00, Y=-2.00
SAR Peak: 6.40 W/kg

SAR 10g (W/Kg)	1.511762
SAR 1g (W/Kg)	3.372873

Any report having not been signed by authorized approver, or having been altered without authorization, or having not been stamped by the "Dedicated Testing/Inspection Stamp" is deemed to be invalid. Copying or excerpting portion of, or altering the content of the report is not permitted without the written authorization of AGC. The test results presented in the report apply only to the tested sample. Any objections to report issued by AGC should be submitted to AGC within 15days after the issuance of the test report. Further enquiry of validity or verification of the test report should be addressed to AGC by agc@agc-cert.com.



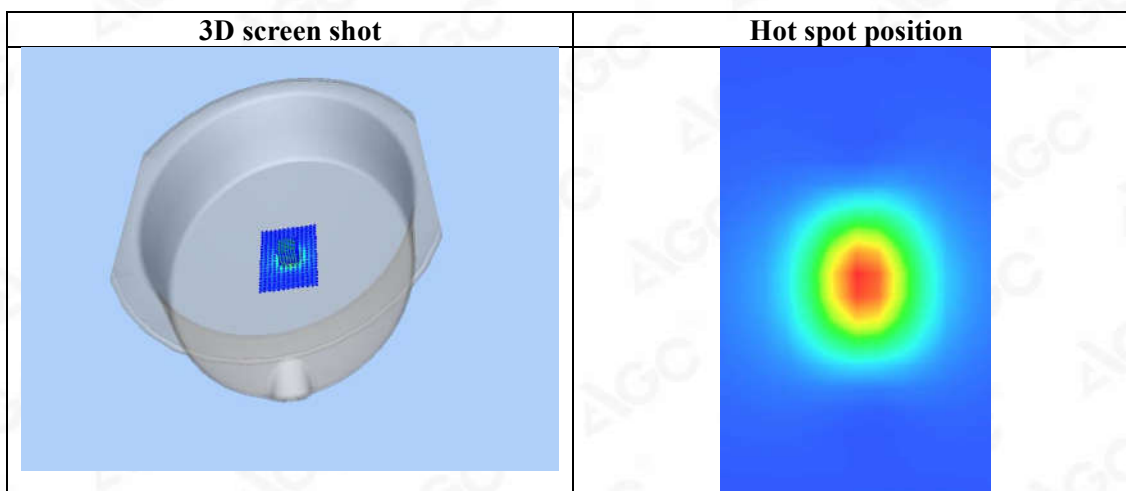
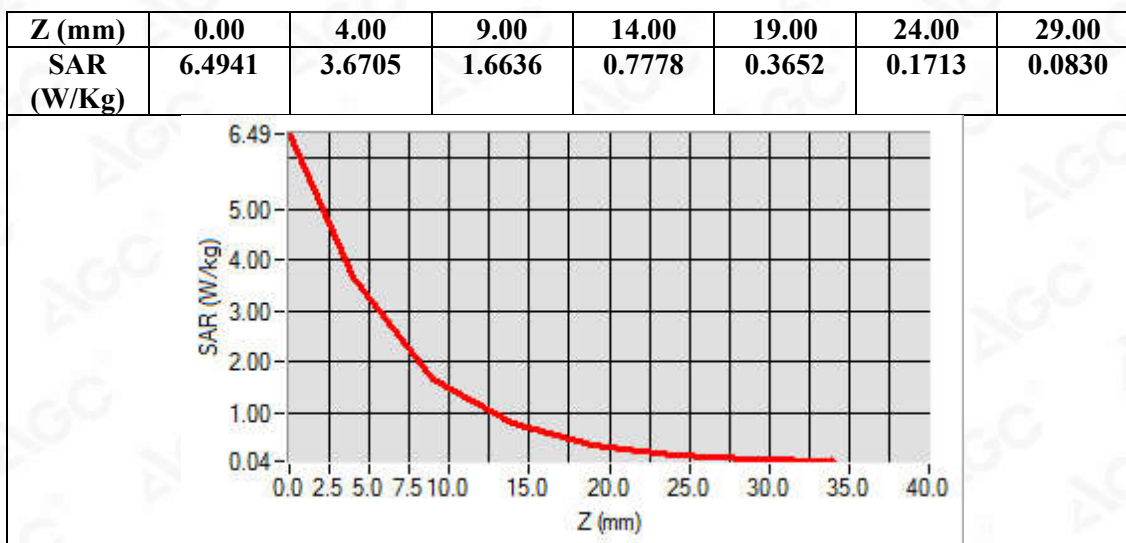

Any report having not been signed by authorized approver, or having been altered without authorization, or having not been stamped by the "Dedicated Testing/Inspection Stamp" is deemed to be invalid. Copying or excerpting portion of, or altering the content of the report is not permitted without the written authorization of AGC. The test results presented in the report apply only to the tested sample. Any objections to report issued by AGC should be submitted to AGC within 15 days after the issuance of the test report. Further enquiry of validity or verification of the test report should be addressed to AGC by agc@agc-cert.com.



APPENDIX B. SAR MEASUREMENT DATA

Test Laboratory: AGC Lab
GSM 850 Mid- Touch-Right <SIM 1>
DUT: Smart phone; Type: K58

Date: Jan. 20, 2022

Communication System: Generic GSM; Communication System Band: GSM 850; Duty Cycle: 1:8.3; Conv.F=5.21;
Frequency: 836.6 MHz; Medium parameters used: $f = 835$ MHz; $\sigma = 0.91$ mho/m; $\epsilon_r = 41.53$; $\rho = 1000$ kg/m³ ;
Phantom section: Right Section
Ambient temperature (°C): 20.8, Liquid temperature (°C): 20.6

SATIMO Configuration:

- Probe: SSE5; Calibrated: Aug. 17, 2021; Serial No.: SN 24/20 EP336
- Sensor-Surface: 4mm (Mechanical Surface Detection)
- Phantom: SAM twin phantom
- Measurement SW: OpenSAR V4_02_35

Configuration/GSM 850 Mid-Touch-Right/Area Scan: Measurement grid: dx=8mm, dy=8mm
Configuration/GSM 850 Mid-Touch-Right/Zoom Scan: Measurement grid: dx=8mm,dy=8mm, dz=5mm;

Area Scan	dx=8mm dy=8mm, h= 5.00 mm
ZoomScan	5x5x7,dx=8mm dy=8mm dz=5mm,Complete
Phantom	Right head
Device Position	Cheek
Band	GSM 850
Channels	Middle
Signal	TDMA (Crest factor: 8.0)

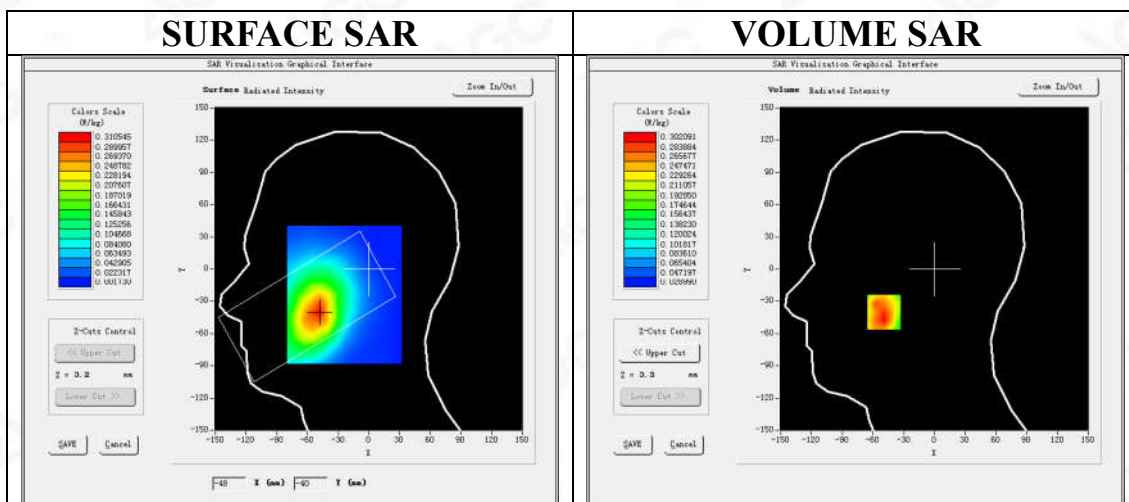

Maximum location: X=-49.00, Y=-40.00

SAR Peak: 0.40 W/kg

SAR 10g (W/Kg)	0.201148
SAR 1g (W/Kg)	0.288697

Any report having not been signed by authorized approver, or having been altered without authorization, or having not been stamped by the "Dedicated Testing/Inspection Stamp" is deemed to be invalid. Copying or excerpting portion of, or altering the content of the report is not permitted without the written authorization of AGC. The test results presented in the report apply only to the tested sample. Any objections to report issued by AGC should be submitted to AGC within 15days after the issuance of the test report. Further enquiry of validity or verification of the test report should be addressed to AGC by agc@agc-cert.com.



Z (mm)	0.00	4.00	9.00	14.00	19.00	24.00	29.00
SAR (W/Kg)	0.4124	0.3021	0.2114	0.1663	0.1250	0.0914	0.0727

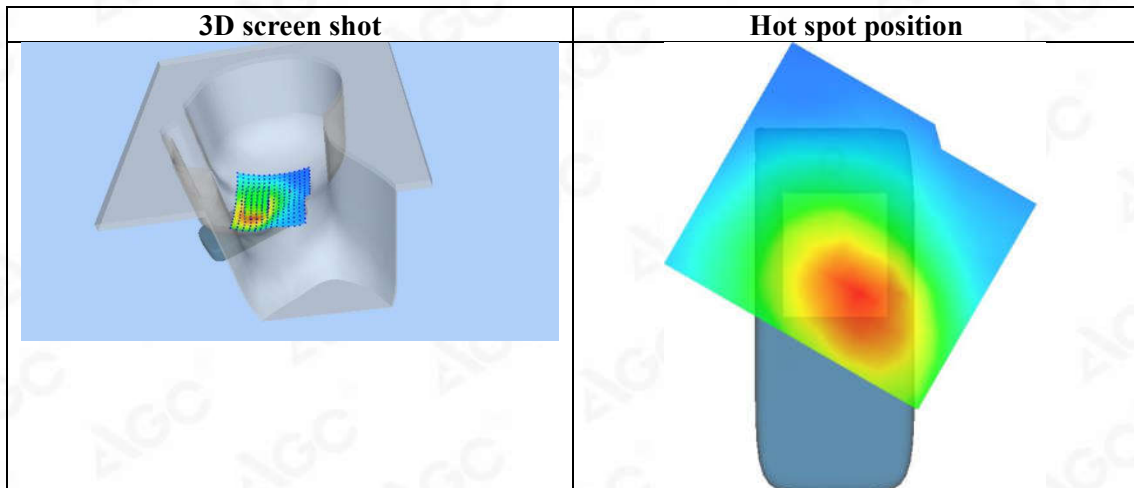
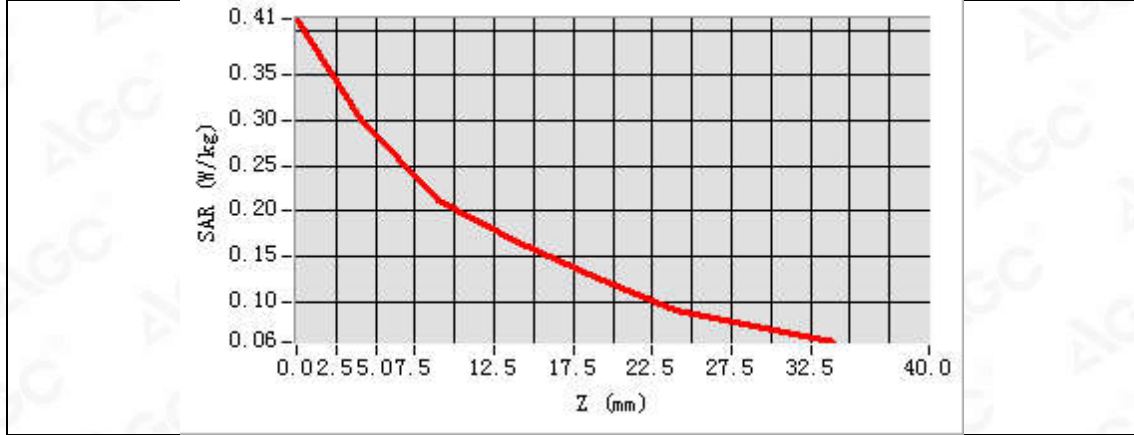

Any report having not been signed by authorized approver, or having been altered without authorization, or having not been stamped by the "Dedicated Testing/Inspection Stamp" is deemed to be invalid. Copying or excerpting portion of, or altering the content of the report is not permitted without the written authorization of AGC. The test results presented in the report apply only to the tested sample. Any objections to report issued by AGC should be submitted to AGC within 15 days after the issuance of the test report. Further enquiry of validity or verification of the test report should be addressed to AGC by agc@agc-cert.com.



Test Laboratory: AGC Lab
GSM 850 Mid- Body- Back (MS)<SIM 1>
DUT: Smart phone; Type: K58

Date: Jan. 20, 2022

Communication System: Generic GSM; Communication System Band: GSM 850; Duty Cycle: 1:8.3; Conv.F=5.21;
Frequency: 836.6 MHz; Medium parameters used: $f = 835$ MHz; $\sigma = 0.91$ mho/m; $\epsilon_r = 41.53$; $\rho = 1000$ kg/m³ ;
Phantom section: Flat Section
Ambient temperature (°C): 20.8, Liquid temperature (°C): 20.6

SATIMO Configuration:

- Probe: SSE5; Calibrated: Aug. 17, 2021; Serial No.: SN 24/20 EP336
- Sensor-Surface: 4mm (Mechanical Surface Detection)
- Phantom: ELLI39 Phantom
- Measurement SW: OpenSAR V4_02_35

Configuration/GSM 850 Mid-Body-Back/Area Scan: Measurement grid: dx=8mm, dy=8mm
Configuration/GSM 850 Mid-Body-Back/Zoom Scan: Measurement grid: dx=8mm,dy=8mm, dz=5mm;

Area Scan	dx=8mm dy=8mm, h= 5.00 mm
ZoomScan	5x5x7,dx=8mm dy=8mm dz=5mm,Complete
Phantom	ELLI
Device Position	Body Back
Band	GSM 850
Channels	Middle
Signal	TDMA (Crest factor: 8.0)

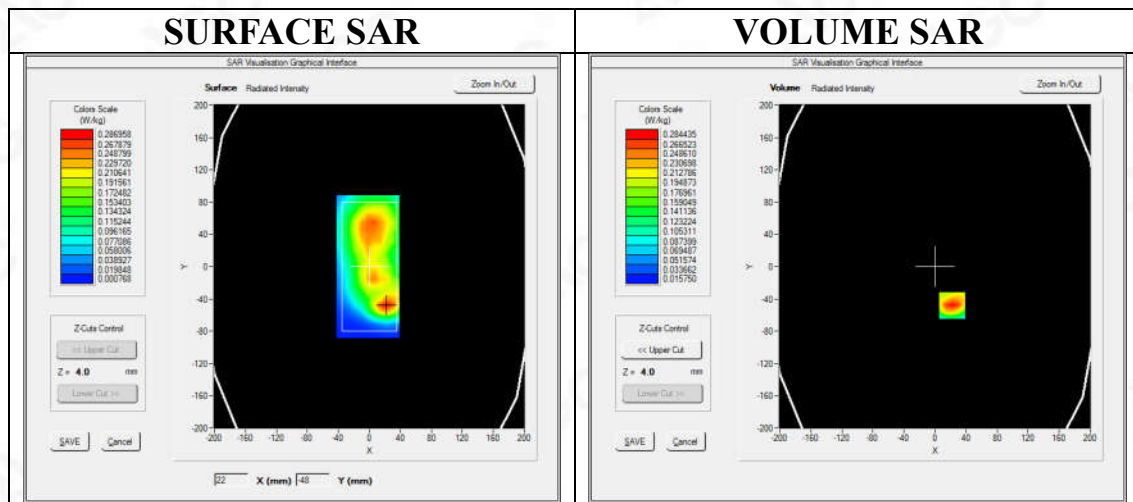

Maximum location: X=22.00, Y=-48.00

SAR Peak: 0.42 W/kg

SAR 10g (W/Kg)	0.161403
SAR 1g (W/Kg)	0.271241

Any report having not been signed by authorized approver, or having been altered without authorization, or having not been stamped by the "Dedicated Testing/Inspection Stamp" is deemed to be invalid. Copying or excerpting portion of, or altering the content of the report is not permitted without the written authorization of AGC. The test results presented in the report apply only to the tested sample. Any objections to report issued by AGC should be submitted to AGC within 15days after the issuance of the test report. Further enquiry of validity or verification of the test report should be addressed to AGC by agc@agc-cert.com.



Z (mm)	0.00	4.00	9.00	14.00	19.00	24.00	29.00
SAR (W/Kg)	0.4157	0.2844	0.1818	0.1167	0.0841	0.0579	0.0396

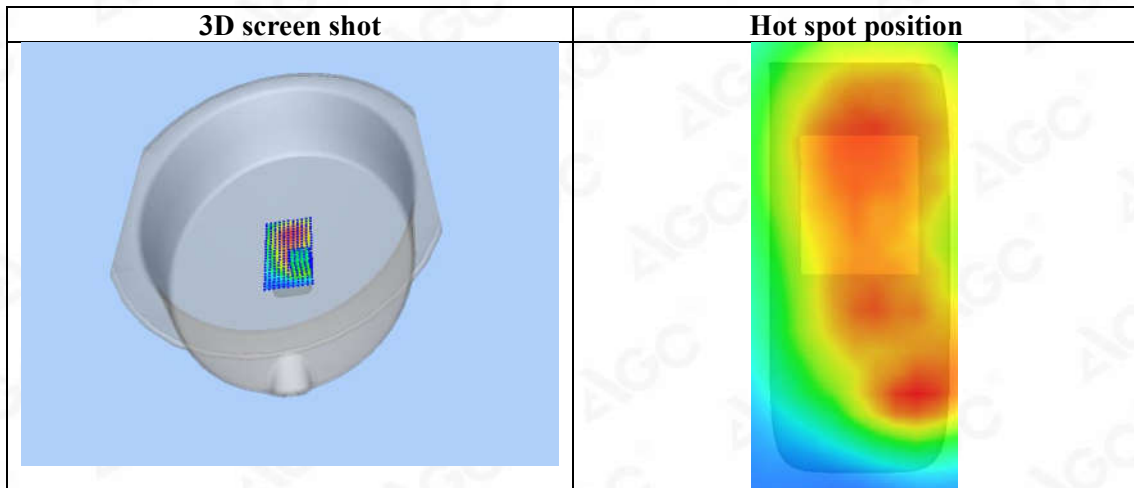
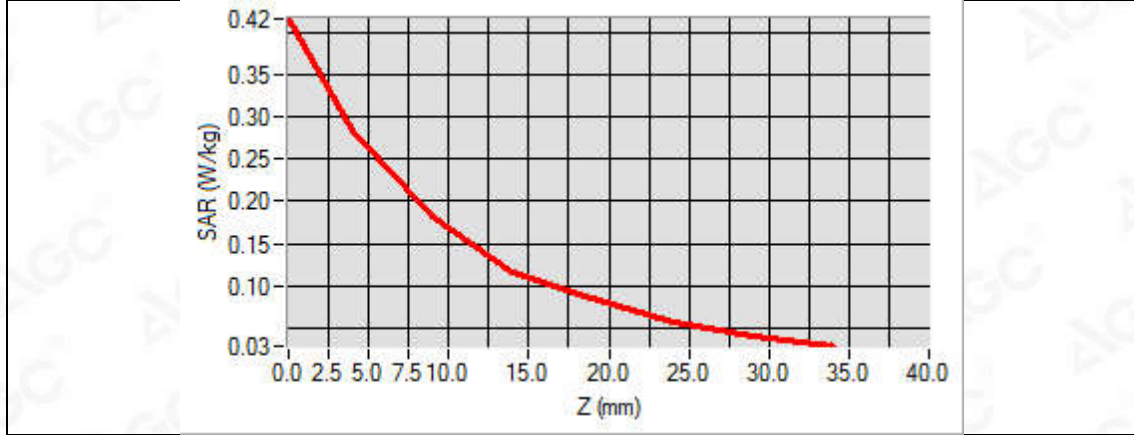

Any report having not been signed by authorized approver, or having been altered without authorization, or having not been stamped by the "Dedicated Testing/Inspection Stamp" is deemed to be invalid. Copying or excerpting portion of, or altering the content of the report is not permitted without the written authorization of AGC. The test results presented in the report apply only to the tested sample. Any objections to report issued by AGC should be submitted to AGC within 15days after the issuance of the test report. Further enquiry of validity or verification of the test report should be addressed to AGC by agc@agc-cert.com.



Test Laboratory: AGC Lab
PCS 1900 Mid-Touch- Left <SIM 1>
DUT: Smart phone; Type: K58

Date: Jan. 21, 2022

Communication System: Generic GSM; Communication System Band: PCS 1900; Duty Cycle: 1:8.3; Conv.F=4.57;
Frequency: 1880 MHz; Medium parameters used: $f = 1800$ MHz; $\sigma = 1.37$ mho/m; $\epsilon_r = 38.72$; $\rho = 1000$ kg/m³ ;
Phantom section: Left Section
Ambient temperature (°C): 21.0, Liquid temperature (°C): 20.7

SATIMO Configuration:

- Probe: SSE5; Calibrated: Aug. 17, 2021; Serial No.: SN 24/20 EP336
- Sensor-Surface: 4mm (Mechanical Surface Detection)
- Phantom: SAM twin phantom
- Measurement SW: OpenSAR V4_02_35

Configuration/PCS1900 Mid-Touch-Left/Area Scan: Measurement grid: dx=8mm, dy=8mm
Configuration/PCS1900 Mid-Touch-Left/Zoom Scan: Measurement grid: dx=8mm,dy=8mm, dz=5mm;

Area Scan	dx=8mm dy=8mm, h= 5.00 mm
ZoomScan	5x5x7,dx=8mm dy=8mm dz=5mm,Complete
Phantom	Left head
Device Position	Cheek
Band	PCS 1900
Channels	Middle
Signal	TDMA (Crest factor: 8.0)

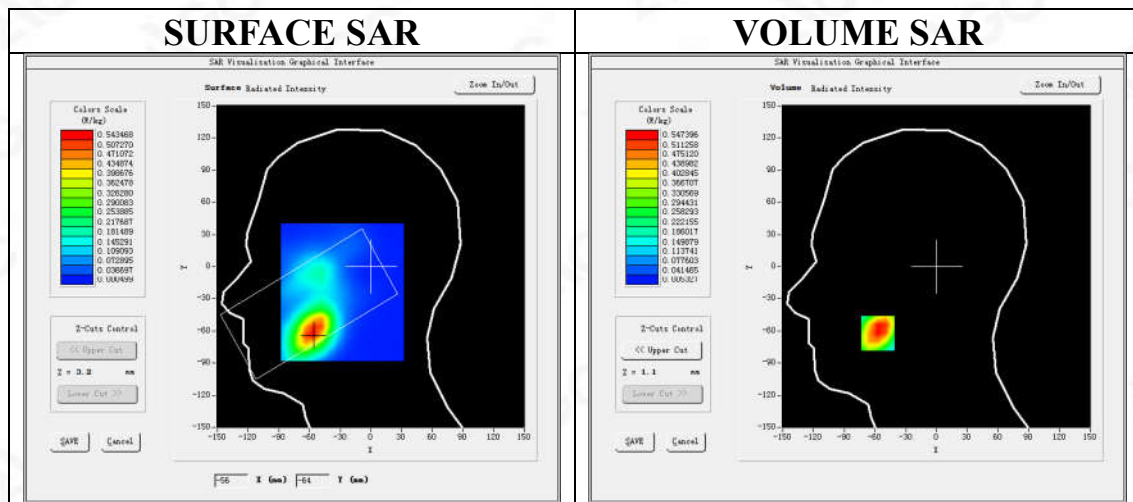

Maximum location: X=-57.00, Y=-62.00

SAR Peak: 0.89 W/kg

SAR 10g (W/Kg)	0.288312
SAR 1g (W/Kg)	0.537622

Any report having not been signed by authorized approver, or having been altered without authorization, or having not been stamped by the "Dedicated Testing/Inspection Stamp" is deemed to be invalid. Copying or excerpting portion of, or altering the content of the report is not permitted without the written authorization of AGC. The test results presented in the report apply only to the tested sample. Any objections to report issued by AGC should be submitted to AGC within 15days after the issuance of the test report. Further enquiry of validity or verification of the test report should be addressed to AGC by agc@agc-cert.com.



Z (mm)	0.00	4.00	9.00	14.00	19.00	24.00	29.00
SAR (W/Kg)	0.8055	0.5474	0.3316	0.1888	0.1170	0.0655	0.0398

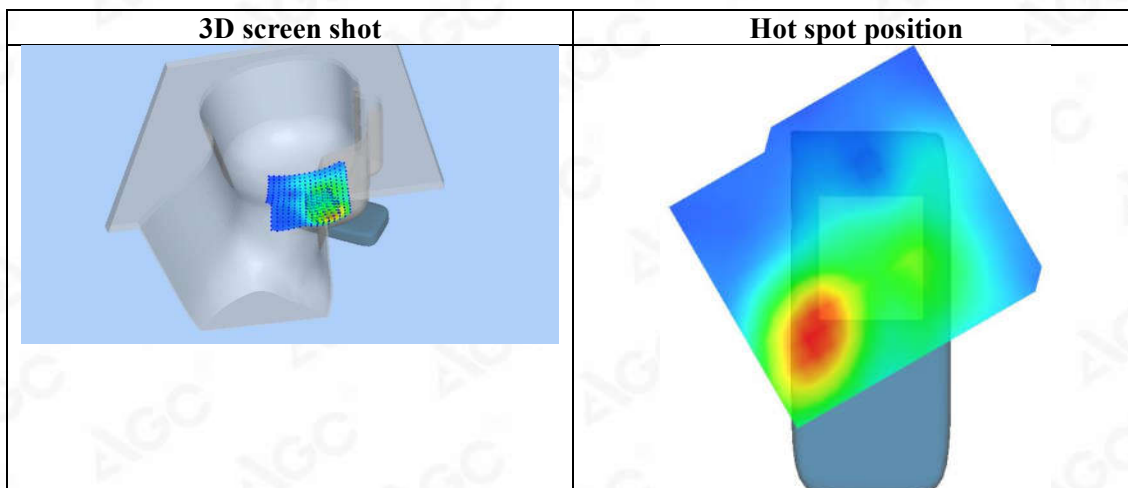
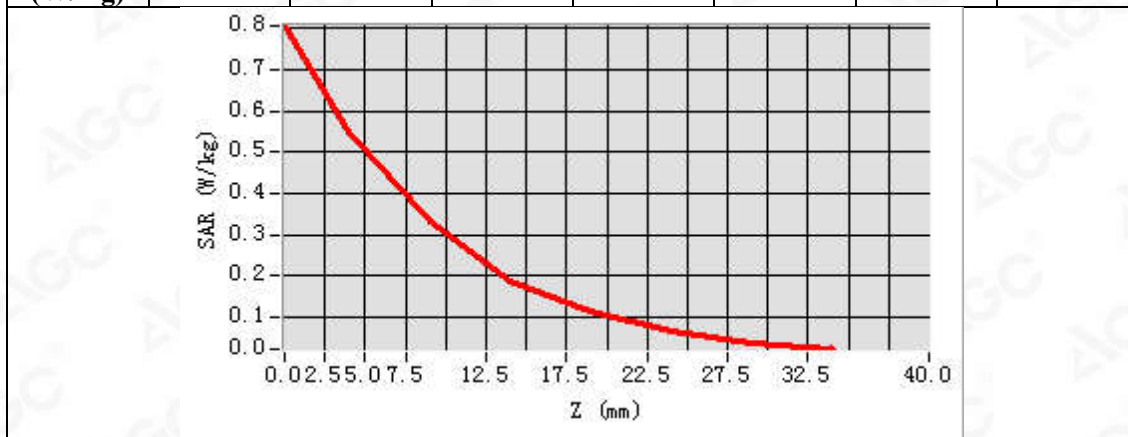

Any report having not been signed by authorized approver, or having been altered without authorization, or having not been stamped by the "Dedicated Testing/Inspection Stamp" is deemed to be invalid. Copying or excerpting portion of, or altering the content of the report is not permitted without the written authorization of AGC. The test results presented in the report apply only to the tested sample. Any objections to report issued by AGC should be submitted to AGC within 15days after the issuance of the test report. Further enquiry of validity or verification of the test report should be addressed to AGC by agc@agc-cert.com.



Test Laboratory: AGC Lab
PCS 1900 Mid-Body-Back (MS)<SIM 1>
DUT: Smart phone; Type: K58

Date: Jan. 21, 2022

Communication System: Generic GSM; Communication System Band: PCS 1900; Duty Cycle: 1:8.3; Conv.F=4.57;
Frequency: 1880 MHz; Medium parameters used: $f = 1800$ MHz; $\sigma = 1.37$ mho/m; $\epsilon_r = 38.72$; $\rho = 1000$ kg/m³ ;
Phantom section: Flat Section
Ambient temperature (°C): 21.0, Liquid temperature (°C): 20.7

SATIMO Configuration:

- Probe: SSE5; Calibrated: Aug. 17, 2021; Serial No.: SN 24/20 EP336
- Sensor-Surface: 4mm (Mechanical Surface Detection)
- Phantom: ELLI39 Phantom
- Measurement SW: OpenSAR V4_02_35

Configuration/PCS1900 Mid-Body-Back/Area Scan: Measurement grid: dx=8mm, dy=8mm
Configuration/PCS1900 Mid-Body-Back/Zoom Scan: Measurement grid: dx=8mm, dy=8mm, dz=5mm;

Area Scan	dx=8mm dy=8mm, h= 5.00 mm
ZoomScan	5x5x7,dx=8mm dy=8mm dz=5mm,Complete
Phantom	ELLI
Device Position	Body Back
Band	PCS 1900
Channels	Middle
Signal	TDMA (Crest factor: 8.0)

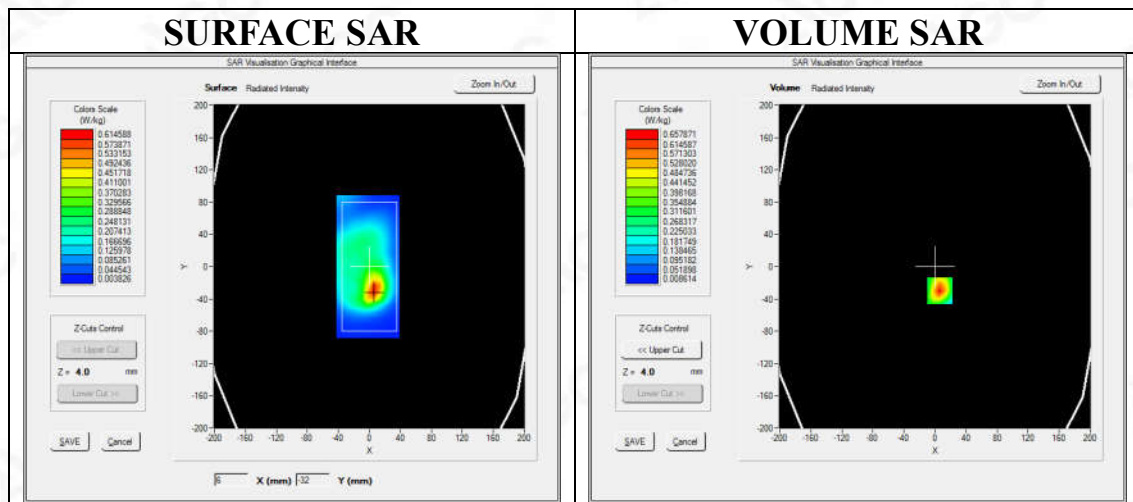

Maximum location: X=6.00, Y=-30.00
SAR Peak: 1.11 W/kg

SAR 10g (W/Kg)	0.311931
SAR 1g (W/Kg)	0.620997

Any report having not been signed by authorized approver, or having been altered without authorization, or having not been stamped by the "Dedicated Testing/Inspection Stamp" is deemed to be invalid. Copying or excerpting portion of, or altering the content of the report is not permitted without the written authorization of AGC. The test results presented in the report apply only to the tested sample. Any objections to report issued by AGC should be submitted to AGC within 15days after the issuance of the test report. Further enquiry of validity or verification of the test report should be addressed to AGC by agc@agc-cert.com.



Z (mm)	0.00	4.00	9.00	14.00	19.00	24.00	29.00
SAR (W/Kg)	1.1261	0.6579	0.3245	0.1814	0.1027	0.0538	0.0304

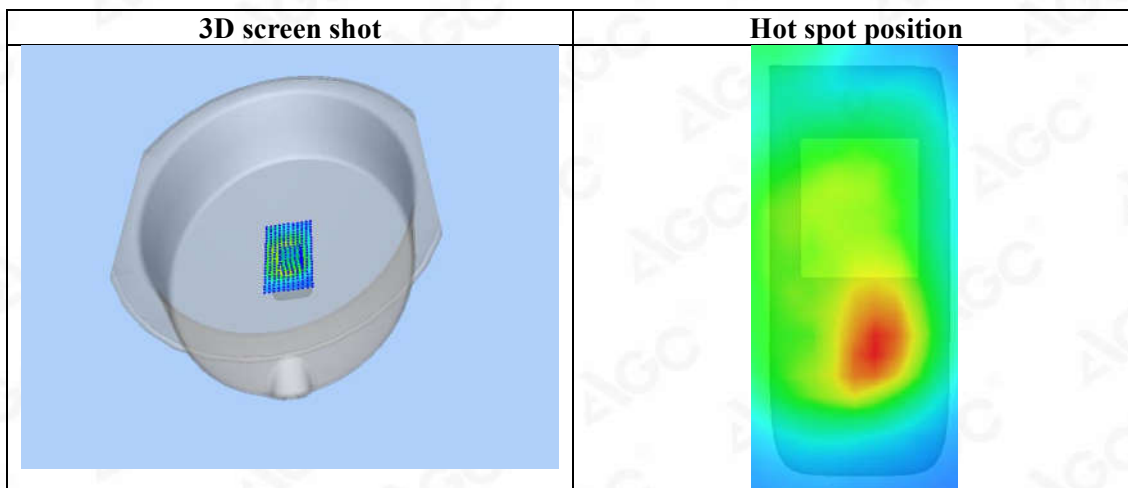
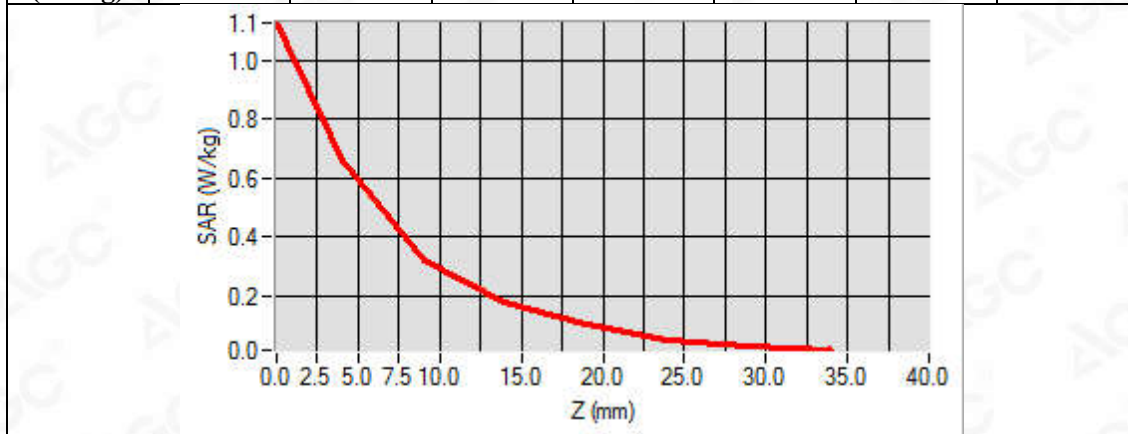

Any report having not been signed by authorized approver, or having been altered without authorization, or having not been stamped by the "Dedicated Testing/Inspection Stamp" is deemed to be invalid. Copying or excerpting portion of, or altering the content of the report is not permitted without the written authorization of AGC. The test results presented in the report apply only to the tested sample. Any objections to report issued by AGC should be submitted to AGC within 15days after the issuance of the test report. Further enquiry of validity or verification of the test report should be addressed to AGC by agc@agc-cert.com.



Test Laboratory: AGC Lab
WCDMA Band II Mid-Touch-Left (RMC)
DUT: Smart phone; Type: K58

Date: Jan. 21, 2022

Communication System: UMTS; Communication System Band: Band II UTRA/FDD ;Duty Cycle:1:1; Conv.F=4.57;
Frequency: 1880 MHz; Medium parameters used: $f = 1800$ MHz; $\sigma = 1.37$ mho/m; $\epsilon_r = 38.72$; $\rho = 1000$ kg/m³ ;
Phantom section: Left Section
Ambient temperature (°C): 21.0, Liquid temperature (°C): 20.7

SATIMO Configuration:

- Probe: SSE5; Calibrated: Aug. 17, 2021; Serial No.: SN 24/20 EP336
- Sensor-Surface: 4mm (Mechanical Surface Detection)
- Phantom: SAM twin phantom
- Measurement SW: OpenSAR V4_02_35

Configuration/ WCDMA Band II Mid-Touch-Left/Area Scan: Measurement grid: dx=8mm, dy=8mm
Configuration/ WCDMA Band II Mid-Touch-Left/Zoom Scan: Measurement grid:dx=8mm,dy=8mm,dz=5mm;

Area Scan	dx=8mm dy=8mm, h= 5.00 mm
ZoomScan	5x5x7,dx=8mm dy=8mm dz=5mm,Complete
Phantom	Left head
Device Position	Cheek
Band	WCDMA Band II
Channels	Middle
Signal	CDMA (Crest factor: 1.0)

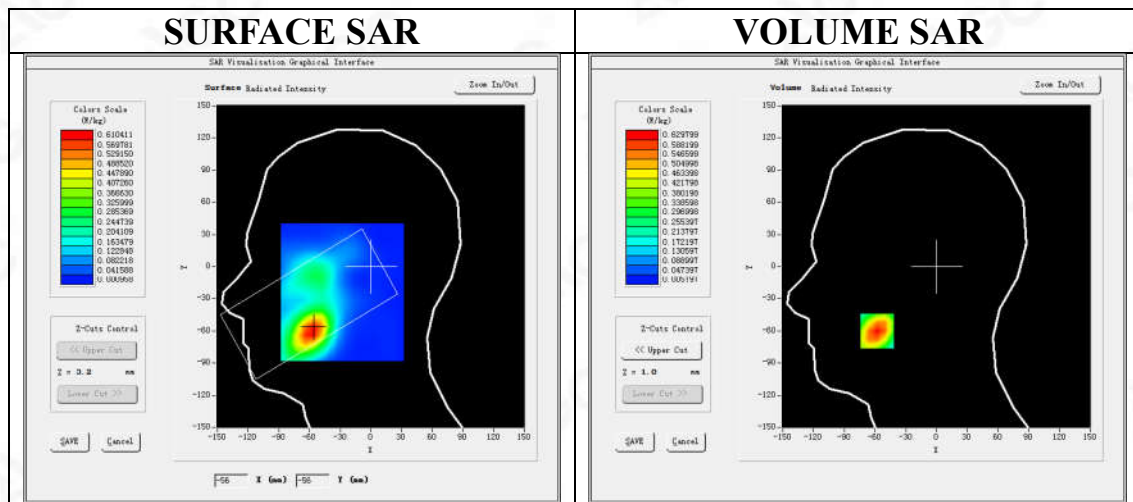

Maximum location: X=-58.00, Y=-60.00
SAR Peak: 0.99 W/kg

SAR 10g (W/Kg)	0.327831
SAR 1g (W/Kg)	0.602291

Any report having not been signed by authorized approver, or having been altered without authorization, or having not been stamped by the "Dedicated Testing/Inspection Stamp" is deemed to be invalid. Copying or excerpting portion of, or altering the content of the report is not permitted without the written authorization of AGC. The test results presented in the report apply only to the tested sample. Any objections to report issued by AGC should be submitted to AGC within 15days after the issuance of the test report. Further enquiry of validity or verification of the test report should be addressed to AGC by agc@agc-cert.com.



Z (mm)	0.00	4.00	9.00	14.00	19.00	24.00	29.00
SAR (W/Kg)	0.9868	0.6298	0.3536	0.2101	0.1241	0.0731	0.0422

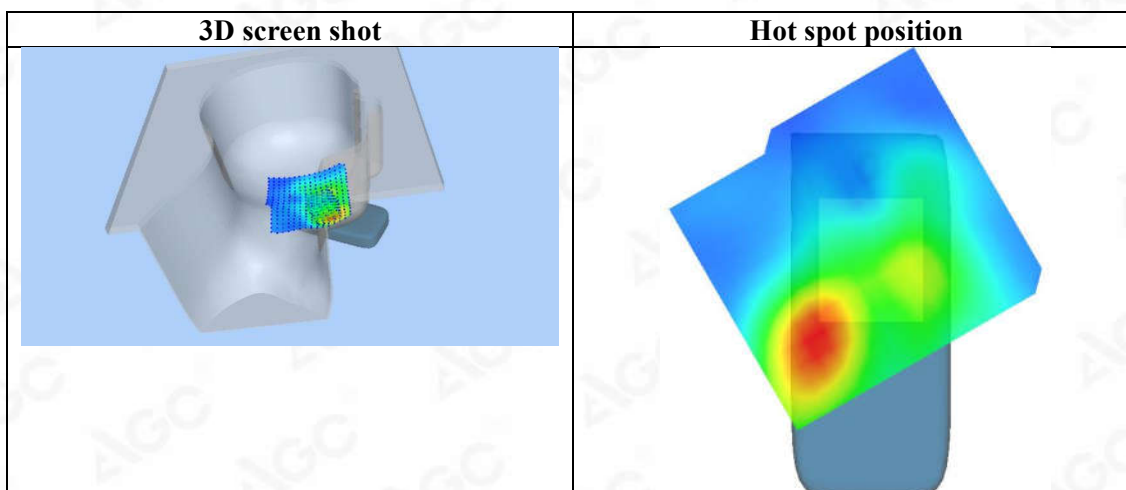
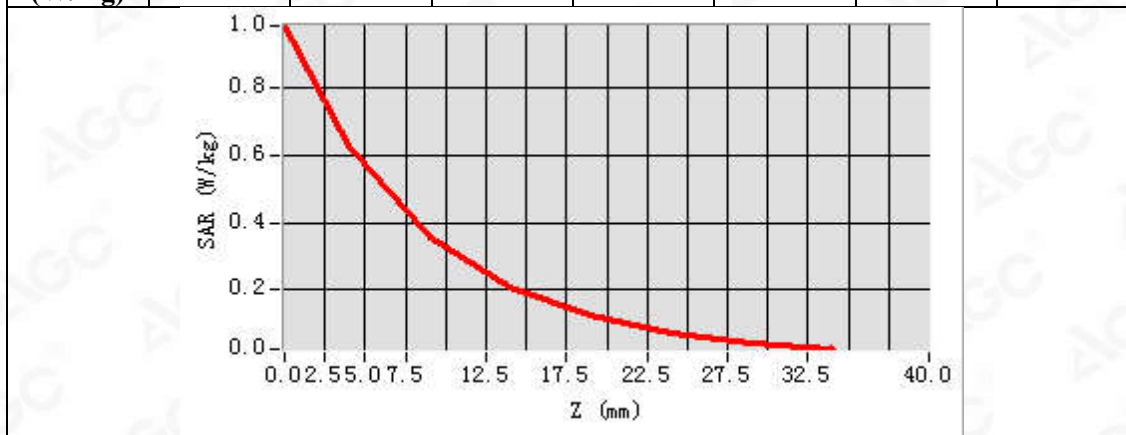

Any report having not been signed by authorized approver, or having been altered without authorization, or having not been stamped by the "Dedicated Testing/Inspection Stamp" is deemed to be invalid. Copying or excerpting portion of, or altering the content of the report is not permitted without the written authorization of AGC. The test results presented in the report apply only to the tested sample. Any objections to report issued by AGC should be submitted to AGC within 15 days after the issuance of the test report. Further enquiry of validity or verification of the test report should be addressed to AGC by agc@agc-cert.com.



Test Laboratory: AGC Lab
WCDMA Band II Low-Body-Towards Grounds (RMC 12.2kbps)
DUT: Smart phone; Type: K58

Date: Jan. 21, 2022

Communication System: UMTS; Communication System Band: Band II UTRA/FDD ;Duty Cycle:1:1; Conv.F=4.57;
Frequency: 1852.4 MHz; Medium parameters used: $f = 1800$ MHz; $\sigma=1.36$ mho/m; $\epsilon_r = 38.99$; $\rho= 1000$ kg/m³ ;
Phantom section: Flat Section
Ambient temperature (°C): 21.0, Liquid temperature (°C): 20.7

SATIMO Configuration:

- Probe: SSE5; Calibrated: Aug. 17, 2021; Serial No.: SN 24/20 EP336
- Sensor-Surface: 4mm (Mechanical Surface Detection)
- Phantom: ELLI39 Phantom
- Measurement SW: OpenSAR V4_02_35

Configuration/ WCDMA band II Low-Body-Back/Area Scan: Measurement grid: dx=8mm, dy=8mm
Configuration/ WCDMA band II Low-Body-Back/Zoom Scan: Measurement grid: dx=8mm,dy=8mm, dz=5m;

Area Scan	dx=8mm dy=8mm, h= 5.00 mm
ZoomScan	5x5x7,dx=8mm dy=8mm dz=5mm,Complete
Phantom	ELLI
Device Position	Body Back
Band	WCDMA band II
Channels	Low
Signal	CDMA (Crest factor: 1.0)

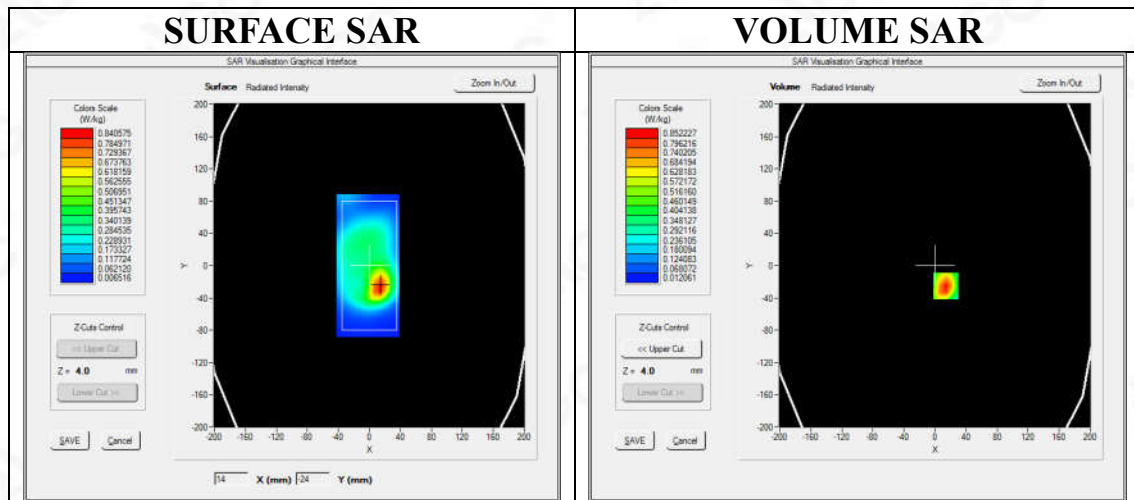

Maximum location: X=14.00, Y=-25.00

SAR Peak: 1.39 W/kg

SAR 10g (W/Kg)	0.423510
SAR 1g (W/Kg)	0.817879

Any report having not been signed by authorized approver, or having been altered without authorization, or having not been stamped by the "Dedicated Testing/Inspection Stamp" is deemed to be invalid. Copying or excerpting portion of, or altering the content of the report is not permitted without the written authorization of AGC. The test results presented in the report apply only to the tested sample. Any objections to report issued by AGC should be submitted to AGC within 15days after the issuance of the test report. Further enquiry of validity or verification of the test report should be addressed to AGC by agc@agc-cert.com.



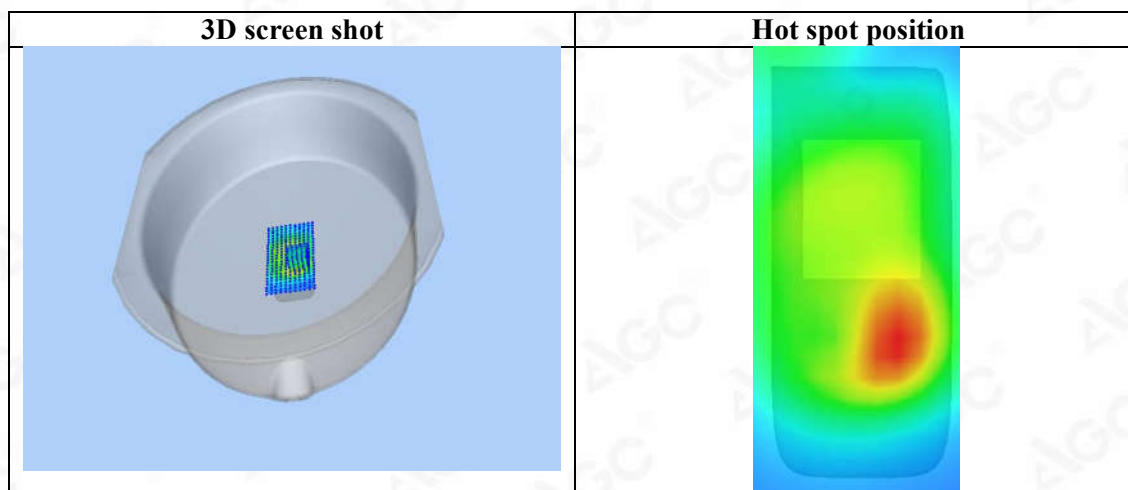
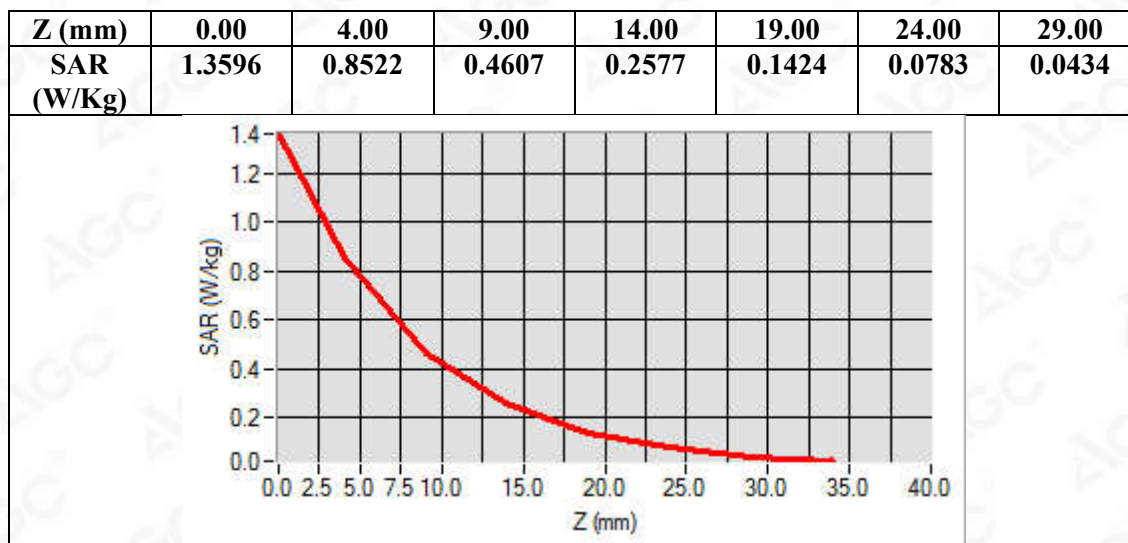

Any report having not been signed by authorized approver, or having been altered without authorization, or having not been stamped by the "Dedicated Testing/Inspection Stamp" is deemed to be invalid. Copying or excerpting portion of, or altering the content of the report is not permitted without the written authorization of AGC. The test results presented in the report apply only to the tested sample. Any objections to report issued by AGC should be submitted to AGC within 15days after the issuance of the test report. Further enquiry of validity or verification of the test report should be addressed to AGC by agc@agc-cert.com.



Test Laboratory: AGC Lab
WCDMA Band II Mid-Body-Towards Grounds (RMC 12.2kbps)
DUT: Smart phone; Type: K58

Date: Jan. 21, 2022

Communication System: UMTS; Communication System Band: Band II UTRA/FDD ;Duty Cycle:1:1; Conv.F=4.57;
Frequency: 1880 MHz; Medium parameters used: $f = 1800$ MHz; $\sigma = 1.37$ mho/m; $\epsilon_r = 38.72$; $\rho = 1000$ kg/m³ ;
Phantom section: Flat Section
Ambient temperature (°C): 21.0, Liquid temperature (°C): 20.7

SATIMO Configuration:

- Probe: SSE5; Calibrated: Aug. 17, 2021; Serial No.: SN 24/20 EP336
- Sensor-Surface: 4mm (Mechanical Surface Detection)
- Phantom: ELLI39 Phantom
- Measurement SW: OpenSAR V4_02_35

Configuration/ WCDMA band II Mid-Body-Back/Area Scan: Measurement grid: dx=8mm, dy=8mm
Configuration/ WCDMA band II Mid-Body-Back/Zoom Scan: Measurement grid: dx=8mm, dy=8mm, dz=5mm;

Area Scan	dx=8mm dy=8mm, h= 5.00 mm
ZoomScan	5x5x7,dx=8mm dy=8mm dz=5mm,Complete
Phantom	ELLI
Device Position	Body Back
Band	WCDMA band II
Channels	Middle
Signal	CDMA (Crest factor: 1.0)

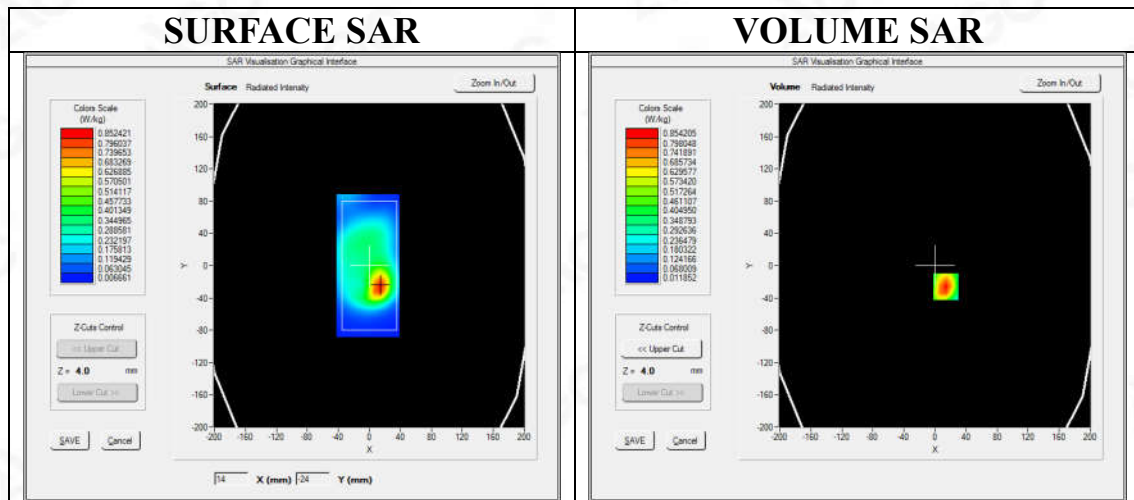

Maximum location: X=14.00, Y=-26.00

SAR Peak: 1.38 W/kg

SAR 10g (W/Kg)	0.422940
SAR 1g (W/Kg)	0.815546

Any report having not been signed by authorized approver, or having been altered without authorization, or having not been stamped by the "Dedicated Testing/Inspection Stamp" is deemed to be invalid. Copying or excerpting portion of, or altering the content of the report is not permitted without the written authorization of AGC. The test results presented in the report apply only to the tested sample. Any objections to report issued by AGC should be submitted to AGC within 15days after the issuance of the test report. Further enquiry of validity or verification of the test report should be addressed to AGC by agc@agc-cert.com.



Z (mm)	0.00	4.00	9.00	14.00	19.00	24.00	29.00
SAR (W/Kg)	1.3565	0.8542	0.4635	0.2583	0.1419	0.0785	0.0439

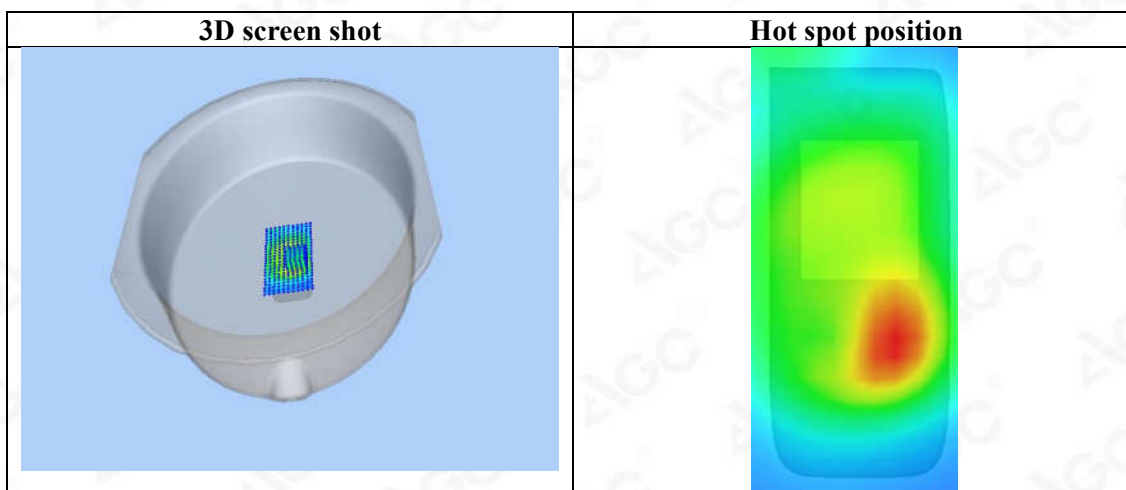
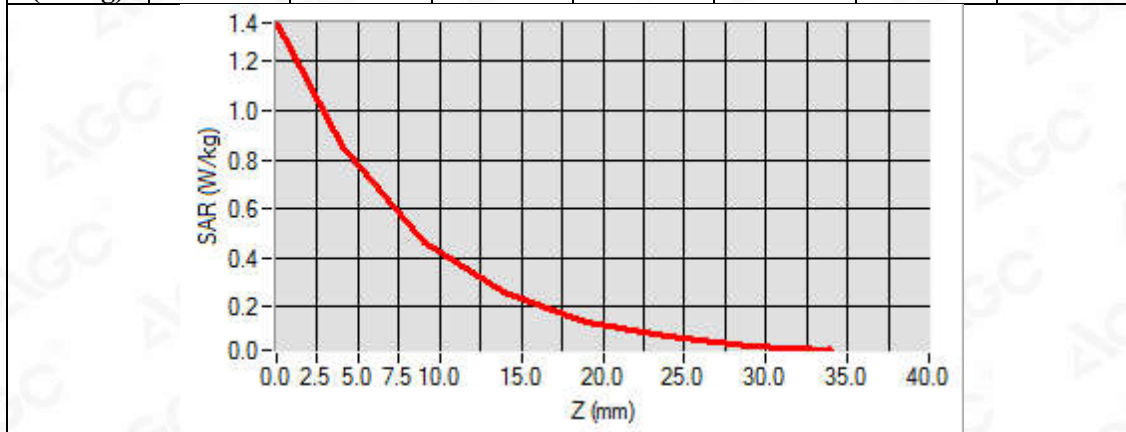

Any report having not been signed by authorized approver, or having been altered without authorization, or having not been stamped by the "Dedicated Testing/Inspection Stamp" is deemed to be invalid. Copying or excerpting portion of, or altering the content of the report is not permitted without the written authorization of AGC. The test results presented in the report apply only to the tested sample. Any objections to report issued by AGC should be submitted to AGC within 15 days after the issuance of the test report. Further enquiry of validity or verification of the test report should be addressed to AGC by agc@agc-cert.com.



Test Laboratory: AGC Lab

Date: Jan. 20, 2022

WCDMA Band V Mid-Touch-Right (RMC)

DUT: Smart phone; Type: K58

Communication System: UMTS; Communication System Band: BAND V UTRA/FDD ; Duty Cycle:1: 1; Conv.F=5.21; Frequency: 836.4 MHz; Medium parameters used: $f = 835\text{MHz}$; $\sigma = 0.91\text{ mho/m}$; $\epsilon_r = 41.53$; $\rho = 1000\text{ kg/m}^3$; Phantom section: Right Section Ambient temperature ($^{\circ}\text{C}$): 20.8, Liquid temperature ($^{\circ}\text{C}$): 20.6

SATIMO Configuration:

- Probe: SSE5; Calibrated: Aug. 17, 2021; Serial No.: SN 24/20 EP336
- Sensor-Surface: 4mm (Mechanical Surface Detection)
- Phantom: SAM twin phantom
- Measurement SW: OpenSAR V4_02_35

Configuration/ WCDMA Band V Mid-Touch-Right/Area Scan: Measurement grid: dx=8mm, dy=8mm

Configuration/ WCDMA Band V Mid-Touch-Right/Zoom Scan: Measurement grid: dx=8mm, dy=8mm, dz=5mm

Area Scan	dx=8mm dy=8mm, h= 5.00 mm
ZoomScan	5x5x7,dx=8mm dy=8mm dz=5mm,Complete
Phantom	Right head
Device Position	Cheek
Band	WCDMA Band V
Channels	Middle
Signal	CDMA (Crest factor: 1.0)

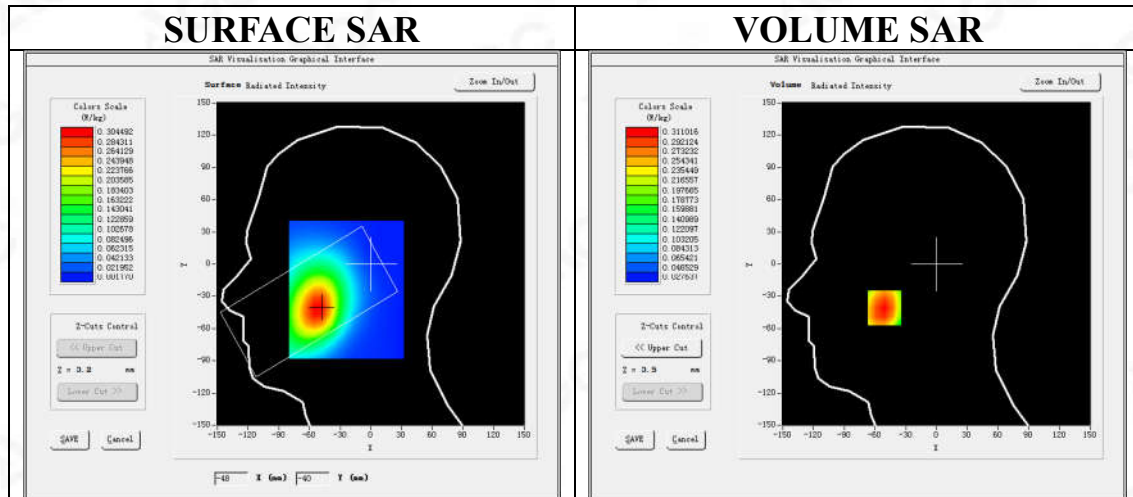

Maximum location: X=-51.00, Y=-41.00

SAR Peak: 0.40 W/kg

SAR 10g (W/Kg)	0.213312
SAR 1g (W/Kg)	0.301543

Any report having not been signed by authorized approver, or having been altered without authorization, or having not been stamped by the "Dedicated Testing/Inspection Stamp" is deemed to be invalid. Copying or excerpting portion of, or altering the content of the report is not permitted without the written authorization of AGC. The test results presented in the report apply only to the tested sample. Any objections to report issued by AGC should be submitted to AGC within 15days after the issuance of the test report. Further enquiry of validity or verification of the test report should be addressed to AGC by agc@agc-cert.com.



Z (mm)	0.00	4.00	9.00	14.00	19.00	24.00	29.00
SAR (W/Kg)	0.3961	0.3110	0.2330	0.1786	0.1363	0.1019	0.0777

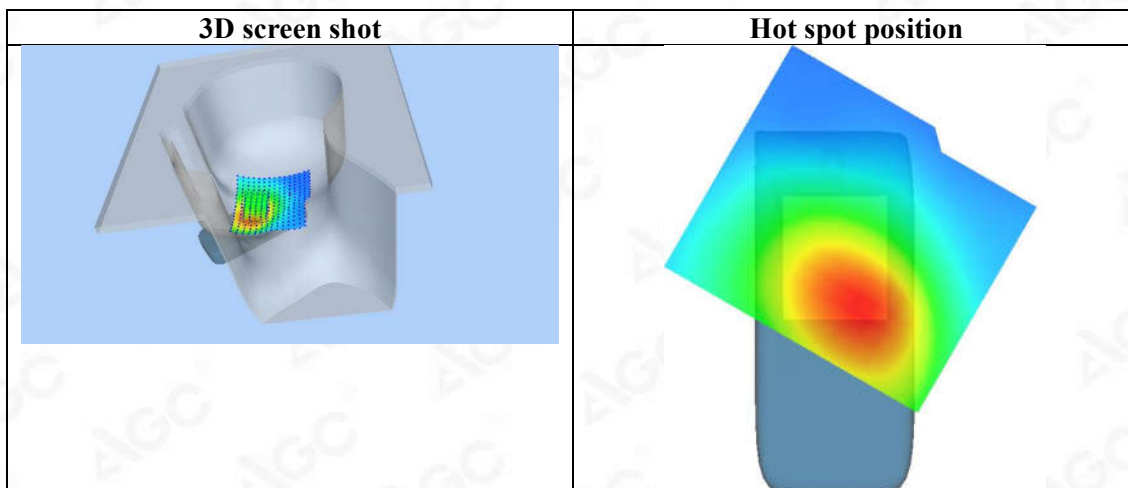
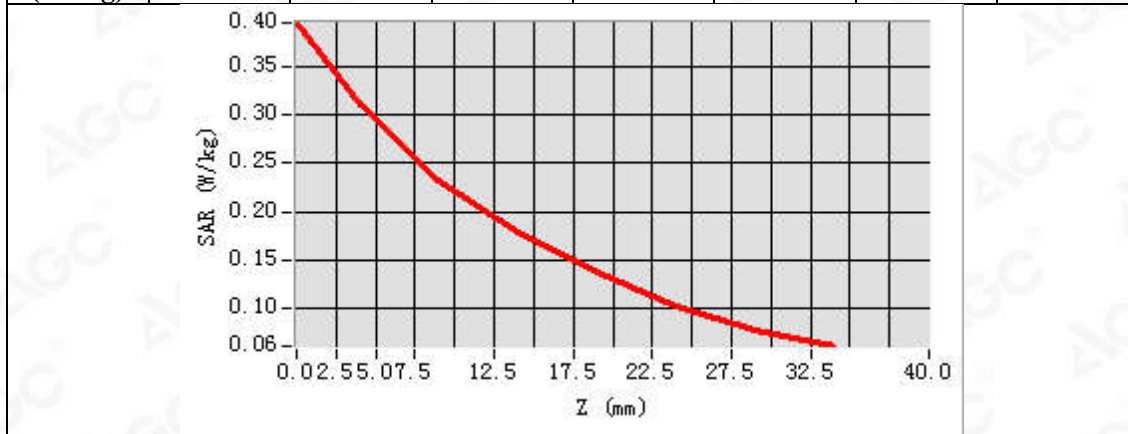

Any report having not been signed by authorized approver, or having been altered without authorization, or having not been stamped by the "Dedicated Testing/Inspection Stamp" is deemed to be invalid. Copying or excerpting portion of, or altering the content of the report is not permitted without the written authorization of AGC. The test results presented in the report apply only to the tested sample. Any objections to report issued by AGC should be submitted to AGC within 15days after the issuance of the test report. Further enquiry of validity or verification of the test report should be addressed to AGC by agc@agc-cert.com.



Test Laboratory: AGC Lab

Date: Jan. 20, 2022

WCDMA Band V Mid-Body-Towards Grounds (RMC)

DUT: Smart phone; Type: K58

Communication System: UMTS; Communication System Band: BAND V UTRA/FDD; Duty Cycle:1: 1; Conv.F=5.21; Frequency: 836.4 MHz; Medium parameters used: $f = 835\text{MHz}$; $\sigma = 0.91\text{ mho/m}$; $\epsilon_r = 41.53$; $\rho = 1000\text{ kg/m}^3$; Phantom section: Flat Section
Ambient temperature ($^{\circ}\text{C}$): 20.8, Liquid temperature ($^{\circ}\text{C}$): 20.6

SATIMO Configuration:

- Probe: SSE5; Calibrated: Aug. 17, 2021; Serial No.: SN 24/20 EP336
- Sensor-Surface: 4mm (Mechanical Surface Detection)
- Phantom: ELLI39 Phantom
- Measurement SW: OpenSAR V4_02_35

Configuration/ WCDMA Band V Mid-Body-Back/Area Scan: Measurement grid: $dx=8\text{mm}$, $dy=8\text{mm}$

Configuration/ WCDMA Band V Mid-Body-Back/Zoom Scan: Measurement grid: $dx=8\text{mm}$, $dy=8\text{mm}$, $dz=5\text{mm}$;

Area Scan	$dx=8\text{mm}$ $dy=8\text{mm}$, $h= 5.00\text{ mm}$
ZoomScan	$5\times 5\times 7$, $dx=8\text{mm}$ $dy=8\text{mm}$ $dz=5\text{mm}$, Complete
Phantom	ELLI
Device Position	Body Back
Band	WCDMA Band V
Channels	Middle
Signal	CDMA (Crest factor: 1.0)

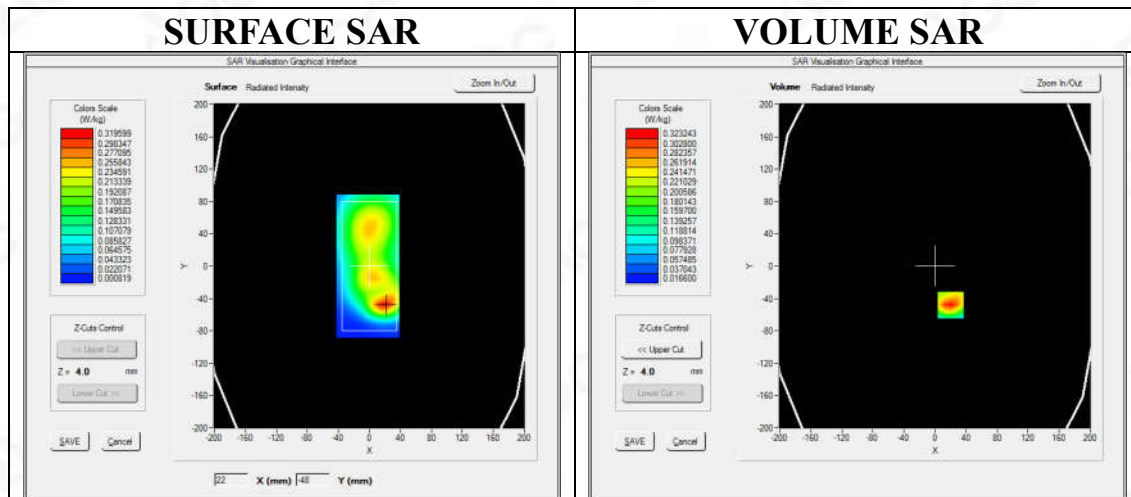

Maximum location: X=20.00, Y=-48.00

SAR Peak: 0.46 W/kg

SAR 10g (W/Kg)	0.182844
SAR 1g (W/Kg)	0.304242

Any report having not been signed by authorized approver, or having been altered without authorization, or having not been stamped by the "Dedicated Testing/Inspection Stamp" is deemed to be invalid. Copying or excerpting portion of, or altering the content of the report is not permitted without the written authorization of AGC. The test results presented in the report apply only to the tested sample. Any objections to report issued by AGC should be submitted to AGC within 15 days after the issuance of the test report. Further enquiry of validity or verification of the test report should be addressed to AGC by agc@agc-cert.com.

Attestation of Global Compliance(Shenzhen)Co., Ltd

Attestation of Global Compliance(Shenzhen)Std & Tech Co., Ltd

Tel: +86-755 2523 4088 E-mail: agc@agc-cert.com Web: <http://cn.agc-cert.com/>



Z (mm)	0.00	4.00	9.00	14.00	19.00	24.00	29.00
SAR (W/Kg)	0.4644	0.3232	0.2061	0.1358	0.0909	0.0619	0.0426

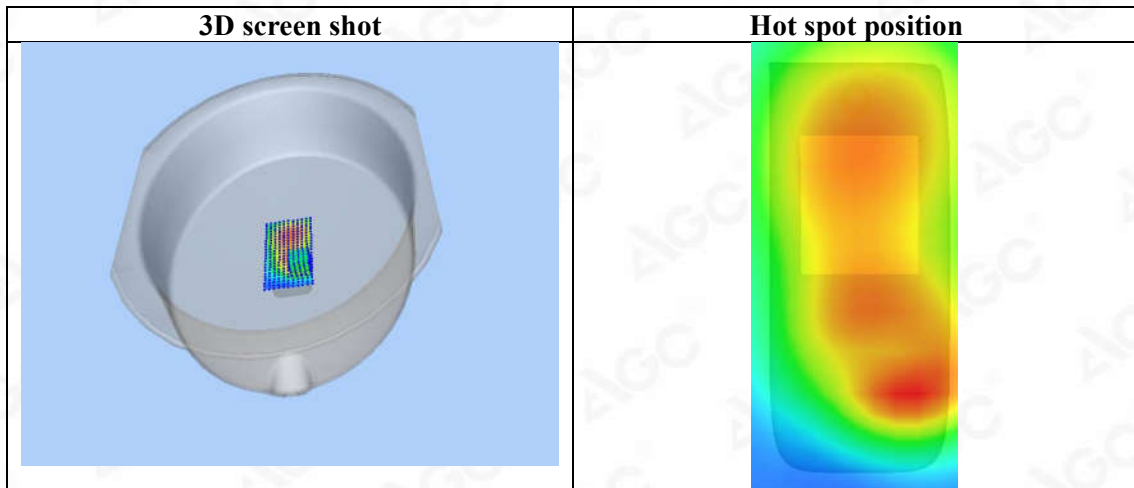
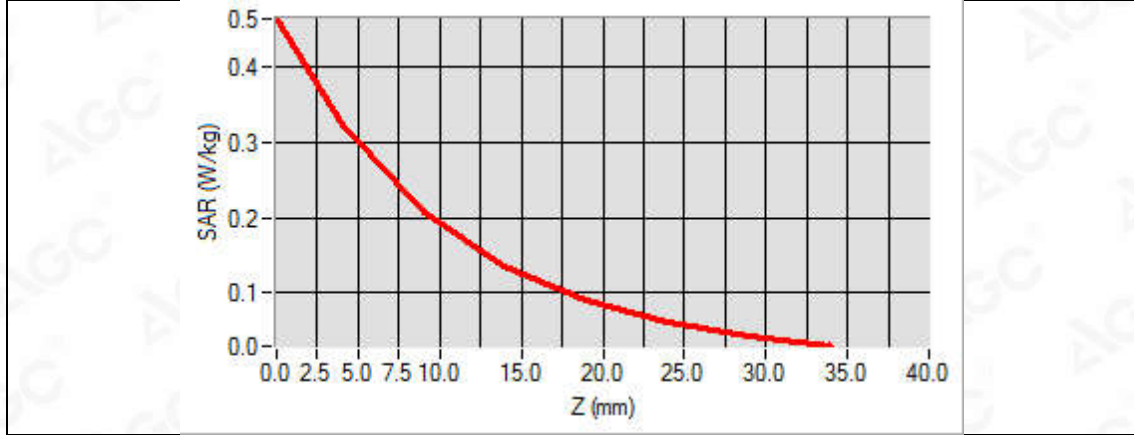

Any report having not been signed by authorized approver, or having been altered without authorization, or having not been stamped by the "Dedicated Testing/Inspection Stamp" is deemed to be invalid. Copying or excerpting portion of, or altering the content of the report is not permitted without the written authorization of AGC. The test results presented in the report apply only to the tested sample. Any objections to report issued by AGC should be submitted to AGC within 15 days after the issuance of the test report. Further enquiry of validity or verification of the test report should be addressed to AGC by agc@agc-cert.com.



Test Laboratory: AGC Lab
LTE Band 2 Mid-Touch-Right (1 RB#0)
DUT: Smart phone; Type: K58

Date: Jan. 25, 2022

Communication System: LTE; Communication System Band: LTE Band 2; Duty Cycle:1:1; Conv.F=4.57;
Frequency:1880MHz; Medium parameters used: $f=1900$ MHz; $\sigma=1.40$ mho/m; $\epsilon_r=39.81$; $\rho=1000$ kg/m³ ;
Phantom section: Right Section
Ambient temperature (°C): 21.3, Liquid temperature (°C): 21.1

SATIMO Configuration:

- Probe: SSE5; Calibrated: Aug. 17, 2021; Serial No.: SN 24/20 EP336
- Sensor-Surface: 4mm (Mechanical Surface Detection)
- Phantom: SAM twin phantom
- Measurement SW: OpenSAR V4_02_35

Configuration/ LTE Band 2 Mid- Touch-Right /Area Scan: Measurement grid: dx=8mm, dy=8mm
Configuration/ LTE Band 2 Mid- Touch-Right /Zoom Scan: Measurement grid: dx=8mm,dy=8mm, dz=5mm;

Area Scan	dx=8mm dy=8mm, h= 5.00 mm
Zoom Scan	5x5x7,dx=8mm dy=8mm dz=5mm
Phantom	Right head
Device Position	Cheek
Band	LTE Band 2
Channels	Middle
Signal	OFDM (Crest factor: 1.0)

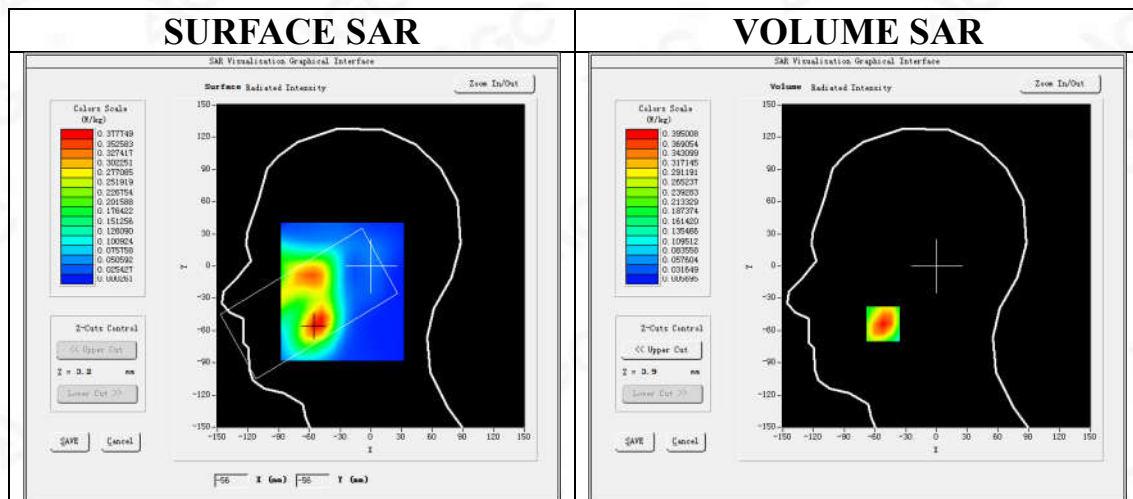

Maximum location: X=-52.00, Y=-54.00

SAR Peak: 0.59 W/kg

SAR 10g (W/Kg)	0.215673
SAR 1g (W/Kg)	0.376171

Any report having not been signed by authorized approver, or having been altered without authorization, or having not been stamped by the "Dedicated Testing/Inspection Stamp" is deemed to be invalid. Copying or excerpting portion of, or altering the content of the report is not permitted without the written authorization of AGC. The test results presented in the report apply only to the tested sample. Any objections to report issued by AGC should be submitted to AGC within 15days after the issuance of the test report. Further enquiry of validity or verification of the test report should be addressed to AGC by agc@agc-cert.com.



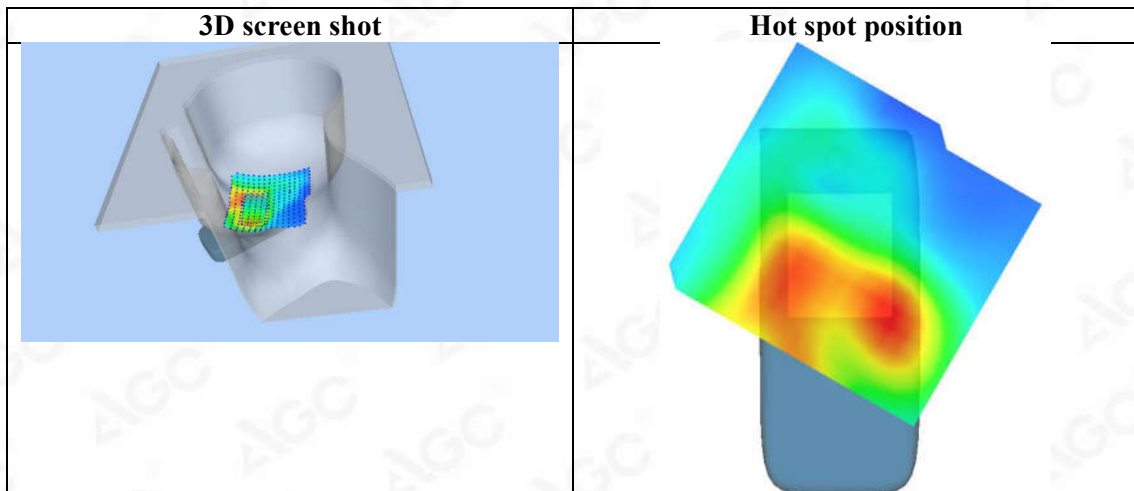
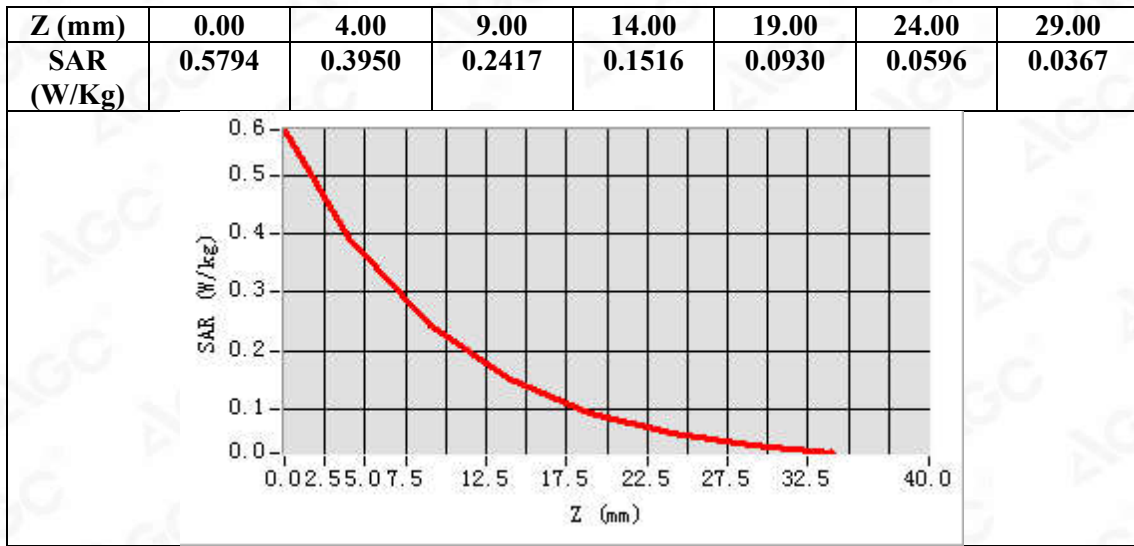

Any report having not been signed by authorized approver, or having been altered without authorization, or having not been stamped by the "Dedicated Testing/Inspection Stamp" is deemed to be invalid. Copying or excerpting portion of, or altering the content of the report is not permitted without the written authorization of AGC. The test results presented in the report apply only to the tested sample. Any objections to report issued by AGC should be submitted to AGC within 15 days after the issuance of the test report. Further enquiry of validity or verification of the test report should be addressed to AGC by agc@agc-cert.com.



Test Laboratory: AGC Lab
LTE Band 2 Mid-Body-Back (1 RB#0)
DUT: Smart phone; Type: K58

Date: Jan. 25, 2022

Communication System: LTE; Communication System Band: LTE Band 2; Duty Cycle:1:1; Conv.F=4.57;
Frequency:1880MHz; Medium parameters used: $f = 1800$ MHz; $\sigma = 1.40$ mho/m; $\epsilon_r = 39.81$; $\rho = 1000$ kg/m³ ;
Phantom section: Flat Section
Ambient temperature (°C): 21.3, Liquid temperature (°C): 21.1

SATIMO Configuration:

- Probe: SSE5; Calibrated: Aug. 17, 2021; Serial No.: SN 24/20 EP336
- Sensor-Surface: 4mm (Mechanical Surface Detection)
- Phantom: ELLI39 Phantom
- Measurement SW: OpenSAR V4_02_35

Configuration/ LTE Band 2 Mid-Body-Back/Area Scan: Measurement grid: dx=8mm, dy=8mm
Configuration/ LTE Band 2 Mid-Body-Back/Zoom Scan: Measurement grid: dx=8mm,dy=8mm, dz=5mm;

Area Scan	dx=8mm dy=8mm, h= 5.00 mm
Zoom Scan	5x5x7,dx=8mm dy=8mm dz=5mm
Phantom	ELLI
Device Position	Body Back
Band	LTE Band 2
Channels	Middle
Signal	OFDM (Crest factor: 1.0)

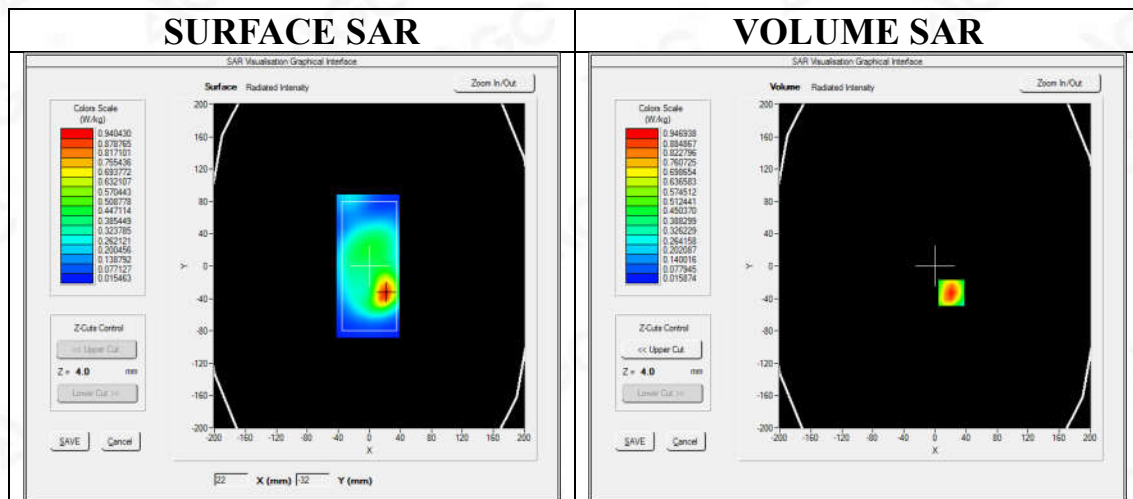

Maximum location: X=21.00, Y=-33.00

SAR Peak: 1.49 W/kg

SAR 10g (W/Kg)	0.481045
SAR 1g (W/Kg)	0.902899

Any report having not been signed by authorized approver, or having been altered without authorization, or having not been stamped by the "Dedicated Testing/Inspection Stamp" is deemed to be invalid. Copying or excerpting portion of, or altering the content of the report is not permitted without the written authorization of AGC. The test results presented in the report apply only to the tested sample. Any objections to report issued by AGC should be submitted to AGC within 15days after the issuance of the test report. Further enquiry of validity or verification of the test report should be addressed to AGC by agc@agc-cert.com.



Z (mm)	0.00	4.00	9.00	14.00	19.00	24.00	29.00
SAR (W/Kg)	1.4896	0.9469	0.5222	0.2986	0.1666	0.0941	0.0532

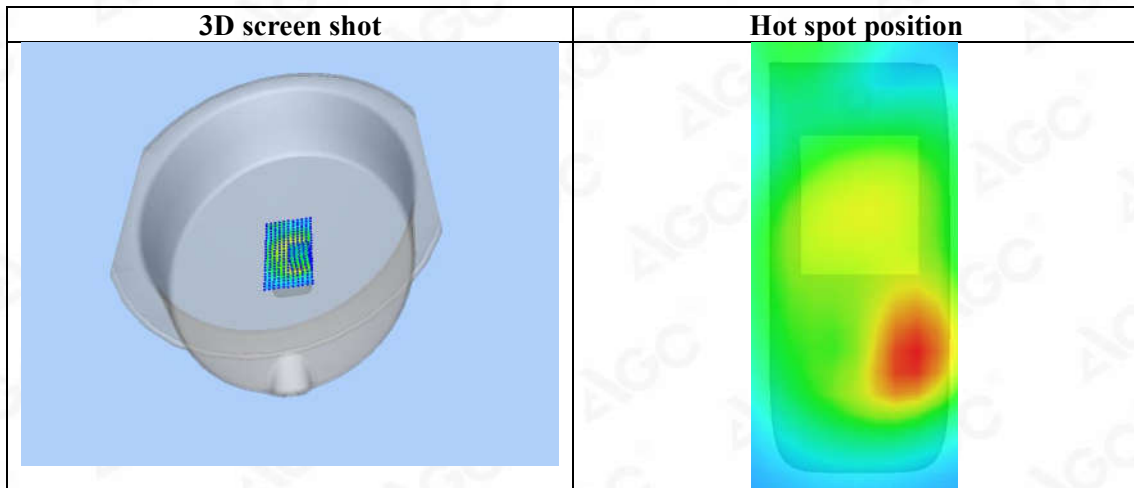
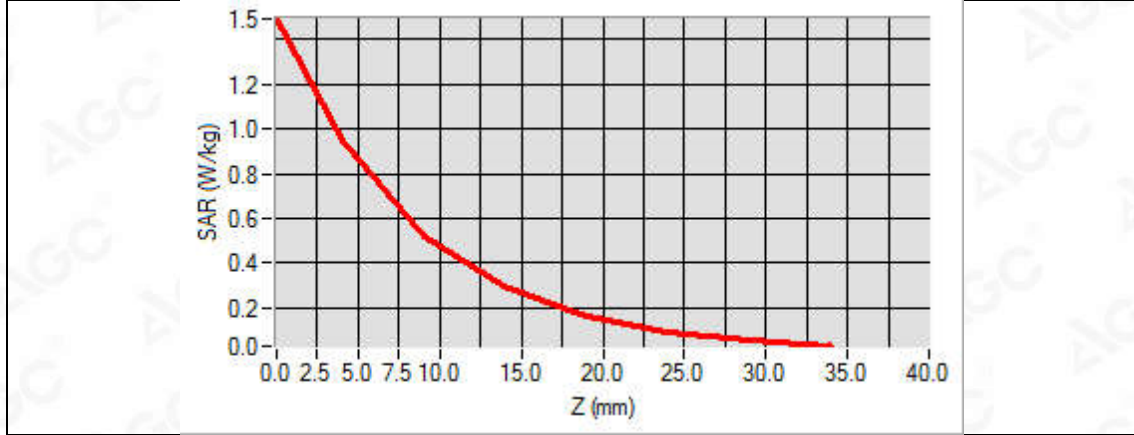

Any report having not been signed by authorized approver, or having been altered without authorization, or having not been stamped by the "Dedicated Testing/Inspection Stamp" is deemed to be invalid. Copying or excerpting portion of, or altering the content of the report is not permitted without the written authorization of AGC. The test results presented in the report apply only to the tested sample. Any objections to report issued by AGC should be submitted to AGC within 15days after the issuance of the test report. Further enquiry of validity or verification of the test report should be addressed to AGC by agc@agc-cert.com.



Test Laboratory: AGC Lab
LTE Band 2 High-Body-Back (1 RB#0)
DUT: Smart phone; Type: K58

Date: Jan. 25, 2022

Communication System: LTE; Communication System Band: LTE Band 2; Duty Cycle:1:1; Conv.F=4.57;
Frequency:1900MHz; Medium parameters used: $f = 1800$ MHz; $\sigma = 1.40$ mho/m; $\epsilon_r = 39.81$; $\rho = 1000$ kg/m³ ;
Phantom section: Flat Section
Ambient temperature (°C): 21.3, Liquid temperature (°C): 21.1

SATIMO Configuration:

- Probe: SSE5; Calibrated: Aug. 17, 2021; Serial No.: SN 24/20 EP336
- Sensor-Surface: 4mm (Mechanical Surface Detection)
- Phantom: ELLI39 Phantom
- Measurement SW: OpenSAR V4_02_35

Configuration/ LTE Band 2 High-Body-Back/Area Scan: Measurement grid: dx=8mm, dy=8mm
Configuration/ LTE Band 2 High-Body-Back/Zoom Scan: Measurement grid: dx=8mm,dy=8mm, dz=5mm;

Area Scan	dx=8mm dy=8mm, h= 5.00 mm
Zoom Scan	5x5x7,dx=8mm dy=8mm dz=5mm
Phantom	ELLI
Device Position	Body Back
Band	LTE Band 2
Channels	High
Signal	OFDM (Crest factor: 1.0)

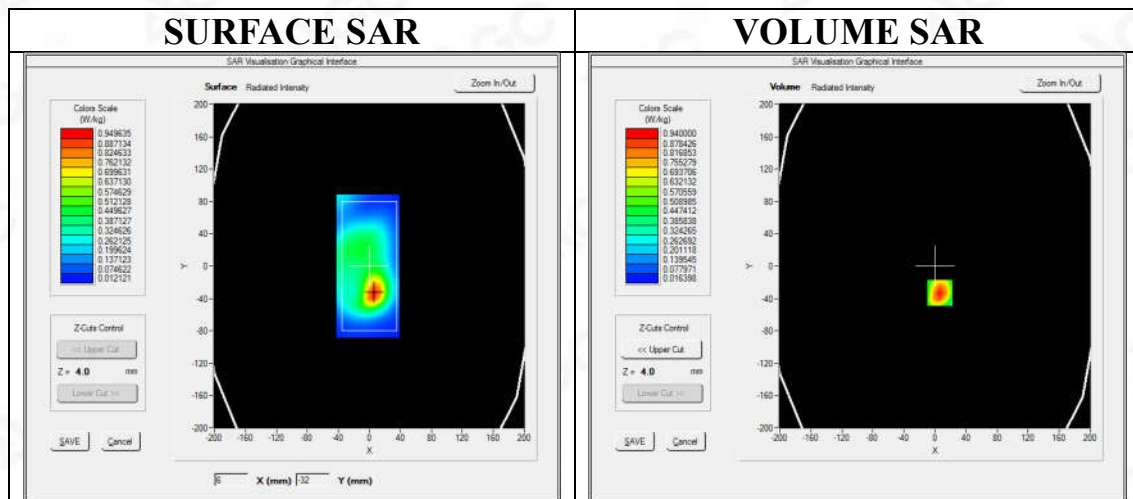

Maximum location: X=6.00, Y=-33.00
SAR Peak: 1.48 W/kg

SAR 10g (W/Kg)	0.477620
SAR 1g (W/Kg)	0.895936

Any report having not been signed by authorized approver, or having been altered without authorization, or having not been stamped by the "Dedicated Testing/Inspection Stamp" is deemed to be invalid. Copying or excerpting portion of, or altering the content of the report is not permitted without the written authorization of AGC. The test results presented in the report apply only to the tested sample. Any objections to report issued by AGC should be submitted to AGC within 15days after the issuance of the test report. Further enquiry of validity or verification of the test report should be addressed to AGC by agc@agc-cert.com.



Z (mm)	0.00	4.00	9.00	14.00	19.00	24.00	29.00
SAR (W/Kg)	1.4763	0.9400	0.5193	0.2943	0.1648	0.0927	0.0525

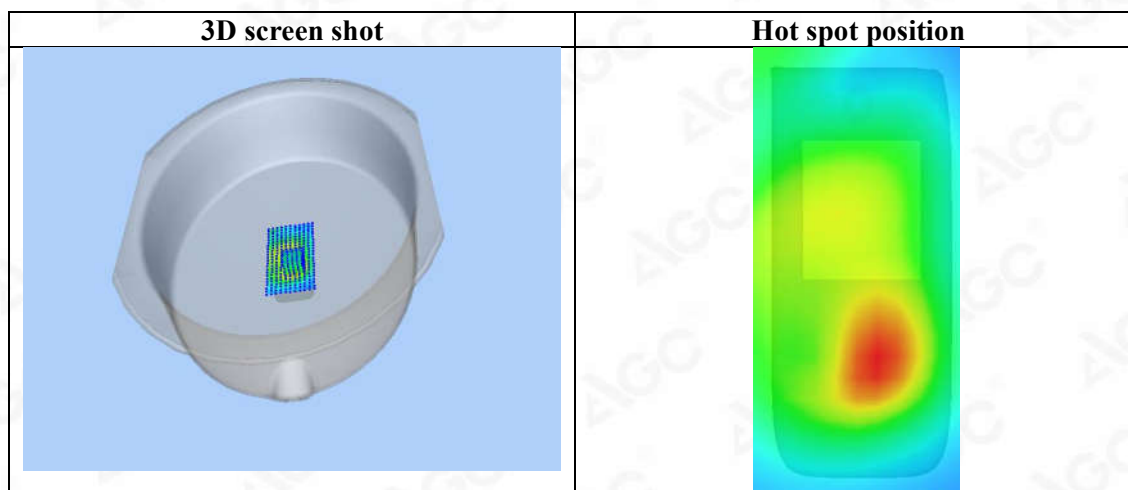
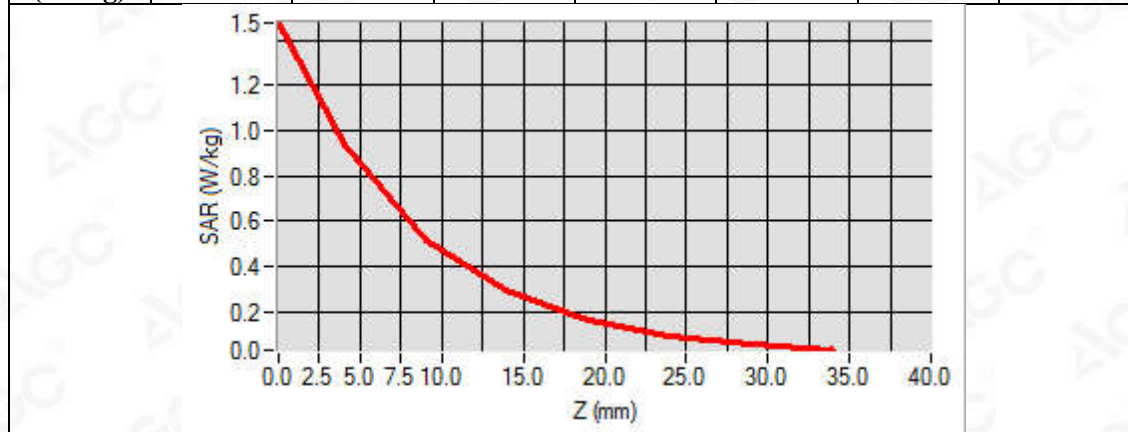

Any report having not been signed by authorized approver, or having been altered without authorization, or having not been stamped by the "Dedicated Testing/Inspection Stamp" is deemed to be invalid. Copying or excerpting portion of, or altering the content of the report is not permitted without the written authorization of AGC. The test results presented in the report apply only to the tested sample. Any objections to report issued by AGC should be submitted to AGC within 15days after the issuance of the test report. Further enquiry of validity or verification of the test report should be addressed to AGC by agc@agc-cert.com.



Test Laboratory: AGC Lab
LTE Band 4 Mid-Touch-Left (1 RB#0)
DUT: Smart phone; Type: K58

Date: Jan. 21, 2022

Communication System: LTE; Communication System Band: LTE Band 4; Duty Cycle:1:1; Conv.F=4.57;
Frequency:1732.5 MHz; Medium parameters used: $f = 1750$ MHz; $\sigma = 1.36$ mho/m; $\epsilon_r = 40.56$; $\rho = 1000$ kg/m³ ;
Phantom section: Left Section
Ambient temperature (°C): 21.0, Liquid temperature (°C): 20.8

SATIMO Configuration:

- Probe: SSE5; Calibrated: Aug. 17, 2021; Serial No.: SN 24/20 EP336
- Sensor-Surface: 4mm (Mechanical Surface Detection)
- Phantom: SAM twin phantom
- Measurement SW: OpenSAR V4_02_35

Configuration/ LTE Band 4 Mid- Touch-Left /Area Scan: Measurement grid: dx=8mm, dy=8mm

Configuration/ LTE Band 4 Mid- Touch-Left /Zoom Scan: Measurement grid: dx=8mm,dy=8mm, dz=5mm;

Area Scan	dx=8mm dy=8mm, h= 5.00 mm
Zoom Scan	5x5x7,dx=8mm dy=8mm dz=5mm
Phantom	Left head
Device Position	Cheek
Band	LTE Band 4
Channels	Middle
Signal	OFDM (Crest factor: 1.0)

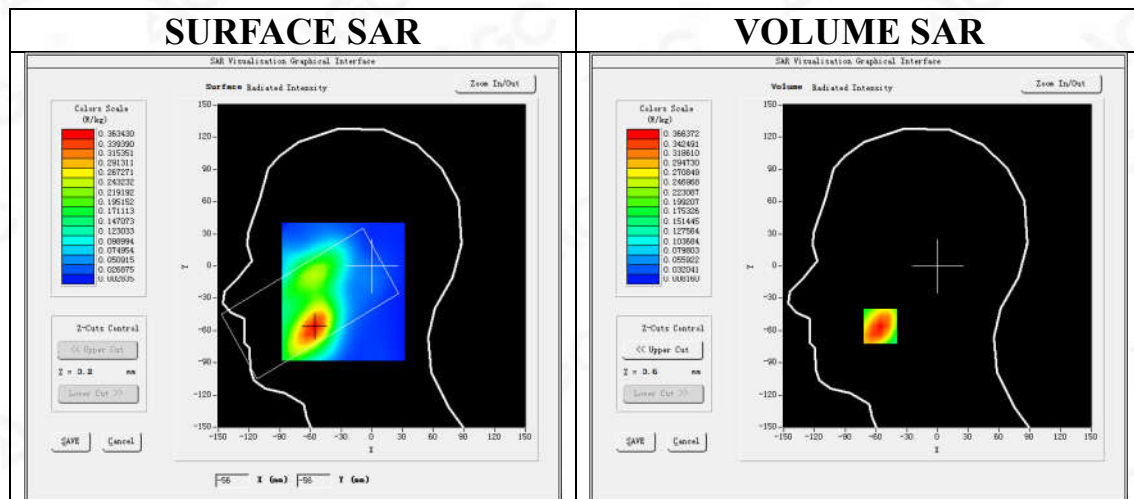

Maximum location: X=-56.00, Y=-56.00

SAR Peak: 0.54 W/kg

SAR 10g (W/Kg)	0.207579
SAR 1g (W/Kg)	0.351813

Any report having not been signed by authorized approver, or having been altered without authorization, or having not been stamped by the "Dedicated Testing/Inspection Stamp" is deemed to be invalid. Copying or excerpting portion of, or altering the content of the report is not permitted without the written authorization of AGC. The test results presented in the report apply only to the tested sample. Any objections to report issued by AGC should be submitted to AGC within 15days after the issuance of the test report. Further enquiry of validity or verification of the test report should be addressed to AGC by agc@agc-cert.com.

