

FCC RADIO TEST REPORT

Applicant..... : Xiamen Paperang Technology Co., Ltd.
Address..... : Room 3124, Xuanye Building, Pioneer Park, Xiamen Torch High-Tech Zone,
Fujian, China
Manufacturer..... : Xiamen Paperang Technology Co., Ltd.
Address..... : Room 3124, Xuanye Building, Pioneer Park, Xiamen Torch High-Tech Zone,
Fujian, China
Factory..... : Xiamen IPRT Technology Co., Ltd.
Address..... : 3rd, 4th and 5th floor, No. 101, Huli Industrial Park, Meixi Road, Tong'an District,
Xiamen City
Product Name..... : Paperang Printer
Brand Name..... : PAPERANG
Model No. : A4N7, A4A7, A4B7, A4C7, A4S7, A4X7, A4W7, A4Y7, A4Z7
(For model difference refer to section 2)
FCC ID..... : 2APWO-A4N7
Measurement Standard..... : 47 CFR FCC Part 15, Subpart C (Section 15.247)
Receipt Date of Samples.... : June 07, 2022
Date of Tested..... : June 07, 2022 to June 21, 2022
Date of Report..... : July 01, 2022

This report shows that above equipment is technically compliant with the requirements of the standards above. All test results in this report apply only to the tested sample(s). Without prior written approval of Dongguan Nore Testing Center Co., Ltd, this report shall not be reproduced except in full.

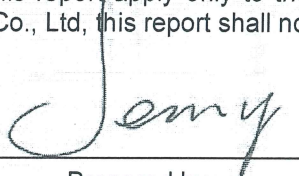

Prepared by

Jenny Liu / Project Engineer



Approved by

Lori Fan / Authorized Signatory

Table of Contents

1. Summary of Test Result.....	4
2. General Description of EUT	5
3. Test Channels and Modes Detail.....	8
4. Configuration of EUT.....	8
5. Modification of EUT	8
6. Description of Support Device.....	9
7. Test Facility and Location	10
8. Applicable Standards and References.....	11
9. Deviations and Abnormalities from Standard Conditions	11
10. Test Conditions	12
11. Measurement Uncertainty.....	12
12. Sample Calculations	13
13. Test Items and Results	14
13.1 Conducted Emissions Measurement	14
13.2 Maximum Conducted Output Power Measurement.....	18
13.3 6dB Bandwidth Measurement.....	20
13.4 Power Spectral Density Measurement	23
13.5 Band Edge and Conducted Spurious Emissions Measurement.....	26
13.6 Radiated Spurious Emissions and Restricted Bands Measurement.....	30
13.7 Antenna Requirement	37
14. Test Equipment List.....	38

1. Summary of Test Result

FCC Rules	Description of Test	Result	Remarks
§15.207 (a)	AC Power Conducted Emission	PASS	---
§15.247(b)(3)	Maximum Conducted Output Power	PASS	---
§15.247(a)(2)	6dB Bandwidth	PASS	---
§15.247(e)	Power Spectral Density	PASS	---
§15.247(d)	Band Edge and Conducted Spurious Emissions	PASS	---
§15.247(d), §15.209, §15.205	Radiated Spurious Emissions and Restricted Bands	PASS	---
§15.203	Antenna Requirement	PASS	---

2. General Description of EUT

Product Information	
Product name:	Paperang Printer
Main Model Name:	A4N7
Additional Model Name:	A4A7, A4B7, A4C7, A4S7, A4X7, A4W7, A4Y7, A4Z7
Model Difference:	These models have the same circuit schematic, construction, PCB Layout and critical components. Their difference is model number due to trading purpose.
S/N:	2206-2480
Brand Name:	PAPERANG
Hardware version:	Not stated
Software version:	Not stated
Rating:	DC 5V 2A from type-c port or DC 7.4V from internal battery
Classification:	Class B
Typical arrangement:	Table-top
I/O Port:	Refer to the user manual
Accessories Information	
Adapter:	N/A
Cable:	USB line: 0.51m, unshielded, detachable
Other:	N/A
Additional Information	
Note:	According to the model difference, all tests were performed on model A4N7.
Remark:	All the information above are provided by the manufacturer. More detailed feature of the EUT please refers to the user manual.

Technical Specification (BLE)	
Bluetooth Version:	V5.2
Frequency Range:	2402-2480MHz
Modulation Type:	GFSK
Number of Channel:	40 (refer to following channel list for details)
Channel Space:	2MHz
Antenna Type:	PCB Antenna
Antenna Gain:	-4.73 dBi (Declared by the manufacturer)
RF PHY Support:	1Mbps
Note: This report only replies to BLE feature of the EUT.	

Channel List					
Channel	Frequency (MHz)	Channel	Frequency (MHz)	Channel	Frequency (MHz)
0	2402	14	2430	28	2458
1	2404	15	2432	29	2460
2	2406	16	2434	30	2462
3	2408	17	2436	31	2464
4	2410	18	2438	32	2466
5	2412	19	2440	33	2468
6	2414	20	2442	34	2470
7	2416	21	2444	35	2472
8	2418	22	2446	36	2474
9	2420	23	2448	37	2476
10	2422	24	2450	38	2478
11	2424	25	2452	39	2480
12	2426	26	2454	-	-
13	2428	27	2456	-	-

3. Test Channels and Modes Detail

Mode		Channel		Frequency (MHz)	Modulation	RF PHY (Mbps)
1	TX	Low	0	2402	GFSK	1
2		Mid	19	2440	GFSK	1
3		High	39	2480	GFSK	1
4	BT Link	---	---	---	---	---

Note: TX mode means that the EUT was programmed to be in continuously transmitting mode.

4. Configuration of EUT

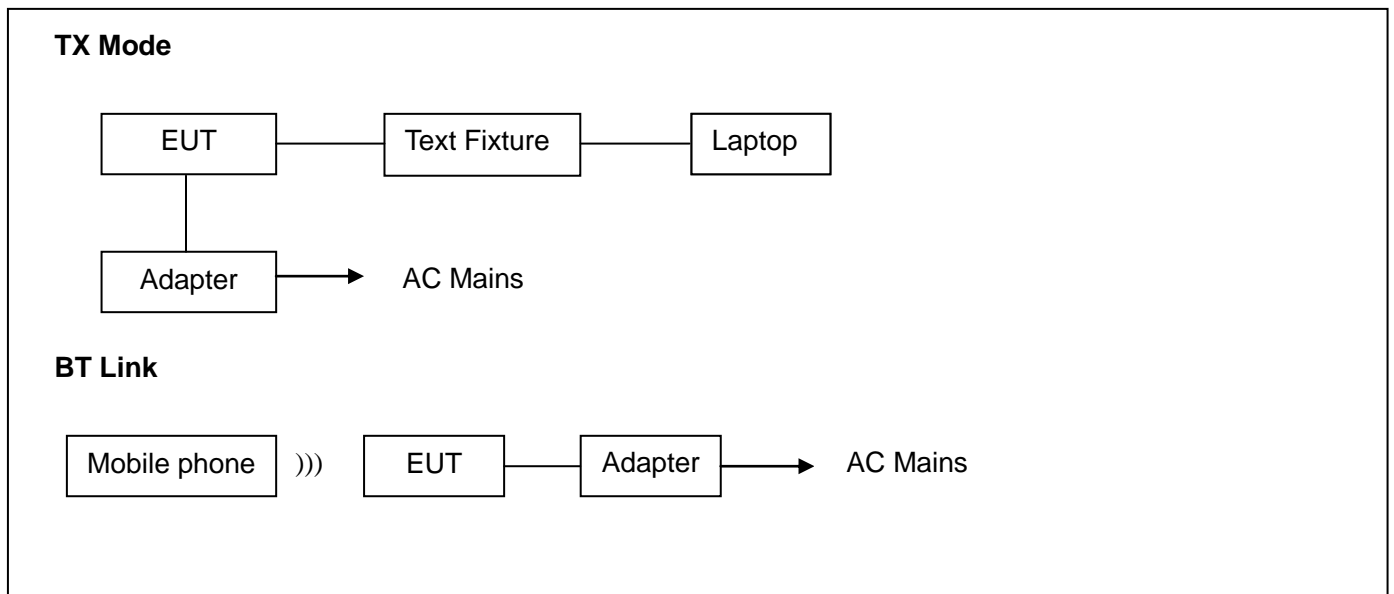

5. Modification of EUT

No modifications are made to the EUT during all test items.

6. Description of Support Device

The EUT has been tested as an independent unit together with other necessary accessories or support units. The following support units or accessories were used to form a representative test configuration during the tests.

No.	Equipment	Brand	M/N	S/N	Cable Specification	Remarks
1.	Laptop	DELL	VOSTR03400	H3K2XA01	Power cord: 1.15m, unshielded	Provide by the Lab
2.	Power supply of the Laptop	DELL	HA45NM140	N/A	---	Provide by the Lab
3.	Test fixture	---	---	---	----	Provide by the Lab
4.	Adapter	HUWEI	HW-050200C0 1	---	----	Provide by the Lab

No.	Test Software	Modulation	Power Setting
1.	BR BlueletSuite_v5.11	GFSK	Default

7. Test Facility and Location

Test Site	:	Dongguan Nore Testing Center Co., Ltd. (Dongguan NTC Co., Ltd.)
Accreditations and Authorizations	:	<p>The Laboratory has been assessed and proved to be in compliance with CNAS/CL01</p> <p>Listed by CNAS, August 13, 2018</p> <p>The Certificate Registration Number is L5795.</p> <p>The Certificate is valid until August 13, 2024</p> <p>The Laboratory has been assessed and proved to be in compliance with ISO17025</p> <p>Listed by A2LA, November 01, 2017</p> <p>The Certificate Registration Number is 4429.01</p> <p>The Certificate is valid until December 31, 2023</p> <p>Listed by FCC, November 06, 2017</p> <p>Test Firm Registration Number: 907417</p> <p>Listed by Industry Canada, June 08, 2017</p> <p>The Certificate Registration Number. Is 46405-9743A</p>
Test Site Location	:	Building D, Gaosheng Science and Technology Park, Hongtu Road, Nancheng District, Dongguan City, Guangdong Province, China

8. Applicable Standards and References

According to the specifications of the manufacturer, the EUT must comply with the requirements of the following standards:

Test Standards:

47 CFR Part 15, Subpart C, 15.247

ANSI C63.10-2013

References Test Guidance:

DTS KDB 558074 D01 15.247 Meas Guidance v05r02

Remark:

The EUT has also been tested and complied with the requirements of FCC Part 15, Subpart B, recorded in a separate test report.

9. Deviations and Abnormalities from Standard Conditions

No additions, deviations and exclusions from the standard.

10. Test Conditions

No.	Test Item	Test Mode	Test Voltage	Tested by	Remarks
1.	AC Power Conducted Emission	4	AC 120V 60Hz	Sean	See note 1
2.	Max. Conducted Output Power	1-3	AC 120V 60Hz	Sean	See note 1
3.	6dB Bandwidth	1-3	AC 120V 60Hz	Sean	See note 1
4.	Power Spectral Density	1-3	AC 120V 60Hz	Sean	See note 1
5.	Band Edge and Conducted Spurious Emissions	1-3	AC 120V 60Hz	Sean	See note 1
6.	Radiated Spurious Emissions and Restricted Bands	1-4	DC 7.4V AC 120V 60Hz	Sean	See note 1
7..	Antenna Requirement	---	---	---	---

Note:

- The testing climatic conditions for temperature, humidity, and atmospheric pressure are within: 15~35°C, 30~70%, 86~106kPa
- AC 120V 60Hz is come from the adapter.

11. Measurement Uncertainty

No.	Test Item	Frequency	Uncertainty	Remarks
1.	Conducted Emission	150KHz ~ 30MHz	±3.04 dB	---
2.	Radiated Emission Test	9kHz ~ 30MHz	±5.04 dB	---
		30MHz ~ 1GHz	±5.04 dB	---
		1GHz ~ 18GHz	±5.23 dB	---
		18GHz ~ 40GHz	±5.23 dB	---
3.	RF Conducted Test	10Hz ~ 40GHz	±0.78 dB	---

Note:

- This uncertainty represents an expanded uncertainty expressed at approximately the 95% confidence level using a coverage factor of k=2.
- The measurement uncertainty levels above are estimated and calculated according to CISPR 16-4-2.
- The conformity assessment statement in this report is based solely on the test results, measurement uncertainty is excluded.

12. Sample Calculations

Conducted Emission						
Freq. (MHz)	Reading Level (dBuV)	Correct Factor (dB)	Measurement (dBuV)	Limit (dBuV)	Over (dB)	Detector
4.1900	30.10	10.60	40.70	56.00	-15.30	QP

Where,

Freq. = Emission frequency in MHz
 Reading Level = Spectrum Analyzer/Receiver reading
 Corrector Factor = Insertion loss of LISN + Cable Loss + RF Switching Unit attenuation
 Measurement = Reading + Corrector Factor
 Limit = Limit stated in standard
 Margin = Measurement - Limit
 Detector = Reading for Quasi-Peak / Average / Peak

Radiated Spurious Emissions and Restricted Bands						
Freq. (MHz)	Reading Level (dBuV)	Correct Factor (dB/m)	Measurement (dBuV/m)	Limit (dBuV/m)	Over (dB)	Detector
233.0700	45.88	-18.38	27.50	46.00	-18.50	QP

Where,

Freq. = Emission frequency in MHz
 Reading Level = Spectrum Analyzer/Receiver reading
 Corrector Factor = Antenna Factor + Cable Loss - Pre-amplifier
 Measurement = Reading + Corrector Factor
 Limit = Limit stated in standard
 Over = Margin, which calculated by Measurement - Limit
 Detector = Reading for Quasi-Peak / Average / Peak

Note: For all conducted test items, the spectrum analyzer offset or transducer is derived from RF cable loss and attenuator factor. The offset or transducer is equal to the RF cable loss plus attenuator factor.

13. Test Items and Results

13.1 Conducted Emissions Measurement

LIMIT

According to the requirements of FCC PART 15.207, the limits are as follows:

Frequency (MHz)	Quasi-peak	Average
0.15 to 0.5	66 to 56	56 to 46
0.5 to 5	56	46
5 to 30	60	50

- Note:
1. If the limits for the average detector are met when using the quasi-peak detector, then the limits for the measurements with the average detector are considered to be met.
 2. The lower limit shall apply at the transition frequencies.
 3. The limit decreases linearly with the logarithm of the frequency in the range 0.15 MHz to 0.5MHz.

BLOCK DIAGRAM OF TEST SETUP

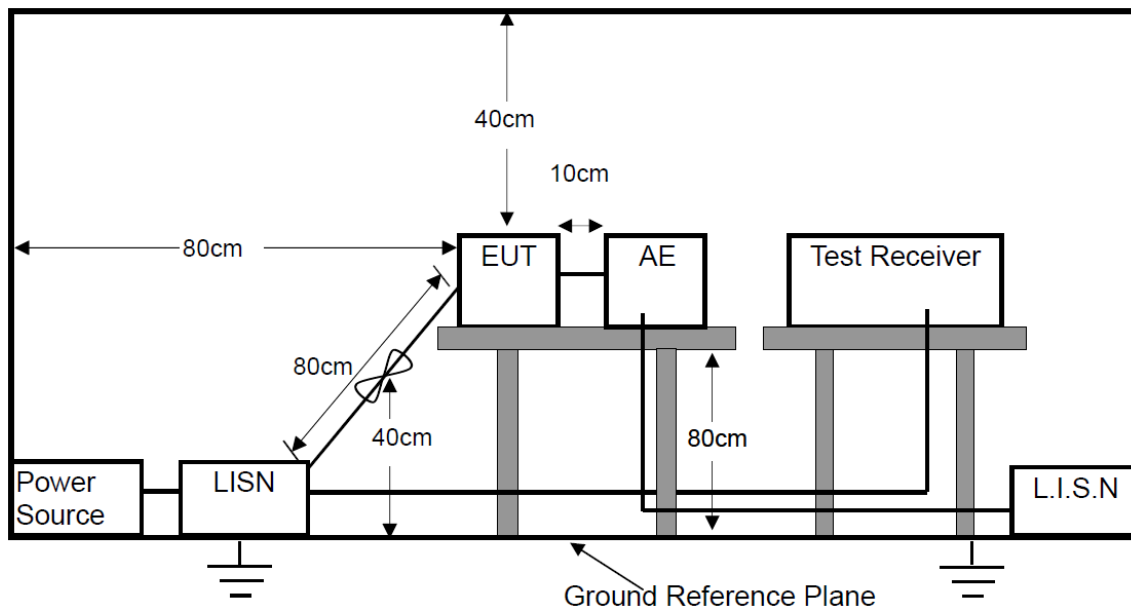

TEST PROCEDURES

- a. The EUT was placed on a wooden table 0.8m height from the metal ground plan and 0.4m from the conducting wall of the shielding room and it was kept at 0.8m from any other grounded conducting surface.
- b. All I/O cables and support devices were positioned as per ANSI C63.10.
- c. Connect mains power port of the EUT to a line impedance stabilization network (LISN).
- d. Connect all support devices to the other LISN and AAN, if needed.
- e. Scan the frequency range from 150KHz to 30MHz at both sides of AC line for maximum conducted interference checking and record the test data.

TEST RESULTS

PASS

Please refer to the following pages.

M/N: A4N7	Testing Voltage: AC 120V 60Hz
Phase: L1	Detector: QP & AVG
Test Mode: 4	

Conducted Emission Measurement

Date: 2022/6/9

Time: 10:02:04

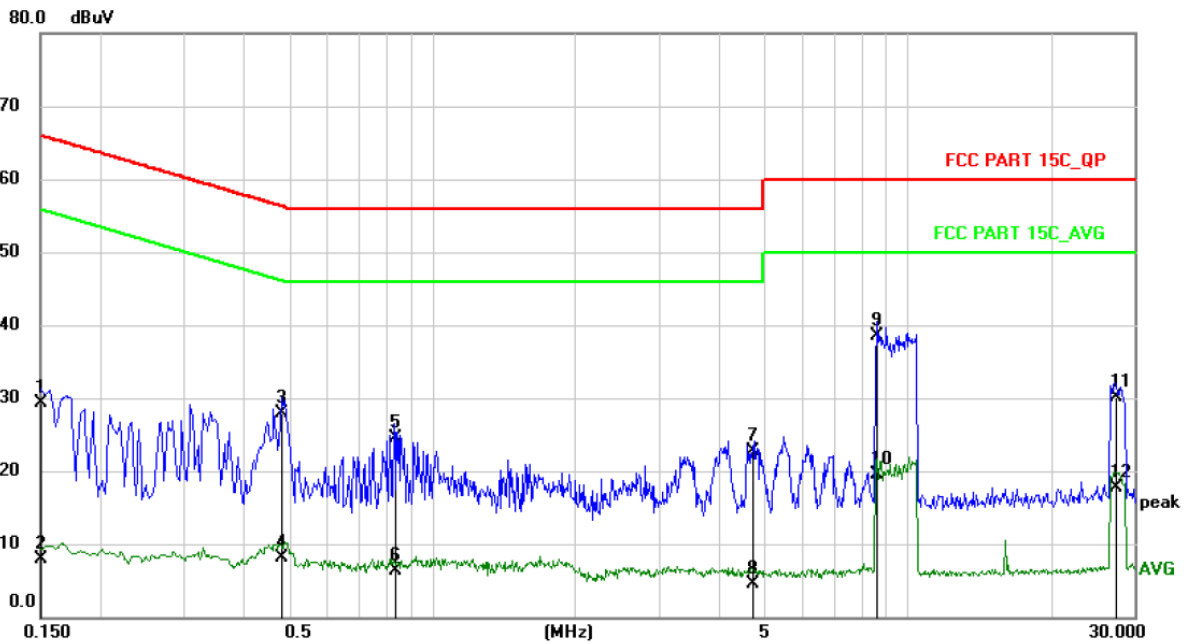

No. Mk.	Freq.	Reading Level	Correct Factor	Measurement	Limit	Over	Detector	Comment
	MHz	dBuV	dB	dBuV	dBuV	dB		
1	0.1500	18.80	10.60	29.40	66.00	-36.60	QP	
2	0.1500	-2.60	10.60	8.00	56.00	-48.00	AVG	
3	0.4818	17.37	10.63	28.00	56.31	-28.31	QP	
4	0.4818	-2.43	10.63	8.20	46.31	-38.11	AVG	
5	0.8338	13.82	10.68	24.50	56.00	-31.50	QP	
6	0.8338	-4.28	10.68	6.40	46.00	-39.60	AVG	
7	4.7019	11.99	10.71	22.70	56.00	-33.30	QP	
8	4.7019	-6.11	10.71	4.60	46.00	-41.40	AVG	
9 *	8.6059	27.77	10.73	38.50	60.00	-21.50	QP	
10	8.6059	8.87	10.73	19.60	50.00	-30.40	AVG	
11	27.3738	19.31	10.79	30.10	60.00	-29.90	QP	
12	27.3738	7.01	10.79	17.80	50.00	-32.20	AVG	

M/N: A4N7	Testing Voltage: AC 120V 60Hz
Phase: N	Detector: QP & AVG
Test Mode: 4	

Conducted Emission Measurement

Date: 2022/6/9

Time: 10:08:54

80.0 dBuV

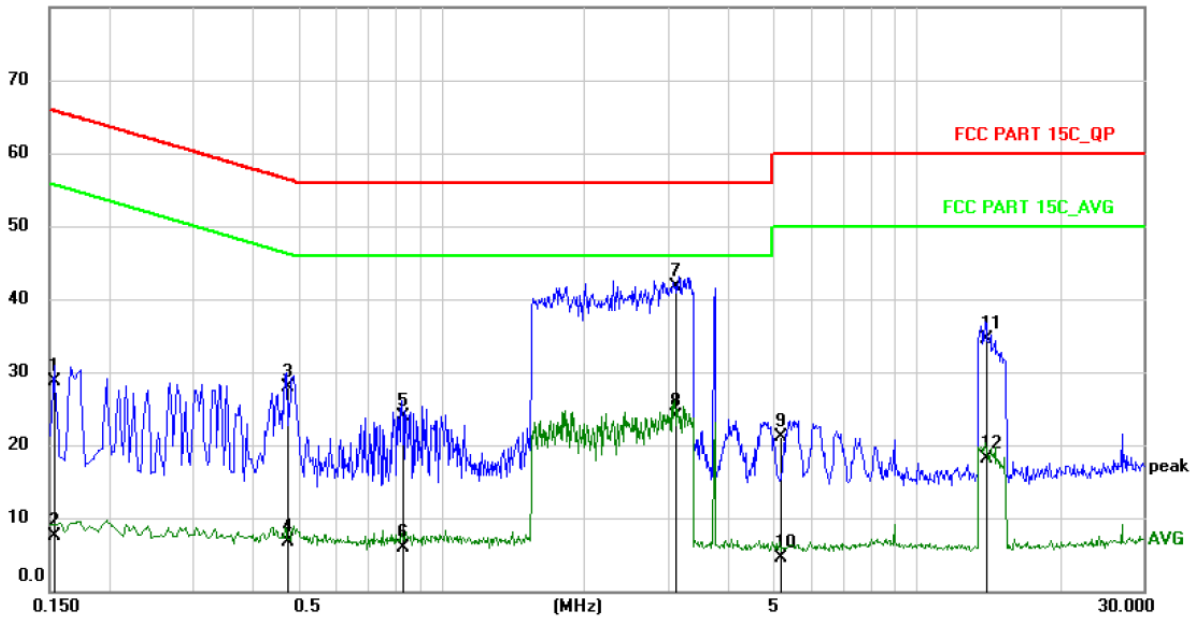

No. Mk.	Freq.	Reading Level	Correct Factor	Measurement	Limit	Over	Detector	Comment
	MHz	dBuV	dB	dBuV	dBuV	dB		
1	0.1539	18.20	10.60	28.80	65.79	-36.99	QP	
2	0.1539	-3.10	10.60	7.50	55.79	-48.29	AVG	
3	0.4739	17.28	10.62	27.90	56.45	-28.55	QP	
4	0.4739	-3.82	10.62	6.80	46.45	-39.65	AVG	
5	0.8300	13.32	10.68	24.00	56.00	-32.00	QP	
6	0.8300	-4.68	10.68	6.00	46.00	-40.00	AVG	
7 *	3.1060	31.09	10.71	41.80	56.00	-14.20	QP	
8	3.1060	13.29	10.71	24.00	46.00	-22.00	AVG	
9	5.1418	10.49	10.71	21.20	60.00	-38.80	QP	
10	5.1418	-6.11	10.71	4.60	50.00	-45.40	AVG	
11	13.9219	23.86	10.74	34.60	60.00	-25.40	QP	
12	13.9219	7.46	10.74	18.20	50.00	-31.80	AVG	

13.2 Maximum Conducted Output Power Measurement

LIMIT

For system using digital modulation in the 2400-2483.5 MHz bands, the limit for peak output power is 1 Watt.

If the transmitting antenna of directional gain greater than 6dBi are used the peak output power from the intentional radiator shall be reduced below the above stated value by the amount in dB that the directional gain of the Antenna exceeds 6dBi.

In case of point-to-point operation, the limit has to be reduced by 1dB for every 3dB that the directional gain of Antenna exceeds 6dBi.

BLOCK DIAGRAM OF TEST SETUP

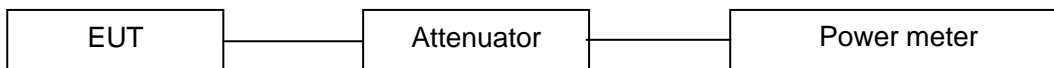

TEST PROCEDURES

ANSI C63.10 - 2013, Section 11.9.1.3

ANSI C63.10 - 2013, Section 11.9.2.3.2

TEST RESULTS

PASS

Please refer to the following table.

GFSK					
Channel	Frequency (MHz)	RF PHY (Mbps)	Peak Output Power (dBm)	Limit (dBm)	Result
0	2402	1	-0.738	≤30	PASS
19	2440	1	-0.660	≤30	PASS
39	2480	1	-0.535	≤30	PASS

13.3 6dB Bandwidth Measurement

LIMIT

The minimum 6dB bandwidth shall be at least 500 kHz

BLOCK DIAGRAM OF TEST SETUP

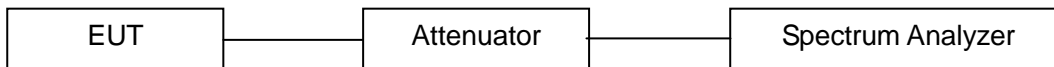

TEST PROCEDURES

The antenna port of the EUT was connected to the input of a spectrum analyzer. Analyzer was set as below according to FCC KDB558074 (v05r02):

- a. Set the RBW = 100KHz.
- b. Set the VBW $\geq 3 \times$ RBW
- c. Set the Detector = peak.
- d. Set the Sweep time = auto couple.
- e. Set the Trace mode = max hold.
- f. Allow trace to fully stabilize.
- g. Measure the maximum width of the emission that is constrained by the frequencies associated with the two outermost amplitude points (upper and lower frequencies) that are attenuated by 6 dB relative to the maximum level measured in the fundamental emission.

TEST RESULTS

PASS

Please refer to the following table.

GFSK						
Channel	Frequency (MHz)	RF PHY (Mbps)	6dB Bandwidth (MHz)	99% Bandwidth (MHz)	6dB Limit (MHz)	Result
0	2402	1	0.714	---	>0.5	PASS
19	2440	1	0.706	---	>0.5	PASS
39	2480	1	0.714	---	>0.5	PASS

Test Plots of 6dB Bandwidth (GFSK:1M)

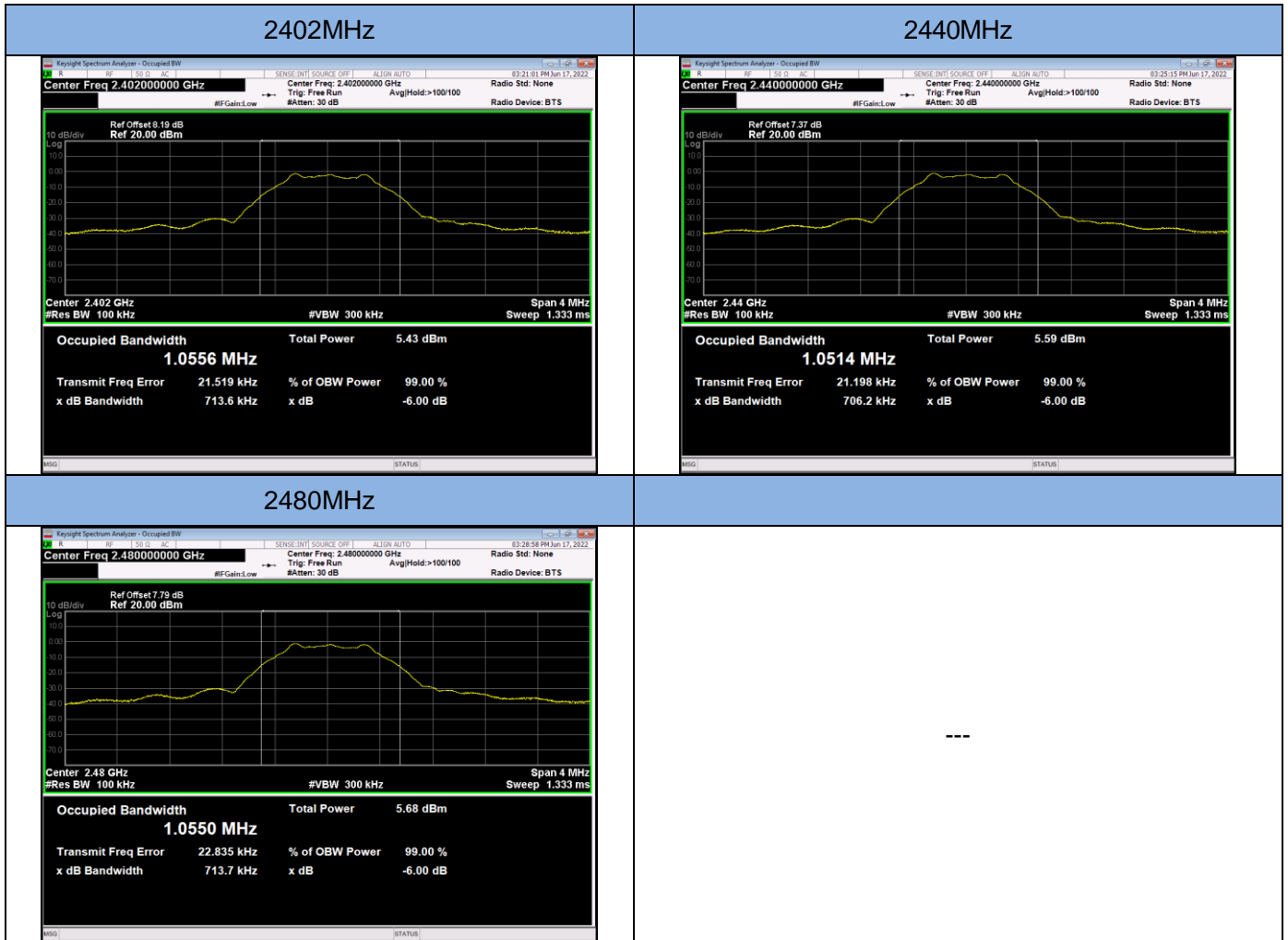

13.4 Power Spectral Density Measurement

LIMIT

The Maximum of Power Spectral Density Measurement is 8dBm in any 3 kHz.

BLOCK DIAGRAM OF TEST SETUP

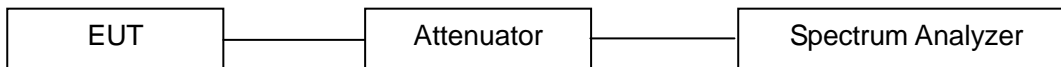

TEST PROCEDURES

The antenna port of the EUT was connected to the input of a spectrum analyzer. Analyzer was set as below according to FCC KDB558074 (v05r02):

- a. Set analyzer center frequency to DTS channel center frequency.
- b. Set the span to 1.5 times the DTS bandwidth.
- c. Set the RBW to: $3 \text{ kHz} \leq \text{RBW} \leq 100\text{KHz}$
- d. Set the VBW $\geq 3 \times \text{RBW}$.
- e. Set the Detector = peak.
- f. Set the Sweep time = auto couple.
- g. Set the Trace mode = max hold.
- h. Allow trace to fully stabilize.
- i. Use the peak marker function to determine the maximum amplitude level within the RBW.
- j. If measured value exceeds limit, reduce RBW (no less than 3 kHz) and repeat.

TEST RESULTS

PASS

Please refer to the following table.

GFSK					
Channel	Frequency (MHz)	RF PHY (Mbps)	PSD dBm / 3kHz	Limit dBm / 3kHz	Results
0	2402	1	-15.894	8	PASS
19	2440	1	-15.785	8	PASS
39	2480	1	-15.634	8	PASS

Test Plots of Power Spectral Density (1M)

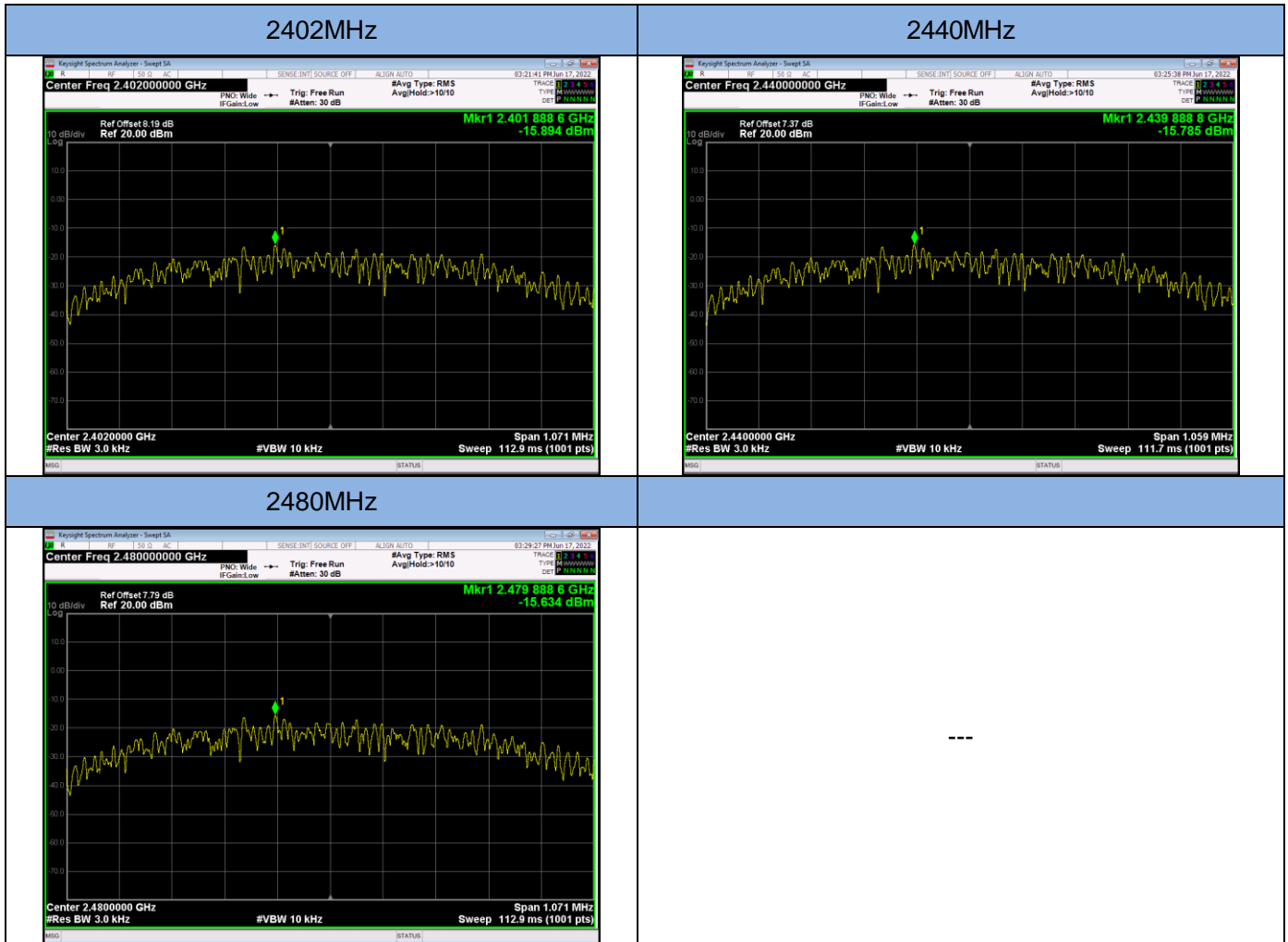

13.5 Band Edge and Conducted Spurious Emissions Measurement

LIMIT

In any 100KHz bandwidth outside the frequency band in which the spread spectrum intentional radiator is operating, the radio frequency power that is produced by the intentional radiator shall be at least 20dB below that in the 100KHz bandwidth within the band that contains the highest level of the desired power, based on either an RF conducted or a radiated measurement.

BLOCK DIAGRAM OF TEST SETUP

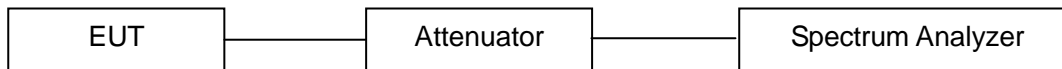

TEST PROCEDURES

The antenna port of the EUT was connected to the input of a spectrum analyzer. Analyzer was set as below according to ANSI C63.10-2013, Section 11.11

Measurement Procedure REF

- a. Set the RBW = 100 kHz.
- b. Set the VBW \geq 300 kHz.
- c. Set the Detector = peak.
- d. Set the Sweep time = auto couple.
- e. Trace mode = max hold.
- f. Allow trace to fully stabilize.
- g. Use the peak marker function to determine the maximum power level in any 100 kHz band segment within the fundamental EBW.

Measurement Procedure OOB

- a. Set RBW = 100 kHz.
- b. Set VBW \geq 300 kHz.
- c. Set the Detector = peak.
- d. Set the Sweep = auto couple.
- e. Set the Trace Mode = max hold.
- f. Allow trace to fully stabilize.
- g. Use the peak marker function to determine the maximum amplitude level.

TEST RESULTS

PASS

Please refer to the following test plots.

Band Edge (GFSK: 1M)

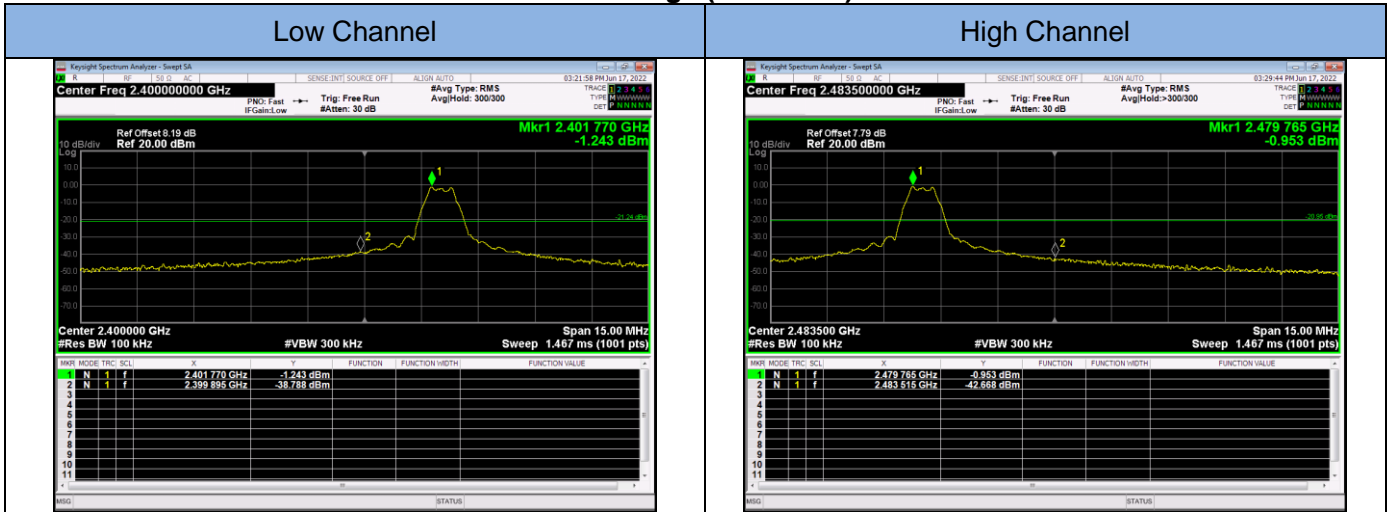

Conducted Spurious Emissions (GFSK: 1Mbps)

Low Channel / 30MHz~26.5GHz

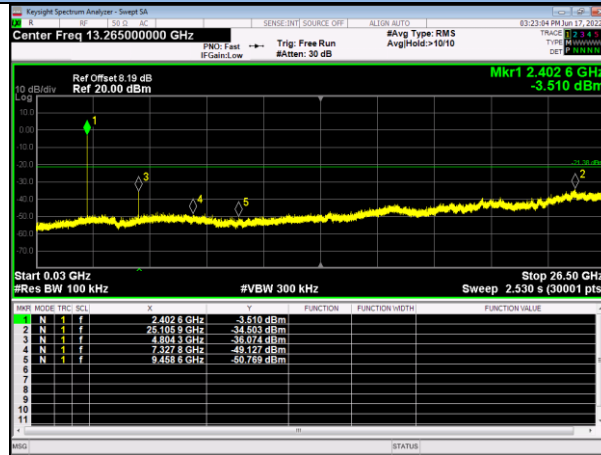

Mid Channel / 30MHz~26.5GHz

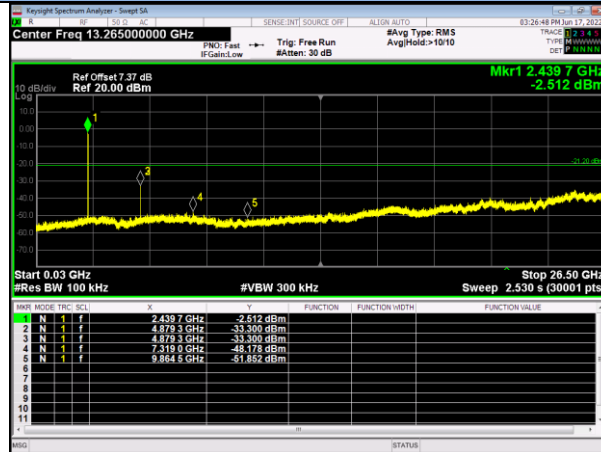

High Channel / 30MHz~26.5GHz

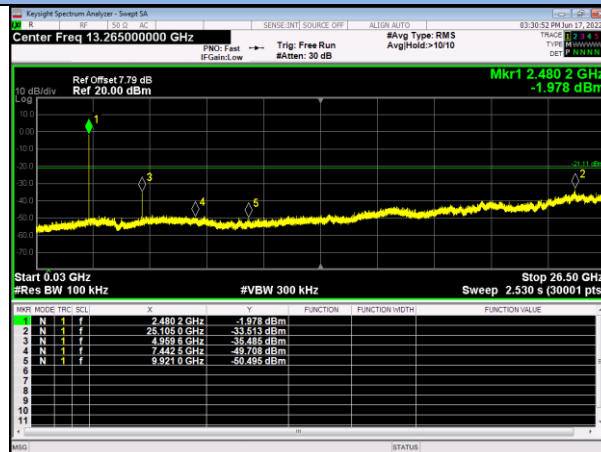

13.6 Radiated Spurious Emissions and Restricted Bands Measurement

LIMIT

Frequency range MHz	Distance Meters	Field Strengths Limit (15.209)
		$\mu\text{V/m}$
0.009 ~ 0.490	300	2400/F(kHz)
0.490 ~ 1.705	30	24000/F(kHz)
1.705 ~ 30	30	30
30 ~ 88	3	100
88 ~ 216	3	150
216 ~ 960	3	200
Above 960	3	500

- Remark:
- (1) Emission level (dB) μV = 20 log Emission level $\mu\text{V/m}$
 - (2) The smaller limit shall apply at the cross point between two frequency bands.
 - (3) As shown in 15.35(b), for frequencies above 1000MHz, the field strength limits are based on average detector, however, the peak field strength of any emission shall not exceed the maximum permitted average limits, specified above by more than 20dB under any condition of modulation.
 - (4) The frequency range scanned is from the lowest radio frequency signal generated in the device which is greater than 9 kHz to the tenth harmonic of the highest fundamental frequency or 40 GHz, whichever is lower.
 - (5) §15.247(d) specifies that emissions which fall in the restricted bands, as defined in §15.205 comply with radiated emission limits specified in §15.209.

BLOCK DIAGRAM OF TEST SETUP

For Radiated Emission below 30MHz

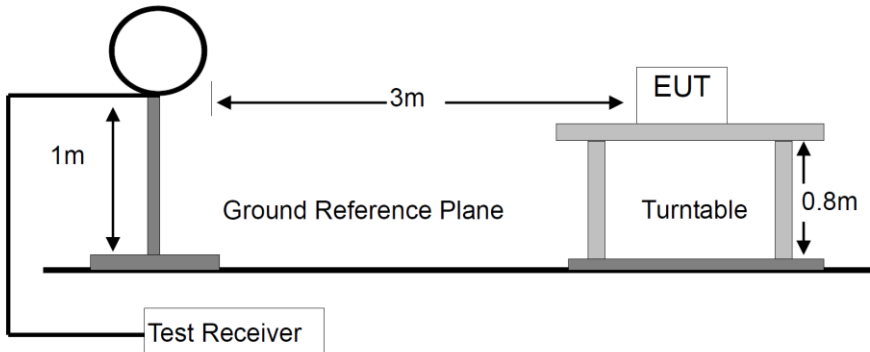

For Radiated Emission 30-1000MHz

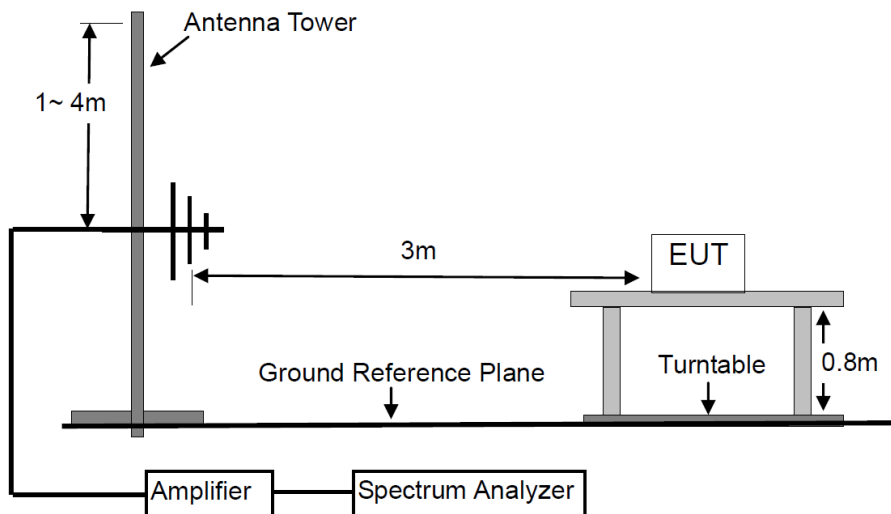

For Radiated Emission Above 1000MHz.

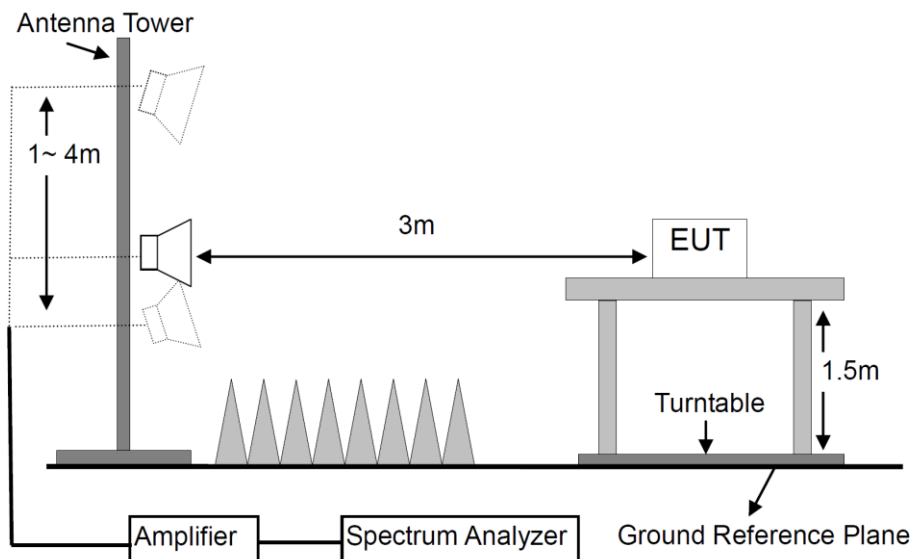

TEST PROCEDURES

- a. Below 1GHz, the EUT was placed on the top of a rotating table 0.8 meters above the ground at a 3 meter semi- anechoic chamber room.
- b. For the radiated emission test above 1GHz:
The EUT was placed on the top of a rotating table 1.5 meters above the ground at a 3 meter full anechoic chamber room. The table was rotated 360 degrees to determine the position of the highest radiation. Place the measurement antenna away from each area of the EUT determined to be a source of emissions at the specified measurement distance, while keeping the measurement antenna aimed at the source of emissions at each frequency of significant emissions, with polarization oriented for maximum response. The measurement antenna may have to be higher or lower than the EUT, depending on the radiation pattern of the emission and staying aimed at the emission source for receiving the maximum signal. The final measurement antenna elevation shall be that which maximizes the emissions. The measurement antenna elevation for maximum emissions shall be restricted to a range of heights of from 1 m to 4 m above the ground or reference ground plane.
- c. The EUT was set 3 meters away from the interference-receiving antenna, which was mounted on the top of a variable-height antenna tower.
- d. The height of antenna is varied from one meter to four meters above the ground to determine the maximum value of the field strength. Both horizontal and vertical polarizations of the antenna are set to make the measurement.
- e. For each suspected emission, the EUT was arranged to its worst case and then the antenna was tuned to heights from 1 meter to 4 meters and the rotatable table was turned from 0 degrees to 360 degrees to find the maximum reading. The test-receiver system was set to peak detect function and specified bandwidth with maximum hold mode.
- f. A Quasi-peak measurement was then made for that frequency point for below 1GHz test. PK and AV for above 1GHz emission test.
- g. Pre-Scan has been conducted to determine the worst-case mode from all possible combinations between available modulations, data rates, XYZ axis and packet type.
The worst case was found when the EUT was positioned on X axis for radiated emission.

During the radiated emission test, the spectrum analyzer was set with the following configurations:

Frequency Band (MHz)	Detector	Resolution Bandwidth	Video Bandwidth
30 to 1000	QP	120 kHz	300 kHz
Above 1000	Peak	1 MHz	3 MHz
	Average	1 MHz	10 Hz

TEST RESULTS

PASS

Please refer to the following pages.

M/N: A4N7	Testing Voltage: AC 120V 60Hz
Polarization: Horizontal	Detector: QP
Test Mode: 4 (GFSK 1M)	Distance: 3m

Radiated Emission Measurement

Date: 2022/6/16

Time: 13:41:27

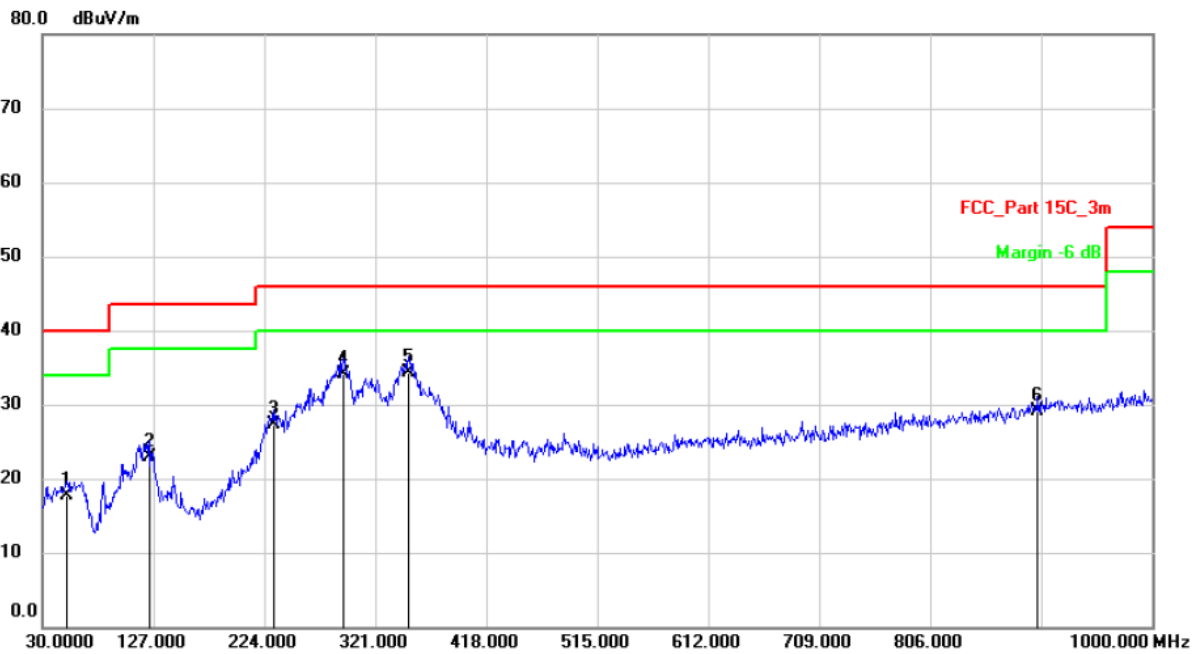

No.	Mk.	Freq.	Reading Level	Correct Factor	Measurement	Limit	Over	Detector	Comment
		MHz	dBuV	dB/m	dBuV/m	dBuV/m	dB		
1		51.3400	24.75	-7.05	17.70	40.00	-22.30	QP	
2		123.1200	32.78	-9.78	23.00	43.50	-20.50	QP	
3		231.7600	34.30	-6.90	27.40	46.00	-18.60	QP	
4		292.8700	39.87	-5.67	34.20	46.00	-11.80	QP	
5	*	350.1000	38.45	-4.15	34.30	46.00	-11.70	QP	
6		900.0900	22.90	6.20	29.10	46.00	-16.90	QP	

Note: Below 30MHz, the emissions are lower than 20dB below the allowable limit.

M/N: A4N7	Testing Voltage: AC 120V 60Hz
Polarization: Vertical	Detector: QP
Test Mode: 4 (GFSK 1M)	Distance: 3m

Radiated Emission Measurement

Date: 2022/6/16

Time: 13:48:25

80.0 dBuV/m

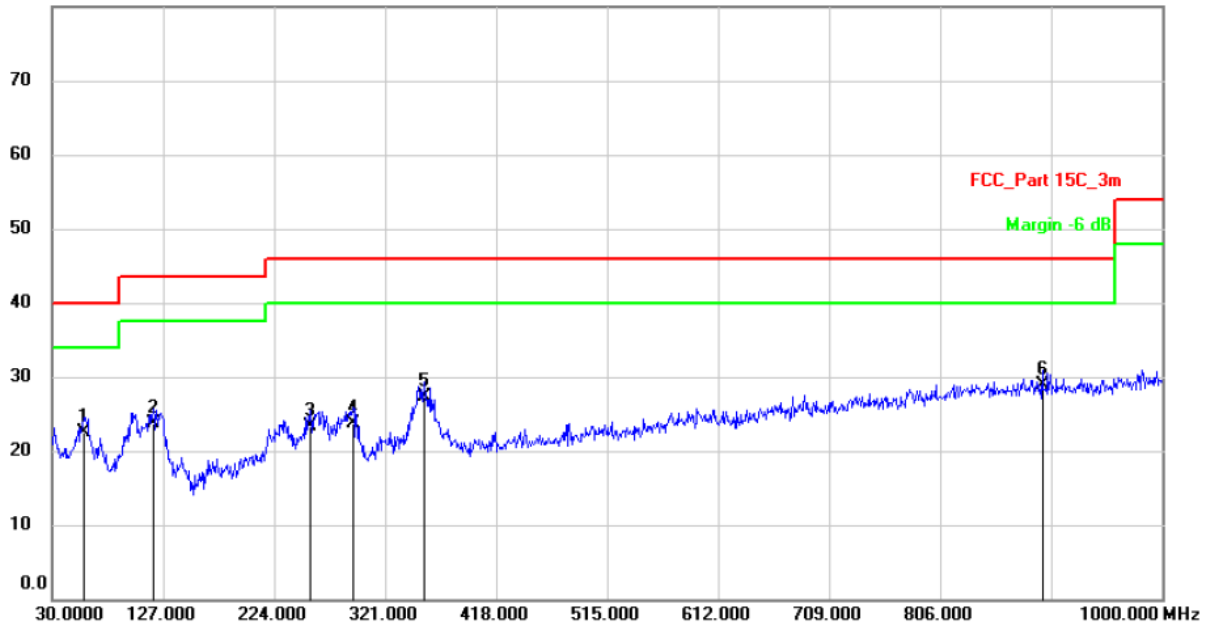

No.	Mk.	Freq.	Reading Level	Correct Factor	Measurement	Limit	Over	Detector	Comment
		MHz	dBuV	dB/m	dBuV/m	dBuV/m	dB		
1		57.1600	30.18	-7.68	22.50	40.00	-17.50	QP	
2		118.2700	34.70	-11.00	23.70	43.50	-19.80	QP	
3		256.0100	30.64	-7.24	23.40	46.00	-22.60	QP	
4		292.8700	30.47	-6.67	23.80	46.00	-22.20	QP	
5		354.9500	32.48	-5.08	27.40	46.00	-18.60	QP	
6	*	895.2400	23.94	4.96	28.90	46.00	-17.10	QP	

Note: Below 30MHz, the emissions are lower than 20dB below the allowable limit.

Modulation: GFSK (1M)					Test Result: PASS		Test frequency range: 1-25GHz			
Freq. (MHz)	Ant. Pol. (H/V)	Reading Level(dBuV)		Factor (dB/m)	Emission Level (dBuV/m)		Limit 3m (dBuV/m)		Margin (dB)	
		PK	AV		PK	AV	PK	AV	PK	AV
Operation Mode: TX Mode (Low)										
4804	H	57.07	43.73	6.30	63.37	50.03	74.00	54.00	-10.63	-3.97
7206	H	48.95	35.87	10.44	59.39	46.31	74.00	54.00	-14.61	-7.69

4804	V	55.36	42.52	6.30	61.66	48.82	74.00	54.00	-12.34	-5.18
7206	V	46.33	32.90	10.44	56.77	43.34	74.00	54.00	-17.23	-10.66

Operation Mode: TX Mode (Mid)										
4880	H	58.40	44.40	6.60	65.00	51.00	74.00	54.00	-9.00	-3.00
7320	H	49.30	36.82	10.55	59.85	47.37	74.00	54.00	-14.15	-6.63

4880	V	57.64	43.79	6.60	64.24	50.39	74.00	54.00	-9.76	-3.61
7320	V	47.04	34.55	10.55	57.59	45.10	74.00	54.00	-16.41	-8.90

Operation Mode: TX Mode (High)										
4960	H	57.19	42.43	6.89	64.08	49.32	74.00	54.00	-9.92	-4.68
7440	H	47.05	33.54	10.60	57.65	44.14	74.00	54.00	-16.35	-9.86

4960	V	55.24	42.12	6.89	62.13	49.01	74.00	54.00	-11.87	-4.99
7440	V	45.98	32.99	10.60	56.58	43.59	74.00	54.00	-17.42	-10.41

Spurious Emission in restricted band:										
2398.000	H	64.46	31.37	0.13	64.59	31.50	74.00	54.00	-9.41	-22.50
2398.000	V	53.32	31.57	0.13	53.45	31.70	74.00	54.00	-20.55	-22.30
2483.500	H	65.68	31.93	0.34	66.02	32.27	74.00	54.00	-7.98	-21.73
2483.500	V	60.73	32.26	0.34	61.07	32.60	74.00	54.00	-12.93	-21.40
Remark: Data of measurement within this frequency range shown "---" in the table above means the reading of emissions are attenuated more than 20dB below the permissible limits.										

13.7 Antenna Requirement

STANDARD APPLICABLE

According to of FCC part 15C section 15.203 and 15.247:

An intentional radiator shall be designed to ensure that no antenna other than that furnished by the responsible party shall be used with the device. The use of a permanently attached antenna or of an antenna that uses a unique coupling to the intentional radiator, the manufacturer may design the unit so that a broken antenna can be replaced by the user, but the use of a standard antenna jack or electrical connector is prohibited.

Systems operating in the 2400-2483.5MHz band that are used exclusively for fixed, point-to-point operations may employ transmitting antennas with directional gain greater than 6dBi provided the maximum peak output power of the intentional radiator is reduced by 1dB for every 3dB that the directional gain of the antenna exceeds 6dBi.

ANTENNA CONNECTED CONSTRUCTION

The antenna is PCB antenna that no antenna other than furnished by the responsible party shall be used with the device, and the best case gain of the antenna is -4.73 dBi, Therefore, the antenna is consider meet the requirement.

14. Test Equipment List

Item	Equipment	Manufacturer	Model No.	Serial No.	Last Cal.	Cal. Interval
1.	Test Receiver	Rohde & Schwarz	ESCI7	100837	Mar. 13, 2022	1 Year
2.	Antenna	Schwarzbeck	VULB9162	9162-010	Mar. 23, 2022	2 Year
3.	Spectrum Analyzer	Rohde & Schwarz	FSU26	200409/026	Mar. 13, 2022	1 Year
4.	Spectrum Analyzer	Keysight	N9020A	MY54200831	Mar. 13, 2022	1 Year
5.	Spectrum Analyzer	Rohde & Schwarz	FSV40	101094	Mar. 13, 2022	1 Year
6.	Horn Antenna	Schwarzbeck	BBHA9170	9170-172	Mar. 23, 2022	2 Year
7.	Power Sensor	DARE	RPR3006W	15I00041SNO 64	Mar. 13, 2022	1 Year
8.	Communication Tester	Rohde & Schwarz	CMW500	149004	Mar. 13, 2022	1 Year
9.	Horn Antenna	COM-Power	AH-118	071078	Mar. 23, 2022	2 Year
10.	Pre-Amplifier	HP	HP 8449B	3008A00964	Mar. 13, 2022	1 Year
11.	Pre-Amplifier	HP	HP 8447D	1145A00203	Mar. 13, 2022	1 Year
12.	Loop Antenna	Schwarzbeck	FMZB 1513	1513-272	Mar. 23, 2022	2 Year
13.	Test Receiver	Rohde & Schwarz	ESCI	101152	Mar. 13, 2022	1 Year
14.	L.I.S.N	Rohde & Schwarz	ENV 216	101317	Mar. 13, 2022	1 Year
15.	L.I.S.N	Rohde & Schwarz	ESH2-Z5	893606/014	Mar. 13, 2022	1 Year
16.	RF Switching Unit	Compliance Direction Systems Inc.	RSU-M2	38311	Mar. 13, 2022	1 Year
17.	Temperature & Humidity Chamber	REMAFEE	SYHR225L	N/A	Mar. 13, 2022	1 Year
18.	DC Source	Maynuo	MY8811	N/A	Mar. 13, 2022	1 Year
19.	Temporary antenna connector	TESCOM	SS402	N/A	N/A	N/A
20.	Chamber	SAEMC	9*7*7m	N/A	Apr. 21, 2021	2 Year
21.	Test Software	EZ	EZ_EMCC	N/A	N/A	N/A

Note: For photographs of EUT and measurement, please refer to appendix in separate documents.

---End---