

Gigabit Business IP Phone

Z 22G

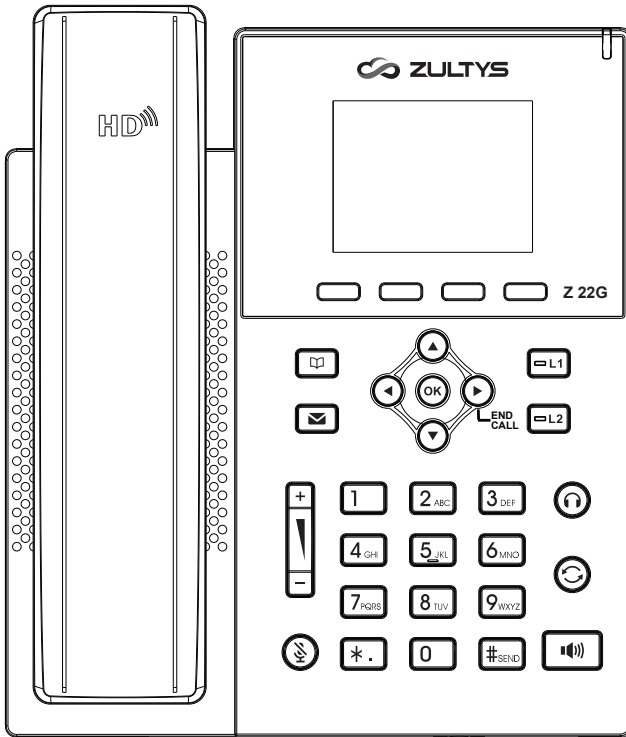

Quick Start Guide

Package Contents

The following items are included in your package. If you find anything missing, contact your system administrator.

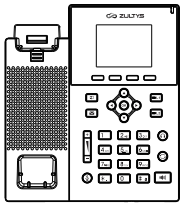

IP Phone

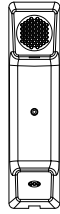

Handset



Handset Cord



Ethernet Cable



Stand



Quick Start Guide



Power Adapter
(Optional)

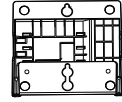

Wall Mount Bracket
(Optional)

Note: We recommend that you use the accessories provided or approved by ZULTYS. The use of unapproved third-party accessories may result in reduced performance or damage.

Assembling the Phone

1. Attach the stand, as shown below:

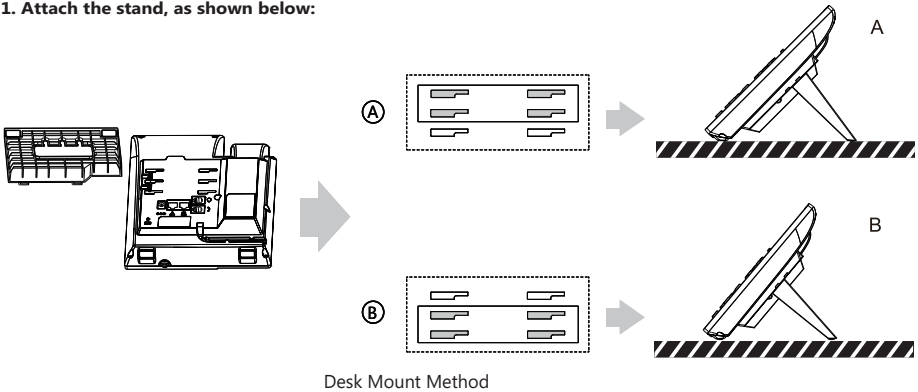

Note: The phone may also be wall mounted using the optional Z 22G wall mount bracket. Refer to wall mount installation guide for additional information.

2. Connect the handset and optional headset, as shown below:

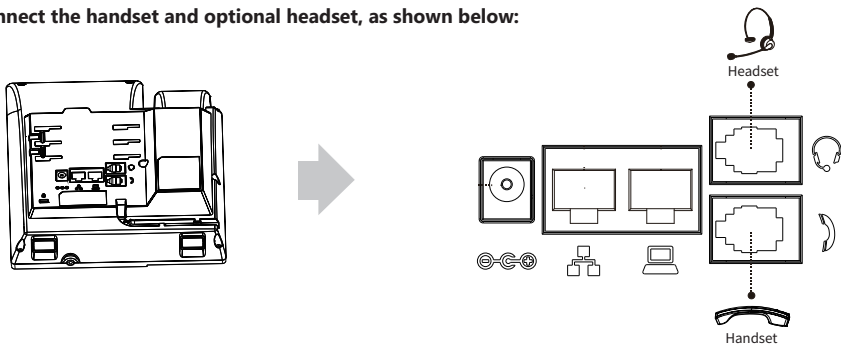

Note: A compatible headset may be purchased separately.

3. Connect the network and power as shown below:



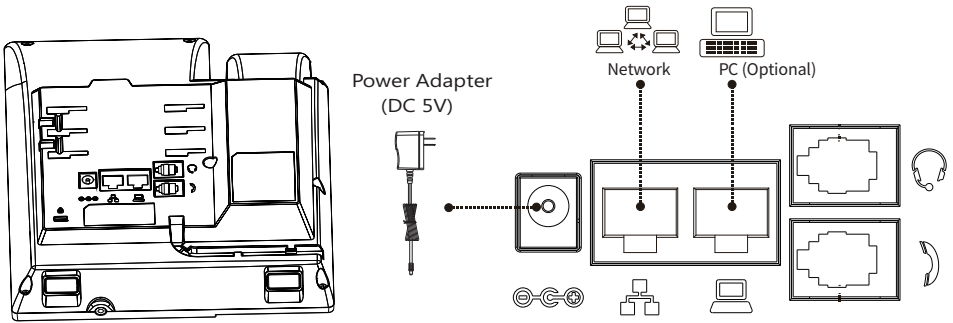















The phone may be powered using the optional Zultys 5V DC power adapter or via Power over Ethernet (PoE). Your system administrator will advise which method to use.



Note: The IP phone should only be used with a ZULTYS 5V DC power adapter. The use of a third-party power adapter may cause damage to the phone. If you are connecting a PC to the Network port of the phone, it is recommended that you use the Ethernet cable provided with the phone.

If inline power (PoE) is provided, you do not need to connect a power adapter. Make sure the switch is PoE-compliant per the IEEE 802.3af standard.

Screen Icons

 In hands-free mode	 Call is on hold	 Missed call(s)	 Network connected
 In headset mode	 Auto-answering activated	 Received call(s)	 Network disconnected
 In handset mode	 Call Forward activated	 Dialed call(s)	 No IP address
 Mute activated	 Do not disturb activated (Red)	 Network Quality Indicator	 VLAN activated
 Ringer off	 New Voicemail Messages	 Keypad locked	

Basic Call Features

Placing a Call

Using the handset:

1. Pick up the handset.
2. Enter the number, and then press the **Dial** soft key or .
--Alternatively-- Enter the number and then lift the handset to initiate the call.

Using the speakerphone:

1. With the handset on-hook, enter the number.
2. Then press  or the **Dial** soft key.

Using the headset:

1. With the headset connected, press  to activate the headset mode.
2. Enter the number, and then press the **Dial** soft key or .

Note: During a call, you can alternate between the headset, hands-free speakerphone and handset modes by pressing the **HEADSET** key, the **Speakerphone** key or by picking up the handset.

Answering a Call

Using the handset:

Pick up the handset.

Using the speakerphone:

Press  or the **Answer** soft key.

Using the headset:

Press  or the **Answer** soft key if headset mode is active.



Note: Reject an incoming call by pressing the **Reject** soft key or silence the ringer by pressing the **Mute** key.

Ending a Call

Using the handset:

Hang up the handset or press the -**End Call** key.





Using the speakerphone:

Press  or press the -**End Call** key.



Using the headset:

Press the -**End Call** key.

Redial

- Press  to enter the **Out Calls** list, press  or  to select the desired entry, and then press  or the **Dial** soft key.
- Press  twice when the phone is idle to dial the last dialed number.

Call Mute and Un-mute



- Press  to mute the microphone during a call.
- Press  again to un-mute the call.

Call Hold and Resume

To place a call on hold:

Press the **Hold** soft key during an active call.

To resume the call, do one of the following:

- If there is only one call on hold, press the **Resume** soft key.
- If there is more than one call on hold, press  or  to select the desired call, and then press the **Resume** soft key.

Call Transfer

You can transfer a call in the following ways:

Blind Transfer

1. Press the **Trans** soft key during an active call. The call is placed on hold.
2. Enter the number you want to transfer to.
3. Press the **Trans** soft key again to complete the transfer.

Semi-Attended Transfer

1. Press the **Trans** soft key during an active call. The call is placed on hold.
2. Enter the number you want to transfer to, and then press .
3. Press the **Trans** soft key when you hear the ring-back tone.

Attended Transfer

1. Press the **Trans** soft key during an active call. The call is placed on hold.
2. Enter the number you want to transfer to, and then press .
3. Press the **Trans** soft key when ready to complete the transfer or the **End** soft key to cancel transfer.

Call Forward

To enable call forward:

1. Press the **Menu** soft key when the phone is idle, and then select **Features->Call Forward**.
2. Select the SIP Line (usually #1) and then the desired forward type:
 - Unconditional**----Incoming calls are forwarded unconditionally.
 - Busy Forward**----Incoming calls are forwarded when the phone is busy.
 - No Answer**----Incoming calls are forwarded if not answered after a period of time.
3. Select 'Enable' and enter the 'Forward to' number. For **No Answer** Forward, enter the 'Time' in seconds to wait before forwarding.
4. Press the **OK** soft or hard key to accept the change.

Note: Advanced 'Call Handling Rules' may be configured from the ZAC unified communications client app.

Call Conference

1. Press the **Conf** soft key during an active call. The call is placed on hold.
2. Enter the number of the second party, and then press the **Dial** soft key or .
3. Press the **Conf** soft key again when the second party answers. All parties are now joined in the conference.
4. Press the **End** soft key to disconnect all parties.

Note: You can split the conference call into two individual calls by pressing the **Split** soft key.

Voice Message



The Message waiting indicator  on the idle screen will indicate when one or more voicemail messages are available and the Message Waiting Indicator LED at the top right of screen will flash red.

To listen to voice messages:

1. Press  key.
2. Follow the voice prompts to listen to your voice messages.

Customizing Your Phone

Call History

1. Press the  key when the phone is idle to access the Call History, press  or  to select an entry.
2. After selecting an entry from the list, you can do the following:
 - Press the **Dial** soft key to call the entry.
 - Press the **Delete** soft key to delete the entry from the list.

If you press the **Option** soft key, you can also do the following:



- Select **Detail** to view detailed information about the entry.
- Select **Add to Contact** to add the entry to the local directory.
- Select **Add to Blacklist** to add the entry to the blacklist.
- Select **Delete All** to delete all entries from the list.

Contact Directory



To add a contact:

1. Press the **Contact** soft key when the phone is idle, and then select **All Contacts**.
2. Press the **Add** soft key to add a contact.
3. Enter a unique contact name in the **Name** field and contact numbers in the corresponding fields.
4. Press the **OK** soft key to accept the change.

To edit a contact:

1. Press the **Contact** soft key when the phone is idle, and then select **All Contacts**.
2. Press  or  to select the desired entry, press the **Option** soft key and then select **Edit**.
3. Edit the contact information.
4. Press the **OK** soft key to accept the change.

To delete a contact:

1. Press the **Contact** soft key when the phone is idle, and then select **All Contacts**.
2. Press  or  to select the desired entry, press the **Option** soft key and then select **Delete**.
3. Press the **OK** soft key when the LCD screen prompts "Delete?".

Note: Contacts may also be added from call history. For more information, refer to **Call History** above.

Volume Adjustment

- Press Volume + or - key during a call to adjust the receiver volume of the handset/speakerphone/headset.
- Press Volume + or - key when the phone is idle or ringing to adjust the ringer volume.

My Details

Name	
Extension	
DID	

ZAC Login Credentials	
Login Name (case sensitive)	
Password	
Host/URL	
Assigned Phone ID	

Support Contact	
Phone	
Email	

Notes

FCC Statement

This device complies with part 15 of the FCC Rules. Operation is subject to the following two conditions: (1) This device may not cause harmful interference, and (2) this device must accept any interference received, including interference that may cause undesired operation.

This equipment has been tested and found to comply with the limits for a Class B digital device, pursuant to part 15 of the FCC Rules. These limits are designed to provide reasonable protection against harmful interference in a residential installation. This equipment generates, uses and can radiate radio frequency energy and, if not installed and used in accordance with the instructions, may cause harmful interference to radio communications. However, there is no guarantee that interference will not occur in a particular installation. If this equipment does cause harmful interference to radio or television reception, which can be determined by turning the equipment off and on, the user is encouraged to try to correct the interference by one or more of the following measures:

- Reorient or relocate the receiving antenna.
- Increase the separation between the equipment and receiver.
- Connect the equipment into an outlet on a circuit different from that to which the receiver is connected.
- Consult the dealer or an experienced radio/TV technician for help.

Caution: Changes or modifications not expressly approved by the party responsible for compliance could void your authority to operate the equipment.

ISED Canada Statement

This product meets the applicable Innovation, Science and Economic Development Canada technical specifications.

Ce produit répond à la innovation, des sciences et de Développement économique Canada spécifications techniques applicables.

About Zultys

Zultys is the global provider of a true all-in-one unified communications solution. Innovative, reliable and scalable, Zultys IP phone systems integrate voice, video, data and mobility in a single premise based appliance or in the cloud - to optimize collaboration for businesses of all sizes.

Zultys delivers a powerful, feature-rich communications system that is easy-to-use, deploy and maintain. Zultys is headquartered in Silicon Valley with offices around the world.

Zultys, Inc.
785 Lucerne Drive, Sunnyvale
California, 94085, USA
Copyright © 2021 Zultys, Inc.
All rights reserved