

# FCC REPORT

## (Bluetooth)

**Applicant:** Balena Ltd.

**Address of Applicant:** 6th Floor, One London Wall London, London, EC2Y 5EB  
United Kingdom

**Equipment Under Test (EUT)**

Product Name: balenaFin

Model No.: v1.1

Trade mark: balenaFin

**FCC ID:** 2APW6-FIN0110-CM2

**Applicable standards:** FCC CFR Title 47 Part 15 Subpart C Section 15.247

**Date of sample receipt:** 23 Aug., 2019

**Date of Test:** 24 Aug., to 26 Dec., 2019

**Date of report issued:** 27 Dec., 2019

**Test Result:** PASS \*

\* In the configuration tested, the EUT complied with the standards specified above.

Authorized Signature:



Bruce Zhang  
Laboratory Manager

This report details the results of the testing carried out on one sample. The results contained in this test report do not relate to other samples of the same product and does not permit the use of the CCIS product certification mark. The manufacturer should ensure that all products in series production are in conformity with the product sample detailed in this report.

This report may only be reproduced and distributed in full. If the product in this report is used in any configuration other than that detailed in the report, the manufacturer must ensure the new system complies with all relevant standards.

This document cannot be reproduced except in full, without prior written approval of the Company. Any unauthorized alteration, forgery or falsification of the content or appearance of this document is unlawful and offenders may be prosecuted to the fullest extent of the law. Unless otherwise stated the results shown in this test report refer only to the sample(s) tested and such sample(s) are retained for 90 days only.

## 2 Version

Version No.	Date	Description
00	27 Dec., 2019	Original

**Tested by:**

*Carey Chen*

**Test Engineer**

**Date:**

*27 Dec., 2019*

**Reviewed by:**

*Winner Zhang*

**Project Engineer**

**Date:**

*27 Dec., 2019*

## 3 Contents

	Page
<b>1 COVER PAGE</b> .....	<b>1</b>
<b>2 VERSION</b> .....	<b>2</b>
<b>3 CONTENTS</b> .....	<b>3</b>
<b>4 TEST SUMMARY</b> .....	<b>4</b>
<b>5 GENERAL INFORMATION</b> .....	<b>5</b>
5.1 CLIENT INFORMATION.....	5
5.2 GENERAL DESCRIPTION OF E.U.T. ....	5
5.3 TEST ENVIRONMENT AND TEST MODE .....	6
5.4 DESCRIPTION OF SUPPORT UNITS .....	6
5.5 MEASUREMENT UNCERTAINTY.....	6
5.6 ADDITIONS TO, DEVIATIONS, OR EXCLUSIONS FROM THE METHOD .....	6
5.7 LABORATORY FACILITY.....	6
5.8 LABORATORY LOCATION.....	6
5.9 TEST INSTRUMENTS LIST .....	7
<b>6 TEST RESULTS AND MEASUREMENT DATA</b> .....	<b>8</b>
6.1 ANTENNA REQUIREMENT.....	8
6.2 CONDUCTED EMISSIONS .....	9
6.3 CONDUCTED OUTPUT POWER .....	12
6.4 20DB OCCUPY BANDWIDTH.....	15
6.5 CARRIER FREQUENCIES SEPARATION .....	18
6.6 HOPPING CHANNEL NUMBER .....	22
6.7 DWELL TIME .....	24
6.8 PSEUDORANDOM FREQUENCY HOPPING SEQUENCE.....	27
6.9 BAND EDGE.....	28
6.9.1 Conducted Emission Method .....	28
6.9.2 Radiated Emission Method .....	32
6.10 SPURIOUS EMISSION.....	57
6.10.1 Conducted Emission Method.....	57
6.10.2 Radiated Emission Method.....	60
<b>7 TEST SETUP PHOTO</b> .....	<b>66</b>
<b>8 EUT CONSTRUCTIONAL DETAILS</b> .....	<b>68</b>

## 4 Test Summary

Test Items	Section in CFR 47	Result
Antenna Requirement	15.203 & 15.247 (b)	Pass
AC Power Line Conducted Emission	15.207	Pass
Conducted Peak Output Power	15.247 (b)(1)	Pass
20dB Occupied Bandwidth	15.247 (a)(1)	Pass
Carrier Frequencies Separation	15.247 (a)(1)	Pass
Hopping Channel Number	15.247 (a)(1)	Pass
Dwell Time	15.247 (a)(1)	Pass
Spurious Emission	15.205 & 15.209	Pass
Band Edge	15.247(d)	Pass
<p><b>Remark:</b></p> <ol style="list-style-type: none"> <li>1. Pass: The EUT complies with the essential requirements in the standard.</li> <li>2. N/A: Not Applicable.</li> <li>3. The cable insertion loss used by "RF Output Power" and other conduction measurement items is 0.5dB (provided by the customer).</li> </ol>		
<b>Test Method:</b>	ANSI C63.4-2014 ANSI C63.10-2013 KDB 558074 D01 15.247 Meas Guidance v05r02	

## 5 General Information

### 5.1 Client Information

Applicant:	Balena Ltd.
Address:	6th Floor, One London Wall London, London, EC2Y 5EB United Kingdom
Manufacturer:	Balena Ltd.
Address:	6th Floor, One London Wall London, London, EC2Y 5EB United Kingdom
Factory:	Fae Technology S.p.a.
Address:	Via C. Battisti, 136 Gazzaniga (BG) 24025 - Italia

### 5.2 General Description of E.U.T.

Product Name:	balenaFin
Model No.:	v1.1
Operation Frequency:	2402MHz~2480MHz
Transfer rate:	1/2/3 Mbits/s
Number of channel:	79
Modulation type:	GFSK, $\pi/4$ -DQPSK, 8DPSK
Modulation technology:	FHSS
Antenna Type:	Internal Antenna External Antenna
Antenna gain:	Internal Antenna: 1dBi External Antenna: 2dBi
Power supply:	DC6V-24V
Test Sample Condition:	The test samples were provided in good working order with no visible defects.

Operation Frequency each of channel for GFSK, $\pi/4$ -DQPSK, 8DPSK							
Channel	Frequency	Channel	Frequency	Channel	Frequency	Channel	Frequency
0	2402MHz	20	2422MHz	40	2442MHz	60	2462MHz
1	2403MHz	21	2423MHz	41	2443MHz	61	2463MHz
2	2404MHz	22	2424MHz	42	2444MHz	62	2464MHz
3	2405MHz	23	2425MHz	43	2445MHz	63	2465MHz
4	2406MHz	24	2426MHz	44	2446MHz	64	2466MHz
5	2407MHz	25	2427MHz	45	2447MHz	65	2467MHz
...	...	...	...	...	...	...	...
15	2417MHz	35	2437MHz	55	2457MHz	75	2477MHz
16	2418MHz	36	2438MHz	56	2458MHz	76	2478MHz
17	2419MHz	37	2439MHz	57	2459MHz	77	2479MHz
18	2420MHz	38	2440MHz	58	2460MHz	78	2480MHz
19	2421MHz	39	2441MHz	59	2461MHz		

Remark: Channel 0, 39 & 78 selected for GFSK,  $\pi/4$ -DQPSK and 8DPSK.

## 5.3 Test environment and test mode

Operating Environment:	
Temperature:	24.0 °C
Humidity:	54 % RH
Atmospheric Pressure:	1010 mbar
Test Modes:	
Non-hopping mode:	Keep the EUT in continuous transmitting mode with worst case data rate.
Hopping mode:	Keep the EUT in hopping mode.
Remark	GFSK (1 Mbps) is the worst case mode.

The sample was placed 0.8m (below 1GHz)/1.5m (above 1GHz) above the ground plane of 3m chamber\*. Measurements in both horizontal and vertical polarities were performed. During the test, each emission was maximized by: having the EUT continuously working, investigated all operating modes, rotated about all 3 axis (X, Y & Z) and considered typical configuration to obtain worst position, manipulating interconnecting cables, rotating the turntable, varying antenna height from 1m to 4m in both horizontal and vertical polarizations. The emissions worst-case are shown in Test Results of the following pages.

## 5.4 Description of Support Units

Manufacturer	Description	Model	Serial Number	FCC ID/DoC
GSP	Adapter	GSCV0600S019V12E	N/A	DoC
Raspberry Pi	Compute Module	Compute Module 3+	N/A	N/A

## 5.5 Measurement Uncertainty

Parameters	Expanded Uncertainty
Conducted Emission (9kHz ~ 30MHz)	±1.60 dB (k=2)
Radiated Emission (9kHz ~ 30MHz)	±3.12 dB (k=2)
Radiated Emission (30MHz ~ 1000MHz)	±4.32 dB (k=2)
Radiated Emission (1GHz ~ 18GHz)	±5.38 dB (k=2)
Radiated Emission (18GHz ~ 40GHz)	±3.36 dB (k=2)

## 5.6 Additions to, deviations, or exclusions from the method

No
----

## 5.7 Laboratory Facility

<p>The test facility is recognized, certified, or accredited by the following organizations:</p> <ul style="list-style-type: none"> <li>● <b>FCC - Designation No.: CN1211</b> Shenzhen Zhongjian Nanfang Testing Co., Ltd. has been accredited as a testing laboratory by FCC(Federal Communications Commission). The test firm Registration No. is 727551.</li> <li>● <b>ISED – CAB identifier.: CN0021</b> The 3m Semi-anechoic chamber of Shenzhen Zhongjian Nanfang Testing Co., Ltd. has been Registered by Certification and Engineering Bureau of Industry Canada for radio equipment testing with Registration No.: 10106A-1.</li> <li>● <b>CNAS - Registration No.: CNAS L6048</b> Shenzhen Zhongjian Nanfang Testing Co., Ltd. is accredited to ISO/IEC 17025:2005 General Requirements for the Competence of Testing and Calibration laboratories for the competence of testing. The Registration No. is CNAS L6048.</li> <li>● <b>A2LA - Registration No.: 4346.01</b> This laboratory is accredited in accordance with the recognized International Standard ISO/IEC 17025:2005 General requirements for the competence of testing and calibration laboratories. The test scope can be found as below link: <a href="https://portal.a2la.org/scopepdf/4346-01.pdf">https://portal.a2la.org/scopepdf/4346-01.pdf</a></li> </ul>
--

## 5.8 Laboratory Location

<p>Shenzhen Zhongjian Nanfang Testing Co., Ltd. Address: No. B-C, 1/F., Building 2, Laodong No.2 Industrial Park, Xixiang Road, Bao'an District, Shenzhen, Guangdong, China Tel: +86-755-23118282, Fax: +86-755-23116366 Email: info@ccis-cb.com, Website: <a href="http://www.ccis-cb.com">http://www.ccis-cb.com</a></p>
--



## 5.9 Test Instruments list

Radiated Emission:					
Test Equipment	Manufacturer	Model No.	Serial No.	Cal. Date (mm-dd-yy)	Cal. Due date (mm-dd-yy)
3m SAC	SAEMC	9m*6m*6m	966	07-22-2017	07-21-2020
Loop Antenna	SCHWARZBECK	FMZB1519B	00044	03-18-2019	03-17-2020
BiConiLog Antenna	SCHWARZBECK	VULB9163	497	03-18-2019	03-17-2020
Horn Antenna	SCHWARZBECK	BBHA9120D	916	03-18-2019	03-17-2020
Horn Antenna	SCHWARZBECK	BBHA9120D	1805	06-22-2017	06-21-2020
Horn Antenna	SCHWARZBECK	BBHA 9170	BBHA9170582	11-21-2018	11-20-2019
				11-20-2019	11-19-2020
EMI Test Software	AUDIX	E3	Version: 6.110919b		
Pre-amplifier	HP	8447D	2944A09358	03-18-2019	03-17-2020
Pre-amplifier	CD	PAP-1G18	11804	03-18-2019	03-17-2020
Spectrum analyzer	Rohde & Schwarz	FSP30	101454	03-18-2019	03-17-2020
Spectrum analyzer	Rohde & Schwarz	FSP40	100363	11-21-2018	11-20-2019
				11-20-2019	11-19-2020
EMI Test Receiver	Rohde & Schwarz	ESRP7	101070	03-18-2019	03-17-2020
Cable	ZDECL	Z108-NJ-NJ-81	1608458	03-18-2019	03-17-2020
Cable	MICRO-COAX	MFR64639	K10742-5	03-18-2019	03-17-2020
Cable	SUHNER	SUCOFLEX100	58193/4PE	03-18-2019	03-17-2020
RF Switch Unit	MWRFTTEST	MW200	N/A	N/A	N/A
Test Software	MWRFTTEST	MTS8200	Version: 2.0.0.0		

Conducted Emission:					
Test Equipment	Manufacturer	Model No.	Serial No.	Cal. Date (mm-dd-yy)	Cal. Due date (mm-dd-yy)
EMI Test Receiver	Rohde & Schwarz	ESCI	101189	03-18-2019	03-17-2020
Pulse Limiter	SCHWARZBECK	OSRAM 2306	9731	03-18-2019	03-17-2020
LISN	CHASE	MN2050D	1447	03-18-2019	03-17-2020
LISN	Rohde & Schwarz	ESH3-Z5	8438621/010	07-21-2018	07-20-2021
Cable	HP	10503A	N/A	03-18-2019	03-17-2020
EMI Test Software	AUDIX	E3	Version: 6.110919b		

## 6 Test results and measurement data

### 6.1 Antenna Requirement

<b>Standard requirement:</b>	FCC Part 15 C Section 15.203 /247(b)
<p>15.203 requirement:                  An intentional radiator shall be designed to ensure that no antenna other than that furnished by the responsible party shall be used with the device. The use of a permanently attached antenna or of an antenna that uses a unique coupling to the intentional radiator, the manufacturer may design the unit so that a broken antenna can be replaced by the user, but the use of a standard antenna jack or electrical connector is prohibited.</p> <p>15.247(b) (4) requirement:                  (4) The conducted output power limit specified in paragraph (b) of this section is based on the use of antennas with directional gains that do not exceed 6 dBi. Except as shown in paragraph (c) of this section, if transmitting antennas of directional gain greater than 6 dBi are used, the conducted output power from the intentional radiator shall be reduced below the stated values in paragraphs (b)(1), (b)(2), and (b)(3) of this section, as appropriate, by the amount in dB that the directional gain of the antenna exceeds 6 dBi.</p>	
<b>E.U.T Antenna:</b>	
<p>The BLE antenna is an Internal antenna and External antenna which cannot replace by end-user, the best-case gain of the antenna is Internal antenna: 1 dBi and External antenna: 2 dBi</p>	
Internal antenna	External antenna
	



## 6.2 Conducted Emissions

Test Requirement:	FCC Part 15 C Section 15.207		
Test Frequency Range:	150 kHz to 30 MHz		
Class / Severity:	Class B		
Receiver setup:	RBW=9 kHz, VBW=30 kHz, Sweep time=auto		
Limit:	Frequency range (MHz)	Limit (dBuV)	
		Quasi-peak	Average
	0.15-0.5	66 to 56*	56 to 46*
	0.5-5	56	46
	5-30	60	50
* Decreases with the logarithm of the frequency.			
Test setup:	<p>Remark  E.U.T: Equipment Under Test  LISN: Line Impedance Stabilization Network  Test table height=0.8m</p>		
Test procedure:	<ol style="list-style-type: none"> <li>1. The E.U.T and simulators are connected to the main power through a line impedance stabilization network (L.I.S.N.). This provides a 50ohm/50uH coupling impedance for the measuring equipment.</li> <li>2. The peripheral devices are also connected to the main power through a LISN that provides a 50ohm/50uH coupling impedance with 50ohm termination. (Please refer to the block diagram of the test setup and photographs).</li> <li>3. Both sides of A.C. line are checked for maximum conducted interference. In order to find the maximum emission, the relative positions of equipment and all of the interface cables must be changed according to ANSI C63.10(latest version) on conducted measurement.</li> </ol>		
Test Instruments:	Refer to section 5.9 for details		
Test mode:	Hopping mode		
Test results:	Pass		

**Measurement Data:**

Product name:	balenaFin	Product Model:	v1.1
Test by:	Carey	Test mode:	BT Tx mode
Test frequency:	150 kHz ~ 30 MHz	Phase:	Line
Test voltage:	AC 120 V/60 Hz	Environment:	Temp: 22.5°C      Humi: 55%

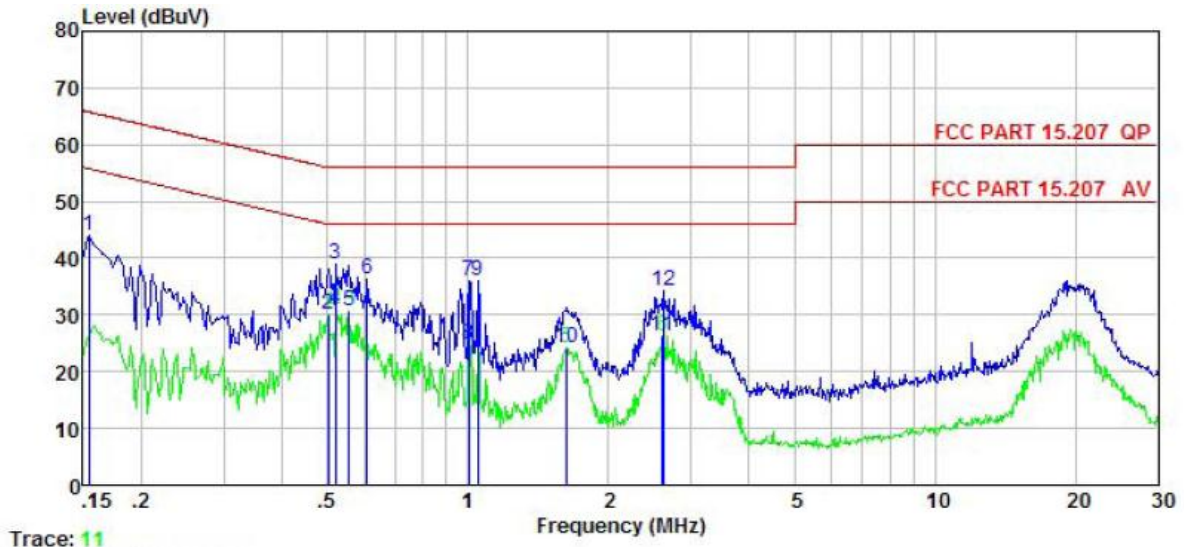

Trace: 11

	Freq	Read Level	LISN Factor	Aux Factor	Cable Loss	Level	Limit Line	Over Limit	Remark
	MHz	dBuV	dB	dB	dB	dBuV	dBuV	dB	
1	0.154	33.79	-0.45	-0.06	10.78	44.06	65.78	-21.72	QP
2	0.502	20.14	-0.39	-0.35	10.76	30.16	46.00	-15.84	Average
3	0.521	28.99	-0.39	-0.36	10.76	39.00	56.00	-17.00	QP
4	0.521	20.86	-0.39	-0.36	10.76	30.87	46.00	-15.13	Average
5	0.555	20.75	-0.39	-0.37	10.76	30.75	46.00	-15.25	Average
6	0.608	26.27	-0.38	-0.38	10.77	36.28	56.00	-19.72	QP
7	1.005	25.01	-0.38	0.46	10.87	35.96	56.00	-20.04	QP
8	1.005	13.78	-0.38	0.46	10.87	24.73	46.00	-21.27	Average
9	1.049	25.17	-0.38	0.40	10.88	36.07	56.00	-19.93	QP
10	1.619	13.77	-0.40	-0.08	10.93	24.22	46.00	-21.78	Average
11	2.608	16.02	-0.43	-0.25	10.93	26.27	46.00	-19.73	Average
12	2.636	23.95	-0.43	-0.25	10.93	34.20	56.00	-21.80	QP

**Notes:**

1. An initial pre-scan was performed on the line and neutral lines with peak detector.
2. Quasi-Peak and Average measurement were performed at the frequencies with maximized peak emission.
3. Final Level = Receiver Read level + LISN Factor + Cable Loss.

<b>Product name:</b>	balenaFin	<b>Product Model:</b>	v1.1
<b>Test by:</b>	Carey	<b>Test mode:</b>	BT Tx mode
<b>Test frequency:</b>	150 kHz ~ 30 MHz	<b>Phase:</b>	Neutral
<b>Test voltage:</b>	AC 120 V/60 Hz	<b>Environment:</b>	Temp: 22.5°C Humi: 55%

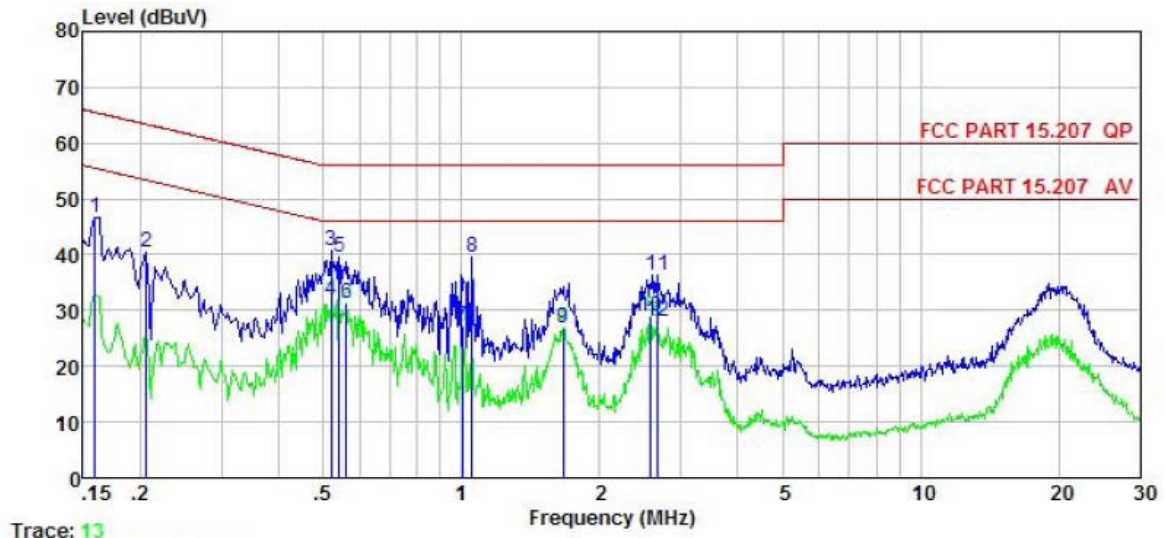

	Read Freq	Read Level	LISN Factor	Aux Factor	Cable Loss	Level	Limit Line	Over Limit	Remark
	MHz	dBuV	dB	dB	dB	dBuV	dBuV	dB	
1	0.159	36.46	-0.68	0.01	10.77	46.56	65.52	-18.96	QP
2	0.206	30.52	-0.69	0.00	10.76	40.59	63.36	-22.77	QP
3	0.521	30.70	-0.65	0.03	10.76	40.84	56.00	-15.16	QP
4	0.521	21.85	-0.65	0.03	10.76	31.99	46.00	-14.01	Average
5	0.541	29.32	-0.65	0.03	10.76	39.46	56.00	-16.54	QP
6	0.561	21.17	-0.65	0.03	10.76	31.31	46.00	-14.69	Average
7	1.005	16.87	-0.63	0.08	10.87	27.19	46.00	-18.81	Average
8	1.054	29.19	-0.63	0.09	10.88	39.53	56.00	-16.47	QP
9	1.662	16.52	-0.66	0.15	10.94	26.95	46.00	-19.05	Average
10	2.581	18.52	-0.67	0.26	10.93	29.04	46.00	-16.96	Average
11	2.664	25.91	-0.67	0.27	10.93	36.44	56.00	-19.56	QP
12	2.664	17.52	-0.67	0.27	10.93	28.05	46.00	-17.95	Average

**Notes:**

1. An initial pre-scan was performed on the line and neutral lines with peak detector.
2. Quasi-Peak and Average measurement were performed at the frequencies with maximized peak emission.
3. Final Level = Receiver Read level + LISN Factor + Cable Loss.

## 6.3 Conducted Output Power

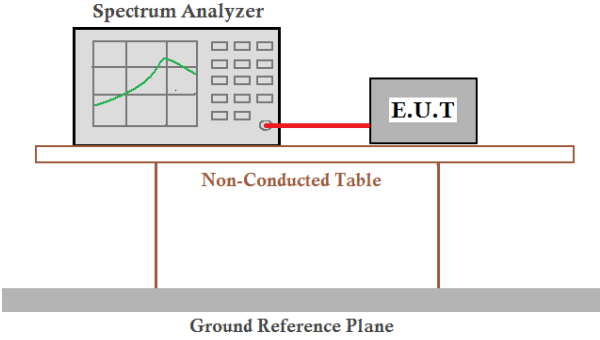
Test Requirement:	FCC Part 15 C Section 15.247 (b)(1)
Receiver setup:	RBW=1MHz, VBW=3MHz, Detector=Peak (If 20dB BW ≤ 1 MHz) RBW=3MHz, VBW=10MHz, Detector=Peak (If 20dB BW > 1 MHz and < 3MHz)
Limit:	For frequency hopping systems operating in the 2400-2483.5 MHz band employing at least 75 non-overlapping hopping channels: 1 watt. For all other frequency hopping systems in the 2400-2483.5 MHz band: 0.125 watts.
Test setup:	 <p>The diagram illustrates the test setup. A Spectrum Analyzer is connected via a red cable to an E.U.T. (Equipment Under Test). Both are placed on a Non-Conducted Table. Below the table is a Ground Reference Plane.</p>
Test Instruments:	Refer to section 5.9 for details
Test mode:	Non-hopping mode
Test results:	Pass

### Measurement Data:

Test channel	Peak Output Power (dBm)	Limit (dBm)	Result
GFSK mode			
Lowest channel	3.09	21.00	Pass
Middle channel	2.58	21.00	Pass
Highest channel	1.99	21.00	Pass
$\pi/4$ -DQPSK mode			
Lowest channel	2.74	21.00	Pass
Middle channel	2.28	21.00	Pass
Highest channel	1.61	21.00	Pass
8DPSK mode			
Lowest channel	2.19	21.00	Pass
Middle channel	1.67	21.00	Pass
Highest channel	1.00	21.00	Pass

Test plot as follows:

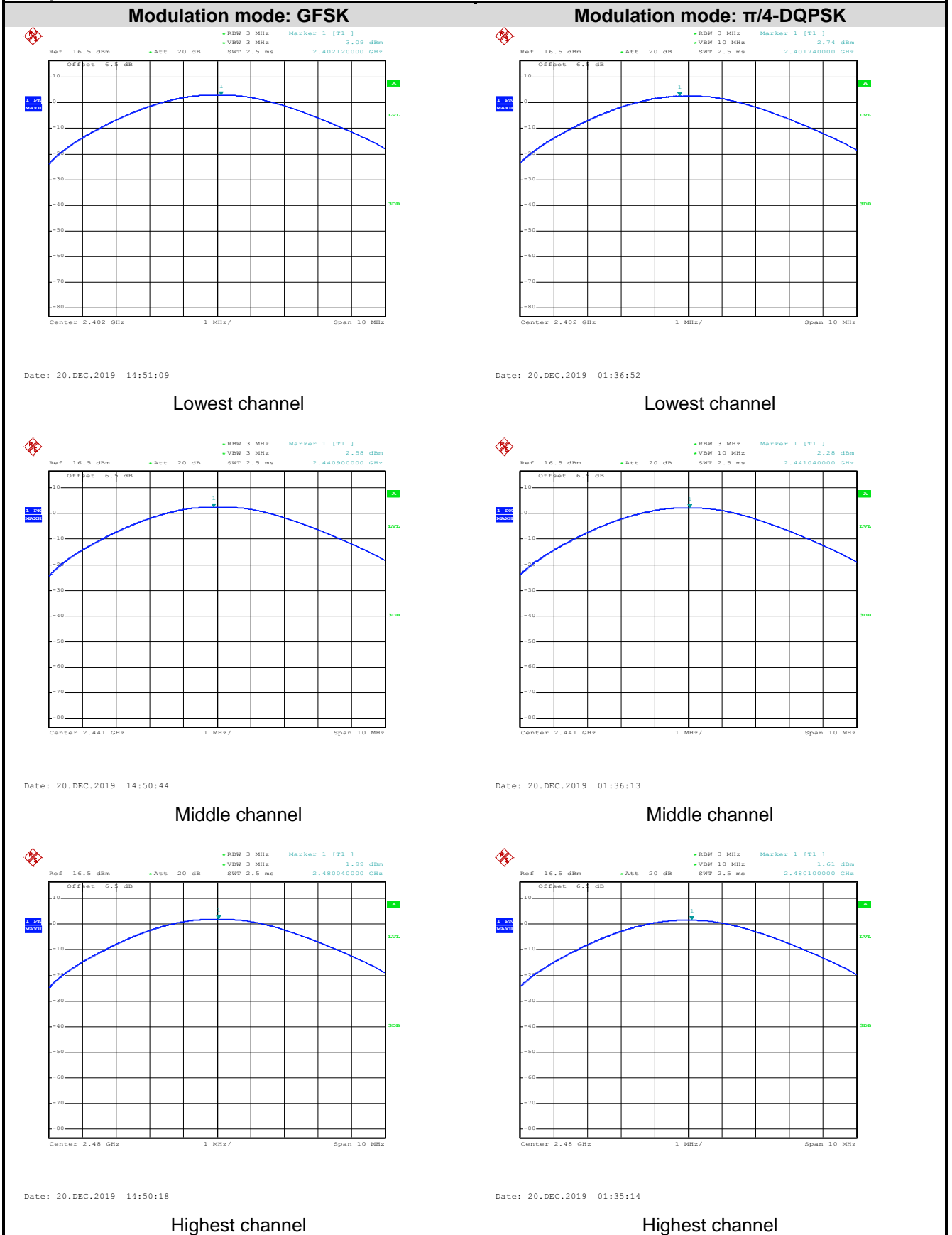

## Modulation mode: 8DPSK

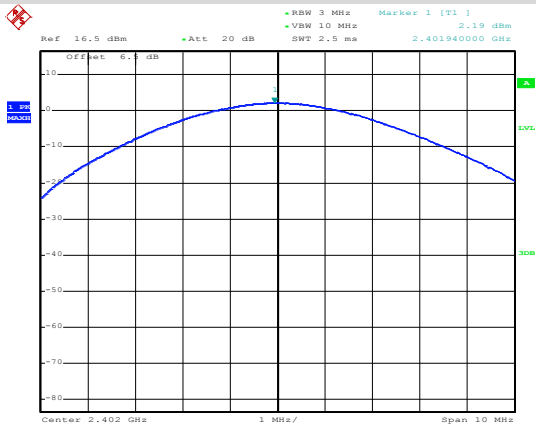

Date: 20.DEC.2019 01:38:17

Lowest channel

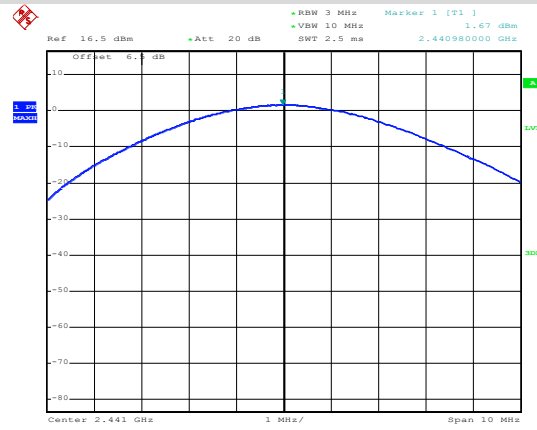

Date: 20.DEC.2019 01:38:51

Middle channel

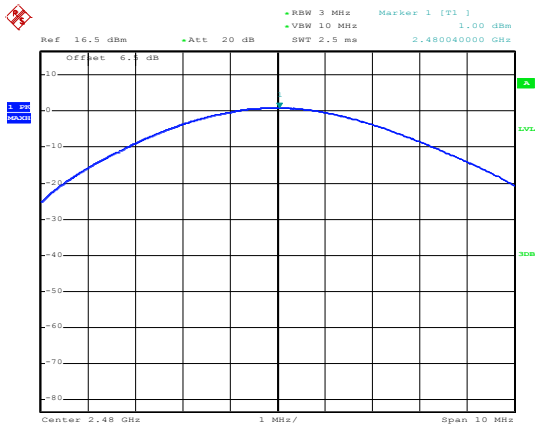

Date: 20.DEC.2019 01:39:25

Highest channel

## 6.4 20dB Occupy Bandwidth

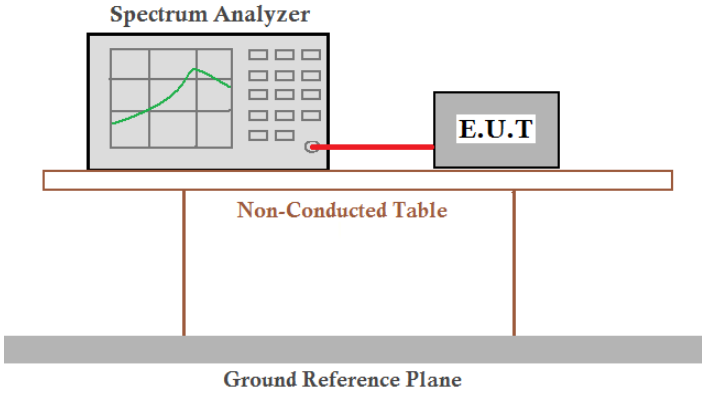
Test Requirement:	FCC Part 15 C Section 15.247 (a)(1)
Receiver setup:	RBW=30 kHz, VBW=100 kHz, detector=Peak
Limit:	N/A
Test setup:	 <p>The diagram shows a Spectrum Analyzer on the left and an E.U.T. on the right, connected by a red cable. They are both on a table labeled 'Non-Conducted Table'. Below the table is a 'Ground Reference Plane'.</p>
Test Instruments:	Refer to section 5.9 for details
Test mode:	Non-hopping mode
Test results:	Pass

### Measurement Data:

Test channel	20dB Occupy Bandwidth (kHz)		
	GFSK	$\pi/4$ -DQPSK	8DPSK
Lowest	1060	1314	1284
Middle	1028	1320	1284
Highest	1024	1314	1284

Test plot as follows:

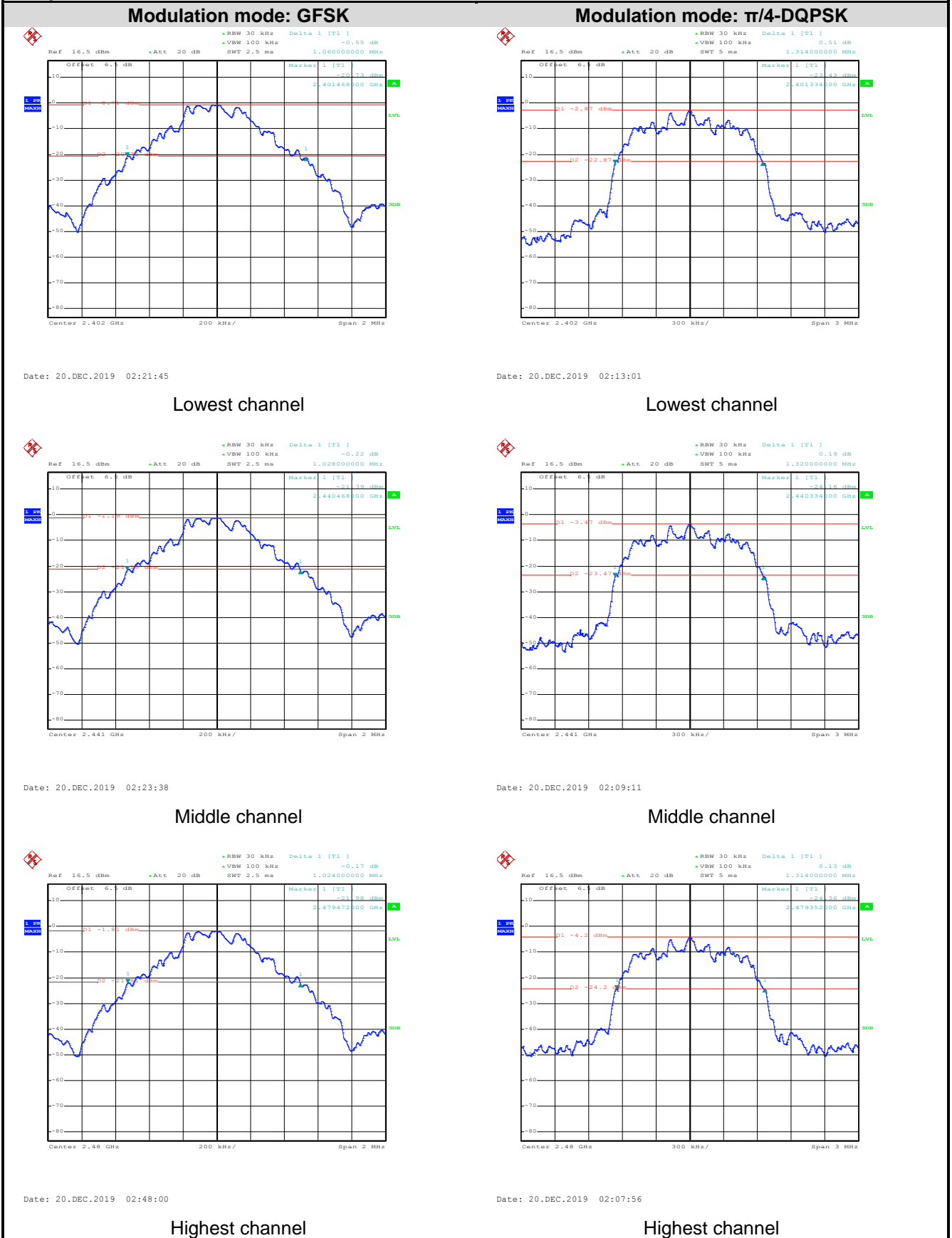



## Modulation mode: 8DPSK

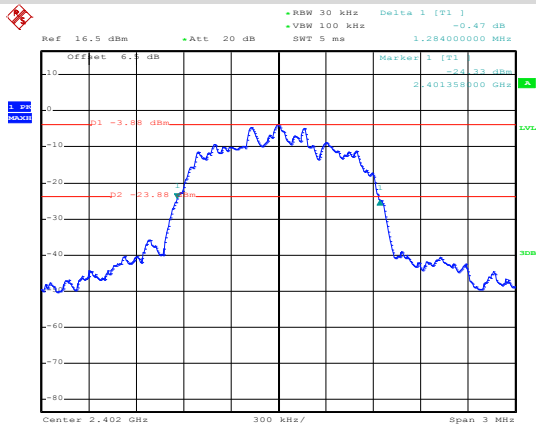

Date: 20.DEC.2019 02:16:01

Lowest channel

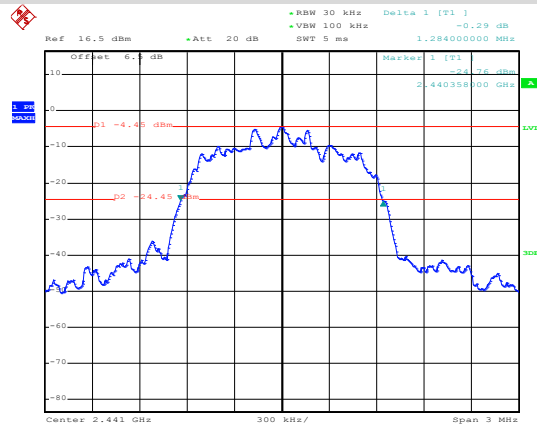

Date: 20.DEC.2019 02:17:30

Middle channel

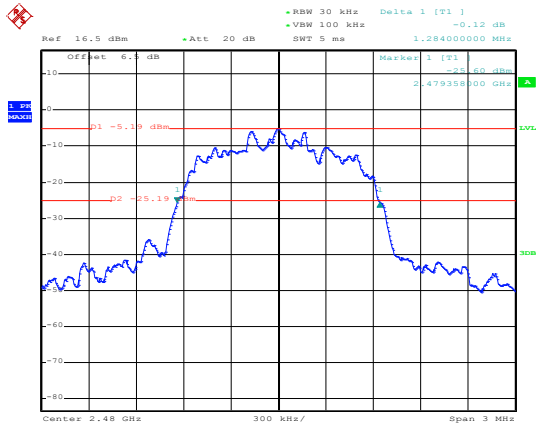

Date: 20.DEC.2019 02:19:01

Highest channel

## 6.5 Carrier Frequencies Separation

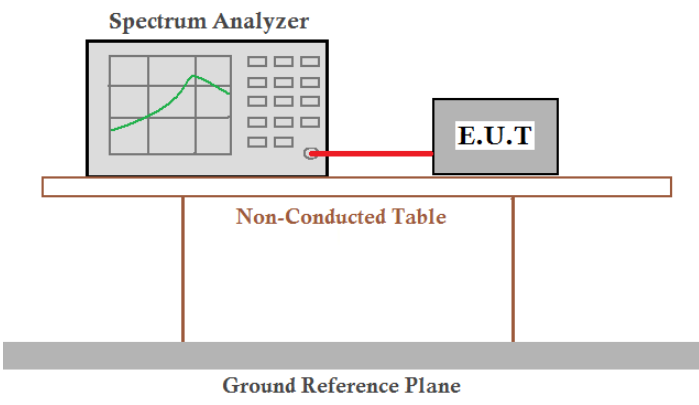
Test Requirement:	FCC Part 15 C Section 15.247 (a)(1)
Receiver setup:	RBW=100 kHz, VBW=300 kHz, detector=Peak
Limit:	a) 0.025MHz or the 20dB bandwidth (whichever is greater) b) 0.025MHz or two-thirds of the 20dB bandwidth (whichever is greater)
Test setup:	 <p>The diagram illustrates the test setup. A Spectrum Analyzer is connected to an E.U.T. (Equipment Under Test) via a red cable. Both are placed on a Non-Conducted Table, which is supported by a Ground Reference Plane.</p>
Test Instruments:	Refer to section 5.9 for details
Test mode:	Hopping mode
Test results:	Pass

**Measurement Data:**

Test channel	Carrier Frequencies Separation (kHz)	Limit (kHz)	Result
GFSK			
Lowest	1000	682.67	Pass
Middle	1016	682.67	Pass
Highest	1004	682.67	Pass
$\pi/4$ -DQPSK mode			
Lowest	1008	876.00	Pass
Middle	1008	876.00	Pass
Highest	1008	876.00	Pass
8DPSK mode			
Lowest	1004	856.00	Pass
Middle	1000	856.00	Pass
Highest	1008	856.00	Pass

Note: According to section 6.4

Mode	20dB bandwidth (kHz) (worse case)	Limit (kHz) (Carrier Frequencies Separation)
GFSK	1024	682.67
$\pi/4$ -DQPSK	1314	876.00
8DPSK	1284	856.00

Test plot as follows:

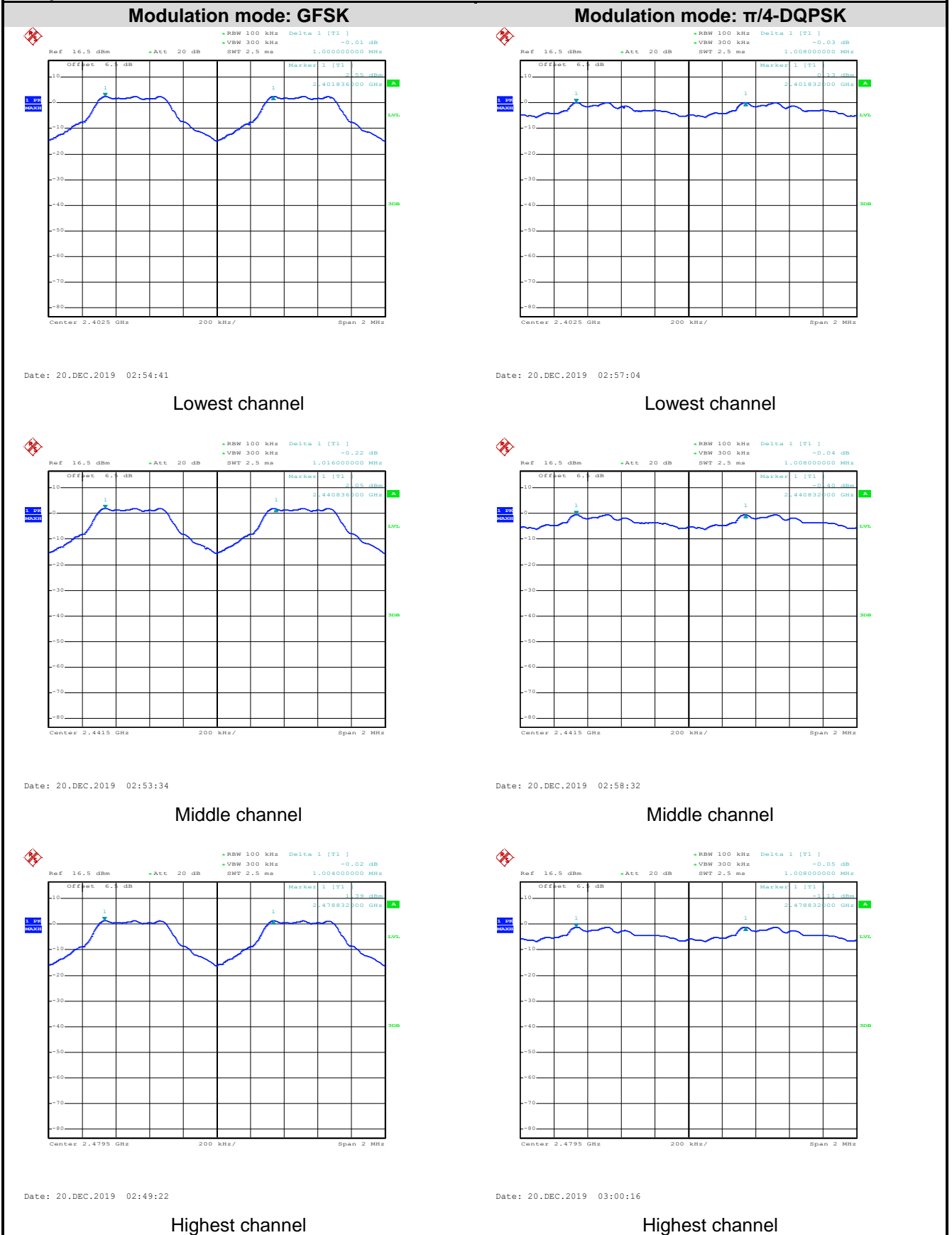

## Modulation mode: 8DPSK

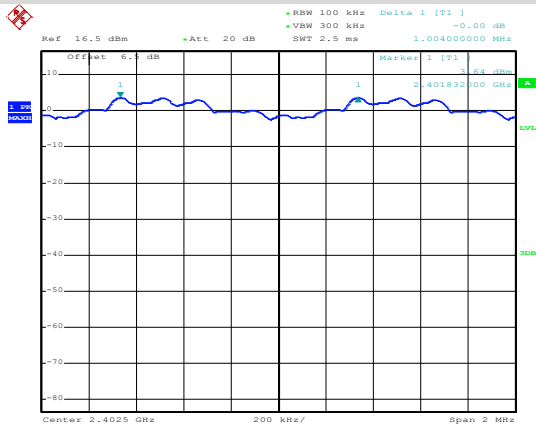

Date: 20.DEC.2019 03:07:49

Lowest channel

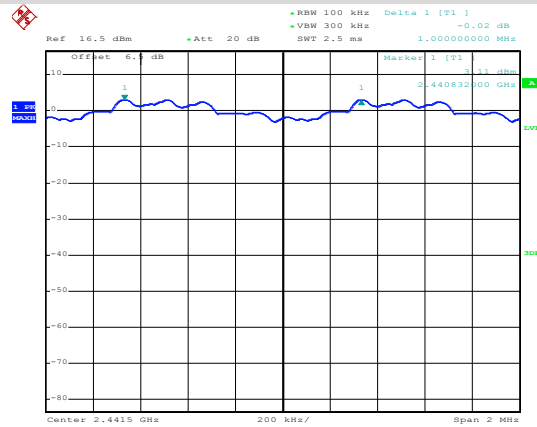

Date: 20.DEC.2019 03:06:04

Middle channel

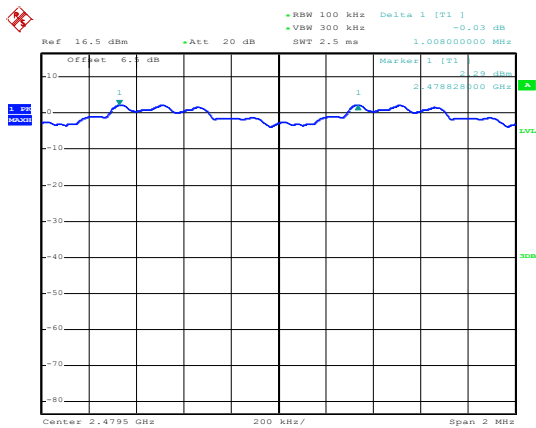

Date: 20.DEC.2019 03:04:11

Highest channel

## 6.6 Hopping Channel Number

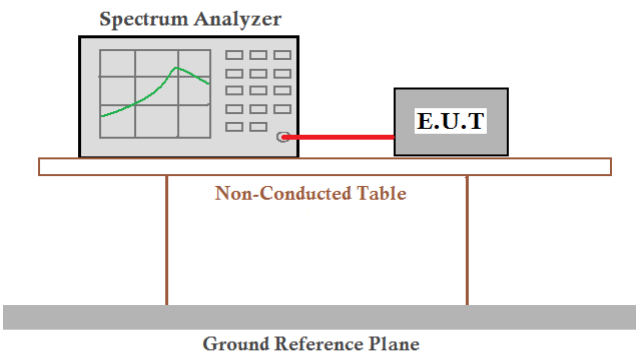
Test Requirement:	FCC Part 15 C Section 15.247 (a)(1)
Receiver setup:	RBW=100 kHz, VBW=300 kHz, Frequency range=2400MHz-2483.5MHz, Detector=Peak
Limit:	15 channels
Test setup:	 <p>The diagram illustrates the test setup. A Spectrum Analyzer is connected to an E.U.T. (Equipment Under Test) via a red cable. Both are placed on a Non-Conducted Table, which is supported by a Ground Reference Plane.</p>
Test Instruments:	Refer to section 5.9 for details
Test mode:	Hopping mode
Test results:	Pass

### Measurement Data:

Mode	Hopping channel numbers	Limit	Result
GFSK, $\pi/4$ -DQPSK, 8DPSK	79	15	Pass

Test plot as follows:

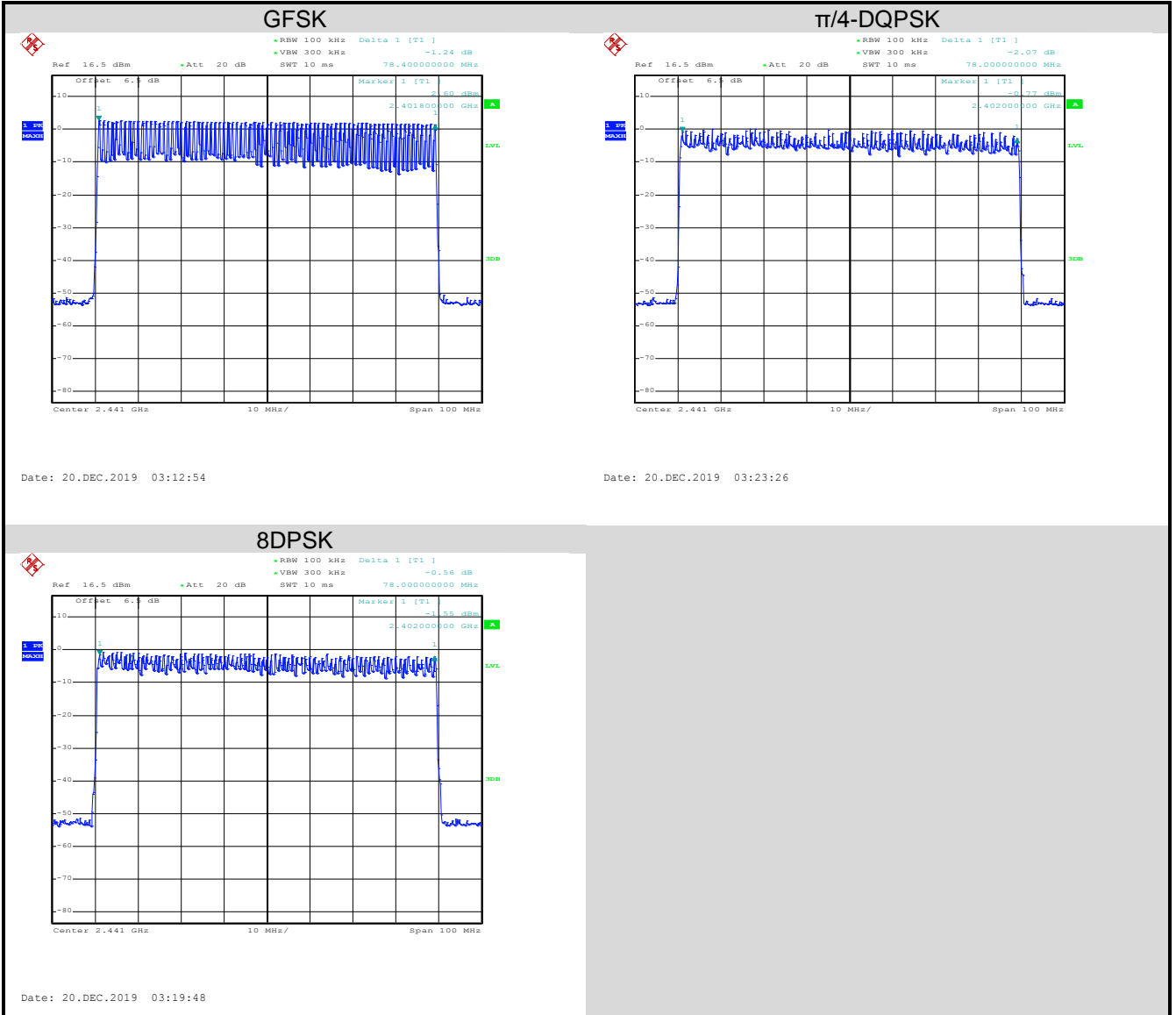

## 6.7 Dwell Time

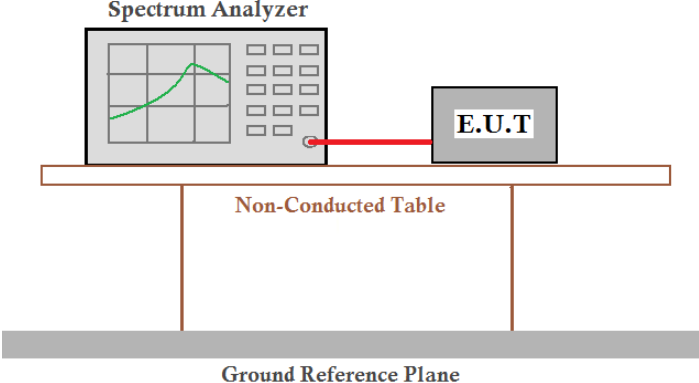
Test Requirement:	FCC Part 15 C Section 15.247 (a)(1)
Receiver setup:	RBW=1 MHz, VBW=1 MHz, Span=0 Hz, Detector=Peak
Limit:	0.4 Second
Test setup:	
Test Instruments:	Refer to section 5.9 for details
Test mode:	Hopping mode
Test results:	Pass

### Measurement Data (Worse case):

Mode	Packet	Dwell time (second)	Limit (second)	Result
GFSK	DH1	0.12928	0.4	Pass
	DH3	0.26784		
	DH5	0.31317		
π/4-DQPSK	2-DH1	0.13120	0.4	Pass
	2-DH3	0.26784		
	2-DH5	0.31232		
8DPSK	3-DH1	0.13024	0.4	Pass
	3-DH3	0.26784		
	3-DH5	0.31232		

**Note:**

The test period = 0.4 Second/Channel x 79 Channel = 31.6 s

Calculation Formula: Dwell time = Ton time per hop \* Hopping numbers \* Period

For example:

DH1 time slot =  $0.404 * (1600 / (2 * 79)) * 31.6 = 129.28\text{ms}$

DH3 time slot =  $1.674 * (1600 / (4 * 79)) * 31.6 = 267.84\text{ms}$

DH5 time slot =  $2.936 * (1600 / (6 * 79)) * 31.6 = 313.17\text{ms}$



Test plot as follows:

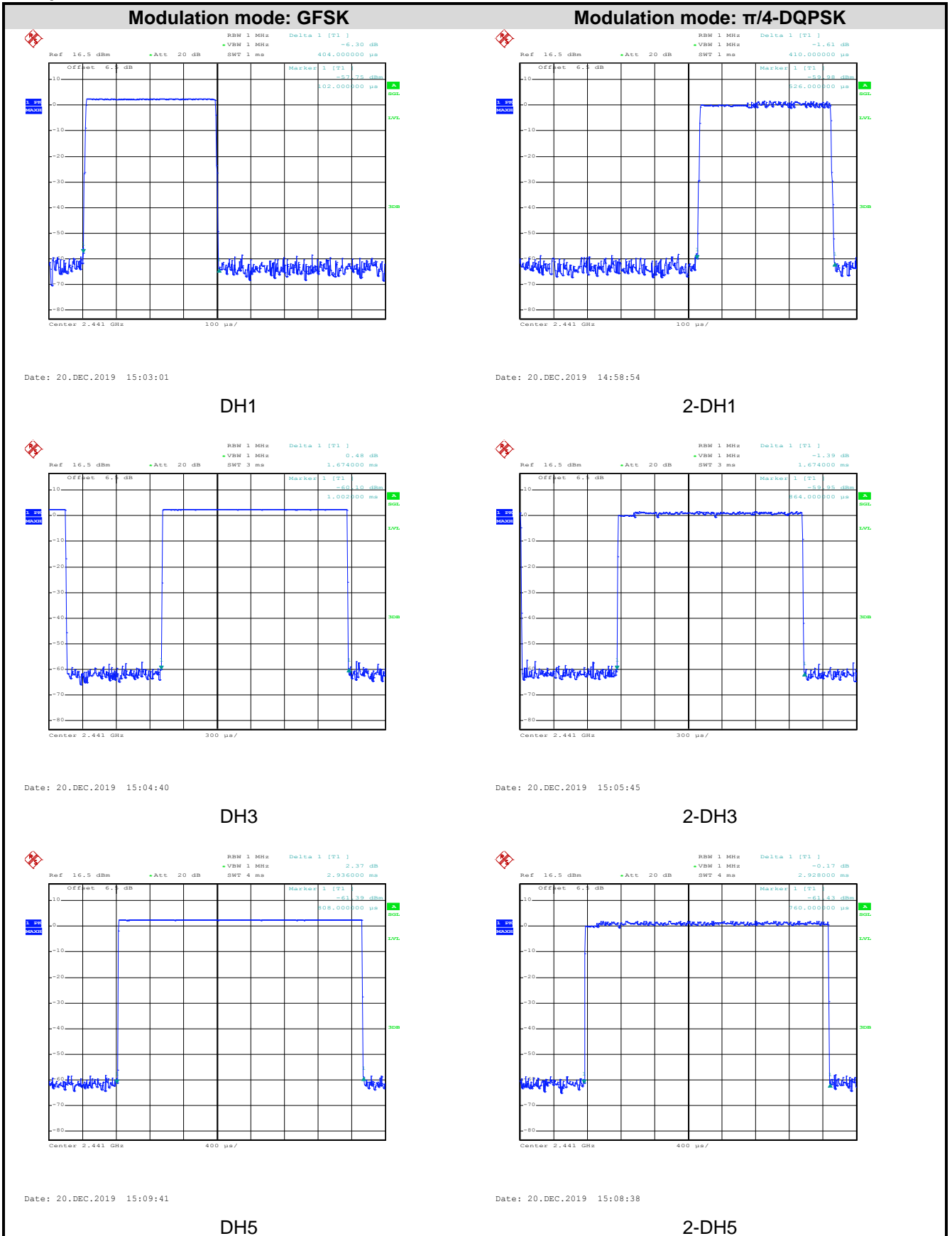

Modulation mode: 8DPSK

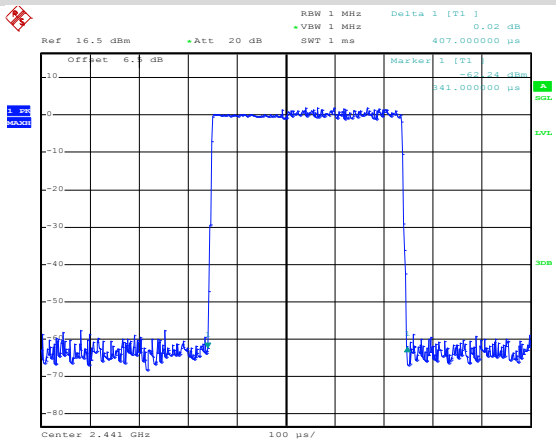

Date: 20.DEC.2019 14:57:40

3-DH1

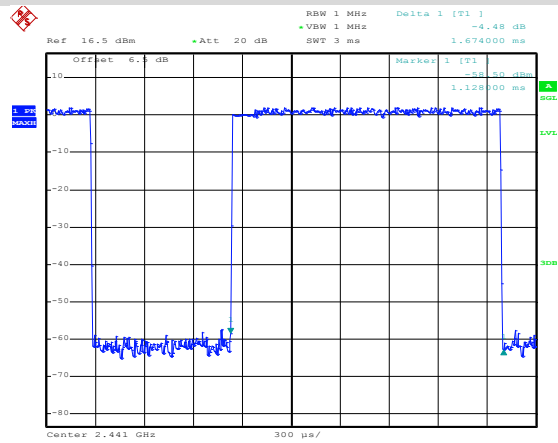

Date: 20.DEC.2019 15:06:33

3-DH3

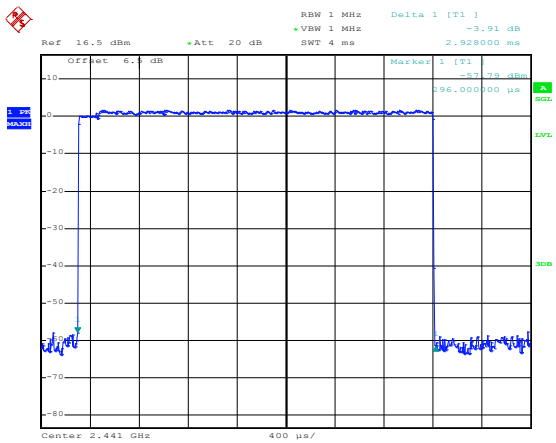

Date: 20.DEC.2019 15:07:41

3-DH5

## 6.8 Pseudorandom Frequency Hopping Sequence

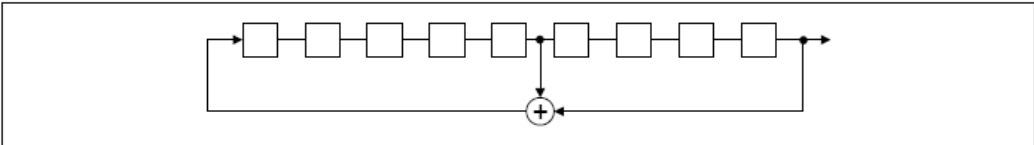
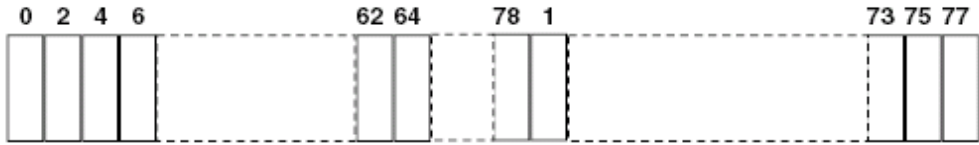
<b>Test Requirement:</b>	<b>FCC Part 15 C Section 15.247 (a)(1) requirement:</b>
<p>Frequency hopping systems shall have hopping channel carrier frequencies separated by a minimum of 25 kHz or the 20 dB bandwidth of the hopping channel, whichever is greater.</p> <p>Alternatively. Frequency hopping systems operating in the 2400-2483.5 MHz band may have hopping channel carrier frequencies that are separated by 25 kHz or two-thirds of the 20 dB bandwidth of the hopping channel, whichever is greater, provided the systems operate with an output power no greater than 125 mW. The system shall hop to channel frequencies that are selected at the system hopping rate from a Pseudorandom ordered list of hopping frequencies. Each frequency must be used equally on the average by each transmitter. The system receivers shall have input bandwidths that match the hopping channel bandwidths of their corresponding transmitters and shall shift frequencies in synchronization with the transmitted signals.</p>	
<b>EUT Pseudorandom Frequency Hopping Sequence</b>	
<p>The pseudorandom sequence may be generated in a nine-stage shift register whose 5th and 9th stage outputs are added in a modulo-two addition stage. And the result is fed back to the input of the first stage. The sequence begins with the first ONE of 9 consecutive ONES; i.e. the shift register is initialized with nine ones.</p> <ul style="list-style-type: none"> <li>• Number of shift register stages: 9</li> <li>• Length of pseudo-random sequence: <math>2^9 - 1 = 511</math> bits</li> <li>• Longest sequence of zeros: 8 (non-inverted signal)</li> </ul>	
	
<p><i>Linear Feedback Shift Register for Generation of the PRBS sequence</i></p>	
<p>An example of Pseudorandom Frequency Hopping Sequence as follow:</p>	
	
<p>Each frequency used equally on the average by each transmitter.</p> <p>The system receivers have input bandwidths that match the hopping channel bandwidths of their corresponding transmitters and shift frequencies in synchronization with the transmitted signals.</p>	

## 6.9 Band Edge

### 6.9.1 Conducted Emission Method

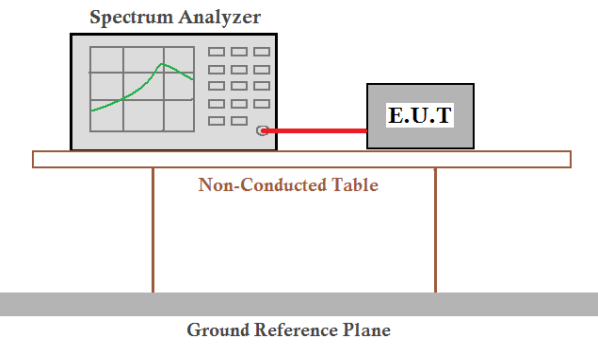
Test Requirement:	FCC Part 15 C Section 15.247 (d)
Receiver setup:	RBW=100 kHz, VBW=300 kHz, Detector=Peak
Limit:	In any 100 kHz bandwidth outside the frequency band in which the spread spectrum intentional radiator is operating, the radio frequency power that is produced by the intentional radiator shall be at least 20 dB below that in the 100 kHz bandwidth within the band that contains the highest level of the desired power, based on either an RF conducted or a radiated measurement.
Test setup:	 <p>The diagram illustrates the test setup. A Spectrum Analyzer is connected to an E.U.T. (Equipment Under Test) via a red cable. Both the Spectrum Analyzer and the E.U.T. are placed on a Non-Conducted Table. The table is supported by a Ground Reference Plane.</p>
Test Instruments:	Refer to section 5.9 for details
Test mode:	Non-hopping mode and hopping mode
Test results:	Pass

Test plot as follows:

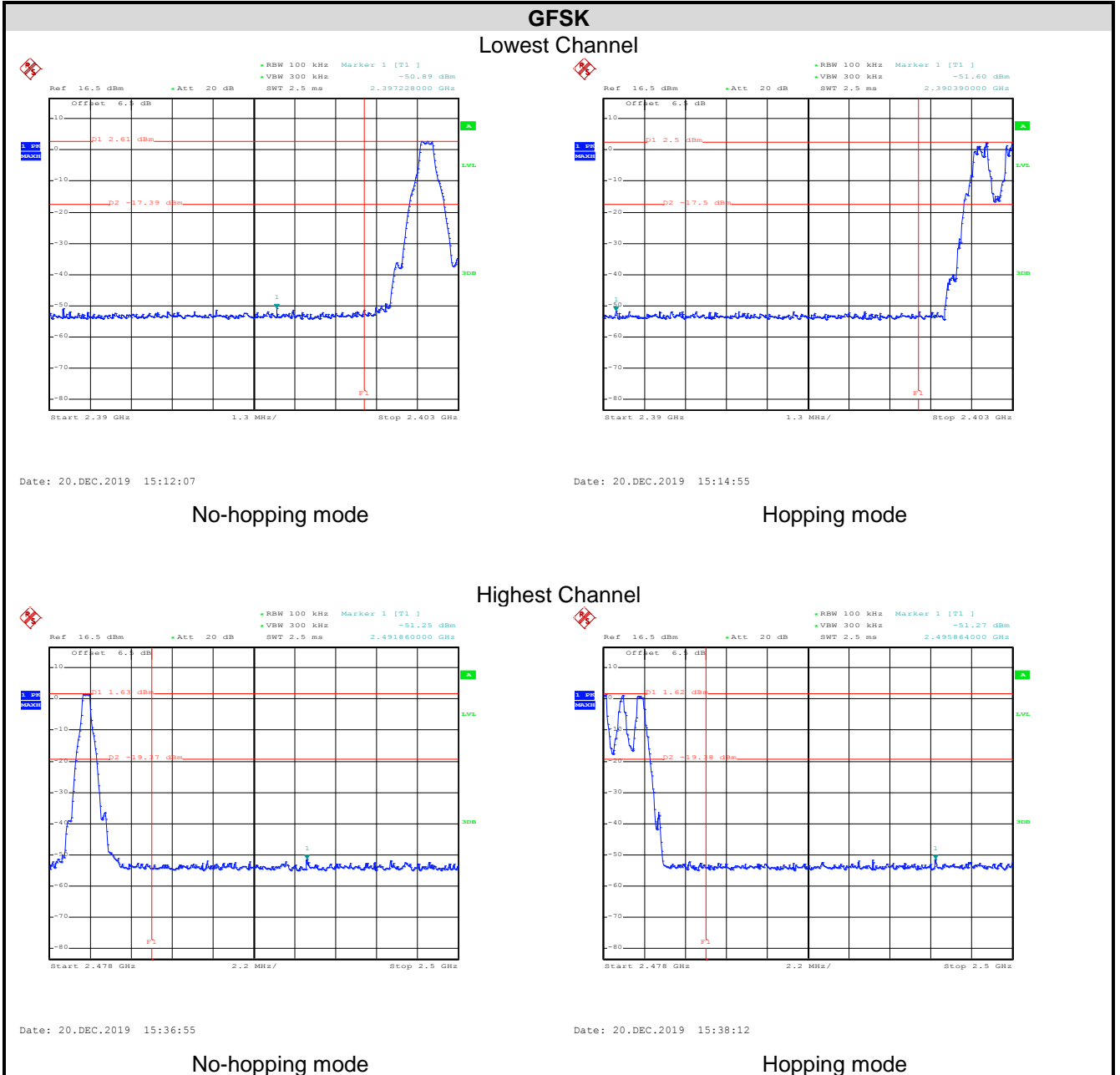

## π/4-DQPSK Lowest Channel

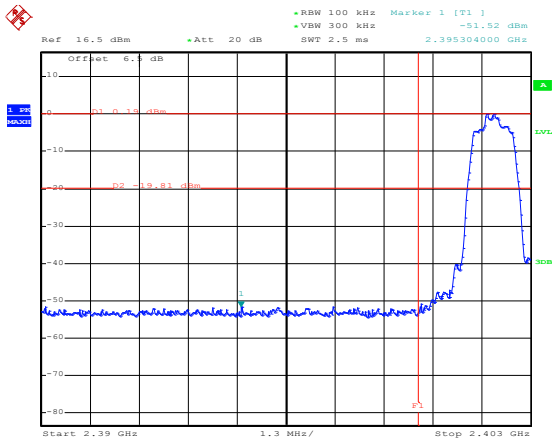

Date: 20.DEC.2019 15:17:49

No-hopping mode

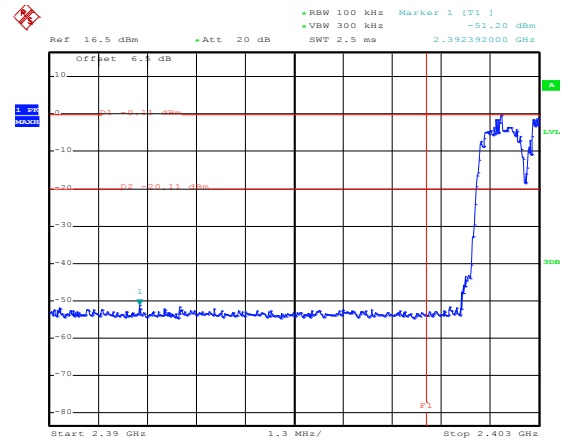

Date: 20.DEC.2019 15:20:12

Hopping mode

## Highest Channel

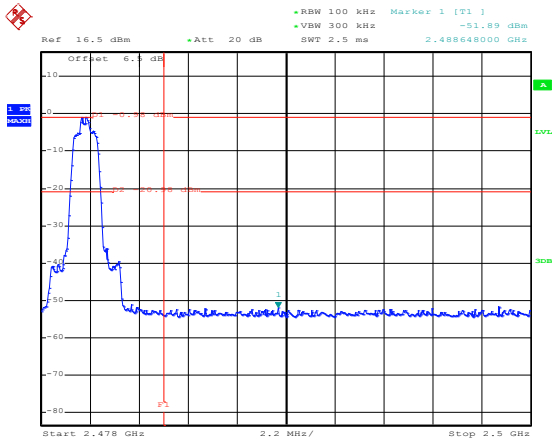

Date: 20.DEC.2019 15:34:34

No-hopping mode

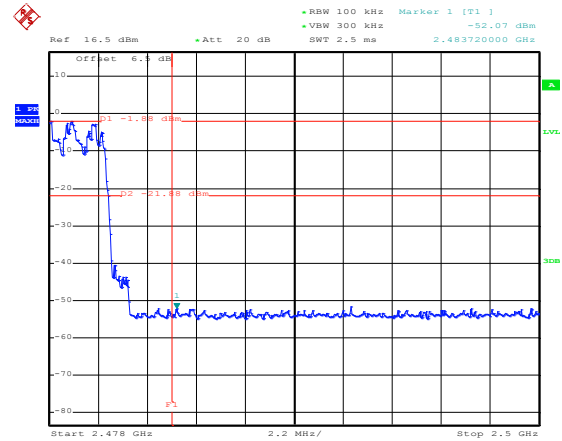

Date: 20.DEC.2019 15:35:46

Hopping mode

## 8DPSK Lowest Channel

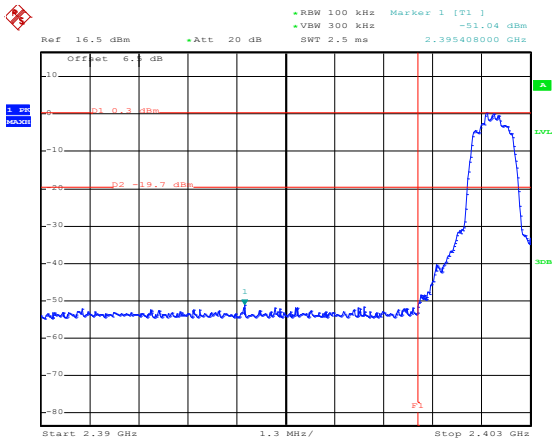

Date: 20.DEC.2019 15:21:29

No-hopping mode

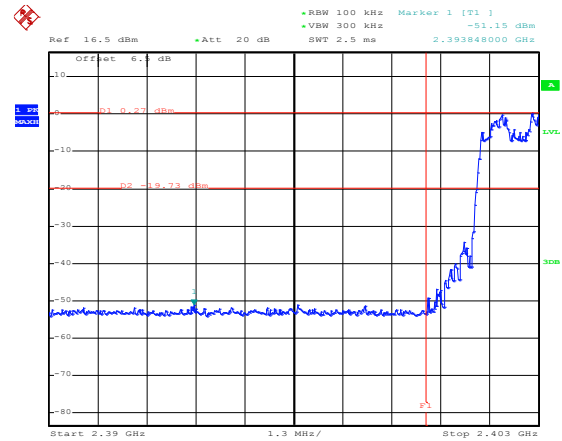

Date: 20.DEC.2019 15:25:15

Hopping mode

## Highest Channel

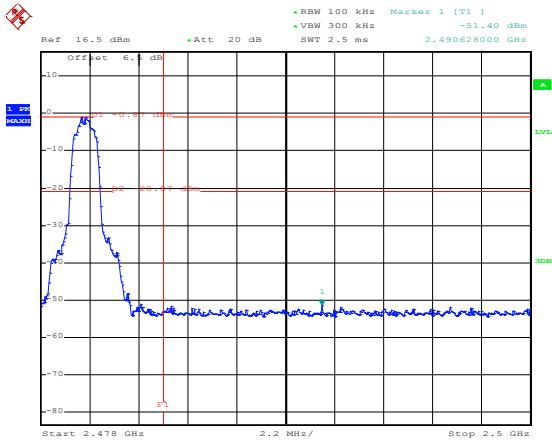

Date: 20.DEC.2019 15:29:38

No-hopping mode

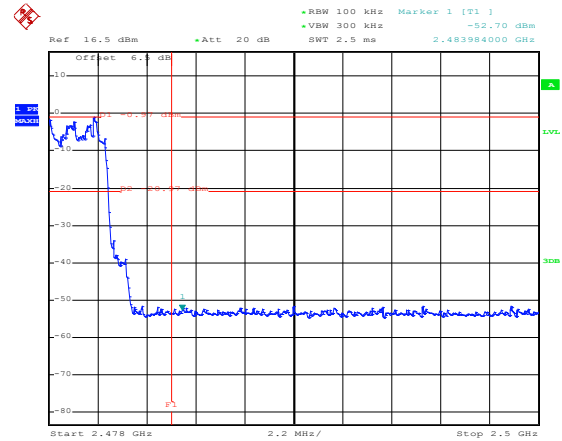

Date: 20.DEC.2019 15:27:21

Hopping mode

## 6.9.2 Radiated Emission Method

Test Requirement:	FCC Part 15 C Section 15.209 and 15.205				
Test Frequency Range:	2.3GHz to 2.5GHz				
Test Distance:	3m				
Receiver setup:	Frequency	Detector	RBW	VBW	Remark
	Above 1GHz	Peak	1MHz	3MHz	Peak Value
		RMS	1MHz	3MHz	Average Value
Limit:	Frequency	Limit (dBuV/m @3m)		Remark	
	Above 1GHz	54.00		Average Value	
		74.00		Peak Value	
Test setup:					
Test Procedure:	<ol style="list-style-type: none"> <li>1. The EUT was placed on the top of a rotating table 1.5meters above the ground at a 3 meter camber. The table was rotated 360 degrees to determine the position of the highest radiation.</li> <li>2. The EUT was set 3 meters away from the interference-receiving antenna, which was mounted on the top of a variable-height antenna tower.</li> <li>3. The antenna height is varied from one meter to four meters above the ground to determine the maximum value of the field strength. Both horizontal and vertical polarizations of the antenna are set to make the measurement.</li> <li>4. For each suspected emission, the EUT was arranged to its worst case and then the antenna was tuned to heights from 1 meter to 4 meters and the rota table was turned from 0 degrees to 360 degrees to find the maximum reading.</li> <li>5. The test-receiver system was set to Peak Detect Function and Specified Bandwidth with Maximum Hold Mode.</li> <li>6. If the emission level of the EUT in peak mode was 10dB lower than the limit specified, then testing could be stopped and the peak values of the EUT would be reported. Otherwise the emissions that did not have 10dB margin would be re-tested one by one using peak, quasi-peak or average method as specified and then reported in a data sheet.</li> </ol>				
Test Instruments:	Refer to section 5.9 for details				
Test mode:	Non-hopping mode				
Test results:	Passed				



**Internal Antenna**

**GFSK Mode:**

<b>Product Name:</b>	balenaFin	<b>Product Model:</b>	v1.1
<b>Test By:</b>	Carey	<b>Test mode:</b>	DH1 Tx mode
<b>Test Channel:</b>	Lowest channel	<b>Polarization:</b>	Vertical
<b>Test Voltage:</b>	AC 120/60Hz	<b>Environment:</b>	Temp: 24°C Humi: 57%

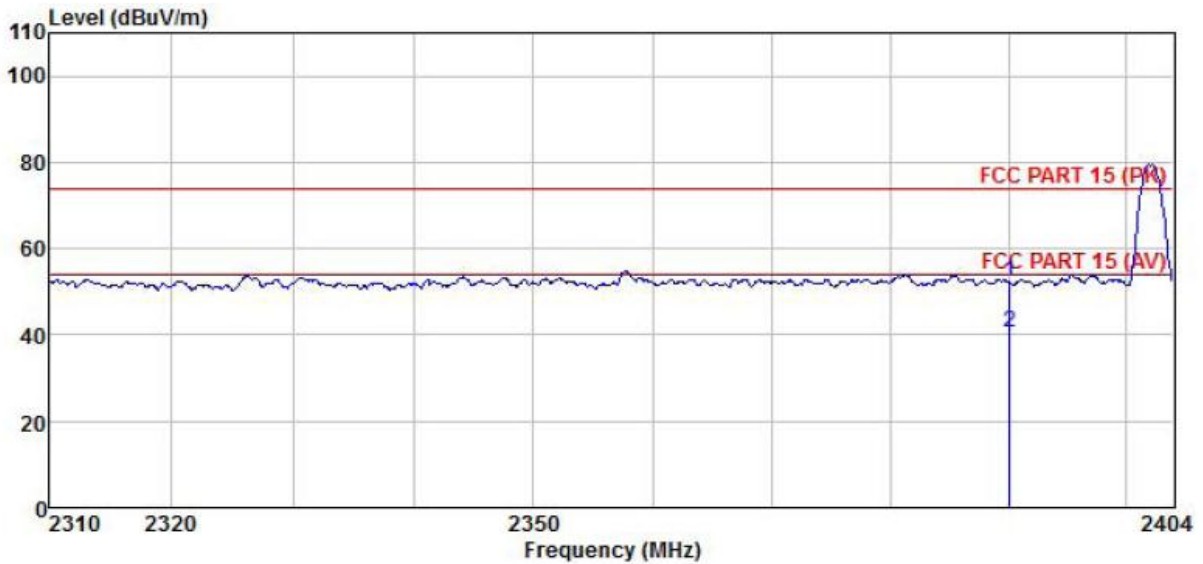

	ReadAntenna	Cable	Preamp	Limit	Over			
Freq	Level	Factor	Loss	Factor	Level	Line	Limit	Remark
-----	-----	-----	-----	-----	-----	-----	-----	-----
MHz	dBuV	dB/m	dB	dB	dBuV/m	dBuV/m	dB	
1	2390.000	20.47	27.07	4.69	0.00	52.23	74.00	-21.77 Peak
2	2390.000	8.77	27.07	4.69	0.00	40.53	54.00	-13.47 Average

**Remark:**

1. Final Level = Receiver Read level + Antenna Factor + Cable Loss – Preamplifier Factor.
2. The emission levels of other frequencies are very lower than the limit and not show in test report.

<b>Product Name:</b>	balenaFin	<b>Product Model:</b>	v1.1
<b>Test By:</b>	Carey	<b>Test mode:</b>	DH1 Tx mode
<b>Test Channel:</b>	Lowest channel	<b>Polarization:</b>	Horizontal
<b>Test Voltage:</b>	AC 120/60Hz	<b>Environment:</b>	Temp: 24°C Humi: 57%

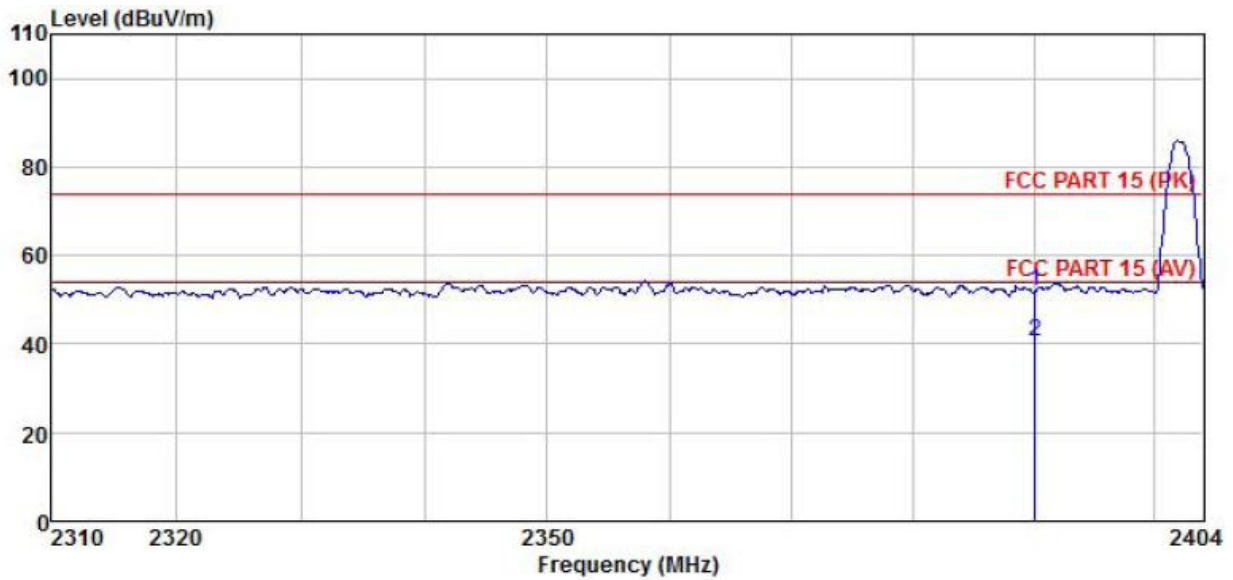

	ReadAntenna	Cable	Preamp	Limit	Over				
Freq	Level	Factor	Loss	Factor	Level	Line			
-----	-----	-----	-----	-----	-----	-----			
MHz	dBuV	dB/m	dB	dB	dBuV/m	dBuV/m			
1	2390.000	20.13	27.08	4.69	0.00	51.90	74.00	-22.10	Peak
2	2390.000	8.81	27.08	4.69	0.00	40.58	54.00	-13.42	Average

**Remark:**

1. Final Level = Receiver Read level + Antenna Factor + Cable Loss – Pre-amplifier Factor.
2. The emission levels of other frequencies are very lower than the limit and not show in test report.

Product Name:	balenaFin	Product Model:	v1.1
Test By:	Carey	Test mode:	DH1 Tx mode
Test Channel:	Highest channel	Polarization:	Vertical
Test Voltage:	AC 120/60Hz	Environment:	Temp: 24°C Humi: 57%

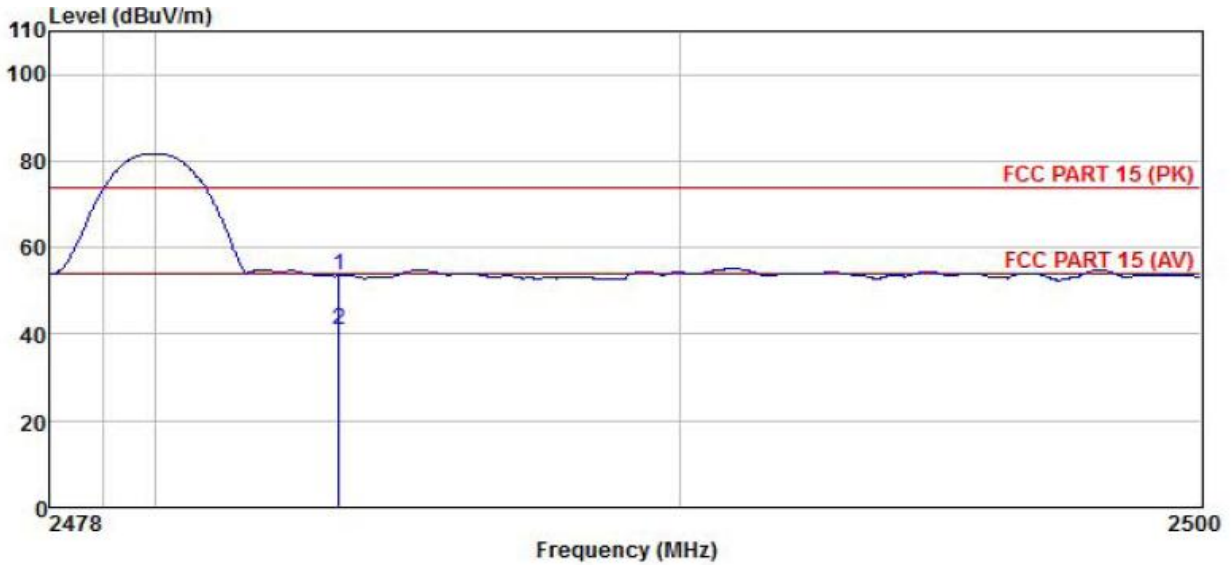

	ReadAntenna	Cable	Preamp	Limit	Over			
Freq	Level	Factor	Loss	Factor	Level	Line	Limit	Remark
-----	-----	-----	-----	-----	-----	-----	-----	-----
MHz	dBuV	dB/m	dB	dB	dBuV/m	dBuV/m	dB	
1	2483.500	21.33	27.36	4.81	0.00	53.50	74.00	-20.50 Peak
2	2483.500	9.03	27.36	4.81	0.00	41.20	54.00	-12.80 Average

**Remark:**

1. Final Level = Receiver Read level + Antenna Factor + Cable Loss – Pre-amplifier Factor.
2. The emission levels of other frequencies are very lower than the limit and not show in test report.

<b>Product Name:</b>	balenaFin	<b>Product Model:</b>	v1.1
<b>Test By:</b>	Carey	<b>Test mode:</b>	DH1 Tx mode
<b>Test Channel:</b>	Highest channel	<b>Polarization:</b>	Horizontal
<b>Test Voltage:</b>	AC 120/60Hz	<b>Environment:</b>	Temp: 24°C Humi: 57%

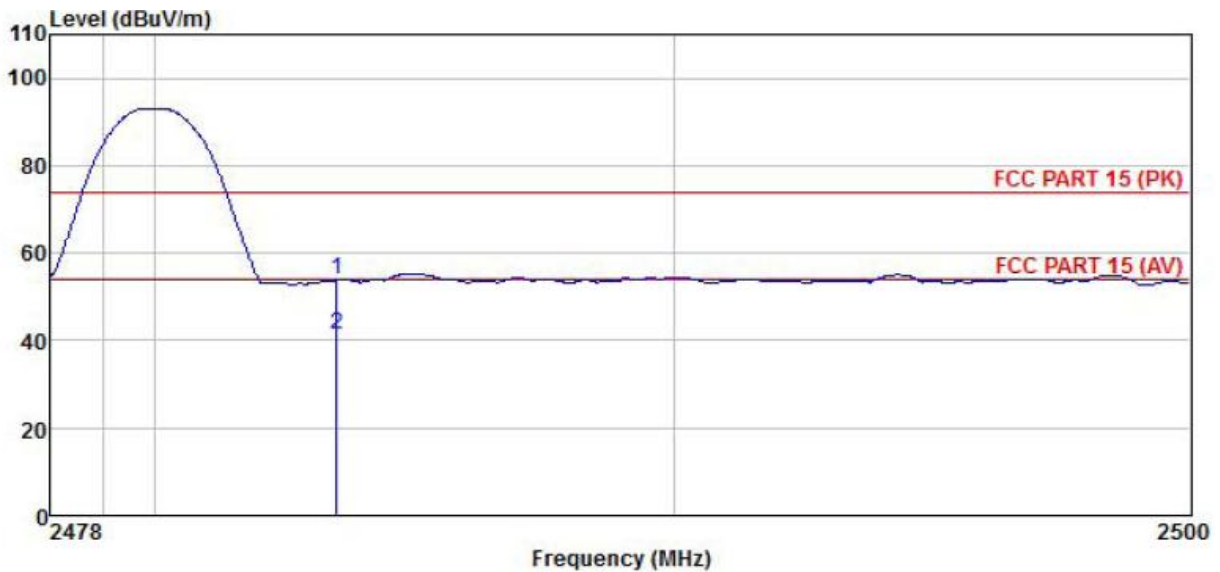

	Read	Antenna	Cable	Preamp	Limit	Over	
Freq	Level	Factor	Loss	Factor	Line	Limit	Remark
MHz	dBuV	dB/m	dB	dB	dBuV/m	dBuV/m	dB
1	2483.500	21.70	27.35	4.81	0.00	53.86	74.00 -20.14 Peak
2	2483.500	9.07	27.35	4.81	0.00	41.23	54.00 -12.77 Average

**Remark:**

1. Final Level = Receiver Read level + Antenna Factor + Cable Loss – Preamplifier Factor.
2. The emission levels of other frequencies are very lower than the limit and not show in test report.

$\pi/4$ -DQPSK mode

Product Name:	balenaFin	Product Model:	v1.1
Test By:	Carey	Test mode:	2DH1 Tx mode
Test Channel:	Lowest channel	Polarization:	Vertical
Test Voltage:	AC 120/60Hz	Environment:	Temp: 24°C Humi: 57%

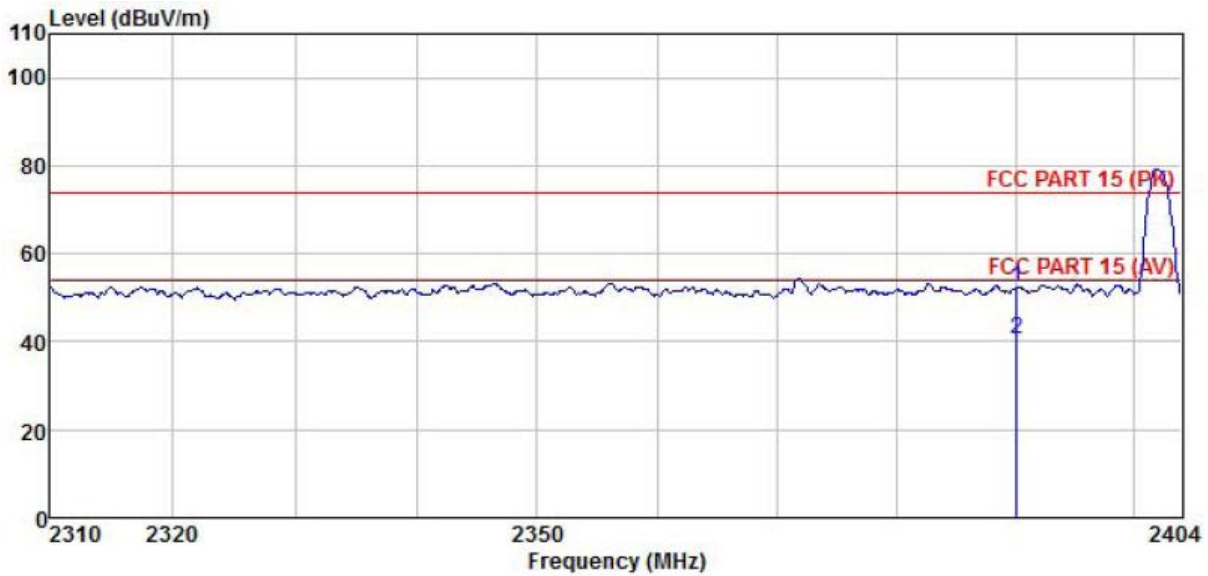

	Read	Antenna	Cable	Preamp	Limit	Over		
Freq	Level	Factor	Loss	Factor	Level	Line	Limit	
-----	-----	-----	-----	-----	-----	-----	-----	
MHz	dBuV	dB/m	dB	dB	dBuV/m	dBuV/m	dB	
1	2390.000	20.60	27.07	4.69	0.00	52.36	74.00	-21.64 Peak
2	2390.000	8.77	27.07	4.69	0.00	40.53	54.00	-13.47 Average

Remark:

1. Final Level = Receiver Read level + Antenna Factor + Cable Loss – Pre-amplifier Factor.
2. The emission levels of other frequencies are very lower than the limit and not show in test report.

<b>Product Name:</b>	balenaFin	<b>Product Model:</b>	v1.1
<b>Test By:</b>	Carey	<b>Test mode:</b>	2DH1 Tx mode
<b>Test Channel:</b>	Lowest channel	<b>Polarization:</b>	Horizontal
<b>Test Voltage:</b>	AC 120/60Hz	<b>Environment:</b>	Temp: 24°C Humi: 57%

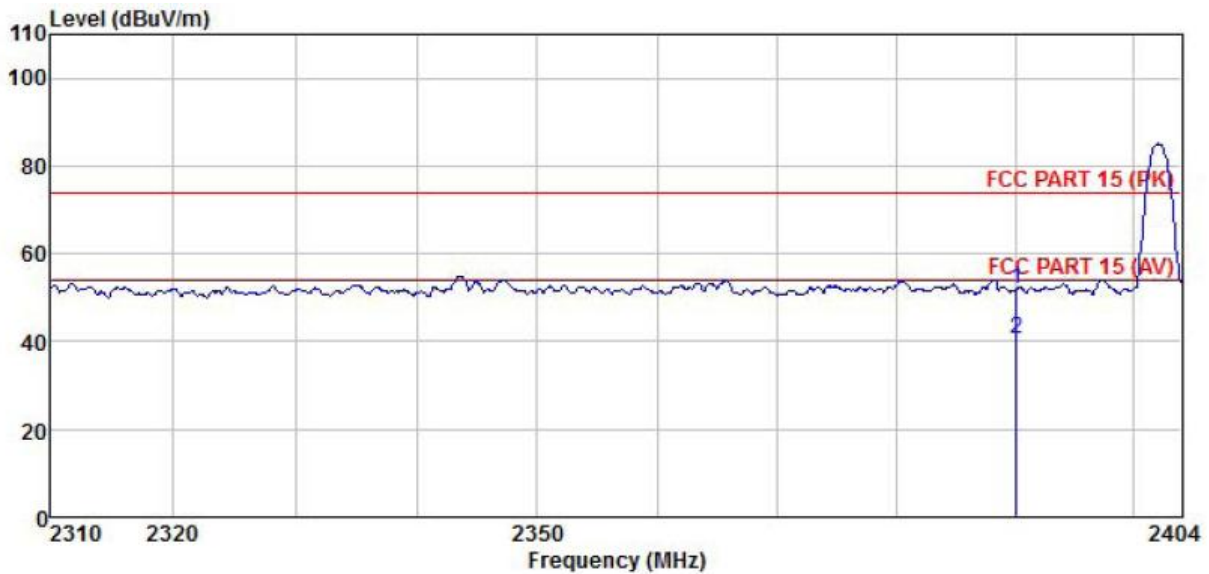

	ReadAntenna	Cable	Preamp	Limit	Over				
Freq	Level	Factor	Loss	Factor	Level	Line			
-----	-----	-----	-----	-----	-----	-----			
MHz	dBuV	dB/m	dB	dB	dBuV/m	dBuV/m			
1	2390.000	20.07	27.08	4.69	0.00	51.84	74.00	-22.16	Peak
2	2390.000	8.71	27.08	4.69	0.00	40.48	54.00	-13.52	Average

**Remark:**

1. Final Level = Receiver Read level + Antenna Factor + Cable Loss – Pre-amplifier Factor.
2. The emission levels of other frequencies are very lower than the limit and not show in test report.

<b>Product Name:</b>	balenaFin	<b>Product Model:</b>	v1.1
<b>Test By:</b>	Carey	<b>Test mode:</b>	2DH1 Tx mode
<b>Test Channel:</b>	Highest channel	<b>Polarization:</b>	Vertical
<b>Test Voltage:</b>	AC 120/60Hz	<b>Environment:</b>	Temp: 24°C Humi: 57%

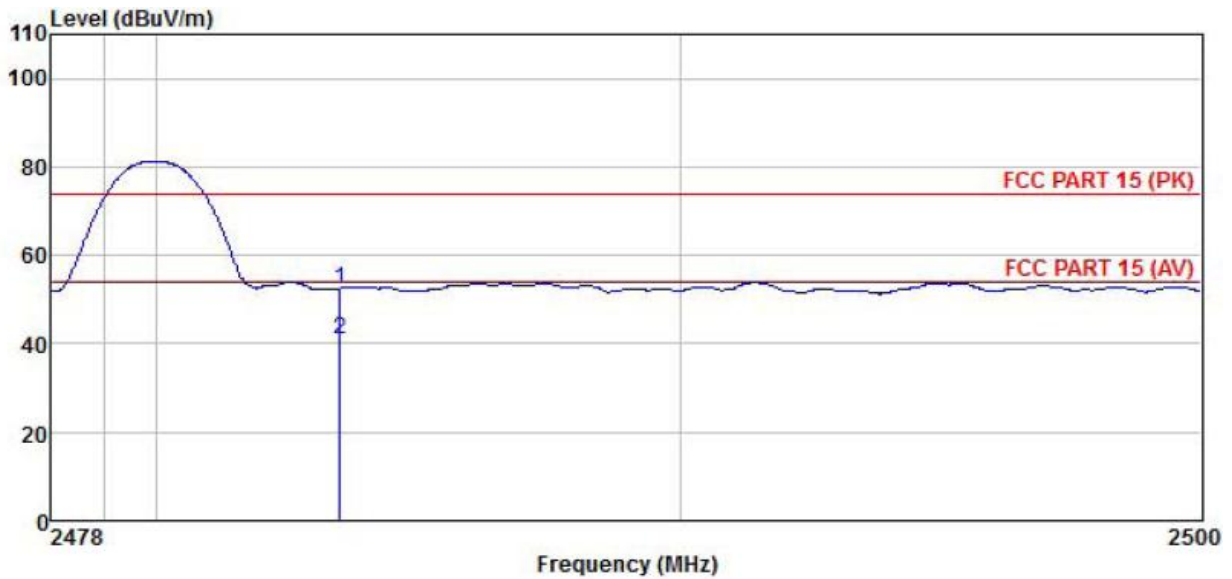

	Read	Antenna	Cable	Preamp	Limit	Over	
Freq	Level	Factor	Loss	Factor	Level	Line	Limit Remark
-----	-----	-----	-----	-----	-----	-----	-----
MHz	dBuV	dB/m	dB	dB	dBuV/m	dBuV/m	dB
1	2483.500	20.36	27.36	4.81	0.00	52.53	74.00 -21.47 Peak
2	2483.500	8.95	27.36	4.81	0.00	41.12	54.00 -12.88 Average

**Remark:**

1. Final Level = Receiver Read level + Antenna Factor + Cable Loss – Pre-amplifier Factor.
2. The emission levels of other frequencies are very lower than the limit and not show in test report.

<b>Product Name:</b>	balenaFin	<b>Product Model:</b>	v1.1
<b>Test By:</b>	Carey	<b>Test mode:</b>	2DH1 Tx mode
<b>Test Channel:</b>	Highest channel	<b>Polarization:</b>	Horizontal
<b>Test Voltage:</b>	AC 120/60Hz	<b>Environment:</b>	Temp: 24°C Humi: 57%

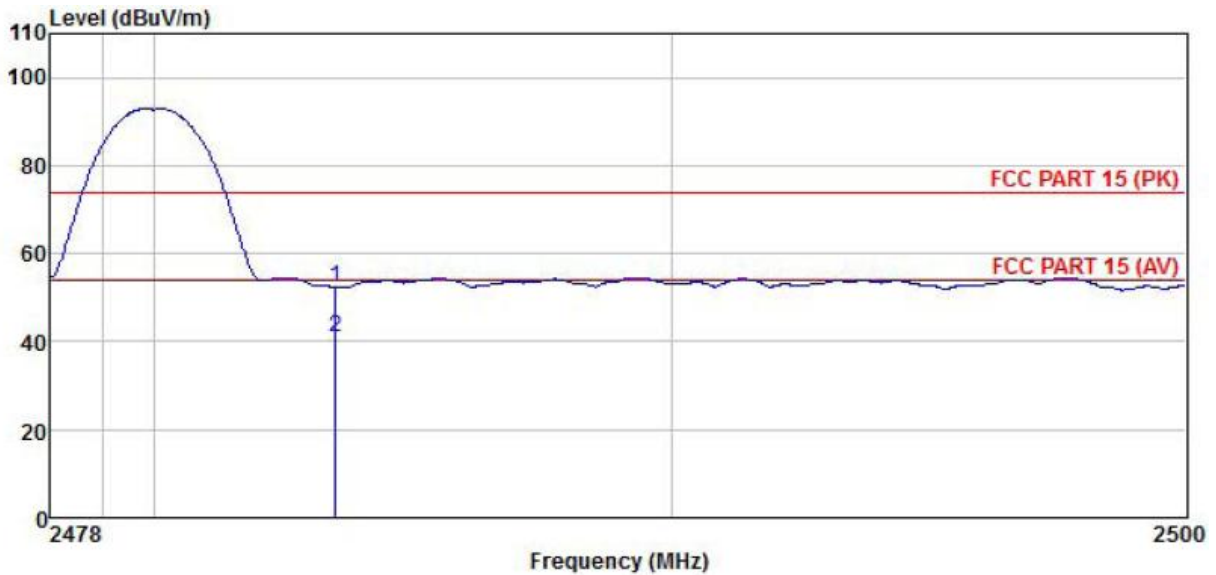

	Read	Antenna	Cable	Preamp	Limit	Over	
Freq	Level	Factor	Loss	Factor	Line	Limit	Remark
MHz	dBuV	dB/m	dB	dB	dBuV/m	dBuV/m	dB
1	2483.500	20.05	27.35	4.81	0.00	52.21	74.00 -21.79 Peak
2	2483.500	8.89	27.35	4.81	0.00	41.05	54.00 -12.95 Average

**Remark:**

1. Final Level = Receiver Read level + Antenna Factor + Cable Loss – Pre-amplifier Factor.
2. The emission levels of other frequencies are very lower than the limit and not show in test report.



**8DPSK mode**

<b>Product Name:</b>	balenaFin	<b>Product Model:</b>	v1.1
<b>Test By:</b>	Carey	<b>Test mode:</b>	3DH1 Tx mode
<b>Test Channel:</b>	Lowest channel	<b>Polarization:</b>	Vertical
<b>Test Voltage:</b>	AC 120/60Hz	<b>Environment:</b>	Temp: 24°C Huni: 57%

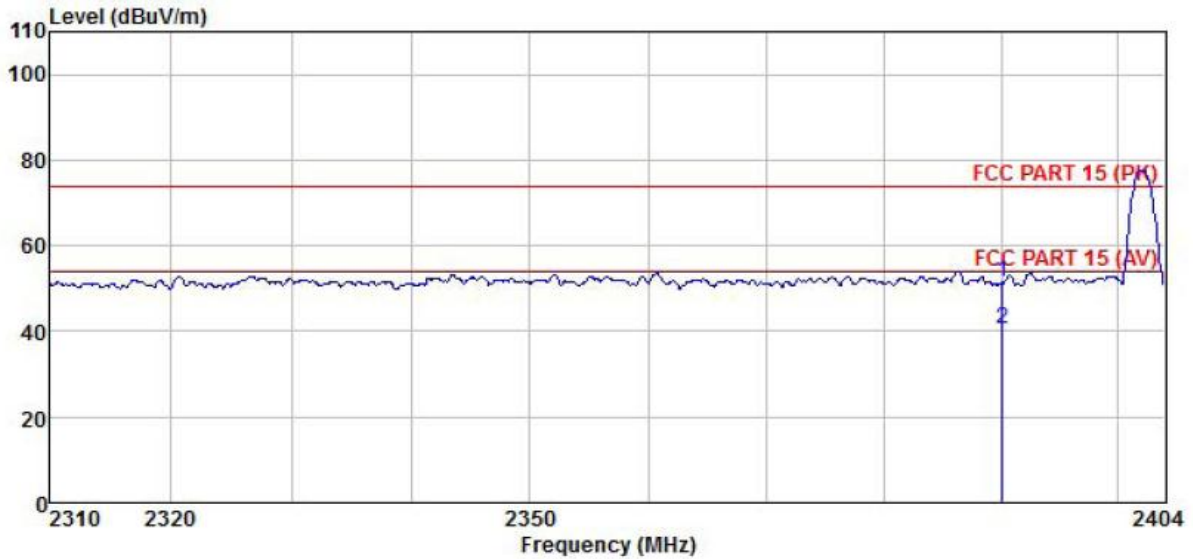

	Read Freq	Antenna Level	Antenna Factor	Cable Loss	Preamp Factor	Level	Limit Line	Over Limit	Remark
	MHz	dBuV	dB/m	dB	dB	dBuV/m	dBuV/m	dB	
1	2390.000	19.61	27.07	4.69	0.00	51.37	74.00	-22.63	Peak
2	2390.000	8.68	27.07	4.69	0.00	40.44	54.00	-13.56	Average

**Remark:**

1. Final Level = Receiver Read level + Antenna Factor + Cable Loss – Preamp Factor.
2. The emission levels of other frequencies are very lower than the limit and not show in test report.

Product Name:	balenaFin	Product Model:	v1.1
Test By:	Carey	Test mode:	3DH1 Tx mode
Test Channel:	Lowest channel	Polarization:	Horizontal
Test Voltage:	AC 120/60Hz	Environment:	Temp: 24°C Humi: 57%

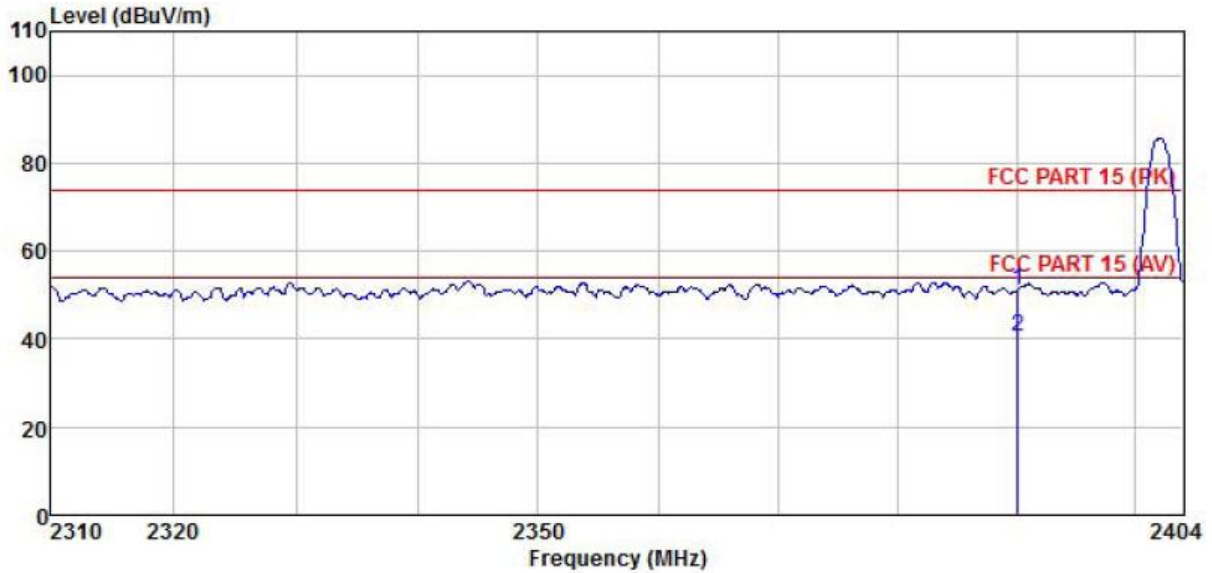

	Read	Antenna	Cable	Preamp	Limit	Over		
Freq	Level	Factor	Loss	Factor	Level	Line	Limit	Remark
MHz	dBuV	dB/m	dB	dB	dBuV/m	dBuV/m	dB	
1	2390.000	19.19	27.08	4.69	0.00	50.96	74.00	-23.04 Peak
2	2390.000	8.69	27.08	4.69	0.00	40.46	54.00	-13.54 Average

**Remark:**

1. Final Level = Receiver Read level + Antenna Factor + Cable Loss – Pre-amplifier Factor.
2. The emission levels of other frequencies are very lower than the limit and not show in test report.

<b>Product Name:</b>	balenaFin	<b>Product Model:</b>	v1.1
<b>Test By:</b>	Carey	<b>Test mode:</b>	3DH1 Tx mode
<b>Test Channel:</b>	Highest channel	<b>Polarization:</b>	Vertical
<b>Test Voltage:</b>	AC 120/60Hz	<b>Environment:</b>	Temp: 24°C Huni: 57%

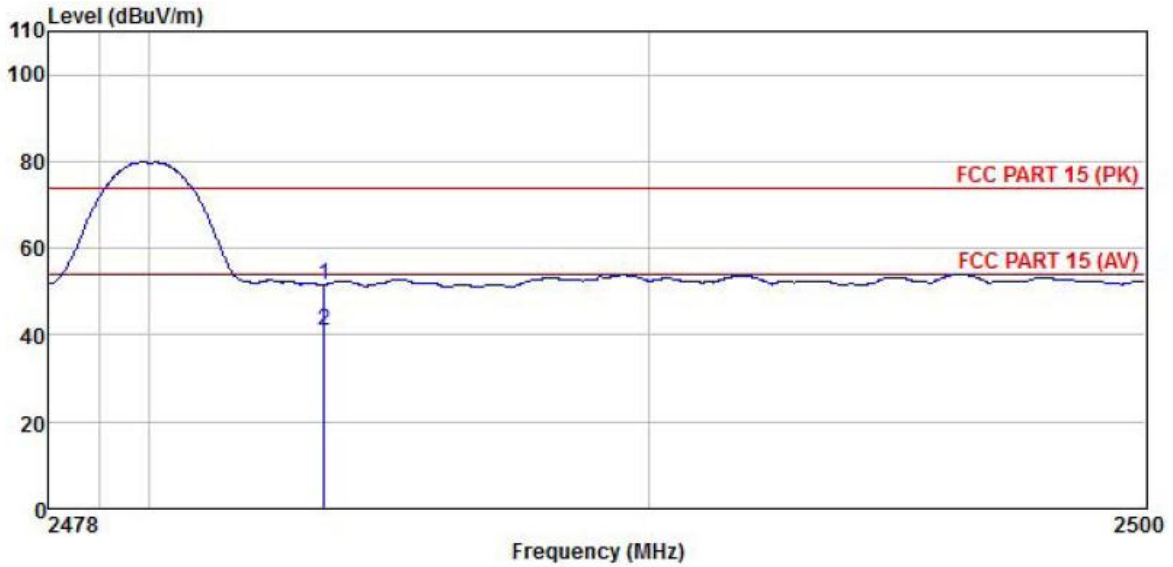

	Read	Antenna	Cable	Preamp	Limit	Over	
Freq	Level	Factor	Loss	Factor	Line	Limit	Remark
MHz	dBuV	dB/m	dB	dB	dBuV/m	dBuV/m	dB
1	2483.500	19.38	27.36	4.81	0.00	51.55	74.00 -22.45 Peak
2	2483.500	8.94	27.36	4.81	0.00	41.11	54.00 -12.89 Average

**Remark:**

1. Final Level = Receiver Read level + Antenna Factor + Cable Loss – Pre-amplifier Factor.
2. The emission levels of other frequencies are very lower than the limit and not show in test report.

<b>Product Name:</b>	balenaFin	<b>Product Model:</b>	v1.1
<b>Test By:</b>	Carey	<b>Test mode:</b>	3DH1 Tx mode
<b>Test Channel:</b>	Highest channel	<b>Polarization:</b>	Horizontal
<b>Test Voltage:</b>	AC 120/60Hz	<b>Environment:</b>	Temp: 24°C Huni: 57%

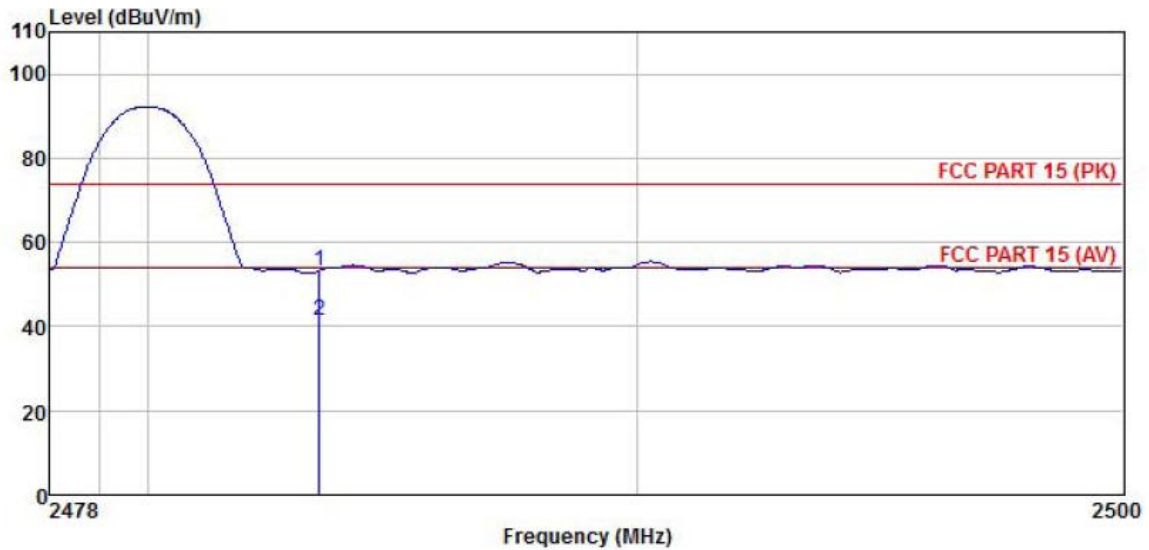

	Read	Antenna	Cable	Preamp	Limit	Over		
Freq	Level	Factor	Loss	Factor	Level	Line	Limit	
-----	-----	-----	-----	-----	-----	-----	-----	
MHz	dBuV	dB/m	dB	dB	dBuV/m	dBuV/m	dB	
1	2483.500	21.17	27.35	4.81	0.00	53.33	74.00	-20.67 Peak
2	2483.500	9.05	27.35	4.81	0.00	41.21	54.00	-12.79 Average

**Remark:**

1. Final Level = Receiver Read level + Antenna Factor + Cable Loss – Preamplifier Factor.
2. The emission levels of other frequencies are very lower than the limit and not show in test report.

**External Antenna**

**GFSK Mode:**

<b>Product Name:</b>	balenaFin	<b>Product Model:</b>	v1.1
<b>Test By:</b>	Carey	<b>Test mode:</b>	DH1 Tx mode
<b>Test Channel:</b>	Lowest channel	<b>Polarization:</b>	Vertical
<b>Test Voltage:</b>	AC 120/60Hz	<b>Environment:</b>	Temp: 24°C Humi: 57%

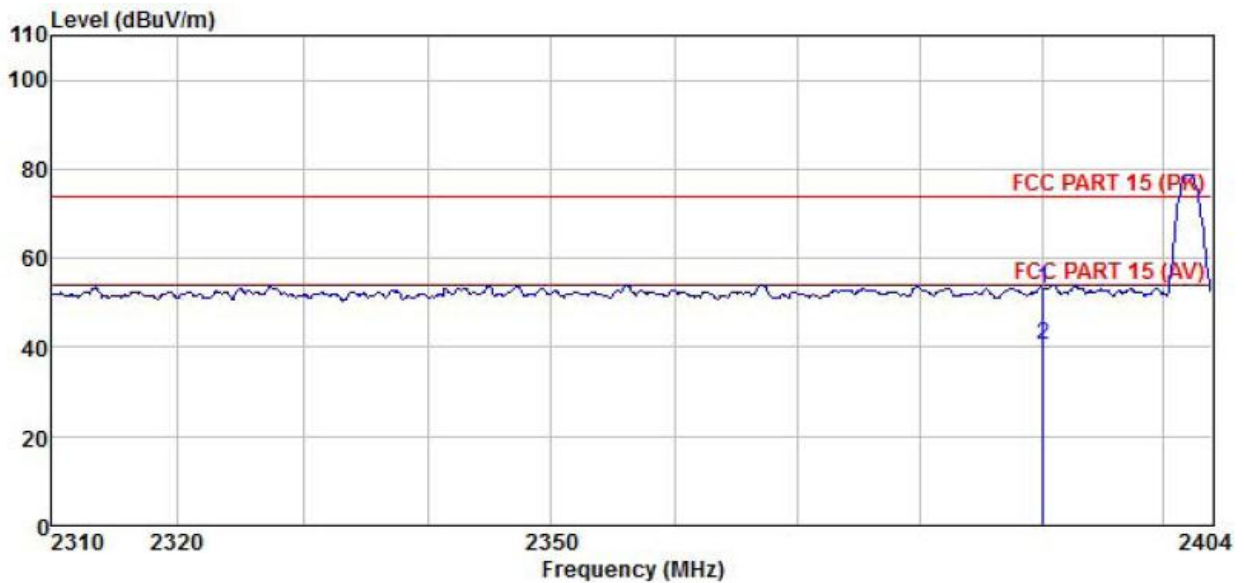

	Read	Antenna	Cable	Preamp	Limit	Over		
Freq	Level	Factor	Loss	Factor	Line	Limit	Remark	
MHz	dBuV	dB/m	dB	dB	dBuV/m	dBuV/m	dB	
1	2390.000	21.52	27.07	4.69	0.00	53.28	74.00	-20.72 Peak
2	2390.000	8.78	27.07	4.69	0.00	40.54	54.00	-13.46 Average

**Remark:**

- Final Level = Receiver Read level + Antenna Factor + Cable Loss – Preamplifier Factor.
- The emission levels of other frequencies are very lower than the limit and not show in test report.

Product Name:	balenaFin	Product Model:	v1.1
Test By:	Carey	Test mode:	DH1 Tx mode
Test Channel:	Lowest channel	Polarization:	Horizontal
Test Voltage:	AC 120/60Hz	Environment:	Temp: 24°C Huni: 57%

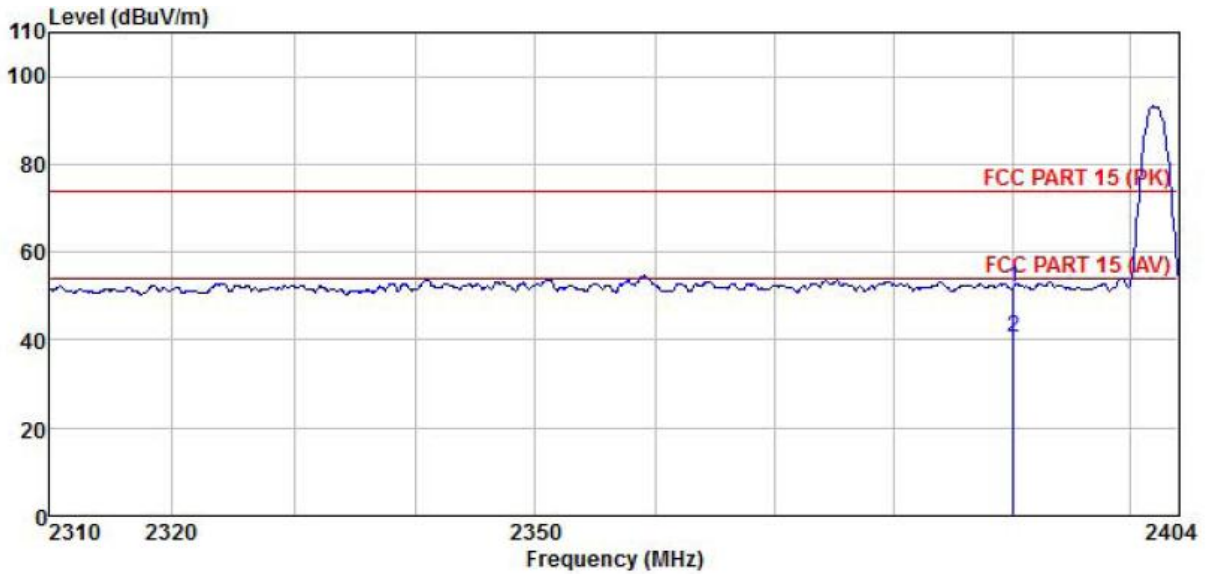

	Read	Antenna	Cable	Preamp	Limit	Over		
Freq	Level	Factor	Loss	Factor	Level	Line	Limit	Remark
-----	-----	-----	-----	-----	-----	-----	-----	-----
MHz	dBuV	dB/m	dB	dB	dBuV/m	dBuV/m	dB	
1	2390.000	20.34	27.08	4.69	0.00	52.11	74.00	-21.89 Peak
2	2390.000	8.77	27.08	4.69	0.00	40.54	54.00	-13.46 Average

Remark:

- Final Level = Receiver Read level + Antenna Factor + Cable Loss – Preamplifier Factor.
- The emission levels of other frequencies are very lower than the limit and not show in test report.

<b>Product Name:</b>	balenaFin	<b>Product Model:</b>	v1.1
<b>Test By:</b>	Carey	<b>Test mode:</b>	DH1 Tx mode
<b>Test Channel:</b>	Highest channel	<b>Polarization:</b>	Vertical
<b>Test Voltage:</b>	AC 120/60Hz	<b>Environment:</b>	Temp: 24°C Humi: 57%

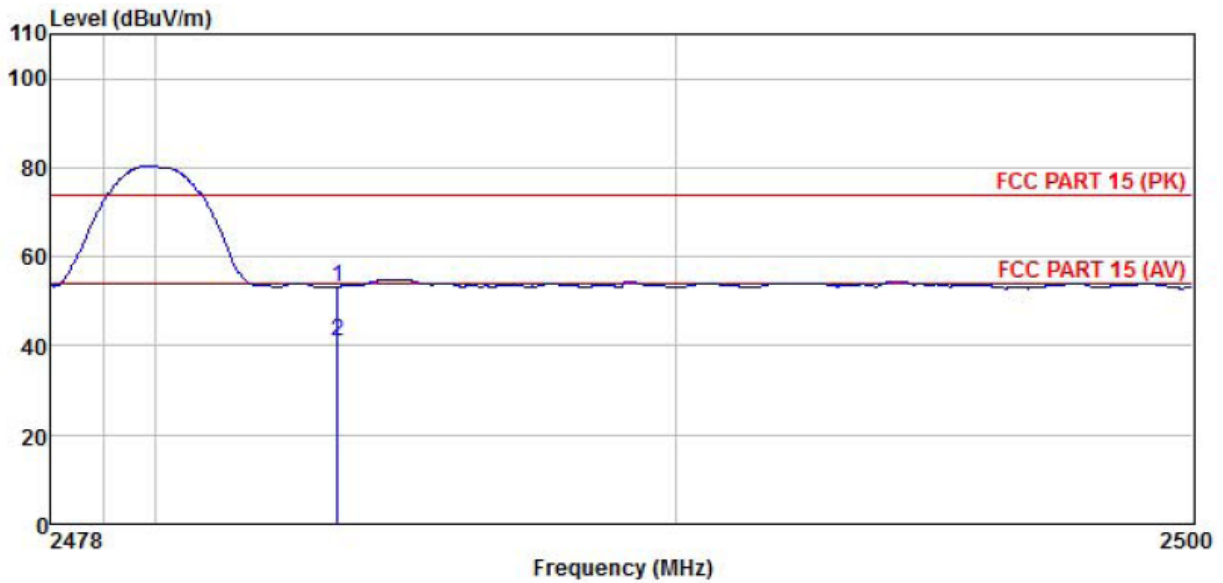

	ReadAntenna	Cable	Preamp	Limit	Over				
Freq	Level	Factor	Loss	Factor	Level	Line			
MHz	dBuV	dB/m	dB	dB	dBuV/m	dBuV/m			
1	2483.500	21.13	27.36	4.81	0.00	53.30	74.00	-20.70	Peak
2	2483.500	9.03	27.36	4.81	0.00	41.20	54.00	-12.80	Average

**Remark:**

- Final Level = Receiver Read level + Antenna Factor + Cable Loss – Pre-amplifier Factor.
- The emission levels of other frequencies are very lower than the limit and not show in test report.

<b>Product Name:</b>	balenaFin	<b>Product Model:</b>	v1.1
<b>Test By:</b>	Carey	<b>Test mode:</b>	DH1 Tx mode
<b>Test Channel:</b>	Highest channel	<b>Polarization:</b>	Horizontal
<b>Test Voltage:</b>	AC 120/60Hz	<b>Environment:</b>	Temp: 24°C Huni: 57%

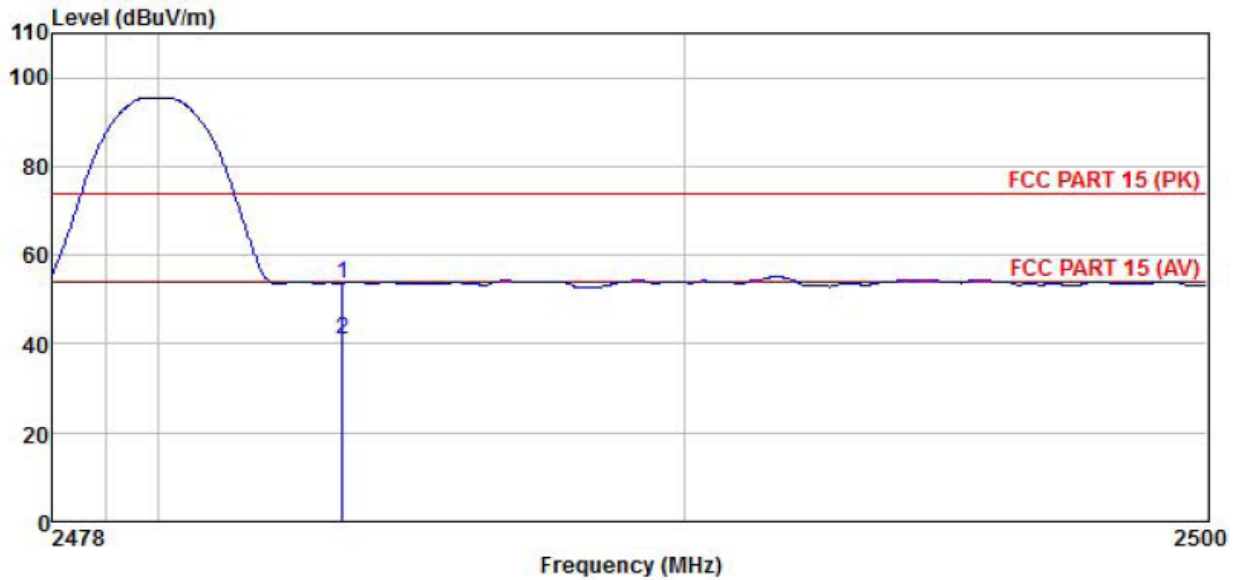

	ReadAntenna	Cable Preamp	Limit	Over					
Freq	Level	Factor	Loss	Factor	Level				
-----	-----	-----	-----	-----	-----				
MHz	dBuV	dB/m	dB	dB	dBuV/m				
1	2483.500	21.53	27.35	4.81	0.00	53.69	74.00	-20.31	Peak
2	2483.500	8.97	27.35	4.81	0.00	41.13	54.00	-12.87	Average

**Remark:**

- Final Level = Receiver Read level + Antenna Factor + Cable Loss – Preamplifier Factor.
- The emission levels of other frequencies are very lower than the limit and not show in test report.



π/4-DQPSK mode

Product Name:	balenaFin	Product Model:	v1.1
Test By:	Carey	Test mode:	2DH1 Tx mode
Test Channel:	Lowest channel	Polarization:	Vertical
Test Voltage:	AC 120/60Hz	Environment:	Temp: 24°C Humi: 57%

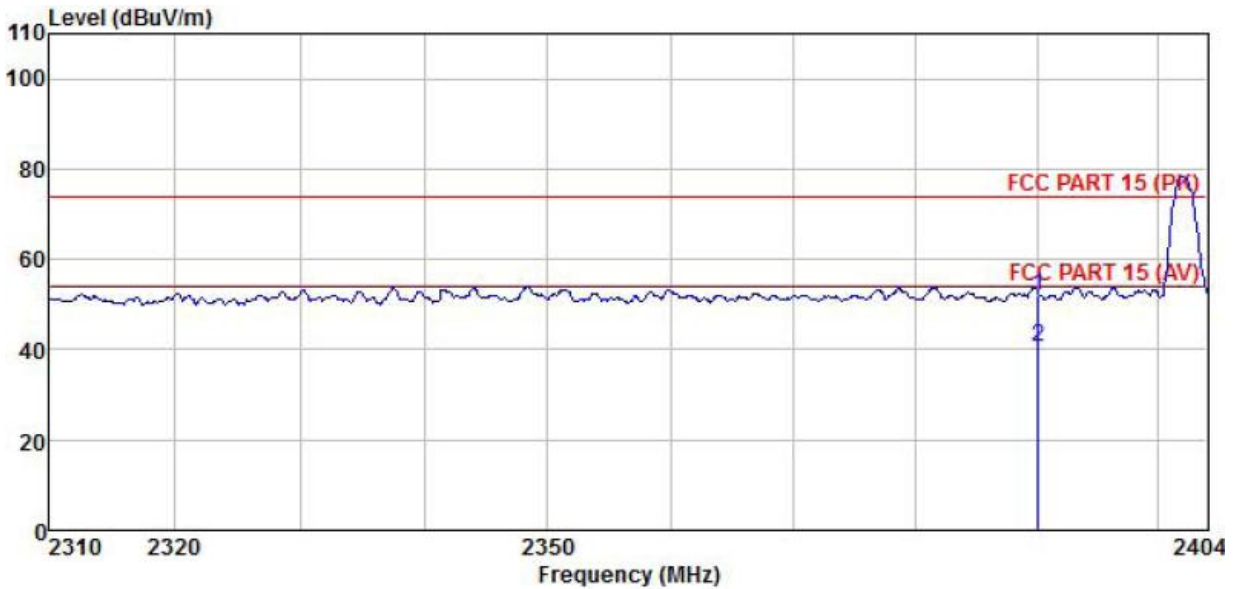

	Read	Antenna	Cable	Preamp	Limit	Over	
Freq	Level	Factor	Loss	Factor	Line	Limit	Remark
-----	-----	-----	-----	-----	-----	-----	-----
MHz	dBuV	dB/m	dB	dB	dBuV/m	dBuV/m	dB
1	2390.000	20.28	27.07	4.69	0.00	52.04	74.00 -21.96 Peak
2	2390.000	8.71	27.07	4.69	0.00	40.47	54.00 -13.53 Average

Remark:

- Final Level = Receiver Read level + Antenna Factor + Cable Loss – Pre-amplifier Factor.
- The emission levels of other frequencies are very lower than the limit and not show in test report.

<b>Product Name:</b>	balenaFin	<b>Product Model:</b>	v1.1
<b>Test By:</b>	Carey	<b>Test mode:</b>	2DH1 Tx mode
<b>Test Channel:</b>	Lowest channel	<b>Polarization:</b>	Horizontal
<b>Test Voltage:</b>	AC 120/60Hz	<b>Environment:</b>	Temp: 24°C Huni: 57%

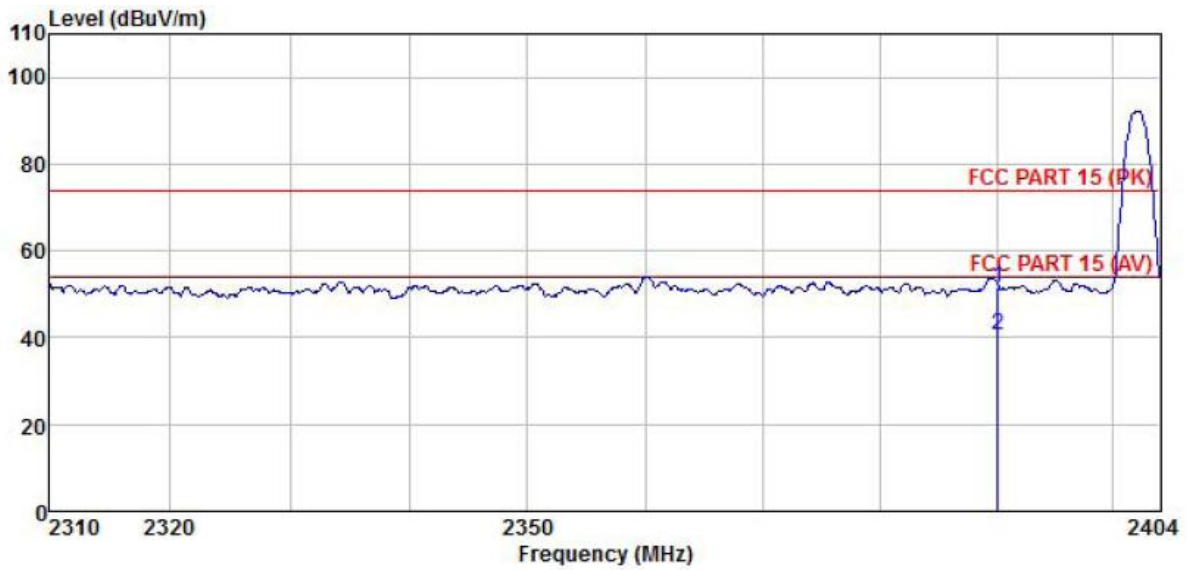

	Read Freq	Antenna Level	Antenna Factor	Cable Loss	Preamp Factor	Level	Limit	Over	Remark
	MHz	dBuV	dB/m	dB	dB	dBuV/m	dBuV/m	dB	
1	2390.000	19.93	27.08	4.69	0.00	51.70	74.00	-22.30	Peak
2	2390.000	8.68	27.08	4.69	0.00	40.45	54.00	-13.55	Average

**Remark:**

- Final Level = Receiver Read level + Antenna Factor + Cable Loss – Pre-amplifier Factor.
- The emission levels of other frequencies are very lower than the limit and not show in test report.

<b>Product Name:</b>	balenaFin	<b>Product Model:</b>	v1.1
<b>Test By:</b>	Carey	<b>Test mode:</b>	2DH1 Tx mode
<b>Test Channel:</b>	Highest channel	<b>Polarization:</b>	Vertical
<b>Test Voltage:</b>	AC 120/60Hz	<b>Environment:</b>	Temp: 24°C Huni: 57%

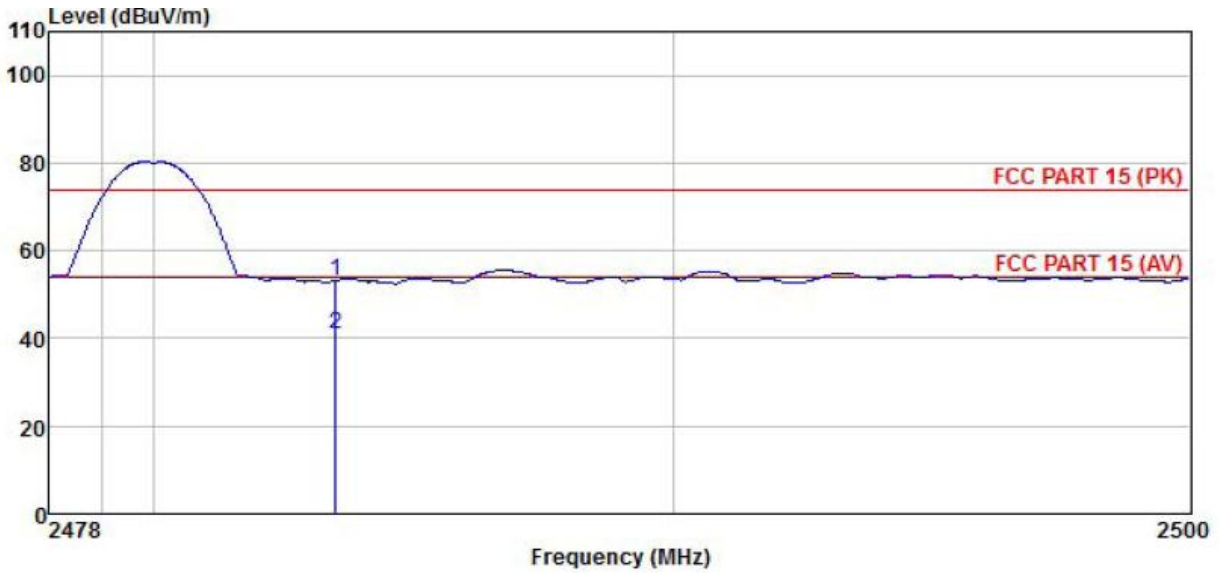

	Read	Antenna	Cable	Preamp	Limit	Over	
Freq	Level	Factor	Loss	Factor	Level	Line	Limit Remark
MHz	dBuV	dB/m	dB	dB	dBuV/m	dBuV/m	dB
1	2483.500	21.08	27.36	4.81	0.00	53.25	74.00 -20.75 Peak
2	2483.500	8.98	27.36	4.81	0.00	41.15	54.00 -12.85 Average

**Remark:**

- Final Level = Receiver Read level + Antenna Factor + Cable Loss – Pre-amplifier Factor.
- The emission levels of other frequencies are very lower than the limit and not show in test report.

<b>Product Name:</b>	balenaFin	<b>Product Model:</b>	v1.1
<b>Test By:</b>	Carey	<b>Test mode:</b>	2DH1 Tx mode
<b>Test Channel:</b>	Highest channel	<b>Polarization:</b>	Horizontal
<b>Test Voltage:</b>	AC 120/60Hz	<b>Environment:</b>	Temp: 24°C Humi: 57%

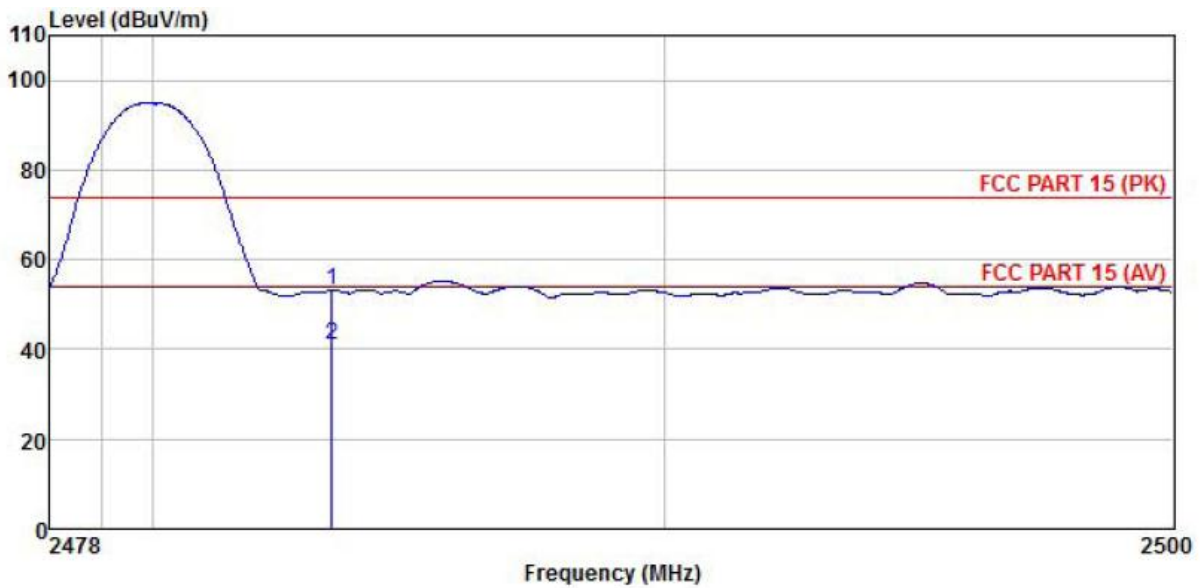

	ReadAntenna	Cable Preamp	Limit	Over					
Freq	Level	Factor	Loss	Factor	Level				
-----	-----	-----	-----	-----	-----				
MHz	dBuV	dB/m	dB	dB	dBuV/m				
1	2483.500	20.88	27.35	4.81	0.00	53.04	74.00	-20.96	Peak
2	2483.500	8.89	27.35	4.81	0.00	41.05	54.00	-12.95	Average

**Remark:**

- Final Level = Receiver Read level + Antenna Factor + Cable Loss – Preamplifier Factor.
- The emission levels of other frequencies are very lower than the limit and not show in test report.

**8DPSK mode**

<b>Product Name:</b>	balenaFin	<b>Product Model:</b>	v1.1
<b>Test By:</b>	Carey	<b>Test mode:</b>	3DH1 Tx mode
<b>Test Channel:</b>	Lowest channel	<b>Polarization:</b>	Vertical
<b>Test Voltage:</b>	AC 120/60Hz	<b>Environment:</b>	Temp: 24°C Humi: 57%

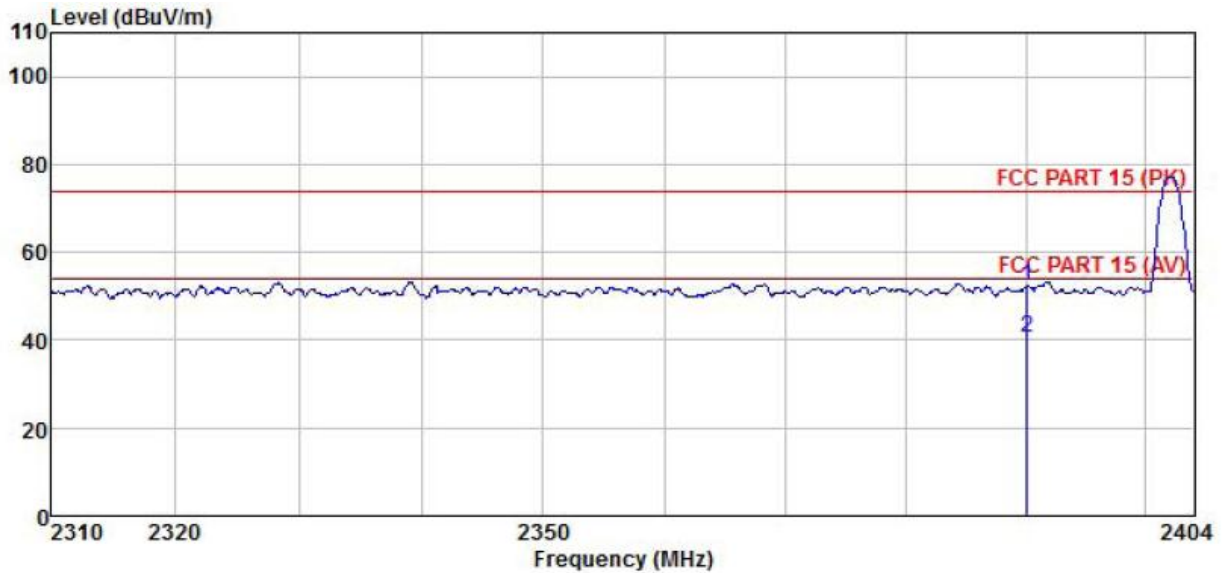

	Read	Antenna	Cable	Preamp	Limit	Over		
Freq	Level	Factor	Loss	Factor	Level	Line	Limit	Remark
-----	-----	-----	-----	-----	-----	-----	-----	-----
MHz	dBuV	dB/m	dB	dB	dBuV/m	dBuV/m	dB	
1	2390.000	20.58	27.07	4.69	0.00	52.34	74.00	-21.66 Peak
2	2390.000	8.73	27.07	4.69	0.00	40.49	54.00	-13.51 Average

**Remark:**

- Final Level = Receiver Read level + Antenna Factor + Cable Loss – Preamplifier Factor.
- The emission levels of other frequencies are very lower than the limit and not show in test report.

Product Name:	balenaFin	Product Model:	v1.1
Test By:	Carey	Test mode:	3DH1 Tx mode
Test Channel:	Lowest channel	Polarization:	Horizontal
Test Voltage:	AC 120/60Hz	Environment:	Temp: 24°C Humi: 57%

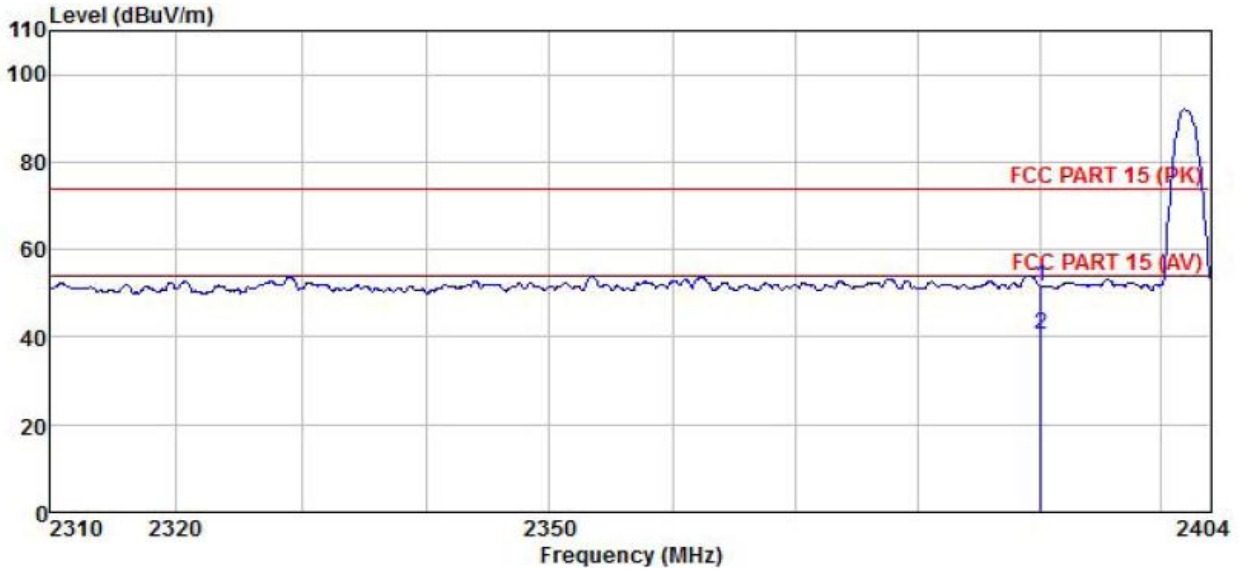

	Read	Antenna	Cable	Preamp	Limit	Over	
Freq	Level	Factor	Loss	Factor	Level	Line	Limit Remark
-----	-----	-----	-----	-----	-----	-----	-----
MHz	dBuV	dB/m	dB	dB	dBuV/m	dBuV/m	dB
1	2390.000	19.79	27.08	4.69	0.00	51.56	74.00 -22.44 Peak
2	2390.000	8.67	27.08	4.69	0.00	40.44	54.00 -13.56 Average

Remark:

- Final Level = Receiver Read level + Antenna Factor + Cable Loss – Pre-amplifier Factor.
- The emission levels of other frequencies are very lower than the limit and not show in test report.

<b>Product Name:</b>	balenaFin	<b>Product Model:</b>	v1.1
<b>Test By:</b>	Carey	<b>Test mode:</b>	3DH1 Tx mode
<b>Test Channel:</b>	Highest channel	<b>Polarization:</b>	Vertical
<b>Test Voltage:</b>	AC 120/60Hz	<b>Environment:</b>	Temp: 24°C Humi: 57%

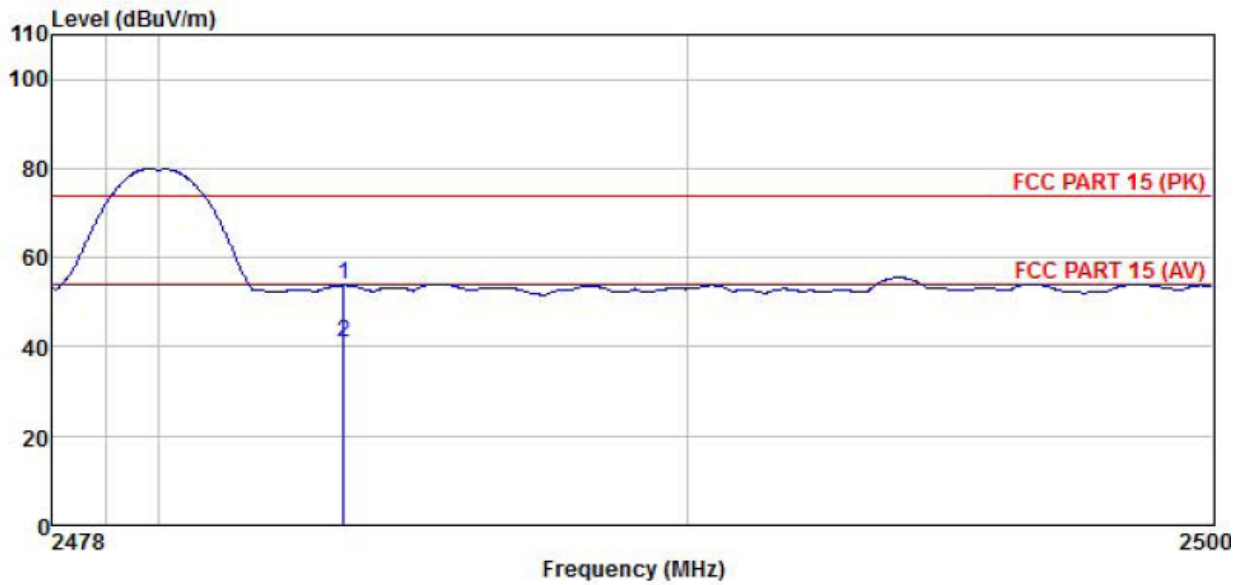

	Read	Antenna	Cable	Preamp	Limit	Over		
Freq	Level	Factor	Loss	Factor	Level	Line	Limit	
-----	-----	-----	-----	-----	-----	-----	-----	
MHz	dBuV	dB/m	dB	dB	dBuV/m	dBuV/m	dB	
1	2483.500	21.63	27.36	4.81	0.00	53.80	74.00	-20.20 Peak
2	2483.500	9.01	27.36	4.81	0.00	41.18	54.00	-12.82 Average

**Remark:**

- Final Level = Receiver Read level + Antenna Factor + Cable Loss – Preamplifier Factor.
- The emission levels of other frequencies are very lower than the limit and not show in test report.

<b>Product Name:</b>	balenaFin	<b>Product Model:</b>	v1.1
<b>Test By:</b>	Carey	<b>Test mode:</b>	3DH1 Tx mode
<b>Test Channel:</b>	Highest channel	<b>Polarization:</b>	Horizontal
<b>Test Voltage:</b>	AC 120/60Hz	<b>Environment:</b>	Temp: 24°C Huni: 57%

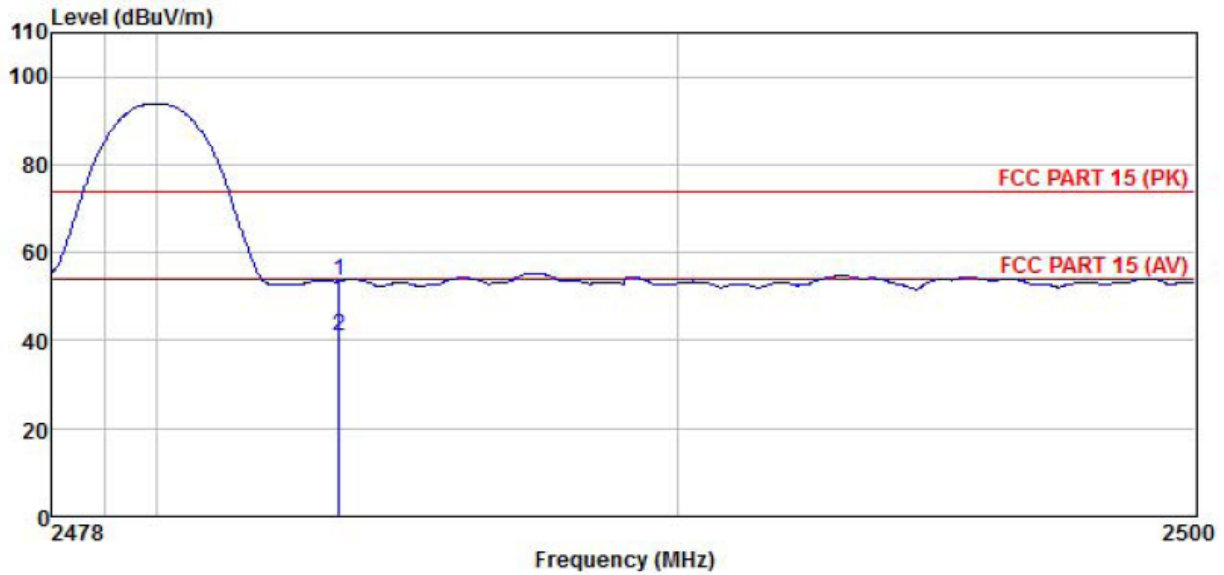

	ReadAntenna	Cable Preamp	Limit	Over					
Freq	Level	Factor	Loss	Factor	Level				
-----	-----	-----	-----	-----	-----				
MHz	dBuV	dB/m	dB	dB	dBuV/m				
1	2483.500	21.38	27.35	4.81	0.00	53.54	74.00	-20.46	Peak
2	2483.500	9.00	27.35	4.81	0.00	41.16	54.00	-12.84	Average

**Remark:**

- Final Level = Receiver Read level + Antenna Factor + Cable Loss – Pre-amplifier Factor.
- The emission levels of other frequencies are very lower than the limit and not show in test report.



## 6.10 Spurious Emission

### 6.10.1 Conducted Emission Method

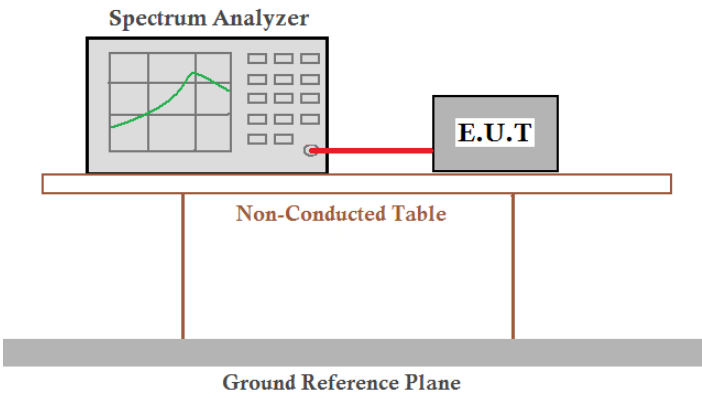
Test Requirement:	FCC Part 15 C Section 15.247 (d)
Limit:	In any 100 kHz bandwidth outside the frequency band in which the spread spectrum intentional radiator is operating, the radio frequency power that is produced by the intentional radiator shall be at least 20 dB below that in the 100 kHz bandwidth within the band that contains the highest level of the desired power, based on either an RF conducted or a radiated measurement.
Test setup:	 <p>The diagram illustrates the test setup. A Spectrum Analyzer is connected to an E.U.T. (Equipment Under Test) via a red cable. Both the Spectrum Analyzer and the E.U.T. are placed on a Non-Conducted Table. The table is supported by two vertical legs and sits on a Ground Reference Plane.</p>
Test Instruments:	Refer to section 5.9 for details
Test mode:	Non-hopping mode
Test results:	Pass

Test plot as follows:

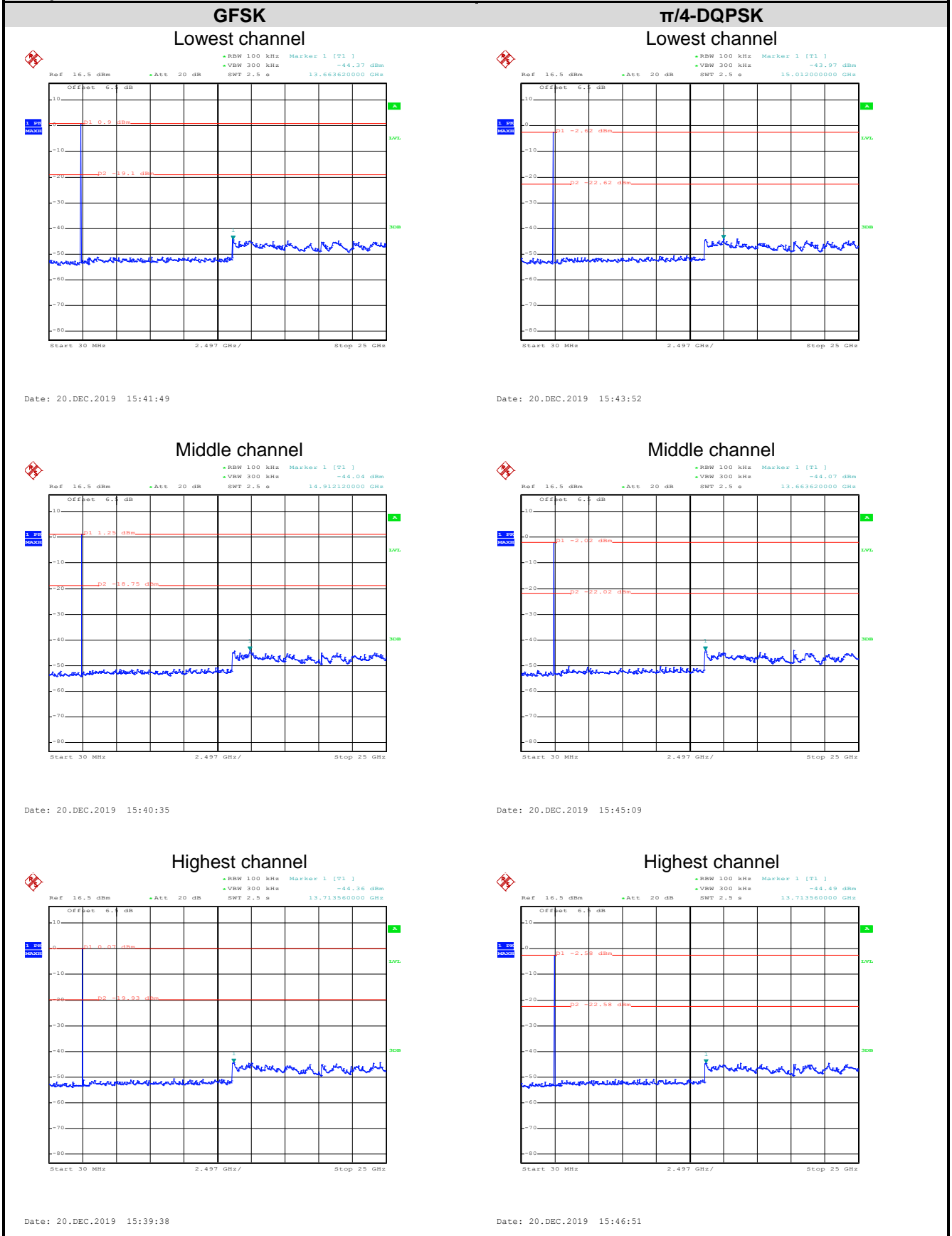

## 8DPSK

### Lowest channel

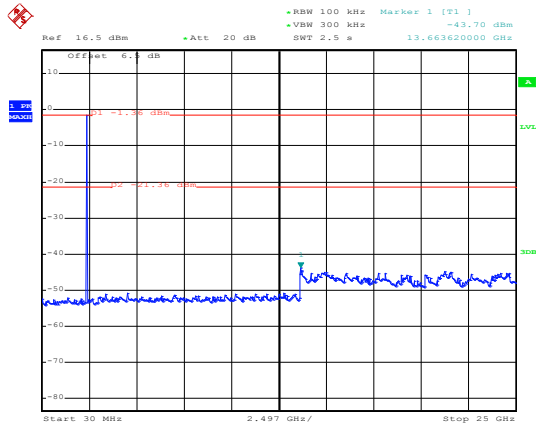

Date: 20.DEC.2019 15:51:38

### Middle channel

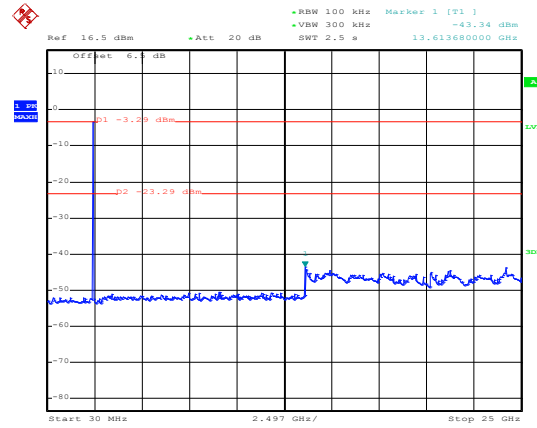

Date: 20.DEC.2019 15:50:28

### Highest channel

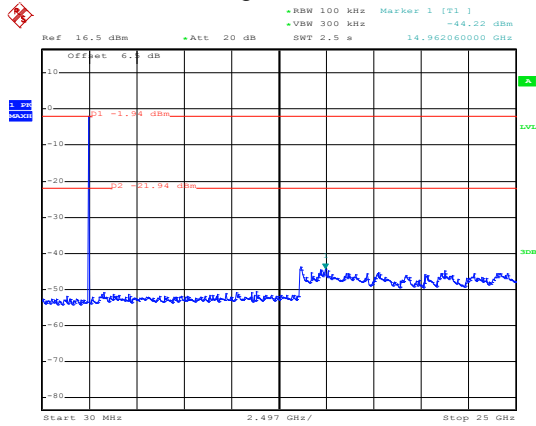

Date: 20.DEC.2019 15:47:53

## 6.10.2 Radiated Emission Method

Test Requirement:	FCC Part 15 C Section 15.209				
Test Frequency Range:	9 kHz to 25 GHz				
Test Distance:	3m				
Receiver setup:	Frequency	Detector	RBW	VBW	Remark
	30MHz-1GHz	Quasi-peak	120kHz	300kHz	Quasi-peak Value
	Above 1GHz	Peak	1MHz	3MHz	Peak Value
		RMS	1MHz	3MHz	Average Value
Limit:	Frequency	Limit (dBuV/m @3m)		Remark	
	30MHz-88MHz	40.0		Quasi-peak Value	
	88MHz-216MHz	43.5		Quasi-peak Value	
	216MHz-960MHz	46.0		Quasi-peak Value	
	Above 1GHz	54.0		Average Value	
		74.0		Peak Value	
Test setup:	Below 1GHz				
Test setup:	Above 1GHz				
Test Procedure:	<ol style="list-style-type: none"> <li>The EUT was placed on the top of a rotating table 0.8m(below 1GHz) /1.5m(above 1GHz) above the ground at a 3 meter chamber. The table was rotated 360 degrees to determine the position of the highest radiation.</li> <li>The EUT was set 3 meters away from the interference-receiving antenna, which was mounted on the top of a variable-height antenna</li> </ol>				

	<p>tower.</p> <ol style="list-style-type: none"> <li>3. The antenna height is varied from one meter to four meters above the ground to determine the maximum value of the field strength. Both horizontal and vertical polarizations of the antenna are set to make the measurement.</li> <li>4. For each suspected emission, the EUT was arranged to its worst case and then the antenna was tuned to heights from 1 meter to 4 meters and the rota table was turned from 0 degrees to 360 degrees to find the maximum reading.</li> <li>5. The test-receiver system was set to Peak Detect Function and Specified Bandwidth with Maximum Hold Mode.</li> <li>6. If the emission level of the EUT in peak mode was 10dB lower than the limit specified, then testing could be stopped and the peak values of the EUT would be reported. Otherwise the emissions that did not have 10dB margin would be re-tested one by one using peak, quasi-peak or average method as specified and then reported in a data sheet.</li> </ol>
Test Instruments:	Refer to section 5.9 for details
Test mode:	Non-hopping mode
Test results:	Pass
Remark:	<ol style="list-style-type: none"> <li>1. Pre-scan all kind of the place mode (X-axis, Y-axis, Z-axis), and found the Y-axis is the worst case.</li> <li>2. 9 kHz to 30 MHz is noise floor, so only shows the data of above 30MHz in this report.</li> </ol>

**Measurement Data (worst case):**  
**Below 1GHz: (External antenna worst case)**

<b>Product Name:</b>	balenaFin	<b>Product Model:</b>	v1.1
<b>Test By:</b>	Carey	<b>Test mode:</b>	BT Tx mode
<b>Test Frequency:</b>	30 MHz ~ 1 GHz	<b>Polarization:</b>	Vertical
<b>Test Voltage:</b>	AC 120/60Hz	<b>Environment:</b>	Temp: 24°C Humi: 57%

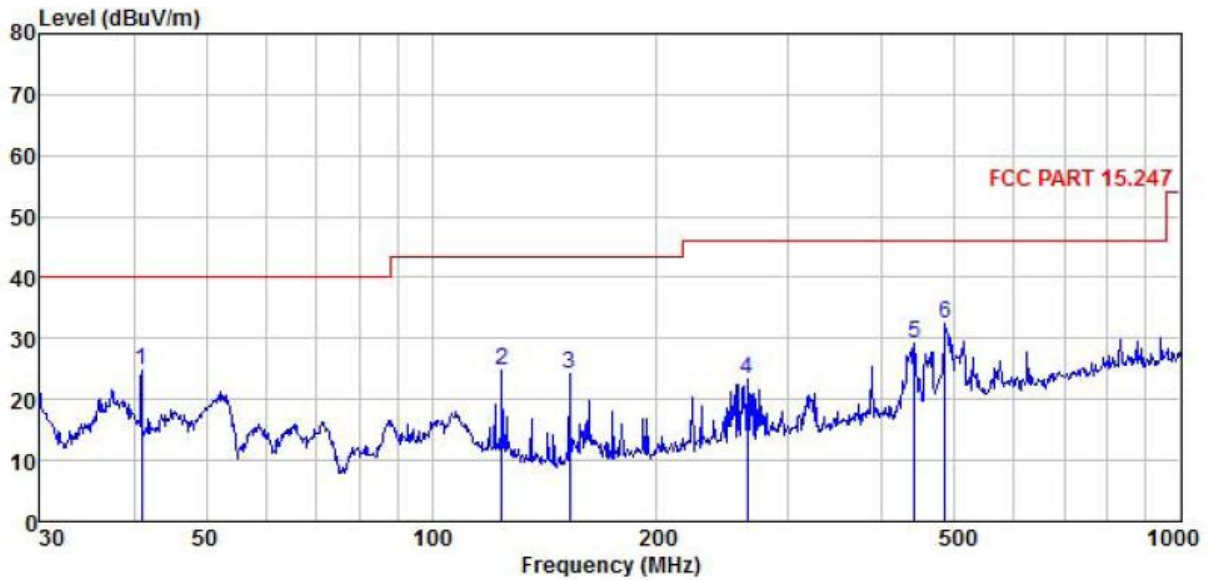

	Read	Antenna	Cable	Preamp	Limit	Over	
Freq	Level	Factor	Loss	Factor	Level	Line	Limit Remark
MHz	dBuV	dB/m	dB	dB	dBuV/m	dBuV/m	dB
1	40.988	41.22	12.38	1.22	29.89	24.93	40.00 -15.07 QP
2	124.133	41.21	10.59	2.21	29.36	24.65	43.50 -18.85 QP
3	152.664	41.82	9.00	2.53	29.20	24.15	43.50 -19.35 QP
4	263.819	36.15	12.97	2.85	28.51	23.46	46.00 -22.54 QP
5	441.743	38.70	16.29	3.18	28.86	29.31	46.00 -16.69 QP
6	485.609	40.16	17.72	3.50	28.93	32.45	46.00 -13.55 QP

**Remark:**

1. Final Level = Receiver Read level + Antenna Factor + Cable Loss – Pre-amplifier Factor.
2. The emission levels of other frequencies are very lower than the limit and not show in test report.

<b>Product Name:</b>	balenaFin	<b>Product Model:</b>	v1.1
<b>Test By:</b>	Carey	<b>Test mode:</b>	BT Tx mode
<b>Test Frequency:</b>	30 MHz ~ 1 GHz	<b>Polarization:</b>	Horizontal
<b>Test Voltage:</b>	AC 120/60Hz	<b>Environment:</b>	Temp: 24°C Humi: 57%

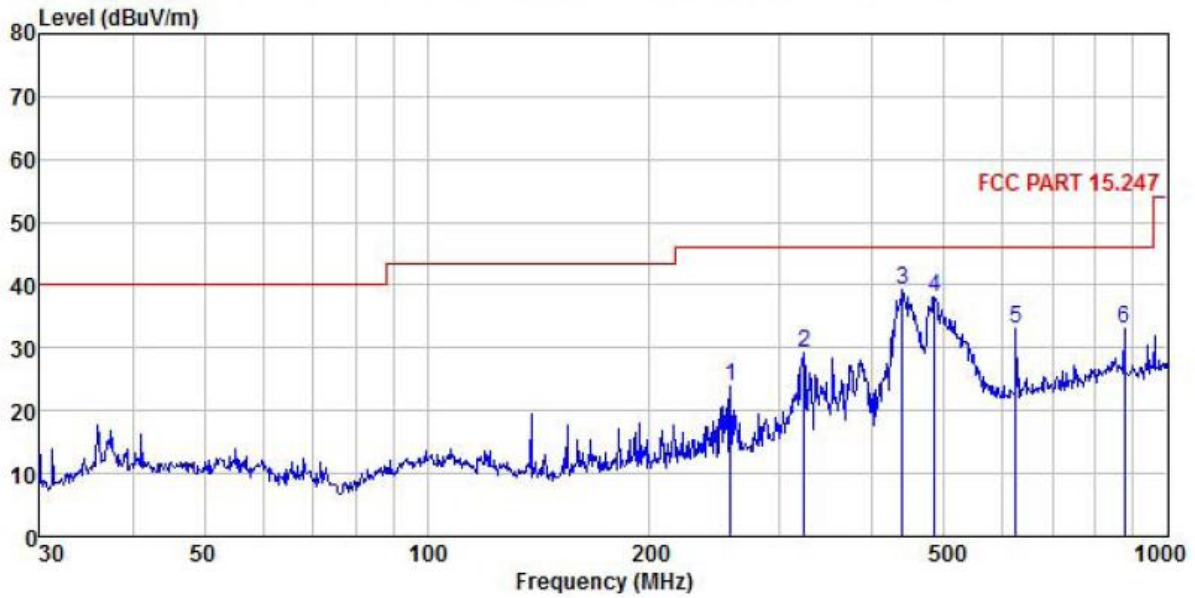

	Freq	Read Level	Antenna Factor	Cable Loss	Preamp Factor	Level	Limit	Over Limit	Remark
	MHz	dBuV	dB/m	dB	dB	dBuV/m	dBuV/m	dB	
1	257.422	36.72	12.85	2.83	28.53	23.87	46.00	-22.13	QP
2	323.320	40.72	14.09	3.02	28.50	29.33	46.00	-16.67	QP
3	438.655	48.63	16.24	3.17	28.85	39.19	46.00	-6.81	QP
4	485.609	45.87	17.72	3.50	28.93	38.16	46.00	-7.84	QP
5	625.078	38.37	19.61	3.90	28.86	33.02	46.00	-12.98	QP
6	875.247	34.38	22.55	3.95	27.94	32.94	46.00	-13.06	QP

**Remark:**

1. Final Level = Receiver Read level + Antenna Factor + Cable Loss – Pre-amplifier Factor.
2. The emission levels of other frequencies are very lower than the limit and not show in test report.

**Above 1GHz:**

**Internal Antenna**

Test channel: Lowest channel								
Detector: Peak Value								
Frequency (MHz)	Read Level (dBuV)	Antenna Factor (dB/m)	Cable Loss (dB)	Preamp Factor (dB)	Level (dBuV/m)	Limit Line (dBuV/m)	Over Limit (dB)	Polarization
4804.00	47.93	31.02	6.80	41.81	43.94	74.00	-30.06	Vertical
4804.00	48.36	31.02	6.80	41.81	44.37	74.00	-29.63	Horizontal
Detector: Average Value								
Frequency (MHz)	Read Level (dBuV)	Antenna Factor (dB/m)	Cable Loss (dB)	Preamp Factor (dB)	Level (dBuV/m)	Limit Line (dBuV/m)	Over Limit (dB)	Polarization
4804.00	38.77	31.02	6.80	41.81	34.78	54.00	-19.22	Vertical
4804.00	38.66	31.02	6.80	41.81	34.67	54.00	-19.33	Horizontal
Test channel: Middle channel								
Detector: Peak Value								
Frequency (MHz)	Read Level (dBuV)	Antenna Factor (dB/m)	Cable Loss (dB)	Preamp Factor (dB)	Level (dBuV/m)	Limit Line (dBuV/m)	Over Limit (dB)	Polarization
4884.00	48.26	31.18	6.86	41.84	44.46	74.00	-29.54	Vertical
4884.00	48.61	31.18	6.86	41.84	44.81	74.00	-29.19	Horizontal
Detector: Average Value								
Frequency (MHz)	Read Level (dBuV)	Antenna Factor (dB/m)	Cable Loss (dB)	Preamp Factor (dB)	Level (dBuV/m)	Limit Line (dBuV/m)	Over Limit (dB)	Polarization
4884.00	39.07	31.18	6.86	41.84	35.27	54.00	-18.73	Vertical
4884.00	38.36	31.18	6.86	41.84	34.56	54.00	-19.44	Horizontal
Test channel: Highest channel								
Detector: Peak Value								
Frequency (MHz)	Read Level (dBuV)	Antenna Factor (dB/m)	Cable Loss (dB)	Preamp Factor (dB)	Level (dBuV/m)	Limit Line (dBuV/m)	Over Limit (dB)	Polarization
4960.00	48.46	31.32	6.91	41.87	44.82	74.00	-29.18	Vertical
4960.00	48.63	31.32	6.91	41.87	44.99	74.00	-29.01	Horizontal
Detector: Average Value								
Frequency (MHz)	Read Level (dBuV)	Antenna Factor (dB/m)	Cable Loss (dB)	Preamp Factor (dB)	Level (dBuV/m)	Limit Line (dBuV/m)	Over Limit (dB)	Polarization
4960.00	38.64	31.32	6.91	41.87	35.00	54.00	-19.00	Vertical
4960.00	38.13	31.32	6.91	41.87	34.49	54.00	-19.51	Horizontal
Remark: 1. Final Level = Receiver Read level + Antenna Factor + Cable Loss – Pre-amplifier Factor. 2. The emission levels of other frequencies are very lower than the limit and not show in test report.								



**Above 1GHz:**

**External Antenna**

Test channel: Lowest channel								
Detector: Peak Value								
Frequency (MHz)	Read Level (dBuV)	Antenna Factor (dB/m)	Cable Loss (dB)	Preamp Factor (dB)	Level (dBuV/m)	Limit Line (dBuV/m)	Over Limit (dB)	Polarization
4804.00	47.29	31.02	6.80	41.81	43.30	74.00	-30.70	Vertical
4804.00	47.80	31.02	6.80	41.81	43.81	74.00	-30.19	Horizontal
Detector: Average Value								
Frequency (MHz)	Read Level (dBuV)	Antenna Factor (dB/m)	Cable Loss (dB)	Preamp Factor (dB)	Level (dBuV/m)	Limit Line (dBuV/m)	Over Limit (dB)	Polarization
4804.00	38.16	31.02	6.80	41.81	34.17	54.00	-19.83	Vertical
4804.00	38.13	31.02	6.80	41.81	34.14	54.00	-19.86	Horizontal
Test channel: Middle channel								
Detector: Peak Value								
Frequency (MHz)	Read Level (dBuV)	Antenna Factor (dB/m)	Cable Loss (dB)	Preamp Factor (dB)	Level (dBuV/m)	Limit Line (dBuV/m)	Over Limit (dB)	Polarization
4884.00	46.89	31.18	6.86	41.84	43.09	74.00	-30.91	Vertical
4884.00	47.33	31.18	6.86	41.84	43.53	74.00	-30.47	Horizontal
Detector: Average Value								
Frequency (MHz)	Read Level (dBuV)	Antenna Factor (dB/m)	Cable Loss (dB)	Preamp Factor (dB)	Level (dBuV/m)	Limit Line (dBuV/m)	Over Limit (dB)	Polarization
4884.00	38.47	31.18	6.86	41.84	34.67	54.00	-19.33	Vertical
4884.00	37.85	31.18	6.86	41.84	34.05	54.00	-19.95	Horizontal
Test channel: Highest channel								
Detector: Peak Value								
Frequency (MHz)	Read Level (dBuV)	Antenna Factor (dB/m)	Cable Loss (dB)	Preamp Factor (dB)	Level (dBuV/m)	Limit Line (dBuV/m)	Over Limit (dB)	Polarization
4960.00	46.86	31.32	6.91	41.87	43.22	74.00	-30.78	Vertical
4960.00	47.33	31.32	6.91	41.87	43.69	74.00	-30.31	Horizontal
Detector: Average Value								
Frequency (MHz)	Read Level (dBuV)	Antenna Factor (dB/m)	Cable Loss (dB)	Preamp Factor (dB)	Level (dBuV/m)	Limit Line (dBuV/m)	Over Limit (dB)	Polarization
4960.00	37.97	31.32	6.91	41.87	34.33	54.00	-19.67	Vertical
4960.00	37.84	31.32	6.91	41.87	34.20	54.00	-19.80	Horizontal
Remark:								
3. Final Level = Receiver Read level + Antenna Factor + Cable Loss – Pre-amplifier Factor.								
4. The emission levels of other frequencies are very lower than the limit and not show in test report.								

## 8 EUT Constructional Details

Reference to the test report No.: CCISE190808001

-----End of report-----