

SAR EVALUATION REPORT

For

Bolt Modus Corp

Oficina N.33 Edificio Ofidepositos Central, Calidonia - Distrito Federal, Panama

FCC ID: 2APW4LIV2L

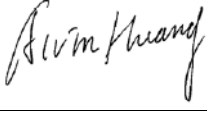
| | |
|---|---|
| Report Type: Original Report | Product Type: Smart phone |
| Report Number: RSZ200416003-SA | |
| Report Date: 2020-05-05 | |
| Reviewed By: Alvin Huang Lab Manager |  |
| Prepared By: Bay Area Compliance Laboratories Corp. (Shenzhen) 6/F., West Wing, Third Phase of Wanli Industrial Building, Shihua Road, Futian Free Trade Zone, Shenzhen, Guangdong, China Tel: +86-755-33320018 Fax: +86-755-33320008 www.baclcorp.com.cn | |

Note: This report must not be used by the customer to claim product certification, approval, or endorsement by A2LA* or any agency of the Federal Government. This report may contain data that are not covered by the A2LA accreditation and are marked with an asterisk “★”.

BACL is not responsible for the authenticity of any test data provided by the applicant. Data included from the applicant that may affect test results are marked with an asterisk ‘*’. Customer model name, addresses, names, trademarks etc. are not considered data.

This report cannot be reproduced except in full, without prior written approval of the Company. Unless otherwise stated the results shown in this test report refer only to the sample(s) tested. This report is valid only with a valid digital signature. The digital signature may be available only under the Adobe software above version 7.0.

| Attestation of Test Results | | | |
|-----------------------------|------------------------|---|---------------------|
| EUT Information | EUT Description | Smart phone | |
| | Tested Model | LIV2LTE | |
| | FCC ID | 2APW4LIV2L | |
| | Serial Number | RSZ200416003-SA-S1 | |
| | Test Date | 2020/04/21 to 2020/04/24 | |
| MODE | | Max. SAR Level(s) Reported(W/kg) | Limit (W/kg) |
| GSM 850 | 1g Head SAR | 0.30 | 1.6 |
| | 1g Body SAR | 0.59 | |
| PCS 1900 | 1g Head SAR | 0.24 | |
| | 1g Body SAR | 0.77 | |
| WCDMA Band 2 | 1g Head SAR | 0.36 | |
| | 1g Body SAR | 0.67 | |
| WCDMA Band 5 | 1g Head SAR | 0.39 | |
| | 1g Body SAR | 0.72 | |
| LTE Band 2 | 1g Head SAR | 0.30 | |
| | 1g Body SAR | 1.07 | |
| LTE Band 4 | 1g Head SAR | 0.33 | |
| | 1g Body SAR | 1.04 | |
| LTE Band 7 | 1g Head SAR | 0.49 | |
| | 1g Body SAR | 0.87 | |
| LTE Band 12 | 1g Head SAR | 0.30 | |
| | 1g Body SAR | 0.49 | |
| LTE Band 17 | 1g Head SAR | 0.27 | |
| | 1g Body SAR | 0.47 | |
| Simultaneous | 1g Head SAR | 0.86 | |
| | 1g Body SAR | 1.26 | |
| | 1g Body SAR | 1.26 (Hotspot) | |

| | |
|---|---|
| Applicable Standards | <p>FCC 47 CFR part 2.1093 Radiofrequency radiation exposure evaluation: portable devices</p> |
| | <p>IEEE1528:2013 IEEE Recommended Practice for Determining the Peak Spatial-Average Specific Absorption Rate (SAR) in the Human Head from Wireless Communications Devices: Measurement Techniques</p> |
| | <p>IEC 62209-2:2010 Human exposure to radio frequency fields from hand-held and body-mounted wireless communication devices-Human models, instrumentation, and procedures-Part 2: Procedure to determine the specific absorption rate (SAR) for wireless communication devices used in close proximity to the human body (frequency range of 30 MHz to 6 GHz)</p> |
| | <p>IEC 62209-1:2016 Measurement procedure for the assessment of specific absorption rate of human exposure to radio frequency fields from hand-held and body-mounted wireless communication devices – Part 1: Devices used next to the ear (Frequency range of 300 MHz to 6 GHz)</p> |
| | <p>KDB procedures KDB 447498 D01 General RF Exposure Guidance v06 KDB 648474 D04 Handset SAR v01r03 KDB 865664 D01 SAR Measurement 100 MHz to 6 GHz v01r04 KDB 865664 D02 RF Exposure Reporting v01r02 KDB 941225 D01 3G SAR Procedures v03r01 KDB 941225 D05 SAR for LTE Devices v02r05 KDB 941225 D06 Hotspot Mode v02r01 KDB 248227 D01 802.11 Wi-Fi SAR v02r02</p> |
| <p>Note: This wireless device has been shown to be capable of compliance for localized specific absorption rate (SAR) for General Population/Uncontrolled Exposure limits specified in FCC 47 CFR part 2.1093 and has been tested in accordance with the measurement procedures specified in IEEE 1528-2013 and RF exposure KDB procedures. The results and statements contained in this report pertain only to the device(s) evaluated.</p> | |

TABLE OF CONTENTS

| | |
|---|-----------|
| DOCUMENT REVISION HISTORY..... | 5 |
| EUT DESCRIPTION | 6 |
| TECHNICAL SPECIFICATION..... | 6 |
| REFERENCE, STANDARDS, AND GUIDELINES..... | 7 |
| SAR LIMITS | 8 |
| FACILITIES | 9 |
| DESCRIPTION OF TEST SYSTEM..... | 10 |
| EQUIPMENT LIST AND CALIBRATION..... | 16 |
| EQUIPMENTS LIST & CALIBRATION INFORMATION | 16 |
| SAR MEASUREMENT SYSTEM VERIFICATION | 17 |
| LIQUID VERIFICATION..... | 17 |
| SYSTEM ACCURACY VERIFICATION | 19 |
| SAR SYSTEM VALIDATION DATA | 20 |
| EUT TEST STRATEGY AND METHODOLOGY..... | 25 |
| TEST POSITIONS FOR DEVICE OPERATING NEXT TO A PERSON’S EAR..... | 25 |
| CHEEK/TOUCH POSITION | 26 |
| EAR/TILT POSITION..... | 26 |
| TEST POSITIONS FOR BODY-WORN AND OTHER CONFIGURATIONS | 27 |
| TEST DISTANCE FOR SAR EVALUATION | 27 |
| SAR EVALUATION PROCEDURE..... | 28 |
| CONDUCTED OUTPUT POWER MEASUREMENT | 29 |
| PROVISION APPLICABLE..... | 29 |
| TEST PROCEDURE..... | 29 |
| RADIO CONFIGURATION..... | 29 |
| MAXIMUM TARGET OUTPUT POWER..... | 33 |
| TEST RESULTS:..... | 34 |
| STANDALONE SAR TEST EXCLUSION CONSIDERATIONS..... | 49 |
| ANTENNA DISTANCE TO EDGE..... | 49 |
| SAR TEST EXCLUSION FOR THE EUT EDGE CONSIDERATIONS RESULT..... | 50 |
| SAR MEASUREMENT RESULTS | 51 |
| SAR TEST DATA | 51 |
| SAR MEASUREMENT VARIABILITY..... | 62 |
| SAR SIMULTANEOUS TRANSMISSION DESCRIPTION..... | 63 |
| SAR PLOTS | 68 |
| APPENDIX A MEASUREMENT UNCERTAINTY | 69 |
| APPENDIX B EUT TEST POSITION PHOTOS..... | 71 |
| APPENDIX C CALIBRATION CERTIFICATES..... | 72 |

DOCUMENT REVISION HISTORY

| Revision Number | Report Number | Description of Revision | Date of Revision |
|-----------------|-----------------|-------------------------|------------------|
| 0 | RSZ200416003-SA | Original Report | 2020-05-05 |

EUT DESCRIPTION

This report has been prepared on behalf of **Bolt Modus Corp** and their product **Smart phone**, Model: **LIV2LTE**, FCC ID: **2APW4LIV2L** or the EUT (Equipment under Test) as referred to in the rest of this report.

**All measurement and test data in this report was gathered from production sample serial number:RSZ200416003-SA-S1 (Assigned by BACL, Shenzhen).The EUT supplied by the applicant was received on 2020-04-18.*

Technical Specification

| | |
|--|--|
| Device Type: | Portable |
| Exposure Category: | Population / Uncontrolled |
| Antenna Type(s): | Internal Antenna |
| DTM Type: | Class B |
| Multi-slot Class: | GPRS/EGPRS(Class 12) |
| Proximity sensor for SAR reduction: | None |
| Body-Worn Accessories: | Headset |
| Face-Head Accessories: | None |
| Operation Mode : | GSM Voice, GPRS/EGPRS Data, WCDMA(R99 (Voice+Data), HSDPA/HSUPA), FDD-LTE, WLAN, Bluetooth |
| Frequency Band: | GSM 850: 824-849 MHz(TX); 869-894 MHz(RX) PCS 1900: 1850-1910 MHz(TX); 1930-1990 MHz(RX) WCDMA Band 2: 1850-1910 MHz(TX); 1930-1990 MHz(RX) WCDMA Band 5: 824-849 MHz(TX); 869-894 MHz(RX) LTE Band 2: 1850-1910 MHz(TX); 1930-1990 MHz(RX) LTE Band 4: 1710-1755 MHz(TX) ; 2110-2155 MHz(RX) LTE Band 7: 2500-2570 MHz(TX); 2620-2690 MHz(RX) LTE Band 12: 699-716 MHz(TX); 729-746 MHz(RX) LTE Band 17: 704-716 MHz(TX); 734-746 MHz(RX) WLAN (2.4G): 2412 -2462 MHz Bluetooth : 2402 MHz-2480 MHz |
| Conducted RF Power: | GSM 850 : 32.71 dBm PCS 1900: 29.91 dBm WCDMA Band 2: 22.76 dBm WCDMA Band 5: 22.80 dBm LTE Band 2: 22.46 dBm LTE Band 4: 22.67 dBm LTE Band 7: 22.88 dBm LTE Band 12: 22.84 dBm LTE Band 17: 22.41 dBm WLAN (2.4G): 8.53 dBm Bluetooth(BDR/EDR): 4.60 dBm BLE: 5.11 dBm |
| Power Source: | Rechargeable Battery |
| Normal Operation: | Head and Body-worn |

REFERENCE, STANDARDS, AND GUIDELINES

FCC:

The Report and Order requires routine SAR evaluation prior to equipment authorization of portable transmitter devices, including portable telephones. For consumer products, the applicable limit is 1.6 mW/g as recommended by the ANSI/IEEE standard C95.1-1992 [6] for an uncontrolled environment (Paragraph 65). According to the Supplement C of OET Bulletin 65 "Evaluating Compliance with FCC Guide-lines for Human Exposure to Radio frequency Electromagnetic Fields", released on Jun 29, 2001 by the FCC, the device should be evaluated at maximum output power (radiated from the antenna) under "worst-case" conditions for normal or intended use, incorporating normal antenna operating positions, device peak performance frequencies and positions for maximum RF energy coupling.

This report describes the methodology and results of experiments performed on wireless data terminal. The objective was to determine if there is RF radiation and if radiation is found, what is the extent of radiation with respect to safety limits. SAR (Specific Absorption Rate) is the measure of RF exposure determined by the amount of RF energy absorbed by human body (or its parts) – to determine how the RF energy couples to the body or head which is a primary health concern for body worn devices. The limit below which the exposure to RF is considered safe by regulatory bodies in North America is 1.6 mW/g average over 1 gram of tissue mass.

CE:

The order requires routine SAR evaluation prior to equipment authorization of portable transmitter devices, including portable telephones. For consumer products, the applicable limit is 2 mW/g as recommended by EN62209-1 for an uncontrolled environment. According to the Standard, the device should be evaluated at maximum output power (radiated from the antenna) under "worst-case" conditions for normal or intended use, incorporating normal antenna operating positions, device peak performance frequencies and positions for maximum RF energy coupling.

This report describes the methodology and results of experiments performed on wireless data terminal. The objective was to determine if there is RF radiation and if radiation is found, what is the extent of radiation with respect to safety limits. SAR (Specific Absorption Rate) is the measure of RF exposure determined by the amount of RF energy absorbed by human body (or its parts) – to determine how the RF energy couples to the body or head which is a primary health concern for body worn devices. The limit below which the exposure to RF is considered safe by regulatory bodies in Europe is 2 mW/g average over 10 gram of tissue mass.

The test configurations were laid out on a specially designed test fixture to ensure the reproducibility of measurements. Each configuration was scanned for SAR. Analysis of each scan was carried out to characterize the above effects in the device.

SAR Limits

FCC Limit

| EXPOSURE LIMITS | SAR (W/kg) | |
|---|--|--|
| | (General Population / Uncontrolled Exposure Environment) | (Occupational / Controlled Exposure Environment) |
| Spatial Average (averaged over the whole body) | 0.08 | 0.4 |
| Spatial Peak (averaged over any 1 g of tissue) | 1.60 | 8.0 |
| Spatial Peak (hands/wrists/feet/ankles averaged over 10 g) | 4.0 | 20.0 |

CE Limit

| EXPOSURE LIMITS | SAR (W/kg) | |
|---|--|--|
| | (General Population / Uncontrolled Exposure Environment) | (Occupational / Controlled Exposure Environment) |
| Spatial Average (averaged over the whole body) | 0.08 | 0.4 |
| Spatial Peak (averaged over any 10 g of tissue) | 2.0 | 10 |
| Spatial Peak (hands/wrists/feet/ankles averaged over 10 g) | 4.0 | 20.0 |

Population/Uncontrolled Environments are defined as locations where there is the exposure of individual who have no knowledge or control of their exposure.

Occupational/Controlled Environments are defined as locations where there is exposure that may be incurred by people who are aware of the potential for exposure (i.e. as a result of employment or occupation).

General Population/Uncontrolled environments Spatial Peak limit 1.6W/kg (FCC) & 2 W/kg (CE) applied to the EUT.

FACILITIES

The test site used by Bay Area Compliance Laboratories Corp. (Shenzhen) to collect data is located at 6/F., West Wing, Third Phase of Wanli Industrial Building, Shihua Road, Futian Free Trade Zone, Shenzhen, Guangdong, China.

The test site has been approved by the FCC under the KDB 974614 D01 and is listed in the FCC Public Access Link (PAL) database, FCC Registration No.: 342867, the FCC Designation No.: CN1221.

The test site has been registered with ISED Canada under ISED Canada Registration Number 3062B.

DESCRIPTION OF TEST SYSTEM

These measurements were performed with the automated near-field scanning system DASY6 from Schmid & Partner Engineering AG (SPEAG) which is the Fifth generation of the system shown in the figure hereinafter:

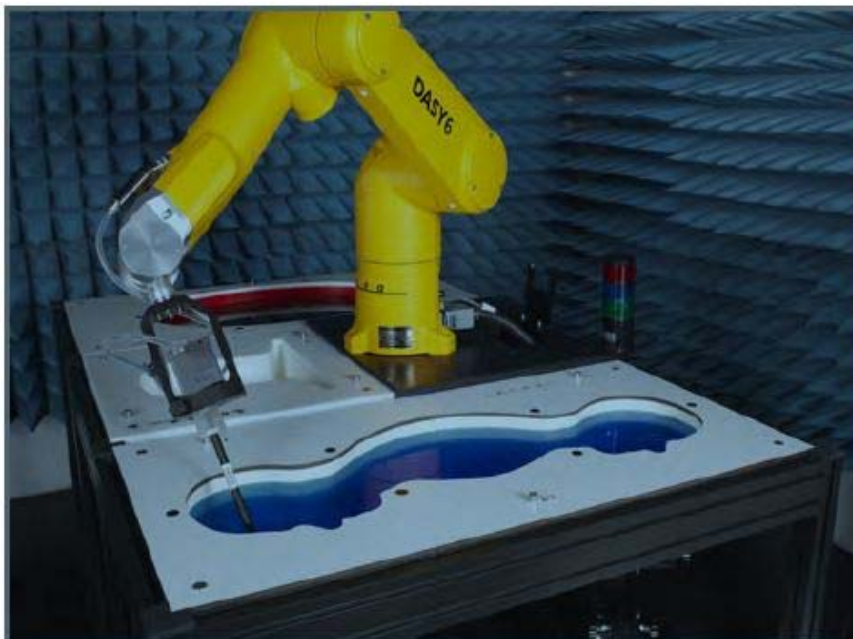

DASY6 System Description

The DASY6 system for performing compliance tests consists of the following items:

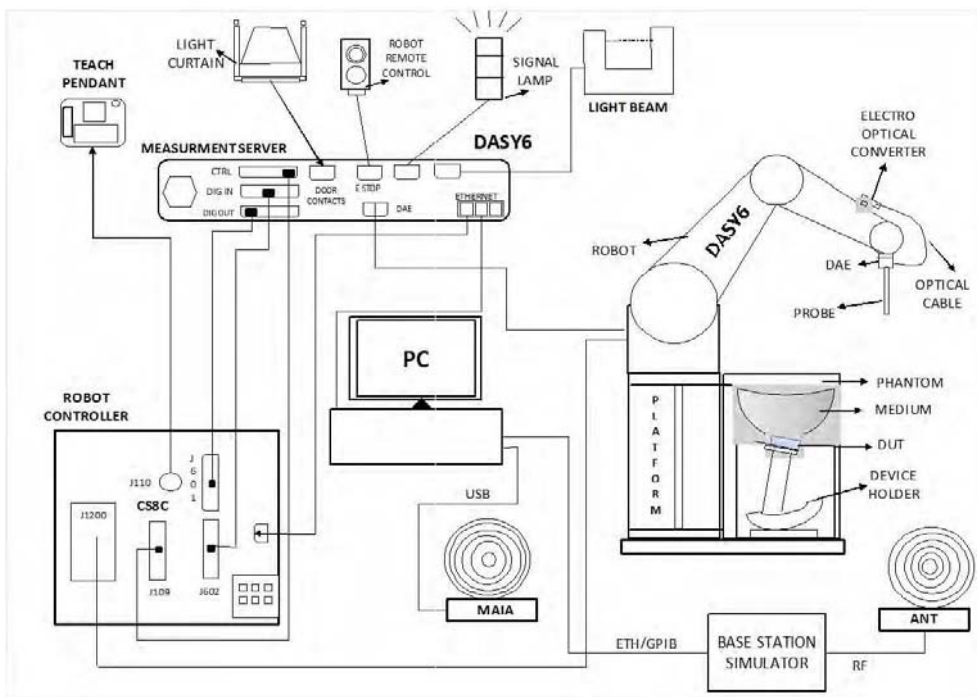

- A standard high precision 6-axis robot (Staubli TX=RX family) with controller, teach pendant and software. An arm extension for accommodating the data acquisition electronics (DAE).
- An isotropic field probe optimized and calibrated for the targeted measurement.
- A data acquisition electronics (DAE) which performs the signal application, signal multiplexing, AD-conversion, offset measurements, mechanical surface detection, collision detection, etc. The unit is battery powered with standard or rechargeable batteries. The signal is optically transmitted to the EOC.
- The Electro-optical converter (EOC) performs the conversion from optical to electrical signals for the digital communication to the DAE. To use optical surface detection, a special version of the EOC is required. The EOC signal is transmitted to the measurement server.
- The function of the measurement server is to perform the time critical tasks such as signal filtering, control of the robot operation and fast movement interrupts.
- The Light Beam used is for probe alignment. This improves the (absolute) accuracy of the probe positioning.
- A computer running Win7 professional operating system and the DASY52 software.
- Remote control and teach pendant as well as additional circuitry for robot safety such as warning lamps, etc.
- The phantom, the device holder and other accessories according to the targeted measurement.

DASY6 Measurement Server

The DASY6 measurement server is based on a PC/104 CPU board with a 400 MHz Intel ULV Celeron, 128 MB chip-disk and 128 MB RAM. The necessary circuits for communication with the DAE4 (or DAE3) electronics box, as well as the 16-bit AD converter system for optical detection and digital I/O interface are contained on the DASY6 I/O board, which is directly connected to the PC/104 bus of the CPU board.



The measurement server performs all real-time data evaluations of field measurements and surface detection, controls robot movements, and handles safety operations. The PC operating system cannot interfere with these time-critical processes. All connections are supervised by a watchdog, and disconnection of any of the cables to the measurement server will automatically disarm the robot and disable all program-controlled robot movements. Furthermore, the measurement server is equipped with an expansion port, which is reserved for future applications. Please note that this expansion port does not have a standardized pinout, and therefore only devices provided by SPEAG can be connected. Connection of devices from any other supplier could seriously damage the measurement server.

Data Acquisition Electronics

The data acquisition electronics (DAE4) consist of a highly sensitive electrometer-grade preamplifier with auto-zeroing, a channel and gain-switching multiplexer, a fast 16 bit AD-converter and a command decoder with a control logic unit. Transmission to the measurement server is accomplished through an optical downlink for data and status information, as well as an optical uplink for commands and the clock.

The mechanical probe mounting device includes two different sensor systems for frontal and sideways probe contacts. They are used for mechanical surface detection and probe collision detection.

The input impedance of both the DAE4 as well as of the DAE3 box is 200M Ω ; the inputs are symmetrical and floating. Common mode rejection is above 80 dB.

EX3DV4 E-Field Probes

| | |
|----------------------|---|
| Frequency | 10 MHz to > 6 GHz Linearity: ± 0.2 dB (30 MHz to 6 GHz) |
| Directivity | ± 0.3 dB in TSL (rotation around probe axis) ± 0.5 dB in TSL (rotation normal to probe axis) |
| Dynamic Range | 10 µW/g to > 100 mW/g Linearity: ± 0.2 dB (noise: typically < 1 µW/g) |
| Dimensions | Overall length: 337 mm (Tip: 20 mm) Tip diameter: 2.5 mm (Body: 12 mm) Typical distance from probe tip to dipole centers: 1 mm |
| Application | High precision dosimetric measurements in any exposure scenario (e.g., very strong gradient fields); the only probe that enables compliance testing for frequencies up to 6 GHz with precision of better 30%. |
| Compatibility | DASY3, DASY4, DASY52 SAR and higher, EASY4/MRI |

SAM Twin Phantom

The SAM Twin Phantom (shown in front of DASY6) is a fiberglass shell phantom with shell thickness 2 mm, except in the ear region where the thickness is increased to 6 mm. The phantom has three measurement areas: 1) Left Head, 2) Right Head, and 3) Flat Section. For larger devices, the use of the ELI-Phantom (shown behind DASY6) is required. For devices such as glasses with a wireless link, the Face Down Phantom is the most suitable (between the SAM Twin and ELI phantoms).

When the phantom is mounted inside allocated slot of the DASY6 platform, phantom reference points can be taught directly in the DASY5 V5.2 software. When the DASY6 platform is used to mount the

Phantom, some of the phantom teaching points cannot be reached by the robot in DASY5 V5.2. A special tool called P1a-P2aX-Former is provided to transform two of the three points, P1 and P2, to reachable locations. To use these new teaching points, a revised phantom configuration file is required.

In addition to our standard broadband liquids, the phantom can be used with the following tissue simulating liquids:

Sugar-water-based liquids can be left permanently in the phantom. Always cover the liquid when the system is not in use to prevent changes in liquid parameters due to water evaporation.

DGBE-based liquids should be used with care. As DGBE is a softener for most plastics, the liquid should be taken out of the phantom, and the phantom should be dried when the system is not in use (desirable at least once a week).

Do not use other organic solvents without previously testing the solvent resistivity of the phantom. Approximately 25 liters of liquid is required to fill the SAM Twin phantom.

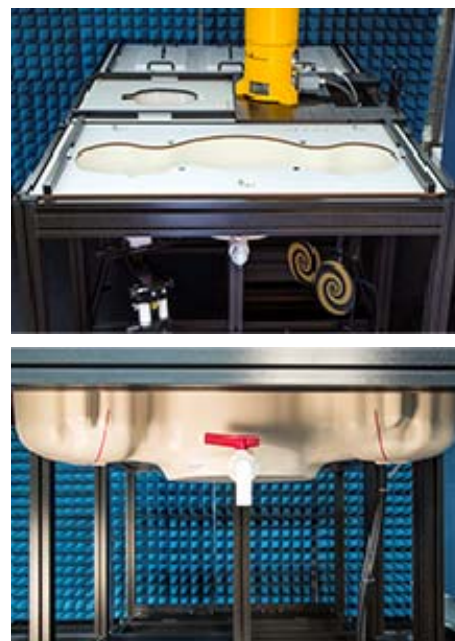

ELI Phantom

The ELI phantom is intended for compliance testing of handheld and body-mounted wireless devices in the frequency range of 30MHz to 6 GHz. ELI is fully compatible with the latest draft of the standard IEC 62209-2 and the use of all known tissue simulating liquids. ELI has been optimized for performance and can be integrated into a SPEAG standard phantom table. A cover is provided to prevent evaporation of water and changes in liquid parameters. Reference markings on the phantom allow installation of the complete setup, including all predefined phantom positions and measurement grids, by teaching three points.

The phantom can be used with the following tissue simulating liquids:

- Sugar-water-based liquids can be left permanently in the phantom. Always cover the liquid when the system is not in use to prevent changes in liquid parameters due to water evaporation.
- DGBE-based liquids should be used with care. As DGBE is a softener for most plastics, the liquid should be taken out of the phantom, and the phantom should be dried when the system is not in use (desirable at least once a week).
- Do not use other organic solvents without previously testing the solvent resistivity of the phantom.

Approximately 25 liters of liquid is required to fill the ELI phantom.

Robots

The DASY6 system uses the high-precision industrial robots TX60L, TX90XL, and RX160L from Staubli SA (France). The TX robot family - the successor of the well-known RX robot family - continues to offer the features important for DASY6 applications:

- High precision (repeatability 0.02mm)
- High reliability (industrial design)
- Low maintenance costs (virtually maintenance free due to direct drive gears; no belt drives)
- Jerk-free straight movements (brushless synchrony motors; no stepper motors)
- Low ELF interference (motor control fields shielded via the closed metallic construction shields)

The robots are controlled by the Staubli CS8c robot controllers. All information regarding the use and maintenance of the robot arm and the robot controller is provided

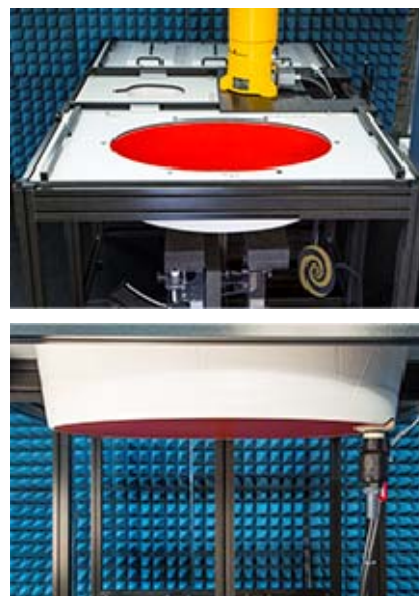

Calibration Frequency Points for EX3DV4 E-Field Probes SN: 7441 Calibrated: 2020/02/08

| Calibration Frequency Point(MHz) | Frequency Range(MHz) | | Conversion Factor | | |
|----------------------------------|----------------------|------|-------------------|-------|-------|
| | From | To | X | Y | Z |
| 750 Head | 650 | 850 | 10.33 | 10.33 | 10.33 |
| 900 Head | 850 | 1000 | 9.74 | 9.74 | 9.74 |
| 1750 Head | 1650 | 1850 | 8.36 | 8.36 | 8.36 |
| 1900 Head | 1850 | 2000 | 8.05 | 8.05 | 8.05 |
| 2300 Head | 2200 | 2400 | 7.89 | 7.89 | 7.89 |
| 2450 Head | 2400 | 2550 | 7.66 | 7.66 | 7.66 |
| 2600 Head | 2550 | 2700 | 7.35 | 7.35 | 7.35 |

Area Scans

Area scans are defined prior to the measurement process being executed with a user defined variable spacing between each measurement point (integral) allowing low uncertainty measurements to be conducted. Scans defined for FCC applications utilize a 15mm 2 step integral, with 1.5mm interpolation used to locate the peak SAR area used for zoom scan assessments.

Where the system identifies multiple SAR peaks (which are within 25% of peak value) the system will provide the user with the option of assessing each peak location individually for zoom scan averaging.

Zoom Scan (Cube Scan Averaging)

The averaging zoom scan volume utilized in the DASY5 software is in the shape of a cube and the side dimension of a 1 g or 10 g mass is dependent on the density of the liquid representing the simulated tissue. A density of 1000 kg/m³ is used to represent the head and body tissue density and not the phantom liquid density, in order to be consistent with the definition of the liquid dielectric properties, i.e. the side length of the 1g cube is 10mm, with the side length of the 10g cube is 21.5mm.

When the cube intersects with the surface of the phantom, it is oriented so that 3 vertices touch the surface of the shell or the center of a face is tangent to the surface. The face of the cube closest to the surface is modified in order to conform to the tangent surface.

The zoom scan integer steps can be user defined so as to reduce uncertainty, but normal practice for typical test applications (including FCC) utilize a physical step of 7 x 7 x 7 (5mmx5mmx5mm) providing a volume of 30 mm in the X & Y & Z axis.

Tissue Dielectric Parameters for Head and Body Phantoms

The head tissue dielectric parameters recommended by the IEC 62209-1:2016

Recommended Tissue Dielectric Parameters for Head and Body

Table A.3 – Dielectric properties of the head tissue-equivalent liquid

| Frequency MHz | Relative permittivity ϵ_r | Conductivity (σ) S/m |
|------------------|---------------------------------------|----------------------------------|
| 300 | 45,3 | 0,87 |
| 450 | 43,5 | 0,87 |
| <i>750</i> | <i>41,9</i> | <i>0,89</i> |
| 835 | 41,5 | 0,90 |
| 900 | 41,5 | 0,97 |
| 1 450 | 40,5 | 1,20 |
| <i>1 500</i> | <i>40,4</i> | <i>1,23</i> |
| <i>1 640</i> | <i>40,2</i> | <i>1,31</i> |
| <i>1 750</i> | <i>40,1</i> | <i>1,37</i> |
| 1 800 | 40,0 | 1,40 |
| 1 900 | 40,0 | 1,40 |
| 2 000 | 40,0 | 1,40 |
| <i>2 100</i> | <i>39,8</i> | <i>1,49</i> |
| <i>2 300</i> | <i>39,5</i> | <i>1,67</i> |
| 2 450 | 39,2 | 1,80 |
| <i>2 600</i> | <i>39,0</i> | <i>1,96</i> |
| 3 000 | 38,5 | 2,40 |
| <i>3 500</i> | <i>37,9</i> | <i>2,91</i> |
| <i>4 000</i> | <i>37,4</i> | <i>3,43</i> |
| <i>4 500</i> | <i>36,8</i> | <i>3,94</i> |
| <i>5 000</i> | <i>36,2</i> | <i>4,45</i> |
| <i>5 200</i> | <i>36,0</i> | <i>4,66</i> |
| <i>5 400</i> | <i>35,8</i> | <i>4,86</i> |
| <i>5 600</i> | <i>35,5</i> | <i>5,07</i> |
| <i>5 800</i> | <i>35,3</i> | <i>5,27</i> |
| 6 000 | 35,1 | 5,48 |

NOTE For convenience, permittivity and conductivity values at those frequencies which are not part of the original data provided by Drossos et al. [33] or the extension to 5 800 MHz are provided (i.e. the values shown *in italics*). These values were linearly interpolated between the values in this table that are immediately above and below these values, except the values at 6 000 MHz that were linearly extrapolated from the values at 3 000 MHz and 5 800 MHz.

EQUIPMENT LIST AND CALIBRATION

Equipments List & Calibration Information

| Equipment | Model | S/N | Calibration Date | Calibration Due Date |
|---|-----------------|-----------------------|------------------|----------------------|
| DASY5 Test Software | DASY52 52.10.2 | N/A | NCR | NCR |
| DASY6 Measurement Server | DASY6 6.0.31 | N/A | NCR | NCR |
| Data Acquisition Electronics | DAE4 | 1562 | 2020/03/10 | 2021/03/09 |
| E-Field Probe | EX3DV4 | 7441 | 2020/02/08 | 2021/02/07 |
| Mounting Device | MD4HHTV5 | SD 000 H01 KA | NCR | NCR |
| SAM Twin Phantom | SAM-Twin V8.0 | 1962 | NCR | NCR |
| Dipole, 750MHz | D750V3 | 1194 | 2020/01/13 | 2021/01/12 |
| Dipole, 900MHz | D900V2 | 132 | 2017/10/10 | 2020/10/09 |
| Dipole,1800MHz | D1800V2 | 2d018 | 2017/10/11 | 2020/10/10 |
| Dipole,1900MHz | D1900V2 | 5d231 | 2020/01/14 | 2023/01/13 |
| Dipole,2600MHz | D2600V2 | 1162 | 2019/10/02 | 2022/10/01 |
| Simulated Tissue Liquid Head | HBBL600-10000V6 | 180622-2 | Each Time | / |
| Network Analyzer | 8753D | 3410A08288 | 2019/07/22 | 2020/07/21 |
| Dielectric Assessment Kit | DAK-3.5 | 1248 | NCR | NCR |
| Anritsu Signal Generator | 68369B | 4114 | 2019/07/09 | 2020/07/08 |
| USB wideband power sensor | U2021XA | MY54250003 | 2019/07/10 | 2020/07/09 |
| Power Amplifier | 5S1G4 | 71377 | NCR | NCR |
| Directional Coupler | 4242-10 | 3307 | NCR | NCR |
| Attenuator | 3dB | 5402 | NCR | NCR |
| Attenuator | 10dB | AU 3842 | NCR | NCR |
| R&S, universal Radio Communication Tester | CMU200 | 115500 | 2019/06/23 | 2020/06/22 |
| WIDEBAND RADIO COMMUNICATION TESTER | CMW500 | 1201.002K50-146520-wh | 2019/06/23 | 2020/06/22 |
| Wireless communication tester | 8960 | MY50266471 | 2019/09/12 | 2020/09/11 |

SAR MEASUREMENT SYSTEM VERIFICATION

Liquid Verification

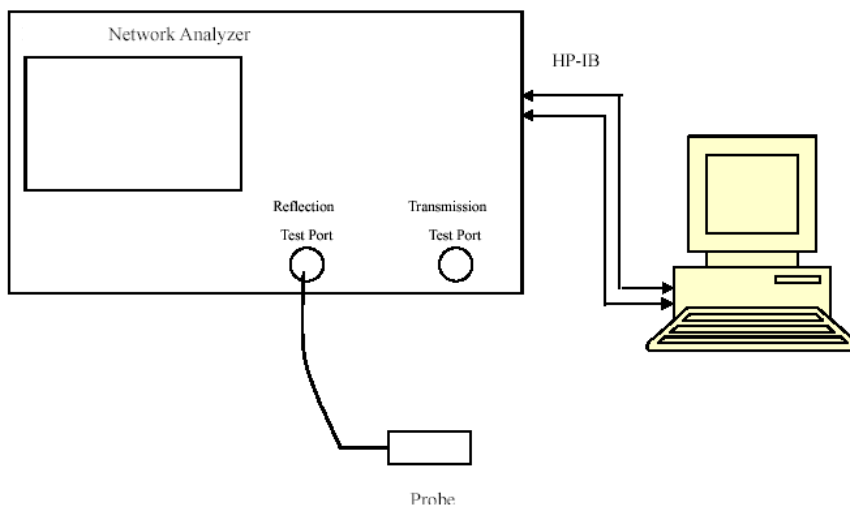

Liquid Verification Setup Block Diagram

Liquid Verification Results

| Frequency (MHz) | Liquid Type | Liquid Parameter | | Target Value | | Delta (%) | | Tolerance (%) |
|-----------------|------------------------------|------------------|----------------|--------------|----------------|--------------------|----------------|---------------|
| | | ϵ_r | σ (S/m) | ϵ_r | σ (S/m) | $\Delta\epsilon_r$ | $\Delta\sigma$ | |
| 704 | Simulated Tissue Liquid Head | 43.097 | 0.884 | 42.18 | 0.89 | 2.17 | -0.67 | ± 5 |
| 707.5 | Simulated Tissue Liquid Head | 43.091 | 0.887 | 42.16 | 0.89 | 2.21 | -0.34 | ± 5 |
| 709 | Simulated Tissue Liquid Head | 43.178 | 0.883 | 42.15 | 0.89 | 2.44 | -0.79 | ± 5 |
| 710 | Simulated Tissue Liquid Head | 43.052 | 0.889 | 42.15 | 0.89 | 2.14 | -0.11 | ± 5 |
| 711 | Simulated Tissue Liquid Head | 42.78 | 0.887 | 42.14 | 0.89 | 1.52 | -0.34 | ± 5 |
| 750 | Simulated Tissue Liquid Head | 43.075 | 0.892 | 41.90 | 0.89 | 2.8 | 0.22 | ± 5 |

*Liquid Verification above was performed on 2020/04/21.

| Frequency (MHz) | Liquid Type | Liquid Parameter | | Target Value | | Delta (%) | | Tolerance (%) |
|-----------------|------------------------------|------------------|----------------|--------------|----------------|--------------------|----------------|---------------|
| | | ϵ_r | σ (S/m) | ϵ_r | σ (S/m) | $\Delta\epsilon_r$ | $\Delta\sigma$ | |
| 750 | Simulated Tissue Liquid Head | 42.975 | 0.887 | 41.90 | 0.89 | 2.57 | -0.34 | ± 5 |
| 824.2 | Simulated Tissue Liquid Head | 41.833 | 0.889 | 41.55 | 0.90 | 0.68 | -1.22 | ± 5 |
| 826.4 | Simulated Tissue Liquid Head | 41.668 | 0.892 | 41.54 | 0.90 | 0.31 | -0.89 | ± 5 |
| 835 | Simulated Tissue Liquid Head | 41.496 | 0.909 | 41.5 | 0.90 | -0.01 | 1 | ± 5 |
| 836.6 | Simulated Tissue Liquid Head | 41.628 | 0.929 | 41.5 | 0.90 | 0.31 | 3.22 | ± 5 |
| 846.6 | Simulated Tissue Liquid Head | 41.586 | 0.933 | 41.5 | 0.91 | 0.21 | 2.53 | ± 5 |
| 848.8 | Simulated Tissue Liquid Head | 41.463 | 0.949 | 41.5 | 0.91 | -0.09 | 4.29 | ± 5 |

*Liquid Verification above was performed on 2020/04/22.

| Frequency (MHz) | Liquid Type | Liquid Parameter | | Target Value | | Delta (%) | | Tolerance (%) |
|-----------------|------------------------------|------------------|----------------|--------------|----------------|--------------------|----------------|---------------|
| | | ϵ_r | σ (S/m) | ϵ_r | σ (S/m) | $\Delta\epsilon_r$ | $\Delta\sigma$ | |
| 1720 | Simulated Tissue Liquid Head | 40.724 | 1.364 | 40.13 | 1.35 | 1.48 | 1.04 | ± 5 |
| 1732.5 | Simulated Tissue Liquid Head | 41.464 | 1.374 | 40.12 | 1.36 | 3.35 | 1.03 | ± 5 |
| 1745 | Simulated Tissue Liquid Head | 41.467 | 1.389 | 40.1 | 1.37 | 3.41 | 1.39 | ± 5 |
| 1800 | Simulated Tissue Liquid Head | 40.048 | 1.386 | 40.0 | 1.40 | 0.12 | -1 | ± 5 |

*Liquid Verification above was performed on 2020/04/22.

| Frequency (MHz) | Liquid Type | Liquid Parameter | | Target Value | | Delta (%) | | Tolerance (%) |
|-----------------|------------------------------|------------------|----------------|--------------|----------------|--------------------|----------------|---------------|
| | | ϵ_r | σ (S/m) | ϵ_r | σ (S/m) | $\Delta\epsilon_r$ | $\Delta\sigma$ | |
| 1850.2 | Simulated Tissue Liquid Head | 41.133 | 1.402 | 40.0 | 1.40 | 2.83 | 0.14 | ± 5 |
| 1852.4 | Simulated Tissue Liquid Head | 40.328 | 1.416 | 40.0 | 1.40 | 0.82 | 1.14 | ± 5 |
| 1860 | Simulated Tissue Liquid Head | 40.697 | 1.411 | 40.0 | 1.40 | 1.74 | 0.79 | ± 5 |
| 1880 | Simulated Tissue Liquid Head | 40.897 | 1.416 | 40.0 | 1.40 | 2.24 | 1.14 | ± 5 |
| 1900 | Simulated Tissue Liquid Head | 40.725 | 1.428 | 40.0 | 1.40 | 1.81 | 2 | ± 5 |
| 1907.6 | Simulated Tissue Liquid Head | 40.913 | 1.43 | 40.0 | 1.40 | 2.28 | 2.14 | ± 5 |
| 1909.8 | Simulated Tissue Liquid Head | 40.396 | 1.445 | 40.0 | 1.40 | 0.99 | 3.21 | ± 5 |

*Liquid Verification above was performed on 2020/04/23

| Frequency (MHz) | Liquid Type | Liquid Parameter | | Target Value | | Delta (%) | | Tolerance (%) |
|-----------------|------------------------------|------------------|----------------|--------------|----------------|--------------------|----------------|---------------|
| | | ϵ_r | σ (S/m) | ϵ_r | σ (S/m) | $\Delta\epsilon_r$ | $\Delta\sigma$ | |
| 2510 | Simulated Tissue Liquid Head | 39.806 | 1.912 | 39.12 | 1.86 | 1.75 | 2.8 | ± 5 |
| 2535 | Simulated Tissue Liquid Head | 39.548 | 1.921 | 39.09 | 1.89 | 1.17 | 1.64 | ± 5 |
| 2560 | Simulated Tissue Liquid Head | 39.408 | 1.933 | 39.05 | 1.92 | 0.92 | 0.68 | ± 5 |
| 2600 | Simulated Tissue Liquid Head | 39.079 | 1.984 | 39.00 | 1.96 | 0.2 | 1.22 | ± 5 |

*Liquid Verification above was performed on 2020/04/25

System Accuracy Verification

Prior to the assessment, the system validation kit was used to test whether the system was operating within its specifications of $\pm 10\%$. The validation results are tabulated below. And also the corresponding SAR plot is attached as well in the SAR plots files.

The spacing distances in the **System Verification Setup Block Diagram** is given by the following:

- a) $s = 15 \text{ mm} \pm 0,2 \text{ mm}$ for $300 \text{ MHz} \leq f \leq 1 \text{ 000 MHz}$;
- b) $s = 10 \text{ mm} \pm 0,2 \text{ mm}$ for $1 \text{ 000 MHz} < f \leq 3 \text{ 000 MHz}$;
- c) $s = 10 \text{ mm} \pm 0,2 \text{ mm}$ for $3 \text{ 000 MHz} < f \leq 6 \text{ 000 MHz}$.

System Verification Setup Block Diagram

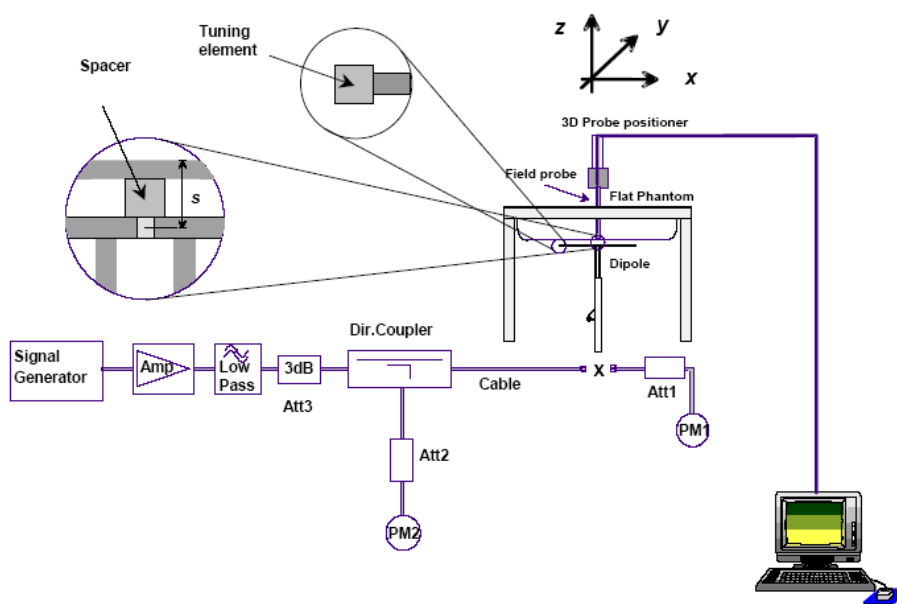

System Accuracy Check Results

| Date | Frequency Band (MHz) | Liquid Type | Input Power (mW) | Measured SAR (W/kg) | Normalized to 1W (W/kg) | Target Value (W/Kg) | Delta (%) | Tolerance (%) |
|------------|----------------------|-------------|------------------|---------------------|-------------------------|---------------------|-----------|---------------|
| 2020/04/21 | 750 | Head | 100 | 1g 0.878 | 8.78 | 8.55 | 2.690 | ± 10 |
| 2020/04/22 | 750 | Head | 100 | 1g 0.873 | 8.73 | 8.55 | 2.105 | ± 10 |
| 2020/04/22 | 1800 | Head | 100 | 1g 3.94 | 39.4 | 38.5 | 2.338 | ± 10 |
| 2020/04/23 | 1900 | Head | 100 | 1g 4.12 | 41.2 | 40.3 | 2.233 | ± 10 |
| 2020/04/24 | 2600 | Head | 100 | 1g 5.64 | 56.4 | 55.4 | 1.805 | ± 10 |

*The SAR values above are normalized to 1 Watt forward power.

SAR SYSTEM VALIDATION DATA

System Performance 750 MHz Head

DUT: Dipole 750 MHz; Type: D750V3; Serial: 1079

Communication System: UID 0, CW (0); Frequency: 750 MHz; Duty Cycle: 1:1
 Medium parameters used: $f = 750 \text{ MHz}$; $\sigma = 0.892 \text{ S/m}$; $\epsilon_r = 43.075$; $\rho = 1000 \text{ kg/m}^3$
 Phantom section: Flat Section

DASY5 Configuration:

- Probe: EX3DV4 - SN7441; ConvF(10.33, 10.33, 10.33) @ 750 MHz;
- Sensor-Surface: 4mm (Mechanical Surface Detection)
- Electronics: DAE4 Sn1562; Calibrated: 2020/03/10
- Phantom: SAM-Twin V8.0 P1aP2a; Type: QD 000 P41 AA ; Serial: 1962
- Measurement SW: DASY52, Version 52.10 (2);

Head 750MHz Pin=100mW/Area Scan (101x161x1): Interpolated grid: $dx=1.000 \text{ mm}$, $dy=1.000 \text{ mm}$
 Maximum value of SAR (interpolated) = 0.989 W/kg

Head 750MHz Pin=100mW/Zoom Scan (7x7x7)/Cube 0: Measurement grid: $dx=5\text{mm}$, $dy=5\text{mm}$, $dz=5\text{mm}$
 Reference Value = 36.39 V/m; Power Drift = -0.05 dB
 Peak SAR (extrapolated) = 1.25 W/kg
SAR(1 g) = 0.878 W/kg; SAR(10 g) = 0.602 W/kg
 Maximum value of SAR (measured) = 0.852 W/kg

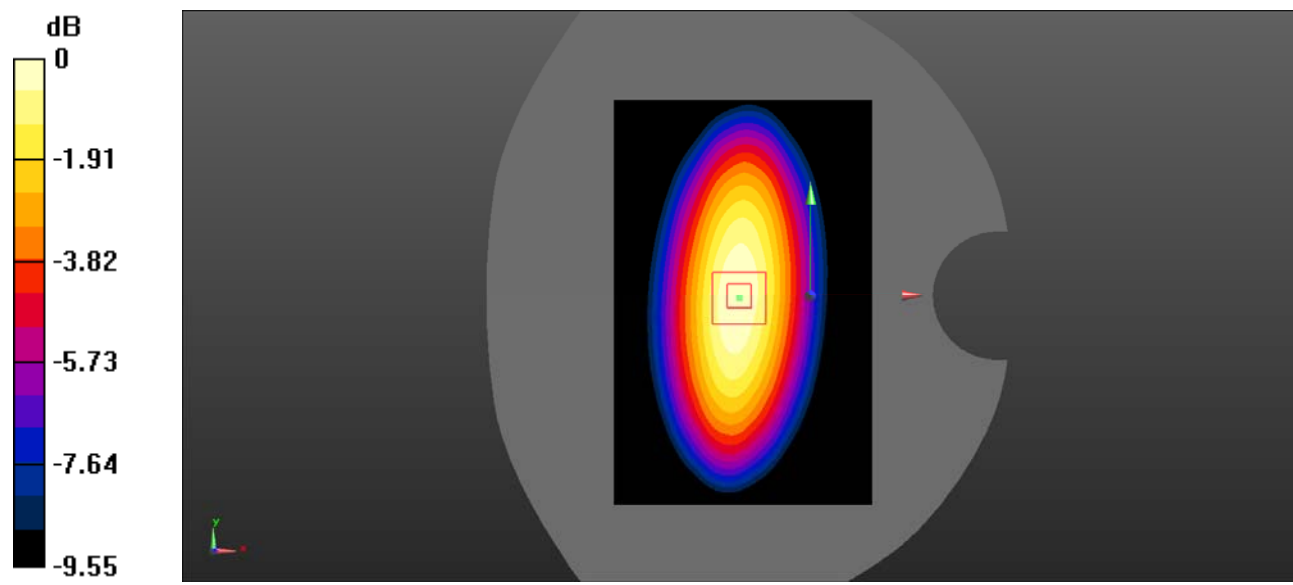

0 dB = 0.852 W/kg = -0.70 dBW/kg

System Performance 750 MHz Head

DUT: Dipole 750 MHz; Type: D750V3; Serial: 1079

Communication System: UID 0, CW (0); Frequency: 750 MHz; Duty Cycle: 1:1

Medium parameters used: $f = 750 \text{ MHz}$; $\sigma = 0.887 \text{ S/m}$; $\epsilon_r = 42.975$; $\rho = 1000 \text{ kg/m}^3$

Phantom section: Flat Section

DASY5 Configuration:

- Probe: EX3DV4 - SN7441; ConvF(10.33, 10.33, 10.33) @ 750 MHz;
- Sensor-Surface: 4mm (Mechanical Surface Detection)
- Electronics: DAE4 Sn1562; Calibrated: 2020/03/10
- Phantom: SAM-Twin V8.0 P1aP2a; Type: QD 000 P41 AA ; Serial: 1962
- Measurement SW: DASY52, Version 52.10 (2);

Head 750MHz Pin=100mW/Area Scan (101x161x1): Interpolated grid: $dx=1.000 \text{ mm}$, $dy=1.000 \text{ mm}$

Maximum value of SAR (interpolated) = 0.991 W/kg

Head 750MHz Pin=100mW/Zoom Scan (7x7x7)/Cube 0: Measurement grid: $dx=5\text{mm}$, $dy=5\text{mm}$, $dz=5\text{mm}$

Reference Value = 36.55 V/m; Power Drift = -0.02 dB

Peak SAR (extrapolated) = 1.15 W/kg

SAR(1 g) = 0.873 W/kg; SAR(10 g) = 0.599 W/kg

Maximum value of SAR (measured) = 0.833 W/kg

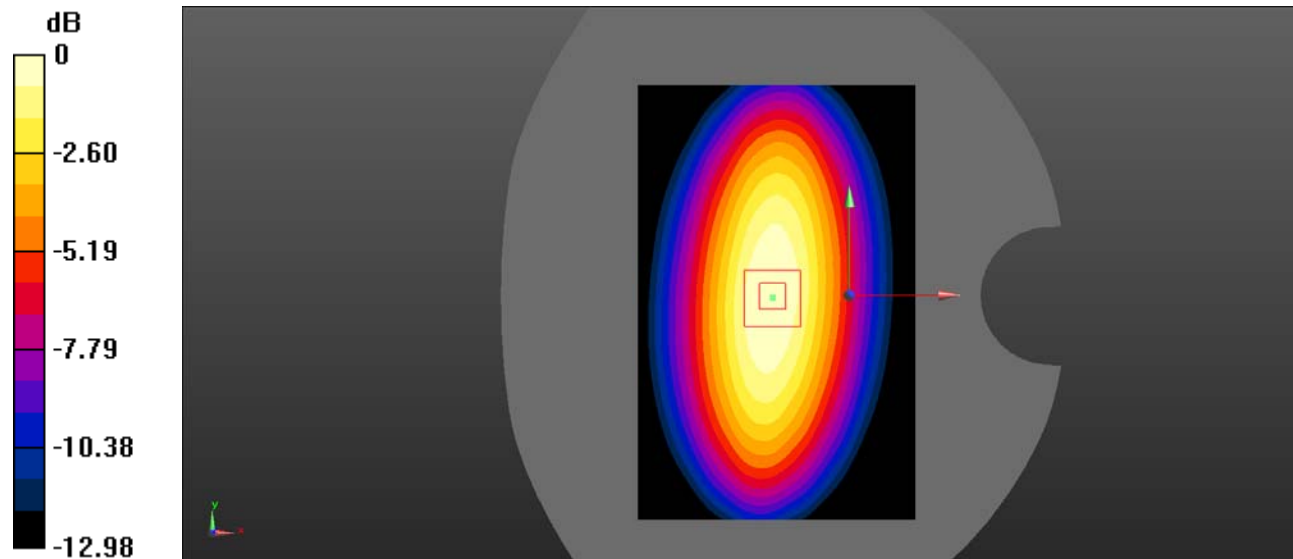

0 dB = 0.833 W/kg = -0.79 dBW/kg

System Performance 1800 MHz Head

DUT: Dipole 1800 MHz; Type: D1800V2; Serial: 2d018

Communication System: UID 0, CW (0); Frequency: 1800 MHz; Duty Cycle: 1:1
 Medium parameters used: $f = 1800 \text{ MHz}$; $\sigma = 1.387 \text{ S/m}$; $\epsilon_r = 39.953$; $\rho = 1000 \text{ kg/m}^3$
 Phantom section: Flat Section

DASY5 Configuration:

- Probe: EX3DV4 - SN7441; ConvF(8.36, 8.36, 8.36) @ 1800 MHz;
- Sensor-Surface: 4mm (Mechanical Surface Detection)
- Electronics: DAE4 Sn1562; Calibrated: 2020/03/10
- Phantom: SAM-Twin V8.0 P1aP2a; Type: QD 000 P41 AA ; Serial: 1962
- Measurement SW: DASY52, Version 52.10 (2);

Head 1800MHz Pin=100mW/Area Scan (81x121x1): Interpolated grid: $dx=1.000 \text{ mm}$, $dy=1.000 \text{ mm}$
 Maximum value of SAR (interpolated) = 4.04 W/kg

Head 1800MHz Pin=100mW/Zoom Scan (7x7x7)/Cube 0: Measurement grid: $dx=5\text{mm}$, $dy=5\text{mm}$, $dz=5\text{mm}$
 Reference Value = 50.44 V/m; Power Drift = 0.04 dB
 Peak SAR (extrapolated) = 4.42W/kg
SAR(1 g) = 3.94 W/kg; SAR(10 g) = 2.08 W/kg
 Maximum value of SAR (measured) = 4.35 W/kg

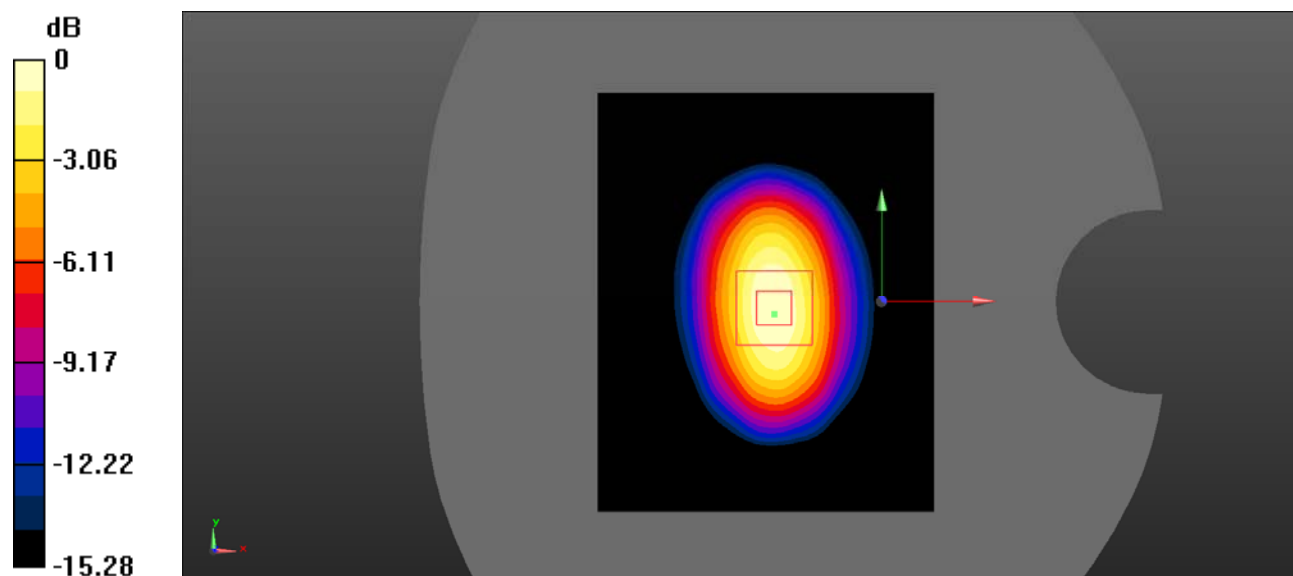

0 dB = 4.35 W/kg = 6.38 dBW/kg

System Performance 1900 MHz Head

DUT: Dipole 1900MHz; Type: D1900V2; Serial: 5d231

Communication System: CW; Frequency: 1900 MHz; Duty Cycle: 1:1

Medium parameters used: $f = 1900 \text{ MHz}$; $\sigma = 1.428 \text{ S/m}$; $\epsilon_r = 40.765$; $\rho = 1000 \text{ kg/m}^3$

Phantom section: Flat Section

DASY5 Configuration:

- Probe: EX3DV4 - SN7441; ConvF(8.05, 8.05,8.05) @ 1900 MHz;
- Sensor-Surface: 4mm (Mechanical Surface Detection)
- Electronics: DAE4 Sn1562; Calibrated: 2020/03/10
- Phantom: SAM-Twin V8.0 P1aP2a; Type: QD 000 P41 AA ; Serial: 1962
- Measurement SW: DASY52, Version 52.10 (2);

Head 1900MHz Pin=100mW/Area Scan (81x121x1): Interpolated grid: $dx=1.000 \text{ mm}$, $dy=1.000 \text{ mm}$

Maximum value of SAR (interpolated) = 5.54 W/kg

Head 1900MHz Pin=100mW/Zoom Scan (7x7x7)/Cube 0: Measurement grid: $dx=5\text{mm}$, $dy=5\text{mm}$, $dz=5\text{mm}$

Reference Value = 56.48 V/m; Power Drift = -0.14 dB

Peak SAR (extrapolated) = 5.48 W/kg

SAR(1 g) = 4.12 W/kg; SAR(10 g) = 2.04 W/kg

Maximum value of SAR (measured) = 4.62 W/kg

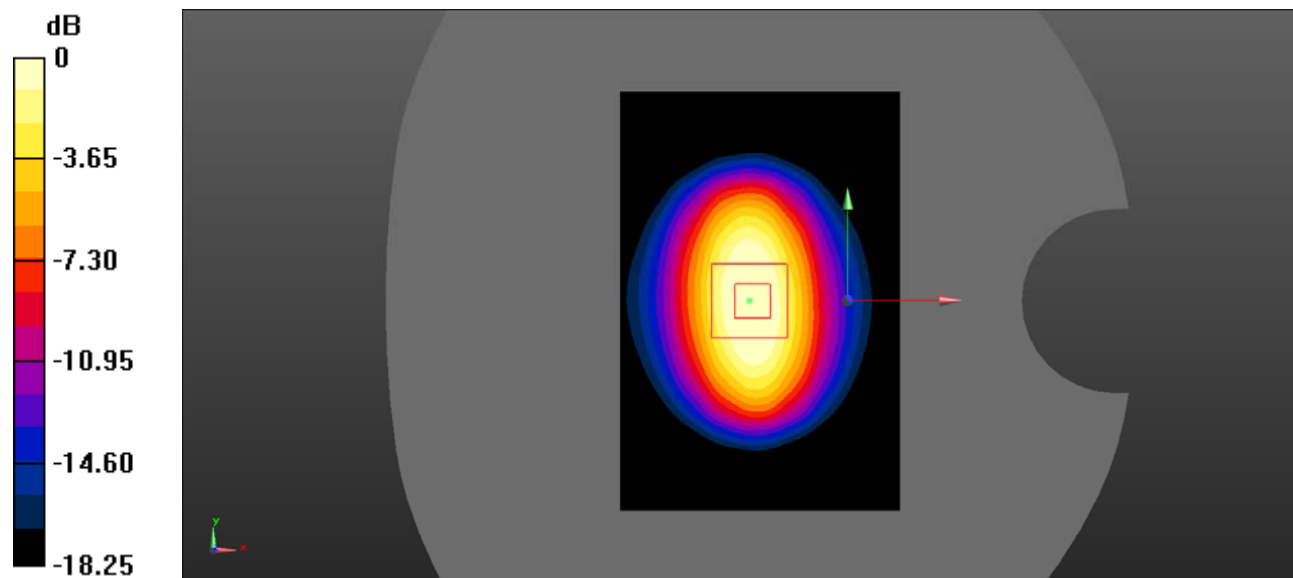

0 dB = 4.62 W/kg = 6.65 dBW/kg

System Performance 2600 Head

DUT: Dipole 2600 Type: D2600V2; Serial: 1162

Communication System: UID 0, CW (0); Frequency: 2600 MHz; Duty Cycle: 1:1
 Medium parameters used: $f = 2600 \text{ MHz}$; $\sigma = 1.987 \text{ S/m}$; $\epsilon_r = 39.128$; $\rho = 1000 \text{ kg/m}^3$
 Phantom section: Flat Section

DASY5 Configuration:

- Probe: EX3DV4 - SN7441; ConvF(7.35, 7.35, 7.35) @ 2600 MHz;
- Sensor-Surface: 4mm (Mechanical Surface Detection)
- Electronics: DAE4 Sn1562; Calibrated: 2020/03/10
- Phantom: SAM-Twin V8.0 P1aP2a; Type: QD 000 P41 AA ; Serial: 1962
- Measurement SW: DASY52, Version 52.10 (2);

Head 2600MHz Pin=100mW/Area Scan (81x121x1): Interpolated grid: $dx=1.000 \text{ mm}$, $dy=1.000 \text{ mm}$
 Maximum value of SAR (interpolated) = 8.02 W/kg

Head 2600MHz Pin=100mW/Zoom Scan (7x7x7)/Cube 0: Measurement grid: $dx=5\text{mm}$, $dy=5\text{mm}$, $dz=5\text{mm}$
 Reference Value = 51.52V/m; Power Drift = -0.12 dB

Peak SAR (extrapolated) = 8.59 W/kg

SAR(1 g) = 5.64 W/kg; SAR(10 g) = 2.55 W/kg

Maximum value of SAR (measured) = 6.58W/kg

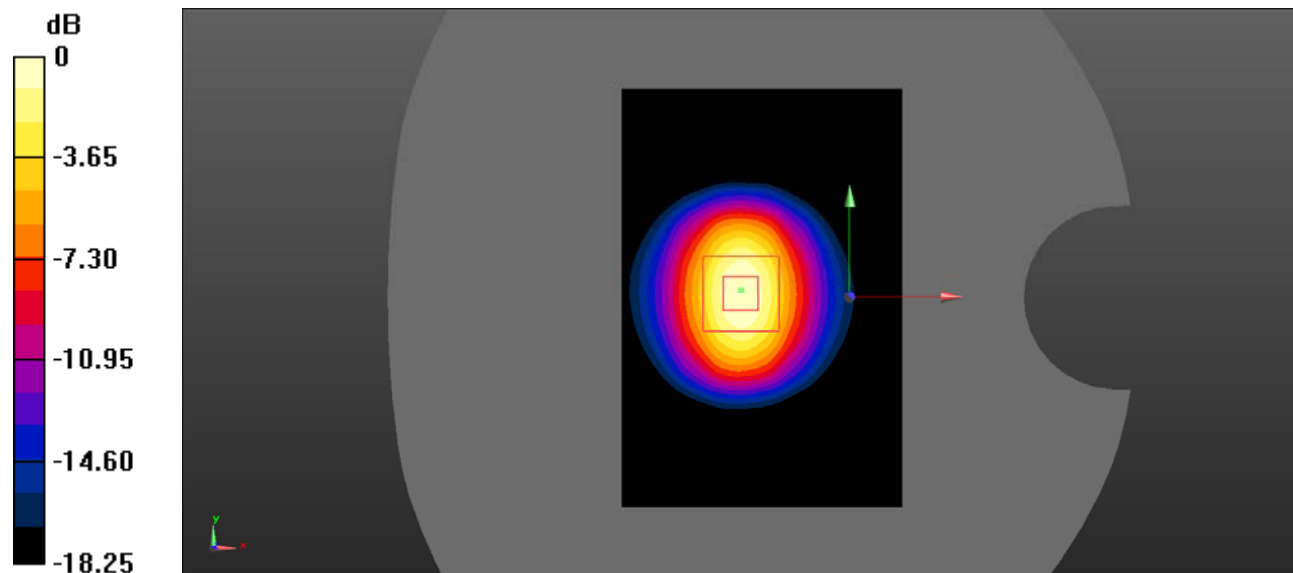

0 dB = 6.58 W/kg = 8.18 dBW/kg

EUT TEST STRATEGY AND METHODOLOGY

Test Positions for Device Operating Next to a Person’s Ear

This category includes most wireless handsets with fixed, retractable or internal antennas located toward the top half of the device, with or without a foldout, sliding or similar keypad cover. The handset should have its earpiece located within the upper ¼ of the device, either along the centerline or off-centered, as perceived by its users. This type of handset should be positioned in a normal operating position with the “test device reference point” located along the “vertical centerline” on the front of the device aligned to the “ear reference point”. The “test device reference point” should be located at the same level as the center of the earpiece region. The “vertical centerline” should bisect the front surface of the handset at its top and bottom edges. A “ear reference point” is located on the outer surface of the head phantom on each ear spacer. It is located 1.5 cm above the center of the ear canal entrance in the “phantom reference plane” defined by the three lines joining the center of each “ear reference point” (left and right) and the tip of the mouth.

A handset should be initially positioned with the earpiece region pressed against the ear spacer of a head phantom. For the SCC-34/SC-2 head phantom, the device should be positioned parallel to the “N-F” line defined along the base of the ear spacer that contains the “ear reference point”. For interim head phantoms, the device should be positioned parallel to the cheek for maximum RF energy coupling. The “test device reference point” is aligned to the “ear reference point” on the head phantom and the “vertical centerline” is aligned to the “phantom reference plane”. This is called the “initial ear position”. While maintaining these three alignments, the body of the handset is gradually adjusted to each of the following positions for evaluating SAR:

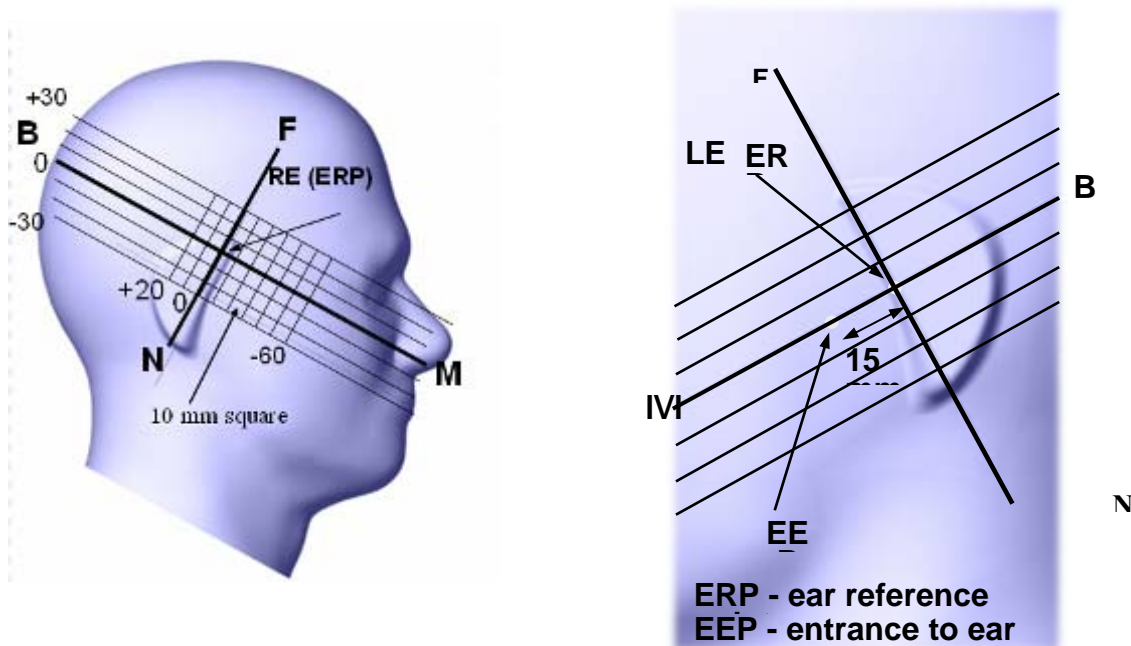

Cheek/Touch Position

The device is brought toward the mouth of the head phantom by pivoting against the “ear reference point” or along the “N-F” line for the SCC-34/SC-2 head phantom.

This test position is established:

When any point on the display, keypad or mouthpiece portions of the handset is in contact with the phantom.

(or) When any portion of a foldout, sliding or similar keypad cover opened to its intended self-adjusting normal use position is in contact with the cheek or mouth of the phantom.

For existing head phantoms – when the handset loses contact with the phantom at the pivoting point, rotation should continue until the device touches the cheek of the phantom or breaks its last contact from the ear spacer.

Cheek /Touch Position

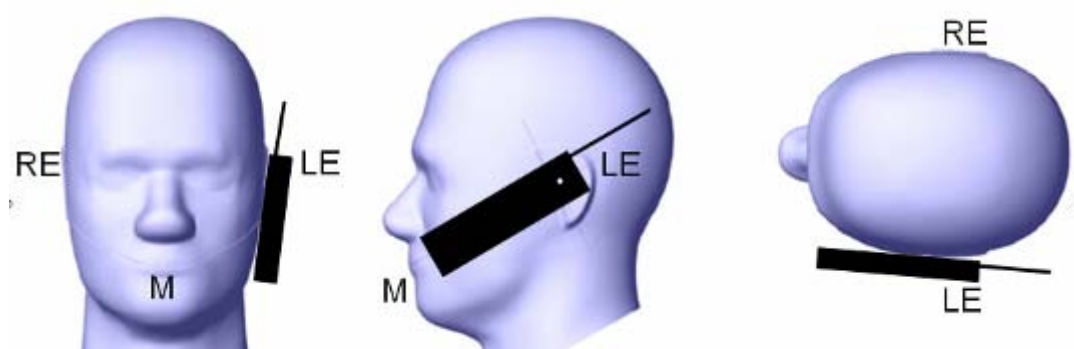

Ear/Tilt Position

With the handset aligned in the “Cheek/Touch Position”:

1) If the earpiece of the handset is not in full contact with the phantom’s ear spacer (in the “Cheek/Touch position”) and the peak SAR location for the “Cheek/Touch” position is located at the ear spacer region or corresponds to the earpiece region of the handset, the device should be returned to the “initial ear position” by rotating it away from the mouth until the earpiece is in full contact with the ear spacer.

2) (otherwise) The handset should be moved (translated) away from the cheek perpendicular to the line passes through both “ear reference points” (note: one of these ear reference points may not physically exist on a split head model) for approximate 2-3 cm. While it is in this position, the device handset is tilted away from the mouth with respect to the “test device reference point” until the inside angle between the vertical centerline on the front surface of the phone and the horizontal line passing through the ear reference point is by 15° to 80° . After the tilt, it is then moved (translated) back toward the head perpendicular to the line passes through both “ear reference points” until the device touches the phantom or the ear spacer. If the antenna touches the head first, the positioning process should be repeated with a tilt angle less than 15° so that the device and its antenna would touch the phantom simultaneously. This test position may require a device holder or positioner to achieve the translation and tilting with acceptable positioning repeatability.

If a device is also designed to transmit with its keypad cover closed for operating in the head position, such positions should also be considered in the SAR evaluation. The device should be tested on the left and right side of the head phantom in the “Cheek/Touch” and “Ear/Tilt” positions. When applicable, each configuration should be tested with the antenna in its fully extended and fully retracted positions. These test configurations should be tested at the high, middle and low frequency channels of each operating mode; for example, AMPS, CDMA, and TDMA. If the SAR measured at the middle channel for each test configuration (left, right, Cheek/Touch, Tilt/Ear, extended and retracted) is at least 2.0 dB lower than the SAR limit, testing at the high and low channels is optional for such test configuration(s). If the transmission band of the test device is less than 10 MHz, testing at the high and low frequency channels is optional.

Ear /Tilt 15° Position

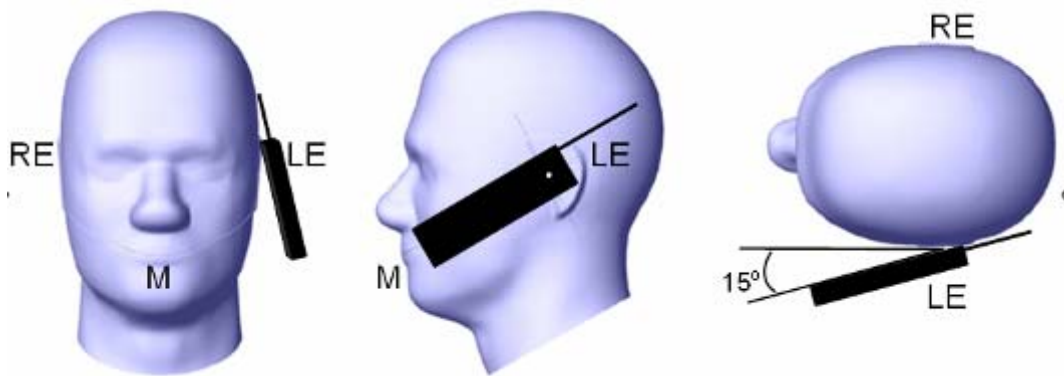

Test positions for body-worn and other configurations

Body-worn operating configurations should be tested with the belt-clips and holsters attached to the device and positioned against a flat phantom in normal use configurations. Devices with a headset output should be tested with a headset connected to the device. When multiple accessories that do not contain metallic components are supplied with the device, the device may be tested with only the accessory that dictates the closest spacing to the body. When multiple accessories that contain metallic components are supplied with the device, the device must be tested with each accessory that contains a unique metallic component. If multiple accessories share an identical metallic component (e.g., the same metallic belt-clip used with different holsters with no other metallic components), only the accessory that dictates the closest spacing to the body must be tested.

Body-worn accessories may not always be supplied or available as options for some devices that are intended to be authorized for body-worn use. A separation distance of 1.5 cm between the back of the device and a flat phantom is recommended for testing body-worn SAR compliance under such circumstances. Other separation distances may be used, but they should not exceed 2.5 cm. In these cases, the device may use body-worn accessories that provide a separation distance greater than that tested for the device provided however that the accessory contains no metallic components.

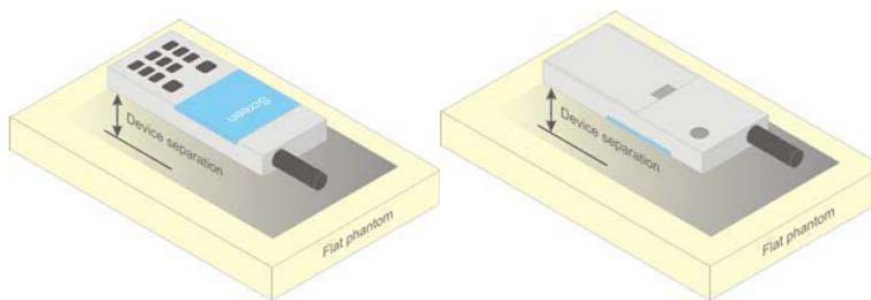

Figure 5 – Test positions for body-worn devices

Test Distance for SAR Evaluation

For this case the EUT(Equipment Under Test) is set 10mm away from the phantom, the test distance is 10mm.

SAR Evaluation Procedure

The evaluation was performed with the following procedure:

Step 1: Measurement of the SAR value at a fixed location above the ear point or central position was used as a reference value for assessing the power drop. The SAR at this point is measured at the start of the test and then again at the end of the testing.

Step 2: The SAR distribution at the exposed side of the head was measured at a distance of 4 mm from the inner surface of the shell. The area covered the entire dimension of the head or radiating structures of the EUT, the horizontal grid spacing was 15 mm x 15 mm, and the SAR distribution was determined by integrated grid of 1.5mm x 1.5mm. Based on these data, the area of the maximum absorption was determined by spline interpolation. The first Area Scan covers the entire dimension of the EUT to ensure that the hotspot was correctly identified.

Step 3: Around this point, a volume of 30 mm x 30 mm x 30 mm was assessed by measuring 7x 7 x 7 points. On the basis of this data set, the spatial peak SAR value was evaluated under the following procedure:

- 1) The data at the surface were extrapolated, since the center of the dipoles is 1.2 mm away from the tip of the probe and the distance between the surface and the lowest measuring point is 1.3 mm. The extrapolation was based on a least square algorithm. A polynomial of the fourth order was calculated through the points in z-axes. This polynomial was then used to evaluate the points between the surface and the probe tip.

- 2) The maximum interpolated value was searched with a straightforward algorithm. Around this maximum the SAR values averaged over the spatial volumes (1 g or 10 g) were computed by the 3D-Spline interpolation algorithm. The 3D-Spline is composed of three one dimensional splines with the "Not a knot"-condition (in x, y and z-directions). The volume was integrated with the trapezoidal-algorithm. One thousand points (10 x 10 x 10) were interpolated to calculate the averages.

All neighboring volumes were evaluated until no neighboring volume with a higher average value was found.

Step 4: Re-measurement of the SAR value at the same location as in Step 1. If the value changed by more than 5%, the evaluation was repeated.

CONDUCTED OUTPUT POWER MEASUREMENT

Provision Applicable

The measured peak output power should be greater and within 5% than EMI measurement.

Test Procedure

The RF output of the transmitter was connected to the input of the EMI Test Receiver through Connector.

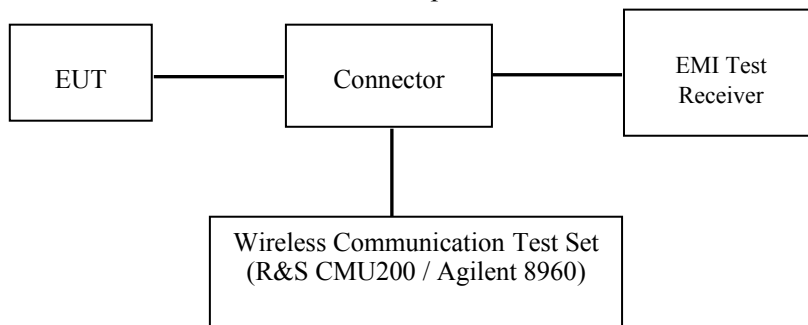

GSM/WCDMA

Radio Configuration

The power measurement was configured by the Wireless Communication Test Set.

GSM/GPRS

Function: Menu select > GSM Mobile Station > GSM 850/1900

Press Connection control to choose the different menus

Press RESET > choose all the reset all settings

Connection Press Signal Off to turn off the signal and change settings

Network Support > GSM + GPRS or GSM + EGSM

Main Service > Packet Data

Service selection > Test Mode A – Auto Slot Config. off

MS Signal Press Slot Config Bottom on the right twice to select and change the number of time slots and power setting

> Slot configuration > Uplink/Gamma

> 33 dBm for GPRS 850

> 30 dBm for GPRS 1900

BS Signal Enter the same channel number for TCH channel (test channel) and BCCH channel

Frequency Offset > + 0 Hz

Mode > BCCH and TCH

BCCH Level > -85 dBm (May need to adjust if link is not stable)

BCCH Channel > choose desired test channel [Enter the same channel number for TCH channel (test channel) and BCCH channel]

Channel Type > Off

P0 > 4 dB

Slot Config > Unchanged (if already set under MS signal)

TCH > choose desired test channel

Hopping > Off

Main Timeslot > 3

Network Coding Scheme > CS4 (GPRS)

Bit Stream > 2E9-1 PSR Bit Stream

AF/RF Enter appropriate offsets for Ext. Att. Output and Ext. Att. Input

Connection Press Signal on to turn on the signal and change settings

WCDMA Release 99

The following tests were conducted according to the test requirements outlines in section 5.2 of the 3GPP TS34.121-1 specification. The EUT has a nominal maximum output power of 24dBm (+1.7/-3.7).

| | | |
|-----------------------------------|-------------------------|--------------|
| WCDMA General Settings | Loopback Mode | Test Mode 1 |
| | Rel99 RMC | 12.2kbps RMC |
| | Power Control Algorithm | Algorithm2 |
| | β_c/β_d | 8/15 |

HSDPA

The following tests were conducted according to the test requirements outlines in section 5.2 of the 3GPP TS34.121-1 specification.

| | Mode | HSDPA | HSDPA | HSDPA | HSDPA |
|------------------------------------|-----------------------------|--------------|-------|-------|-------|
| | Subset | 1 | 2 | 3 | 4 |
| WCDMA General Settings | Loopback Mode | Test Mode 1 | | | |
| | Rel99 RMC | 12.2kbps RMC | | | |
| | HSDPA FRC | H-Set1 | | | |
| | Power Control Algorithm | Algorithm2 | | | |
| | β_c | 2/15 | 12/15 | 15/15 | 15/15 |
| | β_d | 15/15 | 15/15 | 8/15 | 4/15 |
| | $\beta_d(SF)$ | 64 | | | |
| | β_c/β_d | 2/15 | 12/15 | 15/8 | 15/4 |
| | β_{hs} | 4/15 | 24/15 | 30/15 | 30/15 |
| MPR(dB) | 0 | 0 | 0.5 | 0.5 | |
| HSDPA Specific Settings | DACK | 8 | | | |
| | DNAK | 8 | | | |
| | DCQI | 8 | | | |
| | Ack-Nack repetition factor | 3 | | | |
| | CQI Feedback | 4ms | | | |
| | CQI Repetition Factor | 2 | | | |
| | $A_{hs}=\beta_{hs}/\beta_c$ | 30/15 | | | |

HSUPA

The following tests were conducted according to the test requirements outlines in section 5.2 of the 3GPP TS34.121-1 specification.

| | Mode | HSUPA | HSUPA | HSUPA | HSUPA | HSUPA |
|--------------------------------|----------------------------------|---|---|---|--------------|--------------|
| | Subset | 1 | 2 | 3 | 4 | 5 |
| WCDMA General Settings | Loopback Mode | Test Mode 1 | | | | |
| | Rel99 RMC | 12.2kbps RMC | | | | |
| | HSDPA FRC | H-Set1 | | | | |
| | HSUPA Test | HSUPA Loopback | | | | |
| | Power Control Algorithm | Algorithm2 | | | | |
| | β_c | 11/15 | 6/15 | 15/15 | 2/15 | 15/15 |
| | β_d | 15/15 | 15/15 | 9/15 | 15/15 | 0 |
| | β_{cc} | 209/225 | 12/15 | 30/15 | 2/15 | 5/15 |
| | β_c / β_d | 11/15 | 6/15 | 15/9 | 2/15 | - |
| | β_{hs} | 22/15 | 12/15 | 30/15 | 4/15 | 5/15 |
| | CM(dB) | 1.0 | 3.0 | 2.0 | 3.0 | 1.0 |
| MPR(dB) | 0 | 2 | 1 | 2 | 0 | |
| HSDPA Specific Settings | DACK | 8 | | | | |
| | DNAK | 8 | | | | |
| | DCQI | 8 | | | | |
| | Ack-Nack repetition factor | 3 | | | | |
| | CQI Feedback | 4ms | | | | |
| | CQI Repetition Factor | 2 | | | | |
| | $A_{hs} = \beta_{hs} / \beta_c$ | 30/15 | | | | |
| HSUPA Specific Settings | DE-DPCCH | 6 | 8 | 8 | 5 | 7 |
| | DHARQ | 0 | 0 | 0 | 0 | 0 |
| | AG Index | 20 | 12 | 15 | 17 | 21 |
| | ETFCI | 75 | 67 | 92 | 71 | 81 |
| | Associated Max UL Data Rate kbps | 242.1 | 174.9 | 482.8 | 205.8 | 308.9 |
| | Reference E_FCIs | E-TFCI 11 E-TFCI PO 4 E-TFCI 67 E-TFCI PO 18 E-TFCI 71 E-TFCI PO23 E-TFCI 75 E-TFCI PO26 E-TFCI 81 E-TFCI PO 27 | E-TFCI 11 E-TFCI PO4 E-TFCI 92 E-TFCI PO 18 | E-TFCI 11 E-TFCI PO 4 E-TFCI 67 E-TFCI PO 18 E-TFCI 71 E-TFCI PO23 E-TFCI 75 E-TFCI PO26 E-TFCI 81 E-TFCI PO 27 | | |

FDD-LTE

For UE Power Class 1 and 3, the allowed Maximum Power Reduction (MPR) for the maximum output power in Table 6.2.2-1 due to higher order modulation and transmit bandwidth configuration (resource blocks) is specified in Table 6.2.3-1.

Table 6.2.3-1: Maximum Power Reduction (MPR) for Power Class 1 and 3

| Modulation | Channel bandwidth / Transmission bandwidth (N_{RB}) | | | | | | MPR (dB) |
|------------|---|---------|-------|--------|--------|--------|----------|
| | 1.4 MHz | 3.0 MHz | 5 MHz | 10 MHz | 15 MHz | 20 MHz | |
| QPSK | > 5 | > 4 | > 8 | > 12 | > 16 | > 18 | ≤ 1 |
| 16 QAM | ≤ 5 | ≤ 4 | ≤ 8 | ≤ 12 | ≤ 16 | ≤ 18 | ≤ 1 |
| 16 QAM | > 5 | > 4 | > 8 | > 12 | > 16 | > 18 | ≤ 2 |

For UE Power Class 1 and 3 the specific requirements and identified sub clauses are specified in Table 6.2.4-1 along with the allowed A-MPR values that may be used to meet these requirements. The allowed A-MPR values specified below in Table 6.2.4.-1 to 6.2.4-15 are in addition to the allowed MPR requirements specified in sub clause 6.2.3.

Table 6.2.4-1: Additional Maximum Power Reduction (A-MPR)

| Network Signalling value | Requirements (subclause) | E-UTRA Band | Channel bandwidth (MHz) | Resources Blocks (N_{RB}) | A-MPR (dB) |
|--------------------------|-------------------------------|--------------------------|-------------------------|---|------------|
| NS_01 | 6.6.2.1.1 | Table 5.5-1 | 1.4, 3, 5, 10, 15, 20 | Table 5.6-1 | N/A |
| NS_03 | 6.6.2.2.1 | 2, 4, 10, 23, 25, 35, 36 | 3 | >5 | ≤ 1 |
| | | | 5 | >6 | ≤ 1 |
| | | | 10 | >6 | ≤ 1 |
| | | | 15 | >8 | ≤ 1 |
| | | | 20 | >10 | ≤ 1 |
| NS_04 | 6.6.2.2.2 | 41 | 5 | >6 | ≤ 1 |
| NS_05 | 6.6.3.3.1 | 1 | 10, 15, 20 | Table 6.2.4-4 | ≤ 1 |
| NS_06 | 6.6.2.2.3 | 12, 13, 14, 17 | 1.4, 3, 5, 10 | Table 5.6-1 | N/A |
| NS_07 | 6.6.2.2.3 | 13 | 10 | Table 6.2.4-2 | |
| 6.6.3.3.2 | | | | | |
| NS_08 | 6.6.3.3.3 | 19 | 10, 15 | > 44 | ≤ 3 |
| NS_09 | 6.6.3.3.4 | 21 | 10, 15 | > 40 | ≤ 1 |
| | | | | > 55 | ≤ 2 |
| | | | | Table 6.2.4-3 | |
| NS_11 | 6.6.2.2.1 | 23 | 1.4, 3, 5, 10, 15, 20 | Table 6.2.4-5 | |
| NS_12 | 6.6.3.3.5 | 26 | 1.4, 3, 5 | Table 6.2.4-6 | |
| NS_13 | 6.6.3.3.6 | 26 | 5 | Table 6.2.4-7 | |
| NS_14 | 6.6.3.3.7 | 26 | 10, 15 | Table 6.2.4-8 | |
| NS_15 | 6.6.3.3.8 | 26 | 1.4, 3, 5, 10, 15 | Table 6.2.4-9 Table 6.2.4-10 | |
| NS_16 | 6.6.3.3.9 | 27 | 3, 5, 10 | Table 6.2.4-11, Table 6.2.4-12, Table 6.2.4-13 | |
| NS_17 | 6.6.3.3.10 | 28 | 5, 10 | Table 5.6-1 | N/A |
| NS_18 | 6.6.3.3.11 | 28 | 5 | ≥ 2 | ≤ 1 |
| | | | 10, 15, 20 | ≥ 1 | ≤ 4 |
| NS_19 | 6.6.3.3.12 | 44 | 10, 15, 20 | Table 6.2.4-14 | |
| NS_20 | 6.2.2 6.6.2.2.1 6.6.3.2 | 23 | 5, 10, 15, 20 | Table 6.2.4-15 | |
| ... | | | | | |
| NS_32 | - | - | - | - | - |

Maximum Target Output Power

| Max Target Power(dBm) | | | |
|------------------------------|----------------|---------------|-------------|
| Mode/Band | Channel | | |
| | Low | Middle | High |
| GSM 850 | 33.0 | 33.0 | 33.0 |
| GPRS 1 TX Slot | 33.0 | 33.0 | 33.0 |
| GPRS 2 TX Slot | 31.0 | 31.0 | 31.0 |
| GPRS 3 TX Slot | 28.5 | 28.5 | 28.5 |
| GPRS 4 TX Slot | 27.5 | 27.5 | 27.5 |
| EGPRS 1 TX Slot | 28.0 | 28.0 | 28.0 |
| EGPRS 2 TX Slot | 25.5 | 25.5 | 25.5 |
| EGPRS 3 TX Slot | 24.5 | 24.5 | 24.5 |
| EGPRS 4 TX Slot | 21.5 | 21.5 | 21.5 |
| PCS 1900 | 30.5 | 30.5 | 30.5 |
| GPRS 1 TX Slot | 31.0 | 31.0 | 31.0 |
| GPRS 2 TX Slot | 28.5 | 28.5 | 28.5 |
| GPRS 3 TX Slot | 27.0 | 27.0 | 27.0 |
| GPRS 4 TX Slot | 26.0 | 26.0 | 26.0 |
| EGPRS 1 TX Slot | 27.0 | 27.0 | 27.0 |
| EGPRS 2 TX Slot | 25.0 | 25.0 | 25.0 |
| EGPRS 3 TX Slot | 22.5 | 22.5 | 22.5 |
| EGPRS 4 TX Slot | 21.0 | 21.0 | 21.0 |
| WCDMA Band 2 | 23.0 | 23.0 | 23.0 |
| HSDPA | 22.0 | 22.0 | 22.0 |
| HSUPA | 22.0 | 22.0 | 22.0 |
| WCDMA Band 5 | 23.0 | 23.0 | 23.0 |
| HSDPA | 22.0 | 22.0 | 22.0 |
| HSUPA | 22.0 | 22.0 | 22.0 |
| LTE Band 2 | 22.5 | 22.5 | 22.5 |
| LTE Band 4 | 23.0 | 23.0 | 23.0 |
| LTE Band 7 | 23.0 | 23.0 | 23.0 |
| LTE Band 12 | 23.0 | 23.0 | 23.0 |
| LTE Band 17 | 23.0 | 23.0 | 23.0 |
| WLAN 2.4G | 9.5 | 9.5 | 9.5 |
| Bluetooth BDR/EDR | 4.0 | 5.5 | 5.5 |
| Bluetooth BLE | 3.0 | 5.5 | 5.5 |

Test Results:

GSM:

| Band | Channel No. | Frequency (MHz) | RF Output Power (dBm) |
|----------|-------------|-----------------|-----------------------|
| GSM 850 | 128 | 824.2 | 32.26 |
| | 190 | 836.6 | 32.71 |
| | 251 | 848.8 | 32.52 |
| PCS 1900 | 512 | 1850.2 | 29.91 |
| | 661 | 1880.0 | 29.68 |
| | 810 | 1909.8 | 29.80 |

GPRS:

| Band | Channel No. | Frequency (MHz) | RF Output Power (dBm) | | | |
|----------|-------------|-----------------|-----------------------|---------|---------|---------|
| | | | 1 slot | 2 slots | 3 slots | 4 slots |
| GSM 850 | 128 | 824.2 | 32.65 | 30.60 | 28.23 | 27.24 |
| | 190 | 836.6 | 32.63 | 30.54 | 28.20 | 27.14 |
| | 251 | 848.8 | 32.42 | 30.65 | 28.02 | 27.28 |
| PCS 1900 | 512 | 1850.2 | 30.71 | 28.14 | 26.87 | 25.59 |
| | 661 | 1880 | 30.64 | 28.17 | 26.87 | 25.58 |
| | 810 | 1909.8 | 30.69 | 28.14 | 26.95 | 25.70 |

EGPRS:

| Band | Channel No. | Frequency (MHz) | RF Output Power (dBm) | | | |
|----------|-------------|-----------------|-----------------------|---------|---------|---------|
| | | | 1 slot | 2 slots | 3 slots | 4 slots |
| GSM 850 | 128 | 824.2 | 27.34 | 25.05 | 23.93 | 21.11 |
| | 190 | 836.6 | 27.40 | 25.17 | 23.95 | 21.29 |
| | 251 | 848.8 | 27.56 | 25.22 | 23.98 | 21.13 |
| PCS 1900 | 512 | 1850.2 | 26.46 | 24.68 | 22.16 | 20.71 |
| | 661 | 1880 | 26.48 | 24.46 | 22.38 | 20.49 |
| | 810 | 1909.8 | 26.53 | 24.52 | 22.22 | 20.46 |

For SAR, the time based average power is relevant, the difference in between depends on the duty cycle of the TDMA signal.

| Number of Time slot | 1 | 2 | 3 | 4 |
|--|-------|-------|----------|-------|
| Duty Cycle | 1:8 | 1:4 | 1:2.66 | 1:2 |
| Time based Ave. power compared to slotted Ave. power | -9 dB | -6 dB | -4.25 dB | -3 dB |
| Crest Factor | 8 | 4 | 2.66 | 2 |

The time based average power for GPRS

| Band | Channel No. | Frequency (MHz) | Time based average Power (dBm) | | | |
|----------|-------------|-----------------|--------------------------------|--------------|--------------|---------|
| | | | 1 slot | 2 slot | 3 slots | 4 slots |
| GSM 850 | 128 | 824.2 | 23.65 | 24.60 | 23.98 | 24.24 |
| | 190 | 836.6 | 23.63 | 24.54 | 23.95 | 24.14 |
| | 251 | 848.8 | 23.42 | 24.65 | 23.77 | 24.28 |
| PCS 1900 | 512 | 1850.2 | 21.71 | 22.14 | 22.62 | 22.59 |
| | 661 | 1880 | 21.64 | 22.17 | 22.62 | 22.58 |
| | 810 | 1909.8 | 21.69 | 22.14 | 22.70 | 22.70 |

The time based average power for EGPRS

| Band | Channel No. | Frequency (MHz) | Time based average Power (dBm) | | | |
|----------|-------------|-----------------|--------------------------------|--------|---------|---------|
| | | | 1 slot | 2 slot | 3 slots | 4 slots |
| GSM 850 | 128 | 824.2 | 18.34 | 19.05 | 19.68 | 18.11 |
| | 190 | 836.6 | 18.40 | 19.17 | 19.70 | 18.29 |
| | 251 | 848.8 | 18.56 | 19.22 | 19.73 | 18.13 |
| PCS 1900 | 512 | 1850.2 | 17.46 | 18.68 | 17.91 | 17.71 |
| | 661 | 1880 | 17.48 | 18.46 | 18.13 | 17.49 |
| | 810 | 1909.8 | 17.53 | 18.52 | 17.97 | 17.46 |

Note:

1. Rohde & Schwarz Radio Communication Tester (CMU200) was used for the measurement of GSM peak and average output power for active timeslots.
2. For GSM voice, 1 timeslot has been activated with power level 5 (850 MHz band) and 0 (1900 MHz band).
3. For GPRS, 1, 2, 3 and 4 timeslots has been activated separately with power level 3(850 MHz band) and 3(1900 MHz band).

WCDMA Band 2:

| Test Condition | Test Mode | 3GPP Sub Test | Averaged Mean Power (dBm) | | |
|----------------|-----------|---------------|---------------------------|---------------|----------------|
| | | | Low Frequency | Mid Frequency | High Frequency |
| Normal | RMC12.2k | | 22.76 | 22.56 | 22.59 |
| | HSDPA | 1 | 21.63 | 21.50 | 21.69 |
| | | 2 | 21.52 | 21.65 | 21.44 |
| | | 3 | 21.31 | 21.72 | 21.43 |
| | | 4 | 21.44 | 21.74 | 21.58 |
| | | 5 | 21.25 | 21.86 | 21.36 |
| | HSUPA | 1 | 21.14 | 21.09 | 21.23 |
| | | 2 | 21.28 | 21.27 | 21.05 |
| | | 3 | 21.30 | 21.34 | 21.18 |
| | | 4 | 21.38 | 21.55 | 21.21 |
| | | 5 | 21.25 | 21.43 | 21.26 |

WCDMA Band 5:

| Test Condition | Test Mode | 3GPP Sub Test | Averaged Mean Power (dBm) | | |
|----------------|-----------|---------------|---------------------------|---------------|----------------|
| | | | Low Frequency | Mid Frequency | High Frequency |
| Normal | RMC12.2k | | 22.80 | 22.55 | 22.59 |
| | HSDPA | 1 | 21.62 | 21.45 | 21.70 |
| | | 2 | 21.50 | 21.69 | 21.36 |
| | | 3 | 21.39 | 21.74 | 21.41 |
| | | 4 | 21.45 | 21.79 | 21.51 |
| | | 5 | 21.29 | 21.77 | 21.47 |
| | HSUPA | 1 | 21.13 | 21.08 | 21.18 |
| | | 2 | 21.23 | 21.24 | 21.07 |
| | | 3 | 21.13 | 21.42 | 21.19 |
| | | 4 | 21.29 | 21.42 | 21.18 |
| | | 5 | 21.26 | 21.53 | 21.32 |

Note:

1. The default test configuration is to measure SAR with an established radio link between the EUT and a communication test set using a 12.2 kbps RMC (reference measurement Channel) Configured in Test Loop Model 1.
2. KDB 941225 D01-Body SAR is not required for HSDPA/HSUPA when the maximum average output of each RF channel is less than ¼ dB higher than measured 12.2kbps RMC or the maximum SAR for 12.2kbps RMC is < 75% of SAR limit.

LTE Band 2:

| BW (MHz) | Modulation | Resource Block Size & Resource Block Offset | Target MPR | Meas MPR | Ave Tx Power (dBm) | | |
|----------|------------|---|------------|----------|--------------------|-------------|--------------|
| | | | | | Low Channel | Mid Channel | High Channel |
| | | | | | 1850.7MHz | 1880MHz | 1909.3MHz |
| 1.4 | QPSK | RB Size=1, RB Offset=0 | 0 | 0 | 21.45 | 21.48 | 21.44 |
| | | RB Size=1, RB Offset=3 | 0 | 0 | 21.28 | 21.11 | 21.36 |
| | | RB Size=1, RB Offset=5 | 0 | 0 | 21.66 | 21.39 | 21.17 |
| | | RB Size=3, RB Offset=0 | 1 | 1 | 21.20 | 21.16 | 21.52 |
| | | RB Size=3, RB Offset=3 | 1 | 1 | 21.53 | 21.58 | 21.54 |
| | | RB Size=6, RB Offset=0 | 1 | 1 | 21.12 | 21.33 | 21.32 |
| | 16QAM | RB Size=1, RB Offset=0 | 1 | 1 | 21.47 | 21.67 | 21.24 |
| | | RB Size=1, RB Offset=3 | 1 | 1 | 21.70 | 21.79 | 21.59 |
| | | RB Size=1, RB Offset=5 | 1 | 1 | 21.22 | 21.61 | 21.49 |
| | | RB Size=3, RB Offset=0 | 2 | 2 | 21.53 | 21.79 | 21.30 |
| | | RB Size=3, RB Offset=3 | 2 | 2 | 21.15 | 21.63 | 21.25 |
| | | RB Size=6, RB Offset=0 | 2 | 2 | 21.17 | 21.22 | 21.59 |
| BW (MHz) | Modulation | Resource Block Size & Resource Block Offset | Target MPR | Meas MPR | Ave Tx Power (dBm) | | |
| | | | | | Low Channel | Mid Channel | High Channel |
| | | | | | 1851.5MHz | 1880MHz | 1908.5MHz |
| 3 | QPSK | RB Size=1, RB Offset=0 | 0 | 0 | 21.52 | 21.57 | 21.51 |
| | | RB Size=1, RB Offset=8 | 0 | 0 | 21.42 | 21.32 | 21.44 |
| | | RB Size=1, RB Offset=14 | 0 | 0 | 21.56 | 21.29 | 21.35 |
| | | RB Size=6, RB Offset=0 | 1 | 1 | 21.40 | 21.69 | 21.41 |
| | | RB Size=6, RB Offset=9 | 1 | 1 | 21.36 | 21.54 | 21.59 |
| | | RB Size=15, RB Offset=0 | 1 | 1 | 21.52 | 21.39 | 21.37 |
| | 16QAM | RB Size=1, RB Offset=0 | 1 | 1 | 21.21 | 21.14 | 21.37 |
| | | RB Size=1, RB Offset=8 | 1 | 1 | 21.54 | 21.29 | 21.53 |
| | | RB Size=1, RB Offset=14 | 1 | 1 | 21.48 | 21.34 | 21.26 |
| | | RB Size=6, RB Offset=0 | 2 | 2 | 21.32 | 21.78 | 21.82 |
| | | RB Size=8, RB Offset=9 | 2 | 2 | 21.65 | 21.62 | 21.54 |
| | | RB Size=15, RB Offset=0 | 2 | 2 | 21.78 | 21.73 | 21.28 |

| BW (MHz) | Modulation | Resource Block Size & Resource Block Offset | Target MPR | Meas MPR | Ave Tx Power (dBm) | | |
|-------------------------|------------|---|------------|----------|--------------------|-------------|--------------|
| | | | | | Low Channel | Mid Channel | High Channel |
| | | | | | 1852.5MHz | 1880MHz | 1907.5MHz |
| 5 | QPSK | RB Size=1, RB Offset=0 | 0 | 0 | 21.79 | 22.00 | 21.95 |
| | | RB Size=1, RB Offset=13 | 0 | 0 | 21.77 | 22.16 | 21.97 |
| | | RB Size=1, RB Offset=24 | 0 | 0 | 22.09 | 21.97 | 21.70 |
| | | RB Size=15, RB Offset=0 | 1 | 1 | 21.59 | 22.08 | 21.93 |
| | | RB Size=15, RB Offset=10 | 1 | 1 | 22.03 | 22.13 | 22.14 |
| | | RB Size=25, RB Offset=0 | 1 | 1 | 22.02 | 22.07 | 22.04 |
| | 16QAM | RB Size=1, RB Offset=0 | 1 | 1 | 21.96 | 21.74 | 22.12 |
| | | RB Size=1, RB Offset=13 | 1 | 1 | 21.87 | 21.99 | 21.75 |
| | | RB Size=1, RB Offset=24 | 1 | 1 | 21.54 | 21.87 | 21.87 |
| | | RB Size=15, RB Offset=0 | 2 | 2 | 21.82 | 22.12 | 22.23 |
| | | RB Size=15, RB Offset=10 | 2 | 2 | 21.95 | 21.88 | 21.68 |
| RB Size=25, RB Offset=0 | 2 | 2 | 21.78 | 21.72 | 21.85 | | |
| BW (MHz) | Modulation | Resource Block Size & Resource Block Offset | Target MPR | Meas MPR | Ave Tx Power (dBm) | | |
| | | | | | Low Channel | Mid Channel | High Channel |
| | | | | | 1855MHz | 1880MHz | 1905MHz |
| 10 | QPSK | RB Size=1, RB Offset=0 | 0 | 0 | 21.72 | 21.89 | 22.00 |
| | | RB Size=1, RB Offset=25 | 0 | 0 | 21.65 | 21.77 | 21.53 |
| | | RB Size=1, RB Offset=49 | 0 | 0 | 21.84 | 21.69 | 21.86 |
| | | RB Size=25, RB Offset=0 | 1 | 1 | 21.82 | 21.88 | 21.99 |
| | | RB Size=25, RB Offset=25 | 1 | 1 | 21.55 | 21.66 | 21.94 |
| | | RB Size=50, RB Offset=0 | 1 | 1 | 21.37 | 21.60 | 21.70 |
| | 16QAM | RB Size=1, RB Offset=0 | 1 | 1 | 21.60 | 22.07 | 21.90 |
| | | RB Size=1, RB Offset=25 | 1 | 1 | 21.72 | 21.66 | 21.69 |
| | | RB Size=1, RB Offset=49 | 1 | 1 | 21.45 | 21.76 | 21.62 |
| | | RB Size=25, RB Offset=0 | 2 | 2 | 21.74 | 21.67 | 21.64 |
| | | RB Size=25, RB Offset=25 | 2 | 2 | 21.80 | 21.49 | 21.63 |
| | | RB Size=50, RB Offset=0 | 2 | 2 | 21.74 | 21.81 | 21.91 |

| BW (MHz) | Modulation | Resource Block Size & Resource Block Offset | Target MPR | Meas MPR | Ave Tx Power (dBm) | | |
|-------------------------|------------|---|------------|----------|--------------------|-------------|--------------|
| | | | | | Low Channel | Mid Channel | High Channel |
| | | | | | 1857.5MHz | 1880MHz | 1902.5MHz |
| 15 | QPSK | RB Size=1, RB Offset=0 | 0 | 0 | 21.57 | 21.71 | 21.82 |
| | | RB Size=1, RB Offset=38 | 0 | 0 | 21.52 | 21.64 | 21.42 |
| | | RB Size=1, RB Offset=74 | 0 | 0 | 21.88 | 21.33 | 21.82 |
| | | RB Size=36, RB Offset=0 | 1 | 1 | 21.89 | 21.70 | 21.93 |
| | | RB Size=36, RB Offset=39 | 1 | 1 | 21.40 | 21.58 | 21.84 |
| | | RB Size=75, RB Offset=0 | 1 | 1 | 21.33 | 21.64 | 21.66 |
| | 16QAM | RB Size=1, RB Offset=0 | 1 | 1 | 21.96 | 21.76 | 21.70 |
| | | RB Size=1, RB Offset=38 | 1 | 1 | 21.78 | 21.87 | 21.69 |
| | | RB Size=1, RB Offset=74 | 1 | 1 | 21.45 | 21.39 | 21.78 |
| | | RB Size=36, RB Offset=0 | 2 | 2 | 21.65 | 21.85 | 22.05 |
| | | RB Size=36, RB Offset=39 | 2 | 2 | 21.46 | 21.47 | 21.70 |
| RB Size=75, RB Offset=0 | 2 | 2 | 21.68 | 21.81 | 21.83 | | |
| BW (MHz) | Modulation | Resource Block Size & Resource Block Offset | Target MPR | Meas MPR | Ave Tx Power (dBm) | | |
| | | | | | Low Channel | Mid Channel | High Channel |
| | | | | | 1860MHz | 1880MHz | 1900MHz |
| 20 | QPSK | RB Size=1, RB Offset=0 | 0 | 0 | 22.02 | 22.02 | 22.18 |
| | | RB Size=1, RB Offset=50 | 0 | 0 | 21.95 | 21.82 | 21.83 |
| | | RB Size=1, RB Offset=99 | 0 | 0 | 22.03 | 22.13 | 22.39 |
| | | RB Size=50, RB Offset=0 | 1 | 1 | 22.27 | 22.32 | 22.43 |
| | | RB Size=50, RB Offset=50 | 1 | 1 | 21.83 | 22.10 | 22.11 |
| | | RB Size=100, RB Offset=0 | 1 | 1 | 22.14 | 21.96 | 22.30 |
| | 16QAM | RB Size=1, RB Offset=0 | 1 | 1 | 22.09 | 22.12 | 22.46 |
| | | RB Size=1, RB Offset=50 | 1 | 1 | 22.08 | 22.33 | 22.11 |
| | | RB Size=1, RB Offset=99 | 1 | 1 | 22.00 | 22.16 | 22.28 |
| | | RB Size=50, RB Offset=0 | 2 | 2 | 22.23 | 22.22 | 22.06 |
| | | RB Size=50, RB Offset=50 | 2 | 2 | 21.74 | 22.36 | 22.07 |
| | | RB Size=100, RB Offset=0 | 2 | 2 | 22.22 | 22.12 | 22.17 |

LTE Band 4:

| BW (MHz) | Modulation | Resource Block Size & Resource Block Offset | Target MPR | Meas MPR | Ave Tx Power (dBm) | | |
|----------|------------|---|------------|----------|--------------------|-------------|--------------|
| | | | | | Low Channel | Mid Channel | High Channel |
| | | | | | 1710.7MHz | 1732.5MHz | 1754.3MHz |
| 3 | QPSK | RB Size=1, RB Offset=0 | 0 | 0 | 21.70 | 21.81 | 21.83 |
| | | RB Size=1, RB Offset=3 | 0 | 0 | 21.33 | 21.64 | 21.58 |
| | | RB Size=1, RB Offset=5 | 0 | 0 | 21.80 | 21.61 | 21.80 |
| | | RB Size=3, RB Offset=0 | 1 | 1 | 21.63 | 21.84 | 21.59 |
| | | RB Size=3, RB Offset=3 | 1 | 1 | 21.54 | 21.80 | 21.97 |
| | | RB Size=6, RB Offset=0 | 1 | 1 | 21.94 | 21.83 | 21.94 |
| | 16QAM | RB Size=1, RB Offset=0 | 1 | 1 | 21.48 | 21.85 | 21.84 |
| | | RB Size=1, RB Offset=3 | 1 | 1 | 21.78 | 21.79 | 21.80 |
| | | RB Size=1, RB Offset=5 | 1 | 1 | 21.66 | 21.72 | 21.90 |
| | | RB Size=3, RB Offset=0 | 2 | 2 | 21.74 | 21.96 | 21.67 |
| | | RB Size=3, RB Offset=3 | 2 | 2 | 21.47 | 21.84 | 21.60 |
| | | RB Size=6, RB Offset=0 | 2 | 2 | 21.44 | 21.77 | 21.82 |

| BW (MHz) | Modulation | Resource Block Size & Resource Block Offset | Target MPR | Meas MPR | Ave Tx Power (dBm) | | |
|----------|------------|---|------------|----------|--------------------|-------------|--------------|
| | | | | | Low Channel | Mid Channel | High Channel |
| | | | | | 1711.5MHz | 1732.5MHz | 1753.5MHz |
| 3 | QPSK | RB Size=1, RB Offset=0 | 0 | 0 | 21.86 | 22.16 | 22.32 |
| | | RB Size=1, RB Offset=8 | 0 | 0 | 21.80 | 21.94 | 22.10 |
| | | RB Size=1, RB Offset=14 | 0 | 0 | 21.53 | 21.79 | 22.38 |
| | | RB Size=6, RB Offset=0 | 1 | 1 | 21.55 | 22.28 | 21.99 |
| | | RB Size=6, RB Offset=9 | 1 | 1 | 22.06 | 21.85 | 22.33 |
| | | RB Size=15, RB Offset=0 | 1 | 1 | 22.06 | 22.00 | 22.30 |
| | 16QAM | RB Size=1, RB Offset=0 | 1 | 1 | 22.10 | 22.21 | 22.26 |
| | | RB Size=1, RB Offset=8 | 1 | 1 | 21.90 | 22.23 | 22.56 |
| | | RB Size=1, RB Offset=14 | 1 | 1 | 22.08 | 22.03 | 22.21 |
| | | RB Size=6, RB Offset=0 | 2 | 2 | 21.85 | 22.09 | 22.43 |
| | | RB Size=6, RB Offset=9 | 2 | 2 | 22.10 | 21.80 | 22.10 |
| | | RB Size=15, RB Offset=0 | 2 | 2 | 22.13 | 21.82 | 22.23 |

| BW (MHz) | Modulation | Resource Block Size & Resource Block Offset | Target MPR | Meas MPR | Ave Tx Power (dBm) | | |
|-------------------------|------------|---|------------|----------|--------------------|-------------|--------------|
| | | | | | Low Channel | Mid Channel | High Channel |
| | | | | | 1712.5MHz | 1732.5MHz | 1752.5MHz |
| 5 | QPSK | RB Size=1, RB Offset=0 | 0 | 0 | 22.14 | 22.45 | 22.53 |
| | | RB Size=1, RB Offset=13 | 0 | 0 | 21.85 | 22.46 | 22.55 |
| | | RB Size=1, RB Offset=24 | 0 | 0 | 22.37 | 22.49 | 22.68 |
| | | RB Size=15, RB Offset=0 | 1 | 1 | 22.34 | 22.10 | 22.30 |
| | | RB Size=15, RB Offset=10 | 1 | 1 | 22.35 | 22.19 | 22.32 |
| | | RB Size=25, RB Offset=0 | 1 | 1 | 22.28 | 22.28 | 22.23 |
| | 16QAM | RB Size=1, RB Offset=0 | 1 | 1 | 21.93 | 22.19 | 22.28 |
| | | RB Size=1, RB Offset=13 | 1 | 1 | 22.32 | 22.63 | 22.62 |
| | | RB Size=1, RB Offset=24 | 1 | 1 | 22.37 | 22.55 | 22.21 |
| | | RB Size=15, RB Offset=0 | 2 | 2 | 22.16 | 22.49 | 22.63 |
| | | RB Size=15, RB Offset=10 | 2 | 2 | 22.02 | 22.40 | 22.30 |
| RB Size=25, RB Offset=0 | 2 | 2 | 21.96 | 22.42 | 22.31 | | |
| BW (MHz) | Modulation | Resource Block Size & Resource Block Offset | Target MPR | Meas MPR | Ave Tx Power (dBm) | | |
| | | | | | Low Channel | Mid Channel | High Channel |
| | | | | | 1715MHz | 1732.5MHz | 1750MHz |
| 10 | QPSK | RB Size=1, RB Offset=0 | 0 | 0 | 22.21 | 22.26 | 22.33 |
| | | RB Size=1, RB Offset=25 | 0 | 0 | 22.14 | 22.49 | 22.55 |
| | | RB Size=1, RB Offset=49 | 0 | 0 | 21.94 | 22.26 | 22.55 |
| | | RB Size=25, RB Offset=0 | 1 | 1 | 22.26 | 22.44 | 22.28 |
| | | RB Size=25, RB Offset=25 | 1 | 1 | 21.99 | 22.22 | 22.02 |
| | | RB Size=50, RB Offset=0 | 1 | 1 | 22.37 | 22.09 | 22.51 |
| | 16QAM | RB Size=1, RB Offset=0 | 1 | 1 | 22.32 | 22.42 | 22.38 |
| | | RB Size=1, RB Offset=25 | 1 | 1 | 22.23 | 22.43 | 22.56 |
| | | RB Size=1, RB Offset=49 | 1 | 1 | 22.19 | 22.05 | 22.42 |
| | | RB Size=25, RB Offset=0 | 2 | 2 | 22.20 | 22.09 | 22.46 |
| | | RB Size=25, RB Offset=25 | 2 | 2 | 22.09 | 22.07 | 22.18 |
| | | RB Size=50, RB Offset=0 | 2 | 2 | 22.12 | 22.52 | 22.57 |

| BW (MHz) | Modulation | Resource Block Size & Resource Block Offset | Target MPR | Meas MPR | Ave Tx Power (dBm) | | |
|-------------------------|------------|---|------------|----------|--------------------|-------------|--------------|
| | | | | | Low Channel | Mid Channel | High Channel |
| | | | | | 1717.5MHz | 1732.5MHz | 1747.5MHz |
| 15 | QPSK | RB Size=1, RB Offset=0 | 0 | 0 | 21.92 | 22.05 | 22.31 |
| | | RB Size=1, RB Offset=38 | 0 | 0 | 22.12 | 22.09 | 22.02 |
| | | RB Size=1, RB Offset=74 | 0 | 0 | 21.83 | 22.19 | 22.29 |
| | | RB Size=36, RB Offset=0 | 1 | 1 | 22.03 | 22.09 | 21.97 |
| | | RB Size=36, RB Offset=39 | 1 | 1 | 22.09 | 22.23 | 22.22 |
| | | RB Size=75, RB Offset=0 | 1 | 1 | 21.88 | 21.90 | 22.18 |
| | 16QAM | RB Size=1, RB Offset=0 | 1 | 1 | 21.86 | 22.19 | 22.36 |
| | | RB Size=1, RB Offset=38 | 1 | 1 | 21.63 | 22.08 | 22.06 |
| | | RB Size=1, RB Offset=74 | 1 | 1 | 21.94 | 21.92 | 22.51 |
| | | RB Size=36, RB Offset=0 | 2 | 2 | 21.99 | 22.15 | 22.48 |
| | | RB Size=36, RB Offset=39 | 2 | 2 | 21.67 | 21.97 | 22.14 |
| RB Size=75, RB Offset=0 | 2 | 2 | 21.70 | 21.93 | 22.55 | | |
| BW (MHz) | Modulation | Resource Block Size & Resource Block Offset | Target MPR | Meas MPR | Ave Tx Power (dBm) | | |
| | | | | | Low Channel | Mid Channel | High Channel |
| | | | | | 1720MHz | 1732.5MHz | 1745MHz |
| 20 | QPSK | RB Size=1, RB Offset=0 | 0 | 0 | 21.88 | 22.06 | 22.10 |
| | | RB Size=1, RB Offset=50 | 0 | 0 | 22.11 | 21.97 | 22.01 |
| | | RB Size=1, RB Offset=99 | 0 | 0 | 22.18 | 22.22 | 22.14 |
| | | RB Size=50, RB Offset=0 | 1 | 1 | 21.88 | 22.25 | 21.70 |
| | | RB Size=50, RB Offset=50 | 1 | 1 | 22.09 | 21.78 | 21.79 |
| | | RB Size=100, RB Offset=0 | 1 | 1 | 22.17 | 22.29 | 22.12 |
| | 16QAM | RB Size=1, RB Offset=0 | 1 | 1 | 22.13 | 21.96 | 22.07 |
| | | RB Size=1, RB Offset=50 | 1 | 1 | 21.96 | 22.09 | 21.95 |
| | | RB Size=1, RB Offset=99 | 1 | 1 | 22.07 | 21.94 | 22.22 |
| | | RB Size=50, RB Offset=0 | 2 | 2 | 21.68 | 22.21 | 22.02 |
| | | RB Size=50, RB Offset=50 | 2 | 2 | 22.09 | 22.36 | 22.07 |
| | | RB Size=100, RB Offset=0 | 2 | 2 | 22.07 | 21.94 | 21.82 |

LTE Band 7:

| BW | Modulation | Resource Block Size & Resource Block Offset | Target MPR | Meas MPR | Ave Tx Power (dBm) | | |
|--------------------------|-------------------------|---|------------|----------|--------------------|-------------|--------------|
| | | | | | Low Channel | Mid Channel | High Channel |
| | | | | | 2502.5MHz | 2535MHz | 2567.5MHz |
| 5M | QPSK | RB Size=1, RB Offset=0 | 0 | 0 | 22.14 | 22.35 | 22.56 |
| | | RB Size=1, RB Offset=13 | 0 | 0 | 21.83 | 22.23 | 22.40 |
| | | RB Size=1, RB Offset=24 | 0 | 0 | 22.03 | 22.48 | 22.60 |
| | | RB Size=15, RB Offset=0 | 1 | 1 | 22.21 | 22.43 | 22.61 |
| | | RB Size=15, RB Offset=10 | 1 | 1 | 22.26 | 22.47 | 22.45 |
| | RB Size=25, RB Offset=0 | 1 | 1 | 22.42 | 22.49 | 22.38 | |
| | 16QAM | RB Size=1, RB Offset=0 | 1 | 1 | 22.24 | 22.24 | 22.20 |
| | | RB Size=1, RB Offset=13 | 1 | 1 | 22.21 | 22.21 | 22.54 |
| | | RB Size=1, RB Offset=24 | 1 | 1 | 22.15 | 22.07 | 22.60 |
| | | RB Size=15, RB Offset=0 | 2 | 2 | 21.97 | 22.48 | 22.22 |
| RB Size=15, RB Offset=10 | | 2 | 2 | 21.99 | 22.74 | 22.30 | |
| RB Size=25, RB Offset=0 | 2 | 2 | 22.43 | 22.50 | 22.33 | | |
| BW | Modulation | Resource Block Size & Resource Block Offset | Target MPR | Meas MPR | Ave Tx Power (dBm) | | |
| | | | | | Low Channel | Mid Channel | High Channel |
| | | | | | 2505MHz | 2535MHz | 2565MHz |
| 10M | QPSK | RB Size=1, RB Offset=0 | 0 | 0 | 22.17 | 22.41 | 22.45 |
| | | RB Size=1, RB Offset=25 | 0 | 0 | 22.08 | 22.18 | 22.07 |
| | | RB Size=1, RB Offset=49 | 0 | 0 | 21.89 | 22.14 | 22.32 |
| | | RB Size=25, RB Offset=0 | 1 | 1 | 22.32 | 22.55 | 22.33 |
| | | RB Size=25, RB Offset=25 | 1 | 1 | 22.13 | 22.42 | 22.56 |
| | RB Size=50, RB Offset=0 | 1 | 1 | 22.29 | 22.33 | 22.21 | |
| | 16QAM | RB Size=1, RB Offset=0 | 1 | 1 | 22.02 | 22.04 | 22.49 |
| | | RB Size=1, RB Offset=25 | 1 | 1 | 22.30 | 22.58 | 22.14 |
| | | RB Size=1, RB Offset=49 | 1 | 1 | 22.20 | 22.65 | 22.63 |
| | | RB Size=25, RB Offset=0 | 2 | 2 | 21.91 | 22.41 | 22.42 |
| RB Size=25, RB Offset=25 | | 2 | 2 | 21.95 | 22.38 | 22.74 | |
| RB Size=50, RB Offset=0 | 2 | 2 | 22.26 | 22.14 | 22.65 | | |

| BW | Modulation | Resource Block Size & Resource Block Offset | Target MPR | Meas MPR | Ave Tx Power (dBm) | | |
|-----|------------|---|------------|----------|--------------------|-------------|--------------|
| | | | | | Low Channel | Mid Channel | High Channel |
| | | | | | 2507.5MHz | 2535MHz | 2562.5MHz |
| 15M | QPSK | RB Size=1, RB Offset=0 | 0 | 0 | 22.22 | 22.37 | 22.45 |
| | | RB Size=1, RB Offset=38 | 0 | 0 | 22.42 | 22.32 | 22.45 |
| | | RB Size=1, RB Offset=74 | 0 | 0 | 22.52 | 21.97 | 22.24 |
| | | RB Size=36, RB Offset=0 | 1 | 1 | 22.27 | 22.41 | 22.03 |
| | | RB Size=36, RB Offset=38 | 1 | 1 | 22.06 | 22.47 | 22.14 |
| | | RB Size=75, RB Offset=0 | 1 | 1 | 22.27 | 22.10 | 22.28 |
| | 16QAM | RB Size=1, RB Offset=0 | 1 | 1 | 22.28 | 22.29 | 22.30 |
| | | RB Size=1, RB Offset=38 | 1 | 1 | 21.96 | 22.25 | 22.53 |
| | | RB Size=1, RB Offset=74 | 1 | 1 | 22.38 | 22.27 | 22.70 |
| | | RB Size=36, RB Offset=0 | 2 | 2 | 22.40 | 22.07 | 22.36 |
| | | RB Size=36, RB Offset=38 | 2 | 2 | 21.96 | 22.23 | 22.34 |
| | | RB Size=75, RB Offset=0 | 2 | 2 | 22.29 | 22.14 | 22.38 |
| BW | Modulation | Resource Block Size & Resource Block Offset | Target MPR | Meas MPR | Ave Tx Power (dBm) | | |
| | | | | | Low Channel | Mid Channel | High Channel |
| | | | | | 2510MHz | 2535MHz | 2560MHz |
| 20M | QPSK | RB Size=1, RB Offset=0 | 0 | 0 | 22.39 | 22.42 | 22.65 |
| | | RB Size=1, RB Offset=50 | 0 | 0 | 22.57 | 22.43 | 22.49 |
| | | RB Size=1, RB Offset=99 | 0 | 0 | 22.10 | 22.32 | 22.74 |
| | | RB Size=50, RB Offset=0 | 1 | 1 | 22.09 | 22.44 | 22.67 |
| | | RB Size=50, RB Offset=50 | 1 | 1 | 22.49 | 22.33 | 22.82 |
| | | RB Size=100, RB Offset=0 | 1 | 1 | 22.34 | 22.12 | 22.58 |
| | 16QAM | RB Size=1, RB Offset=0 | 1 | 1 | 22.04 | 22.29 | 22.35 |
| | | RB Size=1, RB Offset=50 | 1 | 1 | 22.30 | 22.25 | 22.71 |
| | | RB Size=1, RB Offset=99 | 1 | 1 | 22.51 | 22.48 | 22.81 |
| | | RB Size=50, RB Offset=0 | 2 | 2 | 22.26 | 22.50 | 22.76 |
| | | RB Size=50, RB Offset=50 | 2 | 2 | 22.44 | 22.17 | 22.88 |
| | | RB Size=100, RB Offset=0 | 2 | 2 | 22.47 | 22.23 | 22.49 |

LTE Band 12:

| BW (MHz) | Modulation | Resource Block Size & Resource Block Offset | Target MPR | Meas MPR | Ave Tx Power (dBm) | | |
|----------|------------|---|------------|----------|--------------------|-------------|--------------|
| | | | | | Low Channel | Mid Channel | High Channel |
| | | | | | 699.7MHz | 707.5MHz | 715.3MHz |
| 1.4 | QPSK | RB Size=1, RB Offset=0 | 0 | 0 | 22.08 | 22.32 | 22.46 |
| | | RB Size=1, RB Offset=3 | 0 | 0 | 22.09 | 22.33 | 22.15 |
| | | RB Size=1, RB Offset=5 | 0 | 0 | 21.78 | 22.02 | 22.24 |
| | | RB Size=3, RB Offset=0 | 1 | 1 | 22.03 | 22.16 | 22.14 |
| | | RB Size=3, RB Offset=3 | 1 | 1 | 22.32 | 22.43 | 22.19 |
| | | RB Size=6, RB Offset=0 | 1 | 1 | 21.89 | 22.04 | 22.22 |
| | 16QAM | RB Size=1, RB Offset=0 | 1 | 1 | 22.16 | 22.24 | 22.41 |
| | | RB Size=1, RB Offset=3 | 1 | 1 | 22.36 | 22.25 | 22.29 |
| | | RB Size=1, RB Offset=5 | 1 | 1 | 22.16 | 22.22 | 22.47 |
| | | RB Size=3, RB Offset=0 | 2 | 2 | 22.05 | 22.08 | 22.44 |
| | | RB Size=3, RB Offset=3 | 2 | 2 | 22.13 | 22.38 | 22.71 |
| | | RB Size=6, RB Offset=0 | 2 | 2 | 21.87 | 22.45 | 22.15 |
| BW (MHz) | Modulation | Resource Block Size & Resource Block Offset | Target MPR | Meas MPR | Ave Tx Power (dBm) | | |
| | | | | | Low Channel | Mid Channel | High Channel |
| | | | | | 700.5MHz | 707.5MHz | 714.5MHz |
| 3 | QPSK | RB Size=1, RB Offset=0 | 0 | 0 | 22.35 | 22.43 | 22.69 |
| | | RB Size=1, RB Offset=8 | 0 | 0 | 22.57 | 22.58 | 22.42 |
| | | RB Size=1, RB Offset=14 | 0 | 0 | 22.53 | 22.47 | 22.46 |
| | | RB Size=6, RB Offset=0 | 1 | 1 | 22.36 | 22.46 | 22.61 |
| | | RB Size=6, RB Offset=9 | 1 | 1 | 22.34 | 22.59 | 22.46 |
| | | RB Size=15, RB Offset=0 | 1 | 1 | 22.38 | 22.64 | 22.59 |
| | 16QAM | RB Size=1, RB Offset=0 | 1 | 1 | 22.62 | 22.65 | 22.52 |
| | | RB Size=1, RB Offset=8 | 1 | 1 | 22.15 | 22.58 | 22.70 |
| | | RB Size=1, RB Offset=14 | 1 | 1 | 22.24 | 22.24 | 22.64 |
| | | RB Size=6, RB Offset=0 | 2 | 2 | 22.48 | 22.84 | 22.79 |
| | | RB Size=6, RB Offset=9 | 2 | 2 | 22.10 | 22.17 | 22.59 |
| | | RB Size=15, RB Offset=0 | 2 | 2 | 22.58 | 22.65 | 22.61 |

| BW (MHz) | Modulation | Resource Block Size & Resource Block Offset | Target MPR | Meas MPR | Ave Tx Power (dBm) | | |
|-------------------------|------------|---|------------|----------|--------------------|-------------|--------------|
| | | | | | Low Channel | Mid Channel | High Channel |
| | | | | | 701.5MHz | 707.5MHz | 713.5MHz |
| 5 | QPSK | RB Size=1, RB Offset=0 | 0 | 0 | 22.16 | 22.06 | 22.30 |
| | | RB Size=1, RB Offset=13 | 0 | 0 | 21.89 | 22.22 | 22.00 |
| | | RB Size=1, RB Offset=24 | 0 | 0 | 22.10 | 22.10 | 22.41 |
| | | RB Size=15, RB Offset=0 | 1 | 1 | 22.14 | 21.78 | 22.04 |
| | | RB Size=15, RB Offset=10 | 1 | 1 | 22.40 | 22.19 | 22.01 |
| | | RB Size=25, RB Offset=0 | 1 | 1 | 22.17 | 21.99 | 22.25 |
| | 16QAM | RB Size=1, RB Offset=0 | 1 | 1 | 22.48 | 21.82 | 22.05 |
| | | RB Size=1, RB Offset=13 | 1 | 1 | 21.91 | 22.18 | 22.16 |
| | | RB Size=1, RB Offset=24 | 1 | 1 | 21.99 | 22.09 | 22.51 |
| | | RB Size=15, RB Offset=0 | 2 | 2 | 22.30 | 22.13 | 22.55 |
| | | RB Size=15, RB Offset=10 | 2 | 2 | 22.18 | 22.15 | 22.30 |
| RB Size=25, RB Offset=0 | 2 | 2 | 21.86 | 22.00 | 22.09 | | |
| BW (MHz) | Modulation | Resource Block Size & Resource Block Offset | Target MPR | Meas MPR | Ave Tx Power (dBm) | | |
| | | | | | Low Channel | Mid Channel | High Channel |
| | | | | | 704MHz | 707.5MHz | 711MHz |
| 10 | QPSK | RB Size=1, RB Offset=0 | 0 | 0 | 22.36 | 22.49 | 22.57 |
| | | RB Size=1, RB Offset=25 | 0 | 0 | 22.23 | 22.32 | 22.46 |
| | | RB Size=1, RB Offset=49 | 0 | 0 | 22.41 | 22.19 | 22.67 |
| | | RB Size=25, RB Offset=0 | 1 | 1 | 22.14 | 22.48 | 22.44 |
| | | RB Size=25, RB Offset=25 | 1 | 1 | 22.11 | 22.33 | 22.57 |
| | | RB Size=50, RB Offset=0 | 1 | 1 | 22.05 | 22.43 | 22.65 |
| | 16QAM | RB Size=1, RB Offset=0 | 1 | 1 | 22.02 | 22.54 | 22.40 |
| | | RB Size=1, RB Offset=25 | 1 | 1 | 22.38 | 22.35 | 22.59 |
| | | RB Size=1, RB Offset=49 | 1 | 1 | 22.46 | 22.27 | 22.57 |
| | | RB Size=25, RB Offset=0 | 2 | 2 | 22.50 | 22.34 | 22.66 |
| | | RB Size=25, RB Offset=25 | 2 | 2 | 22.21 | 22.24 | 22.56 |
| | | RB Size=50, RB Offset=0 | 2 | 2 | 22.16 | 22.48 | 22.63 |

LTE Band 17:

| BW (MHz) | Modulation | Resource Block Size & Resource Block Offset | Target MPR | Meas MPR | Ave Tx Power (dBm) | | |
|--------------------------|-------------------------|---|------------|----------|--------------------|-------------|--------------|
| | | | | | Low Channel | Mid Channel | High Channel |
| | | | | | 706.5MHz | 710MHz | 713.5MHz |
| 5 | QPSK | RB Size=1, RB Offset=0 | 0 | 0 | 21.68 | 21.69 | 21.49 |
| | | RB Size=1, RB Offset=13 | 0 | 0 | 21.73 | 21.41 | 21.60 |
| | | RB Size=1, RB Offset=24 | 0 | 0 | 21.84 | 21.63 | 21.14 |
| | | RB Size=15, RB Offset=0 | 1 | 1 | 21.83 | 21.48 | 21.65 |
| | | RB Size=15, RB Offset=10 | 1 | 1 | 21.69 | 21.65 | 21.38 |
| | RB Size=25, RB Offset=0 | 1 | 1 | 21.72 | 21.58 | 21.53 | |
| | 16QAM | RB Size=1, RB Offset=0 | 1 | 1 | 21.52 | 21.69 | 21.56 |
| | | RB Size=1, RB Offset=13 | 1 | 1 | 21.61 | 21.74 | 21.26 |
| | | RB Size=1, RB Offset=24 | 1 | 1 | 22.02 | 21.91 | 21.66 |
| | | RB Size=15, RB Offset=0 | 2 | 2 | 21.84 | 21.74 | 21.38 |
| RB Size=15, RB Offset=10 | | 2 | 2 | 21.73 | 21.42 | 21.66 | |
| RB Size=25, RB Offset=0 | 2 | 2 | 21.74 | 21.84 | 21.20 | | |
| BW (MHz) | Modulation | Resource Block Size & Resource Block Offset | Target MPR | Meas MPR | Ave Tx Power (dBm) | | |
| | | | | | Low Channel | Mid Channel | High Channel |
| | | | | | 709MHz | 710MHz | 711MHz |
| 10 | QPSK | RB Size=1, RB Offset=0 | 0 | 0 | 21.74 | 21.90 | 22.20 |
| | | RB Size=1, RB Offset=25 | 0 | 0 | 21.53 | 22.06 | 22.24 |
| | | RB Size=1, RB Offset=49 | 0 | 0 | 21.79 | 21.74 | 21.91 |
| | | RB Size=25, RB Offset=0 | 1 | 1 | 21.72 | 22.15 | 22.07 |
| | | RB Size=25, RB Offset=25 | 1 | 1 | 21.61 | 21.83 | 21.97 |
| | RB Size=50, RB Offset=0 | 1 | 1 | 21.46 | 21.89 | 22.18 | |
| | 16QAM | RB Size=1, RB Offset=0 | 1 | 1 | 21.68 | 21.66 | 22.15 |
| | | RB Size=1, RB Offset=25 | 1 | 1 | 22.04 | 22.15 | 22.29 |
| | | RB Size=1, RB Offset=49 | 1 | 1 | 21.93 | 21.72 | 22.18 |
| | | RB Size=25, RB Offset=0 | 2 | 2 | 21.59 | 21.72 | 22.29 |
| RB Size=25, RB Offset=25 | | 2 | 2 | 21.96 | 22.16 | 22.10 | |
| RB Size=50, RB Offset=0 | 2 | 2 | 21.91 | 21.88 | 22.41 | | |

Note:

1. SAR for LTE band exposure configurations is measured according to the procedures of KDB 941225 D05 SAR for LTE Devices v02.
2. The CMW500 Wideband Radio Communication tester is used for LTE output power measurements and SAR testing. Closed loop power control is used to keep the radio transmitters the max output power during the test.

WLAN 2.4G:

| Mode | Channel frequency (MHz) | Data Rate | RF Output Power(dBm) |
|--------------|-------------------------|-----------|----------------------|
| 802.11b | 2412 | 1Mbps | 7.08 |
| | 2437 | | 8.53 |
| | 2462 | | 8.04 |
| 802.11g | 2412 | 6Mbps | 7.37 |
| | 2437 | | 9.32 |
| | 2462 | | 7.08 |
| 802.11n HT20 | 2412 | MCS0 | 7.44 |
| | 2437 | | 9.28 |
| | 2462 | | 7.15 |
| 802.11n HT40 | 2422 | MCS0 | 8.48 |
| | 2437 | | 8.01 |
| | 2452 | | 7.42 |

Bluetooth:

| Mode | Channel frequency (MHz) | RF Output Power (dBm) |
|----------------------|-------------------------|-----------------------|
| BDR(GFSK) | 2402 | 3.05 |
| | 2434 | 5.31 |
| | 2441 | 4.60 |
| | 2480 | 4.42 |
| EDR($\pi/4$ -DQPSK) | 2402 | 2.37 |
| | 2441 | 3.67 |
| | 2480 | 3.66 |
| EDR(8-DPSK) | 2402 | 2.41 |
| | 2441 | 3.98 |
| | 2480 | 3.60 |
| Bluetooth LE | 2402 | 2.56 |
| | 2440 | 5.11 |
| | 2480 | 4.56 |

Standalone SAR test exclusion considerations

Antennas Location:

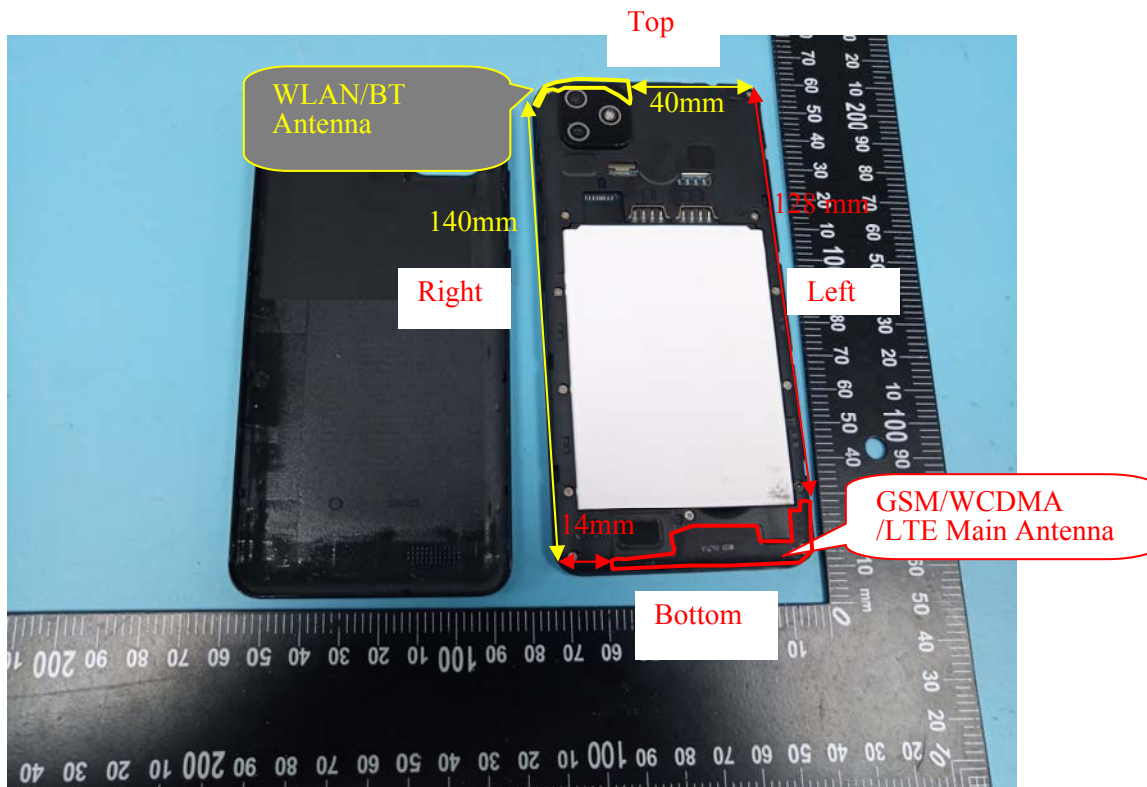

Antenna Distance To Edge

| Antenna Distance To Edge(mm) | | | | | |
|------------------------------|------|------|-------|-----|--------|
| Antenna | Back | Left | Right | Top | Bottom |
| WWAN(GSM/WCDMA/LTE) | < 5 | < 5 | 14 | 128 | < 5 |
| WLAN/BT Antenna | < 5 | 40 | < 5 | < 5 | 140 |

Standalone SAR test exclusion considerations

| Mode | Frequency (MHz) | P _{avg} (dBm) | P _{avg} (mW) | Distance (mm) | Calculated value | Threshold (1-g) | SAR Test Exclusion |
|-----------|-----------------|------------------------|-----------------------|---------------|------------------|-----------------|--------------------|
| WLAN 2.4G | 2437 | 9.5 | 8.91 | 0 | 2.8 | 3 | YES |
| Bluetooth | 2440 | 5.5 | 3.55 | 0 | 1.1 | 3 | YES |

NOTE:

The 1-g and 10-g SAR test exclusion thresholds for 100 MHz to 6 GHz at test separation distances ≤ 50 mm are determined by:

$$[(\text{max. power of channel, including tune-up tolerance, mW}) / (\text{min. test separation distance, mm})] \cdot [\sqrt{f(\text{GHz})}] \leq 3.0 \text{ for 1-g SAR and } \leq 7.5 \text{ for 10-g extremity SAR, where}$$

1. f(GHz) is the RF channel transmit frequency in GHz.
2. Power and distance are rounded to the nearest mW and mm before calculation.
3. The result is rounded to one decimal place for comparison.
4. When the minimum test separation distance is < 5 mm, a distance of 5 mm is applied to determine SAR test Exclusion.

Standalone SAR estimation:

| Mode | Frequency (MHz) | Pavg (dBm) | Pavg (mW) | Distance (mm) | Estimated 1-g (W/kg) |
|-----------|-----------------|------------|-----------|---------------|----------------------|
| WLAN 2.4G | 2437 | 9.5 | 8.91 | 0 | 0.37 |
| WLAN 2.4G | 2437 | 9.5 | 8.91 | 10 | 0.19 |
| BT Head | 2440 | 5.5 | 3.55 | 0 | 0.15 |
| BT Body | 2440 | 5.5 | 3.55 | 10 | 0.07 |

When standalone SAR test exclusion applies to an antenna that transmits simultaneously with other antennas, the standalone SAR must be estimated according to following to determine simultaneous transmission SAR test exclusion:

$$[(\text{max. power of channel, including tune-up tolerance, mW}) / (\text{min. test separation distance, mm})] \cdot [\sqrt{f(\text{GHz})} / x]$$

W/kg for test separation distances ≤50 mm;

where x = 7.5 for 1-g SAR.

When the minimum test separation distance is < 5 mm, a distance of 5 mm is applied to determine SAR test Exclusion.

SAR test exclusion for the EUT edge considerations Result

| Exclusion Result | | | | | |
|------------------|-----------------|-----------------|-----------------|------------|-----------------|
| Mode | Back | Left | Right | Top | Bottom |
| BT | Exclusion* | Exclusion* | Exclusion* | Exclusion* | Exclusion* |
| WLAN 2.4G | Exclusion* | Exclusion* | Exclusion* | Exclusion* | Exclusion* |
| WWAN | Required | Required | Required | Exclusion | Required |

Note:

Required: The distance to Edge is less than 25mm, testing is required.

Exclusion*: SAR test exclusion evaluation has been done above.

Exclusion: The distance to Edge is more than 25 mm, testing is not required.

SAR MEASUREMENT RESULTS

This page summarizes the results of the performed dosimetric evaluation.

SAR Test Data

Environmental Conditions

| | | | | |
|---------------------------|--------------|--------------|--------------|--------------|
| Temperature: | 22.0-23.8 °C | 22.1-23.6 °C | 20.2-23.5 °C | 21.3-24.3 °C |
| Relative Humidity: | 52-66% | 57-68% | 50-66 % | 51-63 % |
| ATM Pressure: | 101.0 kPa | 101.2 kPa | 101.1 kPa | 101.1 kPa |
| Test Date: | 2020/04/21 | 2020/04/22 | 2020/04/23 | 2020/04/24 |

Testing was performed by Seven Liang, Ricardo Lan, Thomas Deng.

GSM 850:

| EUT Position | Frequency (MHz) | Test Mode | Max Power (dBm) | | Scaled Factor | 1g SAR (W/kg) | | Plot |
|-----------------------------|-----------------|-----------|-----------------|-------|---------------|---------------|-------|------|
| | | | Meas. | Rated | | Meas. | Rated | |
| Head Left Cheek | 824.2 | GSM | / | / | / | / | / | / |
| | 836.6 | GSM | 32.71 | 33.0 | 1.069 | 0.262 | 0.28 | 1# |
| | 848.8 | GSM | / | / | / | / | / | / |
| Head Left Tilt | 824.2 | GSM | / | / | / | / | / | / |
| | 836.6 | GSM | 32.71 | 33.0 | 1.069 | 0.139 | 0.15 | 2# |
| | 848.8 | GSM | / | / | / | / | / | / |
| Head Right Cheek | 824.2 | GSM | / | / | / | / | / | / |
| | 836.6 | GSM | 32.71 | 33.0 | 1.069 | 0.276 | 0.30 | 3# |
| | 848.8 | GSM | / | / | / | / | / | / |
| Head Right Tilt | 824.2 | GSM | / | / | / | / | / | / |
| | 836.6 | GSM | 32.71 | 33.0 | 1.069 | 0.149 | 0.16 | 4# |
| | 848.8 | GSM | / | / | / | / | / | / |
| Body Worn Back (10mm) | 824.2 | GSM | / | / | / | / | / | / |
| | 836.6 | GSM | 32.71 | 33.0 | 1.069 | 0.391 | 0.42 | 5# |
| | 848.8 | GSM | / | / | / | / | / | / |
| Body Back (10mm) | 824.2 | GPRS | / | / | / | / | / | / |
| | 836.6 | GPRS | 30.54 | 31.0 | 1.112 | 0.531 | 0.59 | 6# |
| | 848.8 | GPRS | / | / | / | / | / | / |
| Body Left (10mm) | 824.2 | GPRS | / | / | / | / | / | / |
| | 836.6 | GPRS | 30.54 | 31.0 | 1.112 | 0.134 | 0.15 | 7# |
| | 848.8 | GPRS | / | / | / | / | / | / |
| Body Right (10mm) | 824.2 | GPRS | / | / | / | / | / | / |
| | 836.6 | GPRS | 30.54 | 31.0 | 1.112 | 0.257 | 0.29 | 8# |
| | 848.8 | GPRS | / | / | / | / | / | / |
| Body Bottom (10mm) | 824.2 | GPRS | / | / | / | / | / | / |
| | 836.6 | GPRS | 30.54 | 31.0 | 1.112 | 0.088 | 0.10 | 9# |
| | 848.8 | GPRS | / | / | / | / | / | / |

Note:

1. When the 1-g SAR is $\leq 0.8\text{W/Kg}$, testing for other channels are optional.
2. The EUT transmit and receive through the same GSM antenna while testing SAR.
3. When SAR or MPE is not measured at the maximum power level allowed for production units, the results must be scaled to the maximum tune-up tolerance limit according to the power applied to the individual channels tested to determine compliance.
4. When the maximum output power variation across the required test channels is $> 0.5\text{ dB}$, instead of the middle channel, the highest output power channel must be used.
5. The Multi-slot Classes of EUT is Class 12 which has maximum 4 Downlink slots and 4 Uplink slots, the maximum active slots is 5, when perform the multiple slots scan, 3DL+2UL is the worst case.

PCS 1900:

| EUT Position | Frequency (MHz) | Test Mode | Max Power (dBm) | | Scaled Factor | 1g SAR (W/kg) | | Plot |
|-----------------------|-----------------|-----------|-----------------|-------|---------------|---------------|-------|------|
| | | | Meas. | Rated | | Meas. | Rated | |
| Head Left Cheek | 1850.2 | GSM | / | / | / | / | / | / |
| | 1880 | GSM | 29.68 | 30.5 | 1.208 | 0.117 | 0.14 | 10# |
| | 1909.8 | GSM | / | / | / | / | / | / |
| Head Left Tilt | 1850.2 | GSM | / | / | / | / | / | / |
| | 1880 | GSM | 29.68 | 30.5 | 1.208 | 0.092 | 0.11 | 11# |
| | 1909.8 | GSM | / | / | / | / | / | / |
| Head Right Cheek | 1850.2 | GSM | / | / | / | / | / | / |
| | 1880 | GSM | 29.68 | 30.5 | 1.208 | 0.199 | 0.24 | 12# |
| | 1909.8 | GSM | / | / | / | / | / | / |
| Head Right Tilt | 1850.2 | GSM | / | / | / | / | / | / |
| | 1880 | GSM | 29.68 | 30.5 | 1.208 | 0.069 | 0.08 | 13# |
| | 1909.8 | GSM | / | / | / | / | / | / |
| Body Worn Back (10mm) | 1850.2 | GSM | / | / | / | / | / | / |
| | 1880 | GSM | 29.68 | 30.5 | 1.208 | 0.325 | 0.39 | 14# |
| | 1909.8 | GSM | / | / | / | / | / | / |
| Body Back (10mm) | 1850.2 | GPRS | / | / | / | / | / | / |
| | 1880 | GPRS | 26.87 | 27.0 | 1.030 | 0.651 | 0.67 | 15# |
| | 1909.8 | GPRS | / | / | / | / | / | / |
| Body Left (10mm) | 1850.2 | GPRS | / | / | / | / | / | / |
| | 1880 | GPRS | 26.87 | 27.0 | 1.030 | 0.078 | 0.08 | 16# |
| | 1909.8 | GPRS | / | / | / | / | / | / |
| Body Right (10mm) | 1850.2 | GPRS | / | / | / | / | / | / |
| | 1880 | GPRS | 26.87 | 27.0 | 1.030 | 0.139 | 0.14 | 17# |
| | 1909.8 | GPRS | / | / | / | / | / | / |
| Body Bottom (10mm) | 1850.2 | GPRS | / | / | / | / | / | / |
| | 1880 | GPRS | 26.87 | 27.0 | 1.030 | 0.751 | 0.77 | 18# |
| | 1909.8 | GPRS | / | / | / | / | / | / |

Note:

1. When the 1-g SAR is $\leq 0.8\text{W/Kg}$, testing for other channels are optional.
2. The EUT transmit and receive through the same GSM antenna while testing SAR.
3. When SAR or MPE is not measured at the maximum power level allowed for production units, the results must be scaled to the maximum tune-up tolerance limit according to the power applied to the individual channels tested to determine compliance.
4. When the maximum output power variation across the required test channels is $> 0.5\text{ dB}$, instead of the middle channel, the highest output power channel must be used.
5. The Multi-slot Classes of EUT is Class 12 which has maximum 4 Downlink slots and 4 Uplink slots, the maximum active slots is 5, when perform the multiple slots scan, 2DL+3UL is the worst case.

WCDMA Band 2:

| EUT Position | Frequency (MHz) | Test Mode | Max Power (dBm) | | Scaled Factor | 1g SAR (W/kg) | | Plot |
|--------------------|-----------------|-----------|-----------------|-------|---------------|---------------|-------|------|
| | | | Meas. | Rated | | Meas. | Rated | |
| Head Left Cheek | 1852.4 | RMC | / | / | / | / | / | / |
| | 1880 | RMC | 22.56 | 23.0 | 1.107 | 0.247 | 0.27 | 19# |
| | 1907.6 | RMC | / | / | / | / | / | / |
| Head Left Tilt | 1852.4 | RMC | / | / | / | / | / | / |
| | 1880 | RMC | 22.56 | 23.0 | 1.107 | 0.162 | 0.18 | 20# |
| | 1907.6 | RMC | / | / | / | / | / | / |
| Head Right Cheek | 1852.4 | RMC | / | / | / | / | / | / |
| | 1880 | RMC | 22.56 | 23.0 | 1.107 | 0.323 | 0.36 | 21# |
| | 1907.6 | RMC | / | / | / | / | / | / |
| Head Right Tilt | 1852.4 | RMC | / | / | / | / | / | / |
| | 1880 | RMC | 22.56 | 23.0 | 1.107 | 0.130 | 0.14 | 22# |
| | 1907.6 | RMC | / | / | / | / | / | / |
| Body Back (10mm) | 1852.4 | RMC | / | / | / | / | / | / |
| | 1880 | RMC | 22.56 | 23.0 | 1.107 | 0.597 | 0.66 | 23# |
| | 1907.6 | RMC | / | / | / | / | / | / |
| Body Left (10mm) | 1852.4 | RMC | / | / | / | / | / | / |
| | 1880 | RMC | 22.56 | 23.0 | 1.107 | 0.083 | 0.09 | 24# |
| | 1907.6 | RMC | / | / | / | / | / | / |
| Body Right (10mm) | 1852.4 | RMC | / | / | / | / | / | / |
| | 1880 | RMC | 22.56 | 23.0 | 1.107 | 0.143 | 0.16 | 25# |
| | 1907.6 | RMC | / | / | / | / | / | / |
| Body Bottom (10mm) | 1852.4 | RMC | / | / | / | / | / | / |
| | 1880 | RMC | 22.56 | 23.0 | 1.107 | 0.605 | 0.67 | 26# |
| | 1907.6 | RMC | / | / | / | / | / | / |

WCDMA Band 5:

| EUT Position | Frequency (MHz) | Test Mode | Max Power (dBm) | | Scaled Factor | 1g SAR (W/kg) | | Plot |
|--------------------|-----------------|-----------|-----------------|-------|---------------|---------------|-------|------|
| | | | Meas. | Rated | | Meas. | Rated | |
| Head Left Cheek | 826.4 | RMC | / | / | / | / | / | / |
| | 836.6 | RMC | 22.55 | 23.0 | 1.109 | 0.338 | 0.37 | 27# |
| | 846.6 | RMC | / | / | / | / | / | / |
| Head Left Tilt | 826.4 | RMC | / | / | / | / | / | / |
| | 836.6 | RMC | 22.55 | 23.0 | 1.109 | 0.237 | 0.26 | 28# |
| | 846.6 | RMC | / | / | / | / | / | / |
| Head Right Cheek | 826.4 | RMC | / | / | / | / | / | / |
| | 836.6 | RMC | 22.55 | 23.0 | 1.109 | 0.355 | 0.39 | 29# |
| | 846.6 | RMC | / | / | / | / | / | / |
| Head Right Tilt | 826.4 | RMC | / | / | / | / | / | / |
| | 836.6 | RMC | 22.55 | 23.0 | 1.109 | 0.199 | 0.22 | 30# |
| | 846.6 | RMC | / | / | / | / | / | / |
| Body Back (10mm) | 826.4 | RMC | / | / | / | / | / | / |
| | 836.6 | RMC | 22.55 | 23.0 | 1.109 | 0.651 | 0.72 | 31# |
| | 846.6 | RMC | / | / | / | / | / | / |
| Body Left (10mm) | 826.4 | RMC | / | / | / | / | / | / |
| | 836.6 | RMC | 22.55 | 23.0 | 1.109 | 0.251 | 0.28 | 32# |
| | 846.6 | RMC | / | / | / | / | / | / |
| Body Right (10mm) | 826.4 | RMC | / | / | / | / | / | / |
| | 836.6 | RMC | 22.55 | 23.0 | 1.109 | 0.393 | 0.44 | 33# |
| | 846.6 | RMC | / | / | / | / | / | / |
| Body Bottom (10mm) | 826.4 | RMC | / | / | / | / | / | / |
| | 836.6 | RMC | 22.55 | 23.0 | 1.109 | 0.104 | 0.12 | 34# |
| | 846.6 | RMC | / | / | / | / | / | / |

Note:

1. When the 1-g SAR is ≤ 0.8 W/Kg, testing for other channels are optional.
2. The EUT transmit and receive through the same antenna while testing SAR.
3. The default test configuration is to measure SAR with an established radio link between the EUT and a communication test set using a 12.2 kbps RMC (reference measurement Channel) Configured in Test Loop Model.
4. KDB 941225 D01-Body SAR is not required for HSDPA/HSUPA/HSPA+ when the maximum average output of each RF channel is less than $\frac{1}{4}$ dB higher than measured 12.2kbps RMC or the maximum SAR for 12.2kbps RMC is $< 75\%$ of SAR limit.
5. When SAR or MPE is not measured at the maximum power level allowed for production units, the results must be scaled to the maximum tune-up tolerance limit according to the power applied to the individual channels tested to determine compliance.

LTE Band 2:

| EUT Position | Frequency (MHz) | Bandwidth (MHz) | Test Mode | Max Power (dBm) | | Scaled Factor | 1g SAR (W/kg) | | Plot |
|-----------------------|-----------------|-----------------|-----------|-----------------|-------|---------------|---------------|-------|------|
| | | | | Meas. | Rated | | Meas. | Rated | |
| Head Left Cheek | 1860 | 20 | 1RB | / | / | / | / | / | / |
| | 1880 | 20 | 1RB | 22.02 | 22.5 | 1.117 | 0.159 | 0.18 | 35# |
| | 1900 | 20 | 1RB | / | / | / | / | / | / |
| | 1880 | 20 | 50%RB | 22.32 | 22.5 | 1.042 | 0.127 | 0.13 | 36# |
| Head Left Tilt | 1860 | 20 | 1RB | / | / | / | / | / | / |
| | 1880 | 20 | 1RB | 22.02 | 22.5 | 1.117 | 0.115 | 0.13 | 37# |
| | 1900 | 20 | 1RB | / | / | / | / | / | / |
| | 1880 | 20 | 50%RB | 22.32 | 22.5 | 1.042 | 0.095 | 0.10 | 38# |
| Head Right Cheek | 1860 | 20 | 1RB | / | / | / | / | / | / |
| | 1880 | 20 | 1RB | 22.02 | 22.5 | 1.117 | 0.267 | 0.30 | 39# |
| | 1900 | 20 | 1RB | / | / | / | / | / | / |
| | 1880 | 20 | 50%RB | 22.32 | 22.5 | 1.042 | 0.208 | 0.22 | 40# |
| Head Right Tilt | 1860 | 20 | 1RB | / | / | / | / | / | / |
| | 1880 | 20 | 1RB | 22.02 | 22.5 | 1.117 | 0.109 | 0.12 | 41# |
| | 1900 | 20 | 1RB | / | / | / | / | / | / |
| | 1880 | 20 | 50%RB | 22.32 | 22.5 | 1.042 | 0.084 | 0.09 | 42# |
| Body Back (10mm) | 1860 | 20 | 1RB | 22.02 | 22.5 | 1.117 | 0.943 | 1.05 | 43# |
| | 1880 | 20 | 1RB | 22.02 | 22.5 | 1.117 | 0.955 | 1.07 | 44# |
| | 1900 | 20 | 1RB | 22.18 | 22.5 | 1.076 | 0.858 | 0.92 | 45# |
| | 1880 | 20 | 50%RB | 22.32 | 22.5 | 1.042 | 0.756 | 0.79 | 46# |
| Body Left (10mm) | 1860 | 20 | 1RB | / | / | / | / | / | / |
| | 1880 | 20 | 1RB | 22.02 | 22.5 | 1.117 | 0.083 | 0.09 | 47# |
| | 1900 | 20 | 1RB | / | / | / | / | / | / |
| | 1880 | 20 | 50%RB | 22.32 | 22.5 | 1.042 | 0.065 | 0.07 | 48# |
| Body Right (10mm) | 1860 | 20 | 1RB | / | / | / | / | / | / |
| | 1880 | 20 | 1RB | 22.02 | 22.5 | 1.117 | 0.156 | 0.17 | 49# |
| | 1900 | 20 | 1RB | / | / | / | / | / | / |
| | 1880 | 20 | 50%RB | 22.32 | 22.5 | 1.042 | 0.123 | 0.13 | 50# |
| Body Bottom (10mm) | 1860 | 20 | 1RB | / | / | / | / | / | / |
| | 1880 | 20 | 1RB | 22.02 | 22.5 | 1.117 | 0.570 | 0.64 | 51# |
| | 1900 | 20 | 1RB | / | / | / | / | / | / |
| | 1880 | 20 | 50%RB | 22.32 | 22.5 | 1.042 | 0.450 | 0.47 | 52# |

LTE Band 4:

| EUT Position | Frequency (MHz) | Bandwidth (MHz) | Test Mode | Max Power (dBm) | | Scaled Factor | 1g SAR (W/kg) | | Plot |
|--------------------|-----------------|-----------------|-----------|-----------------|-------|---------------|---------------|-------|------|
| | | | | Meas. | Rated | | Meas. | Rated | |
| Head Left Cheek | 1720 | 20 | 1RB | / | / | / | / | / | / |
| | 1732.5 | 20 | 1RB | 22.06 | 23.0 | 1.242 | 0.252 | 0.31 | 53# |
| | 1745 | 20 | 1RB | / | / | / | / | / | / |
| | 1732.5 | 20 | 50%RB | 22.25 | 23.0 | 1.189 | 0.203 | 0.24 | 54# |
| Head Left Tilt | 1720 | 20 | 1RB | / | / | / | / | / | / |
| | 1732.5 | 20 | 1RB | 22.06 | 23.0 | 1.242 | 0.147 | 0.18 | 55# |
| | 1745 | 20 | 1RB | / | / | / | / | / | / |
| | 1732.5 | 20 | 50%RB | 22.25 | 23.0 | 1.189 | 0.117 | 0.14 | 56# |
| Head Right Cheek | 1720 | 20 | 1RB | / | / | / | / | / | / |
| | 1732.5 | 20 | 1RB | 22.06 | 23.0 | 1.242 | 0.267 | 0.33 | 57# |
| | 1745 | 20 | 1RB | / | / | / | / | / | / |
| | 1732.5 | 20 | 50%RB | 22.25 | 23.0 | 1.189 | 0.220 | 0.26 | 58# |
| Head Right Tilt | 1720 | 20 | 1RB | / | / | / | / | / | / |
| | 1732.5 | 20 | 1RB | 22.06 | 23.0 | 1.242 | 0.170 | 0.21 | 59# |
| | 1745 | 20 | 1RB | / | / | / | / | / | / |
| | 1732.5 | 20 | 50%RB | 22.25 | 23.0 | 1.189 | 0.137 | 0.16 | 60# |
| Body Back (10mm) | 1720 | 20 | 1RB | 21.88 | 23.0 | 1.294 | 0.806 | 1.04 | 61# |
| | 1732.5 | 20 | 1RB | 22.06 | 23.0 | 1.242 | 0.818 | 1.02 | 62# |
| | 1745 | 20 | 1RB | 22.10 | 23.0 | 1.230 | 0.539 | 0.66 | 63# |
| | 1732.5 | 20 | 50%RB | 22.25 | 23.0 | 1.189 | 0.664 | 0.79 | 64# |
| Body Left (10mm) | 1720 | 20 | 1RB | / | / | / | / | / | / |
| | 1732.5 | 20 | 1RB | 22.06 | 23.0 | 1.242 | 0.154 | 0.19 | 65# |
| | 1745 | 20 | 1RB | / | / | / | / | / | / |
| | 1732.5 | 20 | 50%RB | 22.25 | 23.0 | 1.189 | 0.122 | 0.14 | 66# |
| Body Right (10mm) | 1720 | 20 | 1RB | / | / | / | / | / | / |
| | 1732.5 | 20 | 1RB | 22.06 | 23.0 | 1.242 | 0.126 | 0.16 | 67# |
| | 1745 | 20 | 1RB | / | / | / | / | / | / |
| | 1732.5 | 20 | 50%RB | 22.25 | 23.0 | 1.189 | 0.100 | 0.12 | 68# |
| Body Bottom (10mm) | 1720 | 20 | 1RB | / | / | / | / | / | / |
| | 1732.5 | 20 | 1RB | 22.06 | 23.0 | 1.242 | 0.349 | 0.43 | 69# |
| | 1745 | 20 | 1RB | / | / | / | / | / | / |
| | 1732.5 | 20 | 50%RB | 22.25 | 23.0 | 1.189 | 0.285 | 0.34 | 70# |

LTE Band 7:

| EUT Position | Frequency (MHz) | Bandwidth (MHz) | Test Mode | Max Power (dBm) | | Scaled Factor | 1g SAR (W/kg) | | Plot |
|-----------------------|-----------------|-----------------|-----------|-----------------|-------|---------------|---------------|-------|------|
| | | | | Meas. | Rated | | Meas. | Rated | |
| | | | | | | | | | |
| Head Left Cheek | 2510 | 20 | 1RB | / | / | / | / | / | / |
| | 2535 | 20 | 1RB | 22.42 | 23.0 | 1.143 | 0.221 | 0.25 | 71# |
| | 2560 | 20 | 1RB | / | / | / | / | / | / |
| | 2535 | 20 | 50%RB | 22.44 | 23.0 | 1.138 | 0.182 | 0.21 | 72# |
| Head Left Tilt | 2510 | 20 | 1RB | / | / | / | / | / | / |
| | 2535 | 20 | 1RB | 22.42 | 23.0 | 1.143 | 0.202 | 0.23 | 73# |
| | 2560 | 20 | 1RB | / | / | / | / | / | / |
| | 2535 | 20 | 50%RB | 22.44 | 23.0 | 1.138 | 0.170 | 0.19 | 74# |
| Head Right Cheek | 2510 | 20 | 1RB | / | / | / | / | / | / |
| | 2535 | 20 | 1RB | 22.42 | 23.0 | 1.143 | 0.433 | 0.49 | 75# |
| | 2560 | 20 | 1RB | / | / | / | / | / | / |
| | 2535 | 20 | 50%RB | 22.44 | 23.0 | 1.138 | 0.366 | 0.42 | 76# |
| Head Right Tilt | 2510 | 20 | 1RB | / | / | / | / | / | / |
| | 2535 | 20 | 1RB | 22.42 | 23.0 | 1.143 | 0.348 | 0.40 | 77# |
| | 2560 | 20 | 1RB | / | / | / | / | / | / |
| | 2535 | 20 | 50%RB | 22.44 | 23.0 | 1.138 | 0.293 | 0.33 | 78# |
| Body Back (10mm) | 2510 | 20 | 1RB | / | / | / | / | / | / |
| | 2535 | 20 | 1RB | 22.42 | 23.0 | 1.143 | 0.765 | 0.87 | 79# |
| | 2560 | 20 | 1RB | / | / | / | / | / | / |
| | 2535 | 20 | 50%RB | 22.44 | 23.0 | 1.138 | 0.625 | 0.71 | 80# |
| Body Left (10mm) | 2510 | 20 | 1RB | / | / | / | / | / | / |
| | 2535 | 20 | 1RB | 22.42 | 23.0 | 1.143 | 0.318 | 0.36 | 81# |
| | 2560 | 20 | 1RB | / | / | / | / | / | / |
| | 2535 | 20 | 50%RB | 22.44 | 23.0 | 1.138 | 0.267 | 0.30 | 82# |
| Body Right (10mm) | 2510 | 20 | 1RB | / | / | / | / | / | / |
| | 2535 | 20 | 1RB | 22.42 | 23.0 | 1.143 | 0.065 | 0.07 | 83# |
| | 2560 | 20 | 1RB | / | / | / | / | / | / |
| | 2535 | 20 | 50%RB | 22.44 | 23.0 | 1.138 | 0.055 | 0.06 | 84# |
| Body Bottom (10mm) | 2510 | 20 | 1RB | / | / | / | / | / | / |
| | 2535 | 20 | 1RB | 22.42 | 23.0 | 1.143 | 0.335 | 0.38 | 85# |
| | 2560 | 20 | 1RB | / | / | / | / | / | / |
| | 2535 | 20 | 50%RB | 22.44 | 23.0 | 1.138 | 0.258 | 0.29 | 86# |

LTE Band 12:

| EUT Position | Frequency (MHz) | Bandwidth (MHz) | Test Mode | Max Power (dBm) | | Scaled Factor | 1g SAR (W/kg) | | Plot |
|--------------------|-----------------|-----------------|-----------|-----------------|-------|---------------|---------------|-------|------|
| | | | | Meas. | Rated | | Meas. | Rated | |
| Head Left Cheek | 704 | 10 | 1RB | / | / | / | / | / | / |
| | 707.5 | 10 | 1RB | 22.49 | 23.0 | 1.125 | 0.271 | 0.30 | 87# |
| | 711 | 10 | 1RB | / | / | / | / | / | / |
| | 707.5 | 10 | 50%RB | 22.48 | 23.0 | 1.127 | 0.230 | 0.26 | 88# |
| Head Left Tilt | 704 | 10 | 1RB | / | / | / | / | / | / |
| | 707.5 | 10 | 1RB | 22.49 | 23.0 | 1.125 | 0.136 | 0.15 | 89# |
| | 711 | 10 | 1RB | / | / | / | / | / | / |
| | 707.5 | 10 | 50%RB | 22.48 | 23.0 | 1.127 | 0.123 | 0.14 | 90# |
| Head Right Cheek | 704 | 10 | 1RB | / | / | / | / | / | / |
| | 707.5 | 10 | 1RB | 22.49 | 23.0 | 1.125 | 0.224 | 0.25 | 91# |
| | 711 | 10 | 1RB | / | / | / | / | / | / |
| | 707.5 | 10 | 50%RB | 22.48 | 23.0 | 1.127 | 0.190 | 0.21 | 92# |
| Head Right Tilt | 704 | 10 | 1RB | / | / | / | / | / | / |
| | 707.5 | 10 | 1RB | 22.49 | 23.0 | 1.125 | 0.128 | 0.14 | 93# |
| | 711 | 10 | 1RB | / | / | / | / | / | / |
| | 707.5 | 10 | 50%RB | 22.48 | 23.0 | 1.127 | 0.095 | 0.11 | 94# |
| Body Back (10mm) | 704 | 10 | 1RB | / | / | / | / | / | / |
| | 707.5 | 10 | 1RB | 22.49 | 23.0 | 1.125 | 0.436 | 0.49 | 95# |
| | 711 | 10 | 1RB | / | / | / | / | / | / |
| | 707.5 | 10 | 50%RB | 22.48 | 23.0 | 1.127 | 0.359 | 0.40 | 96# |
| Body Left (10mm) | 704 | 10 | 1RB | / | / | / | / | / | / |
| | 707.5 | 10 | 1RB | 22.49 | 23.0 | 1.125 | 0.270 | 0.30 | 97# |
| | 711 | 10 | 1RB | / | / | / | / | / | / |
| | 707.5 | 10 | 50%RB | 22.48 | 23.0 | 1.127 | 0.225 | 0.25 | 98# |
| Body Right (10mm) | 704 | 10 | 1RB | / | / | / | / | / | / |
| | 707.5 | 10 | 1RB | 22.49 | 23.0 | 1.125 | 0.170 | 0.19 | 99# |
| | 711 | 10 | 1RB | / | / | / | / | / | / |
| | 707.5 | 10 | 50%RB | 22.48 | 23.0 | 1.127 | 0.157 | 0.18 | 100# |
| Body Bottom (10mm) | 704 | 10 | 1RB | / | / | / | / | / | / |
| | 707.5 | 10 | 1RB | 22.49 | 23.0 | 1.125 | 0.051 | 0.06 | 101# |
| | 711 | 10 | 1RB | / | / | / | / | / | / |
| | 707.5 | 10 | 50%RB | 22.48 | 23.0 | 1.127 | 0.040 | 0.05 | 102# |

LTE Band 17:

| EUT Position | Frequency (MHz) | Bandwidth (MHz) | Test Mode | Max Power (dBm) | | Scaled Factor | 1g SAR (W/kg) | | Plot |
|-----------------------|-----------------|-----------------|-----------|-----------------|-------|---------------|---------------|-------|------|
| | | | | Meas. | Rated | | Meas. | Rated | |
| Head Left Cheek | 709 | 10 | 1RB | / | / | / | / | / | / |
| | 710 | 10 | 1RB | 21.90 | 23.0 | 1.288 | 0.210 | 0.27 | 103# |
| | 711 | 10 | 1RB | / | / | / | / | / | / |
| | 710 | 10 | 50%RB | 22.15 | 23.0 | 1.216 | 0.180 | 0.22 | 104# |
| Head Left Tilt | 709 | 10 | 1RB | / | / | / | / | / | / |
| | 710 | 10 | 1RB | 21.90 | 23.0 | 1.288 | 0.109 | 0.14 | 105# |
| | 711 | 10 | 1RB | / | / | / | / | / | / |
| | 710 | 10 | 50%RB | 22.15 | 23.0 | 1.216 | 0.096 | 0.12 | 106# |
| Head Right Cheek | 709 | 10 | 1RB | / | / | / | / | / | / |
| | 710 | 10 | 1RB | 21.90 | 23.0 | 1.288 | 0.208 | 0.27 | 107# |
| | 711 | 10 | 1RB | / | / | / | / | / | / |
| | 710 | 10 | 50%RB | 22.15 | 23.0 | 1.216 | 0.176 | 0.21 | 108# |
| Head Right Tilt | 709 | 10 | 1RB | / | / | / | / | / | / |
| | 710 | 10 | 1RB | 21.90 | 23.0 | 1.288 | 0.100 | 0.13 | 109# |
| | 711 | 10 | 1RB | / | / | / | / | / | / |
| | 710 | 10 | 50%RB | 22.15 | 23.0 | 1.216 | 0.087 | 0.11 | 110# |
| Body Back (10mm) | 709 | 10 | 1RB | / | / | / | / | / | / |
| | 710 | 10 | 1RB | 21.90 | 23.0 | 1.288 | 0.366 | 0.47 | 111# |
| | 711 | 10 | 1RB | / | / | / | / | / | / |
| | 710 | 10 | 50%RB | 22.15 | 23.0 | 1.216 | 0.309 | 0.38 | 112# |
| Body Left (10mm) | 709 | 10 | 1RB | / | / | / | / | / | / |
| | 710 | 10 | 1RB | 21.90 | 23.0 | 1.288 | 0.143 | 0.18 | 113# |
| | 711 | 10 | 1RB | / | / | / | / | / | / |
| | 710 | 10 | 50%RB | 22.15 | 23.0 | 1.216 | 0.123 | 0.15 | 114# |
| Body Right (10mm) | 709 | 10 | 1RB | / | / | / | / | / | / |
| | 710 | 10 | 1RB | 21.90 | 23.0 | 1.288 | 0.090 | 0.12 | 115# |
| | 711 | 10 | 1RB | / | / | / | / | / | / |
| | 710 | 10 | 50%RB | 22.15 | 23.0 | 1.216 | 0.077 | 0.09 | 116# |
| Body Bottom (10mm) | 709 | 10 | 1RB | / | / | / | / | / | / |
| | 710 | 10 | 1RB | 21.90 | 23.0 | 1.288 | 0.057 | 0.07 | 117# |
| | 711 | 10 | 1RB | / | / | / | / | / | / |
| | 710 | 10 | 50%RB | 22.15 | 23.0 | 1.216 | 0.047 | 0.06 | 118# |

Note:

1. When the 1-g SAR is $\leq 0.8\text{W/Kg}$, testing for other channels are optional.
2. SAR for LTE band exposure configurations is measured according to the procedures of KDB 941225 D05 SAR for LTE Devices v02.
3. KDB941225D05-SAR for higher order modulation is required only when the highest maximum output power for the configuration in the higher order modulation is $> 0.5\text{ dB}$ higher than the same configuration in QPSK or when the reported SAR for the QPSK configuration is $> 1.45\text{ W/kg}$
4. KDB941225D05-For QPSK with 100% RB allocation, when the reported SAR measured for the Highest output power channel is $< 1.45\text{ W/kg}$, tests for the remaining required test channels are optional.
5. KDB941225D05- For QPSK with 100% RB allocation, SAR is not required when the highest maximum output power for 100 % RB allocation is less than the highest maximum output power in 50% and 1 RB allocations and the highest reported SAR for 1 RB and 50% RB allocation are $\leq 0.8\text{ W/kg}$.
6. KDB941225D05- Start with the largest channel bandwidth and measure SAR for QPSK with 1 RB allocation, using the RB offset and required test channel combination with the highest maximum output power among RB offset the upper edge, middle and lower edge of each required test channel.
7. KDB941225D05- other channel bandwidths SAR test is required when the highest maximum output power of a configuration requiring testing in the smaller channel bandwidth is $> 0.5\text{ dB}$ higher than the equivalent channel configurations in the largest channel bandwidth configuration or the reported SAR of a configuration for the largest channel bandwidth is $> 1.45\text{ W/kg}$.
8. Worst case SAR for 50% RB allocation is selected to be tested.
9. KDB 648474 D04-When the peak SAR located in regions that probe is unable to access, a flat phantom is used for SAR measurement.

SAR Measurement Variability

In accordance with published RF Exposure KDB procedure 865664 D01 SAR measurement 100 MHz to 6 GHz v01. These additional measurements are repeated after the completion of all measurements requiring the same head or body tissue-equivalent medium in a frequency band. The test device should be returned to ambient conditions (normal room temperature) with the battery fully charged before it is re-mounted on the device holder for the repeated measurement(s) to minimize any unexpected variations in the repeated results

- 1) Repeated measurement is not required when the original highest measured SAR is < 0.80 W/kg; steps 2) through 4) do not apply.
- 2) When the original highest measured SAR is ≥ 0.80 W/kg, repeat that measurement once.
- 3) Perform a second repeated measurement only if the ratio of largest to smallest SAR for the original and first repeated measurements is > 1.20 or when the original or repeated measurement is ≥ 1.45 W/kg (~ 10% from the 1-g SAR limit).
- 4) Perform a third repeated measurement only if the original, first or second repeated measurement is ≥ 1.5 W/kg and the ratio of largest to smallest SAR for the original, first and second repeated measurements is > 1.20.

Note: The same procedures should be adapted for measurements according to extremity and occupational exposure limits by applying a factor of 2.5 for extremity exposure and a factor of 5 for occupational exposure to the corresponding SAR thresholds.

The Highest Measured SAR Configuration in Each Frequency Band

Head

| SAR probe calibration point | Frequency Band | Freq.(MHz) | EUT Position | Meas. SAR (W/kg) | | Largest to Smallest SAR Ratio |
|-----------------------------|----------------|------------|--------------|------------------|----------|-------------------------------|
| | | | | Original | Repeated | |
| / | / | / | / | / | / | / |

Body

| SAR probe calibration point | Frequency Band | Freq.(MHz) | EUT Position | Meas. SAR (W/kg) | | Largest to Smallest SAR Ratio |
|-----------------------------|----------------|------------|--------------|------------------|----------|-------------------------------|
| | | | | Original | Repeated | |
| 1900MHz (1850-2000MHz) | LTE Band2 1RB | 1880 | Body Back | 0.955 | 0.948 | 1.00 |
| 1800MHz (1650-1850MHz) | LTE Band4 1RB | 1732.5 | Body Back | 0.818 | 0.811 | 1.00 |

Note:

1. Second Repeated Measurement is not required since the ratio of the largest to smallest SAR for the original and first repeated measurement is not > 1.20.
2. The measured SAR results **do not** have to be scaled to the maximum tune-up tolerance to determine if repeated measurements are required.
3. SAR measurement variability must be assessed for each frequency band, which is determined by the **SAR probe calibration point and tissue-equivalent medium** used for the device measurements..

SAR SIMULTANEOUS TRANSMISSION DESCRIPTION

Simultaneous Transmission:

| Description of Simultaneous Transmit Capabilities | | |
|---|---------------|----------|
| Transmitter Combination | Simultaneous? | Hotspot? |
| WWAN(GSM/WCDMA/LTE) + Bluetooth | √ | × |
| WWAN(GSM/WCDMA/LTE) + WLAN | √ | √ |

Simultaneous and Hotspot SAR test exclusion considerations:

| Mode(SAR1+SAR2) | Position | Reported SAR(W/kg) | | ΣSAR < 1.6W/kg |
|------------------------|------------------|--------------------|------|----------------|
| | | SAR1 | SAR2 | |
| GSM 850+Bluetooth | Head Left Cheek | 0.28 | 0.15 | 0.430 |
| | Head Left Tilt | 0.15 | 0.15 | 0.300 |
| | Head Right Cheek | 0.30 | 0.15 | 0.450 |
| | Head Right Tilt | 0.16 | 0.15 | 0.310 |
| | Body Worn Back | 0.42 | 0.07 | 0.490 |
| | Body Back | 0.59 | 0.07 | 0.660 |
| PCS1900 +Bluetooth | Head Left Cheek | 0.14 | 0.15 | 0.290 |
| | Head Left Tilt | 0.11 | 0.15 | 0.260 |
| | Head Right Cheek | 0.24 | 0.15 | 0.390 |
| | Head Right Tilt | 0.08 | 0.15 | 0.230 |
| | Body Worn Back | 0.39 | 0.07 | 0.460 |
| | Body Back | 0.67 | 0.07 | 0.740 |
| WCDMA Band 2+Bluetooth | Head Left Cheek | 0.27 | 0.15 | 0.420 |
| | Head Left Tilt | 0.18 | 0.15 | 0.330 |
| | Head Right Cheek | 0.36 | 0.15 | 0.510 |
| | Head Right Tilt | 0.14 | 0.15 | 0.290 |
| | Body Back | 0.66 | 0.07 | 0.730 |
| WCDMA Band 5+Bluetooth | Head Left Cheek | 0.37 | 0.15 | 0.520 |
| | Head Left Tilt | 0.26 | 0.15 | 0.410 |
| | Head Right Cheek | 0.39 | 0.15 | 0.540 |
| | Head Right Tilt | 0.22 | 0.15 | 0.370 |
| | Body Back | 0.72 | 0.07 | 0.790 |

| Mode(SAR1+SAR2) | Position | Reported SAR(W/kg) | | ΣSAR < 1.6W/kg |
|-----------------------|------------------|--------------------|------|----------------|
| | | SAR1 | SAR2 | |
| LTE Band 2+Bluetooth | Head Left Cheek | 0.27 | 0.15 | 0.420 |
| | Head Left Tilt | 0.18 | 0.15 | 0.330 |
| | Head Right Cheek | 0.36 | 0.15 | 0.510 |
| | Head Right Tilt | 0.14 | 0.15 | 0.290 |
| | Body Back | 0.66 | 0.07 | 0.730 |
| LTE Band 4+Bluetooth | Head Left Cheek | 0.31 | 0.15 | 0.460 |
| | Head Left Tilt | 0.18 | 0.15 | 0.330 |
| | Head Right Cheek | 0.33 | 0.15 | 0.480 |
| | Head Right Tilt | 0.21 | 0.15 | 0.360 |
| | Body Back | 1.04 | 0.07 | 1.110 |
| LTE Band 7+Bluetooth | Head Left Cheek | 0.25 | 0.15 | 0.400 |
| | Head Left Tilt | 0.23 | 0.15 | 0.380 |
| | Head Right Cheek | 0.49 | 0.15 | 0.640 |
| | Head Right Tilt | 0.42 | 0.15 | 0.570 |
| | Body Back | 0.87 | 0.07 | 0.940 |
| LTE Band 12+Bluetooth | Head Left Cheek | 0.30 | 0.15 | 0.450 |
| | Head Left Tilt | 0.15 | 0.15 | 0.300 |
| | Head Right Cheek | 0.25 | 0.15 | 0.400 |
| | Head Right Tilt | 0.14 | 0.15 | 0.290 |
| | Body Back | 0.49 | 0.07 | 0.560 |
| LTE Band 17+Bluetooth | Head Left Cheek | 0.27 | 0.15 | 0.420 |
| | Head Left Tilt | 0.14 | 0.15 | 0.290 |
| | Head Right Cheek | 0.27 | 0.15 | 0.420 |
| | Head Right Tilt | 0.13 | 0.15 | 0.280 |
| | Body Back | 0.47 | 0.07 | 0.540 |

| Mode(SAR1+SAR2) | Position | Reported SAR(W/kg) | | ΣSAR < 1.6W/kg |
|--|------------------|--------------------|------|----------------|
| | | SAR1 | SAR2 | |
| GSM 850+ WLAN(2.4G) | Head Left Cheek | 0.28 | 0.37 | 0.650 |
| | Head Left Tilt | 0.15 | 0.37 | 0.520 |
| | Head Right Cheek | 0.30 | 0.37 | 0.670 |
| | Head Right Tilt | 0.16 | 0.37 | 0.530 |
| | Body Worn Back | 0.42 | 0.19 | 0.610 |
| GSM 850+ WLAN(2.4G) (Hotspot) | Body Back | 0.59 | 0.19 | 0.780 |
| | Body Left | 0.15 | / | 0.150 |
| | Body Right | 0.29 | 0.19 | 0.480 |
| | Body Top | / | 0.19 | 0.190 |
| | Body Bottom | 0.10 | / | 0.100 |
| PCS1900 + WLAN(2.4G) | Head Left Cheek | 0.14 | 0.37 | 0.510 |
| | Head Left Tilt | 0.11 | 0.37 | 0.480 |
| | Head Right Cheek | 0.24 | 0.37 | 0.610 |
| | Head Right Tilt | 0.08 | 0.37 | 0.450 |
| | Body Worn Back | 0.39 | 0.19 | 0.580 |
| PCS1900 + WLAN(2.4G) (Hotspot) | Body Back | 0.67 | 0.19 | 0.860 |
| | Body Left | 0.08 | / | 0.080 |
| | Body Right | 0.14 | 0.19 | 0.330 |
| | Body Top | / | 0.19 | 0.190 |
| | Body Bottom | 0.77 | / | 0.770 |
| WCDMA Band 2+ WLAN(2.4G) (Hotspot) | Head Left Cheek | 0.27 | 0.37 | 0.640 |
| | Head Left Tilt | 0.18 | 0.37 | 0.550 |
| | Head Right Cheek | 0.36 | 0.37 | 0.730 |
| | Head Right Tilt | 0.14 | 0.37 | 0.510 |
| WCDMA Band 2+ WLAN(2.4G) (Hotspot) | Body Back | 0.66 | 0.19 | 0.850 |
| | Body Left | 0.09 | / | 0.090 |
| | Body Right | 0.16 | 0.19 | 0.350 |
| | Body Top | / | 0.19 | 0.190 |
| | Body Bottom | 0.67 | / | 0.670 |
| WCDMA Band 5+ WLAN(2.4G) (Hotspot) | Head Left Cheek | 0.37 | 0.37 | 0.740 |
| | Head Left Tilt | 0.26 | 0.37 | 0.630 |
| | Head Right Cheek | 0.39 | 0.37 | 0.760 |
| | Head Right Tilt | 0.22 | 0.37 | 0.590 |
| WCDMA Band 5+ WLAN(2.4G) (Hotspot) | Body Back | 0.72 | 0.19 | 0.910 |
| | Body Left | 0.28 | / | 0.280 |
| | Body Right | 0.44 | 0.19 | 0.630 |
| | Body Top | / | 0.19 | 0.190 |
| | Body Bottom | 0.12 | / | 0.120 |

| Mode(SAR1+SAR2) | Position | Reported SAR(W/kg) | | ΣSAR < 1.6W/kg |
|---|------------------|--------------------|------|----------------|
| | | SAR1 | SAR2 | |
| LTE Band 2+ WLAN(2.4G) (Hotspot) | Head Left Cheek | 0.18 | 0.37 | 0.550 |
| | Head Left Tilt | 0.13 | 0.37 | 0.500 |
| | Head Right Cheek | 0.30 | 0.37 | 0.670 |
| | Head Right Tilt | 0.12 | 0.37 | 0.490 |
| LTE Band 2+ WLAN(2.4G) (Hotspot) | Body Back | 1.07 | 0.19 | 1.260 |
| | Body Left | 0.09 | / | 0.090 |
| | Body Right | 0.17 | 0.19 | 0.360 |
| | Body Bottom | 0.64 | / | 0.640 |
| | Body Top | / | 0.19 | 0.190 |
| LTE Band 4+ WLAN(2.4G) (Hotspot) | Head Left Cheek | 0.31 | 0.37 | 0.680 |
| | Head Left Tilt | 0.18 | 0.37 | 0.550 |
| | Head Right Cheek | 0.33 | 0.37 | 0.700 |
| | Head Right Tilt | 0.21 | 0.37 | 0.580 |
| LTE Band 4+ WLAN(2.4G) (Hotspot) | Body Back | 1.04 | 0.19 | 1.230 |
| | Body Left | 0.19 | / | 0.190 |
| | Body Right | 0.16 | 0.19 | 0.350 |
| | Body Bottom | 0.43 | / | 0.430 |
| | Body Top | / | 0.19 | 0.190 |
| LTE Band 7+ WLAN(2.4G) (Hotspot) | Head Left Cheek | 0.25 | 0.37 | 0.620 |
| | Head Left Tilt | 0.23 | 0.37 | 0.600 |
| | Head Right Cheek | 0.49 | 0.37 | 0.860 |
| | Head Right Tilt | 0.42 | 0.37 | 0.790 |
| LTE Band 7+ WLAN(2.4G) (Hotspot) | Body Back | 0.87 | 0.19 | 1.060 |
| | Body Left | 0.36 | / | 0.360 |
| | Body Right | 0.07 | 0.19 | 0.260 |
| | Body Bottom | 0.38 | / | 0.380 |
| | Body Top | / | 0.19 | 0.190 |
| LTE Band 12+ WLAN(2.4G) (Hotspot) | Head Left Cheek | 0.30 | 0.37 | 0.670 |
| | Head Left Tilt | 0.15 | 0.37 | 0.520 |
| | Head Right Cheek | 0.25 | 0.37 | 0.620 |
| | Head Right Tilt | 0.14 | 0.37 | 0.510 |
| LTE Band 12+ WLAN(2.4G) (Hotspot) | Body Back | 0.49 | 0.19 | 0.680 |
| | Body Left | 0.30 | / | 0.300 |
| | Body Right | 0.19 | 0.19 | 0.380 |
| | Body Bottom | 0.06 | / | 0.060 |
| | Body Top | / | 0.19 | 0.190 |

| Mode(SAR1+SAR2) | Position | Reported SAR(W/kg) | | ΣSAR < 1.6W/kg |
|---|------------------|--------------------|------|----------------|
| | | SAR1 | SAR2 | |
| LTE Band 17+ WLAN(2.4G) (Hotspot) | Head Left Cheek | 0.27 | 0.37 | 0.640 |
| | Head Left Tilt | 0.14 | 0.37 | 0.510 |
| | Head Right Cheek | 0.27 | 0.37 | 0.640 |
| | Head Right Tilt | 0.13 | 0.37 | 0.500 |
| LTE Band 17+ WLAN(2.4G) (Hotspot) | Body Back | 0.47 | 0.19 | 0.660 |
| | Body Left | 0.18 | / | 0.180 |
| | Body Right | 0.12 | 0.19 | 0.310 |
| | Body Bottom | 0.07 | / | 0.070 |
| | Body Top | / | 0.19 | 0.190 |

Note:

1. Hotspot mode SAR is measured for all edges and surfaces of the device with a transmitting antenna located within 25 mm from that surface or edge; for the data modes, wireless technologies and frequency bands supporting hotspot mode.

2. Hotspot Mode is not feasible during voice calls.

Conclusion:

Sum of SAR: $\Sigma \text{SAR} \leq 1.6 \text{ W/kg}$ therefore simultaneous transmission SAR with Volume Scans is **not required**.

SAR Plots

Please Refer to the Attachment.

APPENDIX A MEASUREMENT UNCERTAINTY

The uncertainty budget has been determined for the measurement system and is given in the following Table.
Measurement uncertainty evaluation for IEEE1528-2013 SAR test

| Source of uncertainty | Tolerance/ uncertainty ± % | Probability distribution | Divisor | ci (1 g) | ci (10 g) | Standard uncertainty ± %, (1 g) | Standard uncertainty ± %, (10 g) |
|---|----------------------------------|-----------------------------|------------|-------------|--------------|---------------------------------------|--|
| Measurement system | | | | | | | |
| Probe calibration | 6.55 | N | 1 | 1 | 1 | 6.6 | 6.6 |
| Axial Isotropy | 4.7 | R | $\sqrt{3}$ | 1 | 1 | 2.7 | 2.7 |
| Hemispherical Isotropy | 9.6 | R | $\sqrt{3}$ | 0 | 0 | 0.0 | 0.0 |
| Boundary effect | 1.0 | R | $\sqrt{3}$ | 1 | 1 | 0.6 | 0.6 |
| Linearity | 4.7 | R | $\sqrt{3}$ | 1 | 1 | 2.7 | 2.7 |
| Detection limits | 1.0 | R | $\sqrt{3}$ | 1 | 1 | 0.6 | 0.6 |
| Readout electronics | 0.3 | N | 1 | 1 | 1 | 0.3 | 0.3 |
| Response time | 0.0 | R | $\sqrt{3}$ | 1 | 1 | 0.0 | 0.0 |
| Integration time | 0.0 | R | $\sqrt{3}$ | 1 | 1 | 0.0 | 0.0 |
| RF ambient conditions – noise | 1.0 | R | $\sqrt{3}$ | 1 | 1 | 0.6 | 0.6 |
| RF ambient conditions–reflections | 1.0 | R | $\sqrt{3}$ | 1 | 1 | 0.6 | 0.6 |
| Probe positioner mech. Restrictions | 0.8 | R | $\sqrt{3}$ | 1 | 1 | 0.5 | 0.5 |
| Probe positioning with respect to phantom shell | 6.7 | R | $\sqrt{3}$ | 1 | 1 | 3.9 | 3.9 |
| Post-processing | 2.0 | R | $\sqrt{3}$ | 1 | 1 | 1.2 | 1.2 |
| Test sample related | | | | | | | |
| Test sample positioning | 2.8 | N | 1 | 1 | 1 | 2.8 | 2.8 |
| Device holder uncertainty | 6.3 | N | 1 | 1 | 1 | 6.3 | 6.3 |
| Drift of output power | 5.0 | R | $\sqrt{3}$ | 1 | 1 | 2.9 | 2.9 |
| Phantom and set-up | | | | | | | |
| Phantom uncertainty (shape and thickness tolerances) | 4.0 | R | $\sqrt{3}$ | 1 | 1 | 2.3 | 2.3 |
| Liquid conductivity target) | 5.0 | R | $\sqrt{3}$ | 0.64 | 0.43 | 1.8 | 1.2 |
| Liquid conductivity meas.) | 2.5 | N | 1 | 0.64 | 0.43 | 1.6 | 1.1 |
| Liquid permittivity target) | 5.0 | R | $\sqrt{3}$ | 0.6 | 0.49 | 1.7 | 1.4 |
| Liquid permittivity meas.) | 2.5 | N | 1 | 0.6 | 0.49 | 1.5 | 1.2 |
| Combined standard uncertainty | | RSS | | | | 12.2 | 12.0 |
| Expanded uncertainty 95 % confidence interval) | | | | | | 24.3 | 23.9 |

Measurement uncertainty evaluation for IEC62209-2 SAR test

| Source of uncertainty | Tolerance/ uncertainty ± % | Probability distribution | Divisor | ci (1 g) | ci (10 g) | Standard uncertainty ± %, (1 g) | Standard uncertainty ± %, (10 g) |
|--|----------------------------------|-----------------------------|---------|-------------|--------------|---------------------------------------|--|
| Measurement system | | | | | | | |
| Probe calibration | 6.55 | N | 1 | 1 | 1 | 6.6 | 6.6 |
| Axial Isotropy | 4.7 | R | √3 | 1 | 1 | 2.7 | 2.7 |
| Hemispherical Isotropy | 9.6 | R | √3 | 0 | 0 | 0.0 | 0.0 |
| Linearity | 4.7 | R | √3 | 1 | 1 | 2.7 | 2.7 |
| Modulation Response | 0.0 | R | √3 | 1 | 1 | 0.0 | 0.0 |
| Detection limits | 1.0 | R | √3 | 1 | 1 | 0.6 | 0.6 |
| Boundary effect | 1.0 | R | √3 | 1 | 1 | 0.6 | 0.6 |
| Readout electronics | 0.3 | N | 1 | 1 | 1 | 0.3 | 0.3 |
| Response time | 0.0 | R | √3 | 1 | 1 | 0.0 | 0.0 |
| Integration time | 0.0 | R | √3 | 1 | 1 | 0.0 | 0.0 |
| RF ambient conditions – noise | 1.0 | R | √3 | 1 | 1 | 0.6 | 0.6 |
| RF ambient conditions–reflections | 1.0 | R | √3 | 1 | 1 | 0.6 | 0.6 |
| Probe positioner mech. Restrictions | 0.8 | R | √3 | 1 | 1 | 0.5 | 0.5 |
| Probe positioning with respect to phantom shell | 6.7 | R | √3 | 1 | 1 | 3.9 | 3.9 |
| Post-processing | 2.0 | R | √3 | 1 | 1 | 1.2 | 1.2 |
| Test sample related | | | | | | | |
| Device holder Uncertainty | 6.3 | N | 1 | 1 | 1 | 6.3 | 6.3 |
| Test sample positioning | 2.8 | N | 1 | 1 | 1 | 2.8 | 2.8 |
| Power scaling | 4.5 | R | √3 | 1 | 1 | 2.6 | 2.6 |
| Drift of output power | 5.0 | R | √3 | 1 | 1 | 2.9 | 2.9 |
| Phantom and set-up | | | | | | | |
| Phantom uncertainty (shape and thickness tolerances) | 4.0 | R | √3 | 1 | 1 | 2.3 | 2.3 |
| Algorithm for correcting SAR for deviations in permittivity and conductivity | 1.9 | N | 1 | 1 | 0.84 | 1.1 | 0.9 |
| Liquid conductivity (meas.) | 2.5 | N | 1 | 0.64 | 0.43 | 1.6 | 1.1 |
| Liquid permittivity (meas.) | 2.5 | N | 1 | 0.6 | 0.49 | 1.5 | 1.2 |
| Temp. unc. - Conductivity | 1.7 | R | √3 | 0.78 | 0.71 | 0.8 | 0.7 |
| Temp. unc. - Permittivity | 0.3 | R | √3 | 0.23 | 0.26 | 0.0 | 0.0 |
| Combined standard uncertainty | | RSS | | | | 12.2 | 12.1 |
| Expanded uncertainty 95 % confidence interval) | | | | | | 24.5 | 24.2 |

APPENDIX B EUT TEST POSITION PHOTOS

Please Refer to the Attachment.

APPENDIX C CALIBRATION CERTIFICATES

Please Refer to the Attachment.

******* END OF REPORT *******