



Quick Start Guide



Scan the QR code with the EZVIZ App
to add the device to your account.
Please keep it for further reference.

COPYRIGHT © Hangzhou EZVIZ Software Co., Ltd.. ALL RIGHTS RESERVED.

Any and all information, including, among others, wordings, pictures, graphs are the properties of Hangzhou EZVIZ Software Co., Ltd. (hereinafter referred to as "EZVIZ"). This user manual (hereinafter referred to as "the Manual") cannot be reproduced, changed, translated, or distributed, partially or wholly, by any means, without the prior written permission of EZVIZ. Unless otherwise stipulated, EZVIZ does not make any warranties, guarantees or representations, express or implied, regarding to the Manual.

About this Manual

The Manual includes instructions for using and managing the product. Pictures, charts, images and all other information hereinafter are for description and explanation only. The information contained in the Manual is subject to change, without notice, due to firmware updates or other reasons. Please find the latest version in the EZVIZ™ website (<http://www.ezvizlife.com>).

Revision Record

New release – January, 2019

Trademarks Acknowledgement

EZVIZ™, ™, and other EZVIZ's trademarks and logos are the properties of EZVIZ in various jurisdictions. Other trademarks and logos mentioned below are the properties of their respective owners.

Legal Disclaimer

TO THE MAXIMUM EXTENT PERMITTED BY APPLICABLE LAW, THE PRODUCT DESCRIBED, WITH ITS HARDWARE, SOFTWARE AND FIRMWARE, IS PROVIDED "AS IS", WITH ALL FAULTS AND ERRORS, AND EZVIZ MAKES NO WARRANTIES, EXPRESS OR IMPLIED, INCLUDING WITHOUT LIMITATION, MERCHANTABILITY, SATISFACTORY QUALITY, FITNESS FOR A PARTICULAR PURPOSE, AND NON-INFRINGEMENT OF THIRD PARTY. IN NO EVENT WILL EZVIZ, ITS DIRECTORS, OFFICERS, EMPLOYEES, OR AGENTS BE LIABLE TO YOU FOR ANY SPECIAL, CONSEQUENTIAL, INCIDENTAL, OR INDIRECT DAMAGES, INCLUDING, AMONG OTHERS, DAMAGES FOR LOSS OF BUSINESS PROFITS, BUSINESS INTERRUPTION, OR LOSS OF DATA OR DOCUMENTATION, IN CONNECTION WITH THE USE OF THIS PRODUCT, EVEN IF EZVIZ HAS BEEN ADVISED OF THE POSSIBILITY OF SUCH DAMAGES.

TO THE MAXIMUM EXTENT PERMITTED BY APPLICABLE LAW, IN NO EVENT SHALL EZVIZ'S TOTAL LIABILITY FOR ALL DAMAGES EXCEED THE ORIGINAL PURCHASE PRICE OF THE PRODUCT.

EZVIZ DOES NOT UNDERTAKE ANY LIABILITY FOR PERSONAL INJURY OR PROPERTY DAMAGE AS THE RESULT OF PRODUCT INTERRUPTION OR SERVICE TERMINATION CAUSED BY: A) IMPROPER INSTALLATION OR USAGE OTHER THAN AS REQUESTED; B) THE PROTECTION OF NATIONAL OR PUBLIC INTERESTS; C) FORCE MAJEURE; D) YOURSELF OR THE THIRD PARTY, INCLUDING WITHOUT LIMITATION, USING ANY THIRD PARTY'S PRODUCTS, SOFTWARE, APPLICATIONS, AND AMONG OTHERS.

REGARDING TO THE PRODUCT WITH INTERNET ACCESS, THE USE OF PRODUCT SHALL BE WHOLLY AT YOUR OWN RISKS. EZVIZ SHALL NOT TAKE ANY RESPONSIBILITIES FOR ABNORMAL OPERATION, PRIVACY LEAKAGE OR OTHER DAMAGES RESULTING FROM CYBER ATTACK, HACKER ATTACK, VIRUS INSPECTION, OR OTHER INTERNET SECURITY RISKS; HOWEVER, EZVIZ WILL PROVIDE TIMELY TECHNICAL SUPPORT IF REQUIRED. SURVEILLANCE LAWS AND DATA PROTECTION LAWS VARY BY JURISDICTION. PLEASE CHECK ALL RELEVANT LAWS IN YOUR JURISDICTION BEFORE USING THIS PRODUCT IN ORDER TO ENSURE THAT YOUR USE CONFORMS TO THE APPLICABLE LAW. EZVIZ SHALL NOT BE LIABLE IN THE EVENT THAT THIS PRODUCT IS USED WITH ILLEGITIMATE PURPOSES.

IN THE EVENT OF ANY CONFLICTS BETWEEN THE ABOVE AND THE APPLICABLE LAW, THE LATTER PREVAILS.

Regulatory Information

FCC Information

This device complies with Part 15 of the FCC Rules. Operation is subject to the following two conditions:

- (1) This device may not cause harmful interference, and
- (2) This device must accept any interference received, including interference that may cause undesired operation.

Note: This product has been tested and found to comply with the limits for a Class B digital device, pursuant to Part 15 of the FCC Rules. These limits are designed to provide reasonable protection against harmful interference in a residential installation. This product generates, uses, and can radiate radio frequency energy and, if not installed and used in accordance with the instructions, may cause harmful interference to radio communications. However, there is no guarantee that interference will not occur in a particular installation. If this product does cause harmful interference to radio or television reception, which can be determined by turning the equipment off and on, the

user is encouraged to try to correct the interference by one or more of the following measures:

- Reorient or relocate the receiving antenna.
- Increase the separation between the equipment and receiver.
- Connect the equipment into an outlet on a circuit different from that to which the receiver is connected.
- Consult the dealer or an experienced radio/TV technician for help.

Please take attention that changes or modification not expressly approved by the party responsible for compliance could void the user's authority to operate the equipment.

This equipment should be installed and operated with a minimum distance 20cm between the radiator and your body.

This device complies with Industry Canada licence-exempt RSS standard(s). Operation is subject to the following two conditions:

- (1) this device may not cause interference, and
- (2) this device must accept any interference, including interference that may cause undesired operation of the device.

Under Industry Canada regulations, this radio transmitter may only operate using an antenna of a type and maximum (or lesser) gain approved for the transmitter by Industry Canada. To reduce potential radio interference to other users, the antenna type and its gain should be so chosen that the equivalent isotropically radiated power (e.i.r.p.) is not more than that necessary for successful communication.

EU Conformity Statement



This product and - if applicable - the supplied accessories too are marked with "CE" and comply therefore with the applicable harmonized European standards listed under the Radio Equipment Directive 2014/53/EU, the EMC Directive 2014/30/EU, the RoHS Directive 2011/65/EU.

2012/19/EU (WEEE directive): Products marked with this symbol cannot be disposed of as unsorted municipal waste in the European Union. For proper recycling, return this product to your local supplier upon the purchase of equivalent new equipment, or dispose of it at designated collection points. For more information see: www.recyclethis.info.



2006/66/EC and its amendment 2013/56/EU (battery directive): This product contains a battery that cannot be disposed of as unsorted municipal waste in the European Union. See the product documentation for specific battery information. The battery is marked with this symbol, which may include lettering to indicate cadmium (Cd), lead (Pb), or mercury (Hg). For proper recycling, return the battery to your supplier or to a designated collection point. For more information see: www.recyclethis.info.

Industry Canada ICES-003 Compliance

This device meets the CAN ICES-3 (B)/NMB-3(B) standards requirements.

EC DECLARATION OF CONFORMITY

Hereby, Hangzhou EZVIZ Software Co.,Ltd. declares that the radio equipment type [CS-DB2] is in compliance with Directive 2014/53/EU.

The full text of the EC DECLARATION OF CONFORMITY is available at the following web link:

<http://www.ezvizlife.com/declaration-of-conformity>.

Safety Instruction

	Note: Please read the manual before using the device.
	This symbol on the device indicates that the safety compatibility manual and / or installation manual must be read, which contains information related to the safe operation of the device. Caution: Be sure to read these instructions before operating the equipment.

Due to the product shape and dimension, the name and address of the importer/ manufacturer are printed on the package.

Customer Service

For more information, please visit www.ezvizlife.com.

Need help? Please visit "www.ezvizlife.com/inter/page/contact-us" for our local contact details.

SAVE THIS MANUAL FOR FUTURE REFERENCE

1. Package Contents

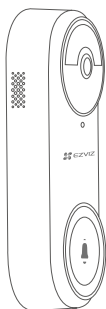

Doorbell (x1)



Mounting Plate (x1)



Inclined Mounting Plate (x2)

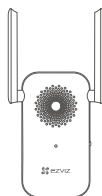

Chime (x1)

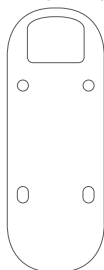

Foam Sticker (x1)

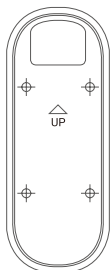

Drill Template (x1)

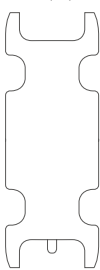

Plate Foam (x1)



Screwdriver (x1)



Wire Connector (x3)



U-shaped Wire (x2)



Pin (x1)



Screw Kit (x1)



Power Adapter (x1)

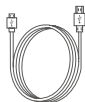

Power Cable (x1)



Quick Start Guide (x1)

i The appearance of chime and power adapter is subject to the actual one you have bought.

Tools You May Need

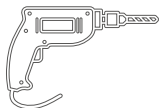

Drill (x1)
It is recommended to use a drill with diameter of 6mm.

2. Basics

Doorbell

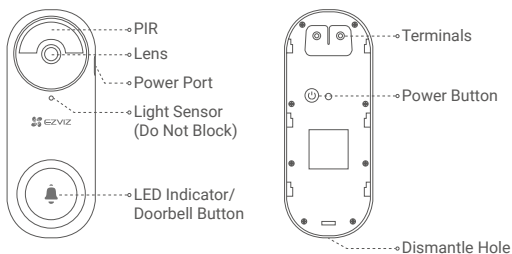

Name	Description
LED Indicator	<ul style="list-style-type: none">• Solid Red: Less than 20% battery left.• Slow-Flashing Red: Charging.• Solid Blue: Person detected or doorbell pressed/fully charged/more than 20% battery left.
Power Button	<ul style="list-style-type: none">• Short press for 1 second: Turn on the doorbell.• Long press for 5 seconds: Turn off the doorbell.

Chime

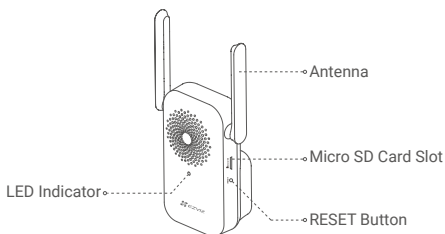

Name	Description
LED Indicator	<ul style="list-style-type: none">• Solid Red: Chime is starting up.• Fast-Flashing Red: Disconnected from the doorbell or SD card error.• Slow-Flashing Red: Wi-Fi connection has failed.• Solid Blue: Chime is functioning properly.• Fast-Flashing Blue: Chime is ready for Wi-Fi connection.
Reset Button	Long press for 5 seconds to restart and all parameters are reset to default.

Setup

- i** It is recommended to place the chime within 4 meters from where the doorbell is installed.

1. Power-on

1. Short press the power button for 1 second to turn on the doorbell. The doorbell beeps once and LED indicator flashes twice, indicating that the doorbell is turned on.

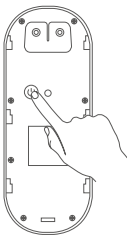

2. Plug the chime into a power outlet (within 4 meters from the doorbell). When the LED indicator is fast-flashing blue, it is ready for Wi-Fi connection.

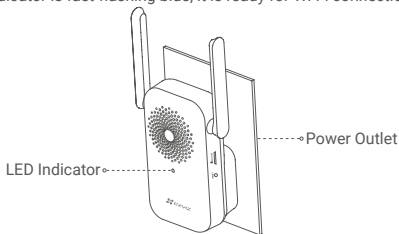

2. Add to EZVIZ App

1. Create a user account.

- Connect your mobile phone to Wi-Fi (suggested).
- Search for "EZVIZ" in the App Store or Google Play™.
- Download and install the EZVIZ app.
- Launch the app and register an EZVIZ user account.

2. Add chime to EZVIZ.

- Log in the EZVIZ app.
- On the Home screen, tap "+" on the upper-right corner to go to the scan QR code page.

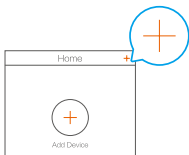

- Scan the QR code on the body of the chime.

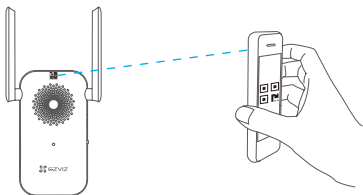

- Follow the EZVIZ app wizard to finish Wi-Fi configuration.

The doorbell will connect to the network by automatically connecting to the chime. Please press the doorbell to check. The chime rings indicating that the connection is successful.

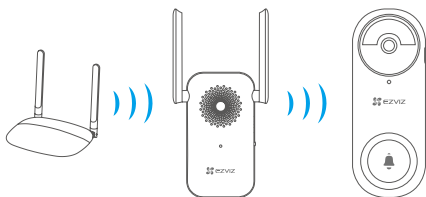

- i** If the network connection of doorbell fails, please adjust the position of the chime. It is recommended to put the chime and doorbell within 4 meters.

Installation

1. Doorbell Installation

- i** • Recommended installation height: 1.2m-1.5m.

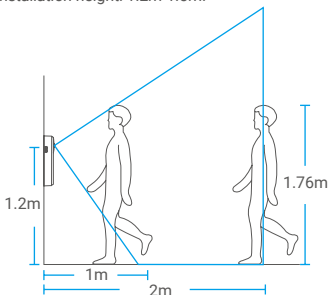

- The following situations are not recommended for installation. Otherwise the network connection may be affected:
 1. Iron doors;
 2. Corners of load-bearing walls.
- Please make sure you have finished Wi-fi configuration of the chime and its LED indicator is solid blue before installation.

Step 1: Installation preparation.

If you have an existing doorbell system or have installed a mechanical or electronic chime, you can replace the existing doorbell with the EZVIZ doorbell.

- Please ring the existing doorbell first to make sure it's working.
- Determine the mounting position of the doorbell, and check if you can reuse the existing holes on the wall.

- i** If you don't have a doorbell or chime installed, skip step 1 and directly go to step 2.

Step 2: Shut off the electricity at the breaker.

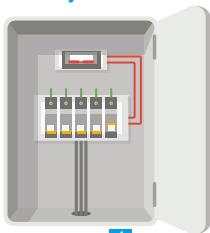

- i** Note: Always be careful when handling electricity wiring. If you're not comfortable to do it yourself, do consult a qualified electrician.

Step 3: Select the mounting plate.

Install directly by the mounting plate, or use one of the inclined mounting plates as a supplementary mounting bracket if you wish to see more on a specific side.

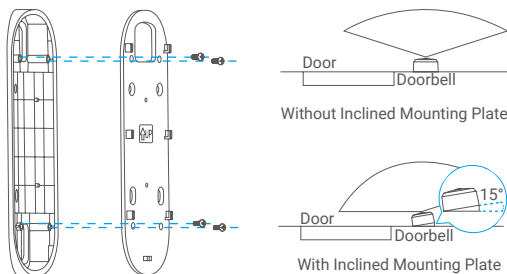

Step 3: Install the mounting plate.

If the wall is smooth:

- Stick the plate foam on the mounting plate and then paste them to the wall.

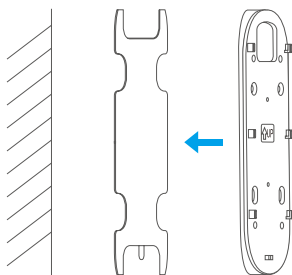

If the wall is uneven,

- Place the drill template onto the surface you have chosen to mount the doorbell.
- (Optional) Drill four screw holes and insert anchors. There is no need to use anchor if you were installing on wooden doorframe.



- i** It is recommended to use a drill with diameter of 6mm.

- Fix the mounting plate to the wall.
(Please fix the upper two screws first.)

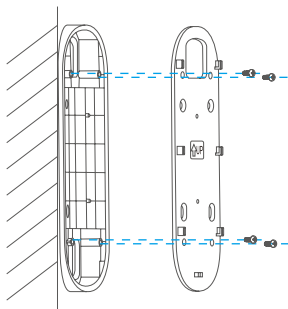

Step 4: Install the doorbell.

- (Optional) For users who have previously installed a doorbell, connect the existing doorbell wires to the terminals at the back of the EZVIZ doorbell, then tighten the terminal screws.

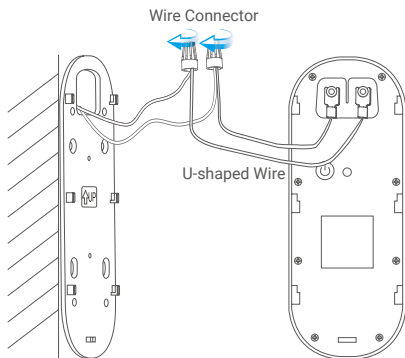

- Install the doorbell to the mounting plate.

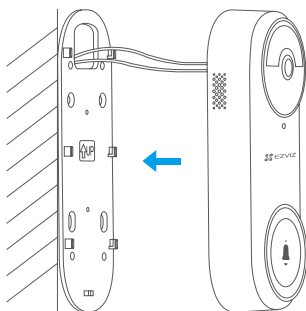

Step 4: Restore power at the breaker.

EN

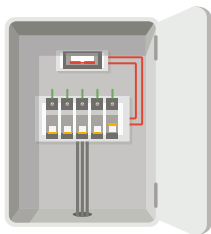

2. Micro SD Card Installation (Optional)

- Insert the micro SD card (sold separately) into the card slot as shown in the figure below.

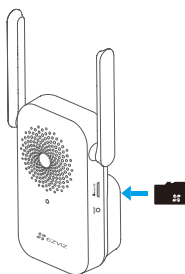

- In the EZVIZ app, tap the **Storage Status** in the Device Settings interface to check the SD card status.
- If the memory card status displays as **Uninitialized**, tap to initialize it. The status will then change to **Normal** and it can store videos.

Maintenance

When the doorbell battery is low, connect the doorbell to power outlet via power adapter.

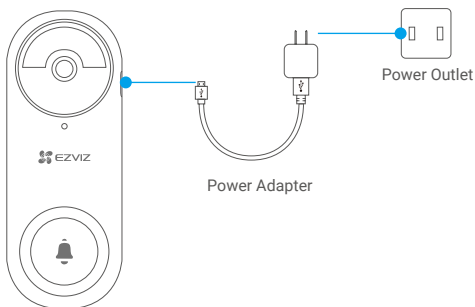

You can also remove the doorbell from the mounting plate to charge by using the pin provided. Press and hold the hole on the bottom of the doorbell and then take it off.

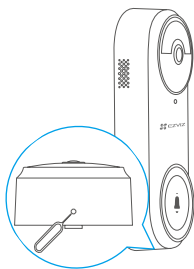

- When charging, the doorbell will automatically turn on.
- Please make sure to shut off the electricity at the breaker before removing the doorbell if it's wire connected.

EXPOSURE TO RADIOFREQUENCY RF(for EU Market)

The frequency bands and the nominal limits of transmitted power (radiated and/or conducted) applicable to this radio device are the following:

Band	Wi-Fi 2.4 GHz
Frequency	From 2.412 GHz to 2.472 GHz
Power transmission (EIRP)	100 mW

- For detailed information, please visit www.ezvizlife.com.

LIMITED WARRANTY

Thank you for purchasing Hangzhou EZVIZ Software Co., Ltd. ("EZVIZ") products. This limited warranty ("warranty") gives you, the original purchaser of the EZVIZ product, specific legal rights. You may also have other legal rights that vary by state, province or jurisdiction. This warranty applies only to the original purchaser of the product. "Original purchaser" means any consumer having purchased the EZVIZ product from an authorized seller. The disclaimers, exclusions, and limitations of liability under this warranty will not apply to the extent prohibited by applicable law. No distributor, reseller, agent, or employee is authorized to make any modification, extension, or addition to this warranty.

Your EZVIZ product is warranted for a period of two (2) years from the date of purchase against defects in materials and workmanship, or such longer period as may be required by law in the country or state where this product is sold, when used normally in accordance with user manual.

You can request warranty service by contacting our Customer Service. For any defective EZVIZ products under warranty, EZVIZ will, at its option, (i) repair or replace your product free of charge; (ii) exchange your product with a functional equivalent product; or (iii) refund the original purchase price, provided you provide the original purchase receipt or copy, a brief explanation of the defect, and return the product in its original packaging. At EZVIZ's sole discretion, repair or replacement may be made with a new or refurbished product or components. This warranty does not cover the shipping cost, insurance, or any other incidental charges incurred by you in returning the product.

Except where prohibited by applicable law, this is your sole and exclusive remedy for breach of this warranty. Any product that has either been repaired or replaced under this warranty will be covered by the terms of this warranty for the longer of ninety (90) days from the date of delivery or the remaining original warranty period.

This warranty does not apply and is void:

- If the warranty claim is made outside the warranty period or if the proof of purchase is not provided;
- For any malfunction, defect, or failure caused by or resulting from the evidence of impact; mishandling; tampering; use contrary to the applicable instruction manual; incorrect power line voltage; accident; loss; theft; fire; flood; or other Acts of God; shipping damage; or damage resulting from repairs performed by unauthorized personnel;
- For any consumable parts, such as batteries, where the malfunction is due to the normal aging of the product;
- Cosmetic damage, including but not limited to scratches, dents, and broken plastic on ports;
- Any software, even if packaged or sold with EZVIZ hardware;
- For any other damages free from defects in material or workmanship;
- Routine cleaning, normal cosmetic and mechanical wear and tear.

Please do not hesitate to contact your seller or our Customer Service, with any questions.

