



**SGS-CSTC Standards Technical Services Co.,  
Ltd. Shanghai Branch**

588 West Jindu Road, Xinqiao, Songjiang, 201612 Shanghai, China

Telephone: +86 (0) 21 6191 5666

Fax: +86 (0) 21 6191 5678

ee.shanghai@sgs.com

Report No.: SHEM181000907101

Page: 1 of 60

# TEST REPORT

**Application No.:** SHEM180009071CR  
**FCC ID** 2APV2-CSDP1  
**IC** 23928-CSDP1  
**Applicant:** Hangzhou Ezviz Software Co., Ltd.  
**Address of Applicant:** Floor 16, Unit B Building 1, No. 555, Qianmo Road, Binjiang District, Hangzhou City, Zhejiang Province  
**Manufacturer:** Hangzhou Ezviz Software Co., Ltd.  
**Address of Manufacturer:** Floor 16, Unit B Building 1, No. 555, Qianmo Road, Binjiang District, Hangzhou City, Zhejiang Province  
**Factory:** Hangzhou Hikvision Electronics Co., Ltd.  
**Address of Factory:** No.299, Qiushi Road, Tonglu Economic Development Zone, Tonglu County, Hangzhou, Zhejiang, 310052, China.

**Equipment Under Test (EUT):**

**EUT Name:** Wire-free Smart Door Viewer  
**Model No.:** CS-DP1,CS-DP1C,CS-DP1S,CS-DP1i,CS-DP1Si ㄨ  
 ㄨ Please refer to section 2 of this report which indicates which model was actually tested and which were electrically identical.

**Trade mark:** eZVIZ  
**Standard(s) :** 47 CFR Part 15, Subpart C 15.247  
 RSS-247 Issue 2, February 2017, RSS-Gen Issue 5, April 2018

**Date of Receipt:** 2018-09-10  
**Date of Test:** 2018-09-20 to 2018-09-25  
**Date of Issue:** 2018-11-02

<b>Test Result:</b>	<b>Pass*</b>
---------------------	--------------

\* In the configuration tested, the EUT complied with the standards specified above.



Parlam Zhan  
E&E Section Manager

The manufacturer should ensure that all products in series production are in conformity with the product sample detailed in this report. If the product in this report is used in any configuration other than that detailed in the report, the manufacturer must ensure the new system complies with all relevant standards. Any mention of SGS International Electrical Approvals or testing done by SGS International Electrical Approvals in connection with, distribution or use of the product described in this report must be approved by SGS International Electrical Approvals in writing.

This document is issued by the Company subject to its General Conditions of Service printed overleaf, available on request or accessible at <http://www.sgs.com/en/Terms-and-Conditions.aspx> and, for electronic format documents, subject to Terms and Conditions for Electronic Documents at <http://www.sgs.com/en/Terms-and-Conditions/Terms-e-Document.aspx>. Attention is drawn to the limitation of liability, indemnification and jurisdiction issues defined therein. Any holder of this document is advised that information contained hereon reflects the Company's findings at the time of its intervention only and within the limits of Client's instructions, if any. The Company's sole responsibility is to its Client and this document does not exonerate parties to a transaction from exercising all their rights and obligations under the transaction documents. This document cannot be reproduced except in full, without prior written approval of the Company. Any unauthorized alteration, forgery or falsification of the content or appearance of this document is unlawful and offenders may be prosecuted to the fullest extent of the law. Unless otherwise stated the results shown in this test report refer only to the sample(s) tested and such sample(s) are retained for 30 days only.

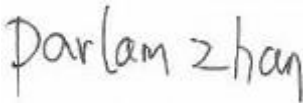

Revision Record			
Version	Description	Date	Remark
00	Original	2018-11-02	/

Authorized for issue by:			
			
		<hr/>	
		Bill Wu / Project Engineer	
			
		<hr/>	
		Parlam Zhan / Reviewer	



## 2 Test Summary

Radio Spectrum Technical Requirement				
Item	Standard	Method	Requirement	Result
Antenna Requirement	47 CFR Part 15, Subpart C 15.247	N/A	47 CFR Part 15, Subpart C 15.203 & 15.247(c)	Pass

Radio Spectrum Matter Part				
Item	Standard	Method	Requirement	Result
Conducted Emissions at AC Power Line (150kHz-30MHz)	47 CFR Part 15, Subpart C 15.247	ANSI C63.10 (2013) Section 6.2	47 CFR Part 15, Subpart C 15.207	Pass
Minimum 6dB Bandwidth	47 CFR Part 15, Subpart C 15.247	ANSI C63.10 (2013) Section 11.8.1	47 CFR Part 15, Subpart C 15.247a(2)	Pass
Conducted Peak Output Power	47 CFR Part 15, Subpart C 15.247	ANSI C63.10 (2013) Section 11.9.1	47 CFR Part 15, Subpart C 15.247(b)(3)	Pass
Power Spectrum Density	47 CFR Part 15, Subpart C 15.247	ANSI C63.10 (2013) Section 11.10.2	47 CFR Part 15, Subpart C 15.247(e)	Pass
Conducted Band Edges Measurement	47 CFR Part 15, Subpart C 15.247	ANSI C63.10 (2013) Section 11.13.3.2	47 CFR Part 15, Subpart C 15.247(d)	Pass
Conducted Spurious Emissions	47 CFR Part 15, Subpart C 15.247	ANSI C63.10 (2013) Section 11.11	47 CFR Part 15, Subpart C 15.247(d)	Pass
Radiated Emissions which fall in the restricted bands	47 CFR Part 15, Subpart C 15.247	ANSI C63.10 (2013) Section 6.10.5	47 CFR Part 15, Subpart C 15.209 & 15.247(d)	Pass
Radiated Spurious Emissions	47 CFR Part 15, Subpart C 15.247	ANSI C63.10 (2013) Section 6.4,6.5,6.6	47 CFR Part 15, Subpart C 15.209 & 15.247(d)	Pass
99% Bandwidth	RSS-247 Issue 2, February 2017	ANSI C63.10 Section 6.9.3	RSS-Gen Section 6.6	Pass
Frequency Stability	RSS-Gen April 2018	RSS-Gen Section 6.11	RSS-Gen Section 8.11	Pass

### Declaration of EUT Family Grouping:

Note: There are series models mentioned in this report, and they are the identical in electrical and electronic characters. Only the model CS-DP1 was tested since their differences were the, their naming and color silk.



### 3 Contents

	Page
1 COVER PAGE.....	1
2 TEST SUMMARY .....	3
3 CONTENTS.....	4
4 GENERAL INFORMATION.....	6
4.1 DETAILS OF E.U.T. ....	6
4.2 DESCRIPTION OF SUPPORT UNITS .....	6
4.3 MEASUREMENT UNCERTAINTY.....	7
4.4 TEST LOCATION.....	8
4.5 TEST FACILITY.....	8
4.6 DEVIATION FROM STANDARDS.....	8
4.7 ABNORMALITIES FROM STANDARD CONDITIONS.....	8
5 EQUIPMENT LIST .....	9
6 RADIO SPECTRUM TECHNICAL REQUIREMENT.....	10
6.1 ANTENNA REQUIREMENT .....	10
6.1.1 Test Requirement:.....	10
6.1.2 Conclusion .....	10
7 RADIO SPECTRUM MATTER TEST RESULTS.....	11
7.1 CONDUCTED EMISSIONS AT AC POWER LINE (150kHz-30MHz).....	11
7.1.1 E.U.T. Operation .....	11
7.1.2 Test Setup Diagram.....	11
7.1.3 Measurement Procedure and Data .....	12
7.2 MINIMUM 6dB BANDWIDTH.....	15
7.2.1 E.U.T. Operation .....	15
7.2.2 Test Setup Diagram.....	15
7.2.3 Measurement Procedure and Data .....	15
7.3 CONDUCTED PEAK OUTPUT POWER .....	16
7.3.1 E.U.T. Operation .....	16
7.3.2 Test Setup Diagram.....	16
7.3.3 Measurement Procedure and Data .....	16
7.4 POWER SPECTRUM DENSITY.....	17
7.4.1 E.U.T. Operation .....	17
7.4.2 Test Setup Diagram.....	17
7.4.3 Measurement Procedure and Data .....	17
7.5 CONDUCTED BAND EDGES MEASUREMENT.....	18
7.5.1 E.U.T. Operation .....	18
7.5.2 Test Setup Diagram.....	18
7.5.3 Measurement Procedure and Data .....	18
7.6 CONDUCTED SPURIOUS EMISSIONS .....	19
7.6.1 E.U.T. Operation .....	19
7.6.2 Test Setup Diagram.....	19
7.6.3 Measurement Procedure and Data .....	19
7.7 RADIATED EMISSIONS WHICH FALL IN THE RESTRICTED BANDS .....	20
7.7.1 E.U.T. Operation .....	21
7.7.2 Test Setup Diagram.....	21
7.7.3 Measurement Procedure and Data .....	22



7.8	RADIATED SPURIOUS EMISSIONS.....	51
7.8.1	<i>E.U.T. Operation</i> .....	52
7.8.2	<i>Test Setup Diagram</i> .....	52
7.8.3	<i>Measurement Procedure and Data</i> .....	53
7.9	99% BANDWIDTH.....	58
7.9.1	<i>E.U.T. Operation</i> .....	58
7.9.2	<i>Test Setup Diagram</i> .....	58
7.9.3	<i>Measurement Procedure and Data</i> .....	58
7.10	FREQUENCY STABILITY.....	59
7.10.1	<i>E.U.T. Operation</i> .....	59
7.10.2	<i>Test Setup Diagram</i> .....	59
7.10.3	<i>Measurement Procedure and Data</i> .....	59
<b>8</b>	<b>TEST SETUP PHOTOGRAPHS .....</b>	<b>60</b>
<b>9</b>	<b>EUT CONSTRUCTIONAL DETAILS.....</b>	<b>60</b>



## 4 General Information

### 4.1 Details of E.U.T.

Power supply:	DC 3.85V 18.33Wh Rechargeable Battery
Test voltage:	AC 120V/60Hz
Cable:	DC Cable 1m
Antenna Gain	1dBi
Antenna Type	Helical Antenna
Channel Spacing	5MHz
Modulation Type	802.11b: DSSS (CCK, DQPSK, DBPSK) 802.11g/n: OFDM (64QAM, 16QAM, QPSK, BPSK)
Number of Channels	802.11b/g/n(HT20):11 802.11n(HT40):7
Operation Frequency	802.11b/g/n(HT20): 2412MHz to 2462MHz 802.11n(HT40): 2422MHz to 2452MHz

### 4.2 Description of Support Units

Description	Manufacturer	Model No.	Serial No.
AC Adapter	DVE	DSA-12G-12FEU	/
Laptop	Lenovo	ThinkPad X100e	/
SecureCRT	VanDyke	V 6.2.0	/
Serial port adapter plate	/	Test Plate 3	/



#### 4.3 Measurement Uncertainty

No.	Item	Measurement Uncertainty
1	Radio Frequency	7.25 x 10 <sup>-8</sup>
2	Timeout	2s
3	Duty cycle	0.37%
4	Occupied Bandwidth	3%
5	RF conducted power	0.75dB
6	RF power density	2.84dB
7	Conducted Spurious emissions	0.75dB
8	RF Radiated power	4.5dB (Below 1GHz)
		4.8dB (Above 1GHz)
9	Radiated Spurious emission test	4.2dB (Below 30MHz)
		4.4dB (30MHz-1GHz)
		4.6dB (1GHz-18GHz)
		5.2dB (Above 18GHz)
10	Temperature test	1°C
11	Humidity test	3%
12	Supply voltages	1.5%
13	Time	3%

Note: The measurement uncertainty represents an expanded uncertainty expressed at approximately the 95% confidence level using a coverage factor of k=2.



#### 4.4 Test Location

All tests were performed at:

SGS-CSTC Standards Technical Services Co., Ltd. Shanghai Branch

588 West Jindu Road, Xinqiao, Songjiang, 201612 Shanghai, China

Tel: +86 21 6191 5666

Fax: +86 21 6191 5678

No tests were sub-contracted.

#### 4.5 Test Facility

The test facility is recognized, certified, or accredited by the following organizations:

- **CNAS (No. CNAS L0599)**

CNAS has accredited SGS-CSTC Standards Technical Services (Shanghai) Co., Ltd. to ISO/IEC 17025:2005 General Requirements for the Competence of Testing and Calibration Laboratories (CNAS-CL01 Accreditation Criteria for the Competence of Testing and Calibration Laboratories) for the competence in the field of testing.

- **NVLAP (Certificate No. 201034-0)**

SGS-CSTC Standards Technical Services (Shanghai) Co., Ltd. is accredited by the National Voluntary Laboratory Accreditation Program (NVLAP). Certificate No. 201034-0.

- **FCC –Designation Number: CN5033**

SGS-CSTC Standards Technical Services (Shanghai) Co., Ltd. has been recognized as an accredited testing laboratory.

Designation Number: CN5033. Test Firm Registration Number: 479755.

- **Industry Canada (IC) – IC Assigned Code: 8617A**

The 3m Semi-anechoic chamber of SGS-CSTC Standards Technical Services (Shanghai) Co., Ltd. has been registered by Certification and Engineering Bureau of Industry Canada for radio equipment testing with Registration No.: 8617A-1.

- **VCCI (Member No.: 3061)**

The 3m Semi-anechoic chamber and Shielded Room of SGS-CSTC Standards Technical Services (Shanghai) Co., Ltd. has been registered in accordance with the Regulations for Voluntary Control Measures with Registration No.: R-13868, C-14336, T-12221, G-10830 respectively.

#### 4.6 Deviation from Standards

None

#### 4.7 Abnormalities from Standard Conditions

None





## 5 Equipment List

Equipment	Manufacturer	Model No	Inventory No	Cal Date	Cal Due Date
<b>Conducted Emission at AC Power Line</b>					
EMI test receiver	R&S	ESR7	SHEM162-1	2017-12-20	2018-12-19
LISN	Schwarzbeck	NSLK8127	SHEM061-1	2017-12-20	2018-12-19
LISN	EMCO	3816/2	SHEM019-1	2017-12-20	2018-12-19
Pulse limiter	R&S	ESH3-Z2	SHEM029-1	2017-12-20	2018-12-19
CE test Cable	/	CE01	/	2017-12-26	2018-12-25
<b>Conducted Test</b>					
Spectrum Analyzer	R&S	FSP-30	SHEM002-1	2017-12-20	2018-12-19
Spectrum Analyzer	Agilent	N9020A	SHEM181-1	2018-08-13	2019-08-12
Signal Generator	R&S	SMR20	SHEM006-1	2018-08-13	2019-08-12
Signal Generator	Agilent	N5182A	SHEM182-1	2018-08-13	2019-08-12
Communication Tester	R&S	CMW270	SHEM183-1	2018-08-13	2019-08-12
Switcher	Tonscend	JS0806	SHEM184-1	2018-08-13	2019-08-12
Power Sensor	Keysight	U2021XA * 4	SHEM184-1	2018-08-13	2019-08-12
Splitter	Anritsu	MA1612A	SHEM185-1	/	/
Coupler	e-meca	803-S-1	SHEM186-1	/	/
High-low Temp Cabinet	Suzhou Zhihe	TL-40	SHEM087-1	2017-09-25	2020-09-24
AC Power Stabilizer	WOCEN	6100	SHEM045-1	2017-12-26	2018-12-25
DC Power Supply	QJE	QJ30003SII	SHEM046-1	2017-12-26	2018-12-25
Conducted test Cable	/	RF01~RF04	/	2017-12-26	2018-12-25
<b>Radiated Test</b>					
EMI test Receiver	R&S	ESU40	SHEM051-1	2017-12-20	2018-12-19
Spectrum Analyzer	R&S	FSP-30	SHEM002-1	2017-12-20	2018-12-19
Loop Antenna (9kHz-30MHz)	Schwarzbeck	FMZB1519	SHEM135-1	2017-04-10	2020-04-09
Antenna (25MHz-2GHz)	Schwarzbeck	VULB9168	SHEM048-1	2017-02-28	2020-02-27
Antenna (25MHz-3GHz)	Schwarzbeck	HL562	SHEM010-1	2017-02-28	2020-02-27
Horn Antenna (1-8GHz)	Schwarzbeck	HF906	SHEM009-1	2017-10-24	2020-10-23
Horn Antenna (1-18GHz)	Schwarzbeck	BBHA9120D	SHEM050-1	2017-01-14	2020-01-13
Horn Antenna (14-40GHz)	Schwarzbeck	BBHA 9170	SHEM049-1	2017-12-03	2020-12-02
Pre-amplifier (9kHz-2GHz)	CLAVIO	BDLNA-0001	SHEM164-1	2018-08-13	2019-08-12
Pre-amplifier (1-18GHz)	CLAVIO	BDLNA-0118	SHEM050-2	2018-08-13	2019-08-12
High-amplifier (14-40GHz)	Schwarzbeck	10001	SHEM049-2	2017-12-20	2018-12-19
Signal Generator	R&S	SMR40	SHEM058-1	2018-08-13	2019-08-12
Band Filter	LORCH	9BRX-875/X150	SHEM156-1	/	/
Band Filter	LORCH	13BRX-1950/X500	SHEM083-2	/	/
Band Filter	LORCH	5BRX-2400/X200	SHEM155-1	/	/
Band Filter	LORCH	5BRX-5500/X1000	SHEM157-2	/	/
High pass Filter	Wainwright	WHK3.0/18G	SHEM157-1	/	/
High pass Filter	Wainwright	WHKS1700	SHEM157-3	/	/
Semi/Fully Anechoic	ST	11*6*6M	SHEM078-2	2017-07-22	2020-07-21
RE test Cable	/	RE01, RE02, RE06	/	2017-12-26	2018-12-25

## 6 Radio Spectrum Technical Requirement

### 6.1 Antenna Requirement

#### 6.1.1 Test Requirement:

47 CFR Part 15, Subpart C 15.203 & 15.247(c)

#### 6.1.2 Conclusion

Standard Requirement:

An intentional radiator shall be designed to ensure that no antenna other than that furnished by the responsible party shall be used with the device. The use of a permanently attached antenna or of an antenna that uses a unique coupling to the intentional radiator, the manufacturer may design the unit so that a broken antenna can be replaced by the user, but the use of a standard antenna jack or electrical connector is prohibited.

15.247(b) (4) requirement:

The conducted output power limit specified in paragraph (b) of this section is based on the use of antennas with directional gains that do not exceed 6 dBi. Except as shown in paragraph (c) of this section, if transmitting antennas of directional gain greater than 6 dBi are used, the conducted output power from the intentional radiator shall be reduced below the stated values in paragraphs (b)(1), (b)(2), and (b)(3) of this section, as appropriate, by the amount in dB that the directional gain of the antenna exceeds 6 dBi.

EUT Antenna:

The antenna is helical antenna and no consideration of replacement. The best case gain of the antenna is 1dBi.

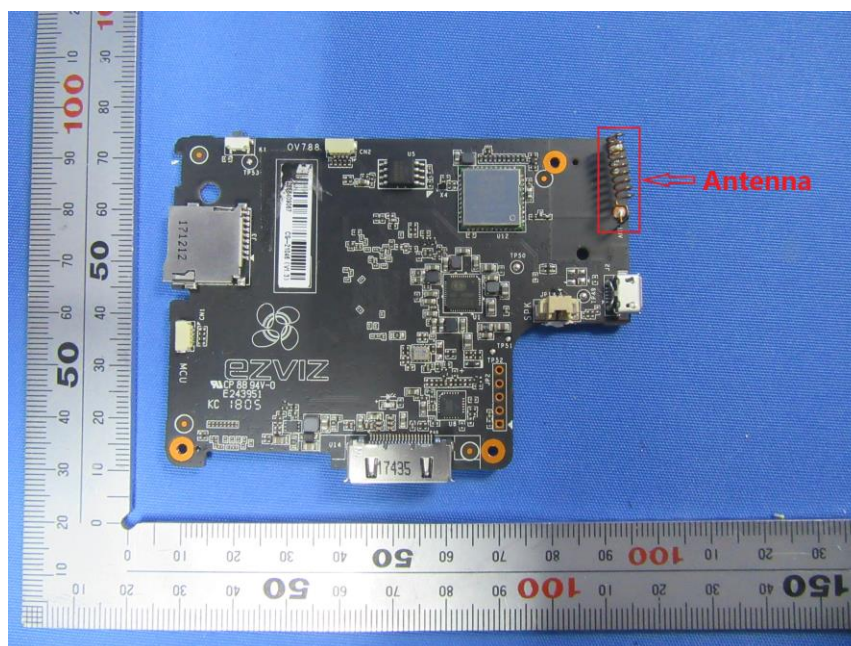

## 7 Radio Spectrum Matter Test Results

### 7.1 Conducted Emissions at AC Power Line (150kHz-30MHz)

Test Requirement 47 CFR Part 15, Subpart C 15.207  
 Test Method: ANSI C63.10 (2013) Section 6.2  
 Limit:

Frequency of emission(MHz)	Conducted limit(dBμV)	
	Quasi-peak	Average
0.15-0.5	66 to 56*	56 to 46*
0.5-5	56	46
5-30	60	50

\*Decreases with the logarithm of the frequency.

#### 7.1.1 E.U.T. Operation

Operating Environment:

Temperature: 20 °C Humidity: 50 % RH Atmospheric Pressure: 1010 mbar

Test mode a:Charge + TX mode\_Keep the EUT in charging and continuously transmitting mode with all modulation types. All data rates for each modulation type have been tested and found the data rate @ 1Mbps is the worst case of IEEE 802.11b; data rate @ 6Mbps is the worst case of IEEE 802.11g; data rate @ 6.5Mbps is the worst case of IEEE 802.11n(HT20); data rate @ 13.5Mbps is the worst case of IEEE 802.11n(HT40). Only the data of worst case is recorded in the report.

#### 7.1.2 Test Setup Diagram

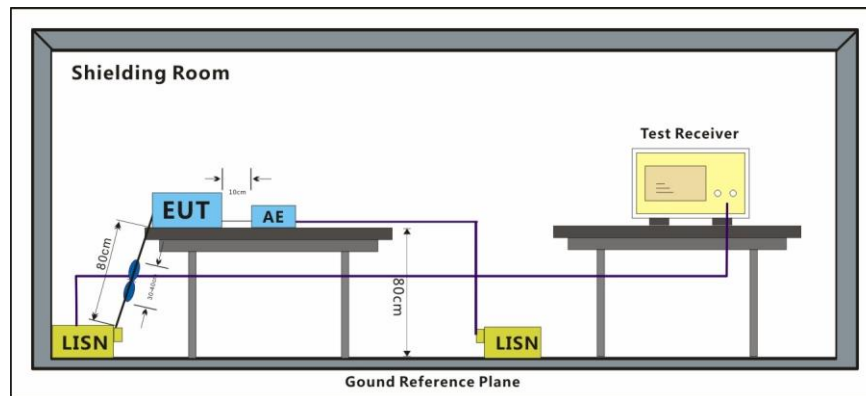



### 7.1.3 Measurement Procedure and Data

- 1) The mains terminal disturbance voltage test was conducted in a shielded room.
- 2) The EUT was connected to AC power source through a LISN 1 (Line Impedance Stabilization Network) which provides a 50ohm/50μH + 5ohm linear impedance. The power cables of all other units of the EUT were connected to a second LISN 2, which was bonded to the ground reference plane in the same way as the LISN 1 for the unit being measured. A multiple socket outlet strip was used to connect multiple power cables to a single LISN provided the rating of the LISN was not exceeded.
- 3) The tabletop EUT was placed upon a non-metallic table 0.8m above the ground reference plane. And for floor-standing arrangement, the EUT was placed on the horizontal ground reference plane,
- 4) The test was performed with a vertical ground reference plane. The rear of the EUT shall be 0.4 m from the vertical ground reference plane. The vertical ground reference plane was bonded to the horizontal ground reference plane. The LISN 1 was placed 0.8 m from the boundary of the unit under test and bonded to a ground reference plane for LISNs mounted on top of the ground reference plane. This distance was between the closest points of the LISN 1 and the EUT. All other units of the EUT and associated equipment was at least 0.8 m from the LISN 2.
- 5) In order to find the maximum emission, the relative positions of equipment and all of the interface cables must be changed according to ANSI C63.10 on conducted measurement.

Remark: LISN=Read Level+ Cable Loss+ LISN Factor



Mode:a; Line:Live Line

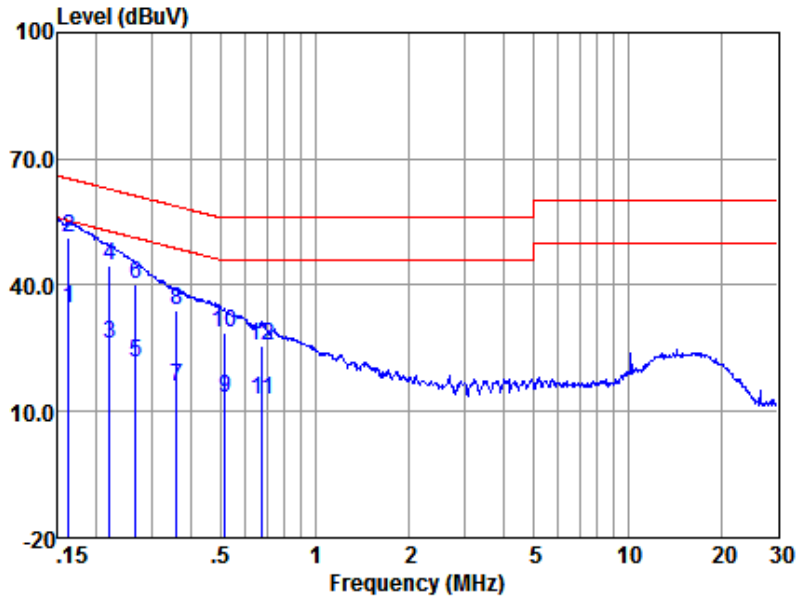

LISN : LINE  
EUT/Project No : 7899IT  
Test mode : a

	Freq (MHz)	Read level (dBuV)	LISN Factor (dB)	Cable Loss (dB)	Emission Level (dBuV)	Limit (dBuV)	Over Limit (dB)	Remark
1	0.16	24.64	0.05	9.82	34.51	55.34	-20.83	Average
2	0.16	41.48	0.05	9.82	51.35	65.34	-13.99	QP
3	0.22	16.15	0.05	9.84	26.04	52.83	-26.79	Average
4	0.22	34.90	0.05	9.84	44.79	62.83	-18.04	QP
5	0.27	11.60	0.05	9.85	21.50	51.20	-29.70	Average
6	0.27	30.27	0.05	9.85	40.17	61.20	-21.03	QP
7	0.36	5.93	0.05	9.84	15.82	48.74	-32.92	Average
8	0.36	24.09	0.05	9.84	33.98	58.74	-24.76	QP
9	0.52	3.42	0.05	9.78	13.25	46.00	-32.75	Average
10	0.52	18.94	0.05	9.78	28.77	56.00	-27.23	QP
11	0.68	2.88	0.04	9.85	12.77	46.00	-33.23	Average
12	0.68	15.90	0.04	9.85	25.79	56.00	-30.21	QP

Notes: Emission Level = Read Level + LISN Factor + Cable loss



Mode:a; Line:Neutral Line

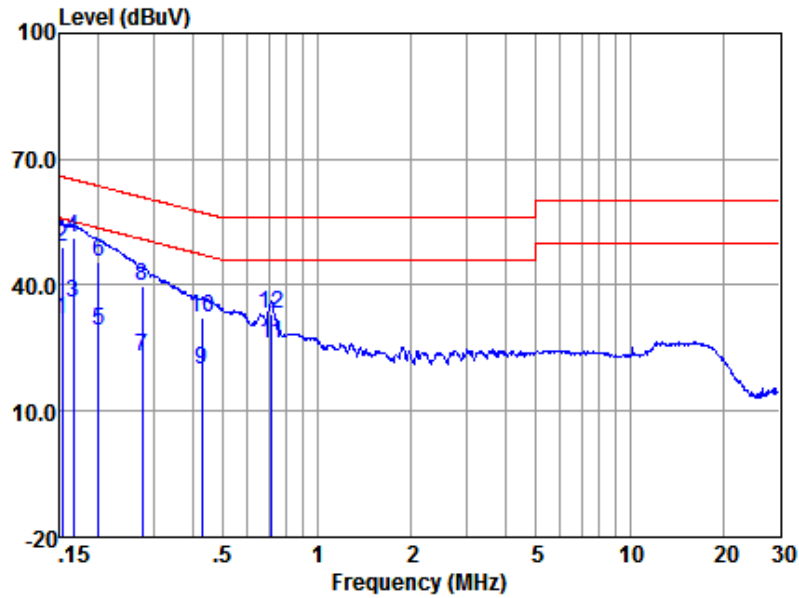

LISN : NEUTRAL  
EUT/Project No : 7899IT  
Test mode : a

	Freq (MHz)	Read level (dBuV)	LISN Factor (dB)	Cable Loss (dB)	Emission Level (dBuV)	Limit (dBuV)	Over Limit (dB)	Remark
1	0.15	22.00	0.06	9.82	31.88	55.87	-23.99	Average
2	0.15	39.28	0.06	9.82	49.16	65.87	-16.71	QP
3	0.17	25.86	0.06	9.83	35.75	55.16	-19.41	Average
4	0.17	41.18	0.06	9.83	51.07	65.16	-14.09	QP
5	0.20	19.44	0.06	9.83	29.33	53.62	-24.29	Average
6	0.20	35.74	0.06	9.83	45.63	63.62	-17.99	QP
7	0.28	13.05	0.06	9.85	22.96	50.94	-27.98	Average
8	0.28	29.97	0.06	9.85	39.88	60.94	-21.06	QP
9	0.43	9.93	0.05	9.84	19.82	47.29	-27.47	Average
10	0.43	22.41	0.05	9.84	32.30	57.29	-24.99	QP
11	0.72	16.33	0.05	9.86	26.24	46.00	-19.76	Average
12	0.72	23.12	0.05	9.86	33.03	56.00	-22.97	QP

Notes: Emission Level = Read Level + LISN Factor + Cable loss



## 7.2 Minimum 6dB Bandwidth

Test Requirement	47 CFR Part 15, Subpart C 15.247a(2)
Test Method:	ANSI C63.10 (2013) Section 11.8.1
Limit:	≥500 kHz

### 7.2.1 E.U.T. Operation

Operating Environment:

Temperature: 20 °C      Humidity: 50 % RH      Atmospheric Pressure: 1010 mbar

Test mode a: Charge + TX mode\_Keep the EUT in charging and continuously transmitting mode with all modulation types. All data rates for each modulation type have been tested and found the data rate @ 1Mbps is the worst case of IEEE 802.11b; data rate @ 6Mbps is the worst case of IEEE 802.11g; data rate @ 6.5Mbps is the worst case of IEEE 802.11n(HT20); data rate @ 13.5Mbps is the worst case of IEEE 802.11n(HT40). Only the data of worst case is recorded in the report.

### 7.2.2 Test Setup Diagram

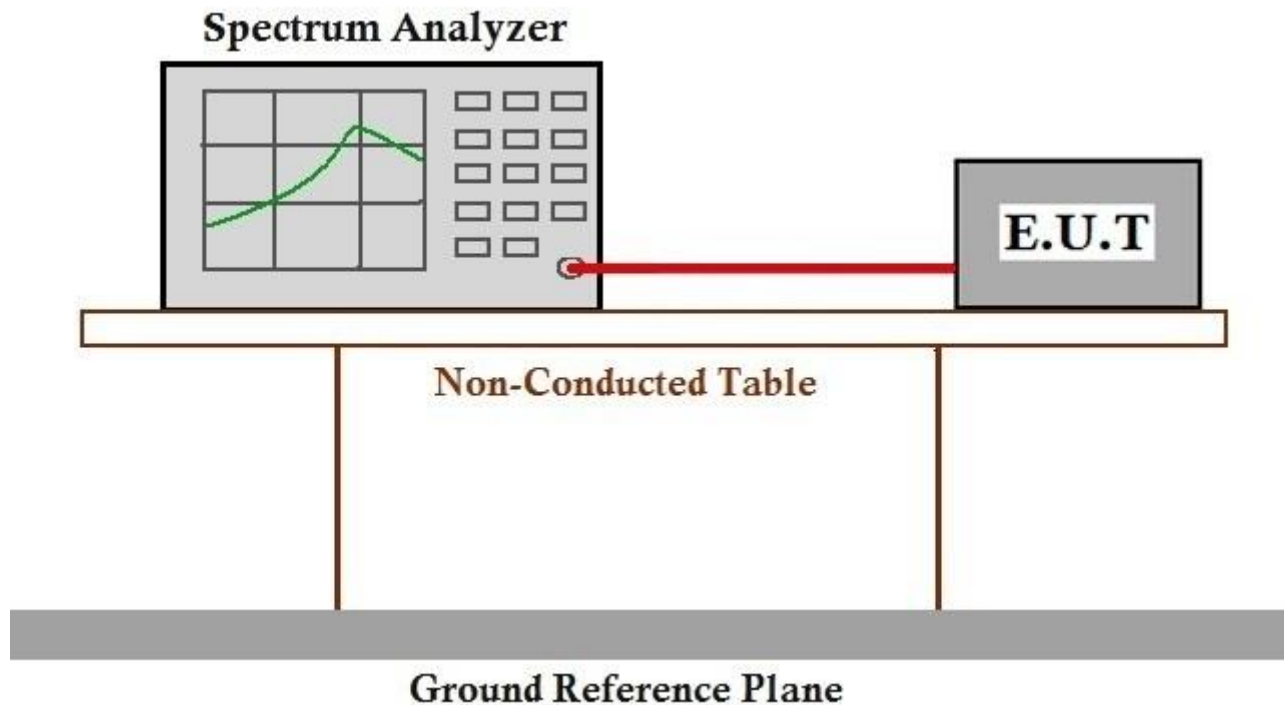

### 7.2.3 Measurement Procedure and Data

The detailed test data see: Appendix A SHEM180900789801

### 7.3 Conducted Peak Output Power

Test Requirement 47 CFR Part 15, Subpart C 15.247(b)(3)

Test Method: ANSI C63.10 (2013) Section 11.9.1

Limit:

Frequency range(MHz)	Output power of the intentional radiator(watt)
902-928	1 for $\geq 50$ hopping channels
	0.25 for $25 \leq$ hopping channels $< 50$
	1 for digital modulation
2400-2483.5	1 for $\geq 75$ non-overlapping hopping channels
	0.125 for all other frequency hopping systems
	1 for digital modulation
5725-5850	1 for frequency hopping systems and digital modulation

#### 7.3.1 E.U.T. Operation

Operating Environment:

Temperature: 20 °C Humidity: 50 % RH Atmospheric Pressure: 1010 mbar

Test mode a: Charge + TX mode\_Keep the EUT in charging and continuously transmitting mode with all modulation types. All data rates for each modulation type have been tested and found the data rate @ 1Mbps is the worst case of IEEE 802.11b; data rate @ 6Mbps is the worst case of IEEE 802.11g; data rate @ 6.5Mbps is the worst case of IEEE 802.11n(HT20); data rate @ 13.5Mbps is the worst case of IEEE 802.11n(HT40). Only the data of worst case is recorded in the report.

#### 7.3.2 Test Setup Diagram

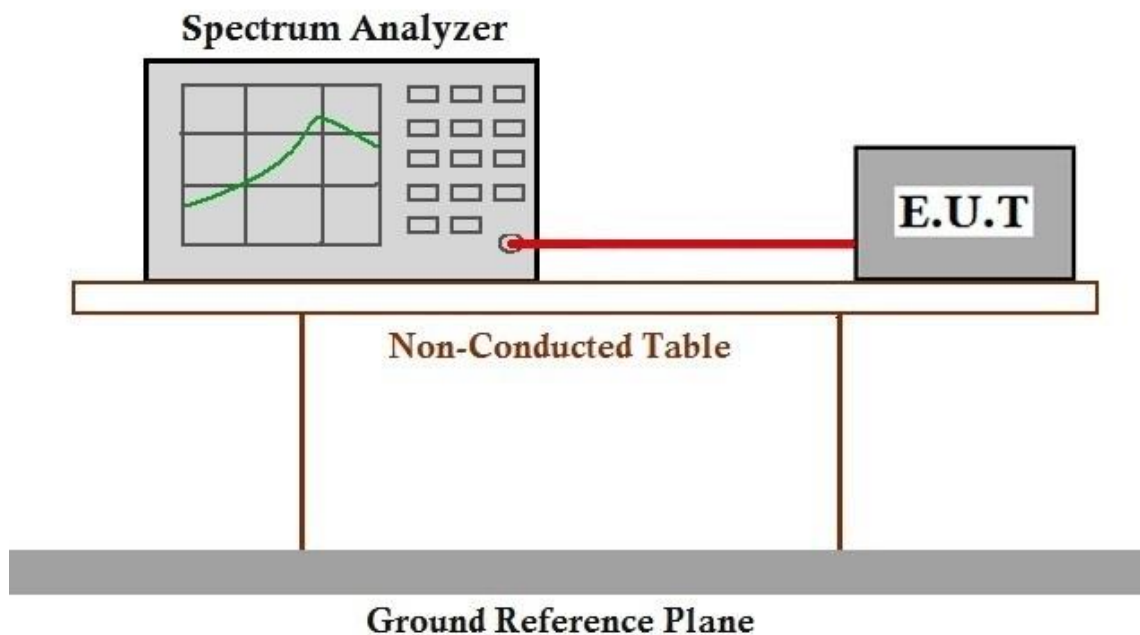

#### 7.3.3 Measurement Procedure and Data

The detailed test data see: Appendix A SHEM180900789801



### 7.4 Power Spectrum Density

Test Requirement	47 CFR Part 15, Subpart C 15.247(e)
Test Method:	ANSI C63.10 (2013) Section 11.10.2
Limit:	≤8dBm in any 3 kHz band during any time interval of continuous transmission

#### 7.4.1 E.U.T. Operation

Operating Environment:

Temperature: 20 °C      Humidity: 50 % RH      Atmospheric Pressure: 1010 mbar

Test mode a: Charge + TX mode\_Keep the EUT in charging and continuously transmitting mode with all modulation types. All data rates for each modulation type have been tested and found the data rate @ 1Mbps is the worst case of IEEE 802.11b; data rate @ 6Mbps is the worst case of IEEE 802.11g; data rate @ 6.5Mbps is the worst case of IEEE 802.11n(HT20); data rate @ 13.5Mbps is the worst case of IEEE 802.11n(HT40). Only the data of worst case is recorded in the report.

#### 7.4.2 Test Setup Diagram

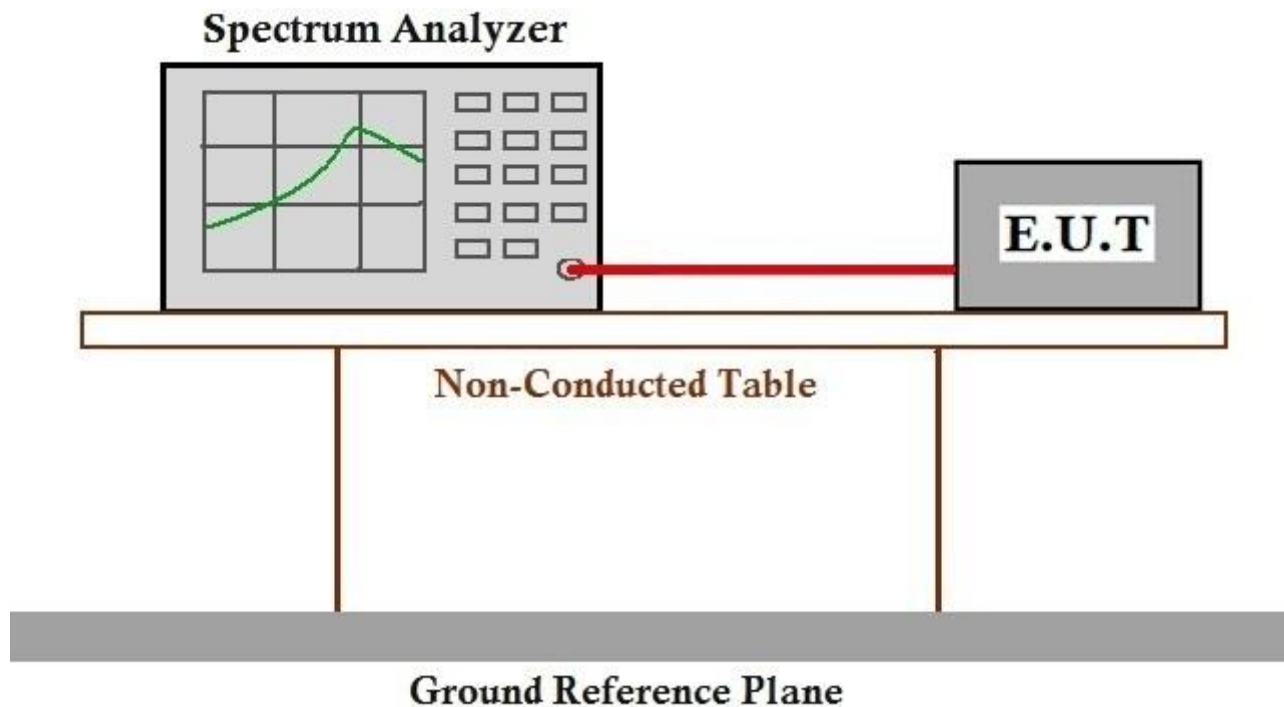

#### 7.4.3 Measurement Procedure and Data

The detailed test data see: Appendix A SHEM180900789801

## 7.5 Conducted Band Edges Measurement

Test Requirement	47 CFR Part 15, Subpart C 15.247(d)
Test Method:	ANSI C63.10 (2013) Section 11.13.3.2
Limit:	In any 100 kHz bandwidth outside the frequency band in which the spread spectrum or digitally modulated intentional radiator is operating, the radio frequency power that is produced by the intentional radiator shall be at least 20 dB below that in the 100 kHz bandwidth within the band that contains the highest level of the desired power, based on either an RF conducted or a radiated measurement, provided the transmitter demonstrates compliance with the peak conducted power limits. If the transmitter complies with the conducted power limits based on the use of RMS averaging over a time interval, as permitted under paragraph (b)(3) of this section, the attenuation required under this paragraph shall be 30 dB instead of 20 dB. Attenuation below the general limits specified in §15.209(a) is not required. In addition, radiated emissions which fall in the restricted bands, as defined in §15.205(a), must also comply with the radiated emission limits specified in §15.209(a) (see §15.205(c))

### 7.5.1 E.U.T. Operation

Operating Environment:	
Temperature:	20 °C      Humidity: 50 % RH      Atmospheric Pressure: 1010 mbar
Test mode	a:Charge + TX mode_Keep the EUT in charging and continuously transmitting mode with all modulation types. All data rates for each modulation type have been tested and found the data rate @ 1Mbps is the worst case of IEEE 802.11b; data rate @ 6Mbps is the worst case of IEEE 802.11g; data rate @ 6.5Mbps is the worst case of IEEE 802.11n(HT20); data rate @ 13.5Mbps is the worst case of IEEE 802.11n(HT40). Only the data of worst case is recorded in the report.

### 7.5.2 Test Setup Diagram

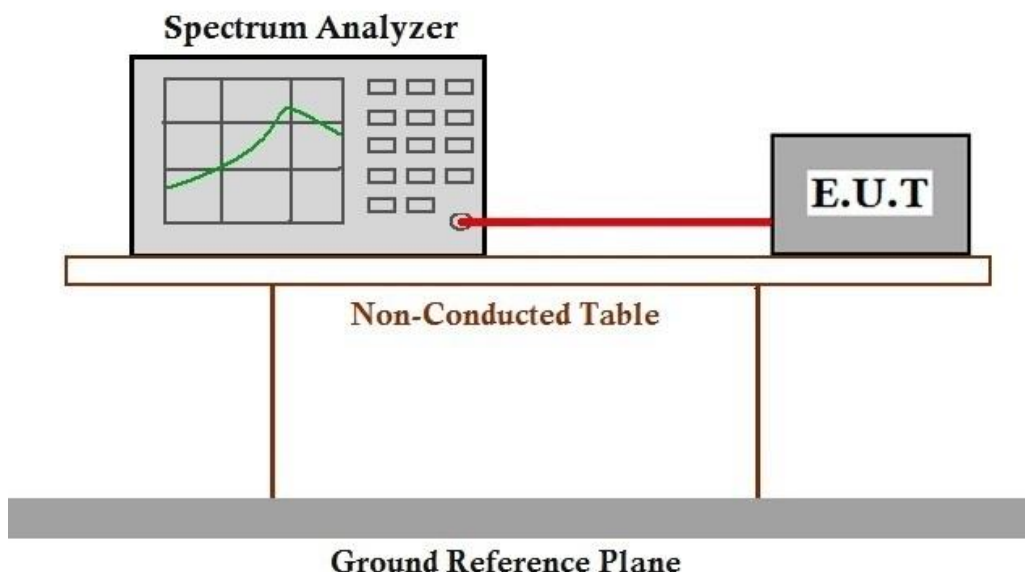

### 7.5.3 Measurement Procedure and Data

The detailed test data see: Appendix A SHEM180900789801

## 7.6 Conducted Spurious Emissions

Test Requirement	47 CFR Part 15, Subpart C 15.247(d)
Test Method:	ANSI C63.10 (2013) Section 11.11
Limit:	In any 100 kHz bandwidth outside the frequency band in which the spread spectrum or digitally modulated intentional radiator is operating, the radio frequency power that is produced by the intentional radiator shall be at least 20 dB below that in the 100 kHz bandwidth within the band that contains the highest level of the desired power, based on either an RF conducted or a radiated measurement, provided the transmitter demonstrates compliance with the peak conducted power limits. If the transmitter complies with the conducted power limits based on the use of RMS averaging over a time interval, as permitted under paragraph (b)(3) of this section, the attenuation required under this paragraph shall be 30 dB instead of 20 dB. Attenuation below the general limits specified in §15.209(a) is not required. In addition, radiated emissions which fall in the restricted bands, as defined in §15.205(a), must also comply with the radiated emission limits specified in §15.209(a) (see §15.205(c))

### 7.6.1 E.U.T. Operation

Operating Environment:	
Temperature:	20 °C      Humidity: 50 % RH      Atmospheric Pressure: 1010 mbar
Test mode	a:Charge + TX mode_Keep the EUT in charging and continuously transmitting mode with all modulation types. All data rates for each modulation type have been tested and found the data rate @ 1Mbps is the worst case of IEEE 802.11b; data rate @ 6Mbps is the worst case of IEEE 802.11g; data rate @ 6.5Mbps is the worst case of IEEE 802.11n(HT20); data rate @ 13.5Mbps is the worst case of IEEE 802.11n(HT40). Only the data of worst case is recorded in the report.

### 7.6.2 Test Setup Diagram

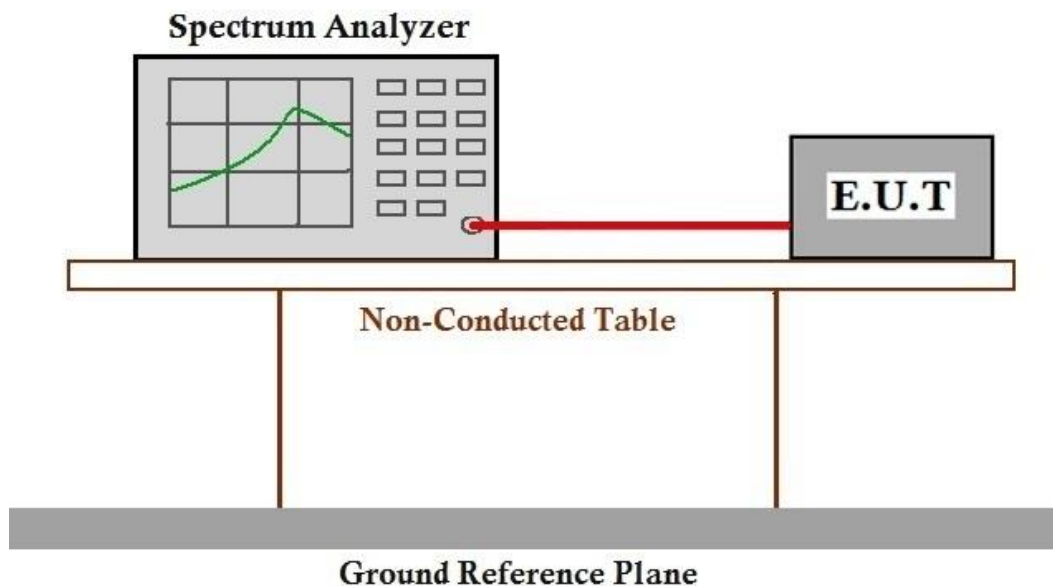

### 7.6.3 Measurement Procedure and Data

The detailed test data see: Appendix A SHEM180900789801



### 7.7 Radiated Emissions which fall in the restricted bands

Test Requirement 47 CFR Part 15, Subpart C 15.209 & 15.247(d)

Test Method: ANSI C63.10 (2013) Section 6.10.5

Limit:

Frequency(MHz)	Field strength(microvolts/meter)	Measurement distance(meters)
0.009-0.490	2400/F(kHz)	300
0.490-1.705	24000/F(kHz)	30
1.705-30.0	30	30
30-88	100	3
88-216	150	3
216-960	200	3
Above 960	500	3

Remark: The emission limits shown in the above table are based on measurements employing a CISPR quasi-peak detector except for the frequency bands 9-90kHz, 110-490kHz and above 1000 MHz. Radiated emission limits in these three bands are based on measurements employing an average detector, the peak field strength of any emission shall not exceed the maximum permitted average limits specified above by more than 20 dB under any condition of modulation.

### 7.7.1 E.U.T. Operation

Operating Environment:

Temperature: 20 °C Humidity: 50 % RH Atmospheric Pressure: 1010 mbar

Test mode a: Charge + TX mode\_Keep the EUT in charging and continuously transmitting mode with all modulation types. All data rates for each modulation type have been tested and found the data rate @ 1Mbps is the worst case of IEEE 802.11b; data rate @ 6Mbps is the worst case of IEEE 802.11g; data rate @ 6.5Mbps is the worst case of IEEE 802.11n(HT20); data rate @ 13.5Mbps is the worst case of IEEE 802.11n(HT40). Only the data of worst case is recorded in the report.

### 7.7.2 Test Setup Diagram

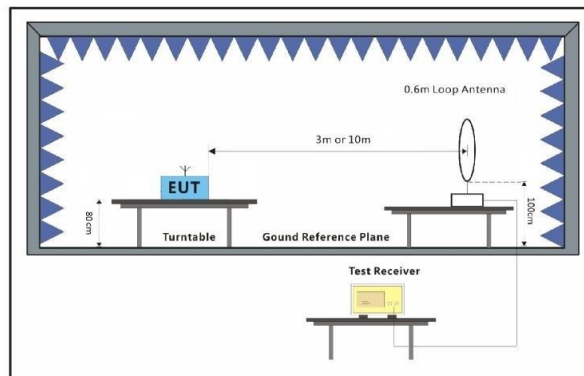
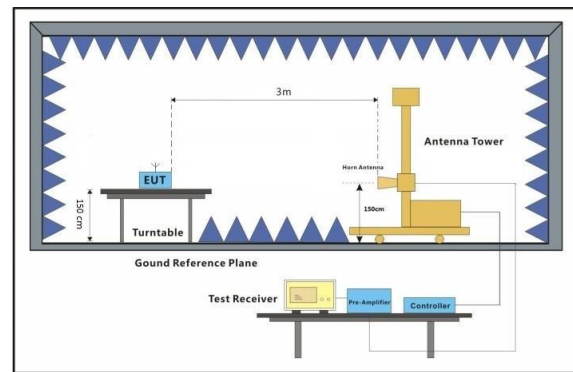
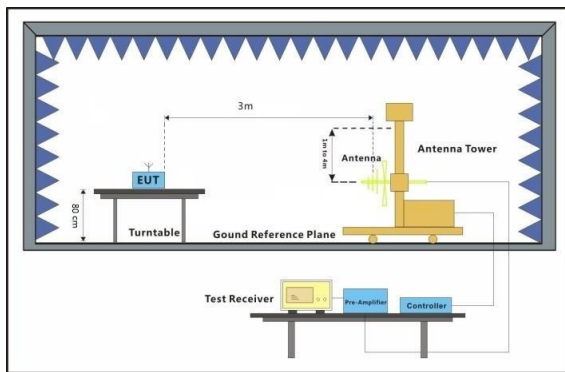



### 7.7.3 Measurement Procedure and Data

- a. For below 1GHz, the EUT was placed on the top of a rotating table 0.8 meters above the ground at a 3 or 10 meter semi-anechoic chamber. The table was rotated 360 degrees to determine the position of the highest radiation.
- b. For above 1GHz, the EUT was placed on the top of a rotating table 1.5 meters above the ground at a 3 meter fully-anechoic chamber. The table was rotated 360 degrees to determine the position of the highest radiation.
- c. The EUT was set 3 or 10 meters away from the interference-receiving antenna, which was mounted on the top of a variable-height antenna tower.
- d. The antenna height is varied from one meter to four meters above the ground to determine the maximum value of the field strength. Both horizontal and vertical polarizations of the antenna are set to make the measurement.
- e. For each suspected emission, the EUT was arranged to its worst case and then the antenna was tuned to heights from 1 meter to 4 meters (for the test frequency of below 30MHz, the antenna was tuned to heights 1 meter) and the rotatable table was turned from 0 degrees to 360 degrees to find the maximum reading.
- f. The test-receiver system was set to Peak Detect Function and Specified Bandwidth with Maximum Hold Mode.
- g. If the emission level of the EUT in peak mode was 10dB lower than the limit specified, then testing could be stopped and the peak values of the EUT would be reported. Otherwise the emissions that did not have 10dB margin would be re-tested one by one using peak, quasi-peak or average method as specified and then reported in a data sheet.
- h. Test the EUT in the lowest channel, the middle channel, the Highest channel.
- i. The radiation measurements are performed in X, Y, Z axis positioning for Transmitting mode, and found the X axis positioning which it is the worst case.
- j. Repeat above procedures until all frequencies measured was complete.

Remark 1:  $\text{Level} = \text{Read Level} + \text{Cable Loss} + \text{Antenna Factor} - \text{Preamp Factor}$

Remark 2: For frequencies above 1GHz, the field strength limits are based on average limits. However, the peak field strength of any emission shall not exceed the maximum permitted average limits specified above by more than 20 dB under any condition of modulation. For the emissions whose peak level is lower than the average limit, only the peak measurement is shown in the report.



Mode:a; Polarization:Horizontal; Modulation:b; bandwidth:20MHz; Channel:Low

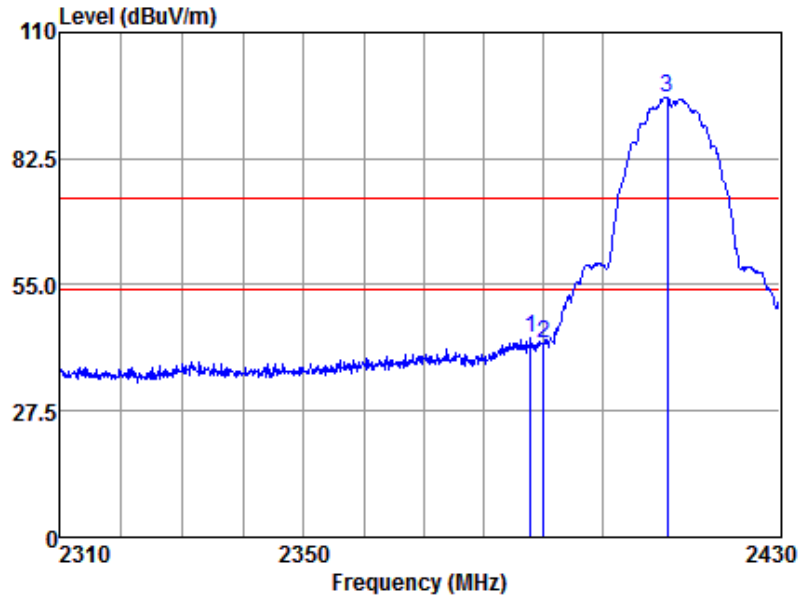

Antenna Polarity :HORIZONTAL

Freq	Read Level	Antenna Factor	Cable Loss	Preamp Factor	Emission Level	Limit Line	Over Limit	Remark
MHz	dBuv	dB/m	dB	dB	dBuv/m	dBuv/m	dB	
2387.91	48.27	26.03	6.47	37.36	43.41	74.00	-30.59	Peak
2390.00	46.90	26.03	6.47	37.36	42.04	74.00	-31.96	Peak
2411.00	100.67	26.06	6.50	37.35	95.88	74.00	21.88	Peak

Note:Emission Level=Read Level+Antenna Factor+Cable loss-Preamp Factor





Mode:a; Polarization:Vertical; Modulation:b; bandwidth:20MHz; Channel:Low

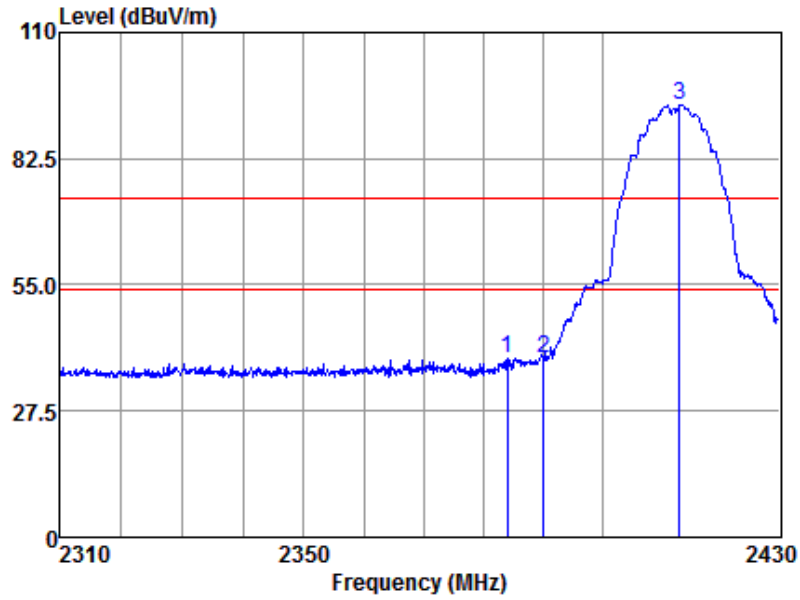

Antenna Polarity :VERTICAL

Freq	Read Level	Antenna Factor	Cable Loss	Preamp Factor	Emission Level	Limit Line	Over Limit	Remark
MHz	dBuv	dB/m	dB	dB	dBuv/m	dBuv/m	dB	
2383.92	43.76	26.03	6.47	37.36	38.90	74.00	-35.10	Peak
2390.00	43.95	26.03	6.47	37.36	39.09	74.00	-34.91	Peak
2413.08	99.05	26.08	6.50	37.36	94.27	74.00	20.27	Peak

Note:Emission Level=Read Level+Antenna Factor+Cable loss-Preamp Factor





Mode:a; Polarization:Horizontal; Modulation:b; bandwidth:20MHz; Channel:High

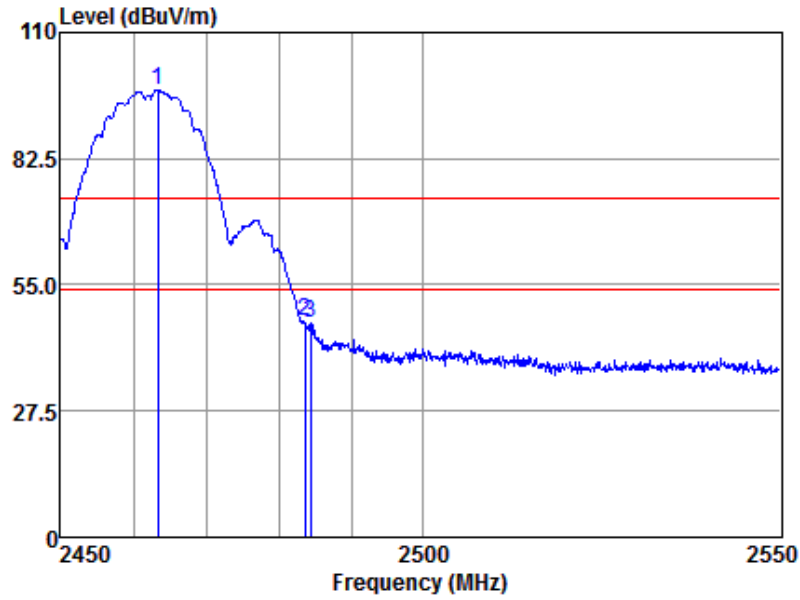

**Antenna Polarity :HORIZONTAL**

Freq	Read Level	Antenna Factor	Cable Loss	Preamp Factor	Emission Level	Limit Line	Over Limit	Remark
MHz	dBuv	dB/m	dB	dB	dBuv/m	dBuv/m	dB	
2463.27	102.24	26.15	6.68	37.46	97.61	74.00	23.61	Peak
2483.50	51.68	26.18	6.80	37.51	47.15	74.00	-26.85	Peak
2484.35	51.14	26.18	6.80	37.51	46.61	74.00	-27.39	Peak

Note:Emission Level=Read Level+Antenna Factor+Cable loss-Preamp Factor



Mode:a; Polarization:Vertical; Modulation:b; bandwidth:20MHz; Channel:High

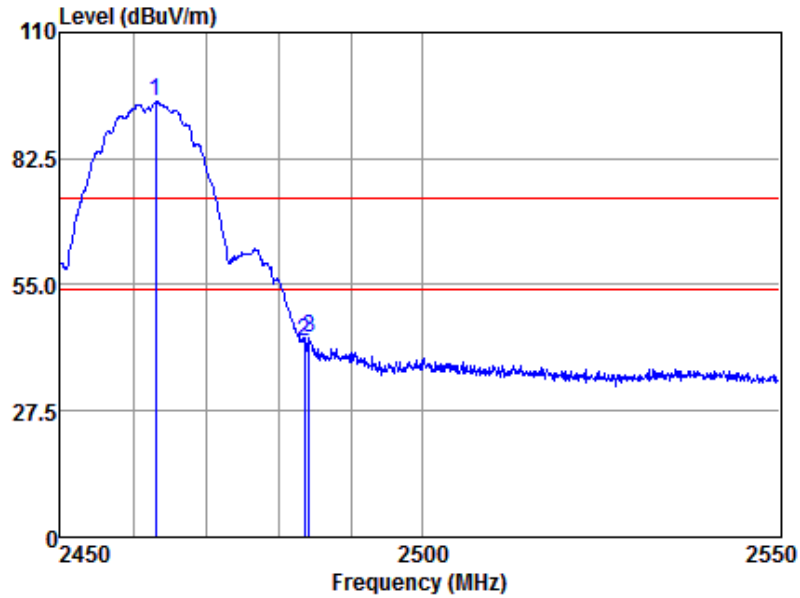

Antenna Polarity :VERTICAL

Freq	Read Level	Antenna Factor	Cable Loss	Preamp Factor	Emission Level	Limit Line	Over Limit	Remark
MHz	dBuv	dB/m	dB	dB	dBuv/m	dBuv/m	dB	
2463.07	99.46	26.15	6.68	37.46	94.83	74.00	20.83	Peak
2483.50	47.34	26.18	6.80	37.51	42.81	74.00	-31.19	Peak
2484.25	47.87	26.18	6.80	37.51	43.34	74.00	-30.66	Peak

Note:Emission Level=Read Level+Antenna Factor+Cable loss-Preamp Factor



Mode:a; Polarization:Horizontal; Modulation:g; bandwidth:20MHz; Channel:Low

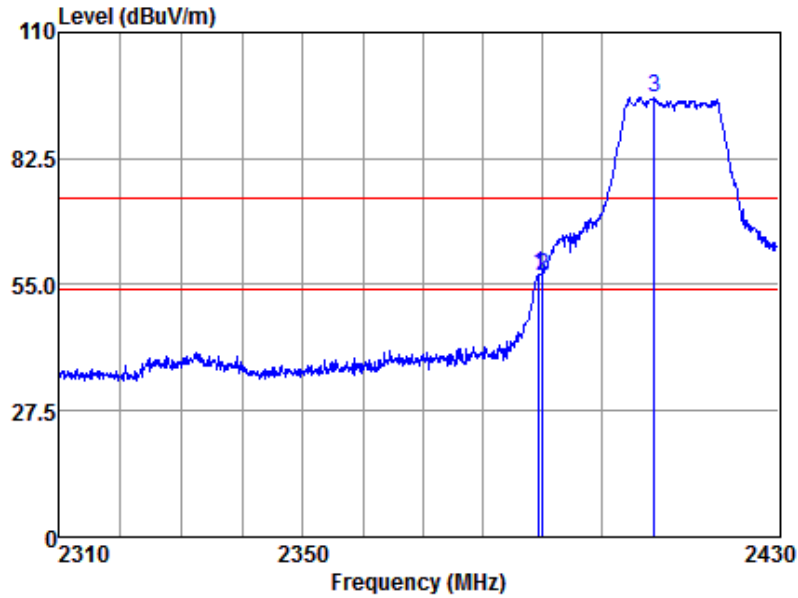

Antenna Polarity :HORIZONTAL

Freq	Read Level	Antenna Factor	Cable Loss	Preamp Factor	Emission Level	Limit Line	Over Limit	Remark
MHz	dBuv	dB/m	dB	dB	dBuv/m	dBuv/m	dB	
2389.36	62.23	26.03	6.47	37.36	57.37	74.00	-16.63	Peak
2390.00	61.69	26.03	6.47	37.36	56.83	74.00	-17.17	Peak
2408.93	100.74	26.06	6.50	37.35	95.95	74.00	21.95	Peak

Note:Emission Level=Read Level+Antenna Factor+Cable loss-Preamp Factor



Mode:a; Polarization:Horizontal; Modulation:g; bandwidth:20MHz; Channel:Low

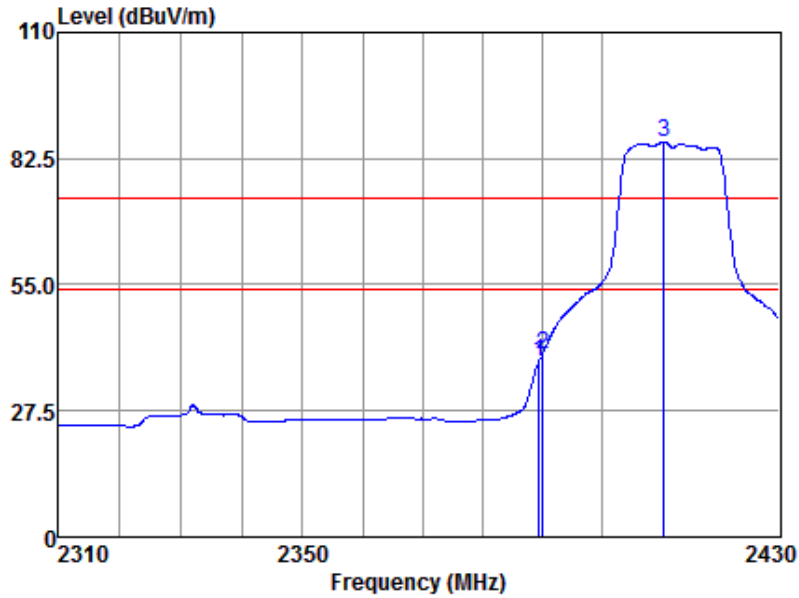

Antenna Polarity :HORIZONTAL

Freq	Read Level	Antenna Factor	Cable Loss	Preamp Factor	Emission Level	Limit Line	Over Limit	Remark
MHz	dBuv	dB/m	dB	dB	dBuv/m	dBuv/m	dB	
2389.36	42.89	26.03	6.47	37.36	38.03	54.00	-15.97	Average
2390.00	44.67	26.03	6.47	37.36	39.81	54.00	-14.19	Average
2410.51	90.78	26.06	6.50	37.35	85.99	54.00	31.99	Average

Note:Emission Level=Read Level+Antenna Factor+Cable loss-Preamp Factor



Mode:a; Polarization:Vertical; Modulation:g; bandwidth:20MHz; Channel:Low

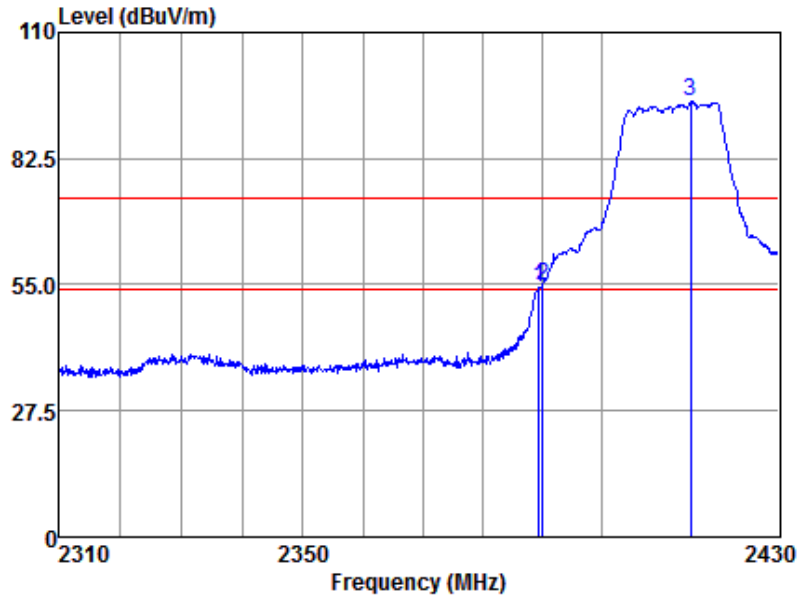

Antenna Polarity :VERTICAL

Freq	Read Level	Antenna Factor	Cable Loss	Preamp Factor	Emission Level	Limit Line	Over Limit	Remark
MHz	dBuv	dB/m	dB	dB	dBuv/m	dBuv/m	dB	
2389.48	59.16	26.03	6.47	37.36	54.30	74.00	-19.70	Peak
2390.00	59.64	26.03	6.47	37.36	54.78	74.00	-19.22	Peak
2415.16	99.68	26.08	6.50	37.36	94.90	74.00	20.90	Peak

Note:Emission Level=Read Level+Antenna Factor+Cable loss-Preamp Factor



Mode:a; Polarization:Vertical; Modulation:g; bandwidth:20MHz; Channel:Low

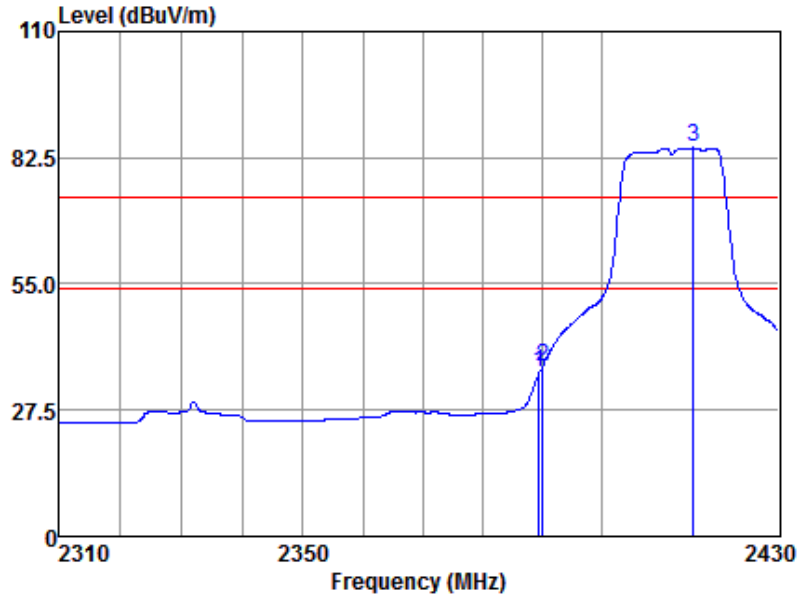

**Antenna Polarity :VERTICAL**

Freq	Read Level	Antenna Factor	Cable Loss	Preamp Factor	Emission Level	Limit Line	Over Limit	Remark
MHz	dBuv	dB/m	dB	dB	dBuv/m	dBuv/m	dB	
2389.48	40.49	26.03	6.47	37.36	35.63	54.00	-18.37	Average
2390.00	41.70	26.03	6.47	37.36	36.84	54.00	-17.16	Average
2415.52	89.36	26.08	6.56	37.36	84.64	54.00	30.64	Average

Note:Emission Level=Read Level+Antenna Factor+Cable loss-Preamp Factor



Mode:a; Polarization:Horizontal; Modulation:g; bandwidth:20MHz; Channel:High

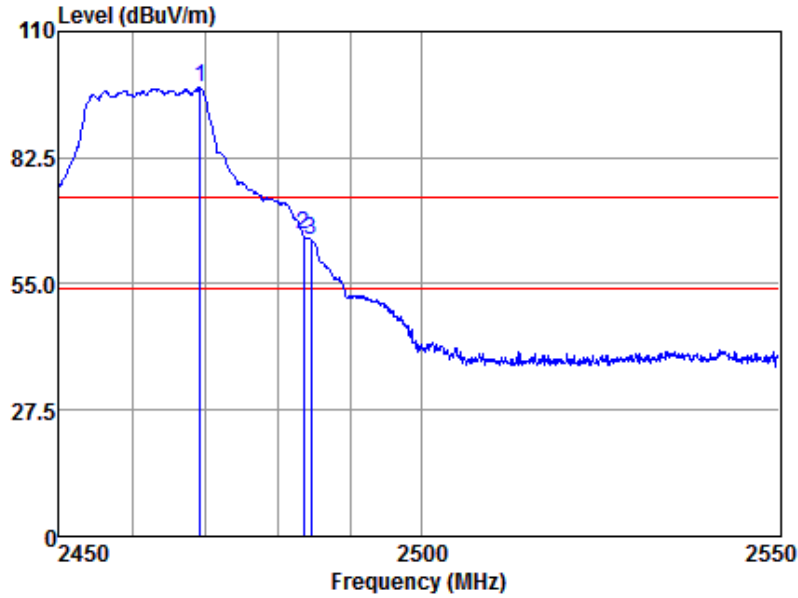

Antenna Polarity :HORIZONTAL

Freq	Read Level	Antenna Factor	Cable Loss	Preamp Factor	Emission Level	Limit Line	Over Limit	Remark
MHz	dBuv	dB/m	dB	dB	dBuv/m	dBuv/m	dB	
2469.39	102.33	26.16	6.74	37.48	97.75	74.00	23.75	Peak
2483.50	70.42	26.18	6.80	37.51	65.89	74.00	-8.11	Peak
2484.55	69.27	26.18	6.80	37.51	64.74	74.00	-9.26	Peak

Note:Emission Level=Read Level+Antenna Factor+Cable loss-Preamp Factor



Mode:a; Polarization:Horizontal; Modulation:g; bandwidth:20MHz; Channel:High

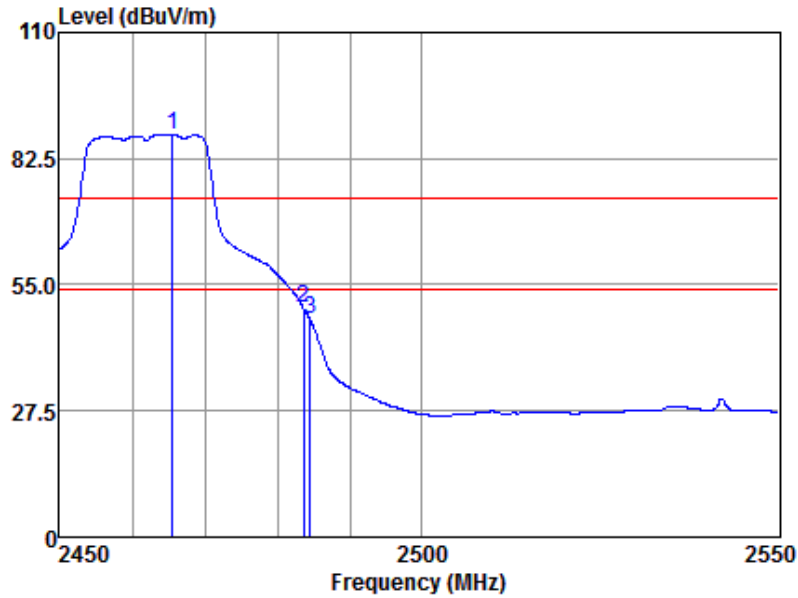

Antenna Polarity :HORIZONTAL

Freq	Read Level	Antenna Factor	Cable Loss	Preamp Factor	Emission Level	Limit Line	Over Limit	Remark
MHz	dBuv	dB/m	dB	dB	dBuv/m	dBuv/m	dB	
2465.44	92.20	26.15	6.74	37.46	87.63	54.00	33.63	Average
2483.50	54.51	26.18	6.80	37.51	49.98	54.00	-4.02	Average
2484.45	51.98	26.18	6.80	37.51	47.45	54.00	-6.55	Average

Note:Emission Level=Read Level+Antenna Factor+Cable loss-Preamp Factor





Mode:a; Polarization:Vertical; Modulation:g; bandwidth:20MHz; Channel:High

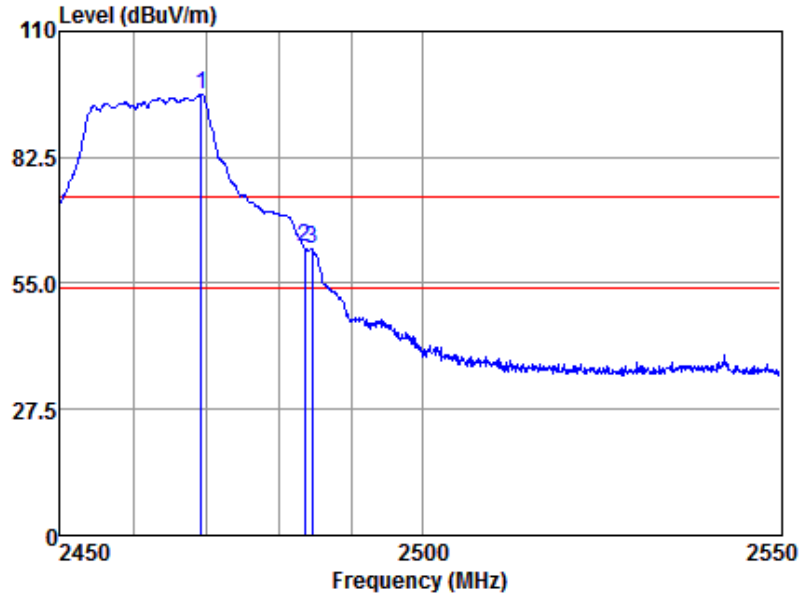

Antenna Polarity :VERTICAL

Freq	Read Level	Antenna Factor	Cable Loss	Preamp Factor	Emission Level	Limit Line	Over Limit	Remark
MHz	dBuv	dB/m	dB	dB	dBuv/m	dBuv/m	dB	
2469.29	100.90	26.16	6.74	37.48	96.32	74.00	22.32	Peak
2483.50	67.40	26.18	6.80	37.51	62.87	74.00	-11.13	Peak
2484.55	67.08	26.18	6.80	37.51	62.55	74.00	-11.45	Peak

Note:Emission Level=Read Level+Antenna Factor+Cable loss-Preamp Factor



Mode:a; Polarization:Vertical; Modulation:g; bandwidth:20MHz; Channel:High

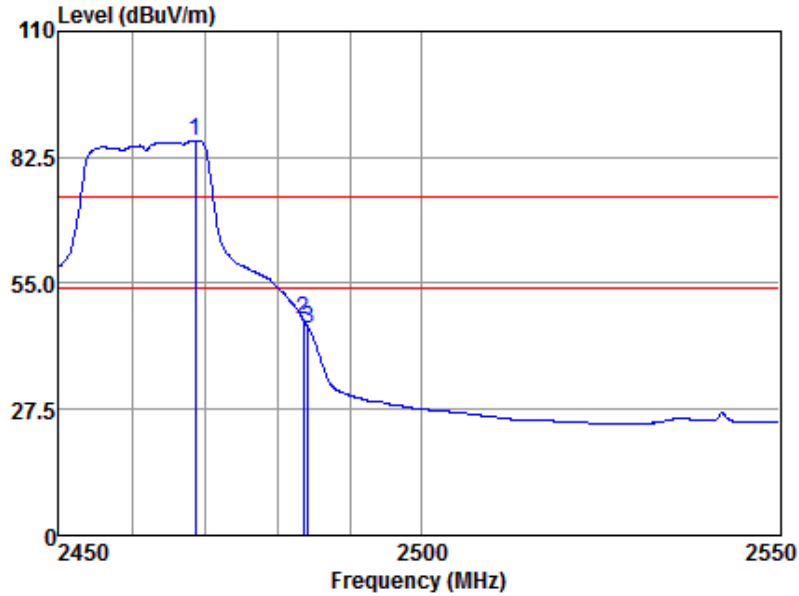

Antenna Polarity :VERTICAL

Freq	Read Level	Antenna Factor	Cable Loss	Preamp Factor	Emission Level	Limit Line	Over Limit	Remark
MHz	dBuv	dB/m	dB	dB	dBuv/m	dBuv/m	dB	
2468.69	90.76	26.16	6.74	37.48	86.18	54.00	32.18	Average
2483.50	51.64	26.18	6.80	37.51	47.11	54.00	-6.89	Average
2484.25	49.75	26.18	6.80	37.51	45.22	54.00	-8.78	Average

Note:Emission Level=Read Level+Antenna Factor+Cable loss-Preamp Factor



Mode:a; Polarization:Horizontal; Modulation:n; bandwidth:20MHz; Channel:Low

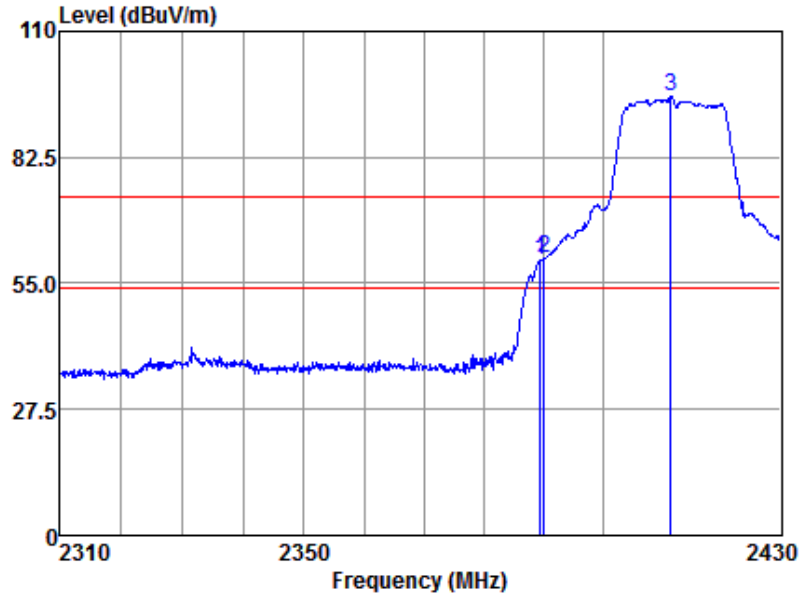

Antenna Polarity :HORIZONTAL

Freq	Read Level	Antenna Factor	Cable Loss	Preamp Factor	Emission Level	Limit Line	Over Limit	Remark
MHz	dBuv	dB/m	dB	dB	dBuv/m	dBuv/m	dB	
2389.48	64.96	26.03	6.47	37.36	60.10	74.00	-13.90	Peak
2390.00	65.16	26.03	6.47	37.36	60.30	74.00	-13.70	Peak
2411.49	100.54	26.08	6.50	37.36	95.76	74.00	21.76	Peak

Note:Emission Level=Read Level+Antenna Factor+Cable loss-Preamp Factor



Mode:a; Polarization:Horizontal; Modulation:n; bandwidth:20MHz; Channel:Low

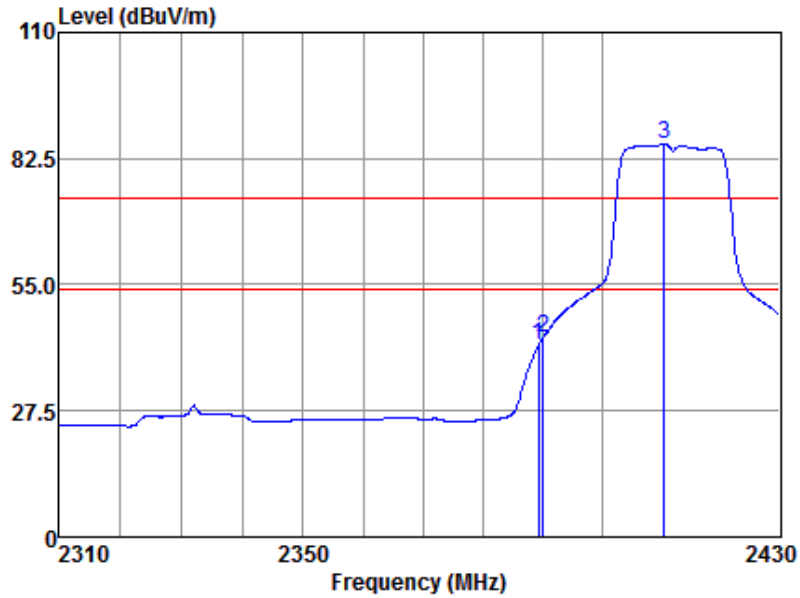

Antenna Polarity :HORIZONTAL

Freq	Read Level	Antenna Factor	Cable Loss	Preamp Factor	Emission Level	Limit Line	Over Limit	Remark
MHz	dBuv	dB/m	dB	dB	dBuv/m	dBuv/m	dB	
2389.24	46.58	26.03	6.47	37.36	41.72	54.00	-12.28	Average
2390.00	48.11	26.03	6.47	37.36	43.25	54.00	-10.75	Average
2410.51	90.34	26.06	6.50	37.35	85.55	54.00	31.55	Average

Note:Emission Level=Read Level+Antenna Factor+Cable loss-Preamp Factor



Mode:a; Polarization:Vertical; Modulation:n; bandwidth:20MHz; Channel:Low

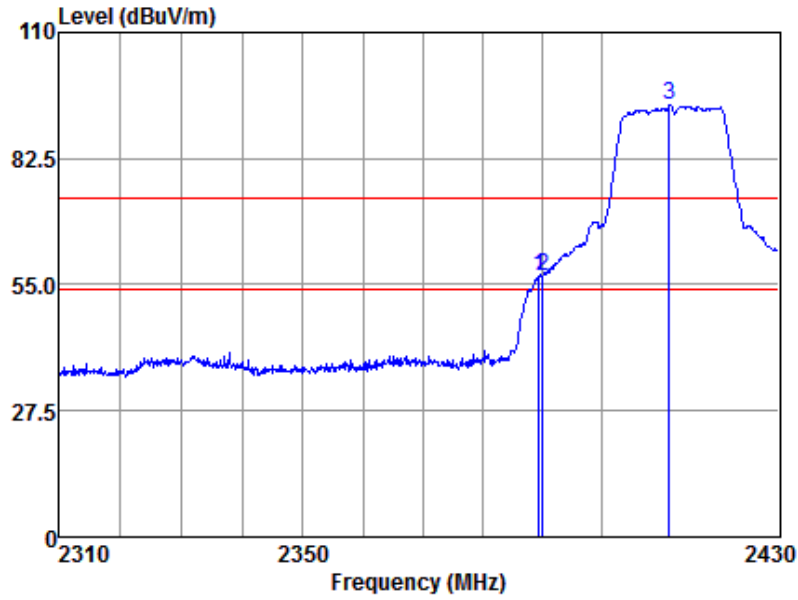

Antenna Polarity :VERTICAL

Freq	Read Level	Antenna Factor	Cable Loss	Preamp Factor	Emission Level	Limit Line	Over Limit	Remark
MHz	dBuv	dB/m	dB	dB	dBuv/m	dBuv/m	dB	
2389.36	61.55	26.03	6.47	37.36	56.69	74.00	-17.31	Peak
2390.00	61.81	26.03	6.47	37.36	56.95	74.00	-17.05	Peak
2411.49	99.02	26.08	6.50	37.36	94.24	74.00	20.24	Peak

Note:Emission Level=Read Level+Antenna Factor+Cable loss-Preamp Factor



Mode:a; Polarization:Vertical; Modulation:n; bandwidth:20MHz; Channel:Low

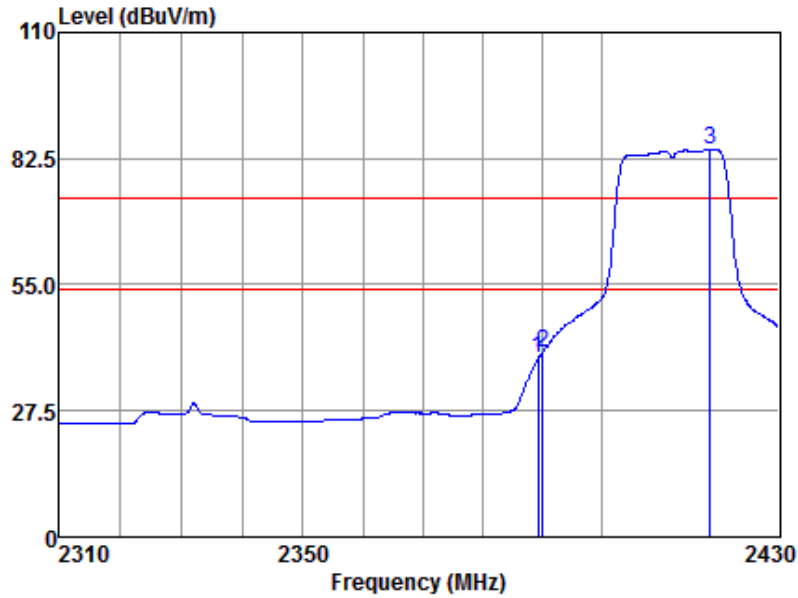

Antenna Polarity :VERTICAL

Freq	Read Level	Antenna Factor	Cable Loss	Preamp Factor	Emission Level	Limit Line	Over Limit	Remark
MHz	dBuv	dB/m	dB	dB	dBuv/m	dBuv/m	dB	
2389.24	43.66	26.03	6.47	37.36	38.80	54.00	-15.20	Average
2390.00	45.06	26.03	6.47	37.36	40.20	54.00	-13.80	Average
2418.46	89.09	26.09	6.56	37.38	84.36	54.00	30.36	Average

Note:Emission Level=Read Level+Antenna Factor+Cable loss-Preamp Factor



Mode:a; Polarization:Horizontal; Modulation:n; bandwidth:20MHz; Channel:High

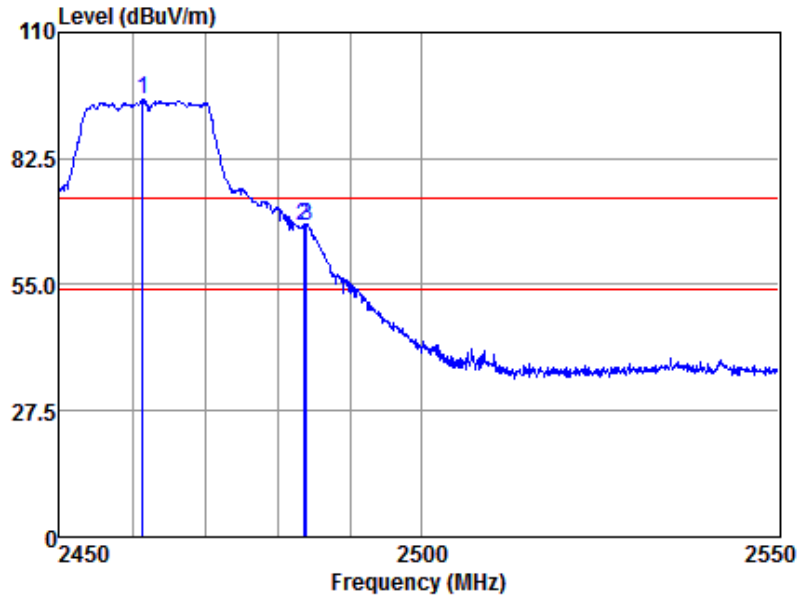

Antenna Polarity :HORIZONTAL

Freq	Read Level	Antenna Factor	Cable Loss	Preamp Factor	Emission Level	Limit Line	Over Limit	Remark
MHz	dBuv	dB/m	dB	dB	dBuv/m	dBuv/m	dB	
2461.40	100.01	26.15	6.68	37.46	95.38	74.00	21.38	Peak
2483.50	72.39	26.18	6.80	37.51	67.86	74.00	-6.14	Peak
2483.95	72.49	26.18	6.80	37.51	67.96	74.00	-6.04	Peak

Note:Emission Level=Read Level+Antenna Factor+Cable loss-Preamp Factor



Mode:a; Polarization:Horizontal; Modulation:n; bandwidth:20MHz; Channel:High

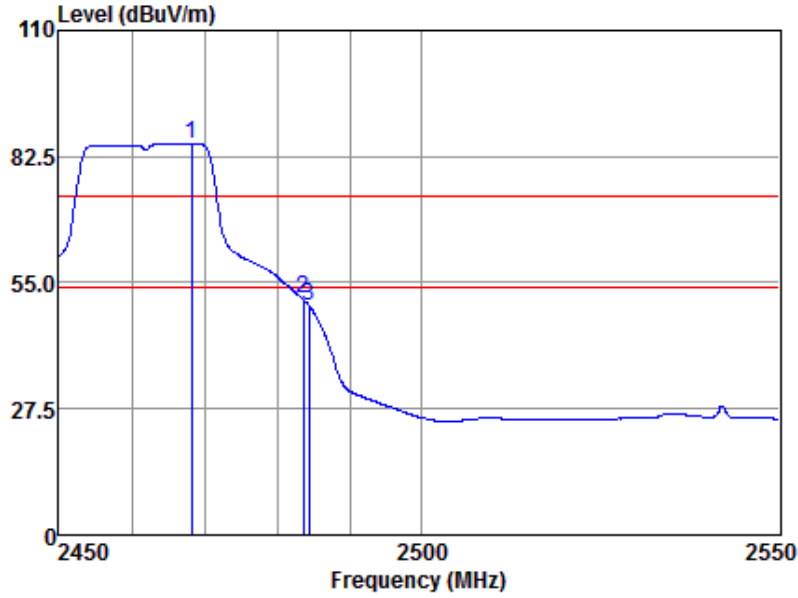

**Antenna Polarity :HORIZONTAL**

Freq	Read Level	Antenna Factor	Cable Loss	Preamp Factor	Emission Level	Limit Line	Over Limit	Remark
MHz	dBuv	dB/m	dB	dB	dBuv/m	dBuv/m	dB	
2468.20	89.91	26.16	6.74	37.48	85.33	54.00	31.33	Average
2483.50	55.97	26.18	6.80	37.51	51.44	54.00	-2.56	Average
2484.35	54.60	26.18	6.80	37.51	50.07	54.00	-3.93	Average

Note:Emission Level=Read Level+Antenna Factor+Cable loss-Preamp Factor





Mode:a; Polarization:Vertical; Modulation:n; bandwidth:20MHz; Channel:High

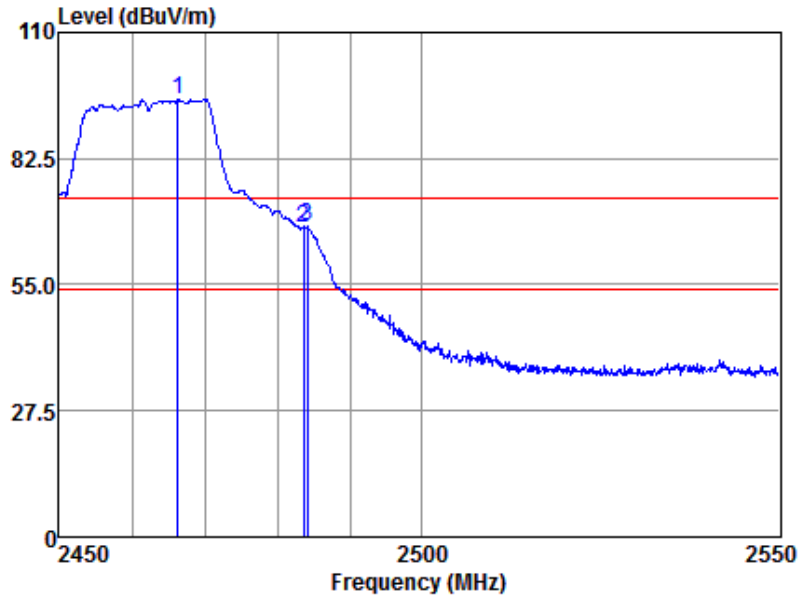

Antenna Polarity :VERTICAL

Freq	Read Level	Antenna Factor	Cable Loss	Preamp Factor	Emission Level	Limit Line	Over Limit	Remark
MHz	dBuv	dB/m	dB	dB	dBuv/m	dBuv/m	dB	
2466.32	100.03	26.15	6.74	37.46	95.46	74.00	21.46	Peak
2483.50	71.94	26.18	6.80	37.51	67.41	74.00	-6.59	Peak
2484.05	72.20	26.18	6.80	37.51	67.67	74.00	-6.33	Peak

Note:Emission Level=Read Level+Antenna Factor+Cable loss-Preamp Factor



Mode:a; Polarization:Vertical; Modulation:n; bandwidth:20MHz; Channel:High

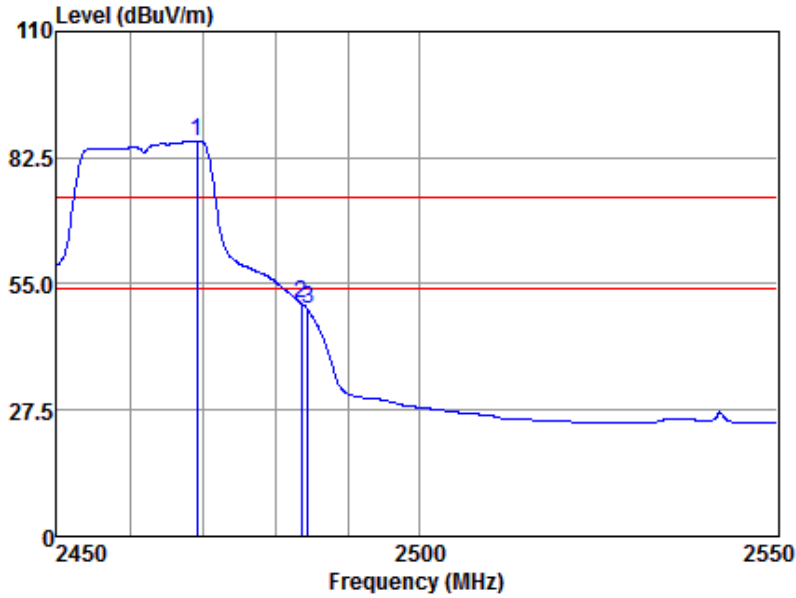

Antenna Polarity :VERTICAL

Freq	Read Level	Antenna Factor	Cable Loss	Preamp Factor	Emission Level	Limit Line	Over Limit	Remark
MHz	dBuv	dB/m	dB	dB	dBuv/m	dBuv/m	dB	
2469.19	90.75	26.16	6.74	37.48	86.17	54.00	32.17	Average
2483.50	55.44	26.18	6.80	37.51	50.91	54.00	-3.09	Average
2484.45	53.94	26.18	6.80	37.51	49.41	54.00	-4.59	Average

Note:Emission Level=Read Level+Antenna Factor+Cable loss-Preamp Factor



Mode:a; Polarization:Horizontal; Modulation:n; bandwidth:40MHz; Channel:Low

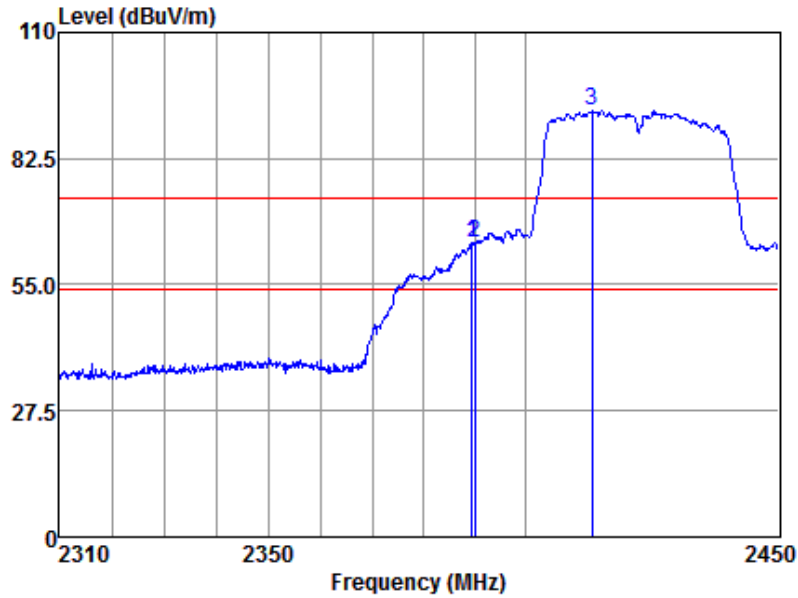

Antenna Polarity :HORIZONTAL

Freq	Read Level	Antenna Factor	Cable Loss	Preamp Factor	Emission Level	Limit Line	Over Limit	Remark
MHz	dBuv	dB/m	dB	dB	dBuv/m	dBuv/m	dB	
2389.35	68.86	26.03	6.47	37.36	64.00	74.00	-10.00	Peak
2390.00	68.99	26.03	6.47	37.36	64.13	74.00	-9.87	Peak
2413.09	97.79	26.08	6.50	37.36	93.01	74.00	19.01	Peak

Note:Emission Level=Read Level+Antenna Factor+Cable loss-Preamp Factor



Mode:a; Polarization:Horizontal; Modulation:n; bandwidth:40MHz; Channel:Low

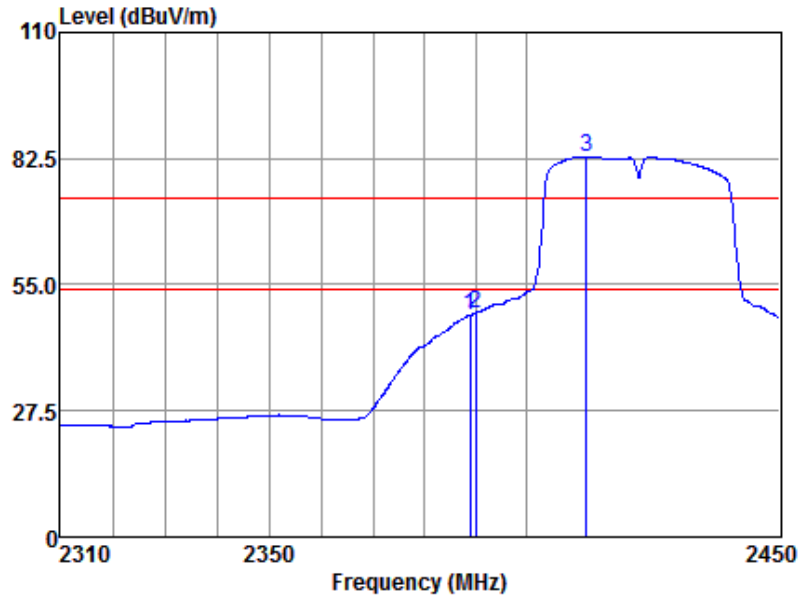

Antenna Polarity :HORIZONTAL

Freq	Read Level	Antenna Factor	Cable Loss	Preamp Factor	Emission Level	Limit Line	Over Limit	Remark
MHz	dBuv	dB/m	dB	dB	dBuv/m	dBuv/m	dB	
2388.79	53.24	26.03	6.47	37.36	48.38	54.00	-5.62	Average
2390.00	53.72	26.03	6.47	37.36	48.86	54.00	-5.14	Average
2411.81	87.60	26.08	6.50	37.36	82.82	54.00	28.82	Average

Note:Emission Level=Read Level+Antenna Factor+Cable loss-Preamp Factor



Mode:a; Polarization:Vertical; Modulation:n; bandwidth:40MHz; Channel:Low

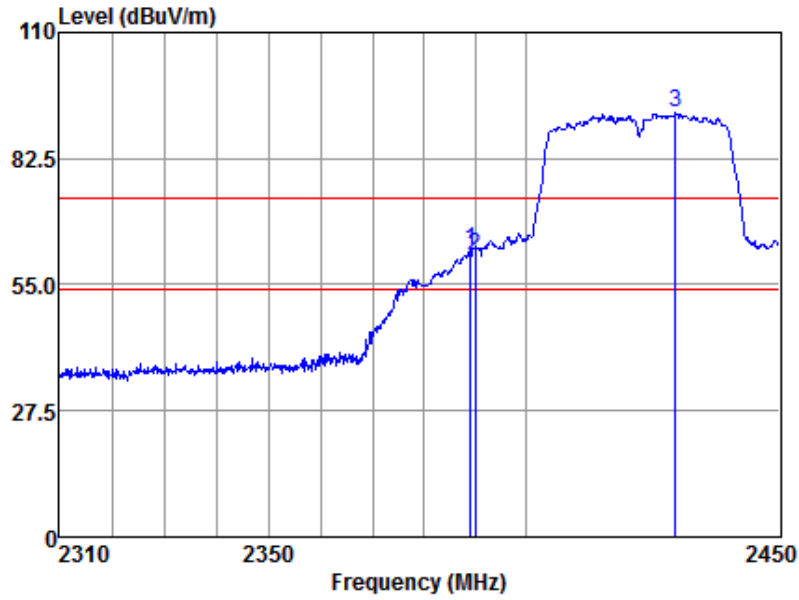

Antenna Polarity :VERTICAL

Freq	Read Level	Antenna Factor	Cable Loss	Preamp Factor	Emission Level	Limit Line	Over Limit	Remark
MHz	dBuv	dB/m	dB	dB	dBuv/m	dBuv/m	dB	
2389.07	67.32	26.03	6.47	37.36	62.46	74.00	-11.54	Peak
2390.00	65.99	26.03	6.47	37.36	61.13	74.00	-12.87	Peak
2429.47	97.14	26.10	6.56	37.39	92.41	74.00	18.41	Peak

Note:Emission Level=Read Level+Antenna Factor+Cable loss-Preamp Factor



Mode:a; Polarization:Vertical; Modulation:n; bandwidth:40MHz; Channel:Low

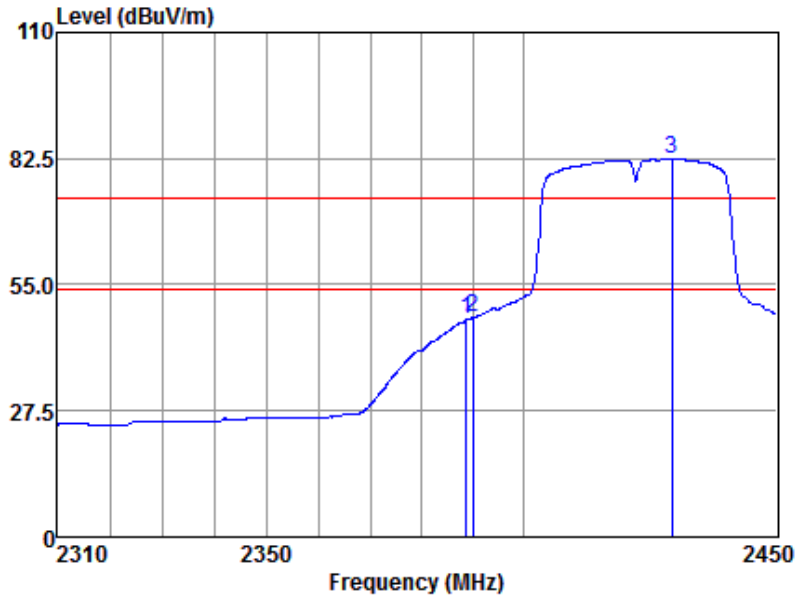

**Antenna Polarity :VERTICAL**

Freq	Read Level	Antenna Factor	Cable Loss	Preamp Factor	Emission Level	Limit Line	Over Limit	Remark
MHz	dBuv	dB/m	dB	dB	dBuv/m	dBuv/m	dB	
2388.65	52.17	26.03	6.47	37.36	47.31	54.00	-6.69	Average
2390.00	52.66	26.03	6.47	37.36	47.80	54.00	-6.20	Average
2429.19	87.15	26.10	6.56	37.39	82.42	54.00	28.42	Average

Note:Emission Level=Read Level+Antenna Factor+Cable loss-Preamp Factor



Mode:a; Polarization:Horizontal; Modulation:n; bandwidth:40MHz; Channel:High

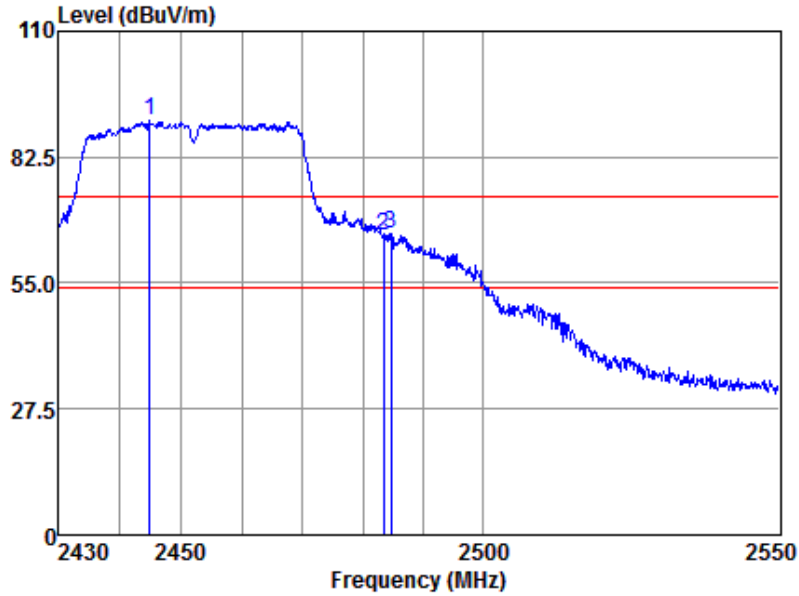

Antenna Polarity :HORIZONTAL

Freq	Read Level	Antenna Factor	Cable Loss	Preamp Factor	Emission Level	Limit Line	Over Limit	Remark
MHz	dBuv	dB/m	dB	dB	dBuv/m	dBuv/m	dB	
2444.80	95.22	26.12	6.62	37.42	90.54	74.00	16.54	Peak
2483.50	69.82	26.18	6.80	37.51	65.29	74.00	-8.71	Peak
2484.72	70.19	26.18	6.80	37.51	65.66	74.00	-8.34	Peak

Note:Emission Level=Read Level+Antenna Factor+Cable loss-Preamp Factor



Mode:a; Polarization:Horizontal; Modulation:n; bandwidth:40MHz; Channel:High

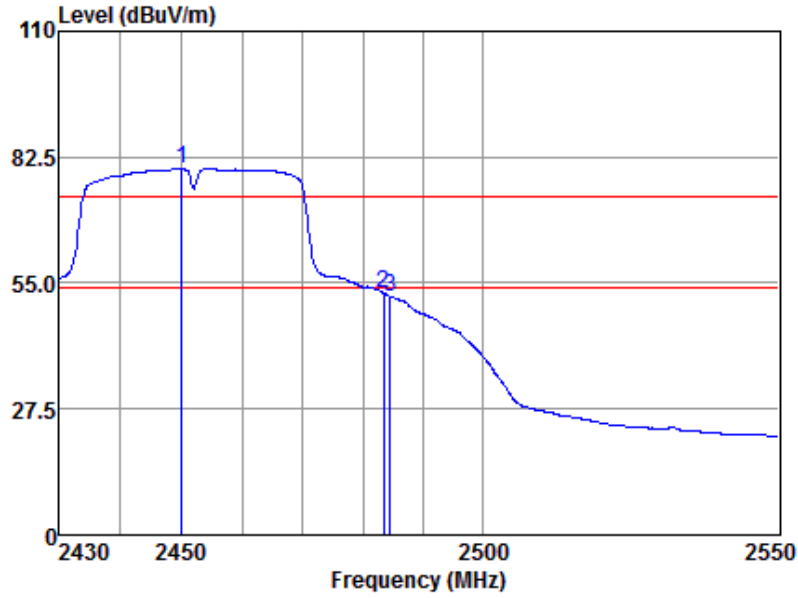

**Antenna Polarity :HORIZONTAL**

Freq	Read Level	Antenna Factor	Cable Loss	Preamp Factor	Emission Level	Limit Line	Over Limit	Remark
MHz	dBuv	dB/m	dB	dB	dBuv/m	dBuv/m	dB	
2450.11	84.53	26.13	6.68	37.43	79.91	54.00	25.91	Average
2483.50	57.29	26.18	6.80	37.51	52.76	54.00	-1.24	Average
2484.60	56.43	26.18	6.80	37.51	51.90	54.00	-2.10	Average

Note:Emission Level=Read Level+Antenna Factor+Cable loss-Preamp Factor





Mode:a; Polarization:Vertical; Modulation:n; bandwidth:40MHz; Channel:High

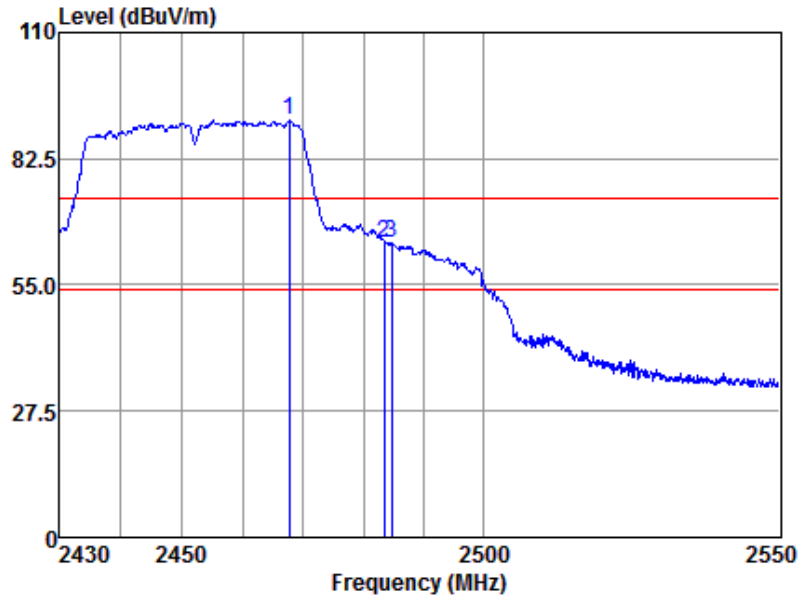

Antenna Polarity :VERTICAL

Freq	Read Level	Antenna Factor	Cable Loss	Preamp Factor	Emission Level	Limit Line	Over Limit	Remark
MHz	dBuv	dB/m	dB	dB	dBuv/m	dBuv/m	dB	
2467.77	95.45	26.16	6.74	37.48	90.87	74.00	16.87	Peak
2483.50	68.60	26.18	6.80	37.51	64.07	74.00	-9.93	Peak
2484.72	68.83	26.18	6.80	37.51	64.30	74.00	-9.70	Peak

Note:Emission Level=Read Level+Antenna Factor+Cable loss-Preamp Factor



Mode:a; Polarization:Vertical; Modulation:n; bandwidth:40MHz; Channel:High

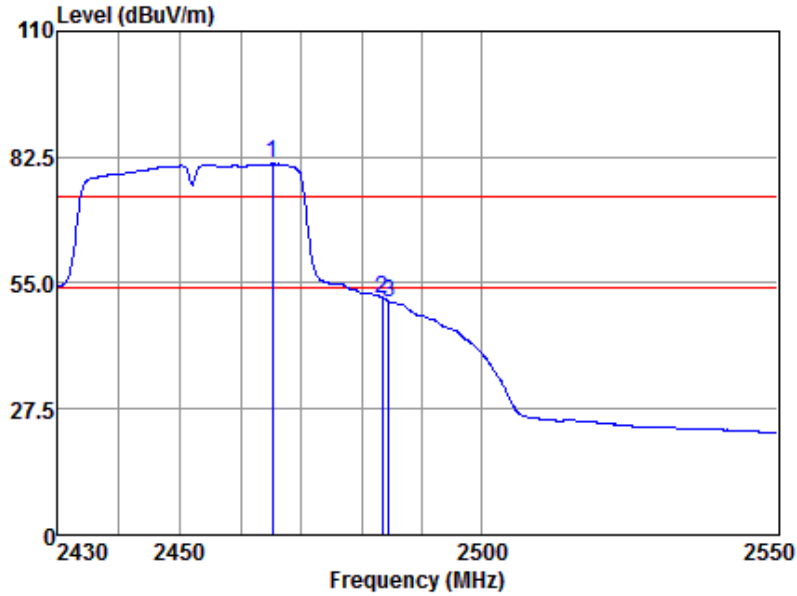

Antenna Polarity :VERTICAL

Freq	Read Level	Antenna Factor	Cable Loss	Preamp Factor	Emission Level	Limit Line	Over Limit	Remark
MHz	dBuv	dB/m	dB	dB	dBuv/m	dBuv/m	dB	
2465.28	85.57	26.15	6.74	37.46	81.00	54.00	27.00	Average
2483.50	56.21	26.18	6.80	37.51	51.68	54.00	-2.32	Average
2484.60	55.45	26.18	6.80	37.51	50.92	54.00	-3.08	Average

Note:Emission Level=Read Level+Antenna Factor+Cable loss-Preamp Factor



## 7.8 Radiated Spurious Emissions

Test Requirement 47 CFR Part 15, Subpart C 15.209 & 15.247(d)

Test Method: ANSI C63.10 (2013) Section 6.4,6.5,6.6

Limit:

Frequency(MHz)	Field strength(microvolts/meter)	Measurement distance(meters)
0.009-0.490	2400/F(kHz)	300
0.490-1.705	24000/F(kHz)	30
1.705-30.0	30	30
30-88	100	3
88-216	150	3
216-960	200	3
Above 960	500	3

Remark: The emission limits shown in the above table are based on measurements employing a CISPR quasi-peak detector except for the frequency bands 9-90kHz, 110-490kHz and above 1000 MHz. Radiated emission limits in these three bands are based on measurements employing an average detector, the peak field strength of any emission shall not exceed the maximum permitted average limits specified above by more than 20 dB under any condition of modulation.

### 7.8.1 E.U.T. Operation

Operating Environment:

Temperature: 20 °C Humidity: 50 % RH Atmospheric Pressure: 1010 mbar

Test mode a: Charge + TX mode\_Keep the EUT in charging and continuously transmitting mode with all modulation types. All data rates for each modulation type have been tested and found the data rate @ 1Mbps is the worst case of IEEE 802.11b; data rate @ 6Mbps is the worst case of IEEE 802.11g; data rate @ 6.5Mbps is the worst case of IEEE 802.11n(HT20); data rate @ 13.5Mbps is the worst case of IEEE 802.11n(HT40). Only the data of worst case is recorded in the report.

### 7.8.2 Test Setup Diagram

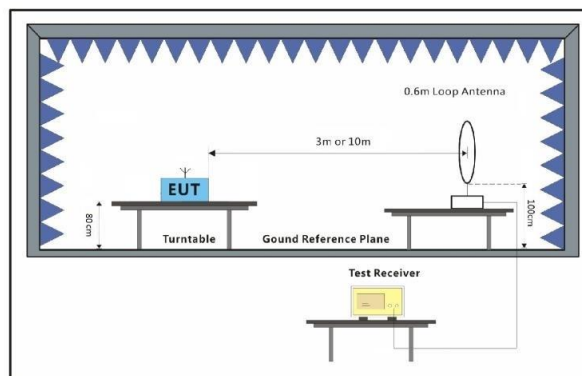
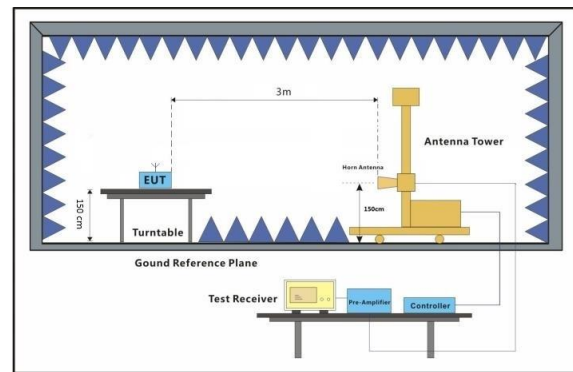
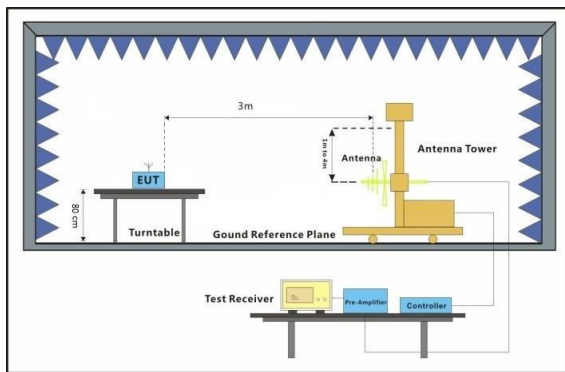



### 7.8.3 Measurement Procedure and Data

- a. For below 1GHz, the EUT was placed on the top of a rotating table 0.8 meters above the ground at a 3 or 10 meter semi-anechoic chamber. The table was rotated 360 degrees to determine the position of the highest radiation.
- b. For above 1GHz, the EUT was placed on the top of a rotating table 1.5 meters above the ground at a 3 meter fully-anechoic chamber. The table was rotated 360 degrees to determine the position of the highest radiation.
- c. The EUT was set 3 or 10 meters away from the interference-receiving antenna, which was mounted on the top of a variable-height antenna tower.
- d. The antenna height is varied from one meter to four meters above the ground to determine the maximum value of the field strength. Both horizontal and vertical polarizations of the antenna are set to make the measurement.
- e. For each suspected emission, the EUT was arranged to its worst case and then the antenna was tuned to heights from 1 meter to 4 meters (for the test frequency of below 30MHz, the antenna was tuned to heights 1 meter) and the rotatable table was turned from 0 degrees to 360 degrees to find the maximum reading.
- f. The test-receiver system was set to Peak Detect Function and Specified Bandwidth with Maximum Hold Mode.
- g. If the emission level of the EUT in peak mode was 10dB lower than the limit specified, then testing could be stopped and the peak values of the EUT would be reported. Otherwise the emissions that did not have 10dB margin would be re-tested one by one using peak, quasi-peak or average method as specified and then reported in a data sheet.
- h. Test the EUT in the lowest channel, the middle channel, the Highest channel.
- i. The radiation measurements are performed in X, Y, Z axis positioning for Transmitting mode, and found the X axis positioning which it is the worst case.
- j. Repeat above procedures until all frequencies measured was complete.

#### Remark:

- 1) For emission below 1GHz, through pre-scan found the worst case is the lowest channel. Only the worst case is recorded in the report.
- 2) The field strength is calculated by adding the Antenna Factor, Cable Factor & Preamplifier. The basic equation with a sample calculation is as follows:  
Final Test Level = Receiver Reading + Antenna Factor + Cable Factor – Preamplifier Factor
- 3) Scan from 9kHz to 25GHz, the disturbance above 18GHz and below 30MHz was very low. The points marked on above plots are the highest emissions could be found when testing, so only above points had been displayed. The amplitude of spurious emissions from the radiator which are attenuated more than 20dB below the limit need not be reported.
- 4) For frequencies above 1GHz, the field strength limits are based on average limits. However, the peak field strength of any emission shall not exceed the maximum permitted average limits specified above by more than 20 dB under any condition of modulation. For the emissions whose peak level is lower than the average limit, only the peak measurement is shown



Mode:a; Polarization:Horizontal; Modulation:b; bandwidth:20MHz; Channel:Low

Frequency	RX_R	Factor	Emission	Limit	Over Limit	Detector
MHz	dBuV	dB	dBuV/m	dBuV/m	dB	
4824	43.75	6.40	50.15	54	-3.85	peak
7236	36.93	10.76	47.69	54	-6.31	peak
9648	36.77	14.37	51.14	54	-2.86	peak

Mode:a; Polarization:Vertical; Modulation:b; bandwidth:20MHz; Channel:Low

Frequency	RX_R	Factor	Emission	Limit	Over Limit	Detector
MHz	dBuV	dB	dBuV/m	dBuV/m	dB	
4824	42.21	6.40	48.61	54	-5.39	peak
7236	37.17	10.76	47.93	54	-6.07	peak
9648	33.29	14.37	47.66	54	-6.34	peak

Mode:a; Polarization:Horizontal; Modulation:b; bandwidth:20MHz; Channel:middle

Frequency	RX_R	Factor	Emission	Limit	Over Limit	Detector
MHz	dBuV	dB	dBuV/m	dBuV/m	dB	
4874	42.15	6.92	49.07	54	-4.93	peak
7311	38.34	11.08	49.42	54	-4.58	peak
9748	31.59	14.36	45.95	54	-8.05	peak

Mode:a; Polarization:Vertical; Modulation:b; bandwidth:20MHz; Channel:middle

Frequency	RX_R	Factor	Emission	Limit	Over Limit	Detector
MHz	dBuV	dB	dBuV/m	dBuV/m	dB	
4874	40.36	6.92	47.28	54	-6.72	peak
7311	35.86	11.08	46.94	54	-7.06	peak
9748	32.23	14.36	46.59	54	-7.41	peak

Mode:a; Polarization:Horizontal; Modulation:b; bandwidth:20MHz; Channel:High

Frequency	RX_R	Factor	Emission	Limit	Over Limit	Detector
MHz	dBuV	dB	dBuV/m	dBuV/m	dB	
4924	42.16	7.31	49.47	54	-4.53	peak
7386	34.52	11.41	45.93	54	-8.07	peak
9848	32.13	14.38	46.51	54	-7.49	peak

Mode:a; Polarization:Vertical; Modulation:b; bandwidth:20MHz; Channel:High

Frequency	RX_R	Factor	Emission	Limit	Over Limit	Detector
MHz	dBuV	dB	dBuV/m	dBuV/m	dB	
4924	39.66	7.31	46.97	54	-7.03	peak
7386	38.30	11.41	49.71	54	-4.29	peak
9848	36.05	14.38	50.43	54	-3.57	peak



Mode:a; Polarization:Horizontal; Modulation:g; bandwidth:20MHz; Channel:Low

Frequency	RX_R	Factor	Emission	Limit	Over Limit	Detector
MHz	dBuV	dB	dBuV/m	dBuV/m	dB	
4824	39.81	6.40	46.21	54	-7.79	peak
7236	38.38	10.76	49.14	54	-4.86	peak
9648	31.75	14.37	46.12	54	-7.88	peak

Mode:a; Polarization:Vertical; Modulation:g; bandwidth:20MHz; Channel:Low

Frequency	RX_R	Factor	Emission	Limit	Over Limit	Detector
MHz	dBuV	dB	dBuV/m	dBuV/m	dB	
4824	38.29	6.40	44.69	54	-9.31	peak
7236	34.74	10.76	45.50	54	-8.50	peak
9648	36.60	14.37	50.97	54	-3.03	peak

Mode:a; Polarization:Horizontal; Modulation:g; bandwidth:20MHz; Channel:middle

Frequency	RX_R	Factor	Emission	Limit	Over Limit	Detector
MHz	dBuV	dB	dBuV/m	dBuV/m	dB	
4874	43.55	6.92	50.47	54	-3.53	peak
7311	34.36	11.08	45.44	54	-8.56	peak
9748	32.78	14.36	47.14	54	-6.86	peak

Mode:a; Polarization:Vertical; Modulation:g; bandwidth:20MHz; Channel:middle

Frequency	RX_R	Factor	Emission	Limit	Over Limit	Detector
MHz	dBuV	dB	dBuV/m	dBuV/m	dB	
4874	43.25	6.92	50.17	54	-3.83	peak
7311	38.91	11.08	49.99	54	-4.01	peak
9748	34.46	14.36	48.82	54	-5.18	peak

Mode:a; Polarization:Horizontal; Modulation:g; bandwidth:20MHz; Channel:High

Frequency	RX_R	Factor	Emission	Limit	Over Limit	Detector
MHz	dBuV	dB	dBuV/m	dBuV/m	dB	
4924	41.00	7.31	48.31	54	-5.69	peak
7386	35.73	11.41	47.14	54	-6.86	peak
9848	35.49	14.38	49.87	54	-4.13	peak

Mode:a; Polarization:Vertical; Modulation:g; bandwidth:20MHz; Channel:High

Frequency	RX_R	Factor	Emission	Limit	Over Limit	Detector
MHz	dBuV	dB	dBuV/m	dBuV/m	dB	
4924	38.14	7.31	45.45	54	-8.55	peak
7386	37.81	11.41	49.22	54	-4.78	peak
9848	35.03	14.38	49.41	54	-4.59	peak



Mode:a; Polarization:Horizontal; Modulation:n; bandwidth:20MHz; Channel:Low

Frequency	RX_R	Factor	Emission	Limit	Over Limit	Detector
MHz	dBuV	dB	dBuV/m	dBuV/m	dB	
4824	38.83	6.40	45.23	54	-8.77	peak
7236	34.82	10.76	45.58	54	-8.42	peak
9648	34.89	14.37	49.26	54	-4.74	peak

Mode:a; Polarization:Vertical; Modulation:n; bandwidth:20MHz; Channel:Low

Frequency	RX_R	Factor	Emission	Limit	Over Limit	Detector
MHz	dBuV	dB	dBuV/m	dBuV/m	dB	
4824	41.81	6.40	48.21	54	-5.79	peak
7236	35.90	10.76	46.66	54	-7.34	peak
9648	37.87	14.37	52.24	54	-1.76	peak

Mode:a; Polarization:Horizontal; Modulation:n; bandwidth:20MHz; Channel:middle

Frequency	RX_R	Factor	Emission	Limit	Over Limit	Detector
MHz	dBuV	dB	dBuV/m	dBuV/m	dB	
4874	41.02	6.92	47.94	54	-6.06	peak
7311	35.26	11.08	46.34	54	-7.66	peak
9748	35.58	14.36	49.94	54	-4.06	peak

Mode:a; Polarization:Vertical; Modulation:n; bandwidth:20MHz; Channel:middle

Frequency	RX_R	Factor	Emission	Limit	Over Limit	Detector
MHz	dBuV	dB	dBuV/m	dBuV/m	dB	
4874	43.41	6.92	50.33	54	-3.67	peak
7311	37.32	11.08	48.40	54	-5.60	peak
9748	33.38	14.36	47.74	54	-6.26	peak

Mode:a; Polarization:Horizontal; Modulation:n; bandwidth:20MHz; Channel:High

Frequency	RX_R	Factor	Emission	Limit	Over Limit	Detector
MHz	dBuV	dB	dBuV/m	dBuV/m	dB	
4924	41.71	7.31	49.02	54	-4.98	peak
7386	35.07	11.41	46.48	54	-7.52	peak
9848	35.23	14.38	49.61	54	-4.39	peak

Mode:a; Polarization:Vertical; Modulation:n; bandwidth:20MHz; Channel:High

Frequency	RX_R	Factor	Emission	Limit	Over Limit	Detector
MHz	dBuV	dB	dBuV/m	dBuV/m	dB	
4924	41.03	7.31	48.34	54	-5.66	peak
7386	35.02	11.41	46.43	54	-7.57	peak
9848	34.04	14.38	48.42	54	-5.58	peak





Mode:a; Polarization:Horizontal; Modulation:n; bandwidth:40MHz; Channel:Low

Frequency	RX_R	Factor	Emission	Limit	Over Limit	Detector
MHz	dBuV	dB	dBuV/m	dBuV/m	dB	
4844	40.40	6.60	47.00	54	-7.00	peak
7266	39.13	10.89	50.02	54	-3.98	peak
9688	31.71	14.35	46.06	54	-7.94	peak

Mode:a; Polarization:Vertical; Modulation:n; bandwidth:40MHz; Channel:Low

Frequency	RX_R	Factor	Emission	Limit	Over Limit	Detector
MHz	dBuV	dB	dBuV/m	dBuV/m	dB	
4844	38.60	6.60	45.20	54	-8.80	peak
7266	35.54	10.89	46.43	54	-7.57	peak
9688	34.23	14.35	48.58	54	-5.42	peak

Mode:a; Polarization:Horizontal; Modulation:n; bandwidth:40MHz; Channel:middle

Frequency	RX_R	Factor	Emission	Limit	Over Limit	Detector
MHz	dBuV	dB	dBuV/m	dBuV/m	dB	
4874	43.36	6.92	50.28	54	-3.72	peak
7311	39.02	11.08	50.10	54	-3.90	peak
9748	33.49	14.36	47.85	54	-6.15	peak

Mode:a; Polarization:Vertical; Modulation:n; bandwidth:40MHz; Channel:middle

Frequency	RX_R	Factor	Emission	Limit	Over Limit	Detector
MHz	dBuV	dB	dBuV/m	dBuV/m	dB	
4874	38.69	6.92	45.61	54	-8.39	peak
7311	38.56	11.08	49.64	54	-4.36	peak
9748	33.90	14.36	48.26	54	-5.74	peak

Mode:a; Polarization:Horizontal; Modulation:n; bandwidth:40MHz; Channel:High

Frequency	RX_R	Factor	Emission	Limit	Over Limit	Detector
MHz	dBuV	dB	dBuV/m	dBuV/m	dB	
4904	43.10	7.22	50.32	54	-3.68	peak
7356	36.06	11.28	47.34	54	-6.66	peak
9808	33.43	14.37	47.80	54	-6.20	peak

Mode:a; Polarization:Vertical; Modulation:n; bandwidth:40MHz; Channel:High

Frequency	RX_R	Factor	Emission	Limit	Over Limit	Detector
MHz	dBuV	dB	dBuV/m	dBuV/m	dB	
4904	43.52	7.22	50.74	54	-3.26	peak
7356	37.47	11.28	48.75	54	-5.25	peak
9808	33.97	14.37	48.34	54	-5.66	peak

**7.9 99% Bandwidth**

Test Requirement RSS-Gen Section 6.6  
 Test Method: ANSI C63.10 Section 6.9.3

**7.9.1 E.U.T. Operation**

Operating Environment:

Temperature: 22 °C Humidity: 50 % RH Atmospheric Pressure: 1002 mbar

Test mode a: Charge + TX mode\_Keep the EUT in charging and continuously transmitting mode with all modulation types. All data rates for each modulation type have been tested and found the data rate @ 1Mbps is the worst case of IEEE 802.11b; data rate @ 6Mbps is the worst case of IEEE 802.11g; data rate @ 6.5Mbps is the worst case of IEEE 802.11n(HT20); data rate @ 13.5Mbps is the worst case of IEEE 802.11n(HT40). Only the data of worst case is recorded in the report.

**7.9.2 Test Setup Diagram**

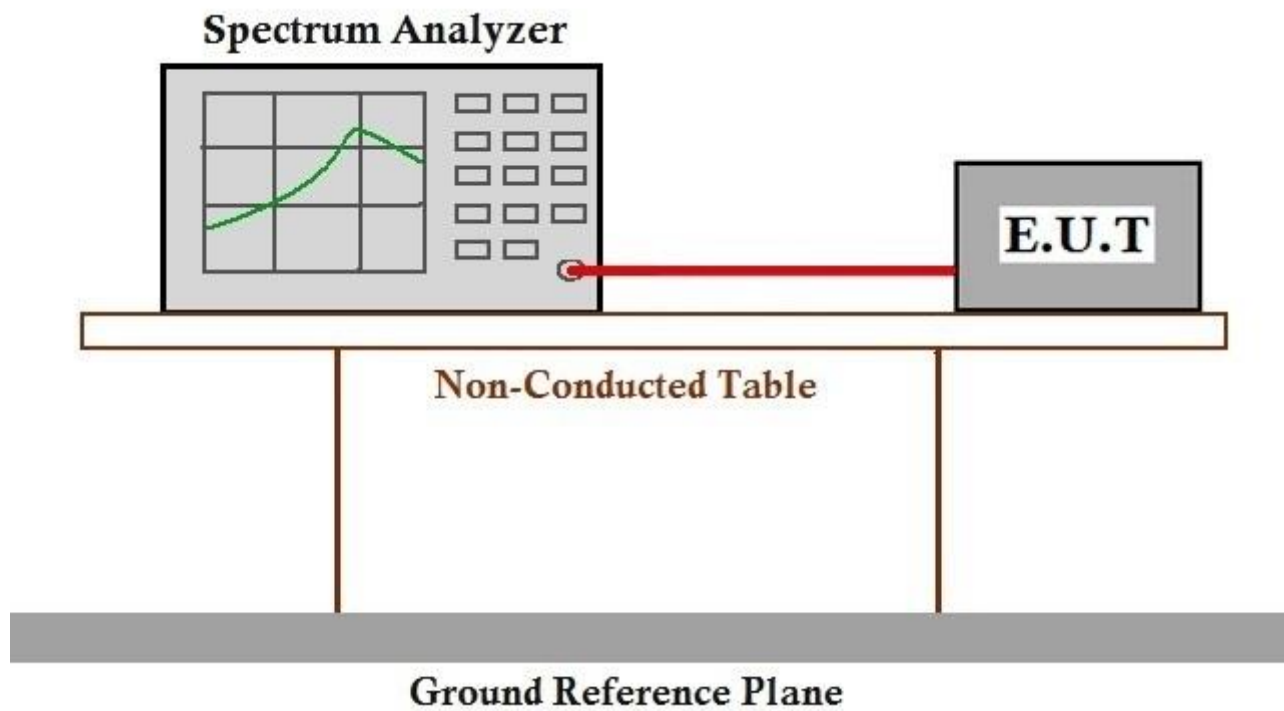

**7.9.3 Measurement Procedure and Data**

The detailed test data see: Appendix A SHEM181000907101

### 7.10 Frequency Stability

Test Requirement RSS-Gen Section 8.11

Test Method: RSS-Gen Section 6.11

#### 7.10.1 E.U.T. Operation

Operating Environment:

Temperature: 21 °C Humidity: 45 % RH Atmospheric Pressure: 1010 mbar

Test mode TX mode\_Keep the EUT in continuously transmitting mode with unmodulated carrier frequency.

#### 7.10.2 Test Setup Diagram

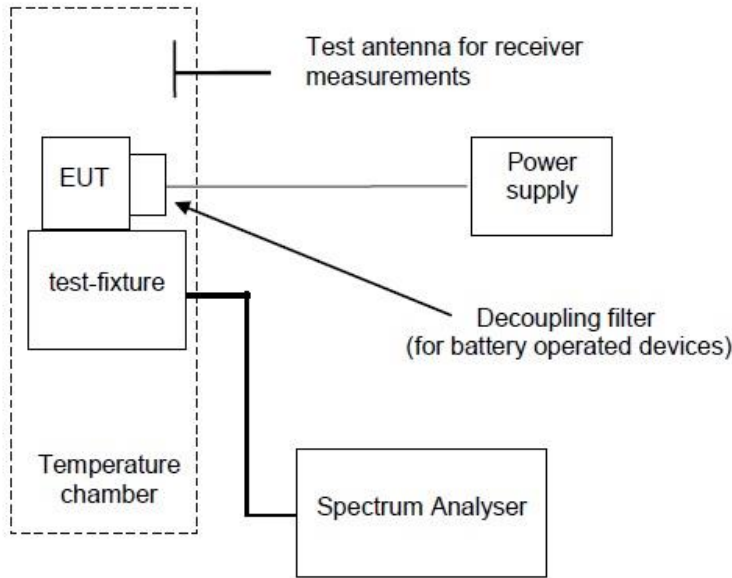

#### 7.10.3 Measurement Procedure and Data

Test Conditions		Test Result				
Voltage	Temp (°C)	2412	2437	2462	2422	2452
Normal	Extreme (-20)	2412.007	2437.009	2462.008	2422.003	2452.011
	Extreme (+20)	2412.014	2437.029	2462.015	2422.010	2452.001
	Extreme (+50)	2412.013	2437.018	2462.016	2422.012	2452.012
Extreme (+15%)	Normal (20)	2412.014	2437.017	2462.011	2422.004	2452.003
Extreme (-15%)		2412.013	2437.014	2462.018	2422.006	2452.007



## **8 Test Setup Photographs**

Refer to the < Test Setup photos-FCC >.

## **9 EUT Constructional Details**

Refer to the < External Photos > & < Internal Photos >.

**- End of the Report -**