

COPYRIGHT © Hangzhou EZVIZ Software Co., Ltd.. ALL RIGHTS RESERVED.

Any and all information, including, among others, wordings, pictures, graphs are the properties of Hangzhou EZVIZ Software Co., Ltd. (hereinafter referred to as “EZVIZ”). This user manual (hereinafter referred to as “the Manual”) cannot be reproduced, changed, translated, or distributed, partially or wholly, by any means, without the prior written permission of EZVIZ. Unless otherwise stipulated, EZVIZ does not make any warranties, guarantees or representations, express or implied, regarding to the Manual.

About this Manual

The Manual includes instructions for using and managing the product. Pictures, charts, images and all other information hereinafter are for description and explanation only. The information contained in the Manual is subject to change, without notice, due to firmware updates or other reasons. Please find the latest version in the EZVIZ™ website (<http://www.ezvizlife.com>).

Revision Record

New release – January, 2019

Trademarks Acknowledgement

EZVIZ™, ™, and other EZVIZ's trademarks and logos are the properties of EZVIZ in various jurisdictions. Other trademarks and logos mentioned below are the properties of their respective owners.

Legal Disclaimer

TO THE MAXIMUM EXTENT PERMITTED BY APPLICABLE LAW, THE PRODUCT DESCRIBED, WITH ITS HARDWARE, SOFTWARE AND FIRMWARE, IS PROVIDED “AS IS”, WITH ALL FAULTS AND ERRORS, AND EZVIZ MAKES NO WARRANTIES, EXPRESS OR IMPLIED, INCLUDING WITHOUT LIMITATION, MERCHANTABILITY, SATISFACTORY QUALITY, FITNESS FOR A PARTICULAR PURPOSE, AND NON-INFRINGEMENT OF THIRD PARTY. IN NO EVENT WILL EZVIZ, ITS DIRECTORS, OFFICERS, EMPLOYEES, OR AGENTS BE LIABLE TO YOU FOR ANY SPECIAL, CONSEQUENTIAL, INCIDENTAL, OR INDIRECT DAMAGES, INCLUDING, AMONG OTHERS, DAMAGES FOR LOSS OF BUSINESS PROFITS, BUSINESS INTERRUPTION, OR LOSS OF DATA OR DOCUMENTATION, IN CONNECTION WITH THE USE OF THIS PRODUCT, EVEN IF EZVIZ

HAS BEEN ADVISED OF THE POSSIBILITY OF SUCH DAMAGES. TO THE MAXIMUM EXTENT PERMITTED BY APPLICABLE LAW, IN NO EVENT SHALL EZVIZ'S TOTAL LIABILITY FOR ALL DAMAGES EXCEED THE ORIGINAL PURCHASE PRICE OF THE PRODUCT.

EZVIZ DOES NOT UNDERTAKE ANY LIABILITY FOR PERSONAL INJURY OR PROPERTY DAMAGE AS THE RESULT OF PRODUCT INTERRUPTION OR SERVICE TERMINATION CAUSED BY: A) IMPROPER INSTALLATION OR USAGE OTHER THAN AS REQUESTED; B) THE PROTECTION OF NATIONAL OR PUBLIC INTERESTS; C) FORCE MAJEURE; D) YOURSELF OR THE THIRD PARTY, INCLUDING WITHOUT LIMITATION, USING ANY THIRD PARTY'S PRODUCTS, SOFTWARE, APPLICATIONS, AND AMONG OTHERS.

REGARDING TO THE PRODUCT WITH INTERNET ACCESS, THE USE OF PRODUCT SHALL BE WHOLLY AT YOUR OWN RISKS. EZVIZ SHALL NOT TAKE ANY RESPONSIBILITIES FOR ABNORMAL OPERATION, PRIVACY LEAKAGE OR OTHER DAMAGES RESULTING FROM CYBER ATTACK, HACKER ATTACK, VIRUS INSPECTION, OR OTHER INTERNET SECURITY RISKS; HOWEVER, EZVIZ WILL PROVIDE TIMELY TECHNICAL SUPPORT IF REQUIRED. SURVEILLANCE LAWS AND DATA PROTECTION LAWS VARY BY JURISDICTION. PLEASE CHECK ALL RELEVANT LAWS IN YOUR JURISDICTION BEFORE USING THIS PRODUCT IN ORDER TO ENSURE THAT YOUR USE CONFORMS TO THE APPLICABLE LAW. EZVIZ SHALL NOT BE LIABLE IN THE EVENT THAT THIS PRODUCT IS USED WITH ILLEGITIMATE PURPOSES.

IN THE EVENT OF ANY CONFLICTS BETWEEN THE ABOVE AND THE APPLICABLE LAW, THE LATTER PREVAILS.

Operations

Step 1 Power-on

Connect the camera to power outlet with the power adapter, as shown below.

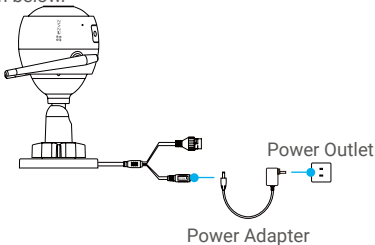

Step 2 Camera Setup

1. Create a user account

- Connect your mobile phone to Wi-Fi.
- Download and install the EZVIZ app by searching "EZVIZ" in App Store or Google Play™.
- Launch the app and register an EZVIZ user account following the start-up wizard.

2. Add a camera to EZVIZ

- Log in the EZVIZ app.
- From the EZVIZ app Home screen, tap "+" on the upper-right hand corner to go to the scan QR code interface.

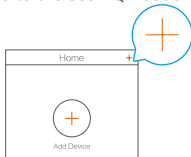

- Scan the QR code on the body of the camera.

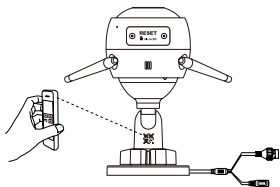

- Follow the EZVIZ app wizard to finish Wi-Fi configuration.

You can also select wired connection.

- connect the camera to a router with a network cable.
- add the camera to EZVIZ app by scanning its QR code.

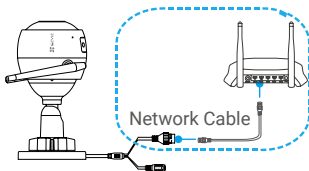

- i** • Hold the RESET button for 5 seconds when adding cameras or Wi-Fi connection failed.
- Please make sure your phone is connected to the 2.4GHz Wi-Fi from the router for Wi-Fi configuration.

Step 3 Camera Installation

You can install the camera on the wall or ceiling.

- i** • Make sure the wall is strong enough to withstand three times the weight of the camera.
- Recommended installation height: 3m (10 ft).

1 Install the Camera

- Place drill template onto the surface you have chosen to mount the camera.
- **(For the cement wall/ceiling only)** Drill screw holes according to the template, and insert three anchors.
- Use three metal screws to fix the camera base according to the template.

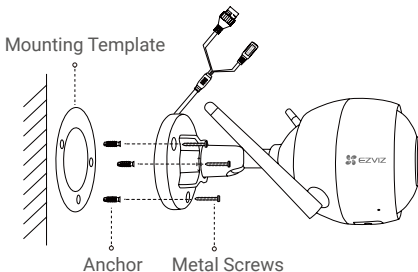

2 Adjust the Surveillance Angle

- Loosen the adjusting screw.
- Adjust the surveillance angle as your desired place.
- Tighten the adjusting screw when you have your camera in the position you want.

- i** Make sure the microSD card slot is facing downward.

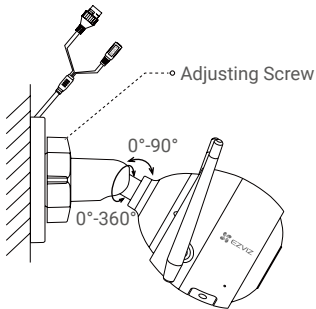

3 Install the waterproof kit (Optional)

i If the camera is installed outdoors or in the humid environment, please use the waterproof kit.

- Insert the gasket to the network port of the camera.



- Pass the A side of the network cable through the nut, the gasket and the endcap.

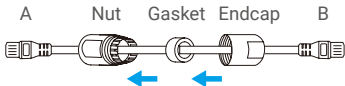

- Tighten up the nut and the endcap.



- Insert the A side into the network port of the camera and tighten up the nut.



- Connect the B side with the LAN port of the router.



Appendix

Box Contents

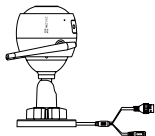

Internet Camera x1



Power Adapter x1



Regulatory Information x1



Mounting Template
x1



Screw Kit
x1

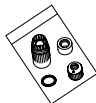

Waterproof
Kit x1



Quick Start Guide
x1

Basics

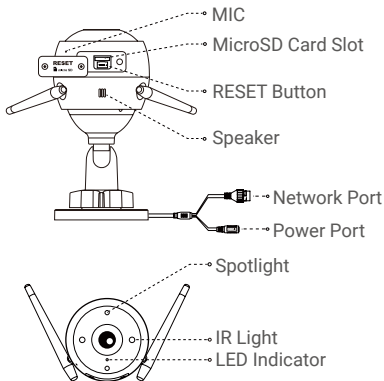

Name	Description
LED Indicator	<ul style="list-style-type: none">• Solid Red: Camera is starting up.• Slow-Flashing Red: Wi-Fi connection has failed.• Fast-Flashing Red: Camera exception (e.g. microSD card error).• Solid Blue: Video is being viewed or played back in EZVIZ App.• Fast-Flashing Blue: Camera is ready for the Wi-Fi connection.• Slow-Flashing Blue: Camera is running properly.
MicroSD Card	It should be purchased separately. After inserting the microSD card, initialize it in the EZVIZ app, and then video files can be stored in the SD card.
RESET Button	Hold the RESET button for 5 seconds when the camera is running. The camera restarts, and resets all parameters to default.

Troubleshooting

- Q:** “The device is offline.” or “The device is not registered.” prompts when adding the camera by EZVIZ app.
- A:** 1. Make sure the network that the camera is connected to is normal and the DHCP of router is enabled.
2. Hold the RESET button for 5 seconds if you manually changed the network parameters.
- Q:** How to use the microSD card for local storage?
- A:** 1. Make sure there is a microSD card inserted and the camera is added to your EZVIZ account. Log in the EZVIZ app and enter the “Device Details” interface, if the “Initialize Storage Card” button appears, you need to initialize the microSD card first.
2. The microSD card recording for the motion detection is enabled by default.
- Q:** Why does the spotlight stays turn on when the environment is bright enough?
- A:** The device may trigger a protection mechanism, which will be automatically lifted after one hour, and if you need to close it manually, tap Black/White Night Vision or Smart Night vision in the app.

EXPOSURE TO RADIOFREQUENCY RF (only for EU market)

The frequency bands and the nominal limits of transmitted power (radiated and/or conducted) applicable to this radio device are the following:

Band	Wi-Fi 2.4 GHz
Frequency	From 2.412 GHz to 2.472 GHz
Power transmission (EIRP)	60 mW

 For detailed information, please visit www.ezviz.eu.

Regulatory Information



This product and - if applicable - the supplied accessories too are marked with "CE" and comply therefore with the applicable harmonized European standards listed under the Radio Equipment Directive 2014/53/EU, the EMC Directive 2014/30/EU, the RoHS Directive 2011/65/EU.



2012/19/EU (WEEE directive): Products marked with this symbol cannot be disposed of as unsorted municipal waste in the European Union. For proper recycling, return this product to your local supplier upon the purchase of equivalent new equipment, or dispose of it at designated collection points. For more information see: www.recyclethis.info



2006/66/EC and its amendment 2013/56/EU (battery directive): This product contains a battery that cannot be disposed of as unsorted municipal waste in the European Union. See the product documentation for specific battery information. The battery is marked with this symbol, which may include lettering to indicate cadmium (Cd), lead (Pb), or mercury (Hg). For proper recycling, return the battery to your supplier or to a designated collection point. For more information see: www.recyclethis.info

EC DECLARATION OF CONFORMITY

Hereby, Hangzhou EZVIZ Software Co., Ltd. declares that the radio equipment type [CS-C1C, CS-C1HC, CS-C1T, CS-C2C, CS-CV206, CS-CV310, CS-C3N, CS-C3W, CS-C3WN, CS-C3X, CS-C6N, CS-CV246, CS-CV248, CS-C6CN, CS-C6C, CS-C6W, CS-TY1, CS-TY2, CS-TY3, CS-CV336, CS-DP1, CS-DP1C, CS-DP2C, CS-DB2C, CS-C4W, CS-C4C, CS-CV228, CS-C5W, CS-C5C, CS-C5HC, CS-C5X, CS-C5HX, CS-C8W, CS-C8C, CS-C3A, CS-BC1, CS-BC1-B1, CS-BC1-B2, CS-BC1-B3, CS-BC1-B4, CS-W2H, CS-X5S-4W, CS-X5S-8W, CS-A1-32W, CS-T9-A, CS-T4-A] is in compliance with Directive 2014/53/EU.

The full text of the EC DECLARATION OF CONFORMITY is available at the following web link:

<http://www.ezvizlife.com/declaration-of-conformity>.

Use only power supplies listed in the Table.

Equipment model	Adapter manufacture	Adapter model
CS-C1C/ CS-C1HC/ CS-C1T/ CS-C2C/ CS-CV206/ CS-CV246/CS-C6N/ CS-C6CN/ CS-C6C/ CS-TY1/ CS-TY2/ CS-TY3/ CS-W2D/ CS-A1-32W/ CS-T9-A	Shenzhen Honor Electronic Co Ltd	ADS-5RE-06 05050EPCU/EPC(US), ADS-5RH-06 05050EPB(UK), ADS-5RH-06 05050EPG(EU), ADS-5RH-06 05050EPSA(AU), ADS-5RH-06 05050EPBR(BR), ADS-5RH-06 05050EPI(IN), ADS-5MA-06A 05050GPK(KR)
	Sichuan Jiuzhou Electronic Technology Co., Ltd	DYS05100CP-U, DYS05100CP-E
CS-CV248/ CS-C6W/ CS-C6W/ CS-CV336/ CS-DP1/ CS-DP1C/ CS-DP2C/ CS-C3A/ CS-BC1	Shenzhen Honor Electronic Co Ltd	ADS-10LA-06 05010EPCU/EPC(US), ADS-10RH-06 05010EPB (UK), ADS-10RH-06 05010EPG(EU), ADS-10RH-06 05010EPSA(SA), ADS-10RH-06 05010EPBR(BR), ADS-10RH-06 05010EPI(IN), ADS-12CG-06 05010EPC(JP)
	Sichuan Jiuzhou Electronic Technology Co., Ltd	DYS05200CQ-U, DYS05200CQ-E
CS-CV310/ CS-C3N/ CS-C3W/ CS-C3WN/ CS-C3X/ CS-SD1/ CS-C4W/ CS-C4C/ CS-CV228/ CS-C8W/ CS-C8C/ CS-W2H/ CS-W3C-WD1200G/ CS-T8-B	Shenzhen Honor Electronic Co Ltd	ADS-12FG-12N 12012EPCU(US), ADS-12FG-12N 12012EPB(UK), ADS-12FG-12N 12012EPG(EU), ADS-12FG-12N 12012EPSA(AU), ADS-12FG-12N 12012EPBR(BR), ADS-12FG-12N 12012EPI(IN)
CS-X5S-4W/ CS-X5S-8W/ CS-X5S-16H	Moso Power Supply Technology Co. Ltd	MSA-C1500IC12.0-18P-GB(UK), MSA-C1500IC12.0-18P-DE, MSA-C1500IC12.0-18P-AU(AU), MSA-C1500IC12.0-18P-BR(BR), ADS-25FSG-12 12018GPI(IN)

Important Safety Information



Note: Please read the manual before using the device.



This symbol on the device indicates that the safety compatibility manual and / or installation manual must be read, which contains information related to the safe operation of the device.

Caution: Be sure to read these instructions before operating the equipment.



This symbol on the device indicates that the surface or component is overheating. If you touch this surface, you may cause personal injury.

Warning: To reduce the risk of personal injury due to overheating of the components, wait until the surface cools down before touching it.



Warning: The separate earthing terminal must be permanently connected to earth.

Warning: For SELV DC input: the DC power source shall comply with the Safety Extra-Low Voltage (SELV) requirements of IEC 60950-1.



Caution: Do not block ventilation openings while the system is on, and keep at least 2 cm distance from ventilation openings and walls or other things which may block the openings.

Warning: Disposal of a battery into fire or a hot oven, or mechanically crushing or cutting of a battery that can result in an explosion.

Warning: Leaving a battery in an extremely high temperature surrounding environment that can result in an explosion or the leakage of flammable liquid or gas.

Warning: A battery subjected to extremely low air pressure that may result in an explosion or the leakage of flammable liquid or gas.

Warning: Dispose of used batteries according to the instructions.

Warning: Replace only with the same or equivalent type recommended by the manufacturer.

Caution: THE PRODUCT IS BUILT IN A REPLACEABLE BATTERY.

Warning: Do not ingest battery, Chemical Burn Hazard.

Caution: This product contains a coin/button cell battery. If the coin / button cell battery is swallowed, it can cause severe internal burns in just 2 hours and can lead to death.

Caution: Keep new and used batteries away from children.

Caution: If the battery compartment does not close securely, stop using the product and keep it away from children.

Caution: If you think batteries might have been swallowed or placed inside any part of the body, seek immediate medical attention.

Caution: Risk of fire or explosion if the battery is replaced by an incorrect type.

FCC Information

Please take attention that changes or modification not expressly approved by the party responsible for compliance could void the user's authority to operate the equipment.

FCC compliance

This equipment has been tested and found to comply with the limits for a Class B digital device, pursuant to part 15 of the FCC Rules. These limits are designed to provide reasonable protection against harmful interference in a residential installation. This equipment generates, uses and can radiate radio frequency energy and, if not installed and used in accordance with the instructions, may cause harmful interference to radio communications. However, there is no guarantee that interference will not occur in a particular installation. If this equipment does cause harmful interference to radio or television reception, which can be determined by turning the equipment off and on, the user is encouraged to try to correct the interference by one or more of the following measures:

- Reorient or relocate the receiving antenna.
- Increase the separation between the equipment and receiver.
- Connect the equipment into an outlet on a circuit different from that to which the receiver is connected.
- Consult the dealer or an experienced radio/TV technician for help.

This equipment should be installed and operated with a minimum distance 20cm between the radiator and your body.

FCC Conditions

This device complies with part 15 of the FCC Rules. Operation is subject to the following two conditions:

1. This device may not cause harmful interference.
2. This device must accept any interference received, including interference that may cause undesired operation.

Industry Canada ICES-003 Compliance

This device meets the CAN ICES-3 (B)/NMB-3(B) standards requirements.

This device complies with Industry Canada licence-exempt RSS standard(s). Operation is subject to the following two conditions:

- (1) this device may not cause interference, and
 - (2) this device must accept any interference, including interference that may cause undesired operation of the device.
- Under Industry Canada regulations, this radio transmitter may only operate using an antenna of a type and maximum (or lesser) gain approved for the transmitter by Industry Canada. To reduce potential radio interference to other users, the antenna type and its gain should be so chosen that the equivalent isotropically radiated power (e.i.r.p.) is not more than that necessary for successful communication.

This equipment should be installed and operated with a minimum distance 20cm between the radiator and your body.

Le présent appareil est conforme aux CNR d'Industrie Canada applicables aux appareils radioexempts de licence. L'exploitation est autorisée aux deux conditions suivantes :

- (1) l'appareil ne doit pas produire de brouillage, et
- (2) l'utilisateur de l'appareil doit accepter tout brouillage radioélectrique subi, même si le brouillage est susceptible d'en compromettre le fonctionnement.

Conformément à la réglementation d'Industrie Canada, le présent émetteur radio peut fonctionner avec une antenne d'un type et d'un gain maximal (ou inférieur) approuvé pour l'émetteur par Industrie Canada. Dans le but de réduire les risques de brouillage radioélectrique à l'intention des autres utilisateurs, il faut choisir le type d'antenne et son gain de sorte que la puissance isotrope rayonnée équivalente (p.i.r.e.) ne dépasse pas l'intensité nécessaire à l'établissement d'une communication satisfaisante.

Cet équipement doit être installé et utilisé à une distance minimale de 20 cm entre le radiateur et votre corps.

IFETEL Information

La operación de este equipo está sujeta a las siguientes dos condiciones:

- (1) es posible que este equipo o dispositivo no cause interferencia perjudicial
- (2) este equipo o dispositivo debe aceptar cualquier interferencia, incluyendo la que pueda causar su operación no deseada.

