

COPYRIGHT © Hangzhou EZVIZ Software Co., Ltd. ALL RIGHTS RESERVED.

Any and all information, including, among others, wordings, pictures, graphs are the properties of Hangzhou EZVIZ Software Co., Ltd. (hereinafter referred to as "EZVIZ"). This user manual (hereinafter referred to as "the Manual") cannot be reproduced, changed, translated, or distributed, partially or wholly, by any means, without the prior written permission of EZVIZ. Unless otherwise stipulated, EZVIZ does not make any warranties, guarantees or representations, express or implied, regarding to the Manual.

About this Manual

The Manual includes instructions for using and managing the product. Pictures, charts, images and all other information hereinafter are for description and explanation only. The information contained in the Manual is subject to change, without notice, due to firmware updates or other reasons. Please find the latest version in the EZVIZ™ website (<http://www.ezvizlife.com>).

Revision Record

New release – January, 2021

Trademarks Acknowledgement

EZVIZ™, ™, and other EZVIZ's trademarks and logos are the properties of EZVIZ in various jurisdictions. Other trademarks and logos mentioned below are the properties of their respective owners.

Legal Disclaimer

TO THE MAXIMUM EXTENT PERMITTED BY APPLICABLE LAW, THE PRODUCT DESCRIBED, WITH ITS HARDWARE, SOFTWARE AND FIRMWARE, IS PROVIDED "AS IS", WITH ALL FAULTS AND ERRORS, AND EZVIZ MAKES NO WARRANTIES, EXPRESS OR IMPLIED, INCLUDING WITHOUT LIMITATION, MERCHANTABILITY, SATISFACTORY QUALITY, FITNESS FOR A PARTICULAR PURPOSE, AND NON-INFRINGEMENT OF THIRD PARTY. IN NO EVENT WILL EZVIZ, ITS DIRECTORS, OFFICERS, EMPLOYEES, OR AGENTS BE LIABLE TO YOU FOR ANY SPECIAL, CONSEQUENTIAL, INCIDENTAL, OR INDIRECT DAMAGES, INCLUDING, AMONG OTHERS, DAMAGES FOR LOSS OF BUSINESS PROFITS, BUSINESS INTERRUPTION, OR LOSS OF DATA OR DOCUMENTATION, IN CONNECTION WITH THE USE OF THIS PRODUCT, EVEN IF EZVIZ HAS BEEN ADVISED OF THE POSSIBILITY OF SUCH DAMAGES.

TO THE MAXIMUM EXTENT PERMITTED BY APPLICABLE LAW, IN NO EVENT SHALL EZVIZ'S TOTAL LIABILITY FOR ALL DAMAGES EXCEED THE ORIGINAL PURCHASE PRICE OF THE PRODUCT.

EZVIZ DOES NOT UNDERTAKE ANY LIABILITY FOR PERSONAL INJURY OR PROPERTY DAMAGE AS THE RESULT OF PRODUCT INTERRUPTION OR SERVICE TERMINATION CAUSED BY: A) IMPROPER INSTALLATION OR USAGE OTHER THAN AS REQUESTED; B) THE PROTECTION OF NATIONAL OR PUBLIC INTERESTS; C) FORCE MAJEURE; D) YOURSELF OR THE THIRD PARTY, INCLUDING WITHOUT LIMITATION, USING ANY THIRD PARTY'S PRODUCTS, SOFTWARE, APPLICATIONS, AND AMONG OTHERS.

REGARDING TO THE PRODUCT WITH INTERNET ACCESS, THE USE OF PRODUCT SHALL BE WHOLLY AT YOUR OWN RISKS. EZVIZ SHALL NOT TAKE ANY RESPONSIBILITIES FOR ABNORMAL OPERATION, PRIVACY LEAKAGE OR OTHER DAMAGES RESULTING FROM CYBER ATTACK, HACKER ATTACK, VIRUS INSPECTION, OR OTHER INTERNET SECURITY RISKS; HOWEVER, EZVIZ WILL PROVIDE TIMELY TECHNICAL SUPPORT IF REQUIRED. SURVEILLANCE LAWS AND DATA PROTECTION LAWS VARY BY JURISDICTION. PLEASE CHECK ALL RELEVANT LAWS IN YOUR JURISDICTION BEFORE USING THIS PRODUCT IN ORDER TO ENSURE THAT YOUR USE CONFORMS TO THE APPLICABLE LAW. EZVIZ SHALL NOT BE LIABLE IN THE EVENT THAT THIS PRODUCT IS USED WITH ILLEGITIMATE PURPOSES.

IN THE EVENT OF ANY CONFLICTS BETWEEN THE ABOVE AND THE APPLICABLE LAW, THE LATTER PREVAILS.

Overview

1. Package Contents



Camera



Drilling Template



Screw Kit



Power Adapter



Regulatory Information



Quick Start Guide

i The power adapter's appearance is subject to the one you have bought.

2. Basics

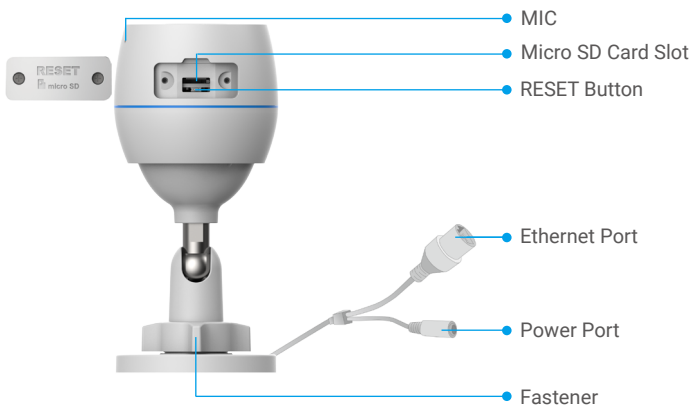

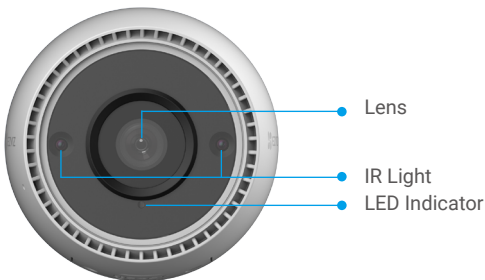

Name	Description
RESET Button	<ul style="list-style-type: none"> When the camera is working, press and hold for about 4s until the LED indicator is solid red, the camera will restart and all parameters will be restored to default settings. If you want to connect the camera to a new Wi-Fi, press and hold for about 4s, and then follow the instructions on the app to configure a new Wi-Fi.
MIC	Collects and converts sound into an electrical signal.
Speaker	Converts an electrical audio signal into a corresponding sound.
Fastener	Rotate to make angle adjusting easier.
IR Light	Helps the camera to get black-and-white images at night.
LED Indicator	<ul style="list-style-type: none"> Solid Red: Camera starting up. Slow-flashing Red: Network exception. Fast-flashing Red: Camera exception (e.g. Micro SD card error). Fast-flashing Blue: Camera ready for Wi-Fi connection. Slow-flashing Blue: Camera running properly. Solid Blue: App visiting camera.

Cable and Network Connection

1. Wiring

Option A: Wired Connection

1. Connect the camera to the LAN port of your router with the Ethernet cable (purchase separately).
2. Connect power port of the camera to the power outlet.

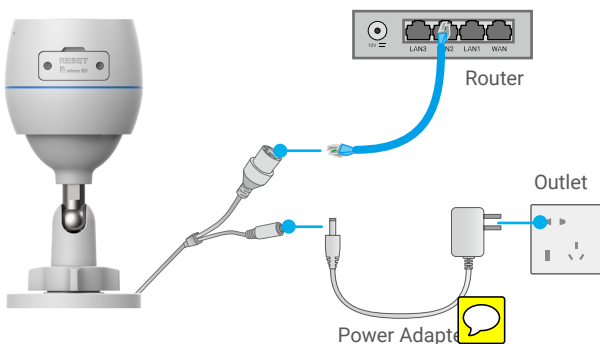

i Use power adapter and power cable come with the camera in the box.

Option B: Wireless Connection

Connect the camera to the power source with power adapter.

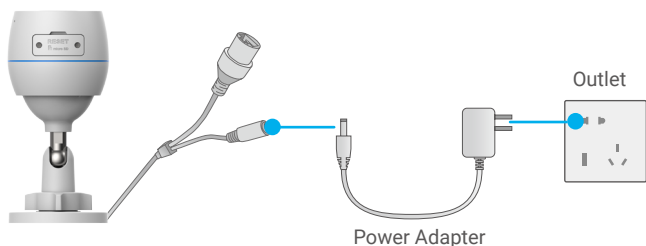

2. Connect to the Internet

1. Get the EZVIZ App

- Connect your mobile phone to Wi-Fi (suggested).
- Download and install the EZVIZ app by searching for "EZVIZ" in the App Store or Google Play™.
- Launch the app and register an EZVIZ user account.

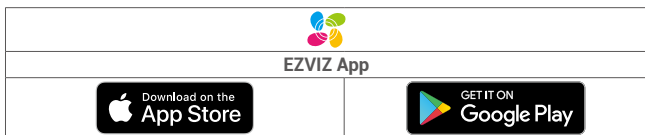

- i** If you have already used the app, please make sure that it is the latest version. To find out if an update is available, go to the app store and search for "EZVIZ".

2. Add Camera to EZVIZ

- Press and hold the RESET button on the camera for about 4 seconds. The LED indicator will fast flash blue.
- Log in to your account using the EZVIZ app.
- On the Home screen, tap "+" on the upper-right corner to go to the Scan QR Code interface.
- Scan the QR code on the Quick Start Guide cover or on the body of the camera.



- Follow the EZVIZ app wizard to add the camera to the app.

- i** If you want to connect your camera to another Wi-Fi, press and hold the reset button for about 4s and repeat the steps above.

Installation

1. SD Card Installation (Optional)

1. Remove the cover on the camera.
2. Insert the micro SD card (sold separately) into the card slot
3. Place the cover back on.

i After installing the micro SD card, you should initialize the card in the EZVIZ app before using it.

4. In the EZVIZ app, tap the Storage Status in the Device Settings interface to check the SD card status.
5. If the memory card status displays as Uninitialized, tap to initialize it.

2. Installation Location

Choose a location with a clear, unblocked field of view and with a good wireless signal to the camera. Please keep the following tips in mind:

- Make sure the wall is strong enough to withstand three times the weight of the camera.
- Camera cannot be installed in front of an air conditioner or facing direct sunlight.
- Setting up detection sensitivity on EZVIZ app when selecting location, thus you can verify if motion can be detected and adjust the value of sensitivity based on the size and distance of detected objects.

3. Installation Procedure

- Stick the drilling template onto a clean and flat surface.
- (For cement wall only) Drill screw holes according to the template, and insert anchors.
- Use screws to fix the camera on the installation surface.
- Loosen the fastener.
- Rotate the upper part of the camera to get an appropriate detection effect.

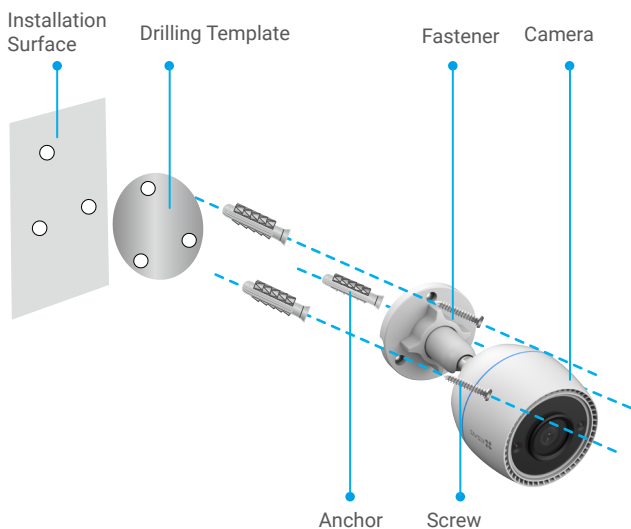







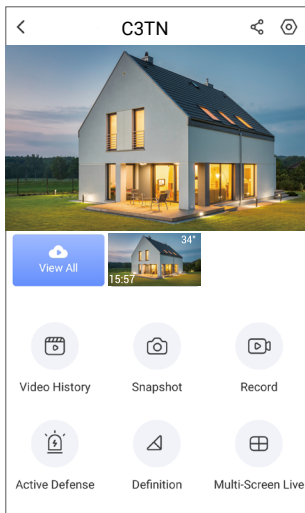

Operations on the EZVIZ App

 The app interface may be different due to version update, and the interface of the app you installed on your phone shall prevail.

1. Live View

When you launch the EZVIZ app, the device page displays as shown below. You can watch a live feed, take snapshots, record videos, or choose video definition as needed.



Icon	Description
	Share. Share your device with anyone you want.
	Settings. View or change the device settings.
	Video History. View Recordings.
	Snapshot. Take a snapshot.
	Record. Manually start/stop recording.
	Active Defense. Sound the alarm to deter intruders.
	Definition. Select video resolution from Ultra HD, Hi-Def or Standard.
	Multi-screen Live. Tap to select live view window layout.

2. Video History

The camera supports both local storage and cloud storage.

Tap **Video History** button on the device page, then you can use the calendar and timeline to find and view specific recordings.

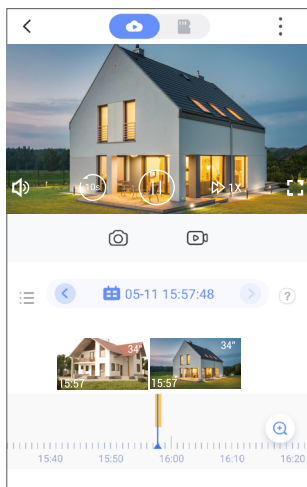

3. Intelligent Human Detection

Go to **Settings - Intelligent Human Detection** and enable it. Then EZVIZ will send you notifications when a trigger is detected.

To let the camera respond differently in different situations, you can customize the detection notification by changing the value of detection sensitivity. The higher sensitivity is, the easier people farther to the camera can be detected.

4. Active Defense

With intelligent human detection enabled, alarms will automatically be triggered and videos will be recorded once human or animal is detected. Alarm stops until no motion is detected.

In addition, you can also tap the **Active Defense** button on the device page to trigger an alarm. The camera will sound an alarm and the spotlight will flash quickly to deter intruders, which can last up to one minute.

FAQ

Q: If the camera is offline on the App, will the video recording continue?

A: If the camera is powered on but disconnected from the Internet, then local recording will continue but cloud recording will stop. If the camera is powered off, both video recordings will stop.

Q: Why the alarm is triggered when nobody in the image?

A: Configure a lower value for the detection sensitivity. Please notice that vehicle and animals are also alarm triggering sources.

Q: How to use the micro SD card for local storage?

A: 1. Make sure that there is a micro SD card inserted and the camera is added to your EZVIZ account. Open the EZVIZ app and enter the "Device Details" interface, if the "Initialize Storage Card" button appears, you need to initialize the micro SD card first.

2. The micro SD card recording for the motion detection is enabled by default.

Q: The mobile phone cannot receive alarm prompts when the camera is online.

A: 1. Make sure that the EZVIZ app is running on your mobile phone and that the Motion Detection Notification is enabled.

2. For Android system, make sure that the app is running in background; and for iOS, enable the message push function in "Settings > Notification".

3. If still no alarm prompts, press and hold the RESET button for about 4 seconds to restore the camera settings.

Q: Live view or playback failed.

A: Make sure that your network is well connected. Watching live videos needs a good bandwidth. You can refresh the video, or change a network and try again.

1. Use Amazon Alexa

These instructions will enable you to control your EZVIZ devices with Amazon Alexa. If you run into any difficulties during the process, please refer to **Troubleshooting**.

Before you start, make sure that:

1. EZVIZ devices are connected to the EZVIZ app.
2. In the EZVIZ app, turn off the "Image Encryption" in the Device Settings page.
3. You have an Alexa-enabled device (i.e. Echo Spot, Echo-Show, All-new Echo-Show, Fire TV (all generations), Fire TV stick (second generation only), or Fire TV Edition smart TVs).
4. The Amazon Alexa app is already installed on your smart device, and you have created an account.

To Control EZVIZ devices with Amazon Alexa:

1. Open the Alexa app and select "Skills and Games" from the menu.
2. On the Skills and Games screen, search for "EZVIZ", and you will find "EZVIZ" skills.
3. Select your EZVIZ device's skill, then tap **ENABLE TO USE**.
4. Enter your EZVIZ username and password, and tap **Sign in**.
5. Tap the **Authorize** button to authorize Alexa to access your EZVIZ account, so that Alexa can control your EZVIZ devices.
6. You will see "EZVIZ has been successfully linked", then tap **DISCOVER DEVICES** to allow Alexa to discover all your EZVIZ devices.
7. Go back to Alexa app menu and select "Devices", and under devices you will see all your EZVIZ devices.

Voice Command

Discover a new smart device via the "Smart Home" menu in the Alexa app or the Alexa Voice Control function.

Once the device is found, you can control it with your voice. Speak simple commands to Alexa.

-  Your device's name for example: "show xxxx camera," can be changed in the EZVIZ app. Each time you change the name of the device, you will need to discover the device again to update the name.

Troubleshooting

What should I do if Alexa fails to discover my device?

Check if there are any Internet connecting problems.

Try to restart the smart device and re-discover the device on Alexa.

Why the device's status is "Offline" on Alexa?

Your device might have been disconnected from the network. Restart the smart device and re-discover on Alexa.

Check if your router is connected to the Internet and try again.

-  For details about countries where Amazon Alexa is available, see Amazon Alexa's official website.

2. Use Google Assistant

With the Google Assistant, you can activate your EZVIZ device and watch live by speaking Google Assistant voice commands.

The following devices and apps are required:

1. A functional EZVIZ app.
2. In the EZVIZ app, turn off the "Image Encryption" and turn on the "Audio" in the Device Settings page.
3. A TV with functional Chromecast connecting to it.
4. The Google Assistant app on your phone.

To get started, follow the steps below:

1. Set up the EZVIZ device and make sure it works properly on the app.
2. Download the Google Home app from the App Store or Google Play Store™ and log into your Google account.
3. On the Myhome screen, tap "+" on the upper-left corner, and select "Set up device" from the menu list to go to the Set up interface.
4. Tap **Works with Google**, and search for "EZVIZ", where you will find "EZVIZ" skills.
5. Enter your EZVIZ username and password, and tap **Sign in**.
6. Tap the **Authorize** button to authorize Google to access your EZVIZ account, so that Google can control your EZVIZ devices.
7. Tap **Return to app**.
8. Follow the above steps to complete the authorization. When synchronization is completed, EZVIZ service will be listed under your list of services. To see a list of compatible devices under your EZVIZ account, tap on the EZVIZ service icon.
9. Now try some commands. Use the name of the camera that you created when you set up the system.

Users can manage devices as a single entity or in a group. Adding devices to a room allows users to control a group of devices at the same time using one command.

See the link for more information:

<https://support.google.com/googlehome/answer/7029485?co=GENIE.Platform%3DAndroid&hl=en>

 For additional information about the device, please refer to www.ezviz.eu.

Regulatory Information



This product and - if applicable - the supplied accessories too are marked with "CE" and comply therefore with the applicable harmonized European standards listed under the Radio Equipment Directive 2014/53/EU, the EMC Directive 2014/30/EU, the RoHS Directive 2011/65/EU.



2012/19/EU (WEEE directive): Products marked with this symbol cannot be disposed of as unsorted municipal waste in the European Union. For proper recycling, return this product to your local supplier upon the purchase of equivalent new equipment, or dispose of it at designated collection points. For more information see: www.recyclethis.info



2006/66/EC and its amendment 2013/56/EU (battery directive): This product contains a battery that cannot be disposed of as unsorted municipal waste in the European Union. See the product documentation for specific battery information. The battery is marked with this symbol, which may include lettering to indicate cadmium (Cd), lead (Pb), or mercury (Hg). For proper recycling, return the battery to your supplier or to a designated collection point. For more information see: www.recyclethis.info

EC DECLARATION OF CONFORMITY

Hereby, Hangzhou EZVIZ Software Co., Ltd. declares that the radio equipment type [CS-C1C, CS-C1HC, CS-C1T, CS-C2C, CS-CV206, CS-CV310, CS-C3N, **CS-C3T, CS-C3TN, CS-C3HX**, CS-C3W, CS-C3WN, CS-C3X, CS-C6N, CS-CV246, CS-CV248, CS-C6CN, CS-C6C, CS-C6W, CS-TY1, CS-TY2, CS-TY3, CS-CV336, **CS-DB1, CS-DB2**, CS-DP1, **CS-DP2**, CS-DP1C, CS-DP2C, CS-DB2C, **CS-CMT-CHIME**, CS-C4W, CS-C4C, CS-CV228, CS-C5W, CS-C5C, CS-C5HC, CS-C5X, CS-C5HX, **CS-C8PF, CS-C8T, CS-C8TN, CS-C8W, CS-C8C, CS-CP1, CS-C3A, CS-BC1, CS-BC1-B1, CS-BC1-B2, CS-BC1-B3, CS-BC1-B4, CS-BC1C, CS-BC2, CS-BC3, CS-BC3C, CS-BC8, CS-BC8C, CS-BM1, CS-W2H, CS-X5S-4W, CS-X5S-8W, CS-A1-32W, **C3-A3-W, CS-T1C-BG, CS-T2C-BG, CS-T3C-BG****, CS-T9-A, CS-T4-A, **CS-HAL-LB1**] is in compliance with Directive 2014/53/EU.

The full text of the EC DECLARATION OF CONFORMITY is available at the following web link:

<http://www.ezvizlife.com/declaration-of-conformity>.

Use only power supplies listed in the Table.

Equipment model	Adapter manufacture	Adapter model
CS-C1C/ CS-C1HC/ CS-C1T/ CS-C2C/ CS-CV206/ CS-CV246/CS-C6N/ CS-C6CN/ CS-C6C/ CS-TY1/ CS-TY2/ CS-TY3/ CS-W2D/ CS-A1-32W/ CS-T9-A/ CS-BC1C/ CS-CP1/ CS-A3-W	Shenzhen Honor Electronic Co Ltd	ADS-5RE-06 05050EPCU/EPC(US), ADS-5RH-06 05050EPB(UK), ADS-5RH-06 05050EPG(EU), ADS-5RH-06 05050EPSA(AU), ADS-5RH-06 05050EPBR(BR), ADS-5RH-06 05050EPI(IN), ADS-5MA-06A 05050GPK(KR)
	Sichuan Jiuzhou Electronic Technology Co., Ltd	DYS05100CP-U, DYS05100CP-E
CS-CV248/ CS-C6W/ CS-C6W/ CS-CV336/ CS-DP1/ CS-DP1C/ CS-DP2C/ CS-C3A/ CS-BC1/ CS-CP1/ CS-BC1C/ CS-BC3/ CS-BC3C/ CS-BC8/ CS-BC8C/ CS-BM1	Shenzhen Honor Electronic Co., Ltd	ADS-10LA-06 05010EPCU/EPC(US), ADS-10RH-06 05010EPB (UK), ADS-10RH-06 05010EPG(EU), ADS-10RH-06 05010EPSA(SA), ADS-10RH-06 05010EPBR(BR), ADS-10RH-06 05010EPI(IN), ADS-12CG-06 05010EPC(JP)
	Sichuan Jiuzhou Electronic Technology Co., Ltd	DYS05200CQ-U, DYS05200CQ-E
CS-CV310/ CS-C3N/ CS-C3W/ CS-C3WN/ CS-C3X/ CS-SD1/ CS-C4W/ CS-C4C/ CS-CV228/ CS-C8W/ CS-C8C/ CS-W2H/ CS-W3C-WD1200G/CS-T8-B/ CS-C3T/ CS-C3TN/ CS-C3HX/ CS-C8PF/ CS-C8T/ CS-C8TN	Shenzhen Honor Electronic Co., Ltd	ADS-12FG-12N 12012EPCU(US), ADS-12FG-12N 12012EPB(UK), ADS-12FG-12N 12012EPG(EU), ADS-12FB-12 12012EPSA(AU), ADS-12FG-12N 12012EPBR(BR), ADS-12FG-12N 12012EPI(IN)
CS-X5S-4W/ CS-X5S-8W/ CS-X5S-16H	Moso Power Supply Technology Co., Ltd	MSA-C1500IC12.0-18P-GB(UK), MSA-C1500IC12.0-18P-DE, MSA-C1500IC12.0-18P-AU(AU), MSA-C1500IC12.0-18P-BR(BR), ADS-25FSG-12 12018GPI(IN)

Important Safety Information



Note: Please read the manual before using the device.



This symbol on the device indicates that the safety compatibility manual and / or installation manual must be read, which contains information related to the safe operation of the device.

Caution: Be sure to read these instructions before operating the equipment.



This symbol on the device indicates that the surface or component is overheating. If you touch this surface, you may cause personal injury.

Warning: To reduce the risk of personal injury due to overheating of the components, wait until the surface cools down before touching it.



Warning: The separate earthing terminal must be permanently connected to earth.

Warning: For SELV DC input: the DC power source shall comply with the Safety Extra-Low Voltage (SELV) requirements of IEC 60950-1.



Caution: Do not block ventilation openings while the system is on, and keep at least 2 cm distance from ventilation openings and walls or other things which may block the openings.

Warning: Disposal of a battery into fire or a hot oven, or mechanically crushing or cutting of a battery that can result in an explosion.

Warning: Leaving a battery in an extremely high temperature surrounding environment that can result in an explosion or the leakage of flammable liquid or gas.

Warning: A battery subjected to extremely low air pressure that may result in an explosion or the leakage of flammable liquid or gas.

Warning: Dispose of used batteries according to the instructions.

Warning: Replace only with the same or equivalent type recommended by the manufacturer.

Caution: THE PRODUCT IS BUILT IN A REPLACEABLE BATTERY.

Warning: Do not ingest battery, Chemical Burn Hazard.

Caution: This product contains a coin/button cell battery. If the coin / button cell battery is swallowed, it can cause severe internal burns in just 2 hours and can lead to death.

Caution: Keep new and used batteries away from children.

Caution: If the battery compartment does not close securely, stop using the product and keep it away from children.

Caution: If you think batteries might have been swallowed or placed inside any part of the body, seek immediate medical attention.

Caution: Risk of fire or explosion if the battery is replaced by an incorrect type.

FCC Information

Please take attention that changes or modification not expressly approved by the party responsible for compliance could void the user's authority to operate the equipment.

FCC compliance

This equipment has been tested and found to comply with the limits for a Class B digital device, pursuant to part 15 of the FCC Rules. These limits are designed to provide reasonable protection against harmful interference in a residential installation. This equipment generates, uses and can radiate radio frequency energy and, if not installed and used in accordance with the instructions, may cause harmful interference to radio communications. However, there is no guarantee that interference will not occur in a particular installation. If this equipment does cause harmful interference to radio or television reception, which can be determined by turning the equipment off and on, the user is encouraged to try to correct the interference by one or more of the following measures:

- Reorient or relocate the receiving antenna.
- Increase the separation between the equipment and receiver.
- Connect the equipment into an outlet on a circuit different from that to which the receiver is connected.
- Consult the dealer or an experienced radio/TV technician for help.

This equipment should be installed and operated with a minimum distance 20cm between the radiator and your body.

FCC Conditions

This device complies with part 15 of the FCC Rules. Operation is subject to the following two conditions:

1. This device may not cause harmful interference.
2. This device must accept any interference received, including interference that may cause undesired operation.

Industry Canada ICES-003 Compliance

This device meets the CAN ICES-3 (B)/NMB-3(B) standards requirements.

This device complies with Industry Canada licence-exempt RSS standard(s). Operation is subject to the following two conditions:

- (1) this device may not cause interference, and
 - (2) this device must accept any interference, including interference that may cause undesired operation of the device.
- Under Industry Canada regulations, this radio transmitter may only operate using an antenna of a type and maximum (or lesser) gain approved for the transmitter by Industry Canada. To reduce potential radio interference to other users, the antenna type and its gain should be so chosen that the equivalent isotropically radiated power (e.i.r.p.) is not more than that necessary for successful communication.

This equipment should be installed and operated with a minimum distance 20cm between the radiator and your body.

Le présent appareil est conforme aux CNR d'Industrie Canada applicables aux appareils radioexempts de licence. L'exploitation est autorisée aux deux conditions suivantes :

- (1) l'appareil ne doit pas produire de brouillage, et
- (2) l'utilisateur de l'appareil doit accepter tout brouillage radioélectrique subi, même si le brouillage est susceptible d'en compromettre le fonctionnement.

Conformément à la réglementation d'Industrie Canada, le présent émetteur radio peut fonctionner avec une antenne d'un type et d'un gain maximal (ou inférieur) approuvé pour l'émetteur par Industrie Canada. Dans le but de réduire les risques de brouillage radioélectrique à l'intention des autres utilisateurs, il faut choisir le type d'antenne et son gain de sorte que la puissance isotrope rayonnée équivalente (p.i.r.e.) ne dépasse pas l'intensité nécessaire à l'établissement d'une communication satisfaisante.

Cet équipement doit être installé et utilisé à une distance minimale de 20 cm entre le radiateur et votre corps.

IFETEL Information

La operación de este equipo está sujeta a las siguientes dos condiciones:

- (1) es posible que este equipo o dispositivo no cause interferencia perjudicial y
- (2) este equipo o dispositivo debe aceptar cualquier interferencia, incluyendo la que pueda causar su operación no deseada.

