



COMOSAR E-Field Probe Calibration Report

Ref : ACR.233.1.17.SATU.A

**SHENZHEN SEM TEST TECHNOLOGY CO.,
LTD.**

**1/F, BUILDING A, HONGWEI INDUSTRIAL PARK, LIUXIAN
2ND ROAD BAO'AN DISTRICT**

SHENZHEN (518101), CHINA

MVG COMOSAR DOSIMETRIC E-FIELD PROBE

SERIAL NO.: SN 45/15 EPGO280

Calibrated at MVG US

2105 Barrett Park Dr. - Kennesaw, GA 30144



Calibration Date: 09/08/201;

Summary:

This document presents the method and results from an accredited COMOSAR Dosimetric E-Field Probe calibration performed in MVG USA using the CALISAR / CALIBAIR test bench, for use with a COMOSAR system only. All calibration results are traceable to national metrology institutions.



| | <i>Name</i> | <i>Function</i> | <i>Date</i> | <i>Signature</i> |
|----------------------|---------------|-----------------|-------------|----------------------|
| <i>Prepared by :</i> | Jérôme LUC | Product Manager | 7/8/2019 | <i>JS</i> |
| <i>Checked by :</i> | Jérôme LUC | Product Manager | 7/8/2019 | <i>JS</i> |
| <i>Approved by :</i> | Kim RUTKOWSKI | Quality Manager | 7/8/2019 | <i>Kim Rutkowski</i> |

| | <i>Customer Name</i> |
|-----------------------|--|
| <i>Distribution :</i> | Shenzhen SEM.Test Technology Co., Ltd. |

| <i>Issue</i> | <i>Date</i> | <i>Modifications</i> |
|--------------|-------------|----------------------|
| A | 7/8/2019 | Initial release |
| | | |
| | | |
| | | |



TABLE OF CONTENTS

1 Device Under Test 4

2 Product Description 4

 2.1 General Information 4

3 Measurement Method 4

 3.1 Linearity 4

 3.2 Sensitivity 5

 3.3 Lower Detection Limit 5

 3.4 Isotropy 5

 3.5 Boundary Effect 5

4 Measurement Uncertainty 5

5 Calibration Measurement Results 6

 5.1 Sensitivity in air 6

 5.2 Linearity 7

 5.3 Sensitivity in liquid 7

 5.4 Isotropy 8

6 List of Equipment 10

1 DEVICE UNDER TEST

| Device Under Test | |
|--|---|
| Device Type | COMOSAR DOSIMETRIC E FIELD PROBE |
| Manufacturer | MVG |
| Model | SSE2 |
| Serial Number | SN 45/15 EPGO280 |
| Product Condition (new / used) | New |
| Frequency Range of Probe | 0.7 GHz-6GHz |
| Resistance of Three Dipoles at Connector | Dipole 1: R1=0.193 MΩ Dipole 2: R2=0.188 MΩ Dipole 3: R3=0.198 MΩ |

A yearly calibration interval is recommended.

2 PRODUCT DESCRIPTION

2.1 GENERAL INFORMATION

MVG's COMOSAR E field Probes are built in accordance to the IEEE 1528, OET 65 Bulletin C and CEI/IEC 62209 standards.



Figure 1 – MVG COMOSAR Dosimetric E field Dipole

| | |
|--|--------|
| Probe Length | 330 mm |
| Length of Individual Dipoles | 2 mm |
| Maximum external diameter | 8 mm |
| Probe Tip External Diameter | 2.5 mm |
| Distance between dipoles / probe extremity | 1 mm |

3 MEASUREMENT METHOD

The IEEE 1528, OET 65 Bulletin C, CENELEC EN50361 and CEI/IEC 62209 standards provide recommended practices for the probe calibrations, including the performance characteristics of interest and methods by which to assess their affect. All calibrations / measurements performed meet the fore mentioned standards.

3.1 LINEARITY

The evaluation of the linearity was done in free space using the waveguide, performing a power sweep to cover the SAR range 0.01W/kg to 100W/kg.

3.2 SENSITIVITY

The sensitivity factors of the three dipoles were determined using a two step calibration method (air and tissue simulating liquid) using waveguides as outlined in the standards.

3.3 LOWER DETECTION LIMIT

The lower detection limit was assessed using the same measurement set up as used for the linearity measurement. The required lower detection limit is 10 mW/kg.

3.4 ISOTROPY

The axial isotropy was evaluated by exposing the probe to a reference wave from a standard dipole with the dipole mounted under the flat phantom in the test configuration suggested for system validations and checks. The probe was rotated along its main axis from 0 - 360 degrees in 15 degree steps. The hemispherical isotropy is determined by inserting the probe in a thin plastic box filled with tissue-equivalent liquid, with the plastic box illuminated with the fields from a half wave dipole. The dipole is rotated about its axis (0°–180°) in 15° increments. At each step the probe is rotated about its axis (0°–360°).

3.5 BOUNDARY EFFECT

The boundary effect is defined as the deviation between the SAR measured data and the expected exponential decay in the liquid when the probe is oriented normal to the interface. To evaluate this effect, the liquid filled flat phantom is exposed to fields from either a reference dipole or waveguide. With the probe normal to the phantom surface, the peak spatial average SAR is measured and compared to the analytical value at the surface.

4 **MEASUREMENT UNCERTAINTY**

The guidelines outlined in the IEEE 1528, OET 65 Bulletin C, CENELEC EN50361 and CEI/IEC 62209 standards were followed to generate the measurement uncertainty associated with an E-field probe calibration using the waveguide technique. All uncertainties listed below represent an expanded uncertainty expressed at approximately the 95% confidence level using a coverage factor of k=2, traceable to the Internationally Accepted Guides to Measurement Uncertainty.

| Uncertainty analysis of the probe calibration in waveguide | | | | | |
|--|-----------------------|--------------------------|------------|----|--------------------------|
| ERROR SOURCES | Uncertainty value (%) | Probability Distribution | Divisor | ci | Standard Uncertainty (%) |
| Incident or forward power | 3.00% | Rectangular | $\sqrt{3}$ | 1 | 1.732% |
| Reflected power | 3.00% | Rectangular | $\sqrt{3}$ | 1 | 1.732% |
| Liquid conductivity | 5.00% | Rectangular | $\sqrt{3}$ | 1 | 2.887% |
| Liquid permittivity | 4.00% | Rectangular | $\sqrt{3}$ | 1 | 2.309% |
| Field homogeneity | 3.00% | Rectangular | $\sqrt{3}$ | 1 | 1.732% |
| Field probe positioning | 5.00% | Rectangular | $\sqrt{3}$ | 1 | 2.887% |

| | | | | | |
|--|-------|-------------|------------|---|--------|
| Field probe linearity | 3.00% | Rectangular | $\sqrt{3}$ | 1 | 1.732% |
| Combined standard uncertainty | | | | | 5.831% |
| Expanded uncertainty 95 % confidence level k = 2 | | | | | 12.0% |

5 CALIBRATION MEASUREMENT RESULTS

| Calibration Parameters | |
|------------------------|-------|
| Liquid Temperature | 21 °C |
| Lab Temperature | 21 °C |
| Lab Humidity | 45 % |

5.1 SENSITIVITY IN AIR

| Normx dipole 1 ($\mu\text{V}/(\text{V}/\text{m})^2$) | Normy dipole 2 ($\mu\text{V}/(\text{V}/\text{m})^2$) | Normz dipole 3 ($\mu\text{V}/(\text{V}/\text{m})^2$) |
|---|---|---|
| 0.73 | 0.63 | 0.80 |

| DCP dipole 1 (mV) | DCP dipole 2 (mV) | DCP dipole 3 (mV) |
|----------------------|----------------------|----------------------|
| 93 | 92 | 96 |

Calibration curves $e_i=f(V)$ ($i=1,2,3$) allow to obtain H-field value using the formula:

$$E = \sqrt{E_1^2 + E_2^2 + E_3^2}$$

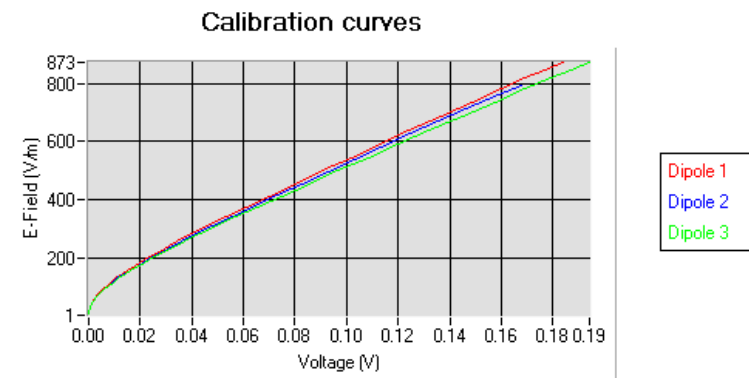

5.2 LINEARITY

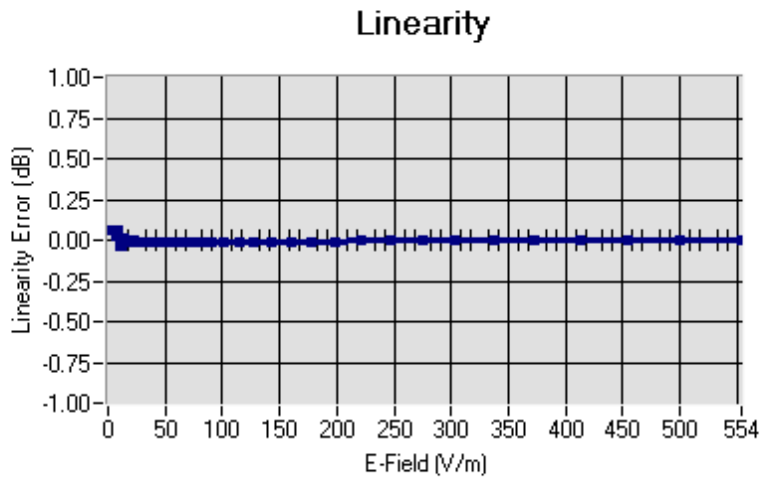

Linearity: $\pm 1.43\%$ ($\pm 0.06\text{dB}$)

5.3 SENSITIVITY IN LIQUID

| Liquid | Frequency (MHz +/- 100MHz) | Permittivity | Epsilon (S/m) | ConvF |
|--------|----------------------------|--------------|---------------|-------|
| HL850 | 835 | 42.71 | 0.89 | 1.91 |
| BL850 | 835 | 57.52 | 1.03 | 1.97 |
| HL900 | 900 | 41.94 | 0.93 | 1.75 |
| BL900 | 900 | 52.87 | 1.09 | 1.82 |
| HL1800 | 1800 | 40.62 | 1.39 | 1.88 |
| BL1800 | 1800 | 53.22 | 1.47 | 1.95 |
| HL1900 | 1900 | 41.22 | 1.37 | 2.15 |
| BL1900 | 1900 | 50.99 | 1.52 | 2.22 |
| HL2000 | 2000 | 40.39 | 1.36 | 2.04 |
| BL2000 | 2000 | 54.39 | 1.54 | 2.08 |
| HL2450 | 2450 | 40.46 | 1.87 | 2.33 |
| BL2450 | 2450 | 54.62 | 1.95 | 2.40 |
| HL5200 | 5200 | 35.14 | 4.74 | 2.44 |
| BL5200 | 5200 | 49.01 | 5.27 | 2.54 |
| HL5400 | 5400 | 34.52 | 4.77 | 2.68 |
| BL5400 | 5400 | 49.67 | 5.45 | 2.77 |
| HL5600 | 5600 | 37.08 | 5.03 | 2.72 |
| BL5600 | 5600 | 47.57 | 5.69 | 2.80 |
| HL5800 | 5800 | 34.64 | 5.19 | 2.52 |
| BL5800 | 5800 | 49.82 | 5.94 | 2.58 |

LOWER DETECTION LIMIT: 7mW/kg

5.4 ISOTROPY

HL900 MHz

- Axial isotropy: 0.04 dB
- Hemispherical isotropy: 0.06 dB

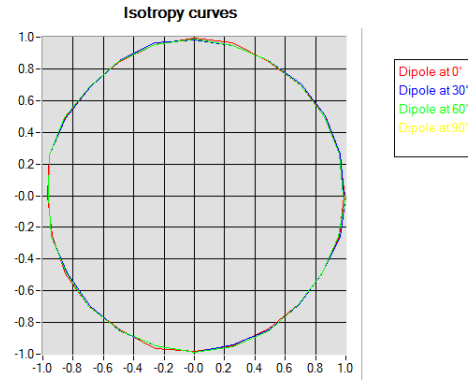

HL1800 MHz

- Axial isotropy: 0.05 dB
- Hemispherical isotropy: 0.06 dB

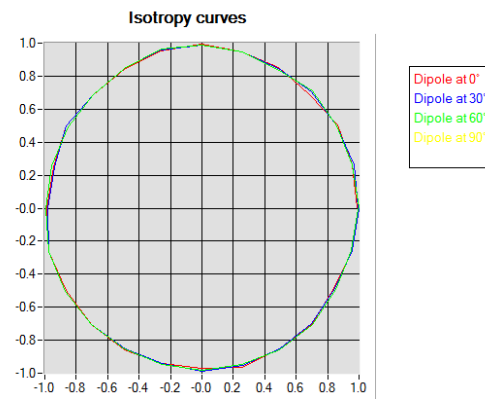

HL5600 MHz

- Axial isotropy: 0.06 dB
- Hemispherical isotropy: 0.08 dB

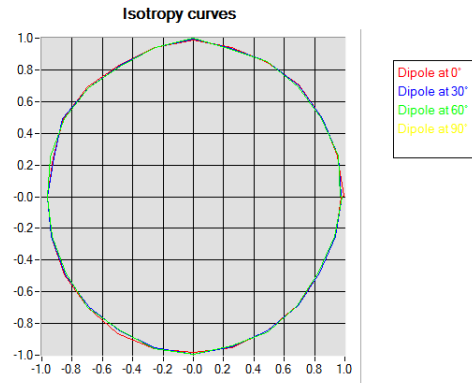



6 LIST OF EQUIPMENT

| Equipment Summary Sheet | | | | |
|-------------------------------|----------------------|--------------------|---|---|
| Equipment Description | Manufacturer / Model | Identification No. | Current Calibration Date | Next Calibration Date |
| Flat Phantom | MVG | SN-20/09-SAM71 | Validated. No cal required. | Validated. No cal required. |
| COMOSAR Test Bench | Version 3 | NA | Validated. No cal required. | Validated. No cal required. |
| Network Analyzer | Rhode & Schwarz ZVA | SN100132 | 02/2019 | 02/2022 |
| Reference Probe | MVG | EP 94 SN 37/08 | 10/2018 | 10/2019 |
| Multimeter | Keithley 2000 | 1188656 | 01/2017 | 01/2020 |
| Signal Generator | Agilent E4438C | MY49070581 | 01/2017 | 01/2020 |
| Amplifier | Aethercomm | SN 046 | Characterized prior to test. No cal required. | Characterized prior to test. No cal required. |
| Power Meter | HP E4418A | US38261498 | 01/2017 | 01/2020 |
| Power Sensor | HP ECP-E26A | US37181460 | 01/2017 | 01/2020 |
| Directional Coupler | Narda 4216-20 | 01386 | Characterized prior to test. No cal required. | Characterized prior to test. No cal required. |
| Waveguide | Mega Industries | 069Y7-158-13-712 | Validated. No cal required. | Validated. No cal required. |
| Waveguide Transition | Mega Industries | 069Y7-158-13-701 | Validated. No cal required. | Validated. No cal required. |
| Waveguide Termination | Mega Industries | 069Y7-158-13-701 | Validated. No cal required. | Validated. No cal required. |
| Temperature / Humidity Sensor | Control Company | 150798832 | 10/2017 | 10/2019 |



SAR Reference Dipole Calibration Report

Ref : ACR.104.1.15.SATU.A

Shenzhen SEM Test Technology Co., Ltd.
1/F, Building A, Hongwei Industrial Park, Liuxian 2nd Road
BAO'AN DISTRICT
SHENZHEN, P.R.C. (518101)
MVG COMOSAR REFERENCE DIPOLE
FREQUENCY: 2450 MHZ
SERIAL NO.: SN 13/15 DIP 2G450-364

Calibrated at MVG US
2105 Barrett Park Dr. - Kennesaw, GA 30144



03/16/2019

Summary:

This document presents the method and results from an accredited SAR reference dipole calibration performed in MVG USA using the COMOSAR test bench. All calibration results are traceable to national metrology institutions.



| | <i>Name</i> | <i>Function</i> | <i>Date</i> | <i>Signature</i> |
|----------------------|---------------|-----------------|-------------|----------------------|
| <i>Prepared by :</i> | Jérôme LUC | Product Manager | 3/16/2019 | <i>JS</i> |
| <i>Checked by :</i> | Jérôme LUC | Product Manager | 3/16/2019 | <i>JS</i> |
| <i>Approved by :</i> | Kim RUTKOWSKI | Quality Manager | 3/16/2019 | <i>Kim Rutkowski</i> |

| | <i>Customer Name</i> |
|-----------------------|--|
| <i>Distribution :</i> | Shenzhen SEM Test Technology Co., Ltd. |

| <i>Issue</i> | <i>Date</i> | <i>Modifications</i> |
|--------------|-------------|----------------------|
| A | 3/16/2019 | Initial release |
| | | |
| | | |
| | | |



TABLE OF CONTENTS

1 Introduction.....4

2 Device Under Test4

3 Product Description4

 3.1 General Information4

4 Measurement Method5

 4.1 Return Loss Requirements5

 4.2 Mechanical Requirements5

5 Measurement Uncertainty5

 5.1 Return Loss5

 5.2 Dimension Measurement5

 5.3 Validation Measurement5

6 Calibration Measurement Results6

 6.1 Return Loss and Impedance In Head Liquid6

 6.2 Return Loss and Impedance In Body Liquid6

 6.3 Mechanical Dimensions6

7 Validation measurement7

 7.1 Head Liquid Measurement7

 7.2 SAR Measurement Result With Head Liquid8

 7.3 Body Liquid Measurement9

 7.4 SAR Measurement Result With Body Liquid10

8 List of Equipment11

1 INTRODUCTION

This document contains a summary of the requirements set forth by the IEEE 1528, FCC KDBs and CEI/IEC 62209 standards for reference dipoles used for SAR measurement system validations and the measurements that were performed to verify that the product complies with the fore mentioned standards.

2 DEVICE UNDER TEST

| Device Under Test | |
|--------------------------------|-----------------------------------|
| Device Type | COMOSAR 2450 MHz REFERENCE DIPOLE |
| Manufacturer | MVG |
| Model | SID2450 |
| Serial Number | SN 13/15 DIP 2G450-364 |
| Product Condition (new / used) | New |

A yearly calibration interval is recommended.

3 PRODUCT DESCRIPTION

3.1 GENERAL INFORMATION

MVG’s COMOSAR Validation Dipoles are built in accordance to the IEEE 1528, FCC KDBs and CEI/IEC 62209 standards. The product is designed for use with the COMOSAR test bench only.



Figure 1 – MVG COMOSAR Validation Dipole

4 MEASUREMENT METHOD

The IEEE 1528, FCC KDBs and CEI/IEC 62209 standards provide requirements for reference dipoles used for system validation measurements. The following measurements were performed to verify that the product complies with the fore mentioned standards.

4.1 RETURN LOSS REQUIREMENTS

The dipole used for SAR system validation measurements and checks must have a return loss of -20 dB or better. The return loss measurement shall be performed against a liquid filled flat phantom, with the phantom constructed as outlined in the fore mentioned standards.

4.2 MECHANICAL REQUIREMENTS

The IEEE Std. 1528 and CEI/IEC 62209 standards specify the mechanical components and dimensions of the validation dipoles, with the dimensions frequency and phantom shell thickness dependent. The COMOSAR test bench employs a 2 mm phantom shell thickness therefore the dipoles sold for use with the COMOSAR test bench comply with the requirements set forth for a 2 mm phantom shell thickness.

5 MEASUREMENT UNCERTAINTY

All uncertainties listed below represent an expanded uncertainty expressed at approximately the 95% confidence level using a coverage factor of k=2, traceable to the Internationally Accepted Guides to Measurement Uncertainty.

5.1 RETURN LOSS

The following uncertainties apply to the return loss measurement:

| Frequency band | Expanded Uncertainty on Return Loss |
|----------------|-------------------------------------|
| 400-6000MHz | 0.1 dB |

5.2 DIMENSION MEASUREMENT

The following uncertainties apply to the dimension measurements:

| Length (mm) | Expanded Uncertainty on Length |
|-------------|--------------------------------|
| 3 - 300 | 0.05 mm |

5.3 VALIDATION MEASUREMENT

The guidelines outlined in the IEEE 1528, FCC KDBs, CENELEC EN50361 and CEI/IEC 62209 standards were followed to generate the measurement uncertainty for validation measurements.

| Scan Volume | Expanded Uncertainty |
|-------------|----------------------|
| 1 g | 20.3 % |

| | |
|------|--------|
| 10 g | 20.1 % |
|------|--------|

6 CALIBRATION MEASUREMENT RESULTS

6.1 RETURN LOSS AND IMPEDANCE IN HEAD LIQUID

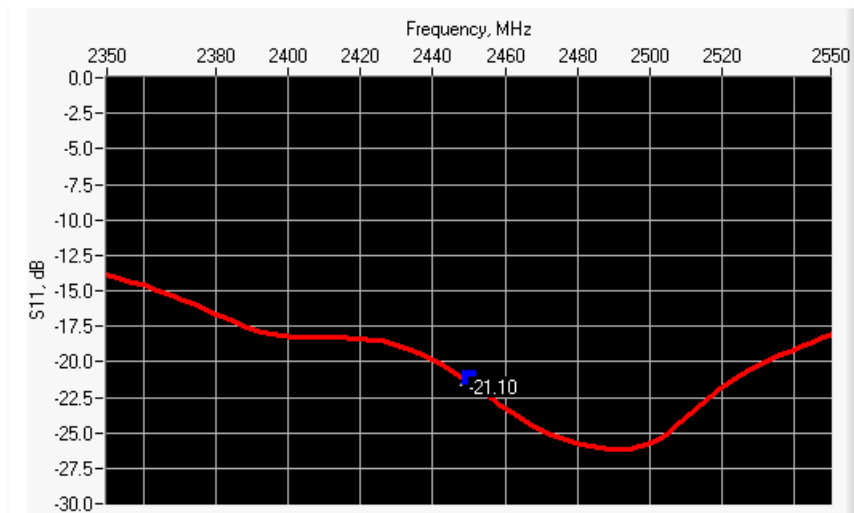

| Frequency (MHz) | Return Loss (dB) | Requirement (dB) | Impedance |
|-----------------|------------------|------------------|-----------------|
| 2450 | -21.10 | -20 | 45.2 Ω + 7.3 jΩ |

6.2 RETURN LOSS AND IMPEDANCE IN BODY LIQUID

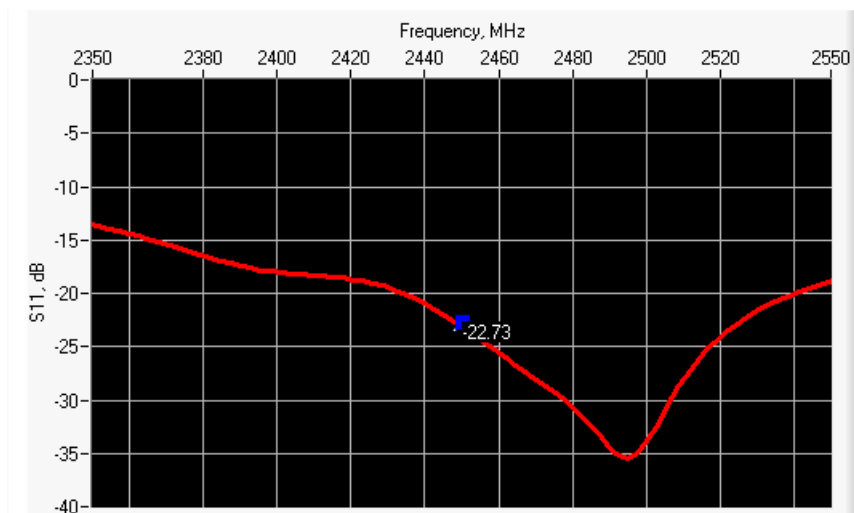

| Frequency (MHz) | Return Loss (dB) | Requirement (dB) | Impedance |
|-----------------|------------------|------------------|-----------------|
| 2450 | -22.73 | -20 | 48.7 Ω + 7.2 jΩ |

6.3 MECHANICAL DIMENSIONS

| Frequency MHz | L mm | | h mm | | d mm | |
|---------------|-------------|----------|-------------|----------|------------|----------|
| | required | measured | required | measured | required | measured |
| 300 | 420.0 ±1 %. | | 250.0 ±1 %. | | 6.35 ±1 %. | |



| | | | | | | |
|------|-------------|------|-------------|------|------------|------|
| 450 | 290.0 ±1 %. | | 166.7 ±1 %. | | 6.35 ±1 %. | |
| 750 | 176.0 ±1 %. | | 100.0 ±1 %. | | 6.35 ±1 %. | |
| 835 | 161.0 ±1 %. | | 89.8 ±1 %. | | 3.6 ±1 %. | |
| 900 | 149.0 ±1 %. | | 83.3 ±1 %. | | 3.6 ±1 %. | |
| 1450 | 89.1 ±1 %. | | 51.7 ±1 %. | | 3.6 ±1 %. | |
| 1500 | 80.5 ±1 %. | | 50.0 ±1 %. | | 3.6 ±1 %. | |
| 1640 | 79.0 ±1 %. | | 45.7 ±1 %. | | 3.6 ±1 %. | |
| 1750 | 75.2 ±1 %. | | 42.9 ±1 %. | | 3.6 ±1 %. | |
| 1800 | 72.0 ±1 %. | | 41.7 ±1 %. | | 3.6 ±1 %. | |
| 1900 | 68.0 ±1 %. | | 39.5 ±1 %. | | 3.6 ±1 %. | |
| 1950 | 66.3 ±1 %. | | 38.5 ±1 %. | | 3.6 ±1 %. | |
| 2000 | 64.5 ±1 %. | | 37.5 ±1 %. | | 3.6 ±1 %. | |
| 2100 | 61.0 ±1 %. | | 35.7 ±1 %. | | 3.6 ±1 %. | |
| 2300 | 55.5 ±1 %. | | 32.6 ±1 %. | | 3.6 ±1 %. | |
| 2450 | 51.5 ±1 %. | PASS | 30.4 ±1 %. | PASS | 3.6 ±1 %. | PASS |
| 2600 | 48.5 ±1 %. | | 28.8 ±1 %. | | 3.6 ±1 %. | |
| 3000 | 41.5 ±1 %. | | 25.0 ±1 %. | | 3.6 ±1 %. | |
| 3500 | 37.0 ±1 %. | | 26.4 ±1 %. | | 3.6 ±1 %. | |
| 3700 | 34.7 ±1 %. | | 26.4 ±1 %. | | 3.6 ±1 %. | |

7 VALIDATION MEASUREMENT

The IEEE Std. 1528, FCC KDBs and CEI/IEC 62209 standards state that the system validation measurements must be performed using a reference dipole meeting the fore mentioned return loss and mechanical dimension requirements. The validation measurement must be performed against a liquid filled flat phantom, with the phantom constructed as outlined in the fore mentioned standards. Per the standards, the dipole shall be positioned below the bottom of the phantom, with the dipole length centered and parallel to the longest dimension of the flat phantom, with the top surface of the dipole at the described distance from the bottom surface of the phantom.

7.1 HEAD LIQUID MEASUREMENT

| Frequency MHz | Relative permittivity (ϵ_r') | | Conductivity (σ) S/m | |
|------------------|---|----------|-------------------------------|----------|
| | required | measured | required | measured |
| 300 | 45.3 ±5 % | | 0.87 ±5 % | |
| 450 | 43.5 ±5 % | | 0.87 ±5 % | |
| 750 | 41.9 ±5 % | | 0.89 ±5 % | |
| 835 | 41.5 ±5 % | | 0.90 ±5 % | |
| 900 | 41.5 ±5 % | | 0.97 ±5 % | |
| 1450 | 40.5 ±5 % | | 1.20 ±5 % | |
| 1500 | 40.4 ±5 % | | 1.23 ±5 % | |
| 1640 | 40.2 ±5 % | | 1.31 ±5 % | |
| 1750 | 40.1 ±5 % | | 1.37 ±5 % | |



| | | | | |
|------|-----------|------|-----------|------|
| 1800 | 40.0 ±5 % | | 1.40 ±5 % | |
| 1900 | 40.0 ±5 % | | 1.40 ±5 % | |
| 1950 | 40.0 ±5 % | | 1.40 ±5 % | |
| 2000 | 40.0 ±5 % | | 1.40 ±5 % | |
| 2100 | 39.8 ±5 % | | 1.49 ±5 % | |
| 2300 | 39.5 ±5 % | | 1.67 ±5 % | |
| 2450 | 39.2 ±5 % | PASS | 1.80 ±5 % | PASS |
| 2600 | 39.0 ±5 % | | 1.96 ±5 % | |
| 3000 | 38.5 ±5 % | | 2.40 ±5 % | |
| 3500 | 37.9 ±5 % | | 2.91 ±5 % | |

7.2 SAR MEASUREMENT RESULT WITH HEAD LIQUID

The IEEE Std. 1528 and CEI/IEC 62209 standards state that the system validation measurements should produce the SAR values shown below (for phantom thickness of 2 mm), within the uncertainty for the system validation. All SAR values are normalized to 1 W forward power. In bracket, the measured SAR is given with the used input power.

| | |
|---|--|
| Software | OPENSAR V4 |
| Phantom | SN 20/09 SAM71 |
| Probe | SN 18/11 EPG122 |
| Liquid | Head Liquid Values: eps' : 38.9 sigma : 1.79 |
| Distance between dipole center and liquid | 10.0 mm |
| Area scan resolution | dx=8mm/dy=8mm |
| Zoon Scan Resolution | dx=5mm/dy=5mm/dz=5mm |
| Frequency | 2450 MHz |
| Input power | 20 dBm |
| Liquid Temperature | 21 °C |
| Lab Temperature | 21 °C |
| Lab Humidity | 45 % |

| Frequency MHz | 1 g SAR (W/kg/W) | | 10 g SAR (W/kg/W) | |
|---------------|------------------|----------|-------------------|----------|
| | required | measured | required | measured |
| 300 | 2.85 | | 1.94 | |
| 450 | 4.58 | | 3.06 | |
| 750 | 8.49 | | 5.55 | |
| 835 | 9.56 | | 6.22 | |
| 900 | 10.9 | | 6.99 | |
| 1450 | 29 | | 16 | |
| 1500 | 30.5 | | 16.8 | |
| 1640 | 34.2 | | 18.4 | |
| 1750 | 36.4 | | 19.3 | |
| 1800 | 38.4 | | 20.1 | |

| | | | | |
|------|------|--------------|------|--------------|
| 1900 | 39.7 | | 20.5 | |
| 1950 | 40.5 | | 20.9 | |
| 2000 | 41.1 | | 21.1 | |
| 2100 | 43.6 | | 21.9 | |
| 2300 | 48.7 | | 23.3 | |
| 2450 | 52.4 | 53.76 (5.38) | 24 | 24.32 (2.43) |
| 2600 | 55.3 | | 24.6 | |
| 3000 | 63.8 | | 25.7 | |
| 3500 | 67.1 | | 25 | |

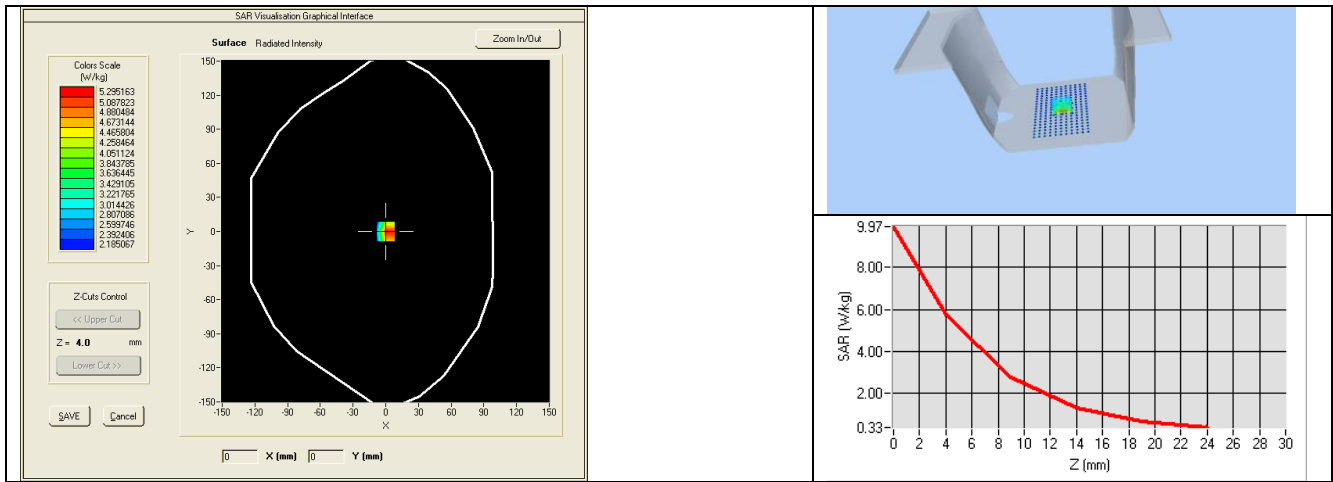

7.3 BODY LIQUID MEASUREMENT

| Frequency MHz | Relative permittivity (ϵ_r') | | Conductivity (σ) S/m | |
|------------------|---|----------|-------------------------------|----------|
| | required | measured | required | measured |
| 150 | 61.9 ± 5 % | | 0.80 ± 5 % | |
| 300 | 58.2 ± 5 % | | 0.92 ± 5 % | |
| 450 | 56.7 ± 5 % | | 0.94 ± 5 % | |
| 750 | 55.5 ± 5 % | | 0.96 ± 5 % | |
| 835 | 55.2 ± 5 % | | 0.97 ± 5 % | |
| 900 | 55.0 ± 5 % | | 1.05 ± 5 % | |
| 915 | 55.0 ± 5 % | | 1.06 ± 5 % | |
| 1450 | 54.0 ± 5 % | | 1.30 ± 5 % | |
| 1610 | 53.8 ± 5 % | | 1.40 ± 5 % | |
| 1800 | 53.3 ± 5 % | | 1.52 ± 5 % | |
| 1900 | 53.3 ± 5 % | | 1.52 ± 5 % | |
| 2000 | 53.3 ± 5 % | | 1.52 ± 5 % | |
| 2100 | 53.2 ± 5 % | | 1.62 ± 5 % | |
| 2450 | 52.7 ± 5 % | PASS | 1.95 ± 5 % | PASS |

| | | | | |
|------|------------|--|------------|--|
| 2600 | 52.5 ±5 % | | 2.16 ±5 % | |
| 3000 | 52.0 ±5 % | | 2.73 ±5 % | |
| 3500 | 51.3 ±5 % | | 3.31 ±5 % | |
| 5200 | 49.0 ±10 % | | 5.30 ±10 % | |
| 5300 | 48.9 ±10 % | | 5.42 ±10 % | |
| 5400 | 48.7 ±10 % | | 5.53 ±10 % | |
| 5500 | 48.6 ±10 % | | 5.65 ±10 % | |
| 5600 | 48.5 ±10 % | | 5.77 ±10 % | |
| 5800 | 48.2 ±10 % | | 6.00 ±10 % | |

7.4 SAR MEASUREMENT RESULT WITH BODY LIQUID

| | |
|---|--|
| Software | OPENSAR V4 |
| Phantom | SN 20/09 SAM71 |
| Probe | SN 18/11 EPG122 |
| Liquid | Body Liquid Values: eps' : 52.7 sigma : 1.94 |
| Distance between dipole center and liquid | 10.0 mm |
| Area scan resolution | dx=8mm/dy=8mm |
| Zoon Scan Resolution | dx=5mm/dy=5mm/dz=5mm |
| Frequency | 2450 MHz |
| Input power | 20 dBm |
| Liquid Temperature | 21 °C |
| Lab Temperature | 21 °C |
| Lab Humidity | 45 % |

| Frequency MHz | 1 g SAR (W/kg/W) | 10 g SAR (W/kg/W) |
|---------------|------------------|-------------------|
| | measured | measured |
| 2450 | 50.33 (5.03) | 23.38 (2.34) |

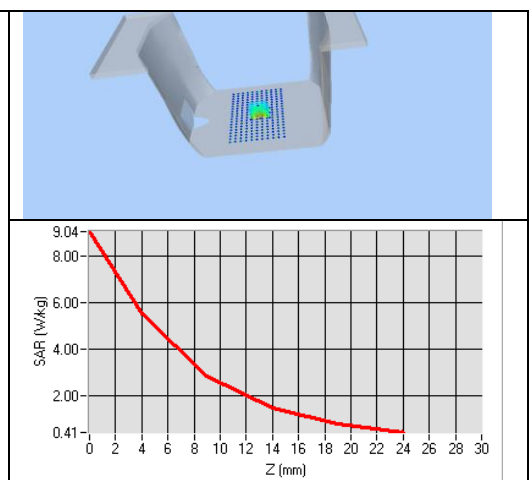
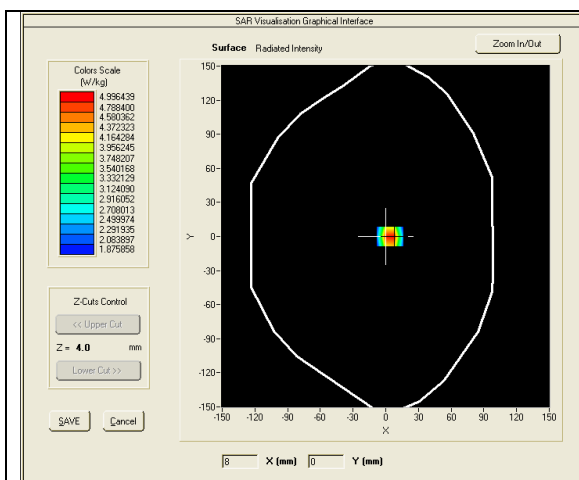



8 LIST OF EQUIPMENT

| Equipment Summary Sheet | | | | |
|---------------------------------|----------------------|--------------------|---|---|
| Equipment Description | Manufacturer / Model | Identification No. | Current Calibration Date | Next Calibration Date |
| SAM Phantom | MVG | SN-20/09-SAM71 | Validated. No cal required. | Validated. No cal required. |
| COMOSAR Test Bench | Version 3 | NA | Validated. No cal required. | Validated. No cal required. |
| Network Analyzer | Rhode & Schwarz ZVA | SN100132 | 02/2019 | 02/2022 |
| Calipers | Carrera | CALIPER-01 | 12/2016 | 12/2019 |
| Reference Probe | MVG | EPG122 SN 18/11 | 10/2018 | 10/2019 |
| Multimeter | Keithley 2000 | 1188656 | 12/2016 | 12/2019 |
| Signal Generator | Agilent E4438C | MY49070581 | 12/2016 | 12/2019 |
| Amplifier | Aethercomm | SN 046 | Characterized prior to test. No cal required. | Characterized prior to test. No cal required. |
| Power Meter | HP E4418A | US38261498 | 12/2016 | 12/2019 |
| Power Sensor | HP ECP-E26A | US37181460 | 12/2016 | 12/2019 |
| Directional Coupler | Narda 4216-20 | 01386 | Characterized prior to test. No cal required. | Characterized prior to test. No cal required. |
| Temperature and Humidity Sensor | Control Company | 11-661-9 | 8/2018 | 8/2021 |



SAR Reference Waveguide Calibration Report

Ref : ACR.240.1.17.SATU.A

**SHENZHEN SEM TEST TECHNOLOGY CO.,
LTD.**

**1/F, BUILDING A, HONGWEI INDUSTRIAL PARK,
LIUXIAN 2ND ROAD BAO'AN DISTRICT SHENZHEN
(518101), CHINA MVG COMOSAR REFERENCE
WAVEGUIDE**

FREQUENCY: 5000-6000 MHZ

SERIAL NO.: SN 49/16 WGA45

Calibrated at MVG US

2105 Barrett Park Dr. - Kennesaw, GA 30144



Calibration Date: 07/15/2019

Summary:

This document presents the method and results from an accredited SAR reference waveguide calibration performed in MVG USA using the COMOSAR test bench. All calibration results are traceable to national metrology institutions.



| | <i>Name</i> | <i>Function</i> | <i>Date</i> | <i>Signature</i> |
|----------------------|---------------|-----------------|-------------|----------------------|
| <i>Prepared by :</i> | Jérôme LUC | Product Manager | 07/15/2019 | <i>JL</i> |
| <i>Checked by :</i> | Jérôme LUC | Product Manager | 07/15/2019 | <i>JL</i> |
| <i>Approved by :</i> | Kim RUTKOWSKI | Quality Manager | 07/15/2019 | <i>Kim Rutkowski</i> |

| | <i>Customer Name</i> |
|-----------------------|--|
| <i>Distribution :</i> | Shenzhen SEM.Test Technology Co., Ltd. |

| <i>Issue</i> | <i>Date</i> | <i>Modifications</i> |
|--------------|-------------|----------------------|
| A | 07/15/2019 | Initial release |
| | | |
| | | |
| | | |



TABLE OF CONTENTS

1 Introduction..... 4

2 Device Under Test 4

3 Product Description 4

 3.1 General Information 4

4 Measurement Method 4

 4.1 Return Loss Requirements 4

 4.2 Mechanical Requirements 4

5 Measurement Uncertainty 5

 5.1 Return Loss 5

 5.2 Dimension Measurement 5

 5.3 Validation Measurement 5

6 Calibration Measurement Results 5

 6.1 Return Loss 5

 6.2 Mechanical Dimensions 6

7 Validation measurement 7

 7.1 Head Liquid Measurement 7

 7.2 Measurement Result 7

 7.3 Body Measurement Result 10

8 List of Equipment 13



1 INTRODUCTION

This document contains a summary of the requirements set forth by the IEEE 1528 and CEI/IEC 62209 standards for reference waveguides used for SAR measurement system validations and the measurements that were performed to verify that the product complies with the fore mentioned standards.

2 DEVICE UNDER TEST

| Device Under Test | |
|--------------------------------|---|
| Device Type | COMOSAR 5000-6000 MHz REFERENCE WAVEGUIDE |
| Manufacturer | MVG |
| Model | SWG5500 |
| Serial Number | SN 49/16 WGA45 |
| Product Condition (new / used) | New |

A yearly calibration interval is recommended.

3 PRODUCT DESCRIPTION

3.1 GENERAL INFORMATION

MVG's COMOSAR Validation Waveguides are built in accordance to the IEEE 1528 and CEI/IEC 62209 standards.

4 MEASUREMENT METHOD

The IEEE 1528 and CEI/IEC 62209 standards provide requirements for reference waveguides used for system validation measurements. The following measurements were performed to verify that the product complies with the fore mentioned standards.

4.1 RETURN LOSS REQUIREMENTS

The waveguide used for SAR system validation measurements and checks must have a return loss of -8 dB or better. The return loss measurement shall be performed with matching layer placed in the open end of the waveguide, with the waveguide and matching layer in direct contact with the phantom shell as outlined in the fore mentioned standards.

4.2 MECHANICAL REQUIREMENTS

The IEEE 1528 and CEI/IEC 62209 standards specify the mechanical dimensions of the validation waveguide, the specified dimensions are as shown in Section 6.2. Figure 1 shows how the dimensions relate to the physical construction of the waveguide.

5 MEASUREMENT UNCERTAINTY

All uncertainties listed below represent an expanded uncertainty expressed at approximately the 95% confidence level using a coverage factor of $k=2$, traceable to the Internationally Accepted Guides to Measurement Uncertainty.

5.1 RETURN LOSS

The following uncertainties apply to the return loss measurement:

| Frequency band | Expanded Uncertainty on Return Loss |
|----------------|-------------------------------------|
| 400-6000MHz | 0.1 dB |

5.2 DIMENSION MEASUREMENT

The following uncertainties apply to the dimension measurements:

| Length (mm) | Expanded Uncertainty on Length |
|-------------|--------------------------------|
| 3 - 300 | 0.05 mm |

5.3 VALIDATION MEASUREMENT

The guidelines outlined in the IEEE 1528 and CEI/IEC 62209 standards were followed to generate the measurement uncertainty for validation measurements.

| Scan Volume | Expanded Uncertainty |
|-------------|----------------------|
| 1 g | 20.3 % |
| 10 g | 20.1 % |

6 CALIBRATION MEASUREMENT RESULTS

6.1 RETURN LOSS IN HEAD LIQUID

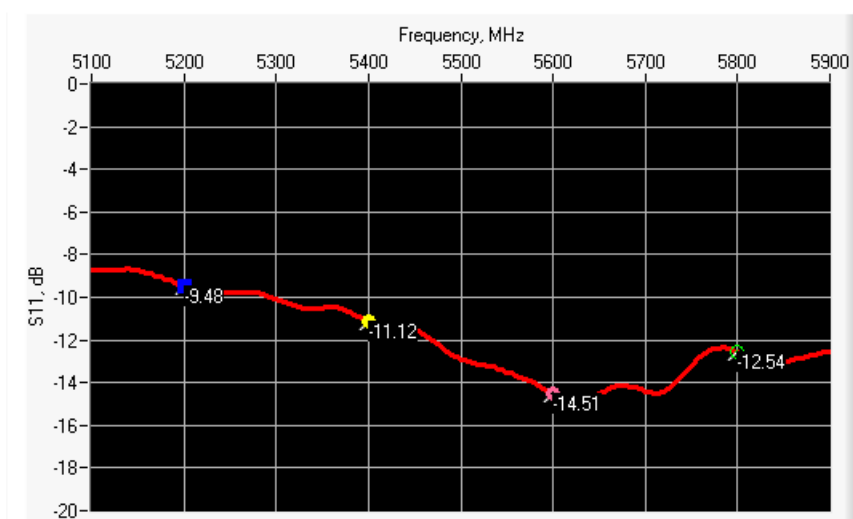

| Frequency (MHz) | Return Loss (dB) | Requirement (dB) | Impedance |
|-----------------|------------------|------------------|-----------------------------------|
| 5200 | -9.48 | -8 | 21.44 Ω + 11.06 j Ω |
| 5400 | -11.12 | -8 | 75.61 Ω + 3.31 j Ω |
| 5600 | -14.51 | -8 | 34.43 Ω - 9.61 j Ω |
| 5800 | -12.54 | -8 | 53.85 Ω + 22.57 j Ω |

6.2 RETURN LOSS IN BODY LIQUID

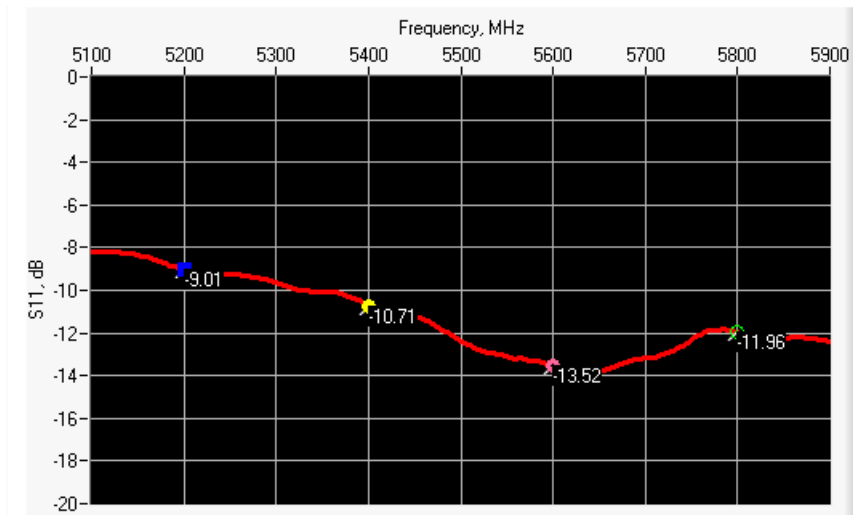

| Frequency (MHz) | Return Loss (dB) | Requirement (dB) | Impedance |
|-----------------|------------------|------------------|-----------------------------------|
| 5200 | -9.01 | -8 | 21.02 Ω + 14.13 j Ω |
| 5400 | -10.71 | -8 | 76.84 Ω - 0.83 j Ω |
| 5600 | -13.52 | -8 | 31.10 Ω - 7.33 j Ω |
| 5800 | -11.96 | -8 | 58.01 Ω + 22.90 j Ω |

6.3 MECHANICAL DIMENSIONS

| Frequency (MHz) | L (mm) | | W (mm) | | L _r (mm) | | W _r (mm) | | T (mm) | |
|-----------------|--------------|----------|--------------|----------|---------------------|----------|---------------------|----------|----------|----------|
| | Required | Measured | Required | Measured | Required | Measured | Required | Measured | Required | Measured |
| 5200 | 40.39 ± 0.13 | PASS | 20.19 ± 0.13 | PASS | 81.03 ± 0.13 | PASS | 61.98 ± 0.13 | PASS | 5.3* | PASS |
| 5800 | 40.39 ± 0.13 | PASS | 20.19 ± 0.13 | PASS | 81.03 ± 0.13 | PASS | 61.98 ± 0.13 | PASS | 4.3* | PASS |

* The tolerance for the matching layer is included in the return loss measurement.

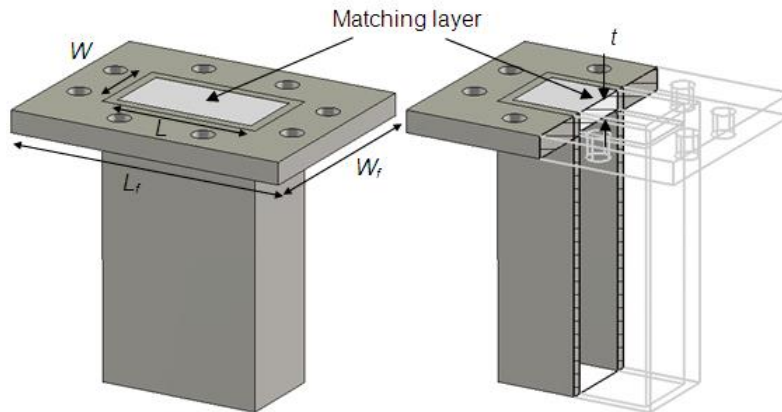

Figure 1: Validation Waveguide Dimensions

7 VALIDATION MEASUREMENT

The IEEE Std. 1528 and CEI/IEC 62209 standards state that the system validation measurements must be performed using a reference waveguide meeting the fore mentioned return loss and mechanical dimension requirements. The validation measurement must be performed with the matching layer placed in the open end of the waveguide, with the waveguide and matching layer in direct contact with the phantom shell.

7.1 HEAD LIQUID MEASUREMENT

| Frequency MHz | Relative permittivity (ϵ_r') | | Conductivity (σ) S/m | |
|------------------|---|----------|-------------------------------|----------|
| | required | measured | required | measured |
| 5000 | 36.2 \pm 10 % | | 4.45 \pm 10 % | |
| 5100 | 36.1 \pm 10 % | | 4.56 \pm 10 % | |
| 5200 | 36.0 \pm 10 % | PASS | 4.66 \pm 10 % | PASS |
| 5300 | 35.9 \pm 10 % | | 4.76 \pm 10 % | |
| 5400 | 35.8 \pm 10 % | PASS | 4.86 \pm 10 % | PASS |
| 5500 | 35.6 \pm 10 % | | 4.97 \pm 10 % | |
| 5600 | 35.5 \pm 10 % | PASS | 5.07 \pm 10 % | PASS |
| 5700 | 35.4 \pm 10 % | | 5.17 \pm 10 % | |
| 5800 | 35.3 \pm 10 % | PASS | 5.27 \pm 10 % | PASS |
| 5900 | 35.2 \pm 10 % | | 5.38 \pm 10 % | |
| 6000 | 35.1 \pm 10 % | | 5.48 \pm 10 % | |

7.2 SAR MEASUREMENT RESULT WITH HEAD LIQUID

At those frequencies, the target SAR value can not be generic. Hereunder is the target SAR value defined by MVG, within the uncertainty for the system validation. All SAR values are normalized to 1 W net power. In bracket, the measured SAR is given with the used input power.

| | |
|--|--|
| Software | OPENSAR V4 |
| Phantom | SN 20/09 SAM71 |
| Probe | SN 18/11 EPG122 |
| Liquid | Head Liquid Values 5200 MHz: eps' :35.14 sigma : 4.74 Head Liquid Values 5400 MHz: eps' :34.52 sigma : 4.77 Head Liquid Values 5600 MHz: eps' :37.08 sigma : 5.03 Head Liquid Values 5800 MHz: eps' :34.64 sigma : 5.19 |
| Distance between dipole waveguide and liquid | 0 mm |
| Area scan resolution | dx=8mm/dy=8mm |
| Zoon Scan Resolution | dx=4mm/dy=4m/dz=2mm |
| Frequency | 5200 MHz 5400 MHz 5600 MHz 5800 MHz |
| Input power | 20 dBm |
| Liquid Temperature | 21 °C |
| Lab Temperature | 21 °C |
| Lab Humidity | 45 % |

| Frequency (MHz) | 1 g SAR (W/kg) | | 10 g SAR (W/kg) | |
|-----------------|----------------|----------------|-----------------|--------------|
| | required | measured | required | measured |
| 5200 | 159.00 | 161.23 (16.12) | 56.90 | 56.14 (5.61) |
| 5400 | 166.40 | 165.58 (16.56) | 58.43 | 57.15 (5.71) |
| 5600 | 173.80 | 173.58 (17.36) | 59.97 | 59.52 (5.95) |
| 5800 | 181.20 | 179.32 (17.93) | 61.50 | 61.13 (6.11) |

SAR MEASUREMENT PLOTS @ 5200 MHz

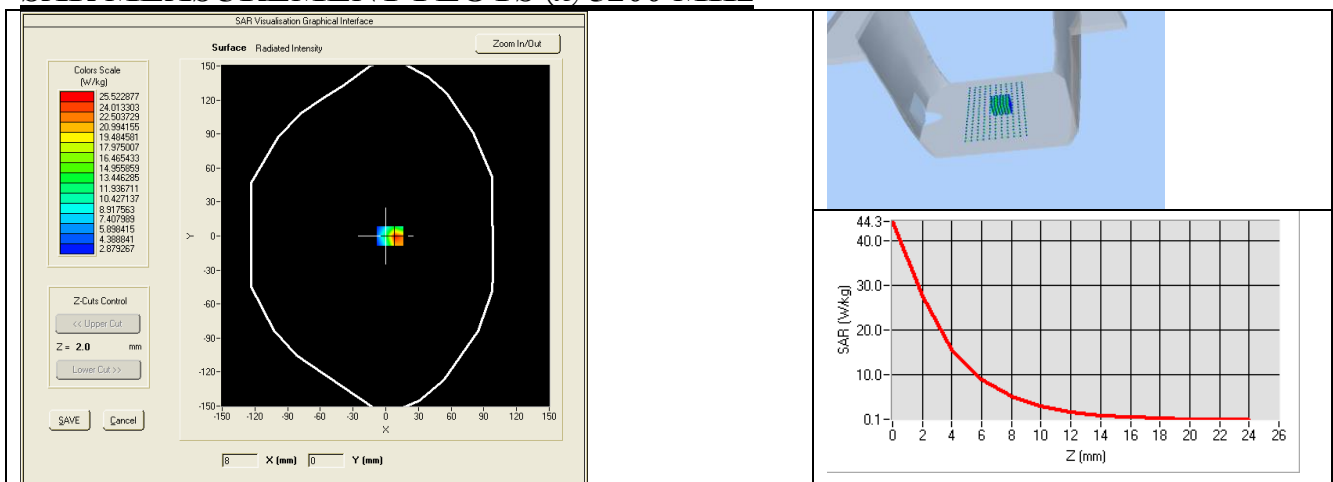

SAR MEASUREMENT PLOTS @ 5400 MHz

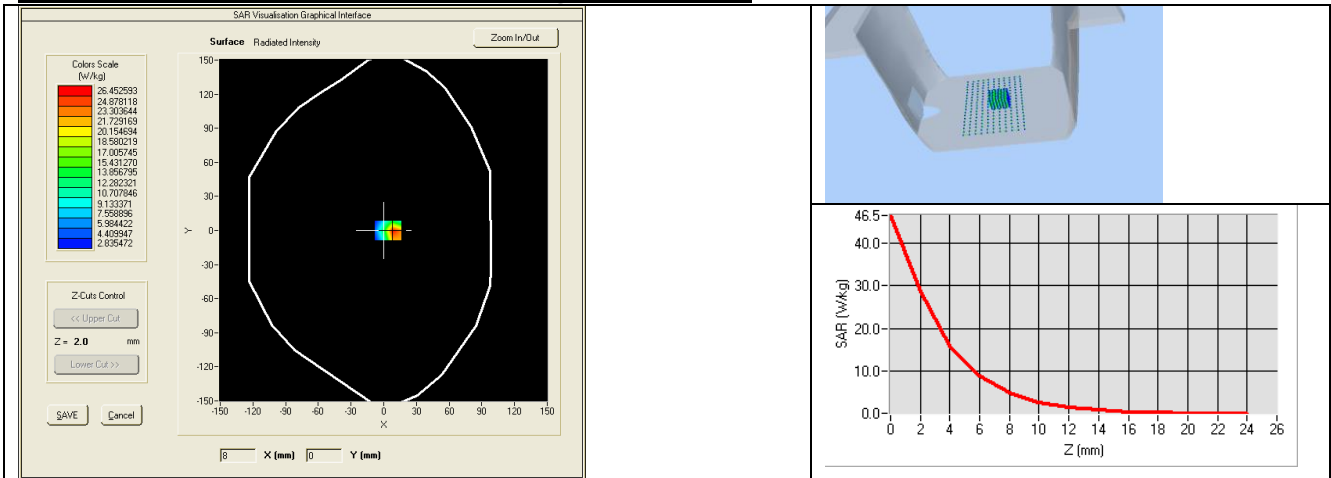

SAR MEASUREMENT PLOTS @ 5600 MHz

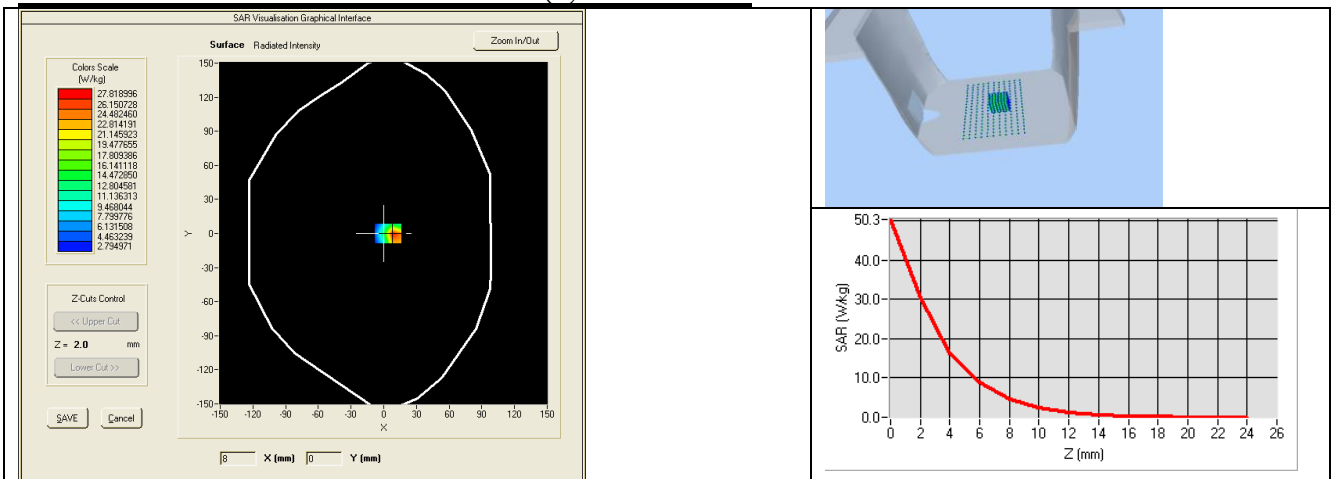

SAR MEASUREMENT PLOTS @ 5800 MHz

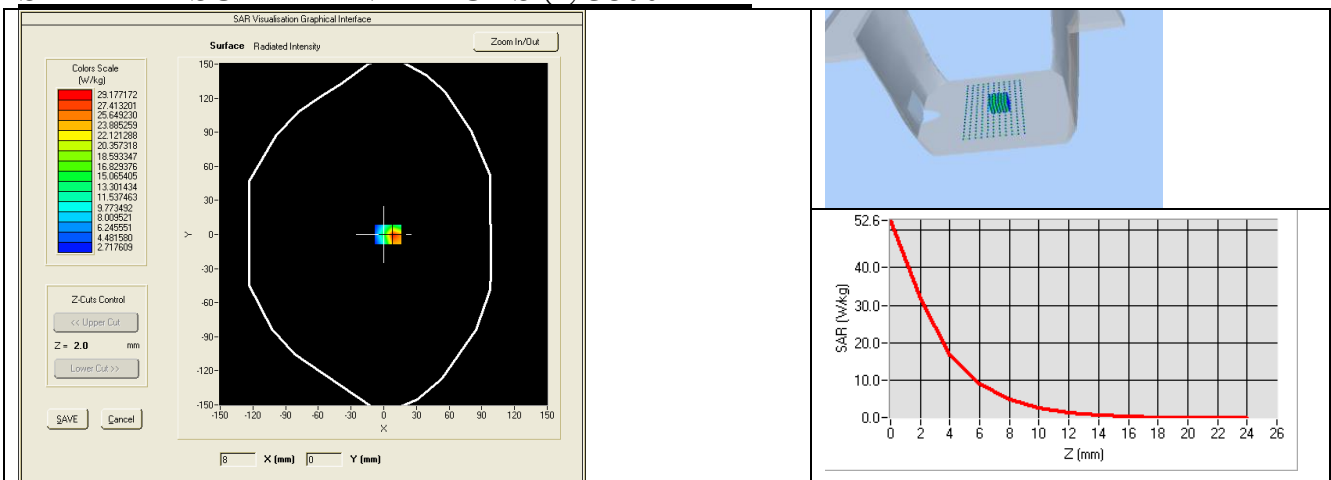

7.3 BODY LIQUID MEASUREMENT

| Frequency MHz | Relative permittivity (ϵ_r') | | Conductivity (σ) S/m | |
|------------------|---|----------|-------------------------------|----------|
| | required | measured | required | measured |
| 5200 | 49.0 ±10 % | PASS | 5.30 ±10 % | PASS |
| 5400 | 48.7 ±10 % | PASS | 5.53 ±10 % | PASS |
| 5600 | 48.5 ±10 % | PASS | 5.77 ±10 % | PASS |
| 5800 | 48.2 ±10 % | PASS | 6.00 ±10 % | PASS |

7.4 SAR MEASUREMENT RESULT WITH BODY LIQUID

| | |
|--|--|
| Software | OPENSAR V4 |
| Phantom | SN 20/09 SAM71 |
| Probe | SN 18/11 EPG122 |
| Liquid | Body Liquid Values 5200 MHz: ϵ_r' :49.01 sigma : 5.27 Body Liquid Values 5400 MHz: ϵ_r' :49.67 sigma : 5.45 Body Liquid Values 5600 MHz: ϵ_r' :47.57 sigma : 5.69 Body Liquid Values 5800 MHz: ϵ_r' :49.82 sigma : 5.94 |
| Distance between dipole waveguide and liquid | 0 mm |
| Area scan resolution | dx=8mm/dy=8mm |
| Zoon Scan Resolution | dx=4mm/dy=4m/dz=2mm |
| Frequency | 5200 MHz 5400 MHz 5600 MHz 5800 MHz |
| Input power | 20 dBm |
| Liquid Temperature | 21 °C |
| Lab Temperature | 21 °C |
| Lab Humidity | 45 % |

| Frequency (MHz) | 1 g SAR (W/kg) measured | 10 g SAR (W/kg) measured |
|-----------------|----------------------------|-----------------------------|
| 5200 | 154.45 (15.45) | 55.01 (5.50) |
| 5400 | 163.31 (16.33) | 57.57 (5.76) |
| 5600 | 165.72 (16.57) | 57.93 (5.79) |
| 5800 | 170.71 (17.07) | 59.17 (5.92) |

BODY SAR MEASUREMENT PLOTS @ 5200 MHz

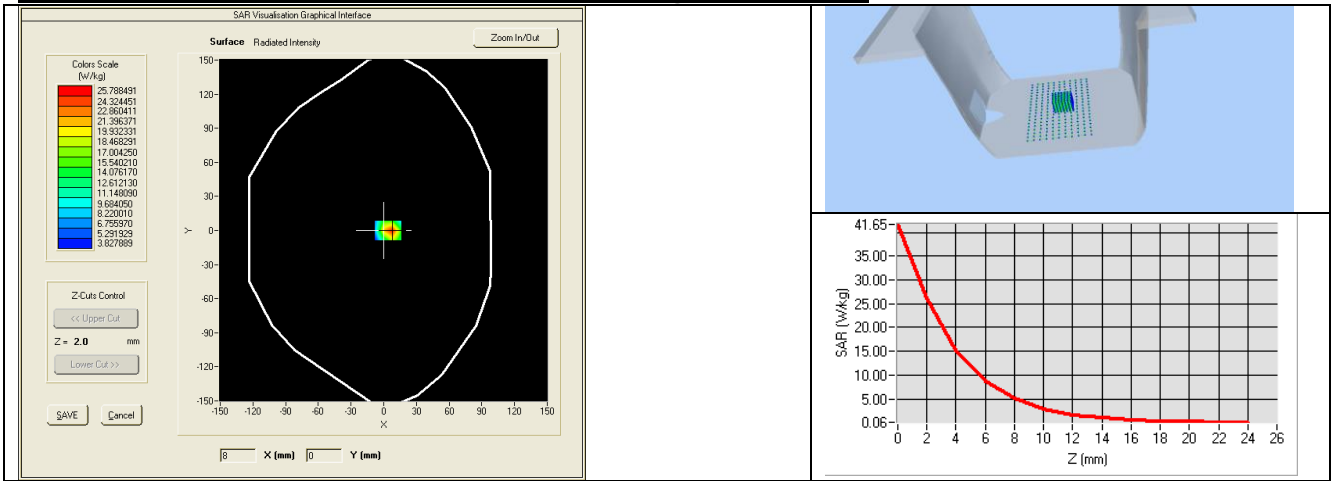

BODY SAR MEASUREMENT PLOTS @ 5400 MHz

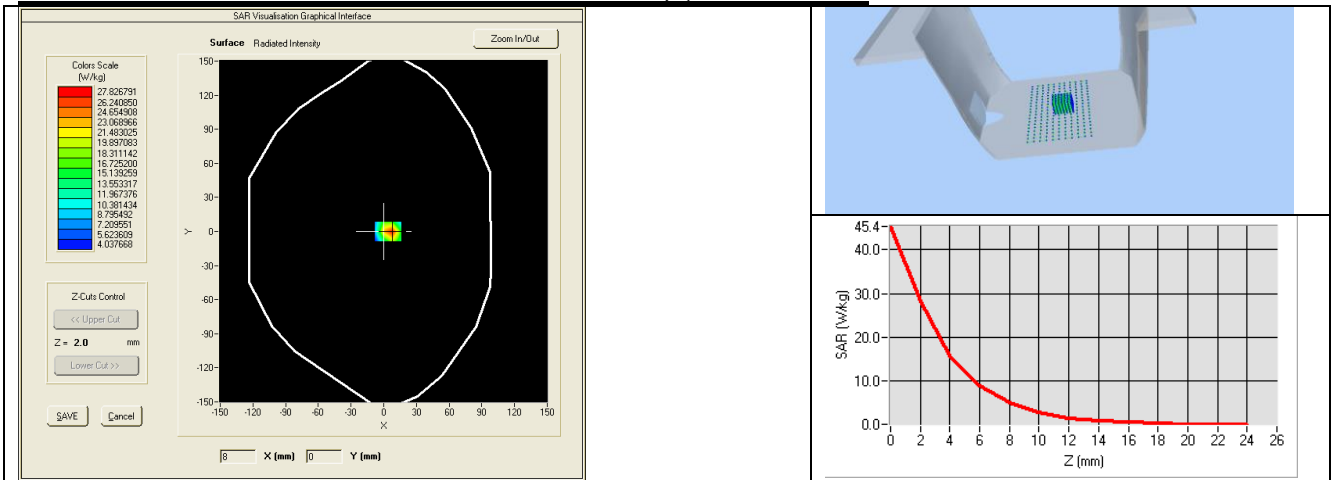

BODY SAR MEASUREMENT PLOTS @ 5600 MHz

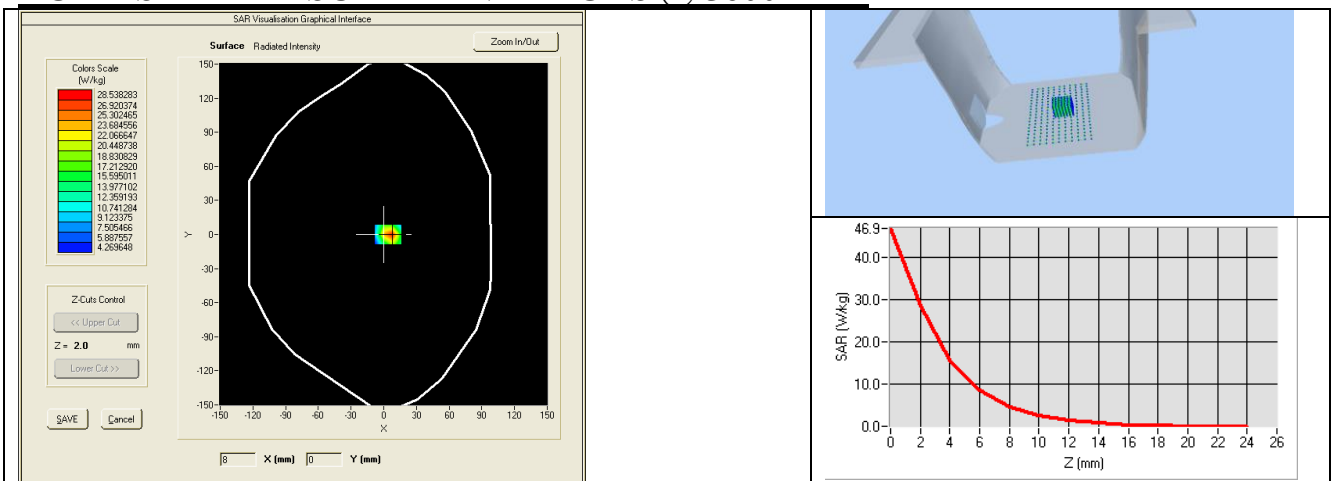

BODY SAR MEASUREMENT PLOTS @ 5800 MHz

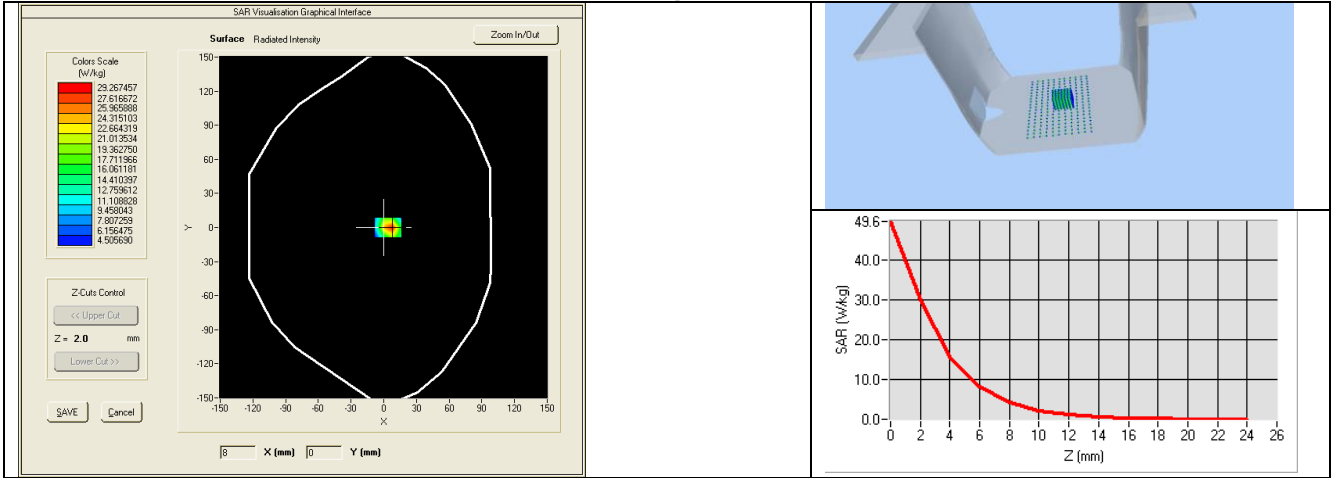



8 LIST OF EQUIPMENT

| Equipment Summary Sheet | | | | |
|---------------------------------|----------------------|--------------------|---|---|
| Equipment Description | Manufacturer / Model | Identification No. | Current Calibration Date | Next Calibration Date |
| Flat Phantom | MVG | SN-20/09-SAM71 | Validated. No cal required. | Validated. No cal required. |
| COMOSAR Test Bench | Version 3 | NA | Validated. No cal required. | Validated. No cal required. |
| Network Analyzer | Rhode & Schwarz ZVA | SN100132 | 02/2019 | 02/2022 |
| Calipers | Carrera | CALIPER-01 | 01/2017 | 01/2020 |
| Reference Probe | MVG | EPG122 SN 18/11 | 10/2019 | 10/2020 |
| Multimeter | Keithley 2000 | 1188656 | 01/2017 | 01/2020 |
| Signal Generator | Agilent E4438C | MY49070581 | 01/2017 | 01/2020 |
| Amplifier | Aethercomm | SN 046 | Characterized prior to test. No cal required. | Characterized prior to test. No cal required. |
| Power Meter | HP E4418A | US38261498 | 01/2017 | 01/2020 |
| Power Sensor | HP ECP-E26A | US37181460 | 01/2017 | 01/2020 |
| Directional Coupler | Narda 4216-20 | 01386 | Characterized prior to test. No cal required. | Characterized prior to test. No cal required. |
| Temperature and Humidity Sensor | Control Company | 150798832 | 10/2019 | 10/2021 |