



Shenzhen CTA Testing Technology Co., Ltd.

Room 106, Building 1, Yibaolai Industrial Park, Qiaotou Community, Fuhai Street, Bao'an District, Shenzhen, China

FCC PART 15 SUBPART C TEST REPORT

FCC PART 15.247

Report Reference No......: **CTA22111100101**

FCC ID..... : **2APU9-HRD-787**

Compiled by
(position+printed name+signature)...: File administrators Zoey Cao

Zoey Cao

Supervised by
(position+printed name+signature)...: Project Engineer Amy Wen



Approved by
(position+printed name+signature)...: RF Manager Eric Wang

Eric Wang
approved

Date of issue.....: Nov. 18, 2022

Testing Laboratory Name: **Shenzhen CTA Testing Technology Co., Ltd.**

Address.....: Room 106, Building 1, Yibaolai Industrial Park, Qiaotou Community, Fuhai Street, Bao'an District, Shenzhen, China

Applicant's name: **Shenzhen Hanrongda Electronic Co., Ltd.**

Address: No.21, LiYuan Xia, XinLi Road, PingHu Town, LongGang District Shenzhen, China

Test specification

Standard: **FCC Part 15.247**

Shenzhen CTA Testing Technology Co., Ltd. All rights reserved.

This publication may be reproduced in whole or in part for non-commercial purposes as long as the Shenzhen CTA Testing Technology Co., Ltd. is acknowledged as copyright owner and source of the material. Shenzhen CTA Testing Technology Co., Ltd. takes no responsibility for and will not assume liability for damages resulting from the reader's interpretation of the reproduced material due to its placement and context.

Equipment description.....: **Multi Band Radio Bluetooth TF Card Player Flashlight SOS Alarm APP Remote Control**

Trade Mark: N/A

Manufacturer: **Shenzhen Hanrongda Electronic Co., Ltd.**

Model/Type reference.....: HRD-787

Listed Models: ZWS-787

Modulation: GFSK

Frequency..... From 2402MHz to 2480MHz

Ratings: DC 3.7V From Battery and DC 5.0V From external circuit

Result.....: **PASS**

Shenzhen CTA Testing Technology Co., Ltd.

Room 106, Building 1, Yibaolai Industrial Park, Qiaotou Community, Fuhai Street, Bao'an District, Shenzhen, China
Tel:+86-755 2322 5875 E-mail:cta@cta-test.cn Web:http://www.cta-test.cn

TEST REPORT

Equipment under Test : Multi Band Radio Bluetooth TF Card Player Flashlight SOS Alarm
APP Remote Control

Model /Type : HRD-787

Listed Models : ZWS-787

Applicant : **Shenzhen Hanrongda Electronic Co., Ltd.**

Address : No.21, LiYuan Xia, XinLi Road, PingHu Town, LongGang District
Shenzhen, China

Manufacturer : **Shenzhen Hanrongda Electronic Co., Ltd.**

Address : No.21, LiYuan Xia, XinLi Road, PingHu Town, LongGang District
Shenzhen, China

Test Result:	PASS
---------------------	-------------

The test report merely corresponds to the test sample.

It is not permitted to copy extracts of these test result without the written permission of the test laboratory.

Contents

1	<u>TEST STANDARDS</u>	4
2	<u>SUMMARY</u>	5
2.1	General Remarks	5
2.2	Product Description	5
2.3	Equipment Under Test	5
2.4	Short description of the Equipment under Test (EUT)	5
2.5	EUT operation mode	6
2.6	Block Diagram of Test Setup	6
2.7	Related Submittal(s) / Grant (s)	6
2.8	Modifications	6
3	<u>TEST ENVIRONMENT</u>	7
3.1	Address of the test laboratory	7
3.2	Test Facility	7
3.3	Environmental conditions	7
3.4	Summary of measurement results	8
3.5	Statement of the measurement uncertainty	8
3.6	Equipments Used during the Test	9
4	<u>TEST CONDITIONS AND RESULTS</u>	10
4.1	AC Power Conducted Emission	10
4.2	Radiated Emissions and Band Edge	13
4.3	Maximum Peak Output Power	20
4.4	Power Spectral Density	21
4.5	6dB Bandwidth	23
4.6	Out-of-band Emissions	25
4.7	Antenna Requirement	29
5	<u>TEST SETUP PHOTOS OF THE EUT</u>	30
6	<u>PHOTOS OF THE EUT</u>	31

1 TEST STANDARDS

The tests were performed according to following standards:

[FCC Rules Part 15.247](#): Frequency Hopping, Direct Spread Spectrum and Hybrid Systems that are in operation within the bands of 902-928 MHz, 2400-2483.5 MHz, and 5725-5850 MHz.

[ANSI C63.10-2013](#): American National Standard for Testing Unlicensed Wireless Devices

[KDB558074 D01 V05r02](#): Guidance for Performing Compliance Measurements on Digital Transmission Systems (DTS) Operating Under §15.247

2 SUMMARY

2.1 General Remarks

Date of receipt of test sample	:	Nov. 11, 2022
Testing commenced on	:	Nov. 11, 2022
Testing concluded on	:	Nov. 18, 2022

2.2 Product Description

Product Description:	Multi Band Radio Bluetooth TF Card Player Flashlight SOS Alarm APP Remote Control
Model/Type reference:	HRD-787
Power supply:	DC 3.7V From Battery and DC 5.0V From external circuit
Adapter information (Auxiliary test supplied by test Lab) :	Model: EP-TA20CBC Input: AC 100-240V 50/60Hz Output: DC 5V 2A
Hardware version:	V1.0
Software version:	V1.0
Testing sample ID:	CTA221111001-1# (Engineer sample) CTA221111001-2# (Normal sample)
Bluetooth BLE	
Supported type:	Bluetooth low Energy
Modulation:	GFSK
Operation frequency:	2402MHz to 2480MHz
Channel number:	40
Channel separation:	2 MHz
Antenna type:	PCB antenna
Antenna gain:	1.94 dBi

2.3 Equipment Under Test

Power supply system utilised

Power supply voltage	:	<input type="radio"/> 230V / 50 Hz	<input type="radio"/> 120V / 60Hz
		<input type="radio"/> 12 V DC	<input type="radio"/> 24 V DC
		<input checked="" type="radio"/> Other (specified in blank below)	

DC 3.7V From Battery and DC 5.0V From external circuit

2.4 Short description of the Equipment under Test (EUT)

This is a Multi Band Radio Bluetooth TF Card Player Flashlight SOS Alarm APP Remote Control.
For more details, refer to the user's manual of the EUT.

2.5 EUT operation mode

The Applicant provides communication tools software(Engineer mode) to control the EUT for staying in continuous transmitting (Duty Cycle more than 98%) and receiving mode for testing .There are 40 channels provided to the EUT and Channel 00/19/39 were selected to test.

Operation Frequency:

Channel	Frequency (MHz)
00	2402
01	2404
02	2406
⋮	⋮
19	2440
⋮	⋮
37	2476
38	2478
39	2480

2.6 Block Diagram of Test Setup

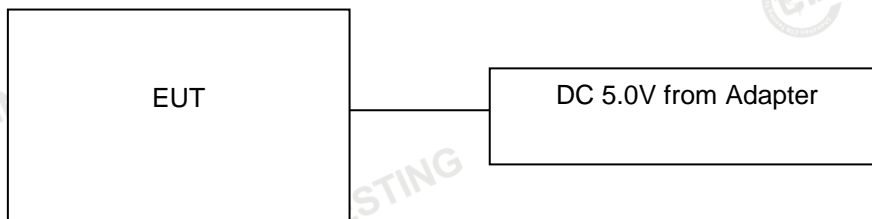

2.7 Related Submittal(s) / Grant (s)

This submittal(s) (test report) is intended for the device filing to comply with Section 15.247 of the FCC Part 15, Subpart C Rules.

2.8 Modifications

No modifications were implemented to meet testing criteria.

3 TEST ENVIRONMENT

3.1 Address of the test laboratory

Shenzhen CTA Testing Technology Co., Ltd.

Room 106, Building 1, Yibaolai Industrial Park, Qiaotou Community, Fuhai Street, Bao'an District, Shenzhen, China

3.2 Test Facility

The test facility is recognized, certified, or accredited by the following organizations:

FCC-Registration No.: 517856 Designation Number: CN1318

Shenzhen CTA Testing Technology Co., Ltd. has been listed on the US Federal Communications Commission list of test facilities recognized to perform electromagnetic emissions measurements.

A2LA-Lab Cert. No.: 6534.01

Shenzhen CTA Testing Technology Co., Ltd. has been listed by American Association for Laboratory Accreditation to perform electromagnetic emission measurement.

The 3m-Semi anechoic test site fulfils CISPR 16-1-4 according to ANSI C63.10 and CISPR 16-1-4:2010.

3.3 Environmental conditions

During the measurement the environmental conditions were within the listed ranges:

Radiated Emission:

Temperature:	23 ° C
Humidity:	44 %
Atmospheric pressure:	950-1050mbar

AC Main Conducted testing:

Temperature:	24 ° C
Humidity:	47 %
Atmospheric pressure:	950-1050mbar

Conducted testing:

Temperature:	24 ° C
Humidity:	46 %
Atmospheric pressure:	950-1050mbar

Shenzhen CTA Testing Technology Co., Ltd.

Room 106, Building 1, Yibaolai Industrial Park, Qiaotou Community, Fuhai Street, Bao'an District, Shenzhen, China

Tel:+86-755 2322 5875 E-mail:cta@cta-test.cn Web:http://www.cta-test.cn

3.4 Summary of measurement results

Test Specification clause	Test case	Test Mode	Test Channel	Recorded In Report		Test result
§15.247(e)	Power spectral density	BLE 1Mbps	<input checked="" type="checkbox"/> Lowest <input checked="" type="checkbox"/> Middle <input checked="" type="checkbox"/> Highest	BLE 1Mbps	<input checked="" type="checkbox"/> Lowest <input checked="" type="checkbox"/> Middle <input checked="" type="checkbox"/> Highest	complies
§15.247(a)(2)	Spectrum bandwidth – 6 dB bandwidth	BLE 1Mbps	<input checked="" type="checkbox"/> Lowest <input checked="" type="checkbox"/> Middle <input checked="" type="checkbox"/> Highest	BLE 1Mbps	<input checked="" type="checkbox"/> Lowest <input checked="" type="checkbox"/> Middle <input checked="" type="checkbox"/> Highest	complies
§15.247(b)(3)	Maximum output Peak power	BLE 1Mbps	<input checked="" type="checkbox"/> Lowest <input checked="" type="checkbox"/> Middle <input checked="" type="checkbox"/> Highest	BLE 1Mbps	<input checked="" type="checkbox"/> Lowest <input checked="" type="checkbox"/> Middle <input checked="" type="checkbox"/> Highest	complies
§15.247(d)	Band edge compliance conducted	BLE 1Mbps	<input checked="" type="checkbox"/> Lowest <input checked="" type="checkbox"/> Highest	BLE 1Mbps	<input checked="" type="checkbox"/> Lowest <input checked="" type="checkbox"/> Highest	complies
§15.205	Band edge compliance radiated	BLE 1Mbps	<input checked="" type="checkbox"/> Lowest <input checked="" type="checkbox"/> Highest	BLE 1Mbps	<input checked="" type="checkbox"/> Lowest <input checked="" type="checkbox"/> Highest	complies
§15.247(d)	TX spurious emissions conducted	BLE 1Mbps	<input checked="" type="checkbox"/> Lowest <input checked="" type="checkbox"/> Middle <input checked="" type="checkbox"/> Highest	BLE 1Mbps	<input checked="" type="checkbox"/> Lowest <input checked="" type="checkbox"/> Middle <input checked="" type="checkbox"/> Highest	complies
§15.247(d)	TX spurious emissions radiated	BLE 1Mbps	<input checked="" type="checkbox"/> Lowest <input checked="" type="checkbox"/> Middle <input checked="" type="checkbox"/> Highest	BLE 1Mbps	<input checked="" type="checkbox"/> Lowest <input checked="" type="checkbox"/> Middle <input checked="" type="checkbox"/> Highest	complies
§15.209(a)	TX spurious Emissions radiated Below 1GHz	BLE 1Mbps	-/-	BLE 1Mbps	-/-	complies
§15.107(a) §15.207	Conducted Emissions < 30 MHz	BLE 1Mbps	-/-	BLE 1Mbps	-/-	complies

Remark:

1. The measurement uncertainty is not included in the test result.
2. We tested all test mode and recorded worst case in report

3.5 Statement of the measurement uncertainty

The data and results referenced in this document are true and accurate. The reader is cautioned that there may be errors within the calibration limits of the equipment and facilities. The measurement uncertainty was calculated for all measurements listed in this test report acc. to TR-100028-01 "Electromagnetic compatibility and Radio spectrum Matters (ERM);Uncertainties in the measurement of mobile radio equipment characteristics; Part 1" and TR-100028-02 "Electromagnetic compatibility and Radio spectrum Matters (ERM);Uncertainties in the measurement of mobile radio equipment characteristics; Part 2 " and is documented in the Shenzhen CTA Testing Technology Co., Ltd. quality system acc. to DIN EN ISO/IEC 17025. Furthermore, component and process variability of devices similar to that tested may result in additional deviation. The manufacturer has the sole responsibility of continued compliance of the device.

Hereafter the best measurement capability for Shenzhen CTA Testing Technology Co., Ltd. :

Test	Range	Measurement Uncertainty	Notes
Radiated Emission	30~1000MHz	4.06 dB	(1)
Radiated Emission	1~18GHz	5.14 dB	(1)
Radiated Emission	18~40GHz	5.38 dB	(1)
Conducted Disturbance	0.15~30MHz	2.14 dB	(1)

- (1) This uncertainty represents an expanded uncertainty expressed at approximately the 95% confidence level using a coverage factor of k=2.

Shenzhen CTA Testing Technology Co., Ltd.

Room 106, Building 1, Yibaolai Industrial Park, Qiaotou Community, Fuhai Street, Bao'an District, Shenzhen, China
Tel:+86-755 2322 5875 E-mail:cta@cta-test.cn Web:http://www.cta-test.cn

3.6 Equipments Used during the Test

Test Equipment	Manufacturer	Model No.	Equipment No.	Calibration Date	Calibration Due Date
LISN	R&S	ENV216	CTA-308	2022/08/03	2023/08/02
LISN	R&S	ENV216	CTA-314	2022/08/03	2023/08/02
EMI Test Receiver	R&S	ESPI	CTA-307	2022/08/03	2023/08/02
EMI Test Receiver	R&S	ESCI	CTA-306	2022/08/03	2023/08/02
Spectrum Analyzer	Agilent	N9020A	CTA-301	2022/08/03	2023/08/02
Spectrum Analyzer	R&S	FSP	CTA-337	2022/08/03	2023/08/02
Vector Signal generator	Agilent	N5182A	CTA-305	2022/08/03	2023/08/02
Analog Signal Generator	R&S	SML03	CTA-304	2022/08/03	2023/08/02
Universal Radio Communication	CMW500	R&S	CTA-302	2022/08/03	2023/08/02
Temperature and humidity meter	Chigo	ZG-7020	CTA-326	2022/08/03	2023/08/02
Ultra-Broadband Antenna	Schwarzbeck	VULB9163	CTA-310	2021/08/07	2024/08/06
Horn Antenna	Schwarzbeck	BBHA 9120D	CTA-309	2021/08/07	2024/08/06
Loop Antenna	Zhinan	ZN30900C	CTA-311	2021/08/07	2024/08/06
Horn Antenna	Beijing Hangwei Dayang	OBH100400	CTA-336	2021/08/07	2024/08/06
Amplifier	Schwarzbeck	BBV 9745	CTA-312	2022/08/03	2023/08/02
Amplifier	Taiwan chengyi	EMC051845B	CTA-313	2022/08/03	2023/08/02
Directional coupler	NARDA	4226-10	CTA-303	2022/08/03	2023/08/02
High-Pass Filter	XingBo	XBLBQ-GTA18	CTA-402	2022/08/03	2023/08/02
High-Pass Filter	XingBo	XBLBQ-GTA27	CTA-403	2022/08/03	2023/08/02
Automated filter bank	Tonscend	JS0806-F	CTA-404	2022/08/03	2023/08/02
Power Sensor	Agilent	U2021XA	CTA-405	2022/08/03	2023/08/02
Amplifier	Schwarzbeck	BBV9719	CTA-406	2022/08/03	2023/08/02

4 TEST CONDITIONS AND RESULTS

4.1 AC Power Conducted Emission

TEST CONFIGURATION

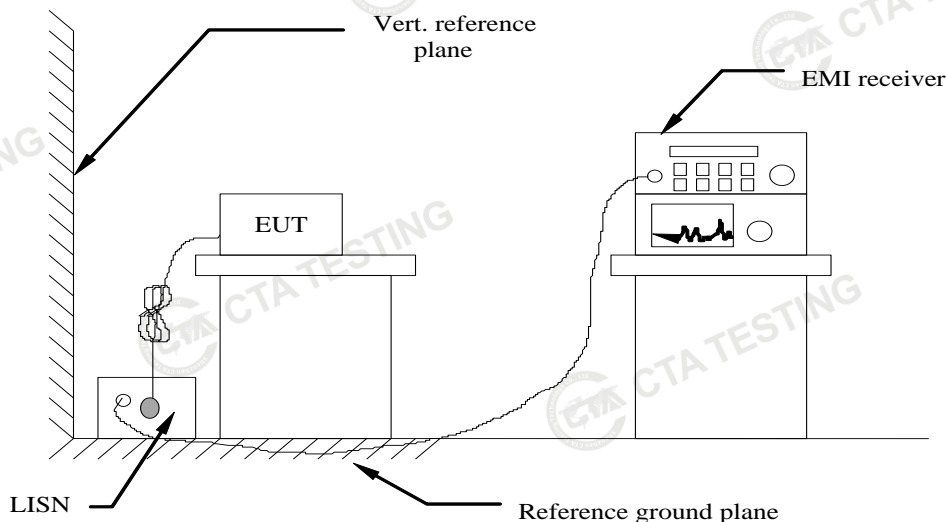

TEST PROCEDURE

- 1 The equipment was set up as per the test configuration to simulate typical actual usage per the user's manual. The EUT is a tabletop system, a wooden table with a height of 0.8 meters is used and is placed on the ground plane as per ANSI C63.10-2013.
- 2 Support equipment, if needed, was placed as per ANSI C63.10-2013
- 3 All I/O cables were positioned to simulate typical actual usage as per ANSI C63.10-2013
- 4 The EUT received power from adapter, the adapter received AC120V/60Hz and AC 240V/60Hz power through a Line Impedance Stabilization Network (LISN) which supplied power source and was grounded to the ground plane.
- 5 All support equipments received AC power from a second LISN, if any.
- 6 The EUT test program was started. Emissions were measured on each current carrying line of the EUT using a spectrum Analyzer / Receiver connected to the LISN powering the EUT. The LISN has two monitoring points: Line 1 (Hot Side) and Line 2 (Neutral Side). Two scans were taken: one with Line 1 connected to Analyzer / Receiver and Line 2 connected to a 50 ohm load; the second scan had Line 1 connected to a 50 ohm load and Line 2 connected to the Analyzer / Receiver.
- 7 Analyzer / Receiver scanned from 150 KHz to 30MHz for emissions in each of the test modes.
- 8 During the above scans, the emissions were maximized by cable manipulation.

AC Power Conducted Emission Limit

For intentional device, according to § 15.207(a) AC Power Conducted Emission Limits is as following :

Frequency range (MHz)	Limit (dBuV)	
	Quasi-peak	Average
0.15-0.5	66 to 56*	56 to 46*
0.5-5	56	46
5-30	60	50

* Decreases with the logarithm of the frequency.

TEST RESULTS

Remark:

1. BLE 1Mbps was tested at Low, Middle, and High channel; only the worst result of BLE 1Mbps High channel was reported as below:

Shenzhen CTA Testing Technology Co., Ltd.

Room 106, Building 1, Yibaolai Industrial Park, Qiaotou Community, Fuhai Street, Bao'an District, Shenzhen, China
Tel:+86-755 2322 5875 E-mail:cta@cta-test.cn Web:http://www.cta-test.cn

2. Both 120 VAC, 50/60 Hz and 240 VAC, 50/60 Hz power supply have been tested, only the worst result of 120 VAC, 60 Hz was reported as below:

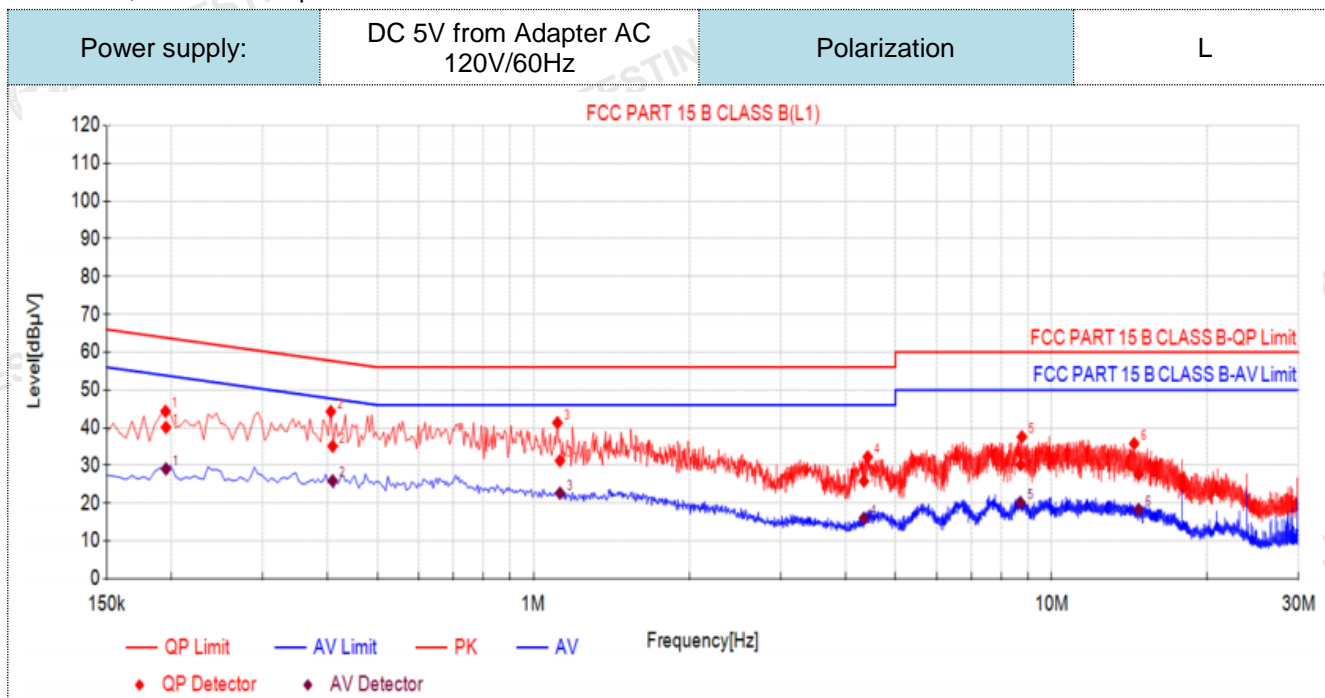

Final Data List

NO.	Freq. [MHz]	Factor [dB]	QP Reading[dB µV]	QP Value [dBµV]	QP Limit [dBµV]	QP Margin [dB]	AV Reading [dBµV]	AV Value [dBµV]	AV Limit [dBµV]	AV Margin [dB]	Verdict
1	0.1954	10.50	29.58	40.08	63.80	23.72	18.58	29.08	53.80	24.72	PASS
2	0.4098	10.50	24.59	35.09	57.65	22.56	15.44	25.94	47.65	21.71	PASS
3	1.1259	10.50	20.77	31.27	56.00	24.73	12.16	22.66	46.00	23.34	PASS
4	4.3467	10.50	15.35	25.85	56.00	30.15	5.52	16.02	46.00	29.98	PASS
5	8.7194	10.50	19.66	30.16	60.00	29.84	9.61	20.11	50.00	29.89	PASS
6	14.7311	10.50	17.10	27.60	60.00	32.40	7.82	18.32	50.00	31.68	PASS

- Note:1).QP Value (dBµV)= QP Reading (dBµV)+ Factor (dB)
 2). Factor (dB)=insertion loss of LISN (dB) + Cable loss (dB)
 3). QPMargin(dB) = QP Limit (dBµV) - QP Value (dBµV)
 4). AVMargin(dB) = AV Limit (dBµV) - AV Value (dBµV)

Power supply:	DC 5V from Adapter AC 120V/60Hz	Polarization	N
---------------	------------------------------------	--------------	---

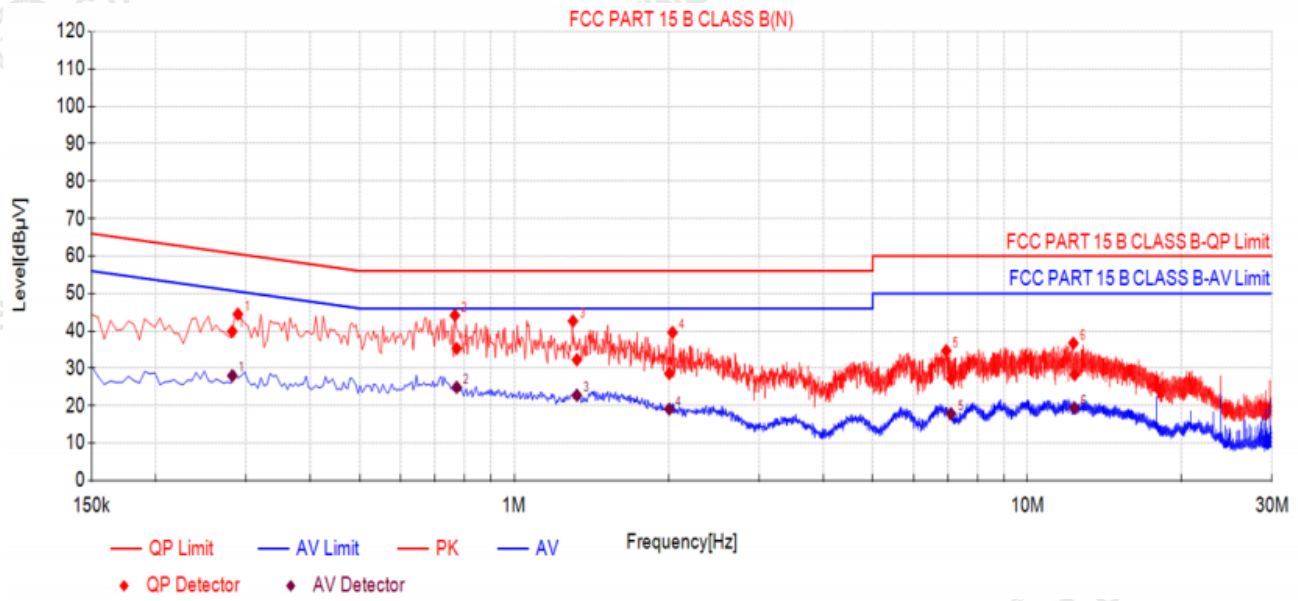

Final Data List											
NO.	Freq. [MHz]	Factor [dB]	QP Reading [dB µV]	QP Value [dBµV]	QP Limit [dBµV]	QP Margin [dB]	AV Reading [dBµV]	AV Value [dBµV]	AV Limit [dBµV]	AV Margin [dB]	Verdict
1	0.2823	10.50	29.36	39.86	60.75	20.89	17.52	28.02	50.75	22.73	PASS
2	0.7729	10.50	24.80	35.30	56.00	20.70	14.42	24.92	46.00	21.08	PASS
3	1.3254	10.50	21.78	32.28	56.00	23.72	12.31	22.81	46.00	23.19	PASS
4	2.0066	10.50	18.11	28.61	56.00	27.39	8.60	19.10	46.00	26.90	PASS
5	7.1049	10.50	16.71	27.21	60.00	32.79	7.36	17.86	50.00	32.14	PASS
6	12.3673	10.50	17.79	28.29	60.00	31.71	8.92	19.42	50.00	30.58	PASS

- Note:1). QP Value (dBµV) = QP Reading (dBµV) + Factor (dB)
 2). Factor (dB) = insertion loss of LISN (dB) + Cable loss (dB)
 3). QPMargin (dB) = QP Limit (dBµV) - QP Value (dBµV)
 4). AVMargin (dB) = AV Limit (dBµV) - AV Value (dBµV)

4.2 Radiated Emissions and Band Edge

TEST CONFIGURATION

Frequency range 9 KHz – 30MHz

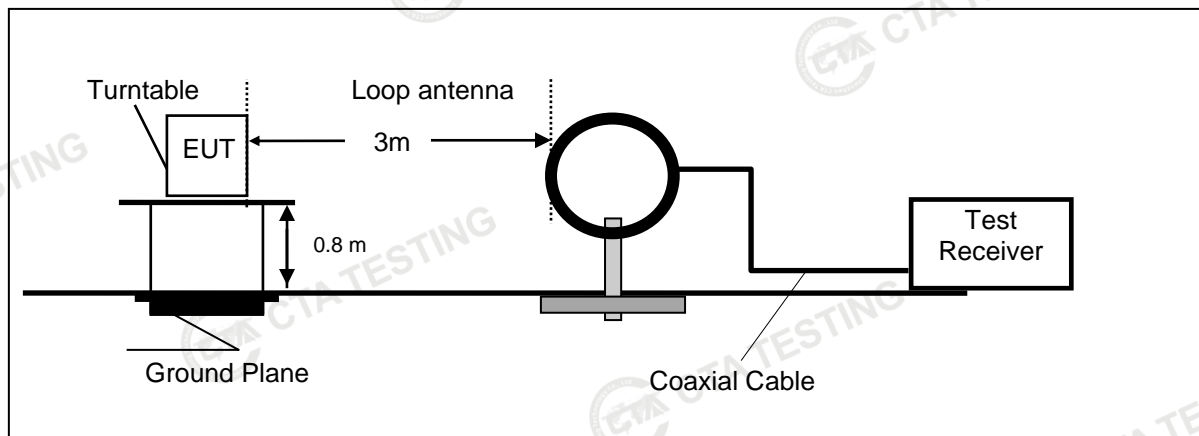

Frequency range 30MHz – 1000MHz

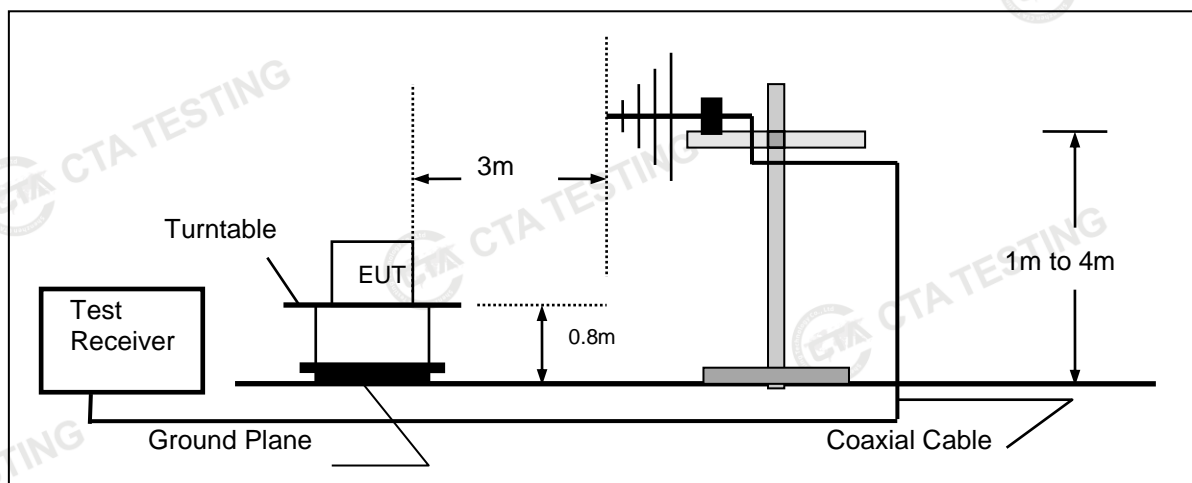

Frequency range above 1GHz-25GHz

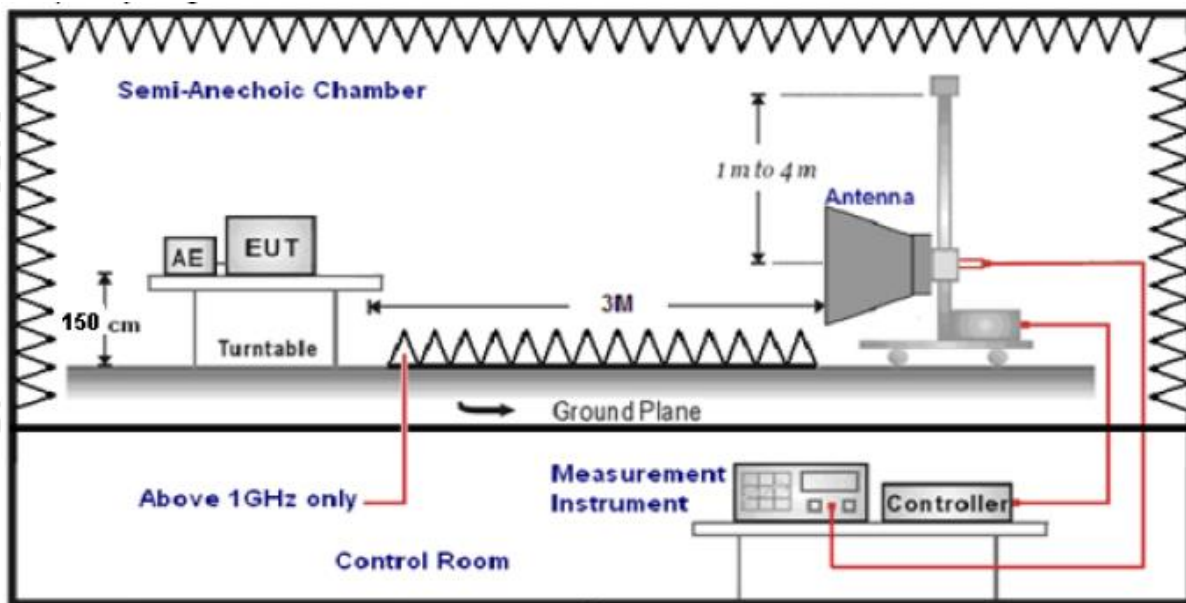

TEST PROCEDURE

1. The EUT was placed on a turn table which is 0.8m above ground plane when testing frequency range 9 KHz –1GHz;the EUT was placed on a turn table which is 1.5m above ground plane when testing frequency range 1GHz – 25GHz.
2. Maximum procedure was performed by raising the receiving antenna from 1m to 4m and rotating the turn table from 0°C to 360°C to acquire the highest emissions from EUT.
3. And also, each emission was to be maximized by changing the polarization of receiving antenna both horizontal and vertical.
4. Repeat above procedures until all frequency measurements have been completed.
5. The EUT minimum operation frequency was 32.768KHz and maximum operation frequency was 2480MHz.so radiated emission test frequency band from 9KHz to 25GHz.
6. The distance between test antenna and EUT as following table states:

Test Frequency range	Test Antenna Type	Test Distance
9KHz-30MHz	Active Loop Antenna	3
30MHz-1GHz	Ultra-Broadband Antenna	3
1GHz-18GHz	Double Ridged Horn Antenna	3
18GHz-25GHz	Horn Antenna	1

7. Setting test receiver/spectrum as following table states:

Test Frequency range	Test Receiver/Spectrum Setting	Detector
9KHz-150KHz	RBW=200Hz/VBW=3KHz,Sweep time=Auto	QP
150KHz-30MHz	RBW=9KHz/VBW=100KHz,Sweep time=Auto	QP
30MHz-1GHz	RBW=120KHz/VBW=1000KHz,Sweep time=Auto	QP
1GHz-40GHz	Peak Value: RBW=1MHz/VBW=3MHz, Sweep time=Auto Average Value: RBW=1MHz/VBW=10Hz, Sweep time=Auto	Peak

Field Strength Calculation

The field strength is calculated by adding the Antenna Factor and Cable Factor and subtracting the Amplifier Gain and Duty Cycle Correction Factor(if any) from the measured reading. The basic equation with a sample calculation is as follows:

$$FS = RA + AF + CL - AG$$

Where FS = Field Strength	CL = Cable Attenuation Factor (Cable Loss)
RA = Reading Amplitude	AG = Amplifier Gain
AF = Antenna Factor	

Shenzhen CTA Testing Technology Co., Ltd.

Room 106, Building 1, Yibaolai Industrial Park, Qiaotou Community, Fuhai Street, Bao'an District, Shenzhen, China
Tel:+86-755 2322 5875 E-mail:cta@cta-test.cn Web:http://www.cta-test.cn

Transd=AF +CL-AG

RADIATION LIMIT

For intentional device, according to § 15.209(a), the general requirement of field strength of radiated emission from intentional radiators at a distance of 3 meters shall not exceed the following table. According to § 15.247(d), in any 100kHz bandwidth outside the frequency band in which the EUT is operating, the radio frequency power that is produced by the intentional radiator shall be at least 20dB below that in the 100kHz bandwidth within the band that contains the highest level of desired power.

The pre-test have done for the EUT in three axes and found the worst emission at position shown in test setup photos.

Frequency (MHz)	Distance (Meters)	Radiated (dB μ V/m)	Radiated (μ V/m)
0.009-0.49	3	$20\log(2400/F(\text{KHz}))+40\log(300/3)$	2400/F(KHz)
0.49-1.705	3	$20\log(24000/F(\text{KHz}))+40\log(30/3)$	24000/F(KHz)
1.705-30	3	$20\log(30)+40\log(30/3)$	30
30-88	3	40.0	100
88-216	3	43.5	150
216-960	3	46.0	200
Above 960	3	54.0	500

TEST RESULTS

Remark:

1. This test was performed with EUT in X, Y, Z position and the worse case was found when EUT in X position.
2. BLE 1Mbps were tested at Low, Middle, and High channel and recorded worst mode at BLE 1Mbps.
3. Radiated emission test from 9 KHz to 10th harmonic of fundamental was verified, and no emission found except system noise floor in 9 KHz to 30MHz and not recorded in this report.

For 30MHz-1GHz

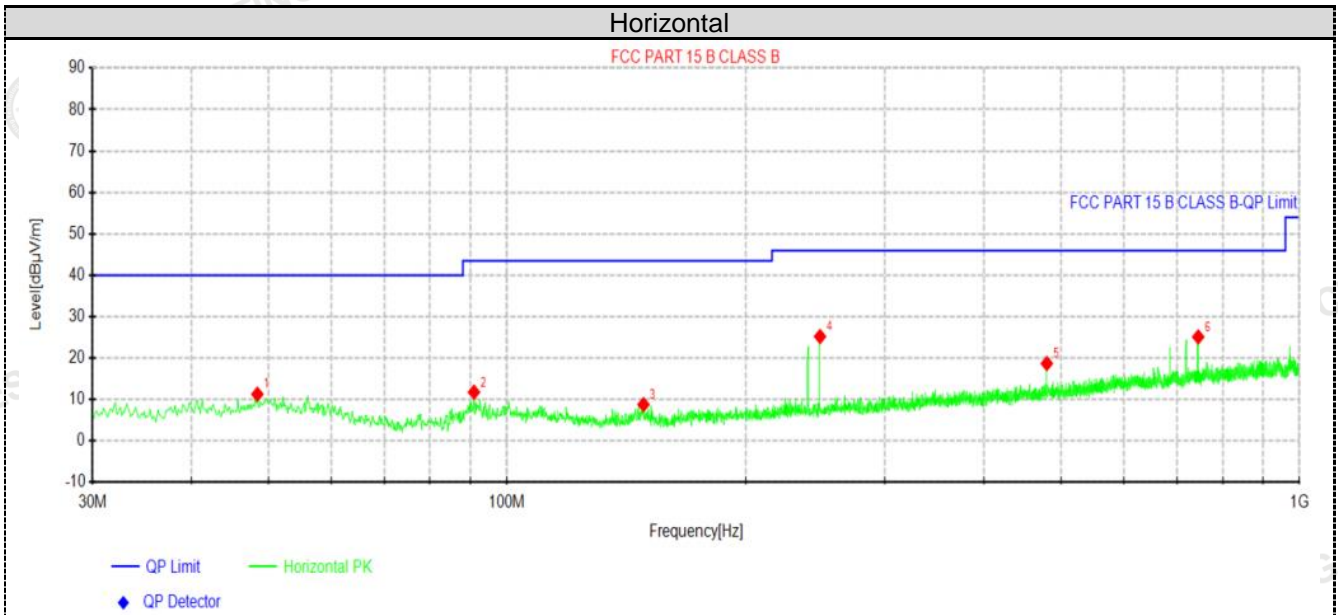

Suspected Data List									
NO.	Freq. [MHz]	Reading [dBµV]	Level [dBµV/m]	Factor [dB/m]	Limit [dBµV/m]	Margin [dB]	Height [cm]	Angle [°]	Polarity
1	48.43	27.48	11.30	-16.18	40.00	28.70	100	75	Horizontal
2	90.8675	31.58	11.79	-19.79	43.50	31.71	100	19	Horizontal
3	148.703	30.55	8.79	-21.76	43.50	34.71	100	84	Horizontal
4	248.371	43.26	25.23	-18.03	46.00	20.77	100	253	Horizontal
5	479.958	33.28	18.71	-14.57	46.00	27.29	100	13	Horizontal
6	745.132	35.94	25.14	-10.80	46.00	20.86	100	132	Horizontal

Note:1).Level (dBµV/m)= Reading (dBµV)+ Factor (dB/m)

2). Factor(dB/m)=Antenna Factor (dB/m) + Cable loss (dB) - Pre Amplifier gain (dB)

3). Margin(dB) = Limit (dBµV/m) - Level (dBµV/m)

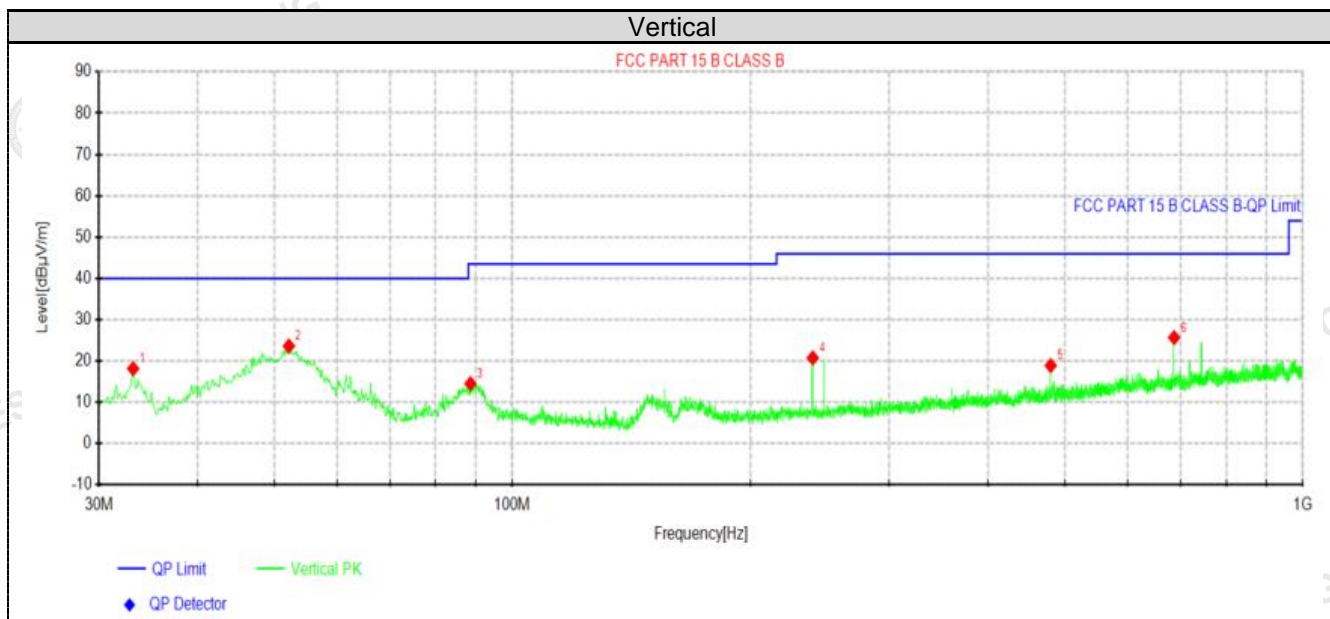

Suspected Data List

NO.	Freq. [MHz]	Reading [dBµV]	Level [dBµV/m]	Factor [dB/m]	Limit [dBµV/m]	Margin [dB]	Height [cm]	Angle [°]	Polarity
1	33.1525	36.35	18.16	-18.19	40.00	21.84	100	17	Vertical
2	52.1888	40.17	23.64	-16.53	40.00	16.36	100	211	Vertical
3	88.5638	34.67	14.54	-20.13	43.50	28.96	100	65	Vertical
4	240.005	39.04	20.77	-18.27	46.00	25.23	100	227	Vertical
5	479.958	33.47	18.90	-14.57	46.00	27.10	100	340	Vertical
6	687.538	37.43	25.69	-11.74	46.00	20.31	100	360	Vertical

Note:1).Level (dBµV/m)= Reading (dBµV)+ Factor (dB/m)

2). Factor(dB/m)=Antenna Factor (dB/m) + Cable loss (dB) - Pre Amplifier gain (dB)

3). Margin(dB) = Limit (dBµV/m) - Level (dBµV/m)

For 1GHz to 25GHz

GFSK (above 1GHz)

Frequency(MHz):			2402		Polarity:		HORIZONTAL		
Frequency (MHz)	Emission Level (dBuV/m)		Limit (dBuV/m)	Margin (dB)	Raw Value (dBuV)	Antenna Factor (dB/m)	Cable Factor (dB)	Pre-amplifier (dB)	Correction Factor (dB/m)
4804.00	61.74	PK	74	12.26	66.01	32.33	5.12	41.72	-4.27
4804.00	45.56	AV	54	8.44	49.83	32.33	5.12	41.72	-4.27
7206.00	54.28	PK	74	19.72	54.80	36.6	6.49	43.61	-0.52
7206.00	43.63	AV	54	10.37	44.15	36.6	6.49	43.61	-0.52

Frequency(MHz):			2402		Polarity:		VERTICAL		
Frequency (MHz)	Emission Level (dBuV/m)		Limit (dBuV/m)	Margin (dB)	Raw Value (dBuV)	Antenna Factor (dB/m)	Cable Factor (dB)	Pre-amplifier (dB)	Correction Factor (dB/m)
4804.00	60.02	PK	74	13.98	64.29	32.33	5.12	41.72	-4.27
4804.00	43.48	AV	54	10.52	47.75	32.33	5.12	41.72	-4.27
7206.00	52.74	PK	74	21.26	53.26	36.6	6.49	43.61	-0.52
7206.00	42.05	AV	54	11.95	42.57	36.6	6.49	43.61	-0.52

Frequency(MHz):			2440		Polarity:		HORIZONTAL		
Frequency (MHz)	Emission Level (dBuV/m)		Limit (dBuV/m)	Margin (dB)	Raw Value (dBuV)	Antenna Factor (dB/m)	Cable Factor (dB)	Pre-amplifier (dB)	Correction Factor (dB/m)
4880.00	61.36	PK	74	12.64	65.24	32.6	5.34	41.82	-3.88
4880.00	46.18	AV	54	7.82	50.06	32.6	5.34	41.82	-3.88
7320.00	53.46	PK	74	20.54	53.57	36.8	6.81	43.72	-0.11
7320.00	43.52	AV	54	10.48	43.63	36.8	6.81	43.72	-0.11

Frequency(MHz):			2440		Polarity:		VERTICAL		
Frequency (MHz)	Emission Level (dBuV/m)		Limit (dBuV/m)	Margin (dB)	Raw Value (dBuV)	Antenna Factor (dB/m)	Cable Factor (dB)	Pre-amplifier (dB)	Correction Factor (dB/m)
4880.00	59.65	PK	74	14.35	63.53	32.6	5.34	41.82	-3.88
4880.00	44.91	AV	54	9.09	48.79	32.6	5.34	41.82	-3.88
7320.00	52.36	PK	74	21.64	52.47	36.8	6.81	43.72	-0.11
7320.00	41.84	AV	54	12.16	41.95	36.8	6.81	43.72	-0.11

Frequency(MHz):			2480		Polarity:		HORIZONTAL		
Frequency (MHz)	Emission Level (dBuV/m)		Limit (dBuV/m)	Margin (dB)	Raw Value (dBuV)	Antenna Factor (dB/m)	Cable Factor (dB)	Pre-amplifier (dB)	Correction Factor (dB/m)
4960.00	60.92	PK	74	13.08	64.00	32.73	5.66	41.47	-3.08
4960.00	45.76	AV	54	8.24	48.84	32.73	5.66	41.47	-3.08
7440.00	55.57	PK	74	18.43	55.12	37.04	7.25	43.84	0.45
7440.00	44.36	PK	54	9.64	43.91	37.04	7.25	43.84	0.45

Frequency(MHz):			2480		Polarity:		VERTICAL		
Frequency (MHz)	Emission Level (dBuV/m)		Limit (dBuV/m)	Margin (dB)	Raw Value (dBuV)	Antenna Factor (dB/m)	Cable Factor (dB)	Pre-amplifier (dB)	Correction Factor (dB/m)
4960.00	59.24	PK	74	14.76	62.32	32.73	5.66	41.47	-3.08
4960.00	44.16	AV	54	9.84	47.24	32.73	5.66	41.47	-3.08
7440.00	53.95	PK	74	20.05	53.50	37.04	7.25	43.84	0.45
7440.00	42.79	PK	54	11.21	42.34	37.04	7.25	43.84	0.45

REMARKS:

Shenzhen CTA Testing Technology Co., Ltd.

Room 106, Building 1, Yibaolai Industrial Park, Qiaotou Community, Fuhai Street, Bao'an District, Shenzhen, China

Tel:+86-755 2322 5875 E-mail:cta@cta-test.cn Web:http://www.cta-test.cn

1. Emission level (dBuV/m) =Raw Value (dBuV)+Correction Factor (dB/m)
2. Correction Factor (dB/m) = Antenna Factor (dB/m)+Cable Factor (dB)- Pre-amplifier
3. Margin value = Limit value- Emission level.
4. -- Mean the PK detector measured value is below average limit.
5. The other emission levels were very low against the limit.

Results of Band Edges Test (Radiated)**GFSK**

Frequency(MHz):			2402		Polarity:		HORIZONTAL		
Frequency (MHz)	Emission Level (dBuV/m)		Limit (dBuV/m)	Margin (dB)	Raw Value (dBuV)	Antenna Factor (dB/m)	Cable Factor (dB)	Pre-amplifier (dB)	Correction Factor (dB/m)
2390.00	61.69	PK	74	12.31	72.11	27.42	4.31	42.15	-10.42
2390.00	44.57	AV	54	9.43	54.99	27.42	4.31	42.15	-10.42
Frequency(MHz):			2402		Polarity:		VERTICAL		
Frequency (MHz)	Emission Level (dBuV/m)		Limit (dBuV/m)	Margin (dB)	Raw Value (dBuV)	Antenna Factor (dB/m)	Cable Factor (dB)	Pre-amplifier (dB)	Correction Factor (dB/m)
2390.00	59.76	PK	74	14.24	70.18	27.42	4.31	42.15	-10.42
2390.00	42.54	AV	54	11.46	52.96	27.42	4.31	42.15	-10.42
Frequency(MHz):			2480		Polarity:		HORIZONTAL		
Frequency (MHz)	Emission Level (dBuV/m)		Limit (dBuV/m)	Margin (dB)	Raw Value (dBuV)	Antenna Factor (dB/m)	Cable Factor (dB)	Pre-amplifier (dB)	Correction Factor (dB/m)
2483.50	61.35	PK	74	12.65	71.46	27.7	4.47	42.28	-10.11
2483.50	42.72	AV	54	11.28	52.83	27.7	4.47	42.28	-10.11
Frequency(MHz):			2480		Polarity:		VERTICAL		
Frequency (MHz)	Emission Level (dBuV/m)		Limit (dBuV/m)	Margin (dB)	Raw Value (dBuV)	Antenna Factor (dB/m)	Cable Factor (dB)	Pre-amplifier (dB)	Correction Factor (dB/m)
2483.50	59.43	PK	74	14.57	69.54	27.7	4.47	42.28	-10.11
2483.50	40.65	AV	54	13.35	50.76	27.7	4.47	42.28	-10.11

REMARKS:

1. Emission level (dBuV/m) =Raw Value (dBuV)+Correction Factor (dB/m)
2. Correction Factor (dB/m) = Antenna Factor (dB/m)+Cable Factor (dB)- Pre-amplifier
3. Margin value = Limit value- Emission level.
4. -- Mean the PK detector measured value is below average limit.
5. The other emission levels were very low against the limit.

4.3 Maximum Peak Output Power

Limit

The Maximum Peak Output Power Measurement is 30dBm.

Test Procedure

Remove the antenna from the EUT and then connect a low loss RF cable from the antenna port to the power sensor.

Test Configuration



Test Results

Type	Channel	Output power (dBm)	Limit (dBm)	Result
GFSK 1Mbps	00	0.48	30.00	Pass
	19	0.02		
	39	0.29		

Note: 1.The test results including the cable lose.S

4.4 Power Spectral Density

Limit

For digitally modulated systems, the power spectral density conducted from the intentional radiator to the antenna shall not be greater than 8 dBm in any 3 kHz band during any time interval of continuous transmission.

Test Procedure

1. Use this procedure when the maximum peak conducted output power in the fundamental emission is used to demonstrate compliance.
2. Set the RBW \geq 3 kHz.
3. Set the VBW \geq 3 \times RBW.
4. Set the span to 1.5 times the DTS channel bandwidth.
5. Detector = peak.
6. Sweep time = auto couple.
7. Trace mode = max hold.
8. Allow trace to fully stabilize.
9. Use the peak marker function to determine the maximum power level.
10. If measured value exceeds limit, reduce RBW (no less than 3 kHz) and repeat.
11. The resulting peak PSD level must be 8dBm.

Test Configuration



Test Results

Type	Channel	Power Spectral Density (dBm/3KHz)	Limit (dBm/3KHz)	Result
GFSK 1Mbps	00	-18.67	8.00	Pass
	19	-18.02		
	39	-17.81		

Test plot as follows:

BLE GFSK 1Mbps

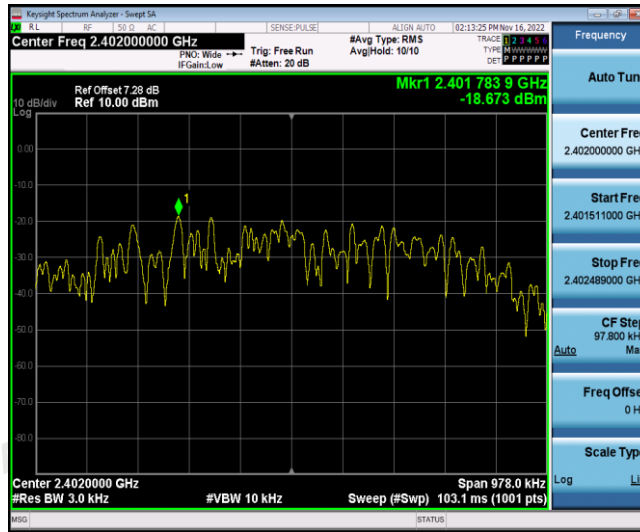

CH00

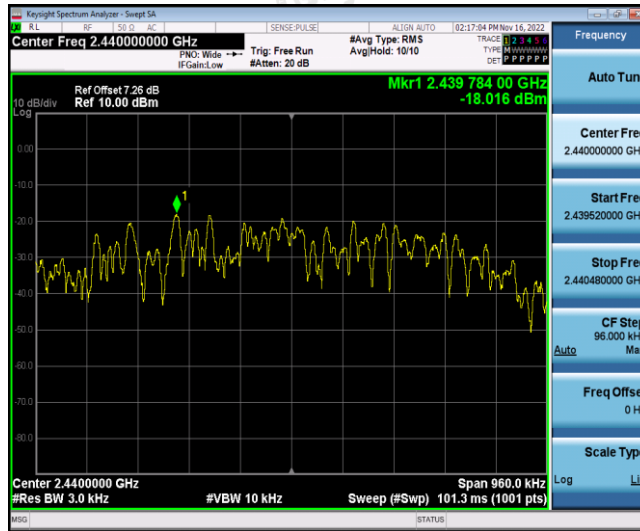

CH19

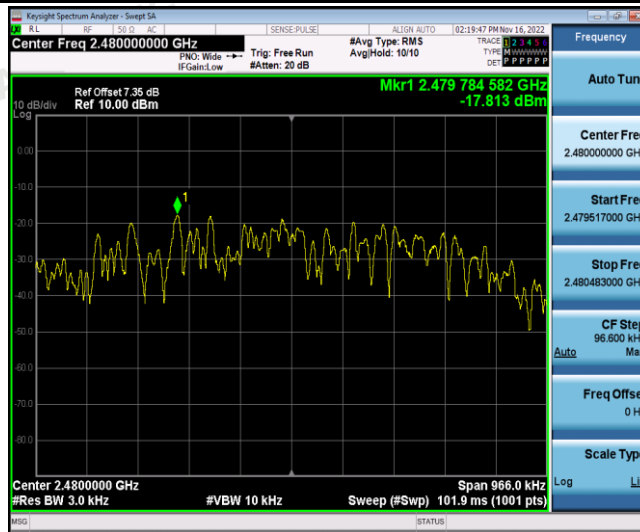

CH39

4.5 6dB Bandwidth

Limit

For digital modulation systems, the minimum 6 dB bandwidth shall be at least 500 kHz

Test Procedure

The transmitter output was connected to the spectrum analyzer through an attenuator. The bandwidth of the fundamental frequency was measured by spectrum analyzer with 100 KHz RBW and 300 KHz VBW. The 6dB bandwidth is defined as the total spectrum the power of which is higher than peak power minus 6dB.

Test Configuration

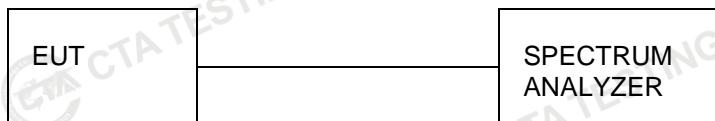

Test Results

Type	Channel	6dB Bandwidth (MHz)	Limit (KHz)	Result
GFSK 1Mbps	00	0.652	≥500	Pass
	19	0.640		
	39	0.644		

Test plot as follows:

BLE GFSK 1Mbps



CH00



CH19



CH39

4.6 Out-of-band Emissions

Limit

In any 100 kHz bandwidth outside the frequency band in which the spread spectrum or digitally modulated intentional radiator is operating, the radio frequency power that is produced by the intentional radiator shall be at least 20 dB below that in the 100 kHz bandwidth within the band that contains the highest level of the desired power, based on either an RF conducted or a radiated measurement, provided the transmitter demonstrates compliance with the peak conducted power limits. If the transmitter complies with the conducted power limits based on the use of RMS averaging over a time interval, as permitted under paragraph (b)(3) of this section, the attenuation required under this paragraph shall be 30 dB instead of 20 dB. Attenuation below the general limits specified in §15.209(a) is not required.

Test Procedure

Connect the transmitter output to spectrum analyzer using a low loss RF cable, and set the spectrum analyzer to RBW=100 kHz, VBW= 300 kHz, peak detector, and max hold. Measurements utilizing these settings are made of the in-band reference level, band-edge and out-of-band emissions.

Test Configuration

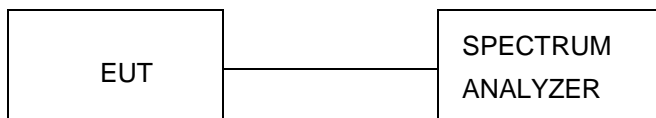

Test Results

Remark: The measurement frequency range is from 30MHz to the 10th harmonic of the fundamental frequency. The lowest, middle and highest channels are tested to verify the spurious emissions and band-edge measurement data.

Test plot as follows:

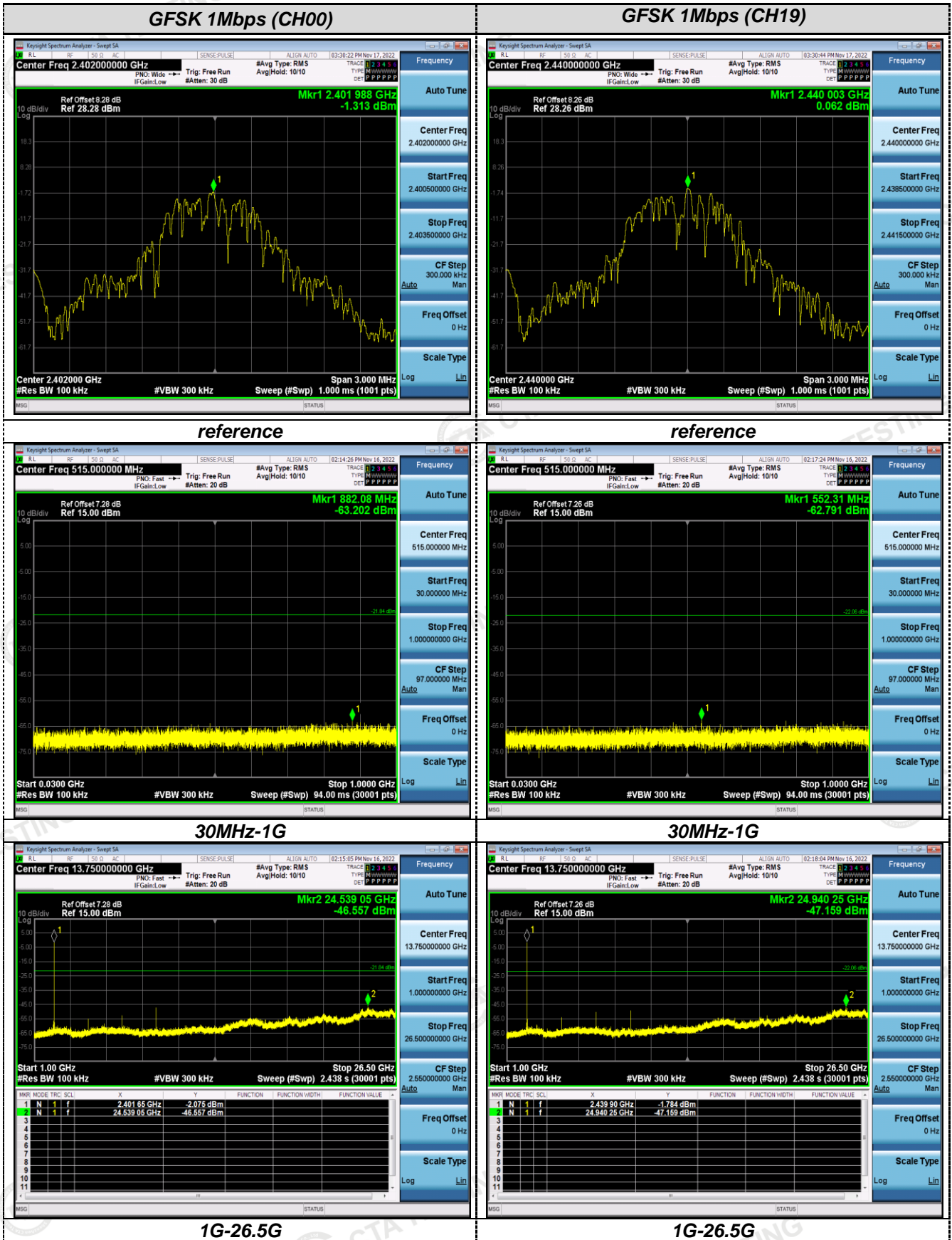



Band-edge Measurements for RF Conducted Emissions:

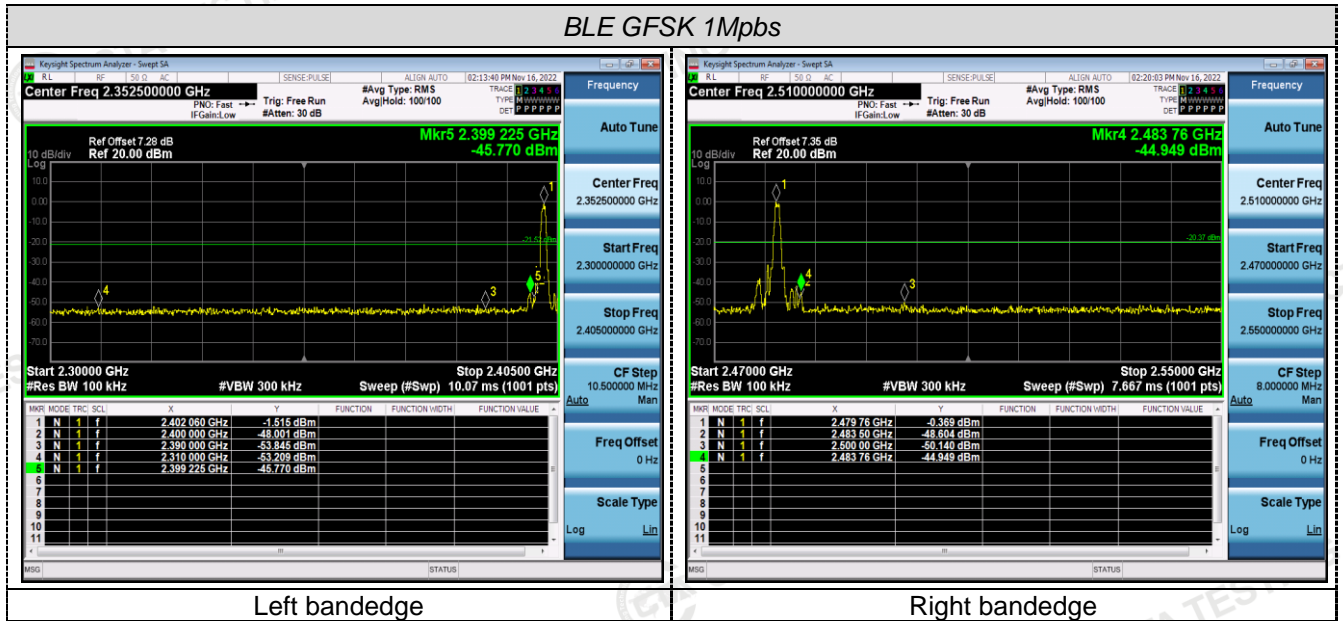

4.7 Antenna Requirement

Standard Applicable

For intentional device, according to FCC 47 CFR Section 15.203:

An intentional radiator shall be designed to ensure that no antenna other than that furnished by the responsible party shall be used with the device. The use of a permanently attached antenna or of an antenna that uses a unique coupling to the intentional radiator, the manufacturer may design the unit so that a broken antenna can be replaced by the user, but the use of a standard antenna jack or electrical connector is prohibited

FCC CFR Title 47 Part 15 Subpart C Section 15.247(c) (1) (I):

(i) Systems operating in the 2400-2483.5 MHz band that is used exclusively for fixed. Point-to-point operations may employ transmitting antennas with directional gain greater than 6dBi provided the maximum conducted output power of the intentional radiator is reduced by 1 dB for every 3 dB that the directional gain of the antenna exceeds 6dBi.

Antenna Connected Construction

The maximum gain of antenna was 1.94 dBi.

Remark: The antenna gain is provided by the customer, if the data provided by the customer is not accurate, Shenzhen CTA Testing Technology Co., Ltd. does not assume any responsibility.

5 Test Setup Photos of the EUT



Shenzhen CTA Testing Technology Co., Ltd.

Room 106, Building 1, Yibaolai Industrial Park, Qiaotou Community, Fuhai Street, Bao'an District, Shenzhen, China
Tel:+86-755 2322 5875 E-mail:cta@cta-test.cn Web:http://www.cta-test.cn

6 Photos of the EUT



Shenzhen CTA Testing Technology Co., Ltd.

Room 106, Building 1, Yibaolai Industrial Park, Qiaotou Community, Fuhai Street, Bao'an District, Shenzhen, China
Tel:+86-755 2322 5875 E-mail:cta@cta-test.cn Web:http://www.cta-test.cn



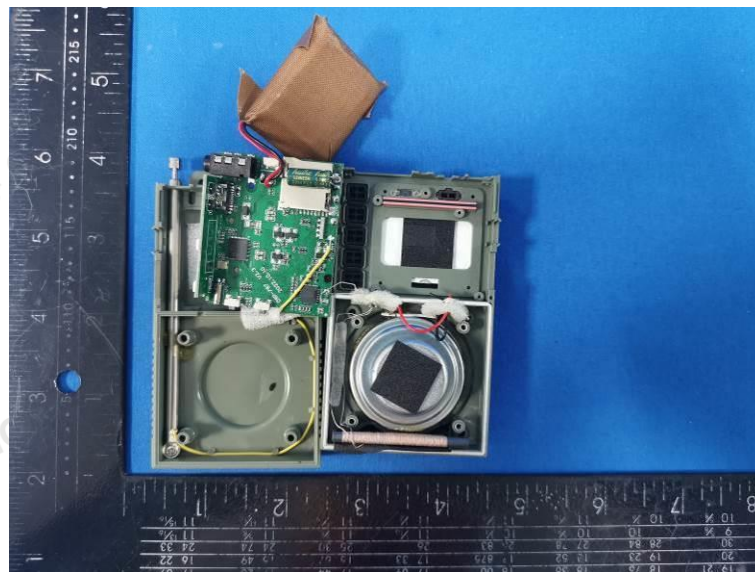
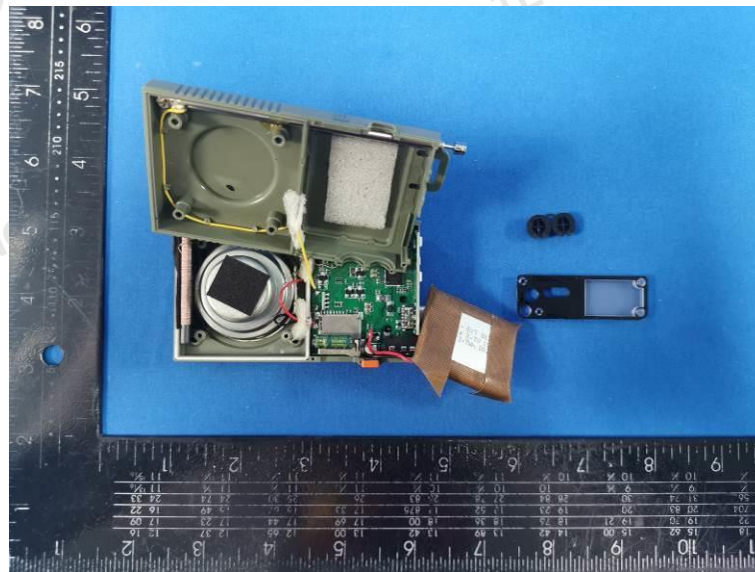
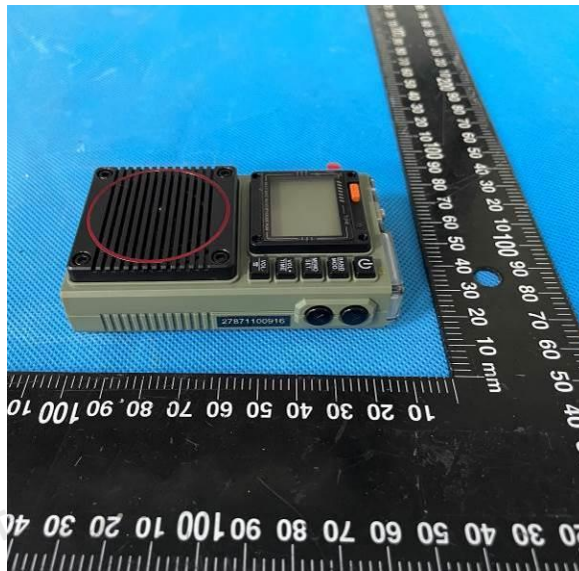

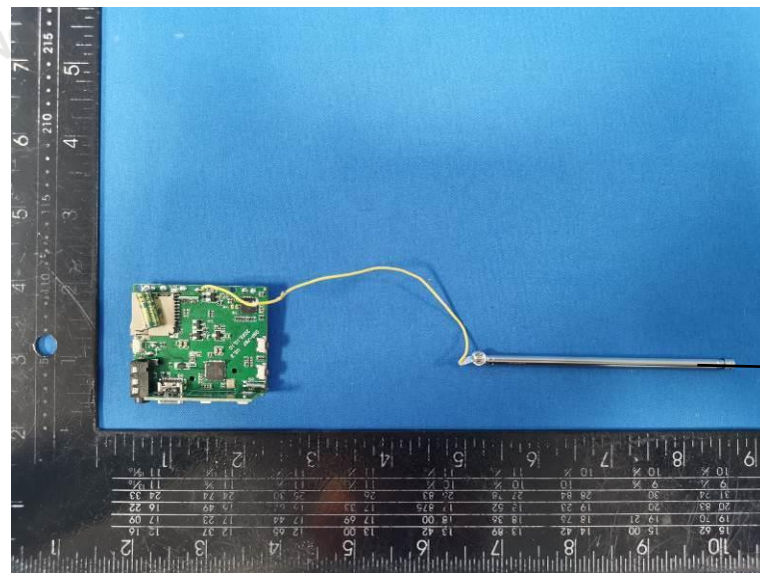

FM(RX)
Antenna

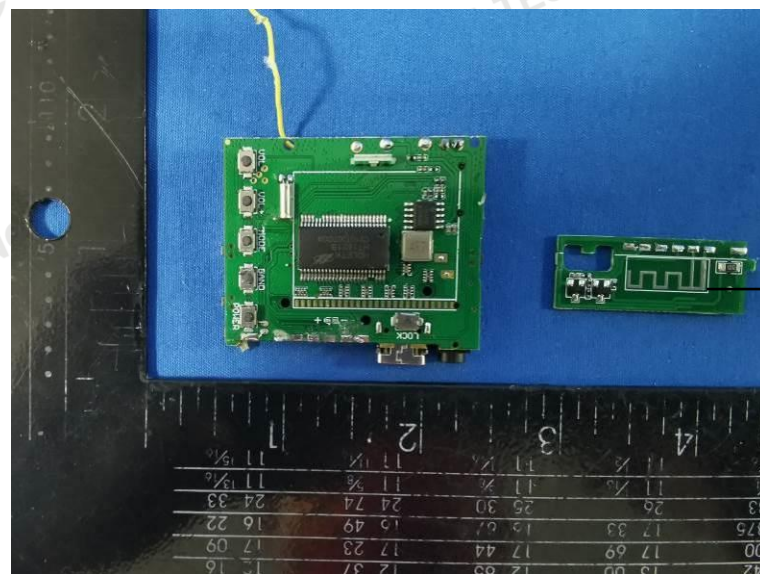

BT Antenna

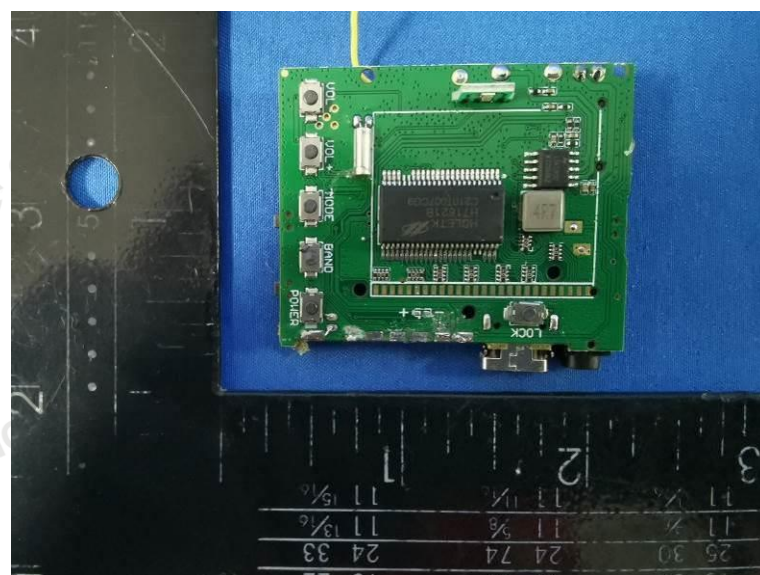

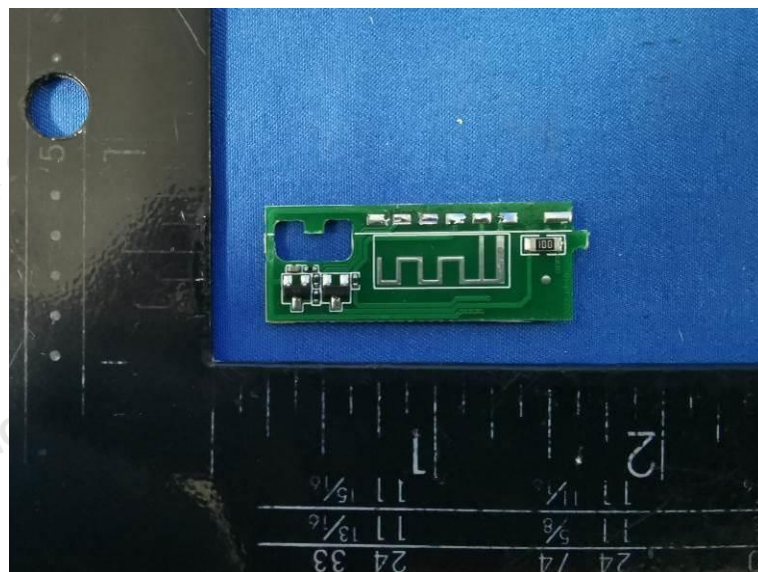
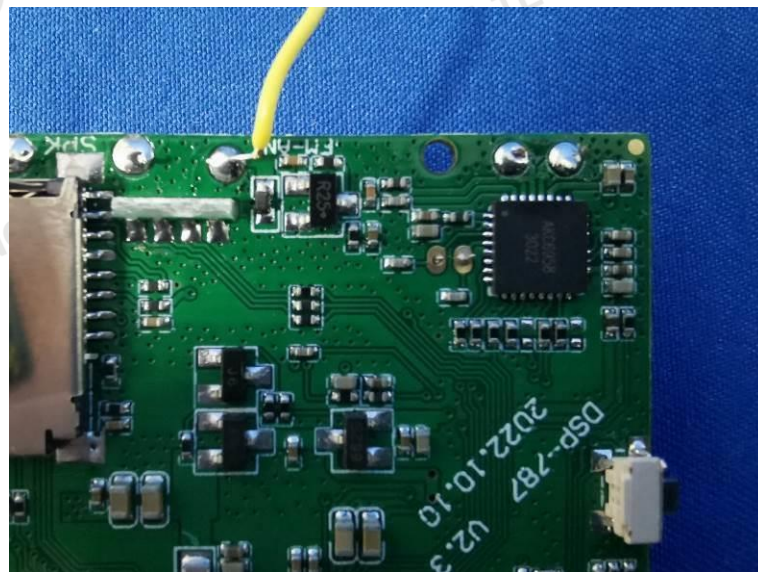
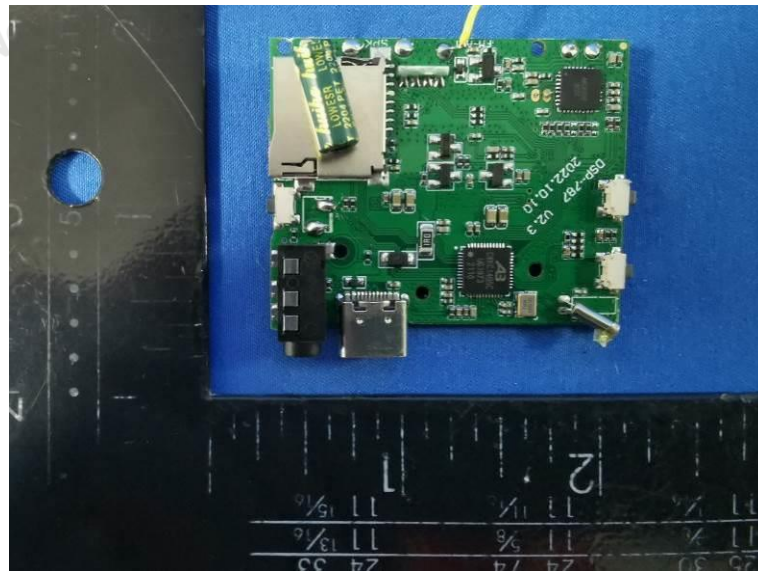

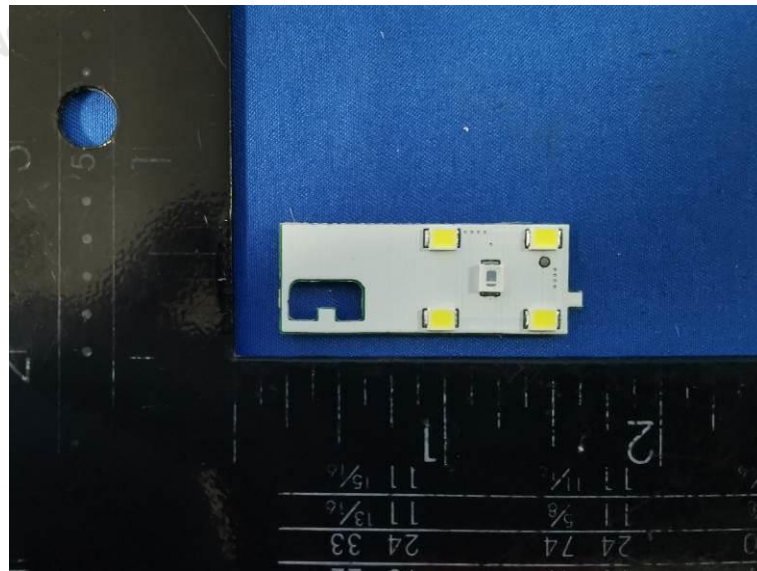

***** End of Report *****