

Appendix Test Data

Report No.:	18220WC40059501	Test Sample No.:	1-2-2
Start Test Date:	2024.4.01	Finish Test Date:	2024.4.01
Test Engineer:	Joker Wang	Auditor:	Justin Feng
Temperature:	25.5°C	Relative Humidity:	47%
Pressure:	101kPa		

Appendix A: -20dB Bandwidth

Condition	Antenna	Modulation	Frequency (MHz)	-20dB BW(MHz)	if larger than CFS
NVNT	ANT1	1-DH5	2402.00	1.028	Yes
NVNT	ANT1	1-DH5	2441.00	1.031	Yes
NVNT	ANT1	1-DH5	2480.00	1.034	Yes
NVNT	ANT1	2-DH5	2402.00	1.328	Yes
NVNT	ANT1	2-DH5	2441.00	1.328	Yes
NVNT	ANT1	2-DH5	2480.00	1.325	Yes
NVNT	ANT1	3-DH5	2402.00	1.283	Yes
NVNT	ANT1	3-DH5	2441.00	1.280	Yes
NVNT	ANT1	3-DH5	2480.00	1.279	Yes

-20dB_Bandwidth_NVNT_ANT1_1-DH5_2402

Shenzhen Anbotek Compliance Laboratory Limited

Address: 1/F., Building D, Sogood Science and Technology Park, Sanwei Community,
Hangcheng Street, Bao'an District, Shenzhen, Guangdong, China.
Tel: (86) 0755-26066440 Fax: (86) 0755-26014772 Email: service@anbotek.com



Hotline
400-003-0500
www.anbotek.com.cn



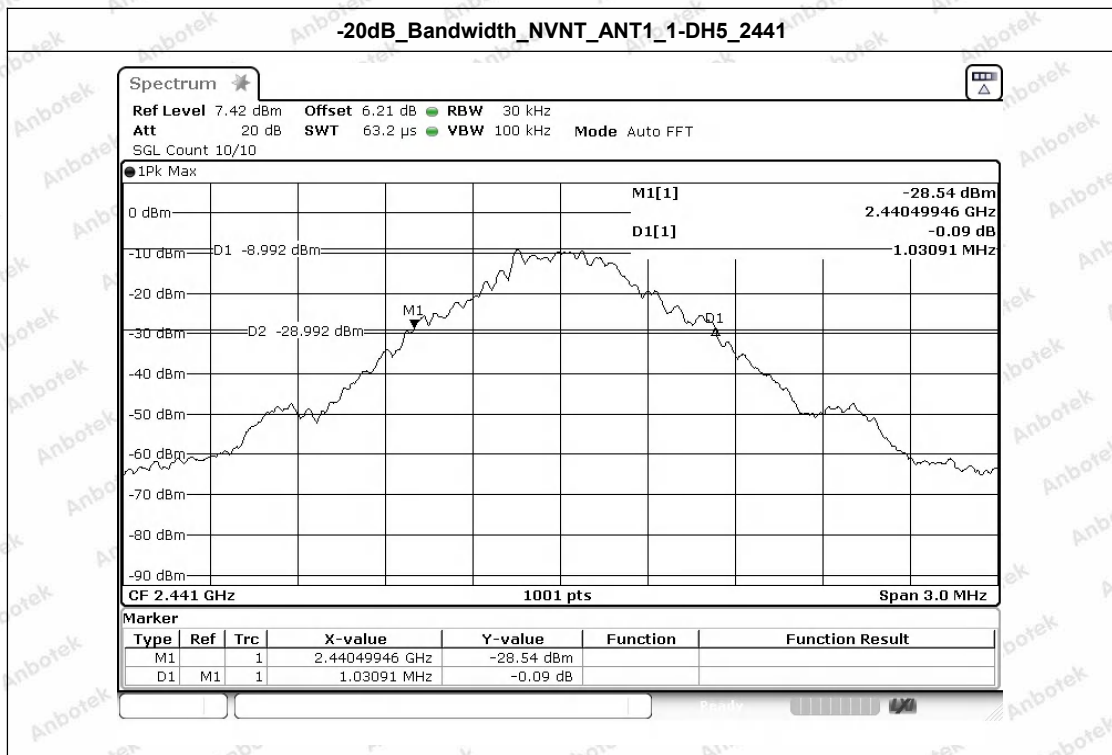
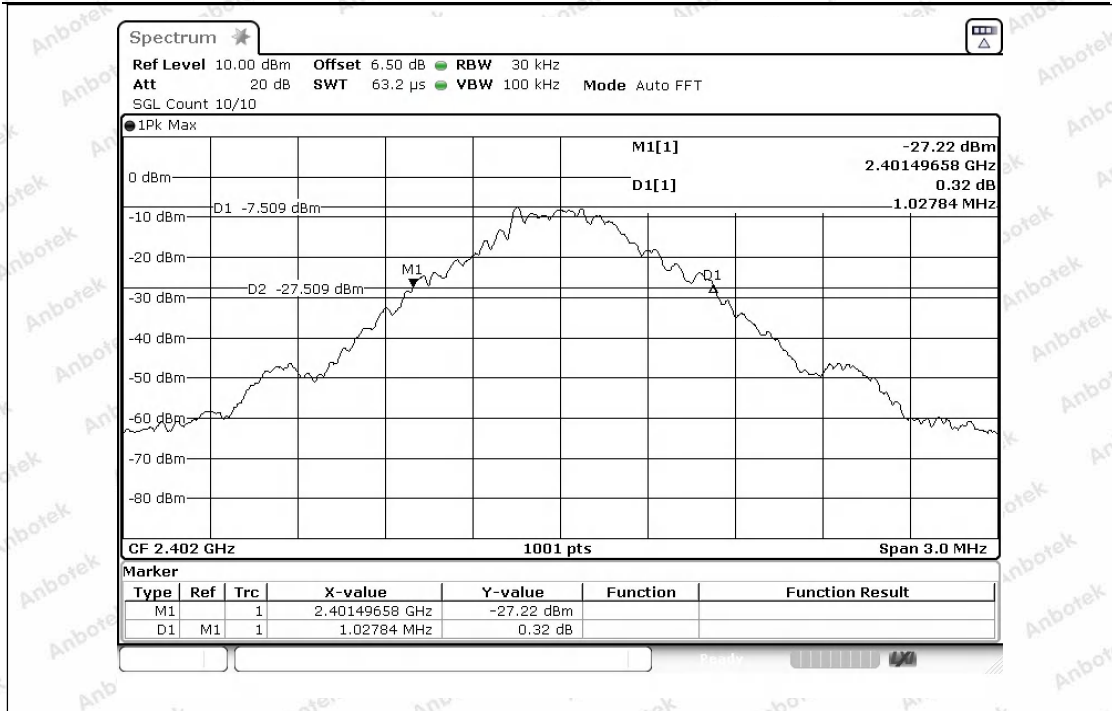

-20dB_Bandwidth_NVNT_ANT1_1-DH5_2480

Shenzhen Anbotek Compliance Laboratory Limited

Address: 1/F., Building D, Sogood Science and Technology Park, Sanwei Community, Hangcheng Street, Bao'an District, Shenzhen, Guangdong, China.
 Tel: (86) 0755-26066440 Fax: (86) 0755-26014772 Email: service@anbotek.com

Hotline
 400-003-0500
www.anbotek.com.cn



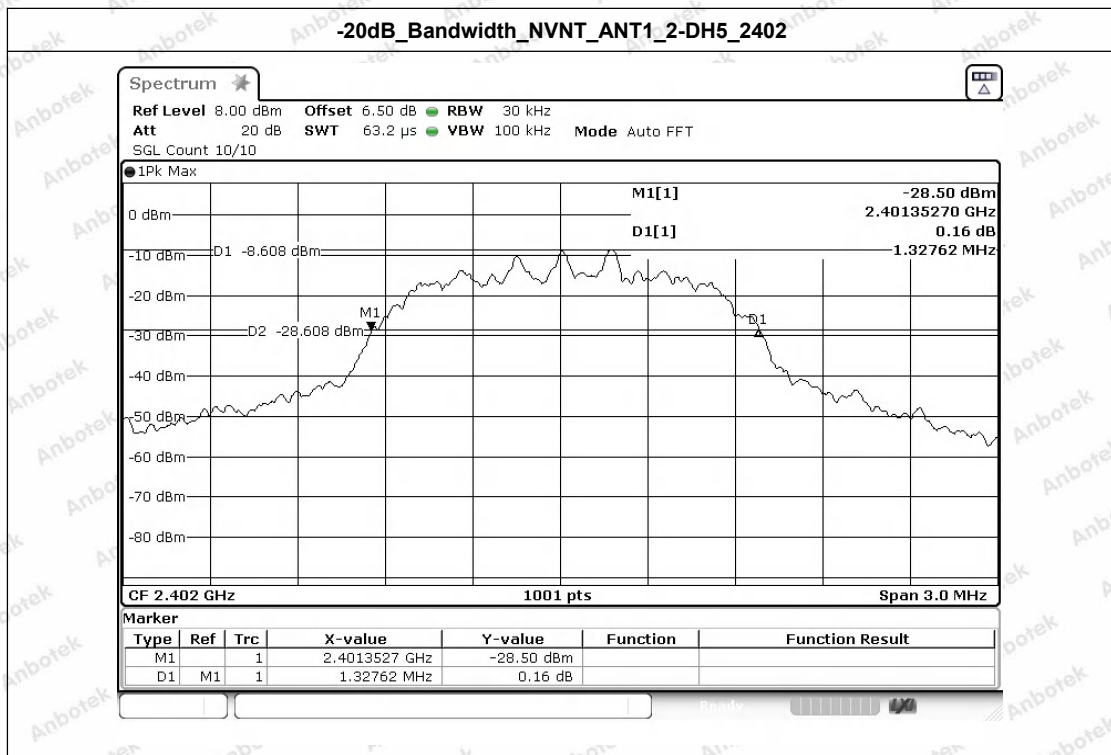
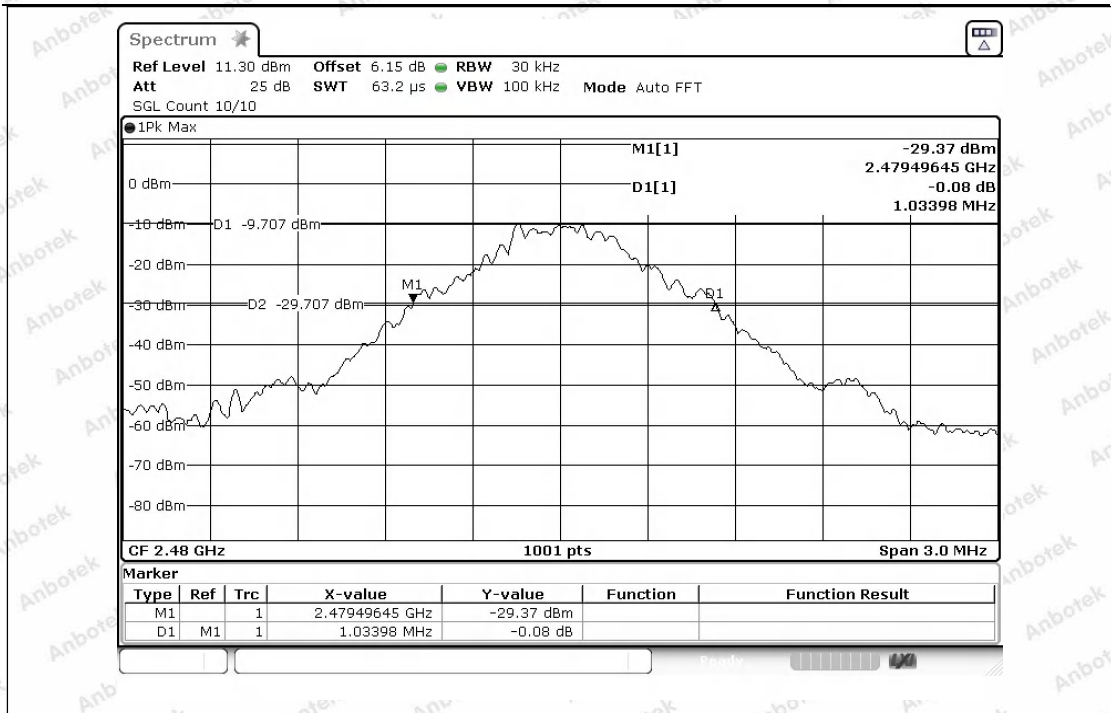

-20dB_Bandwidth_NVNT_ANT1_2-DH5_2441

Shenzhen Anbotek Compliance Laboratory Limited

Address: 1/F., Building D, Sogood Science and Technology Park, Sanwei Community, Hangcheng Street, Bao'an District, Shenzhen, Guangdong, China.
 Tel: (86) 0755-26066440 Fax: (86) 0755-26014772 Email: service@anbotek.com

Hotline
 400-003-0500
www.anbotek.com.cn



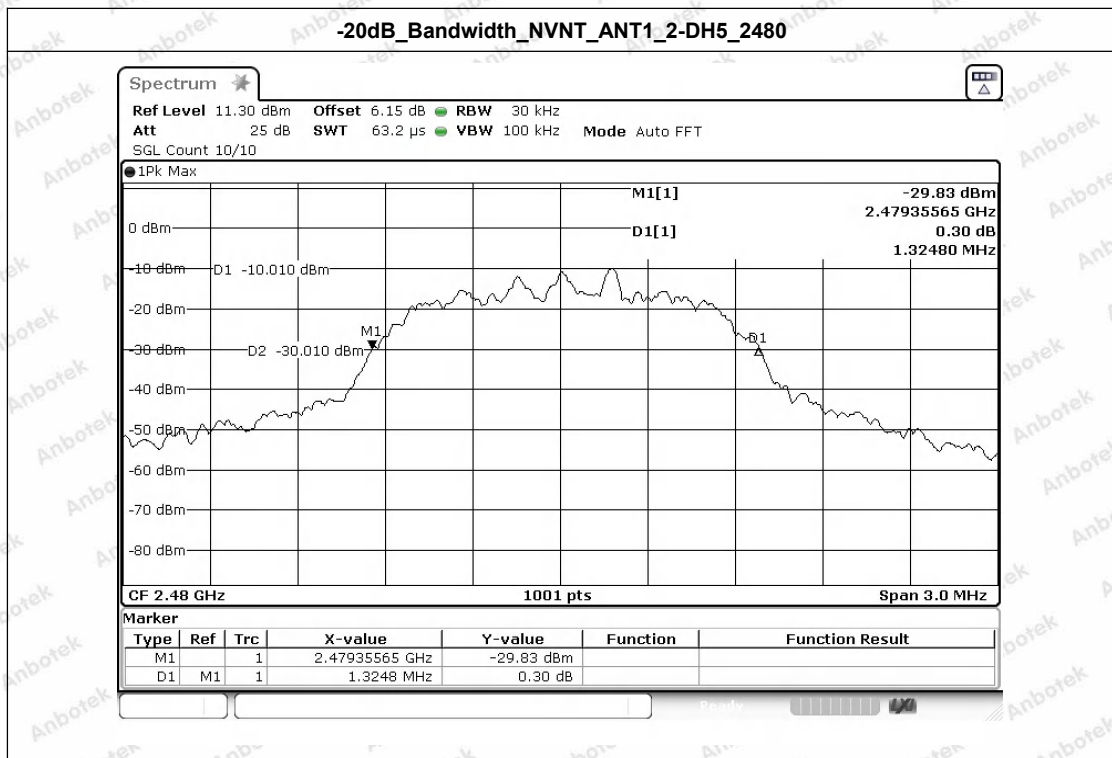
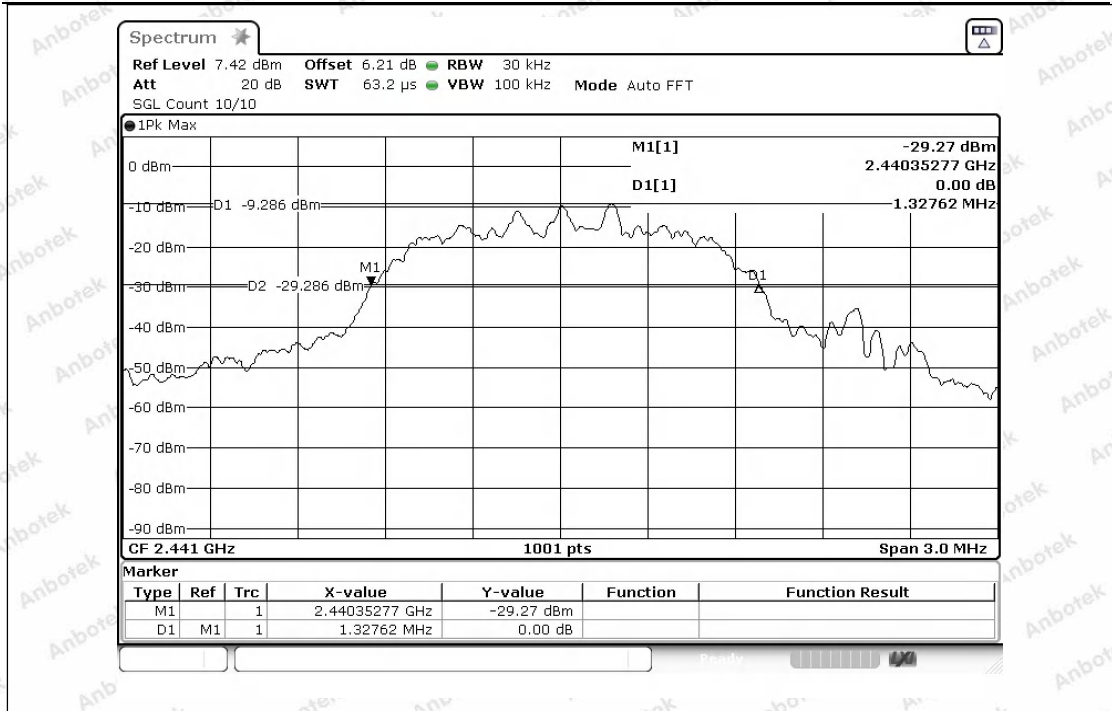

-20dB_Bandwidth_NVNT_ANT1_3-DH5_2402



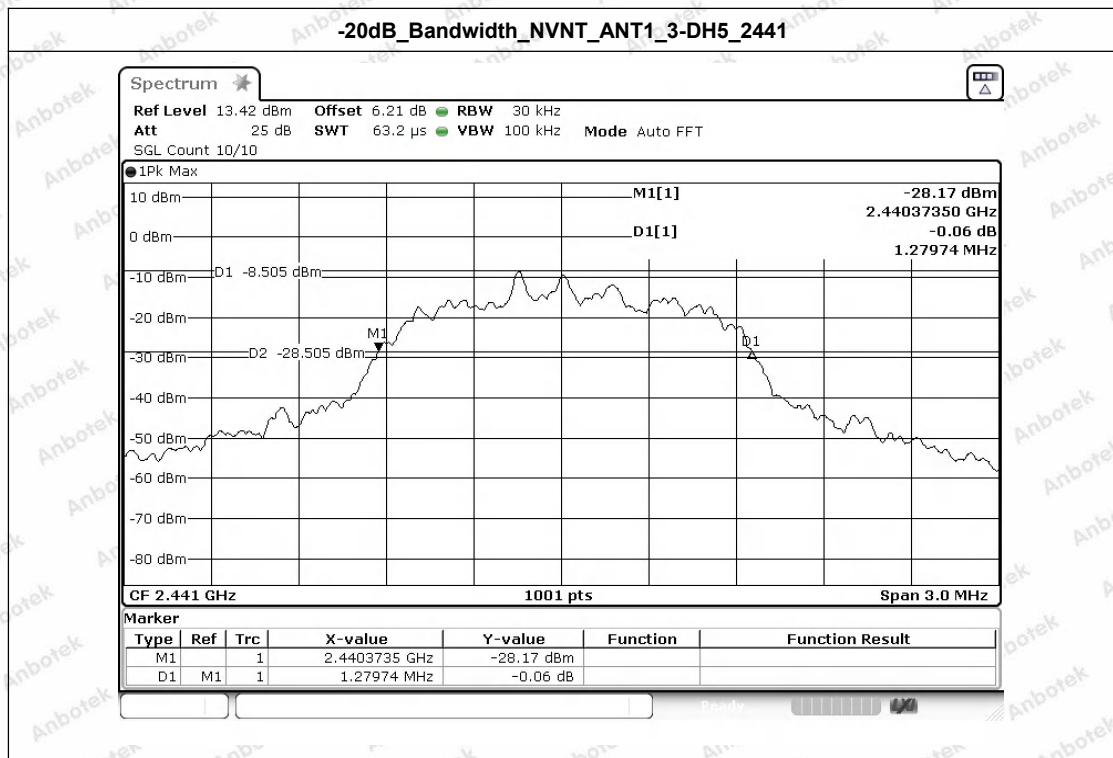
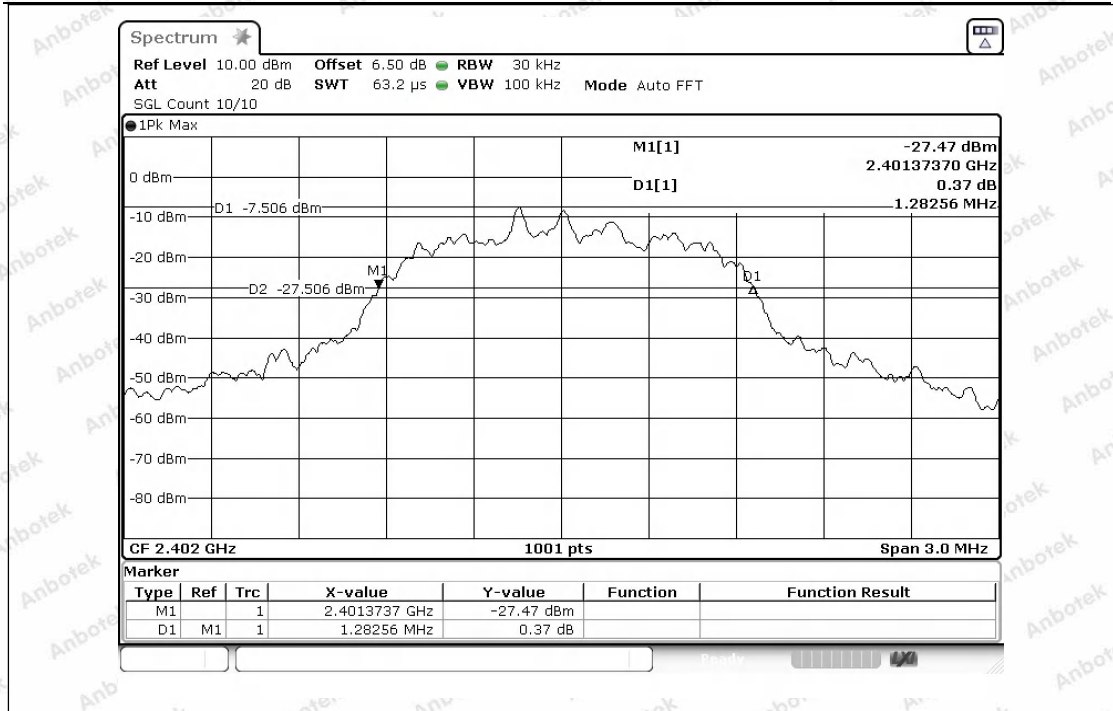

-20dB_Bandwidth_NVNT_ANT1_3-DH5_2480

Shenzhen Anbotek Compliance Laboratory Limited

Address: 1/F., Building D, Sogood Science and Technology Park, Sanwei Community, Hangcheng Street, Bao'an District, Shenzhen, Guangdong, China.
 Tel: (86) 0755-26066440 Fax: (86) 0755-26014772 Email: service@anbotek.com

Hotline
 400-003-0500
www.anbotek.com.cn



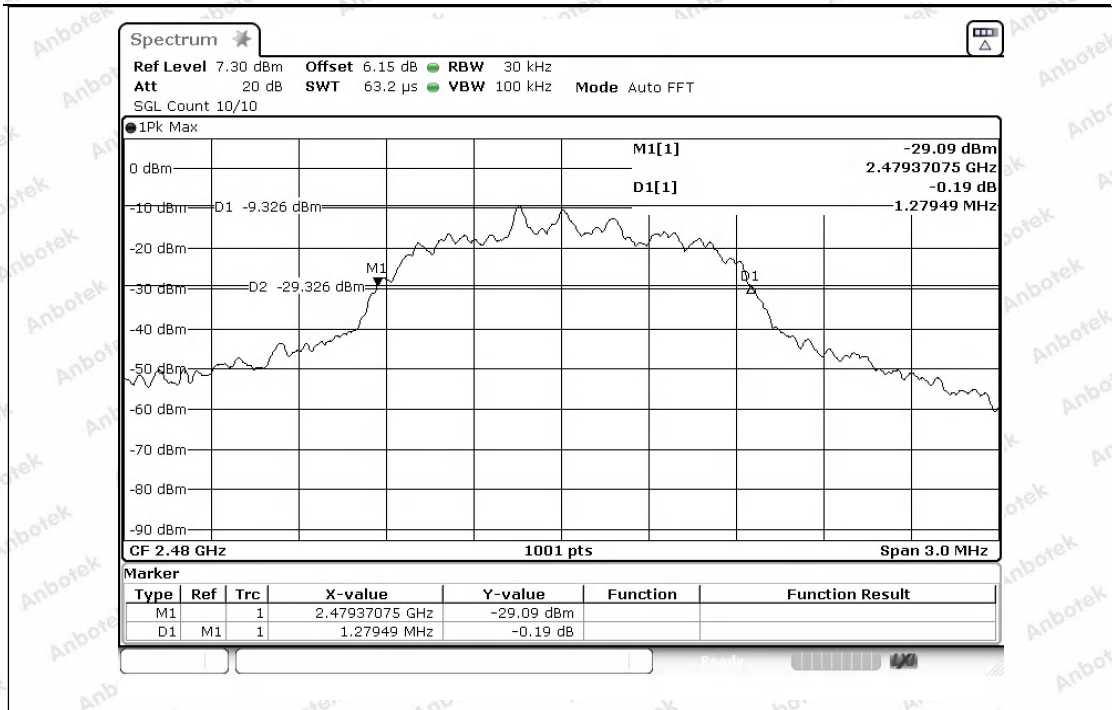

Shenzhen Anbotek Compliance Laboratory Limited

Address: 1/F., Building D, Sogood Science and Technology Park, Sanwei Community, Hangcheng Street, Bao'an District, Shenzhen, Guangdong, China.
 Tel: (86) 0755-26066440 Fax: (86) 0755-26014772 Email: service@anbotek.com

Hotline
 400-003-0500
www.anbotek.com.cn



Appendix B: 99% Occupied Bandwidth

Condition	Antenna	Modulation	Frequency (MHz)	99%BW(MHz)
NVNT	ANT1	1-DH5	2402.00	0.932
NVNT	ANT1	1-DH5	2441.00	0.941
NVNT	ANT1	1-DH5	2480.00	0.938
NVNT	ANT1	2-DH5	2402.00	1.208
NVNT	ANT1	2-DH5	2441.00	1.211
NVNT	ANT1	2-DH5	2480.00	1.208
NVNT	ANT1	3-DH5	2402.00	1.202
NVNT	ANT1	3-DH5	2441.00	1.199
NVNT	ANT1	3-DH5	2480.00	1.187

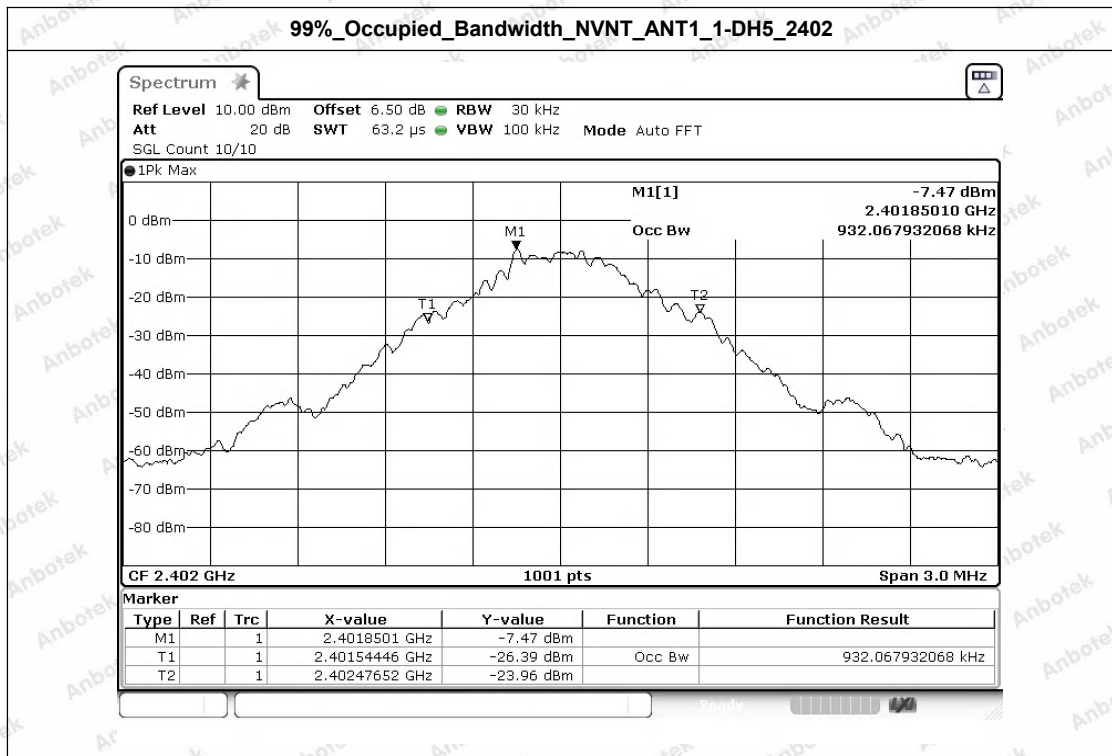

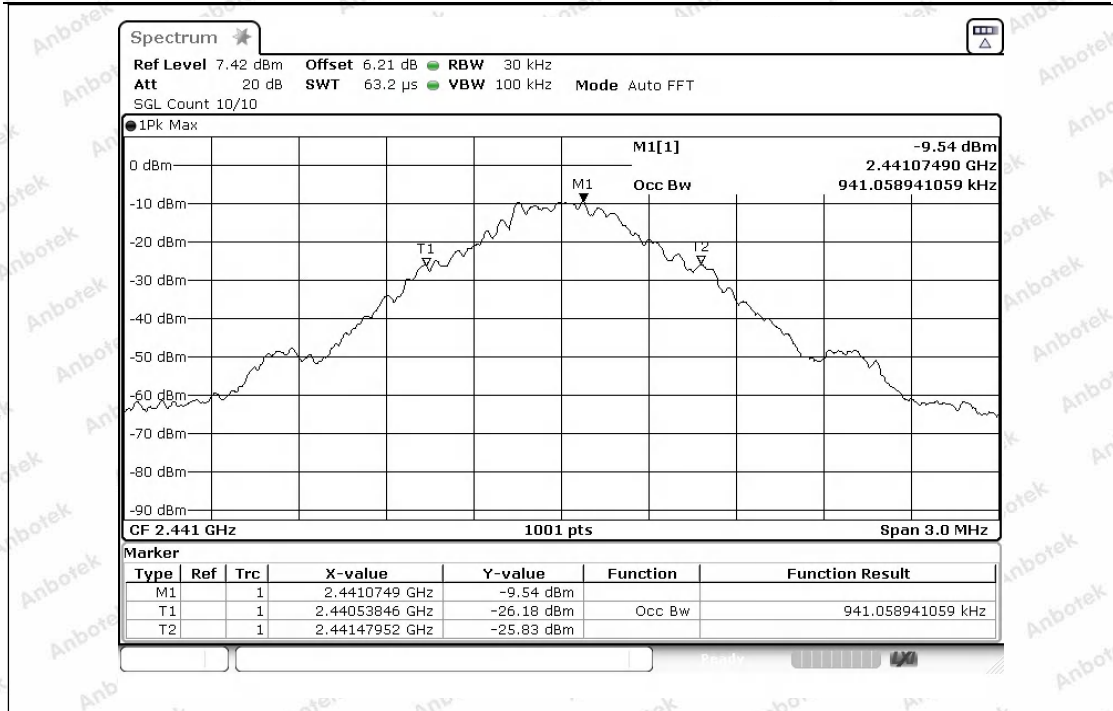

99%_Occupied_Bandwidth_NVNT_ANT1_1-DH5_2480

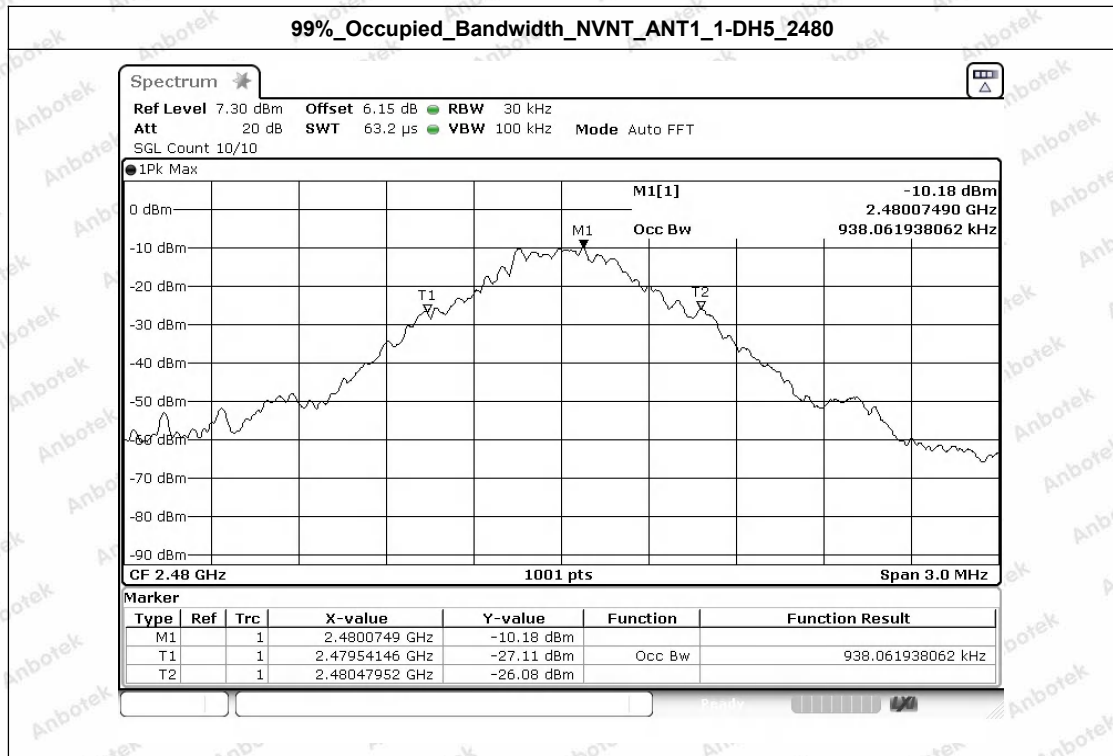

99%_Occupied_Bandwidth_NVNT_ANT1_2-DH5_2402

Shenzhen Anbotek Compliance Laboratory Limited

Address: 1/F., Building D, Sogood Science and Technology Park, Sanwei Community, Hangcheng Street, Bao'an District, Shenzhen, Guangdong, China.
 Tel: (86) 0755-26066440 Fax: (86) 0755-26014772 Email: service@anbotek.com

Hotline 400-003-0500
 www.anbotek.com.cn



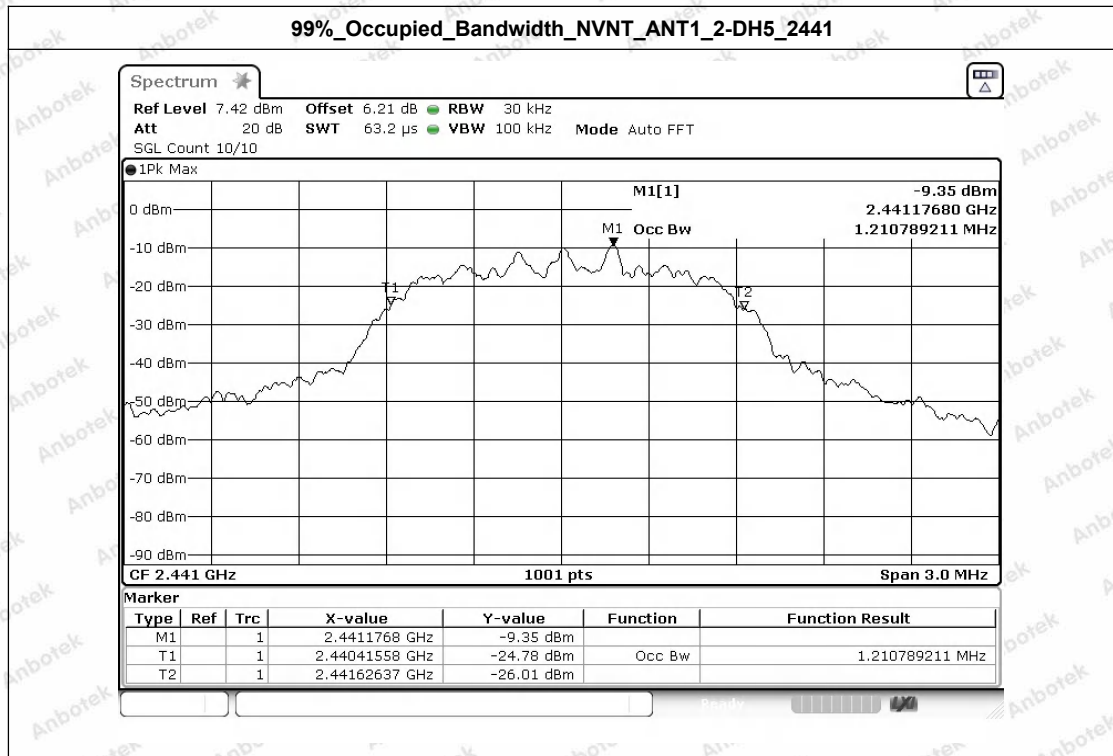
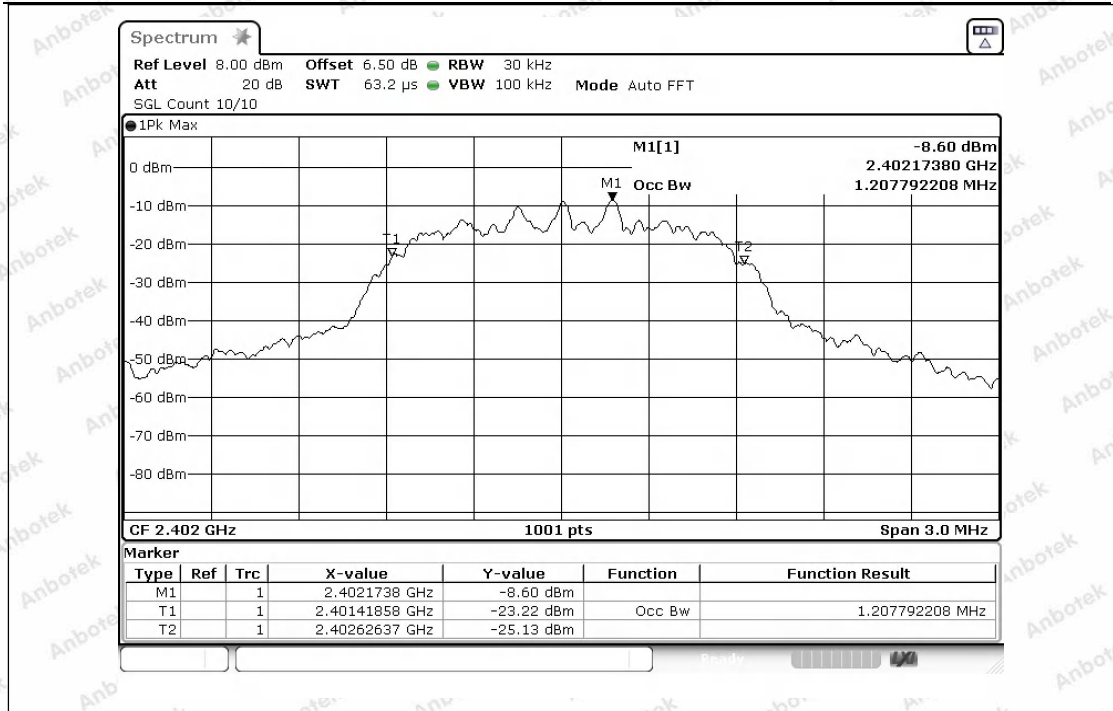

99%_Occupied_Bandwidth_NVNT_ANT1_2-DH5_2480

Shenzhen Anbotek Compliance Laboratory Limited

Address: 1/F., Building D, Sogood Science and Technology Park, Sanwei Community, Hangcheng Street, Bao'an District, Shenzhen, Guangdong, China.
 Tel: (86) 0755-26066440 Fax: (86) 0755-26014772 Email: service@anbotek.com

Hotline
 400-003-0500
www.anbotek.com.cn



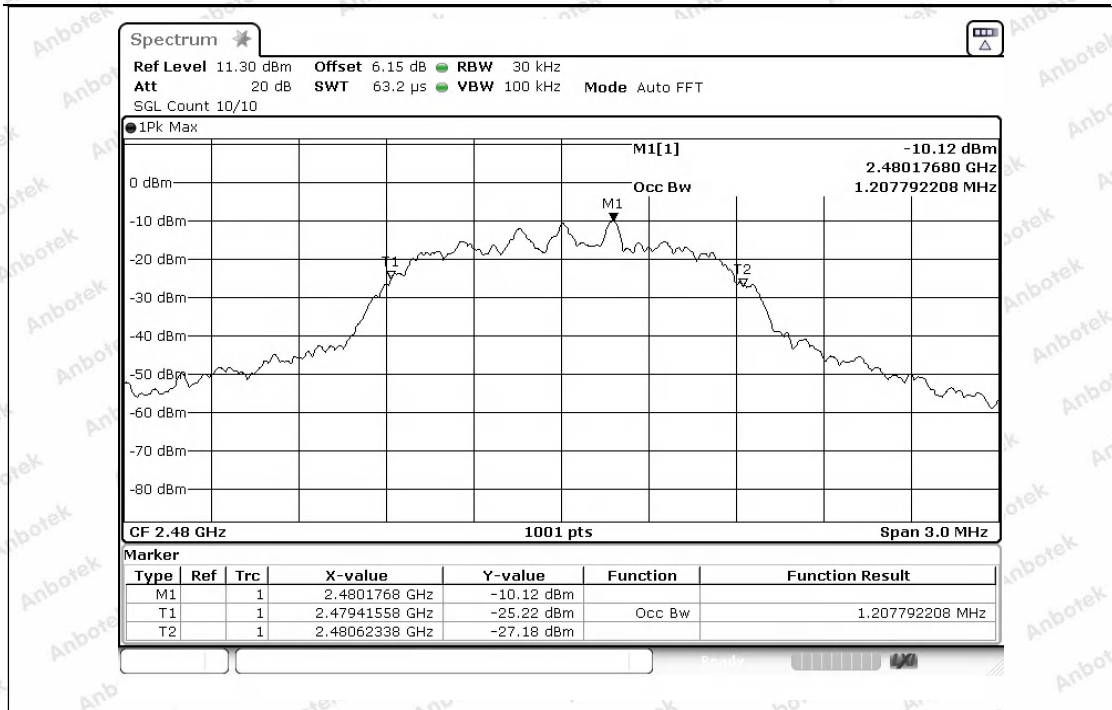

99%_Occupied_Bandwidth_NVNT_ANT1_3-DH5_2402

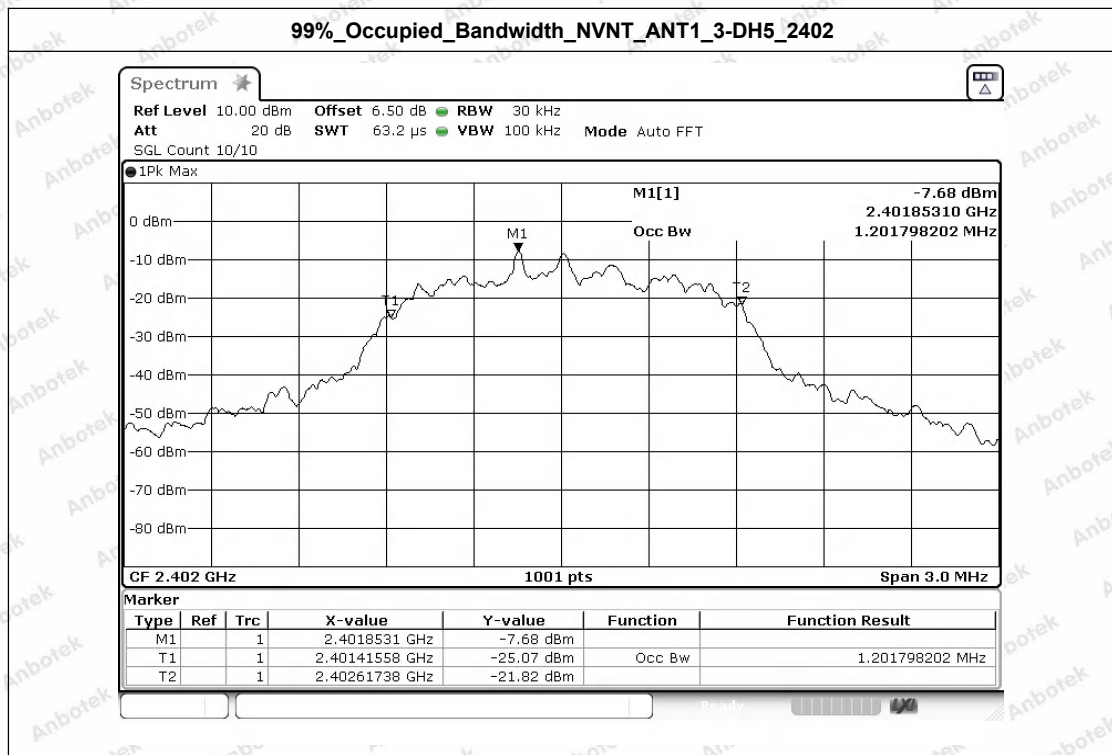

99%_Occupied_Bandwidth_NVNT_ANT1_3-DH5_2441

Shenzhen Anbotek Compliance Laboratory Limited

Address: 1/F., Building D, Sogood Science and Technology Park, Sanwei Community, Hangcheng Street, Bao'an District, Shenzhen, Guangdong, China.
 Tel: (86) 0755-26066440 Fax: (86) 0755-26014772 Email: service@anbotek.com

Hotline
 400-003-0500
 www.anbotek.com.cn



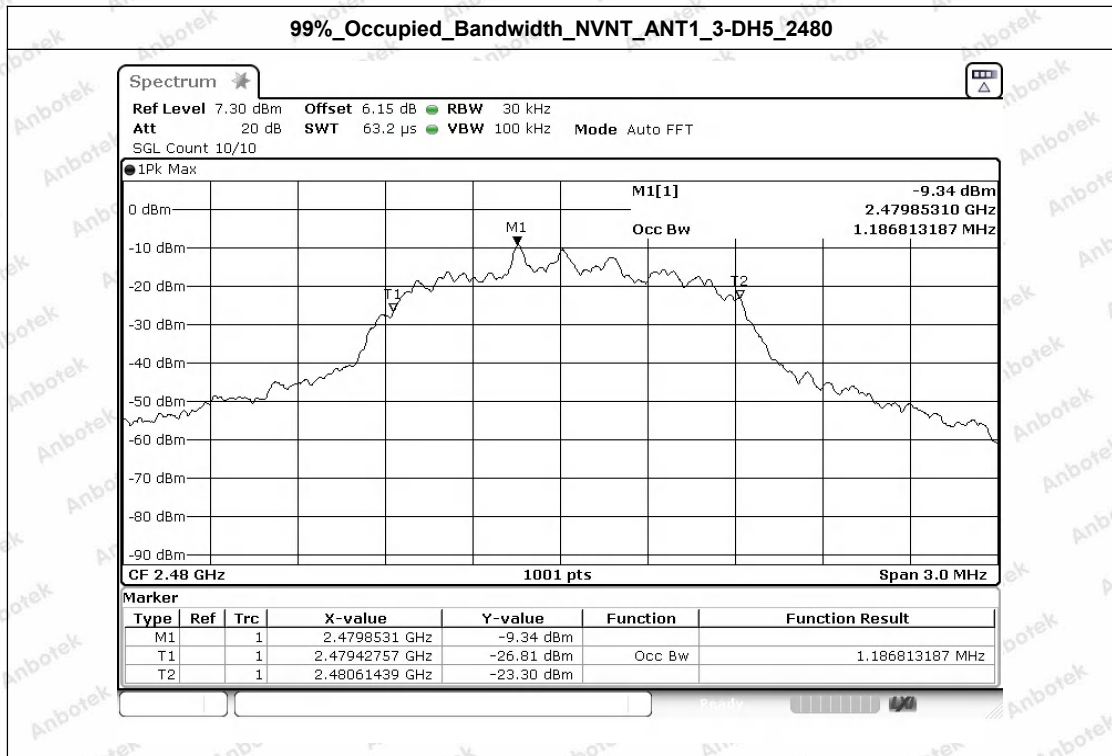
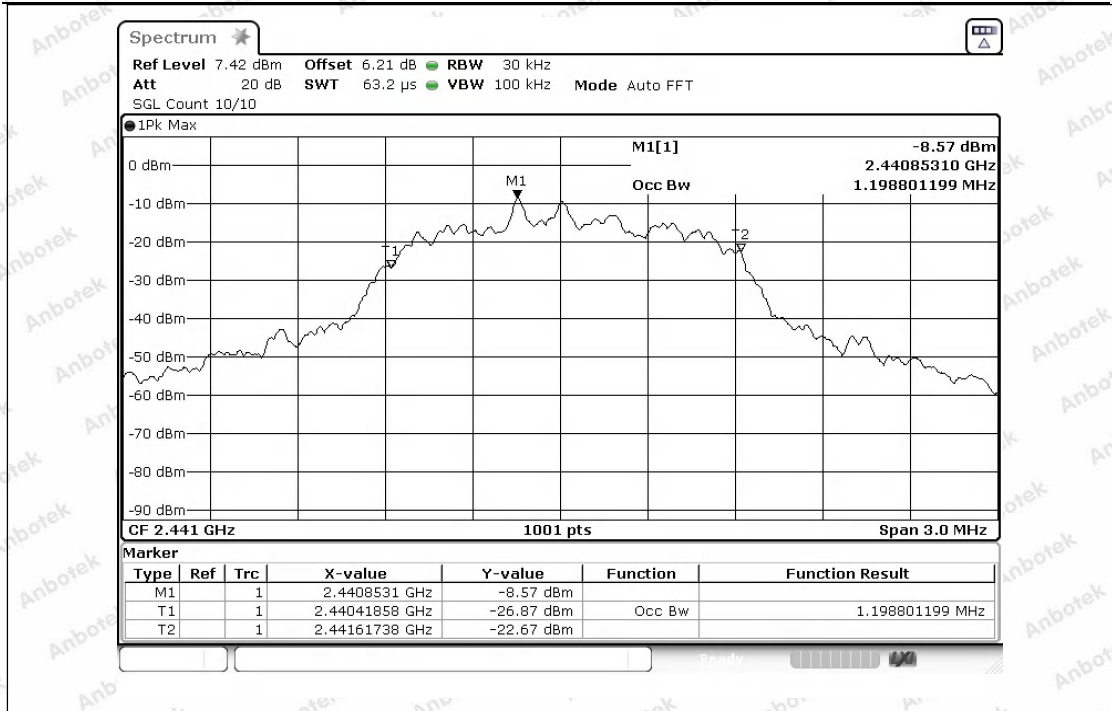

Shenzhen Anbotek Compliance Laboratory Limited

Address: 1/F., Building D, Sogood Science and Technology Park, Sanwei Community, Hangcheng Street, Bao'an District, Shenzhen, Guangdong, China.
 Tel: (86) 0755-26066440 Fax: (86) 0755-26014772 Email: service@anbotek.com

Hotline
 400-003-0500
www.anbotek.com.cn



Appendix C: Peak Output Power

Condition	Antenna	Modulation	Frequency (MHz)	Max. Conducted Power(dBm)	Max. Conducted Power(mW)	Limit(mW)	Result
NVNT	ANT1	1-DH5	2402.00	-5.14	0.31	125	Pass
NVNT	ANT1	1-DH5	2441.00	-6.47	0.23	125	Pass
NVNT	ANT1	1-DH5	2480.00	-7.24	0.19	125	Pass
NVNT	ANT1	2-DH5	2402.00	-4.96	0.32	125	Pass
NVNT	ANT1	2-DH5	2441.00	-5.67	0.27	125	Pass
NVNT	ANT1	2-DH5	2480.00	-6.34	0.23	125	Pass
NVNT	ANT1	3-DH5	2402.00	-4.14	0.39	125	Pass
NVNT	ANT1	3-DH5	2441.00	-5.01	0.32	125	Pass
NVNT	ANT1	3-DH5	2480.00	-6.12	0.24	125	Pass

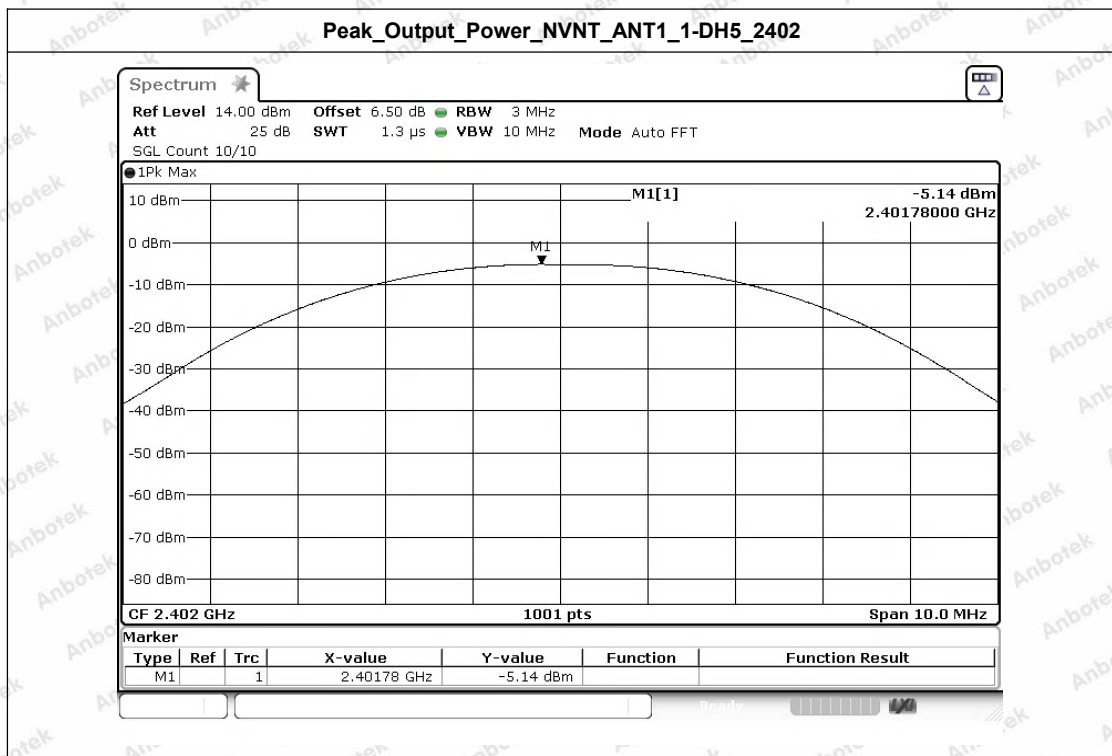

Peak_Output_Power_NVNT_ANT1_1-DH5_2441



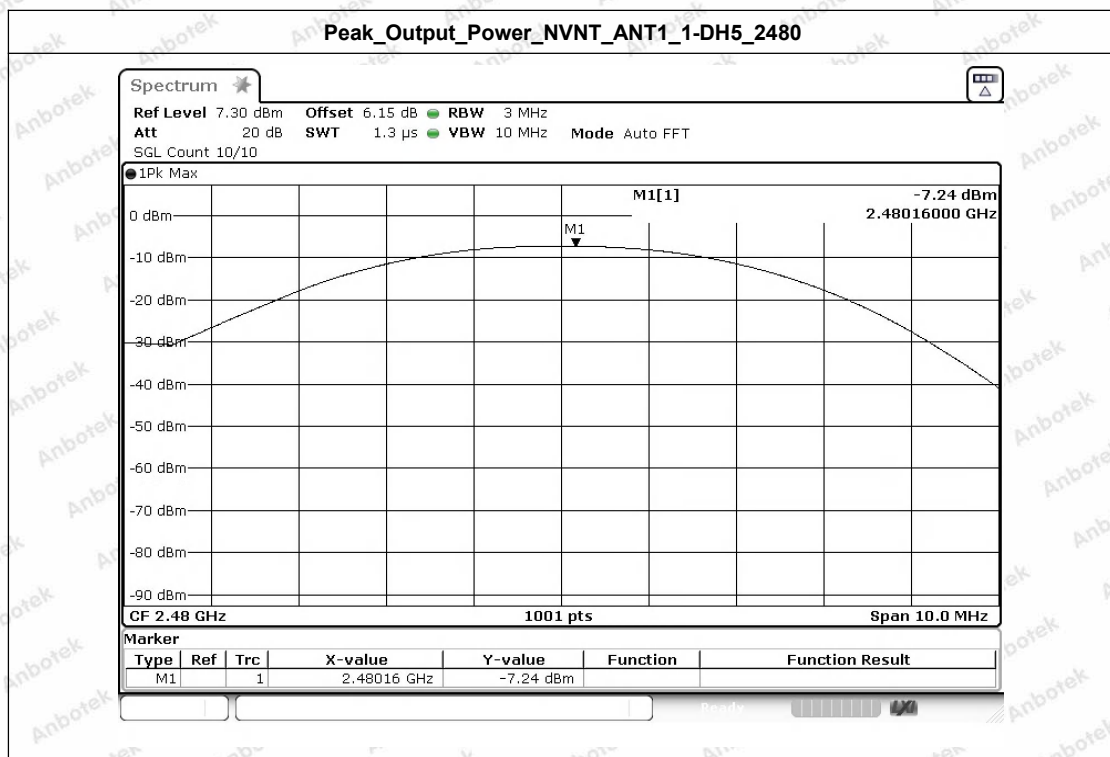
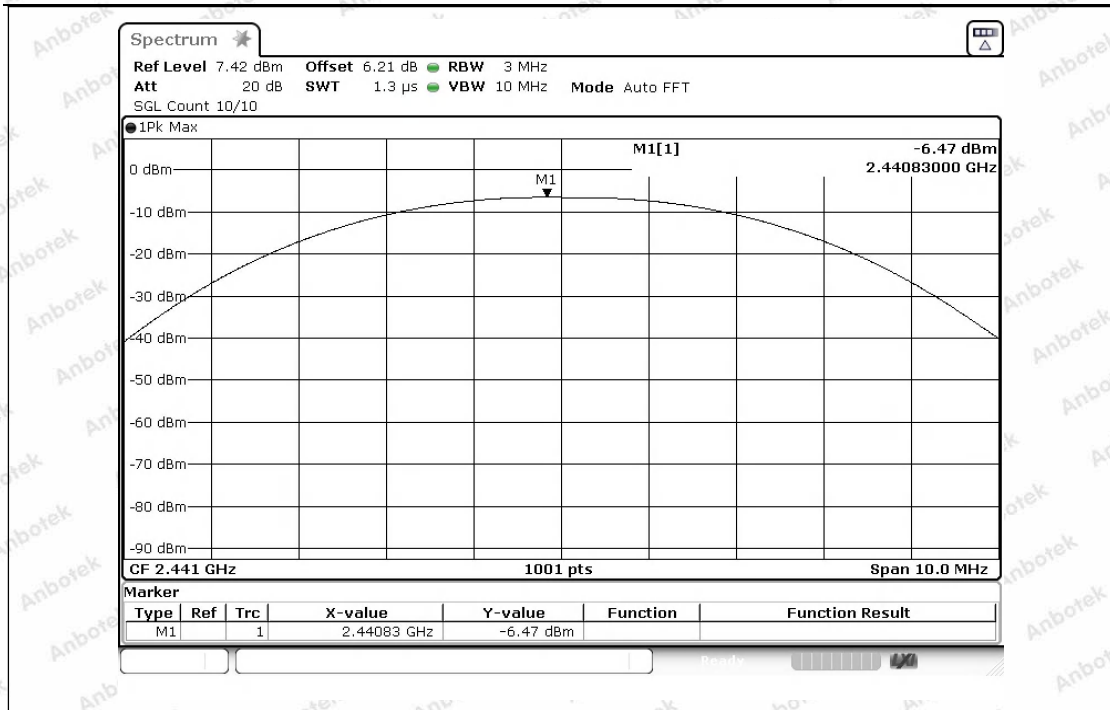

Peak Output Power NVNT_ANT1_2-DH5_2402



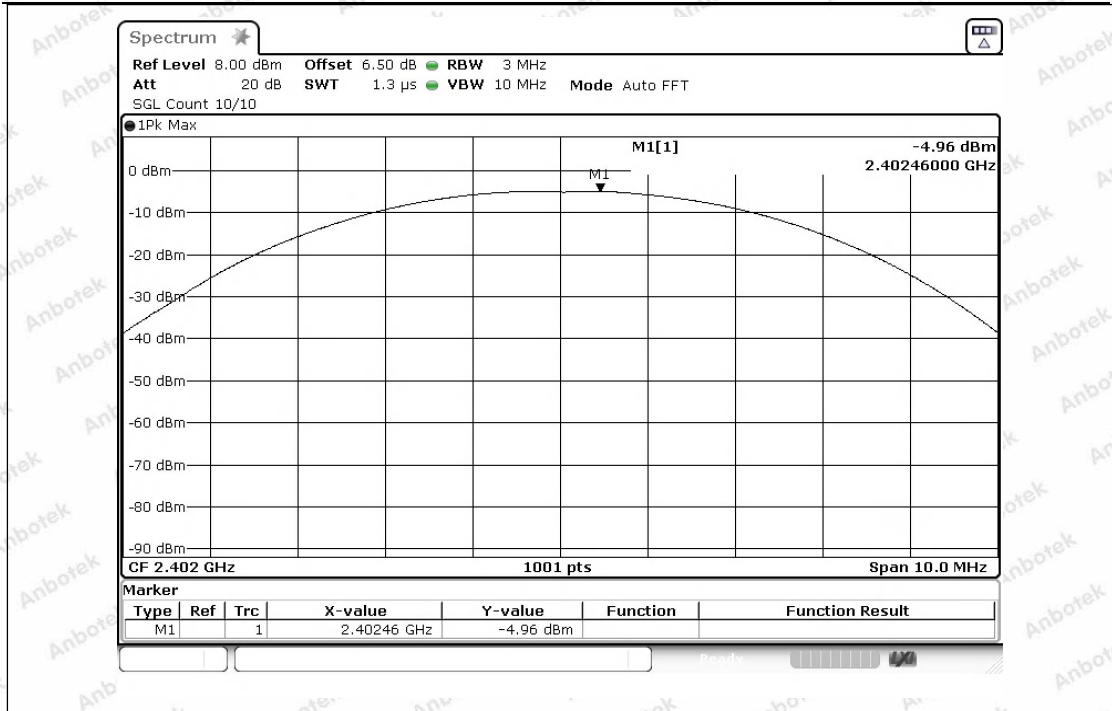

Peak_Output_Power_NVNT_ANT1_2-DH5_2441

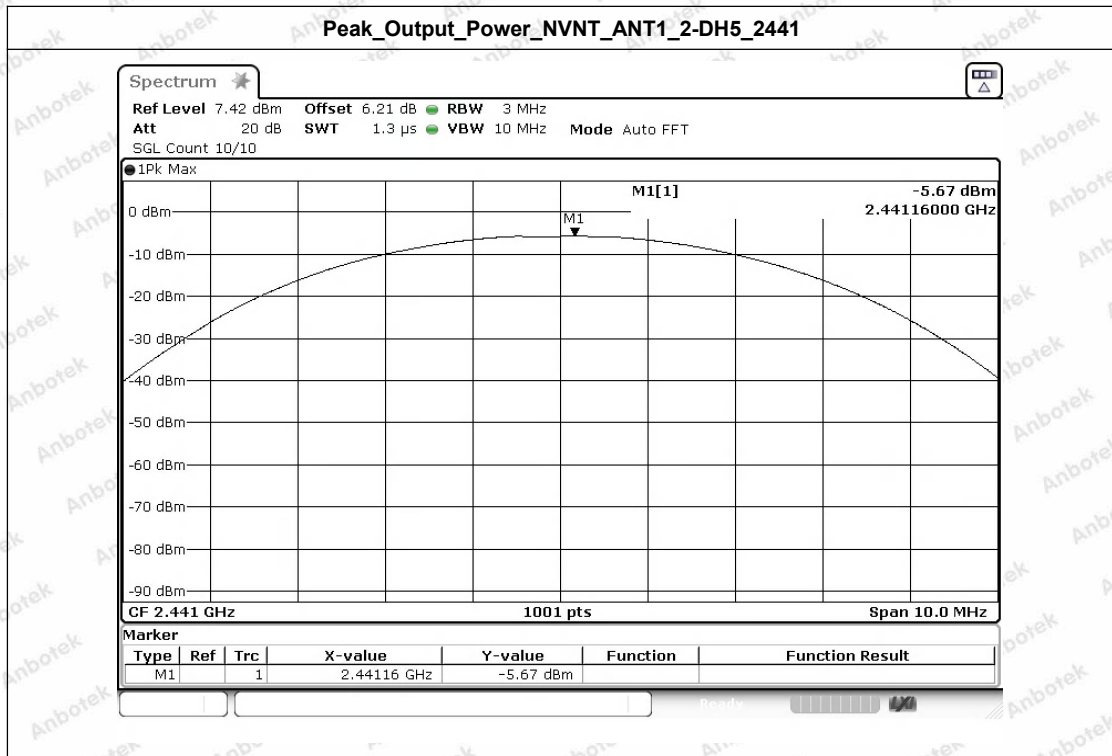

Peak_Output_Power_NVNT_ANT1_2-DH5_2480



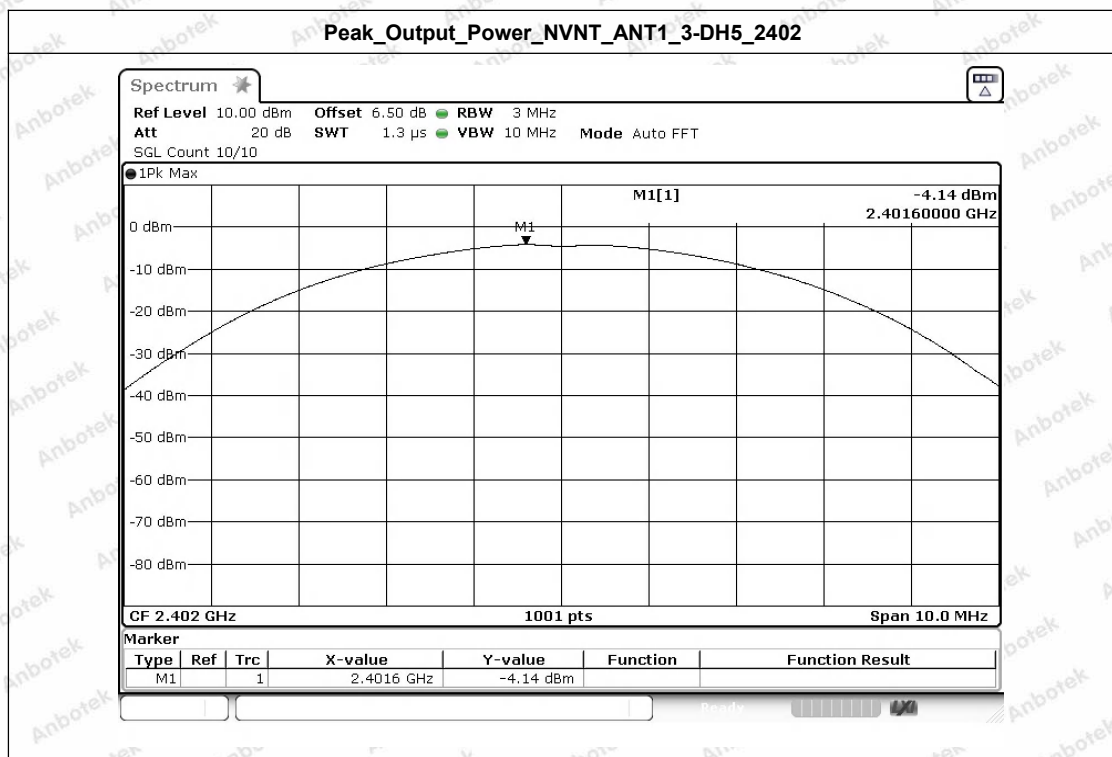
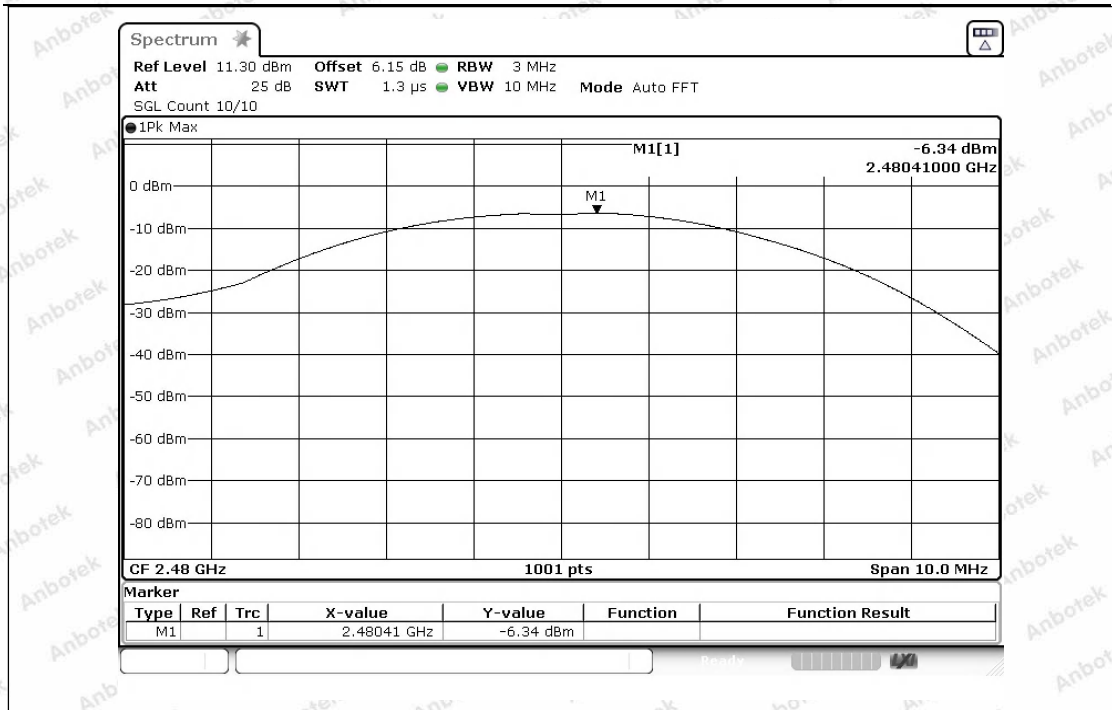

Peak_Output_Power_NVNT_ANT1_3-DH5_2441



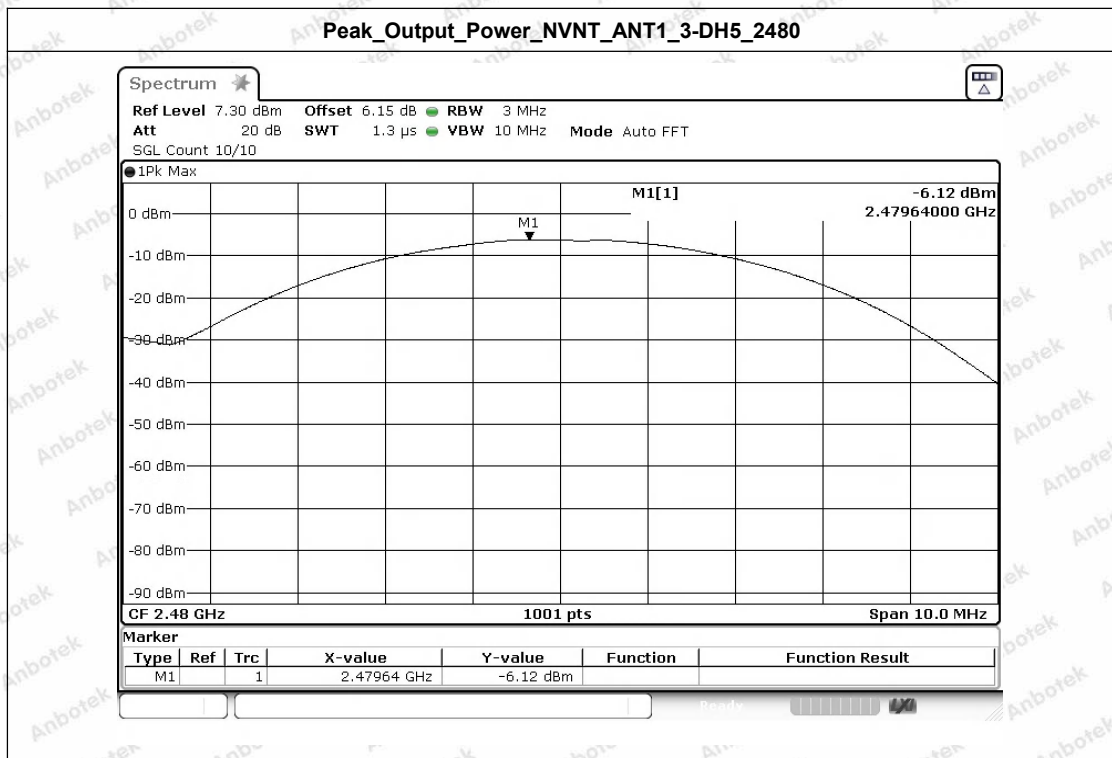
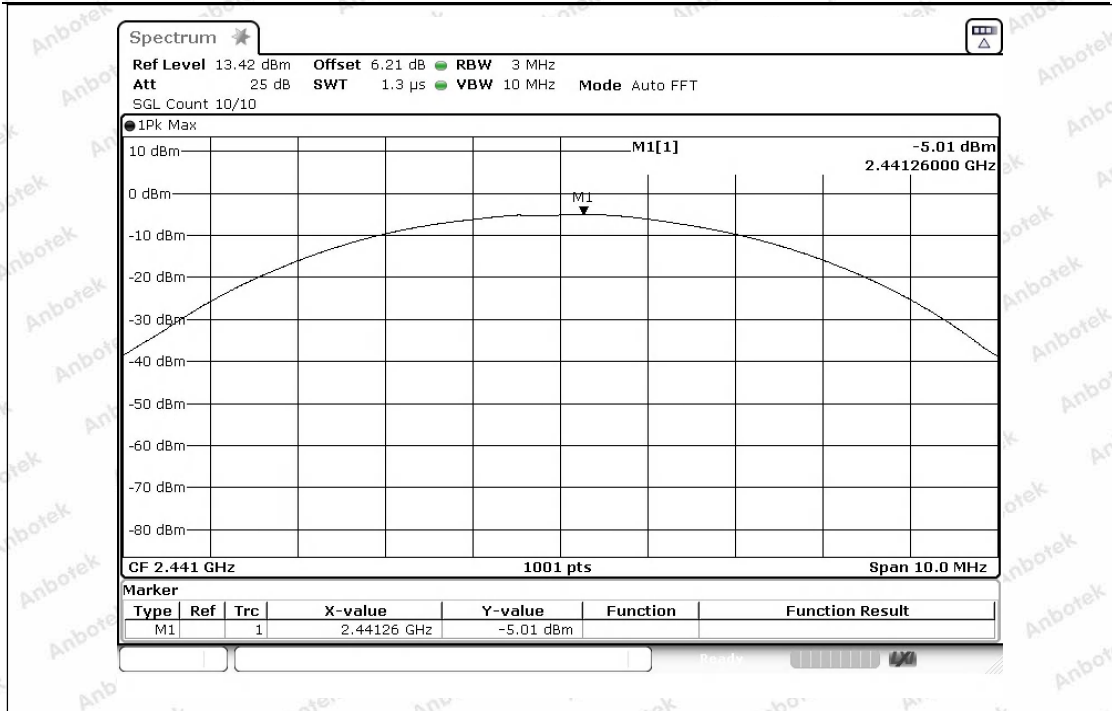

Shenzhen Anbotek Compliance Laboratory Limited

Address: 1/F., Building D, Sogood Science and Technology Park, Sanwei Community, Hangcheng Street, Bao'an District, Shenzhen, Guangdong, China.
 Tel: (86) 0755-26066440 Fax: (86) 0755-26014772 Email: service@anbotek.com

Hotline
 400-003-0500
www.anbotek.com.cn



Appendix D: Spurious Emissions

Condition	Antenna	Modulation	TX Mode	Spurious MAX.Value(dBm)	Limit	Result
NVNT	ANT1	1-DH5	2402.00	-50.439	-25.284	Pass
NVNT	ANT1	1-DH5	2441.00	-49.783	-26.779	Pass
NVNT	ANT1	1-DH5	2480.00	-51.548	-27.573	Pass
NVNT	ANT1	2-DH5	2402.00	-50.711	-25.988	Pass
NVNT	ANT1	2-DH5	2441.00	-54.205	-26.651	Pass
NVNT	ANT1	2-DH5	2480.00	-33.354	-27.529	Pass
NVNT	ANT1	3-DH5	2402.00	-51.772	-25.451	Pass
NVNT	ANT1	3-DH5	2441.00	-52.183	-26.489	Pass
NVNT	ANT1	3-DH5	2480.00	-52.359	-27.235	Pass

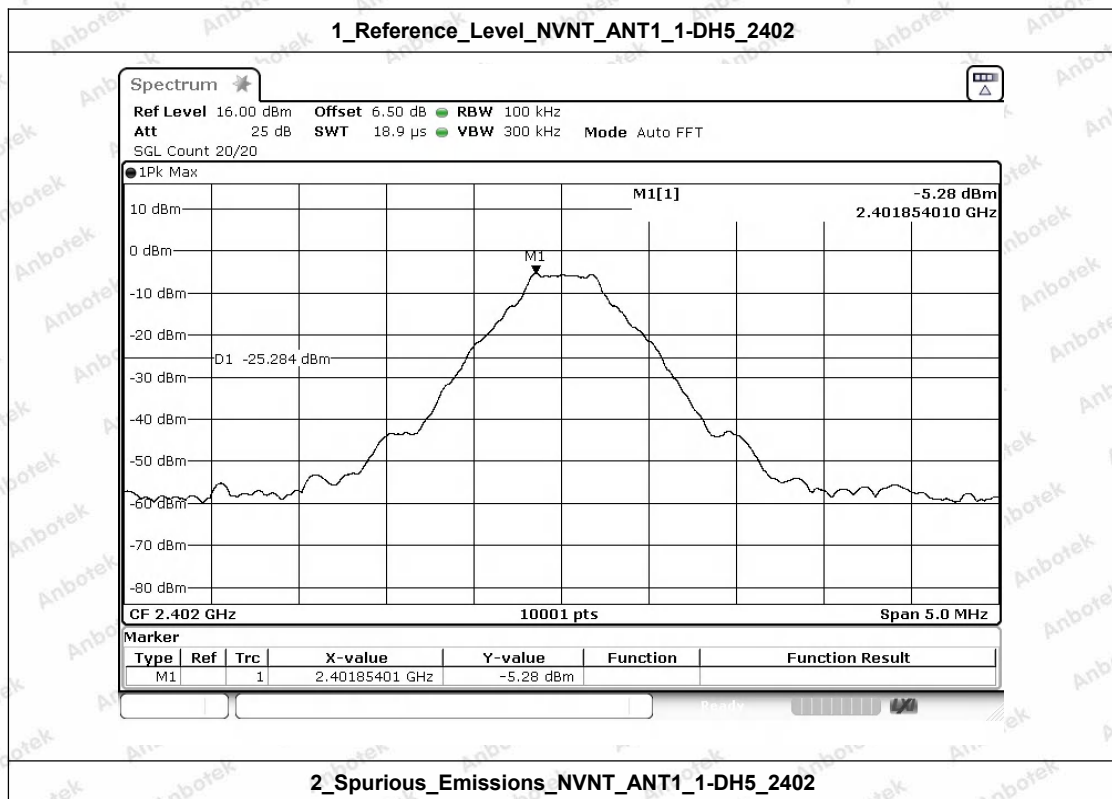

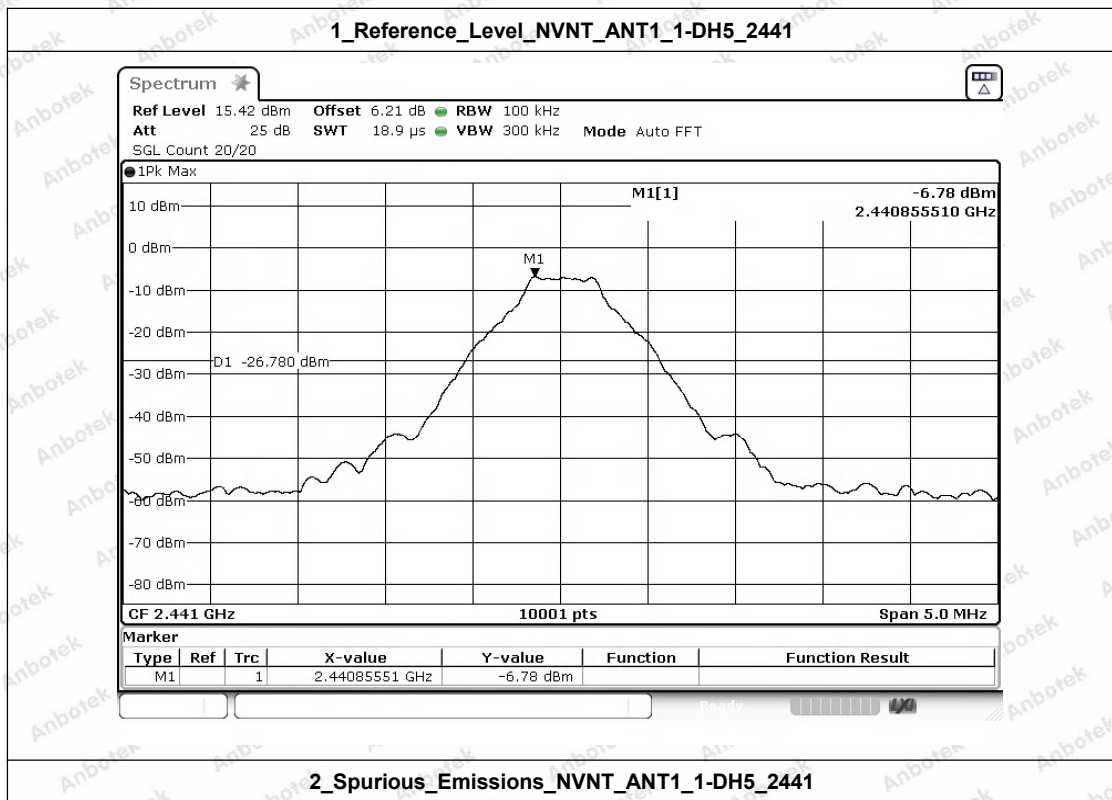
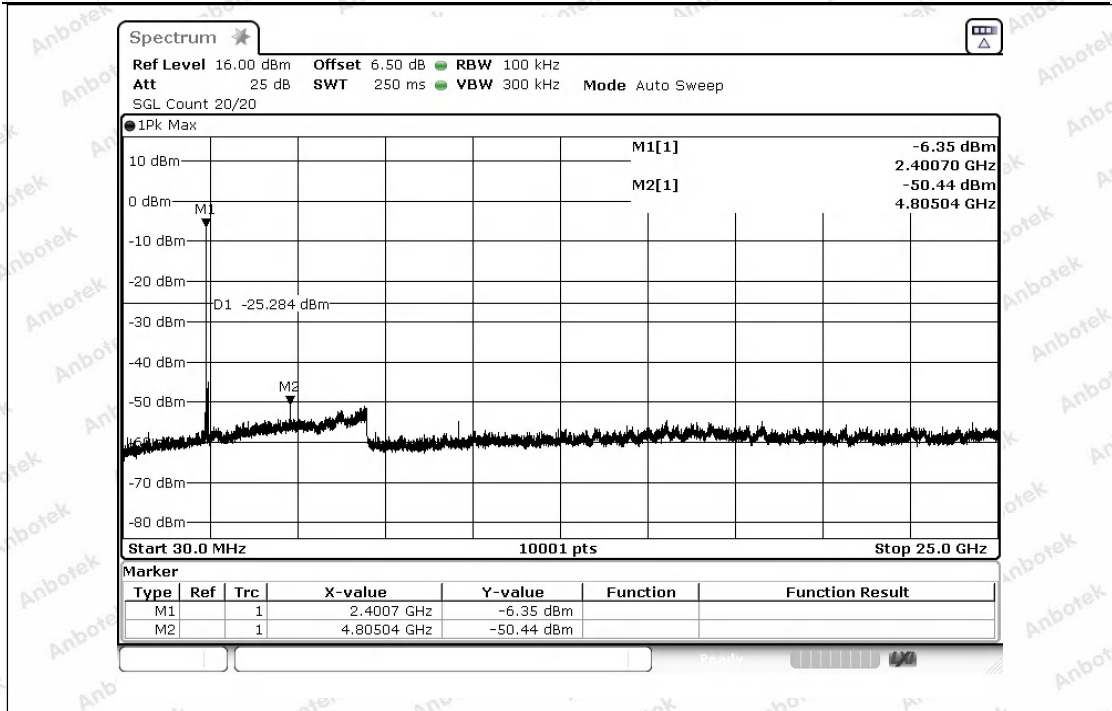

Shenzhen Anbotek Compliance Laboratory Limited

Address: 1/F., Building D, Sogood Science and Technology Park, Sanwei Community, Hangcheng Street, Bao'an District, Shenzhen, Guangdong, China.
 Tel: (86) 0755-26066440 Fax: (86) 0755-26014772 Email: service@anbotek.com

Hotline
 400-003-0500
 www.anbotek.com.cn



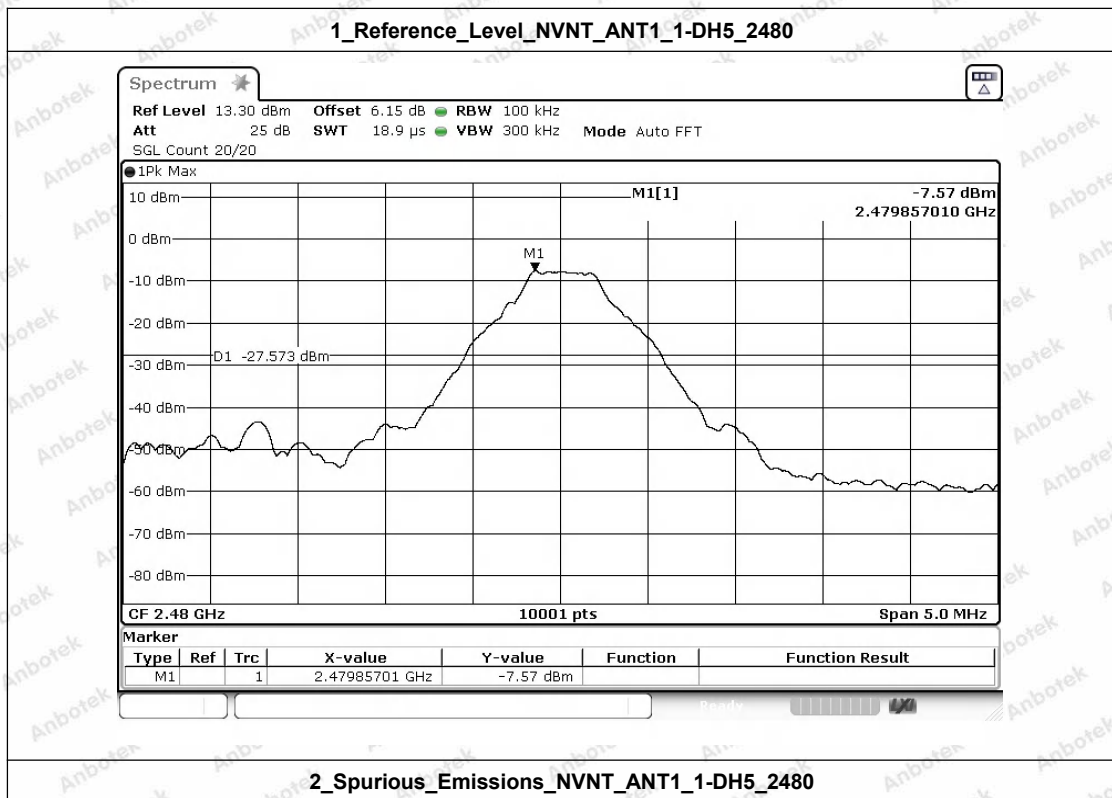
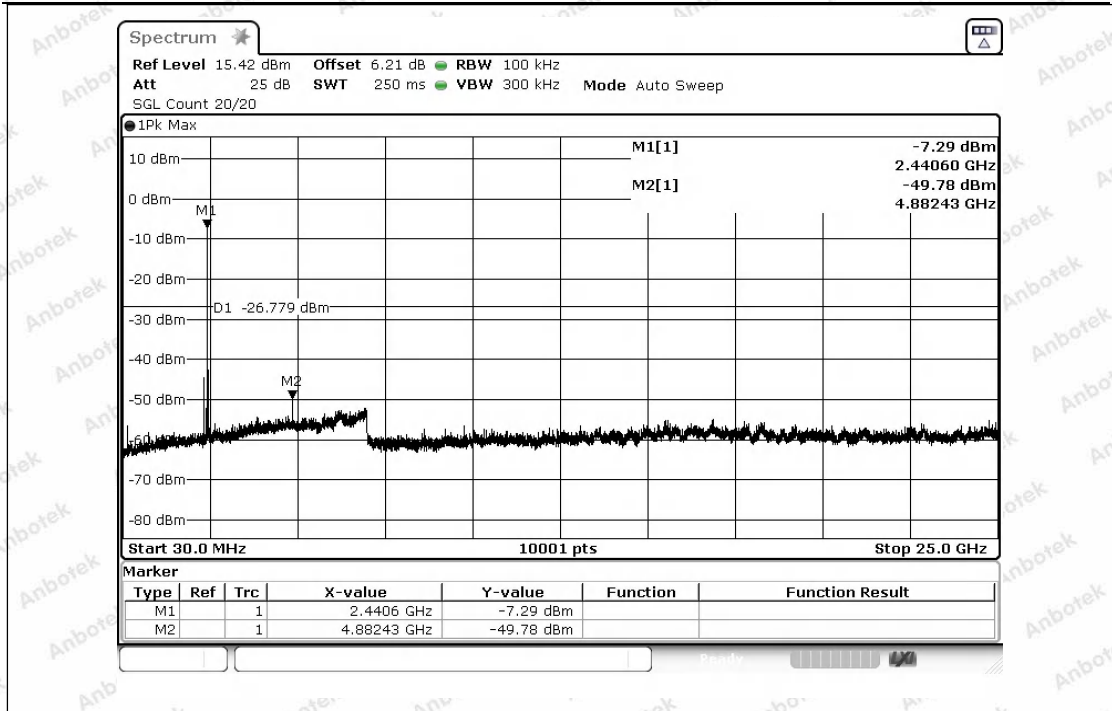

2_Spurious_Emissions_NVNT_ANT1_1-DH5_2480

Shenzhen Anbotek Compliance Laboratory Limited

Address: 1/F., Building D, Sogood Science and Technology Park, Sanwei Community, Hangcheng Street, Bao'an District, Shenzhen, Guangdong, China.
 Tel: (86) 0755-26066440 Fax: (86) 0755-26014772 Email: service@anbotek.com

Hotline 400-003-0500
 www.anbotek.com.cn



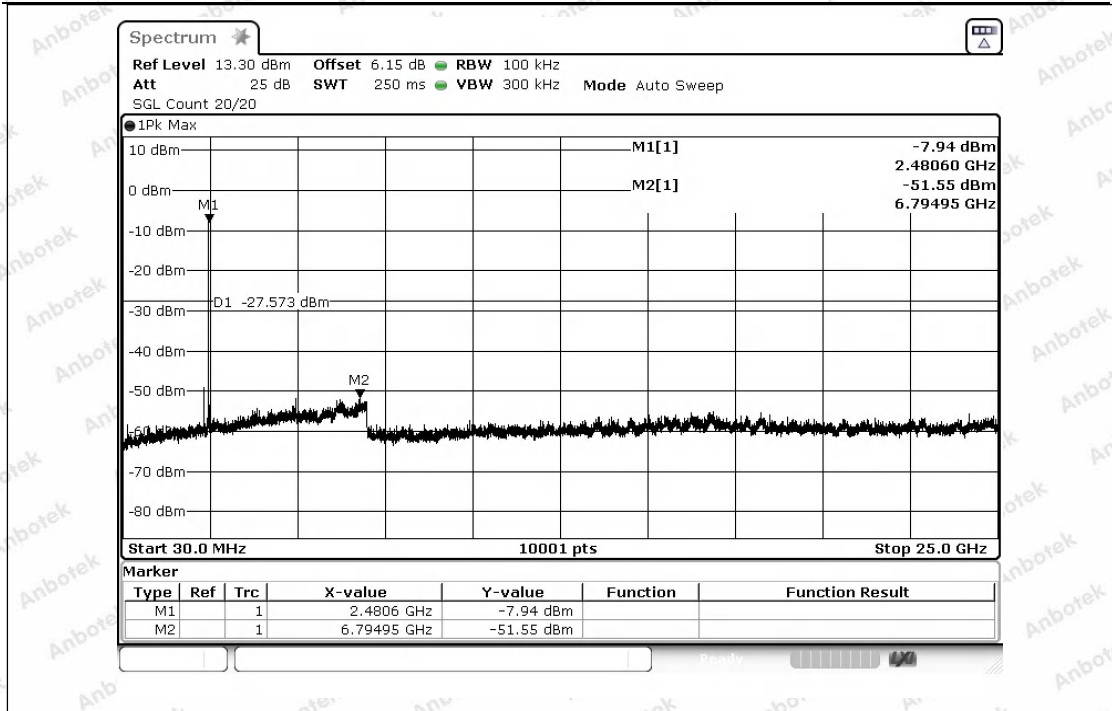

1_Reference_Level_NVNT_ANT1_2-DH5_2402

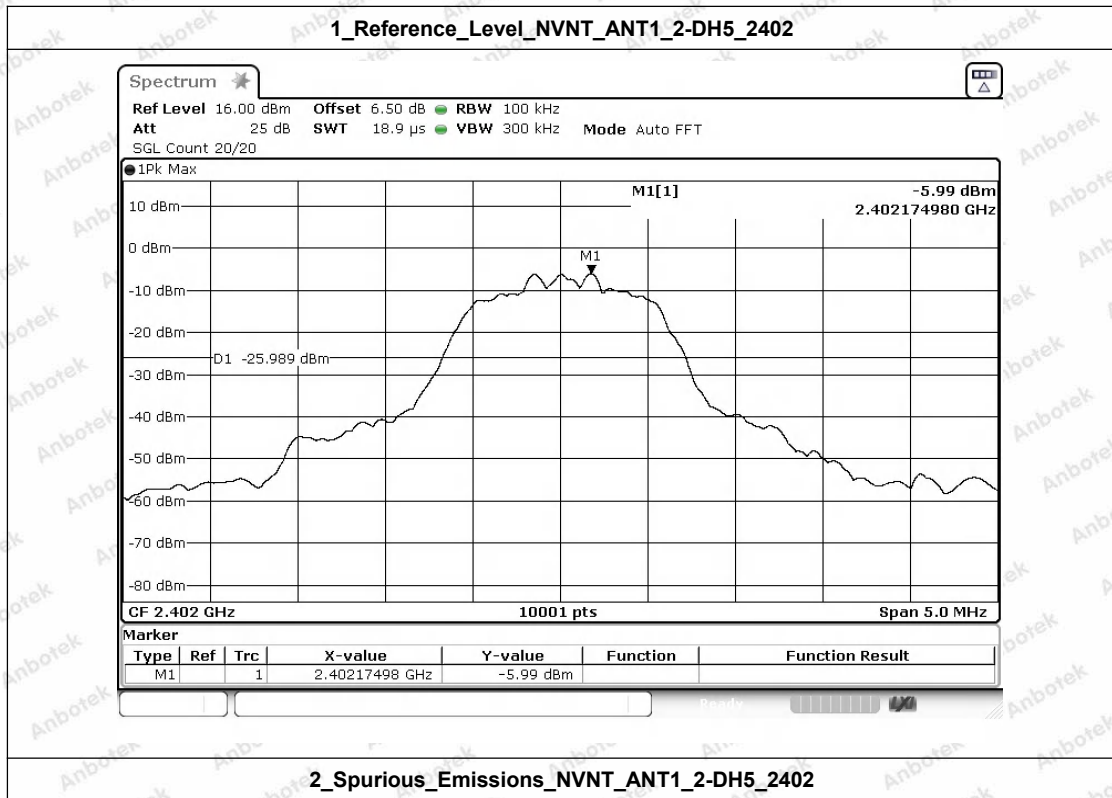

2_Spurious_Emissions_NVNT_ANT1_2-DH5_2402

Shenzhen Anbotek Compliance Laboratory Limited

Address: 1/F., Building D, Sogood Science and Technology Park, Sanwei Community, Hangcheng Street, Bao'an District, Shenzhen, Guangdong, China.
 Tel: (86) 0755-26066440 Fax: (86) 0755-26014772 Email: service@anbotek.com

Hotline
 400-003-0500
 www.anbotek.com.cn



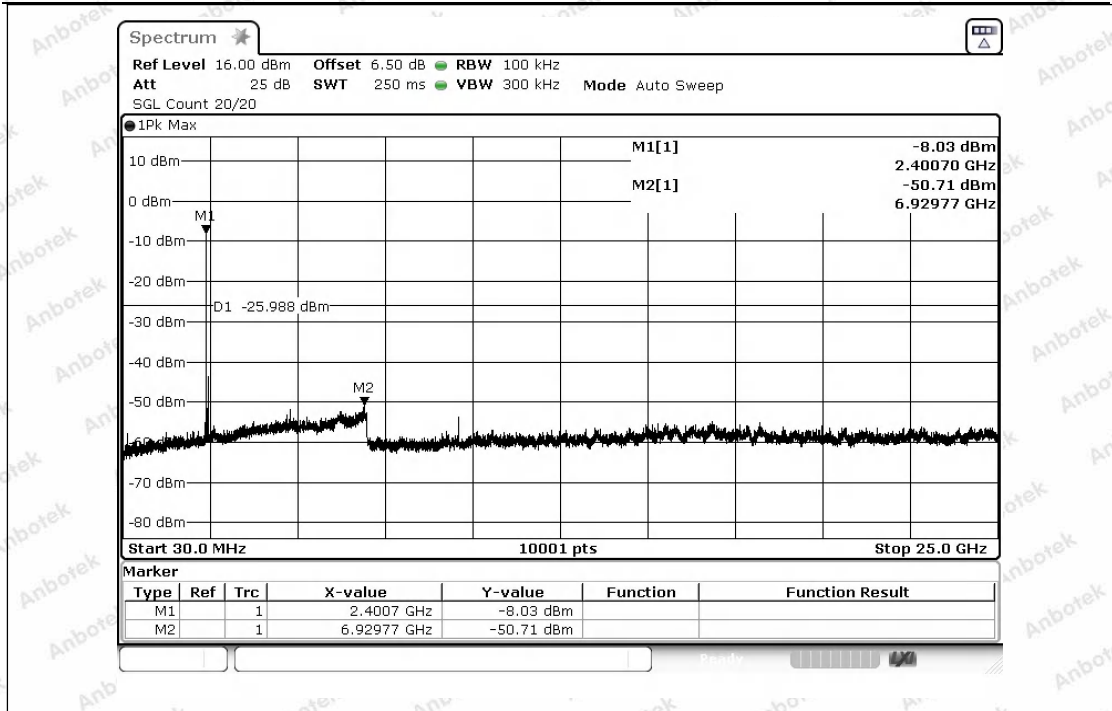

1_Reference_Level_NVNT_ANT1_2-DH5_2441

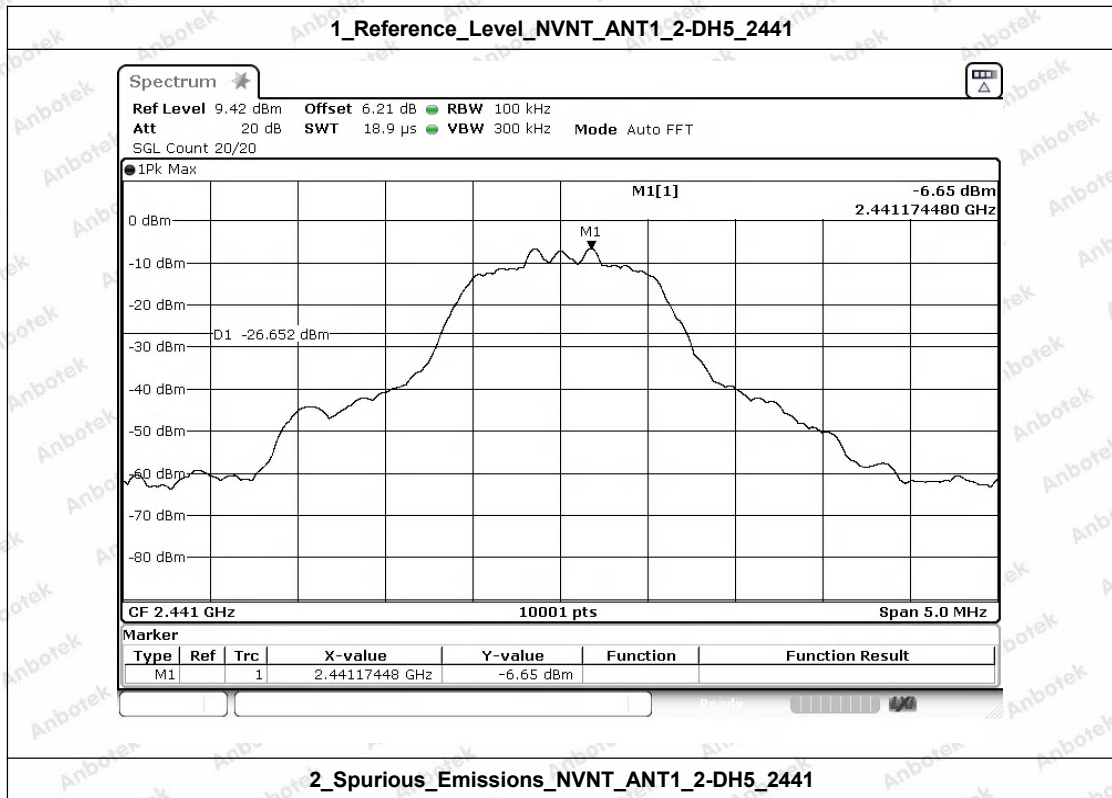

2_Spurious_Emissions_NVNT_ANT1_2-DH5_2441

Shenzhen Anbotek Compliance Laboratory Limited

Address: 1/F., Building D, Sogood Science and Technology Park, Sanwei Community, Hangcheng Street, Bao'an District, Shenzhen, Guangdong, China.
 Tel: (86) 0755-26066440 Fax: (86) 0755-26014772 Email: service@anbotek.com

Hotline
 400-003-0500
www.anbotek.com.cn



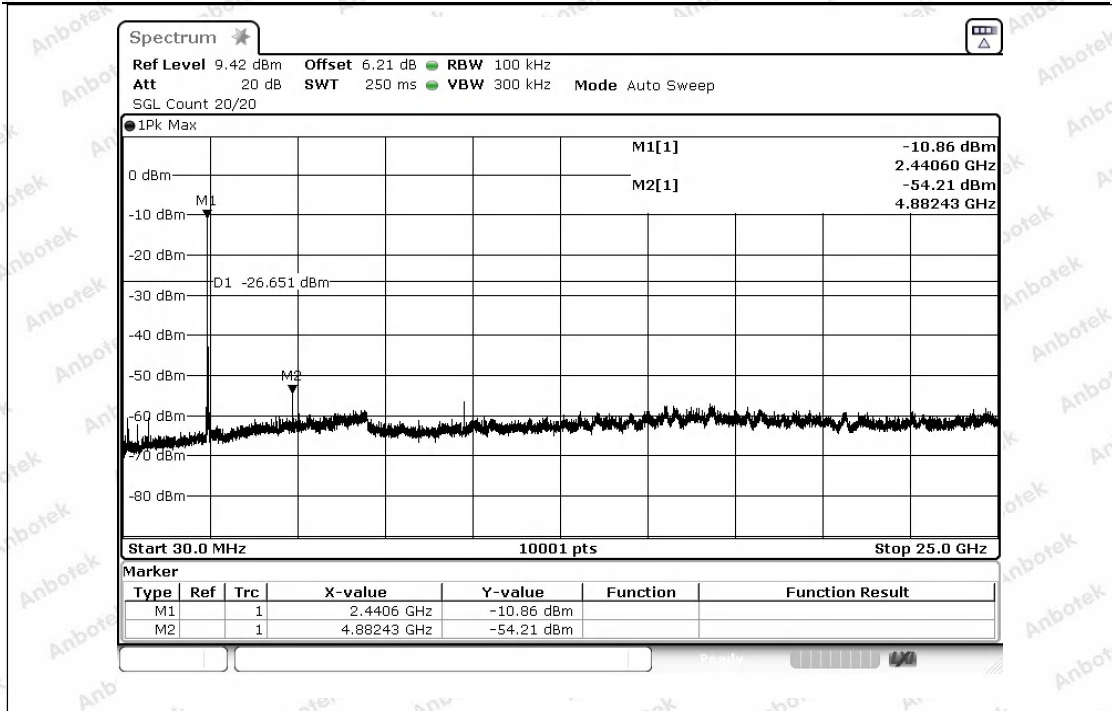

1_Reference_Level_NVNT_ANT1_2-DH5_2480

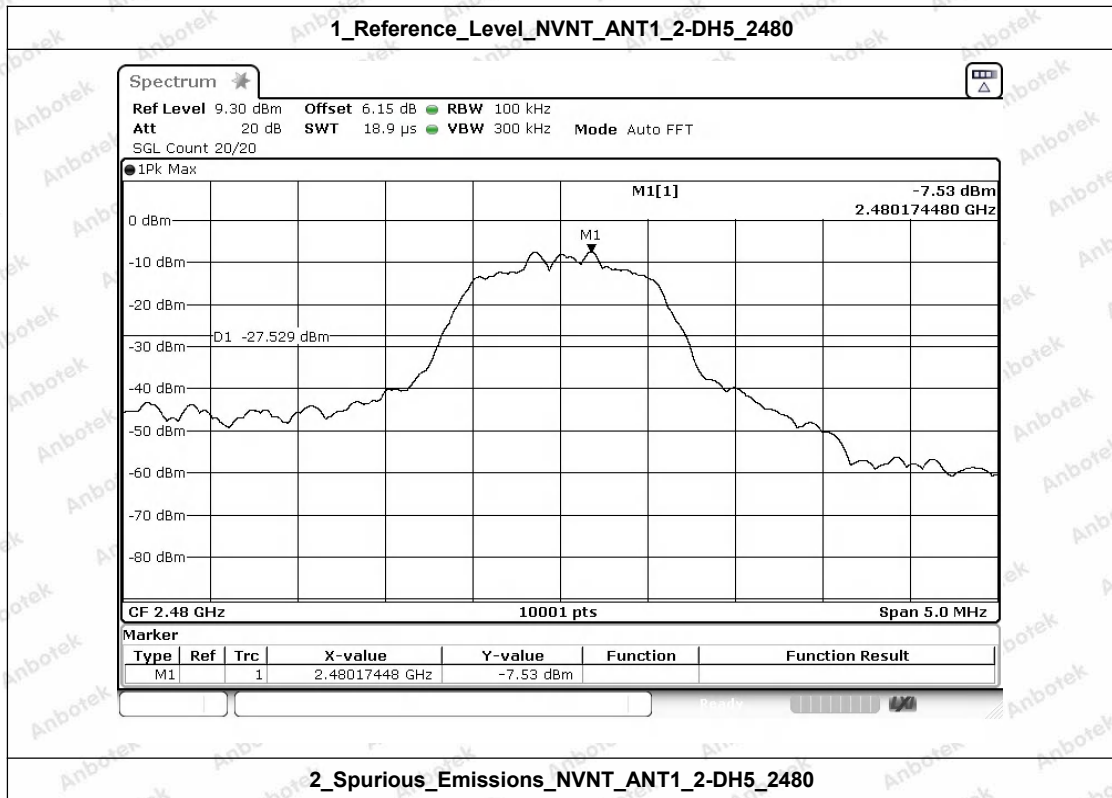

2_Spurious_Emissions_NVNT_ANT1_2-DH5_2480

Shenzhen Anbotek Compliance Laboratory Limited

Address: 1/F., Building D, Sogood Science and Technology Park, Sanwei Community, Hangcheng Street, Bao'an District, Shenzhen, Guangdong, China.
 Tel: (86) 0755-26066440 Fax: (86) 0755-26014772 Email: service@anbotek.com

Hotline 400-003-0500
 www.anbotek.com.cn



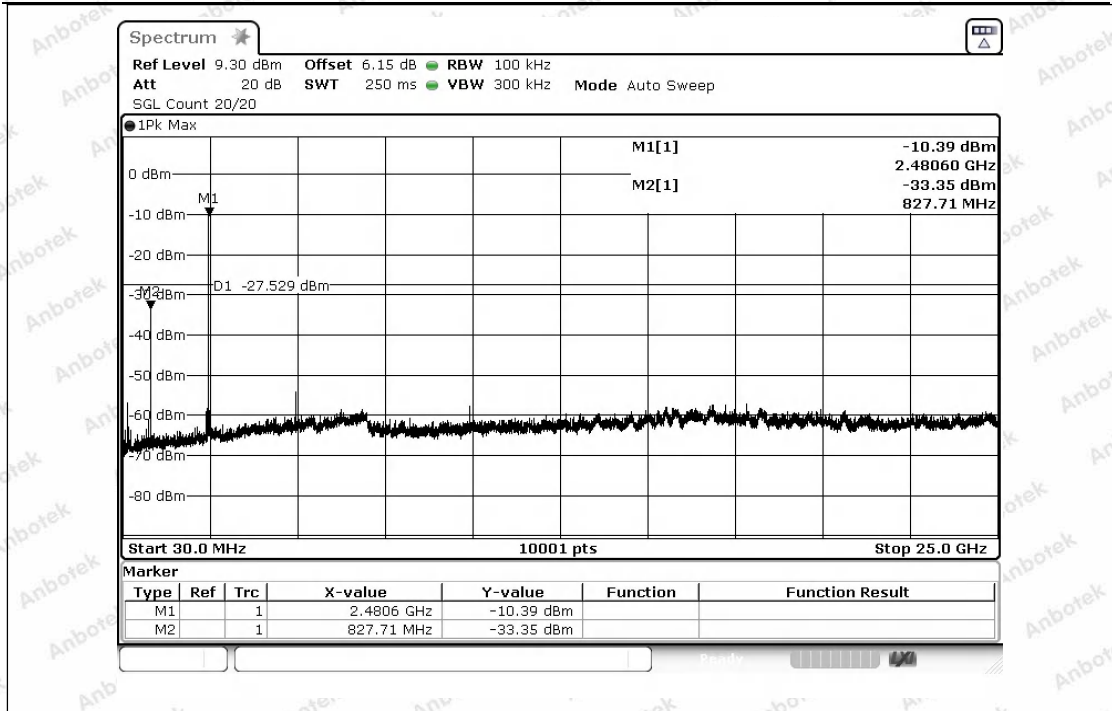

1_Reference_Level_NVNT_ANT1_3-DH5_2402

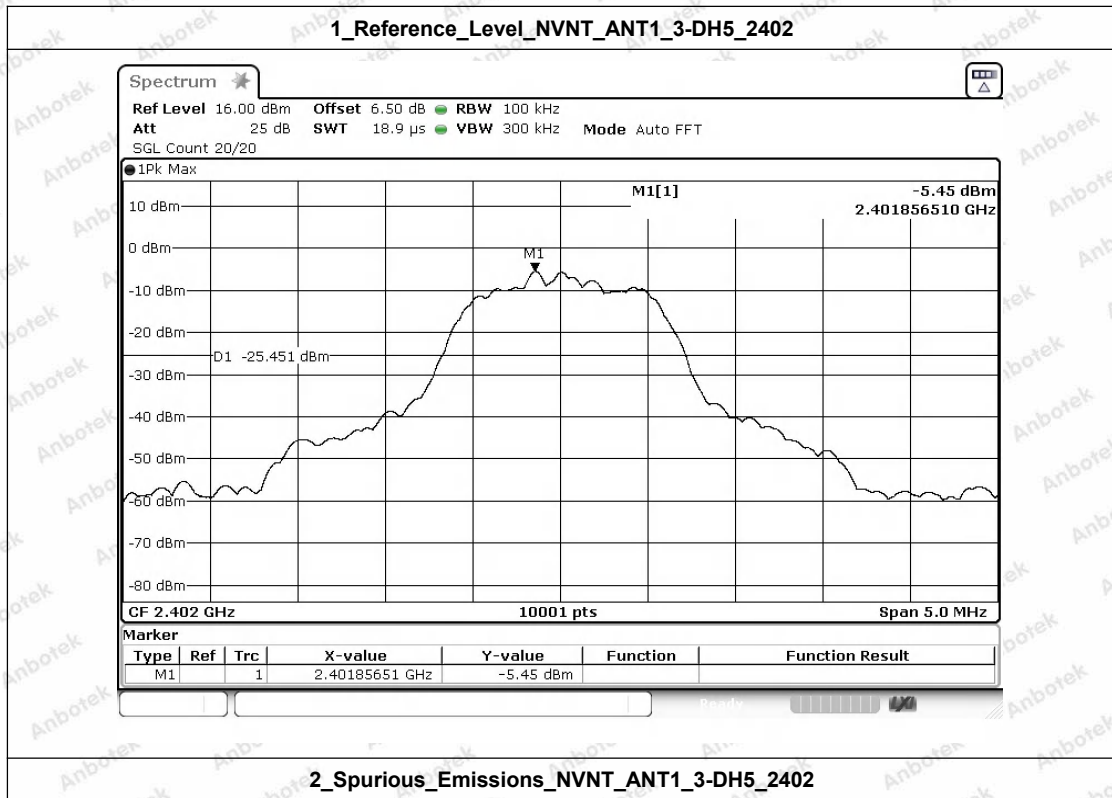

2_Spurious_Emissions_NVNT_ANT1_3-DH5_2402

Shenzhen Anbotek Compliance Laboratory Limited

Address: 1/F., Building D, Sogood Science and Technology Park, Sanwei Community, Hangcheng Street, Bao'an District, Shenzhen, Guangdong, China.
 Tel: (86) 0755-26066440 Fax: (86) 0755-26014772 Email: service@anbotek.com

Hotline
 400-003-0500
www.anbotek.com.cn



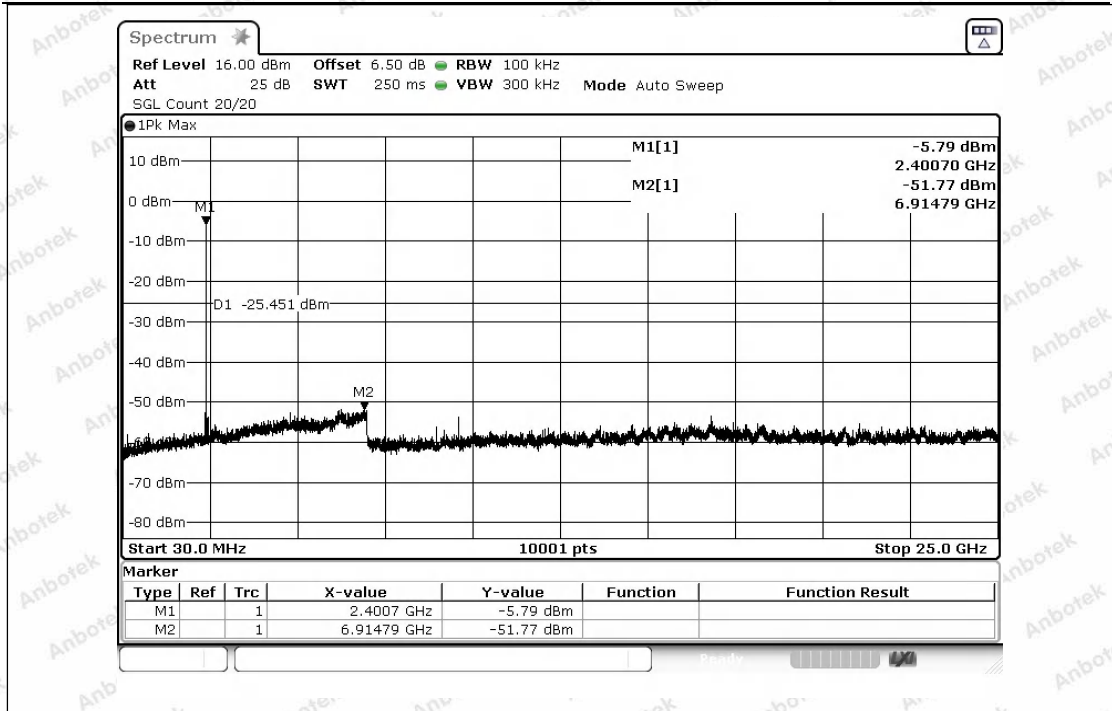

1_Reference_Level_NVNT_ANT1_3-DH5_2441

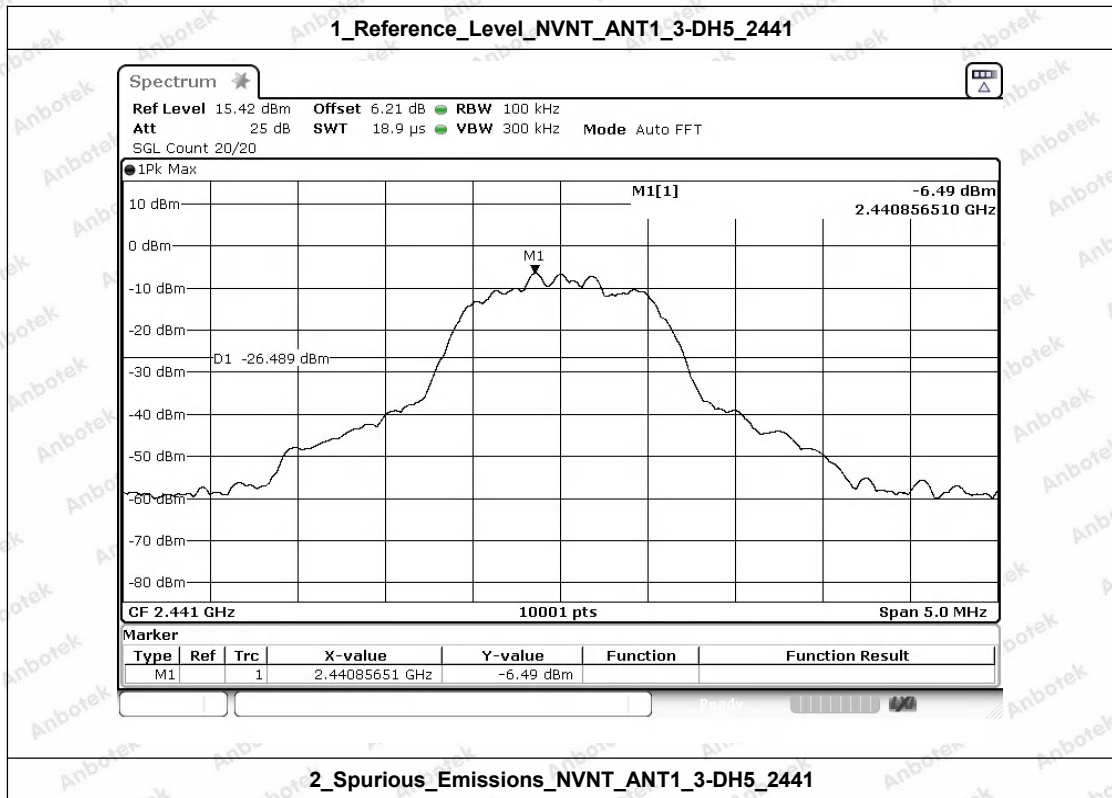

2_Spurious_Emissions_NVNT_ANT1_3-DH5_2441

Shenzhen Anbotek Compliance Laboratory Limited

Address: 1/F., Building D, Sogood Science and Technology Park, Sanwei Community, Hangcheng Street, Bao'an District, Shenzhen, Guangdong, China.
 Tel: (86) 0755-26066440 Fax: (86) 0755-26014772 Email: service@anbotek.com

Hotline
 400-003-0500
 www.anbotek.com.cn



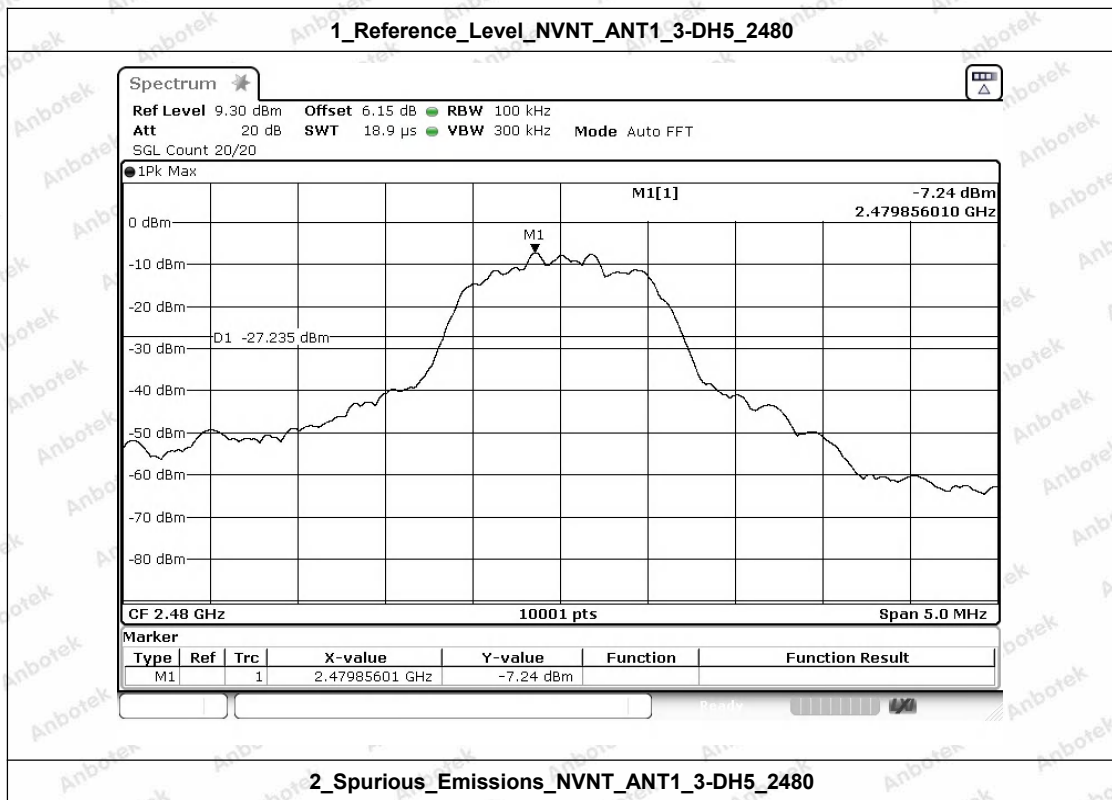
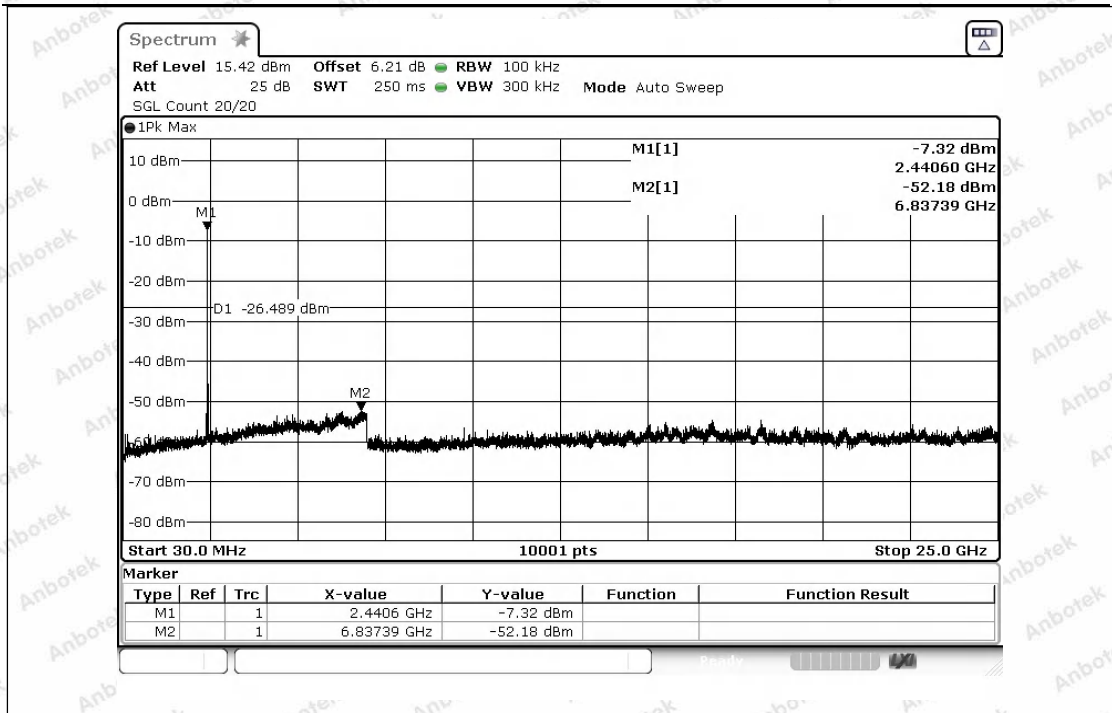

2_Spurious_Emissions_NVNT_ANT1_3-DH5_2480

Shenzhen Anbotek Compliance Laboratory Limited

Address: 1/F., Building D, Sogood Science and Technology Park, Sanwei Community, Hangcheng Street, Bao'an District, Shenzhen, Guangdong, China.
 Tel: (86) 0755-26066440 Fax: (86) 0755-26014772 Email: service@anbotek.com

Hotline 400-003-0500
 www.anbotek.com.cn



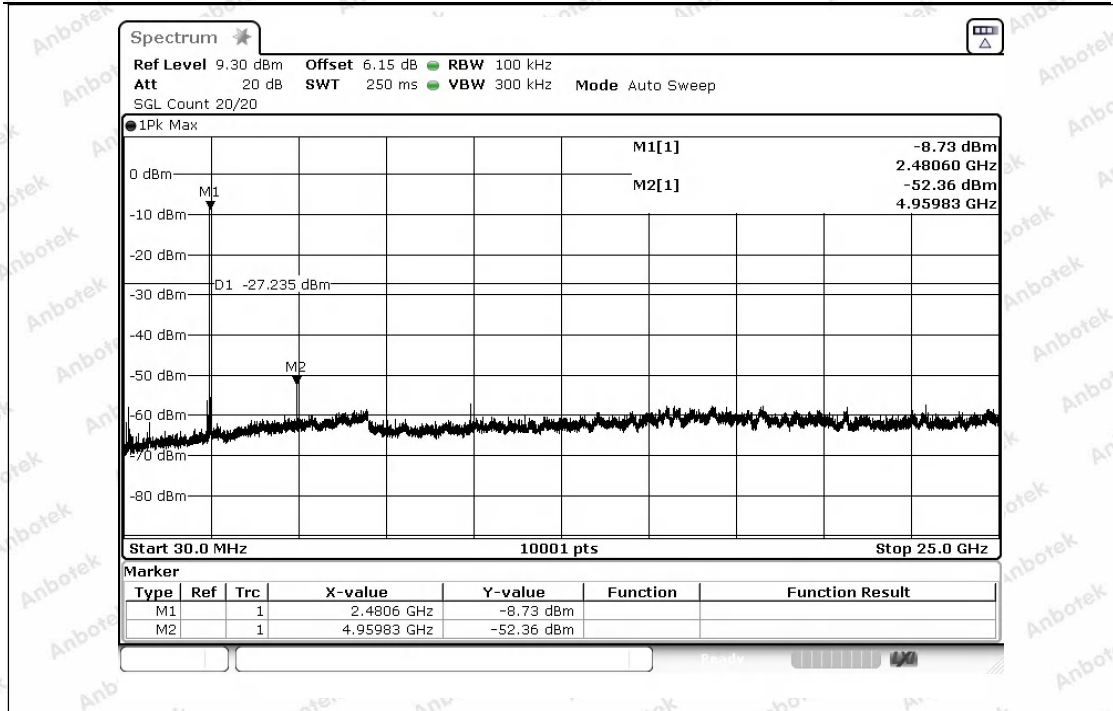

Shenzhen Anbotek Compliance Laboratory Limited

Address: 1/F., Building D, Sogood Science and Technology Park, Sanwei Community, Hangcheng Street, Bao'an District, Shenzhen, Guangdong, China.
 Tel: (86) 0755-26066440 Fax: (86) 0755-26014772 Email: service@anbotek.com



Hotline
 400-003-0500
 www.anbotek.com.cn



Appendix E: Bandedge

Condition	Antenna	Modulation	TX Mode	Bandedge MAX.Value	Limit	Result
NVNT	ANT1	1-DH5	2402.00	-57.135	-25.284	Pass
NVNT	ANT1	1-DH5	Hopping_LCH	-51.403	-25.896	Pass
NVNT	ANT1	1-DH5	2480.00	-56.283	-27.573	Pass
NVNT	ANT1	1-DH5	Hopping_HCH	-52.562	-26.179	Pass
NVNT	ANT1	2-DH5	2402.00	-55.873	-25.988	Pass
NVNT	ANT1	2-DH5	Hopping_LCH	-54.778	-25.434	Pass
NVNT	ANT1	2-DH5	2480.00	-60.787	-27.529	Pass
NVNT	ANT1	2-DH5	Hopping_HCH	-54.860	-26.220	Pass
NVNT	ANT1	3-DH5	2402.00	-56.535	-25.451	Pass
NVNT	ANT1	3-DH5	Hopping_LCH	-53.362	-25.089	Pass
NVNT	ANT1	3-DH5	2480.00	-59.781	-27.235	Pass
NVNT	ANT1	3-DH5	Hopping_HCH	-53.779	-25.927	Pass

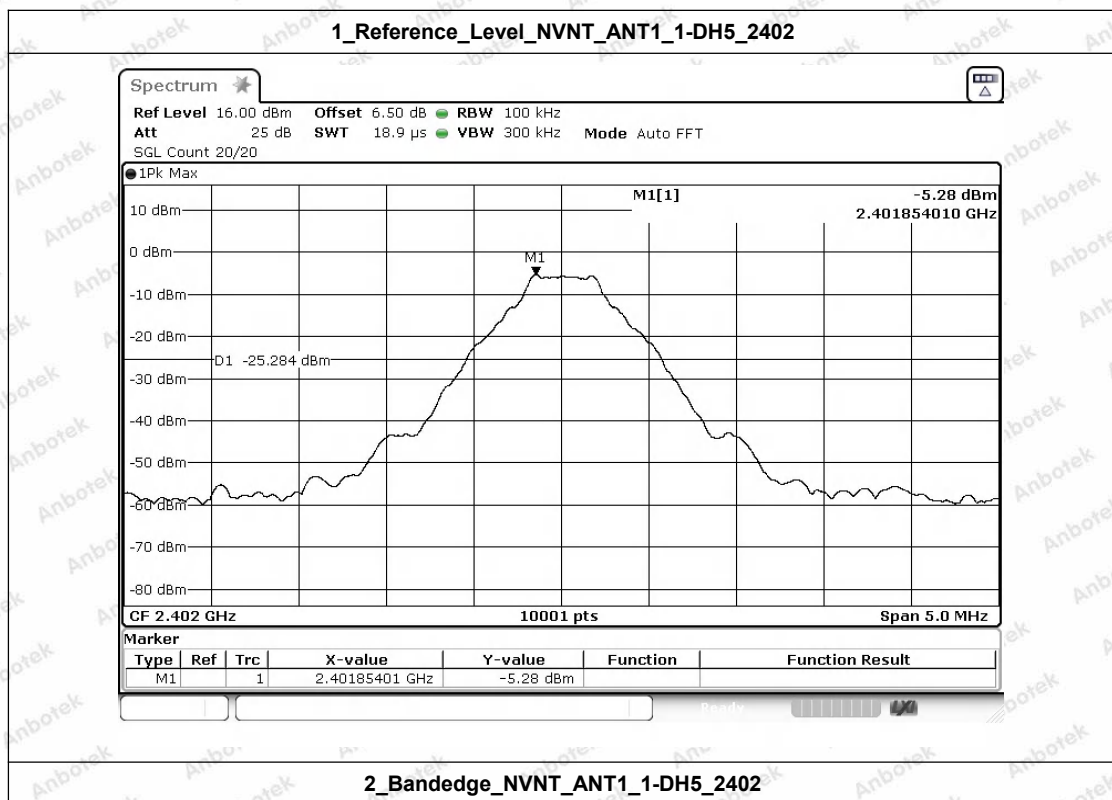

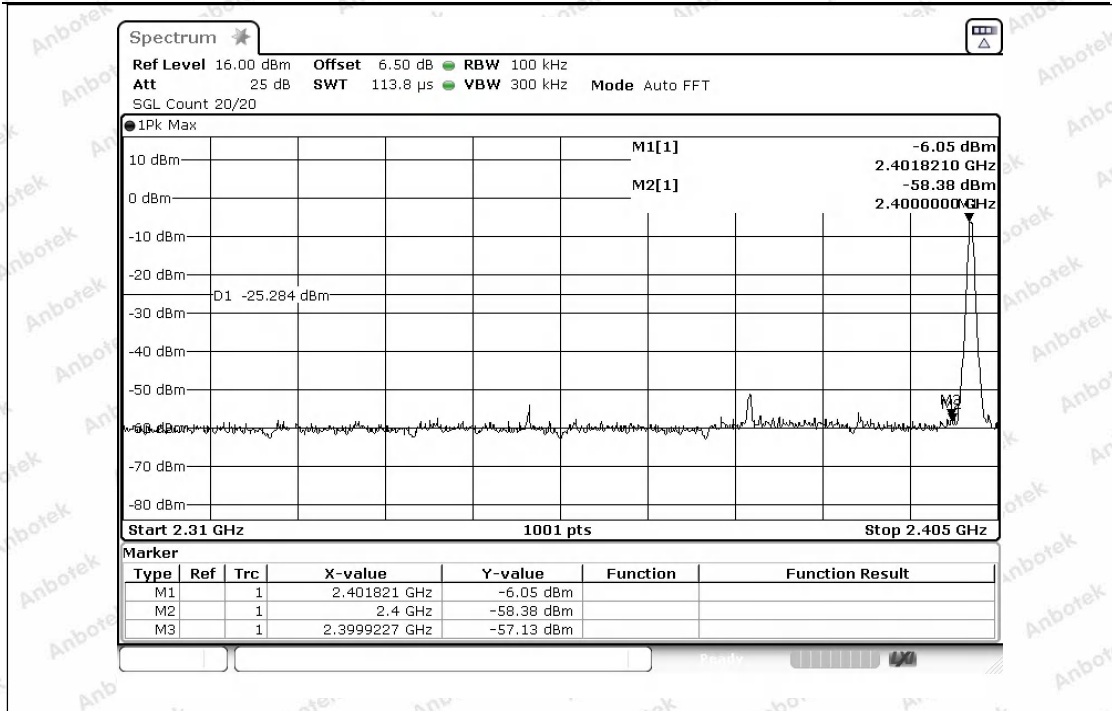

1_Reference_Level_Hopping_NVNT_ANT1_1-DH5_Hopping

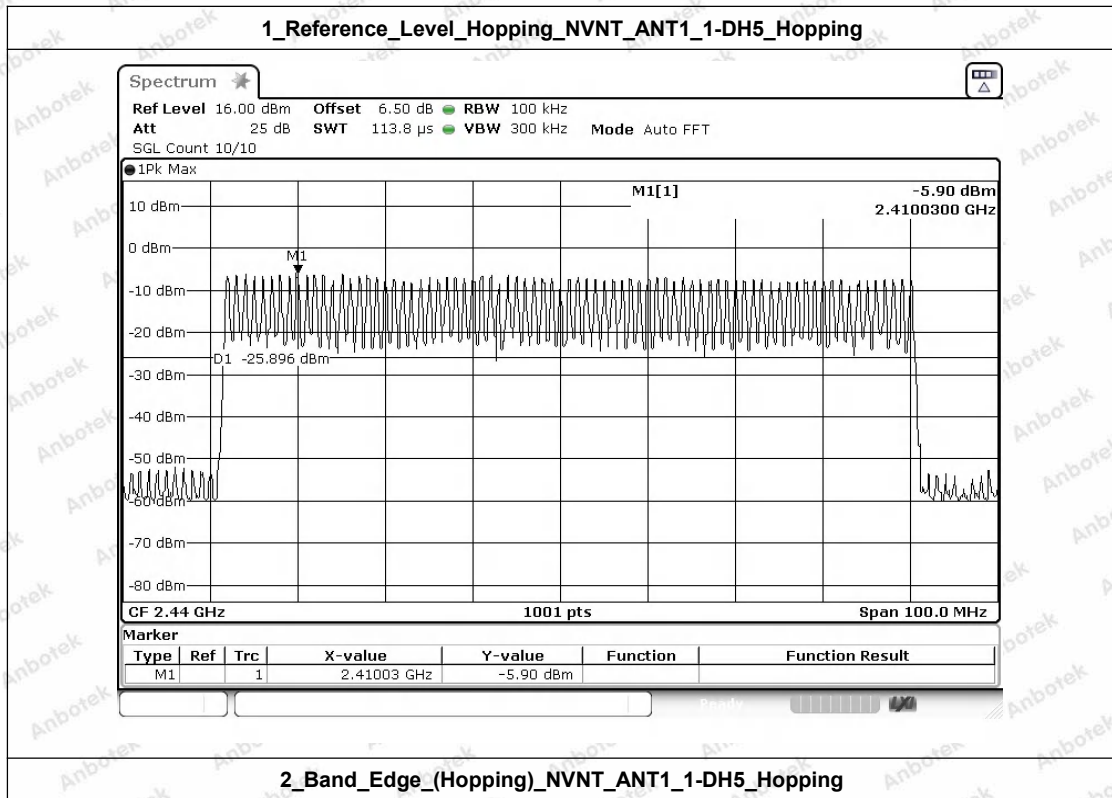

2_Band_Edge_(Hopping)_NVNT_ANT1_1-DH5_Hopping



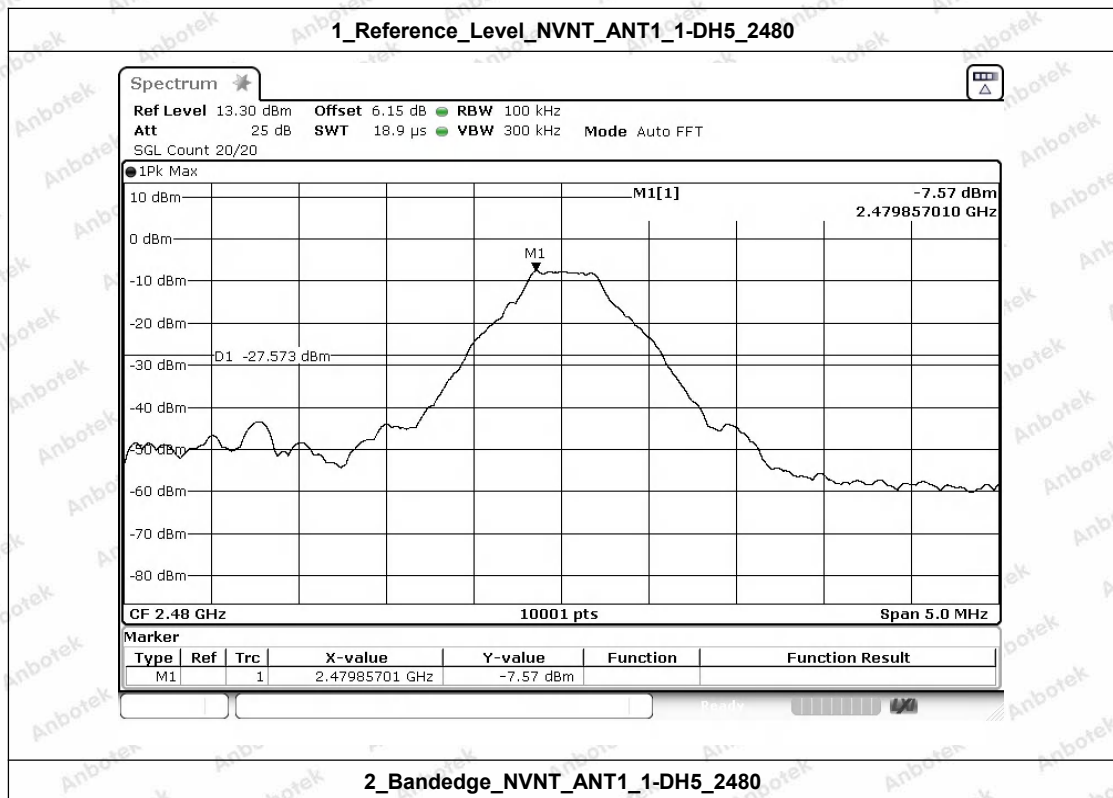
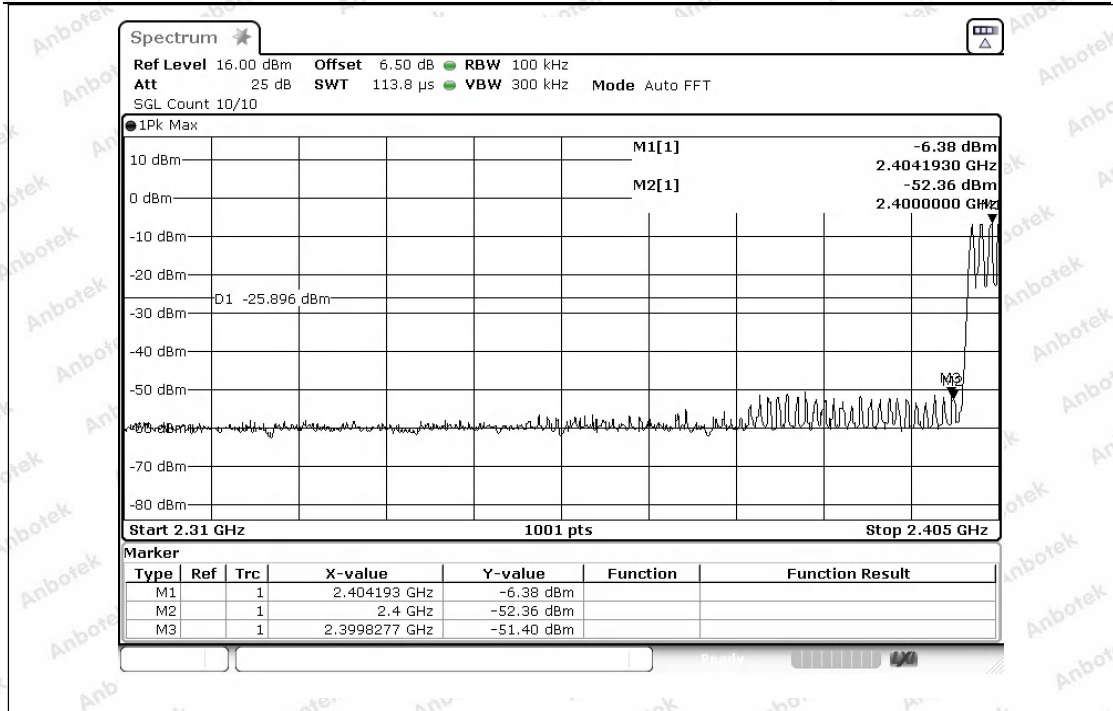

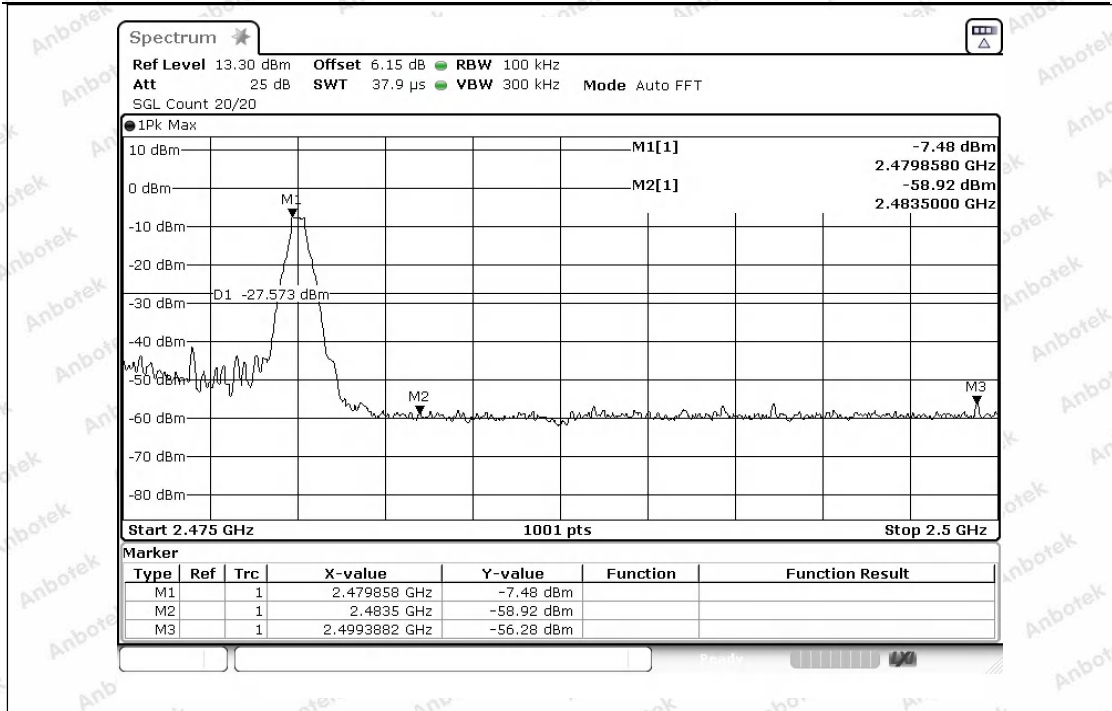

1_Reference_Level_Hopping_NVNT_ANT1_1-DH5_Hopping

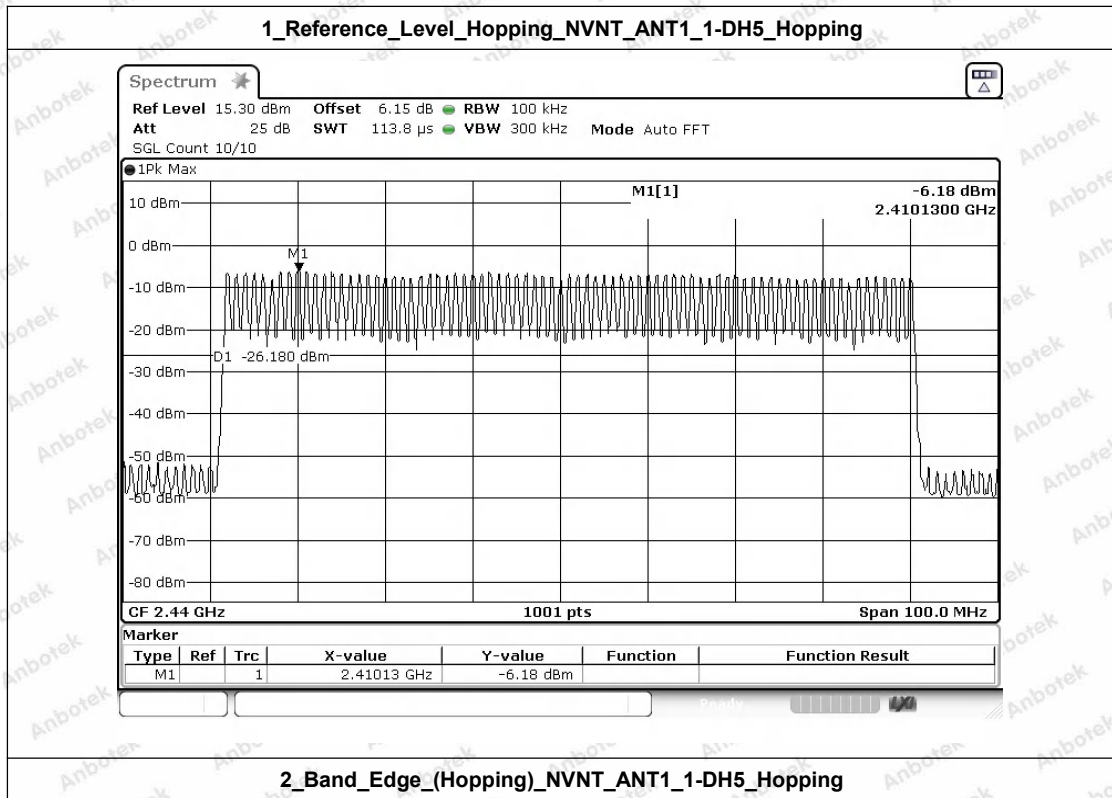

2_Band_Edge_(Hopping)_NVNT_ANT1_1-DH5_Hopping

Shenzhen Anbotek Compliance Laboratory Limited

Address: 1/F., Building D, Sogood Science and Technology Park, Sanwei Community, Hangcheng Street, Bao'an District, Shenzhen, Guangdong, China.
 Tel: (86) 0755-26066440 Fax: (86) 0755-26014772 Email: service@anbotek.com

Hotline 400-003-0500
 www.anbotek.com.cn

