

FCC TEST REPORT

Client Name : JMtek Industries(Shenzhen) Co., Ltd
Address : 14G, Innovation Tech Building, Quanzhi Science and Technology innovation Park, ShaJing Street, Baoan District, ShenZhen, China
Product Name : Wireless Charger
Date : May 11, 2022



Shenzhen Anbotek Compliance Laboratory Limited

Contents

1. General Information	4
1.1. Client Information	4
1.2. Description of Device (EUT)	4
1.3. Auxiliary Equipment Used During Test	5
1.4. Description of Test Modes	5
1.5. Description Of Test Setup	6
1.6. Test Equipment List	7
1.7. Measurement Uncertainty	8
1.8. Description of Test Facility	8
2. Summary of Test Results	9
3. Conducted Emission Test	10
3.1. Test Standard and Limit	10
3.2. Test Setup	10
3.3. Test Procedure	10
3.4. Test Data	10
4. Radiation Spurious Emission	13
4.1. Test Standard and Limit	13
4.2. Test Setup	13
4.3. Test Procedure	14
4.4. Test Data	14
5. Antenna Requirement	19
5.1. Test Standard and Requirement	19
5.2. Antenna Connected Construction	19
APPENDIX I -- TEST SETUP PHOTOGRAPH	20
APPENDIX II -- EXTERNAL PHOTOGRAPH	22
APPENDIX III -- INTERNAL PHOTOGRAPH	26

TEST REPORT

Applicant : JMTEK Industries(Shenzhen) Co., Ltd
Manufacturer : JMTEK Industries(Shenzhen) Co., Ltd
Product Name : Wireless Charger
Model No. : WPC200 Qi, WPC100 Qi, WPC300 Qi, WPC400 Qi
Trade Mark : N.A.
Rating(s) : Input: DC 5V/2A, 9V/2A
Wireless Output: DC 5V/1A 5W, DC 9V/1.1A 10W
Test Standard(s) : FCC Part15 Subpart C, Paragraph 15.209
Test Method(s) : ANSI C63.10: 2020

The device described above is tested by Shenzhen Anbotek Compliance Laboratory Limited to determine the maximum emission levels emanating from the device and the severe levels of the device can endure and its performance criterion. The measurement results are contained in this test report and Shenzhen Anbotek Compliance Laboratory Limited is assumed full of responsibility for the accuracy and completeness of these measurements. Also, this report shows that the EUT (Equipment Under Test) is technically compliant with the FCC Part 15 Subpart C requirements.

This report applies to above tested sample only and shall not be reproduced in part without written approval of Shenzhen Anbotek Compliance Laboratory Limited.

Date of Receipt

Apr. 14, 2022

Date of Test

Apr. 14~22, 2022

Prepared By

Nian Xiu Chen

(Nianxiu Chen)

Approved & Authorized Signer

Kingkong Jin

(Kingkong Jin)

1. General Information

1.1. Client Information

Applicant	:	JMTek Industries(Shenzhen) Co., Ltd
Address	:	14G, Innovation Tech Building, Quanzhi Science and Technology innovation Park, ShaJing Street, Baoan District, ShenZhen, China
Manufacturer	:	JMTek Industries(Shenzhen) Co., Ltd
Address	:	14G, Innovation Tech Building, Quanzhi Science and Technology innovation Park, ShaJing Street, Baoan District, ShenZhen, China
Factory	:	JMTek Industries(Shenzhen) Co., Ltd
Address	:	14G, Innovation Tech Building, Quanzhi Science and Technology innovation Park, ShaJing Street, Baoan District, ShenZhen, China

1.2. Description of Device (EUT)

Product Name	:	Wireless Charger	
Model No.	:	WPC200 Qi, WPC100 Qi, WPC300 Qi, WPC400 Qi (Note: All samples are the same except the model number and appearance, so we prepare "WPC200 Qi" for test only.)	
Trade Mark	:	N.A.	
Test Power Supply	:	AC 120V, 60Hz for adapter	
Test Sample No.	:	1-2-1(Normal Sample), 1-2-2(Engineering Sample)	
Product Description	:	Operation Frequency:	110.1-205KHz
	:	Modulation Type:	FSK
	:	Antenna Type:	Inductive loop coil Antenna
	:	Antenna Gain(Peak):	0 dBi (Provided by customer)
	:	Adapter:	N/A
Remark: 1) For a more detailed features description, please refer to the manufacturer's specifications or the User's Manual.			

1.3. Auxiliary Equipment Used During Test

Adapter	:	Model: MDY-11-EX Input: 100-240V~50/60Hz, 07A Output: 5V---3A/ 9V---3A/ 12V---2.25A/ 20V---1.35A/ 11V---3A Max
Wireless charging load	:	Manufacturer: Shenzhen Ouju Technology Co., Ltd. M/N: CD2577 Power: 5W/7.5W/10W/15W Last Cal.: Oct. 26, 2021 Cal. Interval: 1 Year

1.4. Description of Test Modes

To investigate the maximum EMI emission characteristics generates from EUT, the test system was pre-scanning tested base on the consideration of following EUT operation mode or test configuration mode which possible have effect on EMI emission level. Each of these EUT operation mode(s) or test configuration mode(s) mentioned above was evaluated respectively.

Pretest Mode	Description
Mode 1	Wireless charging

For Conducted Emission	
Final Test Mode	Description
Mode 1	Wireless charging

For Radiated Emission	
Final Test Mode	Description
Mode 1	Wireless charging

Note: (1)Test channel is 0.1241MHz.

(2) All the situation(full load, half load and empty load) has been tested,only the worst situation (full load 10W) was recorded in the report.

1.5. Description Of Test Setup

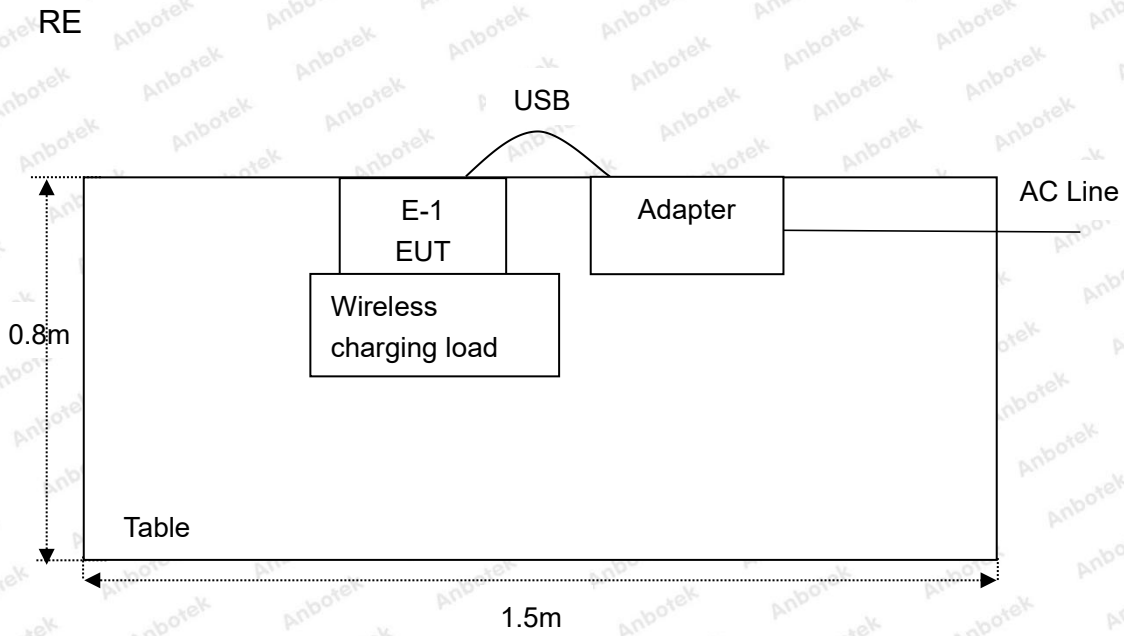
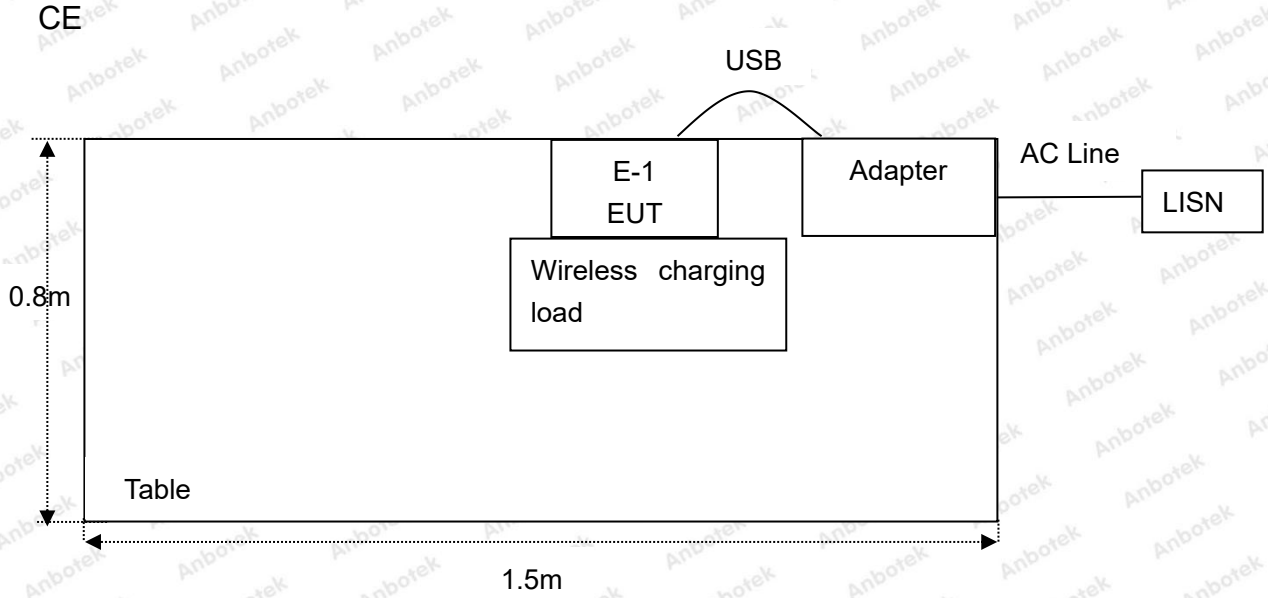

1.6. Test Equipment List

Item	Equipment	Manufacturer	Model No.	Serial No.	Last Cal.	Cal. Interval
1.	Three Phase V-type Artificial Power Network	CYBERTEK	EM5040DT	E215040DT001	Jul 05, 2021	1 Year
2.	EMI Test Receiver	Rohde & Schwarz	ESCI	100627	Oct. 22, 2021	1 Year
3.	EMI Test Receiver	Rohde & Schwarz	ESR26	101481	Oct. 22, 2021	1 Year
4.	RF Switching Unit	Compliance Direction	RSU-M2	38303	Oct. 22, 2021	1 Year
5.	MAX Spectrum Analysis	Agilent	N9020A	MY51170037	Oct. 22, 2021	1 Year
6.	Preamplifier	SKET Electronic	BK1G18G30D	KD17503	Oct. 22, 2021	1 Year
7.	Double Ridged Horn Antenna	Instruments corporation	GTH-0118	351600	Oct. 22, 2021	2 Year
8.	Bilog Broadband Antenna	Schwarzbeck	VULB9163	VULB 9163-289	Oct. 22, 2021	2 Year
9.	Loop Antenna	Schwarzbeck	FMZB1519B	00053	Oct. 22, 2021	2 Year
10.	Horn Antenna	A-INFO	LB-180400-KF	J211060628	Oct. 22, 2021	2 Year
11.	Pre-amplifier	SONOMA	310N	186860	Oct. 22, 2021	1 Year
12.	EMI Test Software EZ-EMC	SHURPLE	N/A	N/A	N/A	N/A
13.	RF Test Control System	YIHENG	YH3000	2017430	Oct. 22, 2021	1 Year
14.	Power Sensor	DAER	RPR3006W	15I00041SN045	Oct. 22, 2021	1 Year
15.	Power Sensor	DAER	RPR3006W	15I00041SN046	Oct. 22, 2021	1 Year
16.	MXA Spectrum Analysis	KEYSIGHT	N9020A	MY53280032	Oct. 22, 2021	1 Year
17.	MXG RF Vector Signal Generator	Agilent	N5182A	MY48180656	Oct. 22, 2021	1 Year
18.	Signal Generator	Agilent	E4421B	MY41000743	Oct. 22, 2021	1 Year
19.	DC Power Supply	IVYTECH	IV3605	1804D360510	Oct. 22, 2021	1 Year
20.	Constant Temperature Humidity Chamber	ZHONGJIAN	ZJ-KHWS80B	N/A	Oct. 22, 2021	1 Year

1.7. Measurement Uncertainty

Radiation Uncertainty	:	Ur = 3.9 dB (Horizontal)
		Ur = 3.8 dB (Vertical)
Conduction Uncertainty	:	Uc = 3.4 dB

1.8. Description of Test Facility

The test facility is recognized, certified, or accredited by the following organizations:

FCC-Registration No.: 184111

Shenzhen Anbotek Compliance Laboratory Limited, EMC Laboratory has been registered and fully described in a report filed with the (FCC) Federal Communications Commission. The acceptance letter from the FCC is maintained in our files. Registration No. 184111.

ISED-Registration No.: 8058A

Shenzhen Anbotek Compliance Laboratory Limited, EMC Laboratory has been registered and fully described in a report filed with the (ISED) Innovation, Science and Economic Development Canada. The acceptance letter from the ISED is maintained in our files. Registration 8058A.

Test Location

Shenzhen Anbotek Compliance Laboratory Limited.

1/F, Building D, Sogood Science and Technology Park, Sanwei community, Hangcheng Street, Bao'an District, Shenzhen, Guangdong, China.518102

2. Summary of Test Results

Standard Section	Test Item	Result
FCC Part 15, Paragraph 15.207	Conducted Emission Test	PASS
FCC Part 15, Paragraph 15.209(a)(f)	Spurious Emission	PASS
Part 15.203	Antenna Requirement	PASS

3. Conducted Emission Test

3.1. Test Standard and Limit

Test Standard	FCC Part15 Section 15.207		
Test Limit	Frequency	Maximum RF Line Voltage (dBuV)	
		Quasi-peak Level	Average Level
	150kHz~500kHz	66 ~ 56 *	56 ~ 46 *
	500kHz~5MHz	56	46
5MHz~30MHz	60	50	

Remark: (1) *Decreasing linearly with logarithm of the frequency.
 (2) The lower limit shall apply at the transition frequency.

3.2. Test Setup

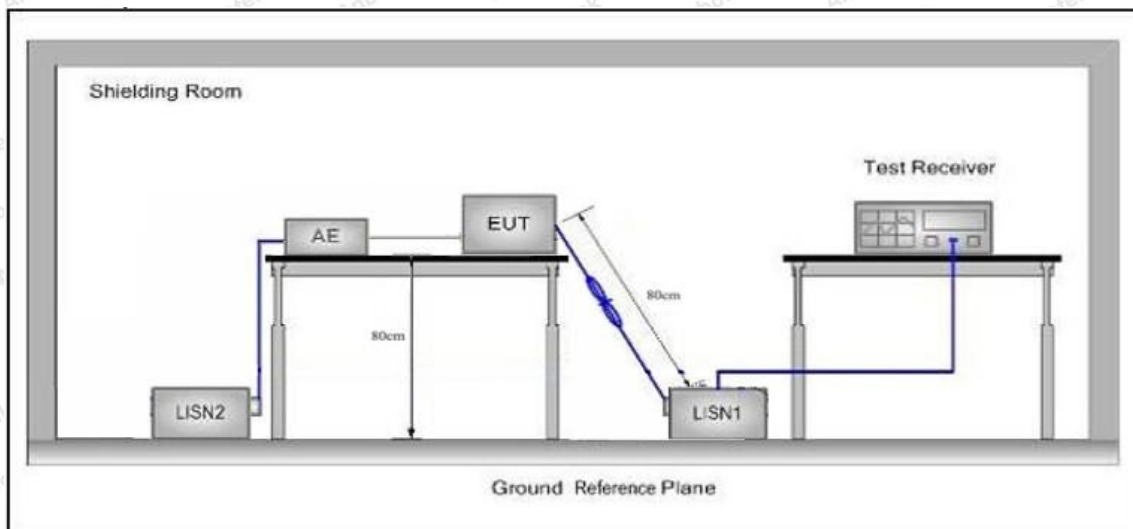

3.3. Test Procedure

The EUT system is connected to the power mains through a line impedance stabilization network (L.I.S.N.). This provides a 50ohm coupling impedance for the EUT system. Please refer the block diagram of the test setup and photographs. Both sides of AC line are checked to find out the maximum conducted emission. In order to find the maximum emission levels, the relative positions of equipment and all of the interface cables shall be changed according to FCC ANSI C63.10-2020 on Conducted Emission Measurement.

The bandwidth of test receiver (ESCI) set at 9kHz.

The frequency range from 150kHz to 30MHz is checked.

3.4. Test Data

Please to see the following pages

Shenzhen Anbotek Compliance Laboratory Limited

Address: 1/F., Building D, Sogood Science and Technology Park, Sanwei Community, Hangcheng Street, Bao'an District, Shenzhen, Guangdong, China.
 Tel:(86) 755-26066440 Fax: (86) 755-26014772 Email: service@anbotek.com

Code:AB-RF-05-a

Hotline
 400-003-0500
 www.anbotek.com

Conducted Emission Test Data

Test Site: 1# Shielded Room
 Operating Condition: Mode 1
 Test Specification: AC 120V, 60Hz for adapter
 Comment: Live Line
 Tem.: 22.8°C Hum.: 51%

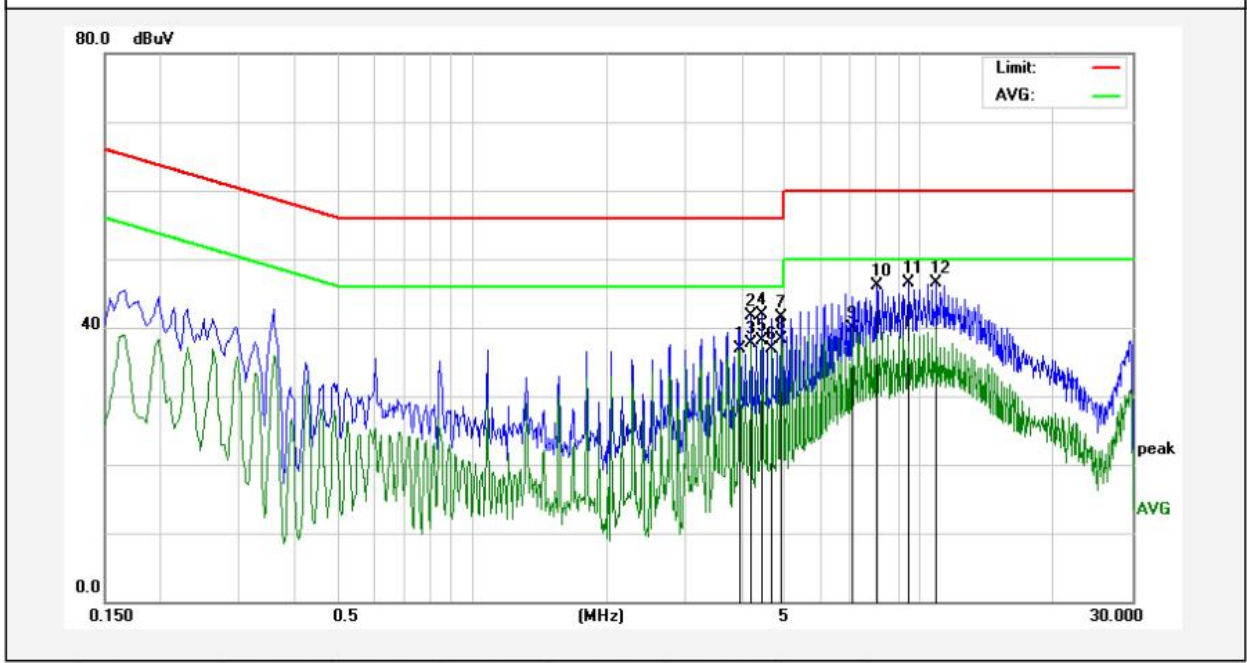

No.	Freq. (MHz)	Reading (dBuV)	Factor (dB)	Result (dBuV)	Limit (dBuV)	Over Limit (dB)	Detector	Remark
1	3.9660	36.69	0.12	36.81	46.00	-9.19	AVG	
2	4.2060	41.68	0.11	41.79	56.00	-14.21	QP	
3	4.2060	37.68	0.11	37.79	46.00	-8.21	AVG	
4	4.4420	41.73	0.11	41.84	56.00	-14.16	QP	
5	4.4420	37.95	0.11	38.06	46.00	-7.94	AVG	
6	4.6820	36.70	0.11	36.81	46.00	-9.19	AVG	
7	4.9220	41.40	0.11	41.51	56.00	-14.49	QP	
8	4.9220	38.29	0.11	38.40	46.00	-7.60	AVG	
9	7.0860	39.83	0.11	39.94	50.00	-10.06	AVG	
10	8.0420	46.00	0.12	46.12	60.00	-13.88	QP	
11	9.4860	46.33	0.12	46.45	60.00	-13.55	QP	
12	10.9260	46.35	0.13	46.48	60.00	-13.52	QP	

Conducted Emission Test Data

Test Site: 1# Shielded Room
 Operating Condition: Mode 1
 Test Specification: AC 120V, 60Hz for adapter
 Comment: Neutral Line
 Tem.: 22.8°C Hum.: 51%

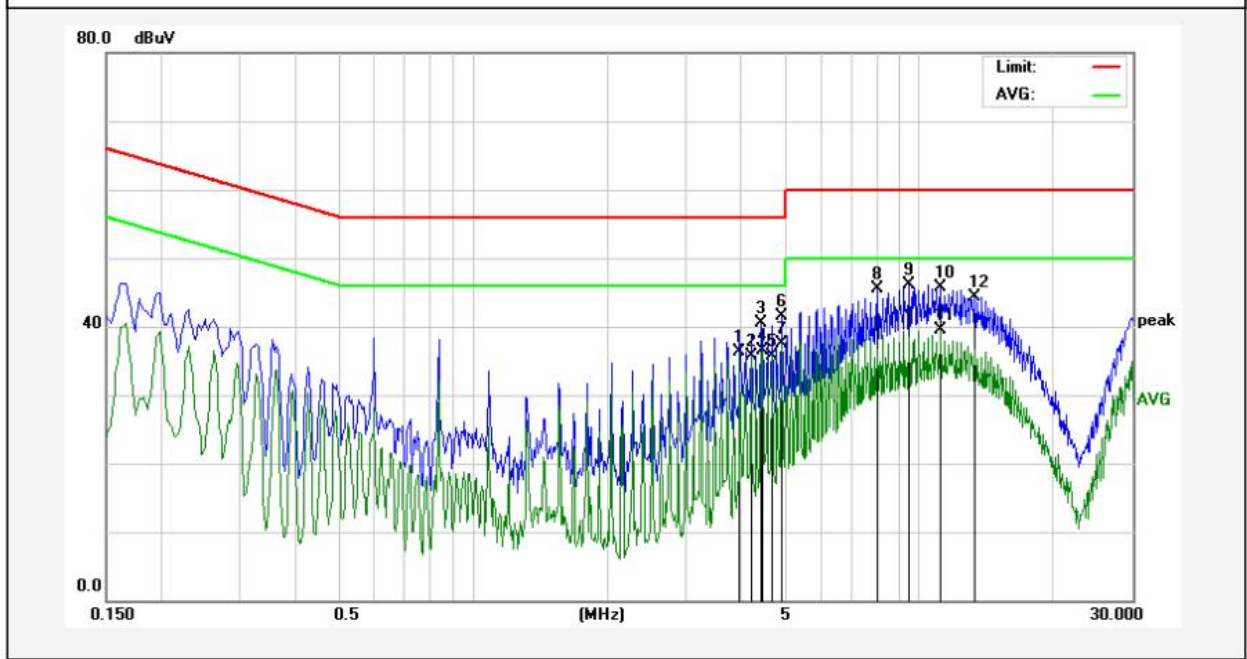

No.	Freq. (MHz)	Reading (dBuV)	Factor (dB)	Result (dBuV)	Limit (dBuV)	Over Limit (dB)	Detector	Remark
1	3.9540	36.13	0.12	36.25	46.00	-9.75	AVG	
2	4.1940	35.51	0.11	35.62	46.00	-10.38	AVG	
3	4.4300	40.34	0.11	40.45	56.00	-15.55	QP	
4	4.4340	36.48	0.11	36.59	46.00	-9.41	AVG	
5	4.6740	35.54	0.11	35.65	46.00	-10.35	AVG	
6	4.9140	41.31	0.11	41.42	56.00	-14.58	QP	
7	4.9140	37.35	0.11	37.46	46.00	-8.54	AVG	
8	8.0260	45.39	0.12	45.51	60.00	-14.49	QP	
9	9.4620	46.03	0.12	46.15	60.00	-13.85	QP	
10	11.1420	45.60	0.13	45.73	60.00	-14.27	QP	
11	11.1420	39.40	0.13	39.53	50.00	-10.47	AVG	
12	13.2980	44.13	0.15	44.28	60.00	-15.72	QP	

4. Radiation Spurious Emission

4.1. Test Standard and Limit

Test Standard	FCC Part15 C Section 15.209 and 15.205				
Test Limit	Frequency (MHz)	Field strength (microvolt/meter)	Limit (dBuV/m)	Remark	Measurement distance (m)
	0.009MHz~0.490MHz	2400/F(kHz)	-	-	300
	0.490MHz-1.705MHz	24000/F(kHz)	-	-	30
	1.705MHz-30MHz	30	-	-	30
	30MHz~88MHz	100	40.0	Quasi-peak	3
	88MHz~216MHz	150	43.5	Quasi-peak	3
	216MHz~960MHz	200	46.0	Quasi-peak	3
	960MHz~1000MHz	500	54.0	Quasi-peak	3
	Above 1000MHz	500	54.0	Average	3
-		74.0	Peak	3	

Remark:

(1)The lower limit shall apply at the transition frequency.

(2) 15.35(b), Unless otherwise specified, the limit on peak radio frequency emissions is 20dB above the maximum permitted average emission limit applicable to the equipment under test. This peak limit applies to the total peak emission level radiated by the device.

4.2. Test Setup

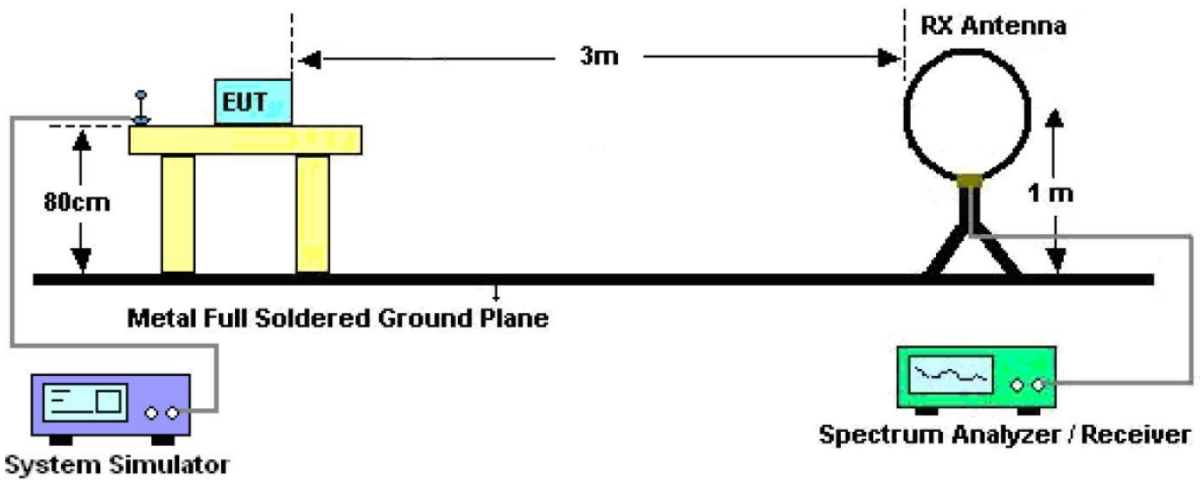

Figure 1. Below 30MHz

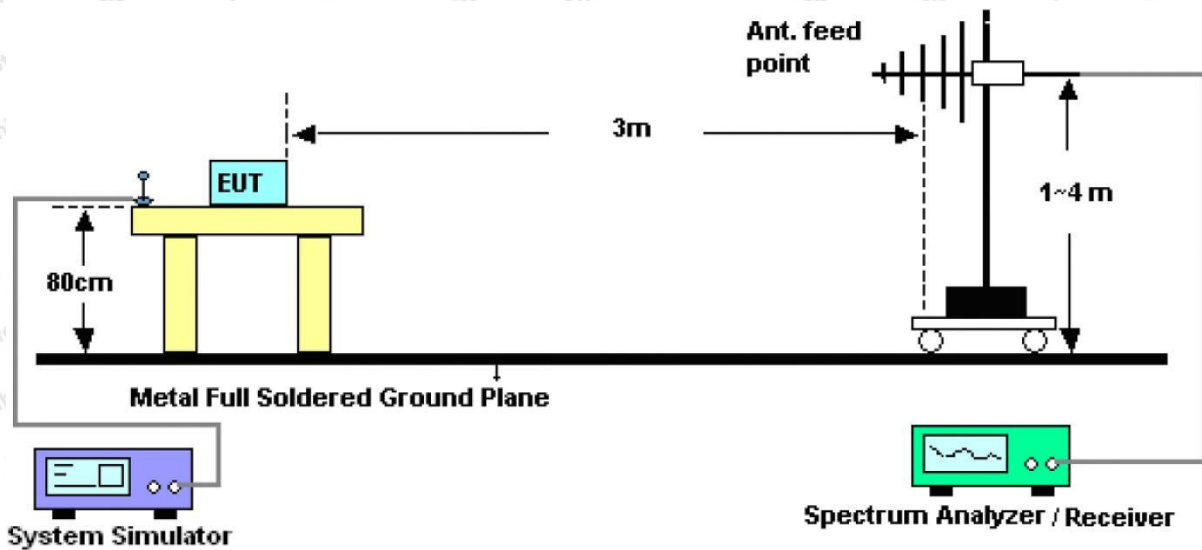

Figure 2. 30MHz to 1GHz

4.3. Test Procedure

For below 1GHz: The EUT is placed on a turntable, which is 0.8m above the ground plane. The turn table can rotate 360 degrees to determine the position of the maximum emission level. The EUT is set 3 meters away from the receiving antenna which is mounted on a antenna tower. The antenna can be moved up and down from 1 to 4 meters to find out the maximum emission level. Rotated the EUT through three orthogonal axes to determine the maximum emissions, both horizontal and vertical polarization of the antenna are set on test. The EUT is tested in 9*6*6 Chamber. The device is evaluated in xyz orientation.

For 9kHz to 150kHz, Set the spectrum analyzer as:

RBW = 200Hz, VBW = 1kHz, Detector= Quasi-Peak, Trace mode= Max hold, Sweep- auto couple.

For 150kHz to 30MHz, Set the spectrum analyzer as:

RBW = 9kHz, VBW = 30kHz, Detector= Quasi-Peak, Trace mode= Max hold, Sweep- auto couple.

For 30MHz to 1000MHz, Set the spectrum analyzer as:

RBW = 100kHz, VBW = 300kHz, Detector= Quasi-Peak, Trace mode= Max hold, Sweep- auto couple.

4.4. Test Data

PASS

Note: The data is in TX mode, and this is the worst mode.

Test Results

(Between 9KHz – 30MHz)

Standard: FCC PART15 C _3m **Power Source:** AC 120V, 60Hz for adapter
Test item: Radiation Test **Temp.(C)/Hum.(%RH):** 22.7°C/49%RH
Test Mode: Mode 1 **Distance:** 3m

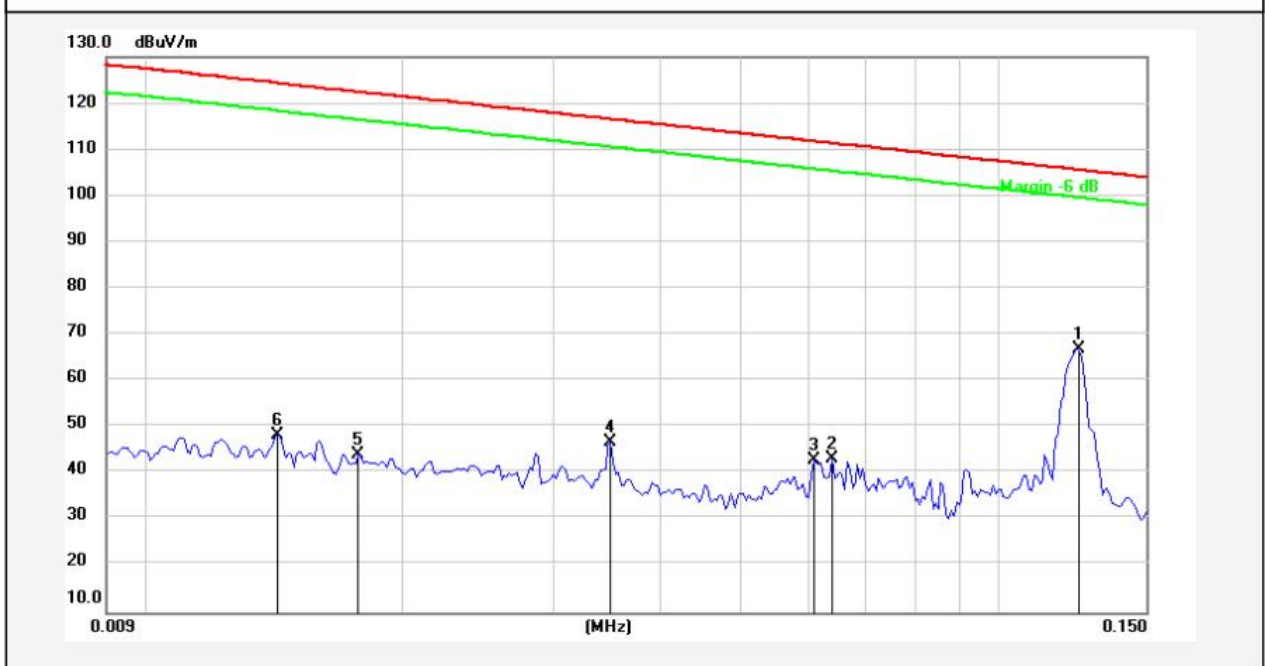

No.	Freq. (MHz)	Reading (dBuV)	Factor ()	Result (dBuV/m)	Limit (dBuV/m)	Over Limit (dB)	Detector	Height (cm)	degree (deg)	Remark
1	0.1241	46.43	20.34	66.77	105.66	-38.89	QP			
2	0.0640	22.67	20.38	43.05	111.37	-68.32	QP			
3	0.0609	22.58	20.37	42.95	111.80	-68.85	QP			
4	0.0352	26.32	20.48	46.80	116.53	-69.73	QP			
5	0.0177	23.96	20.15	44.11	122.47	-78.36	QP			
6	0.0143	27.92	20.22	48.14	124.31	-76.17	QP			

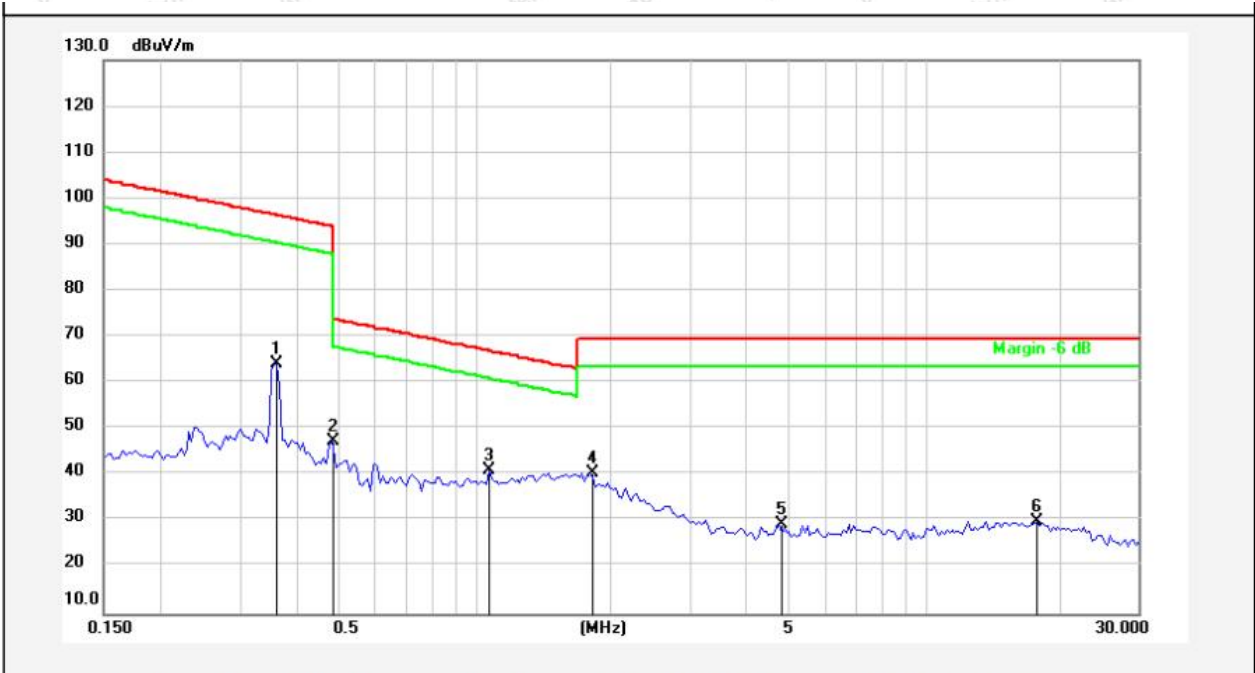

No.	Freq. (MHz)	Reading (dBuV)	Factor ()	Result (dBuV/m)	Limit (dBuV/m)	Over Limit (dB)	Detector	Height (cm)	degree (deg)	Remark
1	0.3642	43.73	20.28	64.01	96.36	-32.35	QP			
2	0.4812	27.08	20.27	47.35	93.96	-46.61	QP			
3	1.0786	20.82	20.25	41.07	66.97	-25.90	QP			
4	1.8096	20.14	20.27	40.41	69.50	-29.09	QP			
5	4.7590	8.94	20.41	29.35	69.50	-40.15	QP			
6	17.8963	9.34	20.57	29.91	69.50	-39.59	QP			

Remark: According to FCC PART 15.209 (d), the emission limits for the frequency bands 9–90 kHz, 110–490 kHz and above 1000 MHz, Radiated emission limits in these three bands are based on measurements employing an average detector.

(Between 30MHz –1000 MHz)

Standard:	FCC PART15 C _3m	Polarization:	Horizontal
Test item:	Radiation Test	Power Source:	AC 120V, 60Hz for adapter
Test Mode:	Mode 1	Temp.(C)/Hum.(%RH):	22.7°C/49%RH
Distance:	3m		

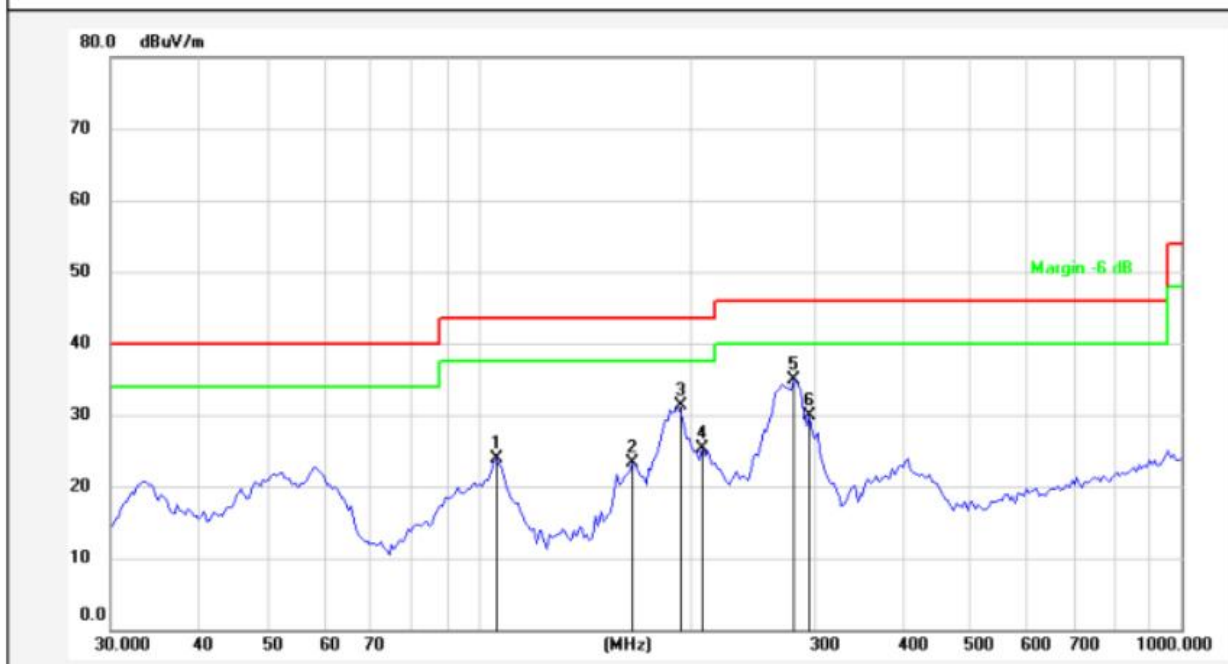

No.	Freq. (MHz)	Reading (dBuV)	Factor ()	Result (dBuV/m)	Limit (dBuV/m)	Over Limit (dB)	Detector	Height (cm)	degree (deg)	Remark
1	106.0126	41.65	-17.73	23.92	43.50	-19.58	QP			
2	165.7771	43.52	-20.19	23.33	43.50	-20.17	QP			
3	192.4186	49.90	-18.63	31.27	43.50	-12.23	QP			
4	208.2148	43.08	-17.83	25.25	43.50	-18.25	QP			
5	280.5152	50.17	-15.32	34.85	46.00	-11.15	QP			
6	295.6648	44.86	-14.96	29.90	46.00	-16.10	QP			

Standard: FCC PART15 C _3m **Polarization:** Vertical
Test item: Radiation Test **Power Source:** AC 120V, 60Hz for adapter
Test Mode: Mode 1 **Temp.(C)/Hum.(%RH):** 22.7°C/49%RH
Distance: 3m

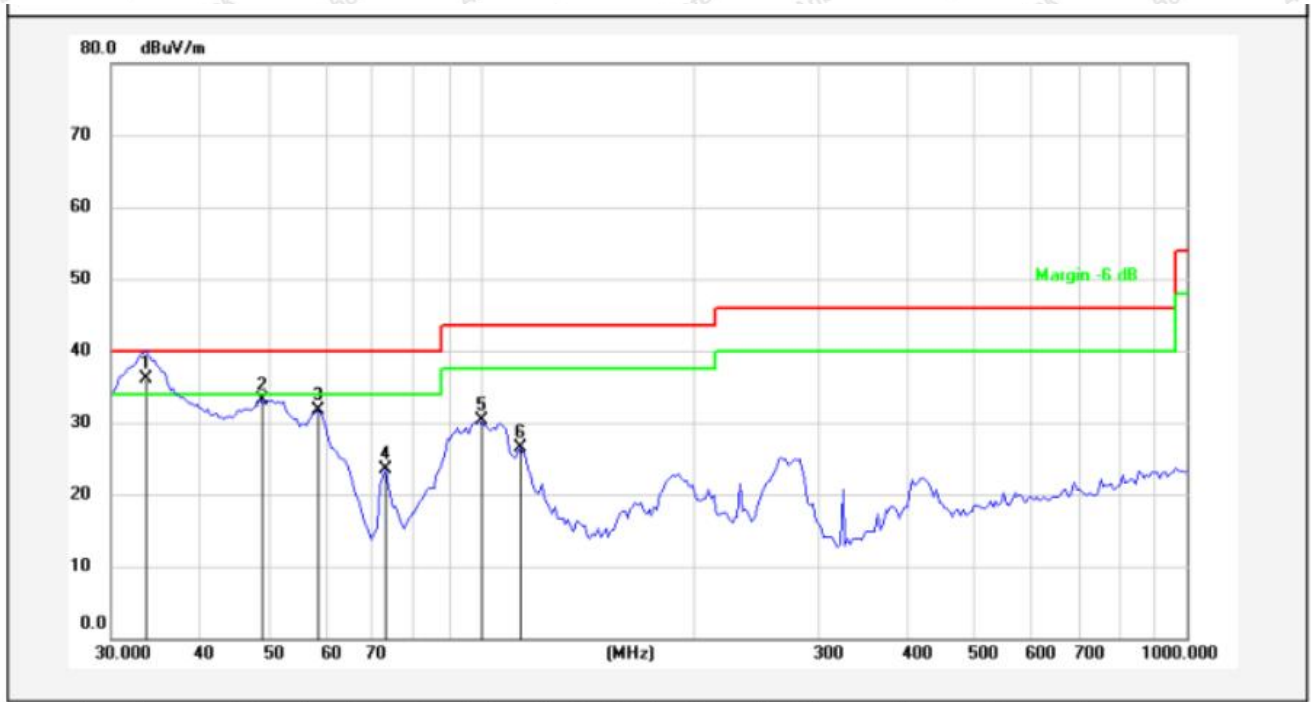

No.	Freq. (MHz)	Reading (dBuV)	Factor ()	Result (dBuV/m)	Limit (dBuV/m)	Over Limit (dB)	Detector	Height (cm)	degree (deg)	Remark
1	33.6213	54.14	-18.05	36.09	40.00	-3.91	QP			
2	48.5867	50.33	-17.13	33.20	40.00	-6.80	QP			
3	58.9217	49.26	-17.65	31.61	40.00	-8.39	QP			
4	73.3593	45.11	-21.66	23.45	40.00	-16.55	QP			
5	99.7028	47.25	-16.99	30.26	43.50	-13.24	QP			
6	113.7143	45.25	-18.74	26.51	43.50	-16.99	QP			

5. Antenna Requirement

5.1. Test Standard and Requirement

Test Standard	FCC Part15 Section 15.203
Requirement	An intentional radiator shall be designed to ensure that no antenna other than that furnished by the responsible party shall be used with the device. The use of a permanently attached antenna or of an antenna that uses a unique coupling to the intentional radiator, the manufacturer may design the unit so that a broken antenna can be replaced by the user, but the use of a standard antenna jack or electrical connector is prohibited.

5.2. Antenna Connected Construction

The antenna is a Inductive loop coil Antenna which permanently attached, and the best case gain of the antenna is 0 dBi. It complies with the standard requirement.

APPENDIX I -- TEST SETUP PHOTOGRAPH

Photo of Conducted Emission Measurement

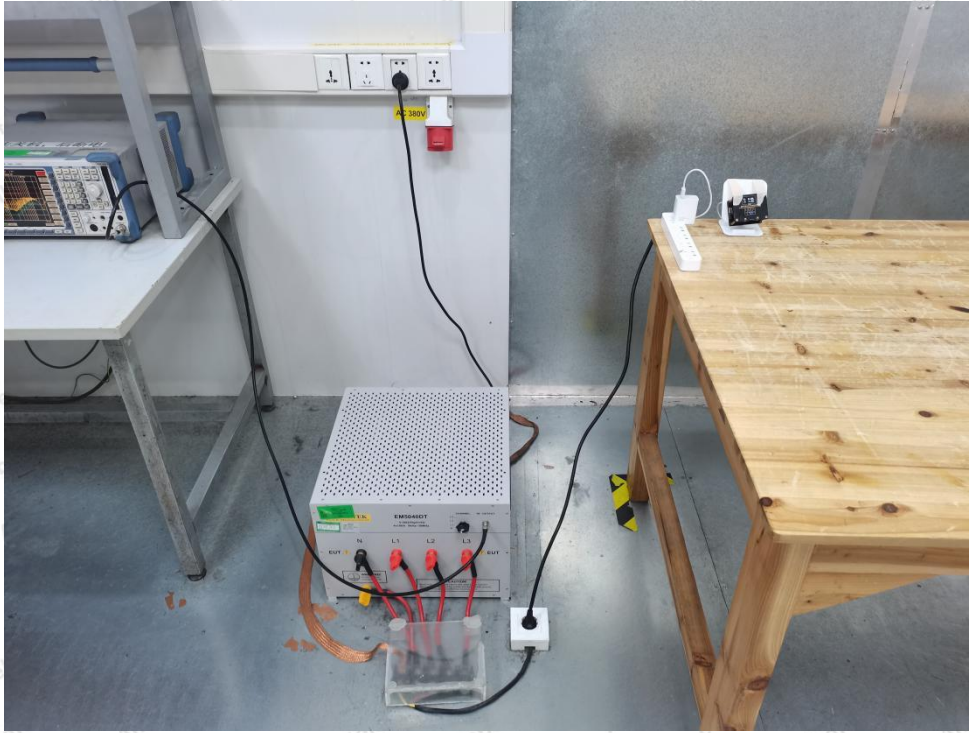

Photo of Radiation Emission Test





APPENDIX II -- EXTERNAL PHOTOGRAPH



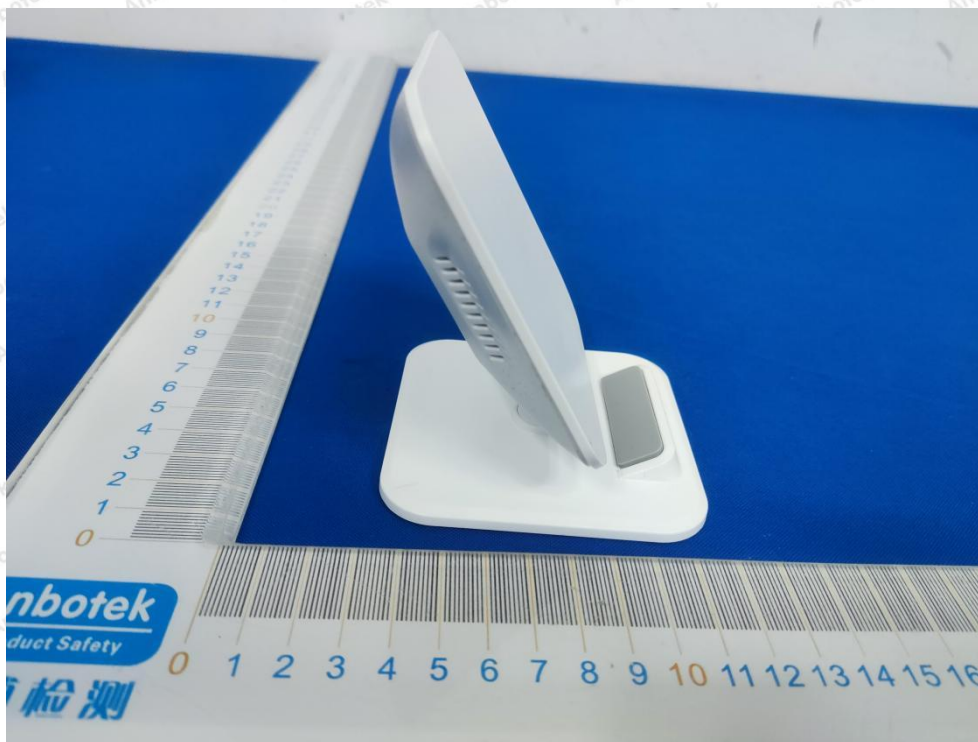

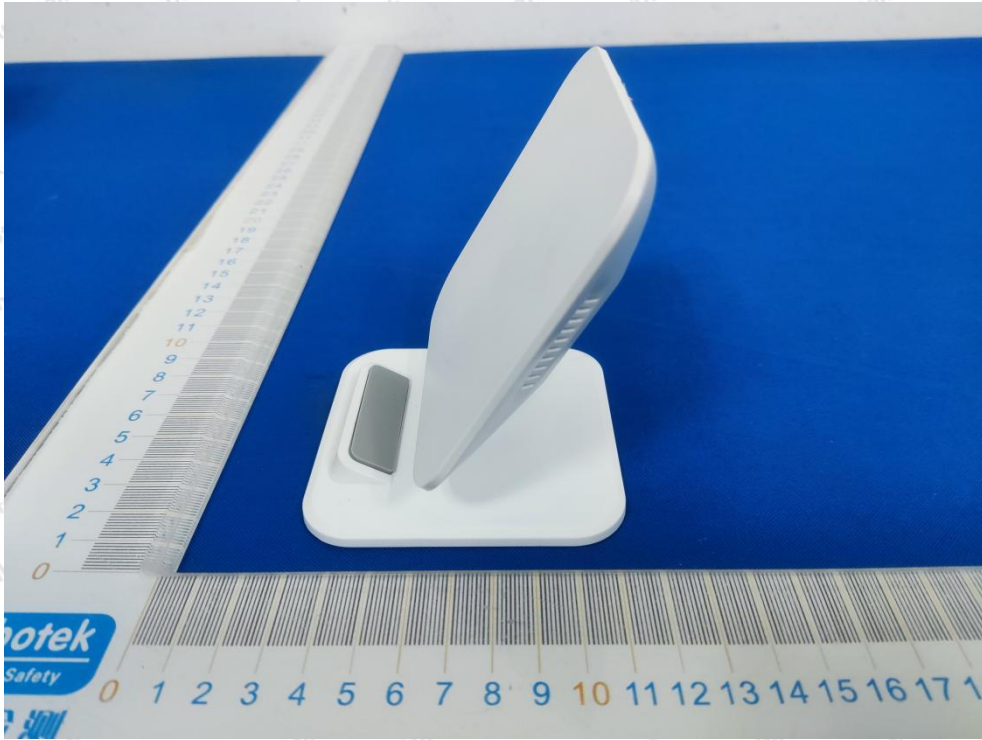



APPENDIX III -- INTERNAL PHOTOGRAPH



ANT

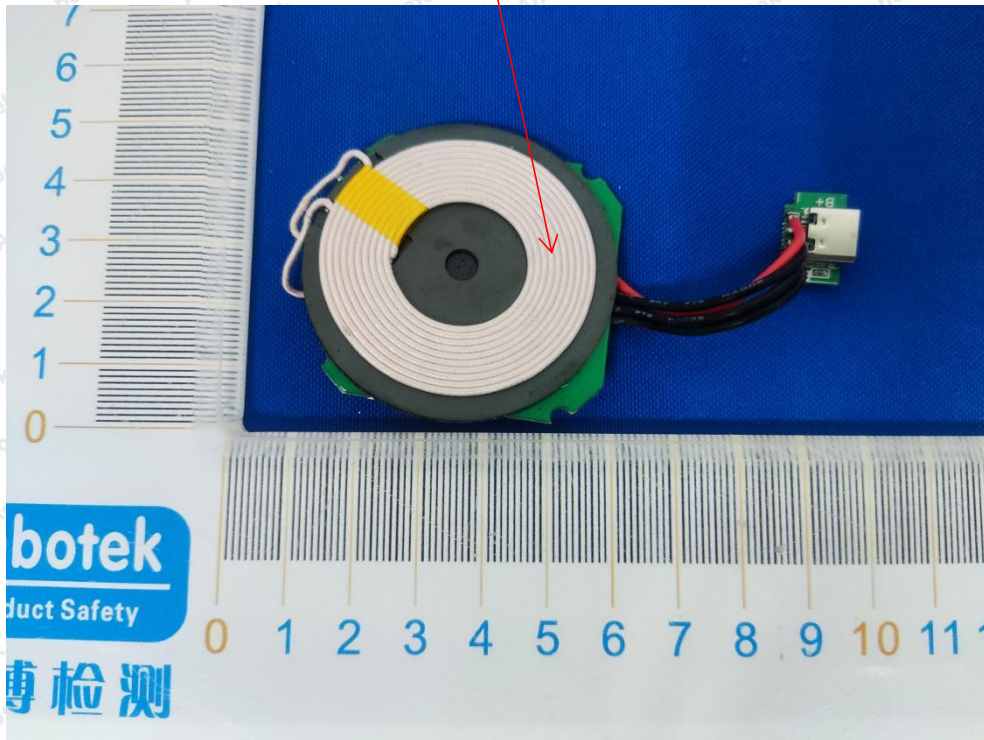

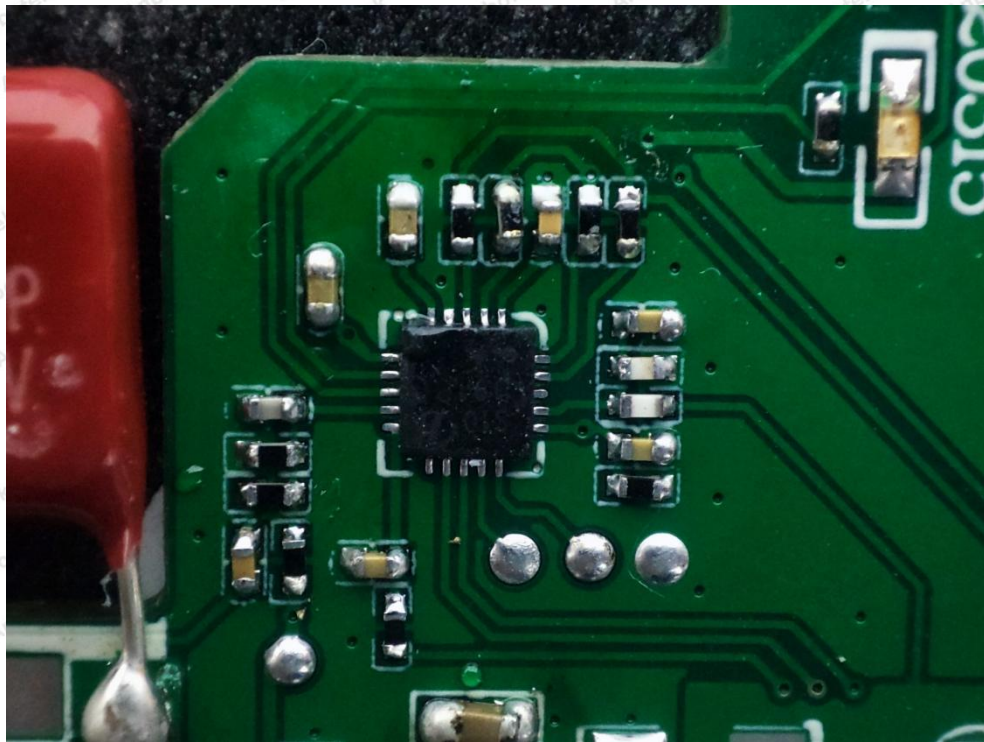
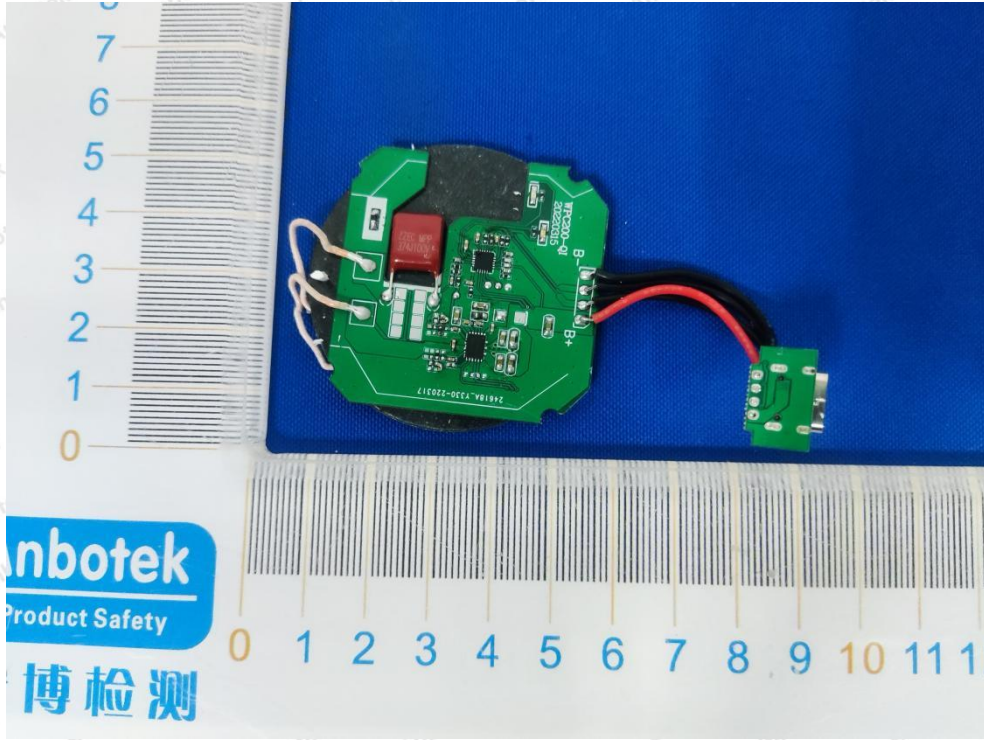

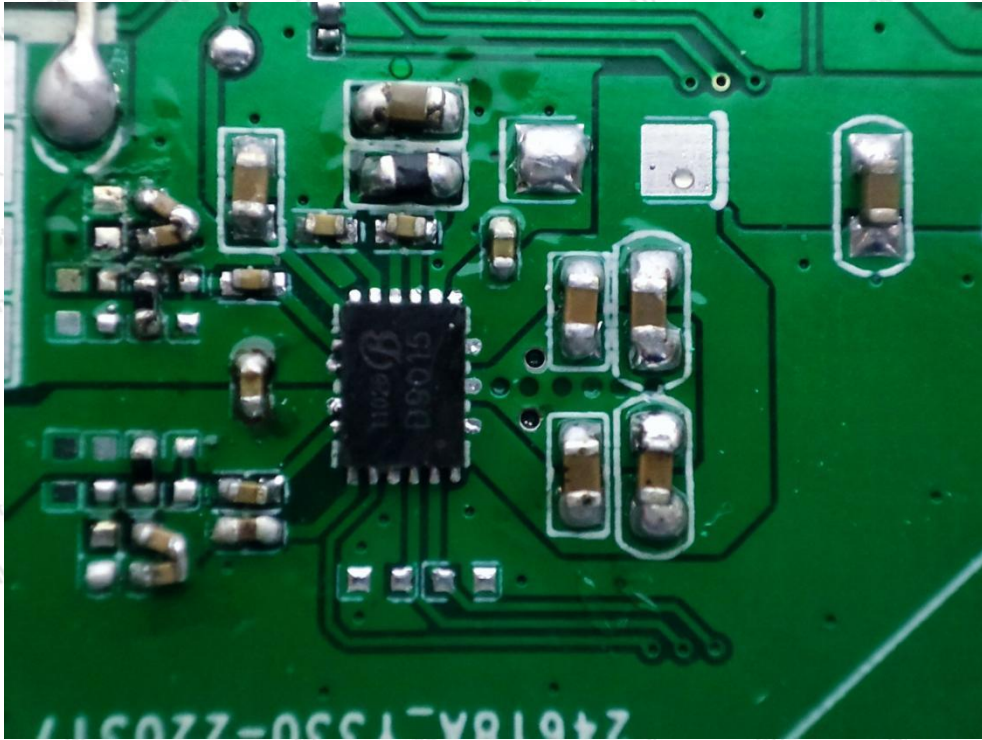

----- End of Report -----