



## CTVK08 Quick Start Guide

### Specification

Product Name	Automatic Car Mount Wireless Charger
Model	CTVK08
Input	5V = 2A / 12V = 1.5A
Output	15W (Max)
Charging Distance	4mm ~ 6mm
Battery Charge Limit Voltage	4.2V
Working Temperature	0°C-40°C/32°F-104°F
Applicable Model	Compatible with iPhone, Samsung, LG, Moto etc. (4-6.5 inches phone)
Package List	Automatic Car Mount Wireless Charger x1, Charging Cable x1, Vent Clip x1, Quick Start Guide x1

The parameters above are derived from the laboratory of VICSEED. The actual parameters may differ from product to product or other factors. All images shown here are for reference only.

### Compatibility

**1. Charging**  
Before using this product, make sure your smartphone is compatible with Qi wireless charging technology. A Quick Charge 3.0 car charger is required for fast charging.

Smartphone	Car Charger	Output Power
Qi-Compatible Phones	5V = 2A	5W
iPhone Xs Max, iPhone XR, iPhone XS, iPhone X, iPhone 8 Plus, etc.	12V = 1.5A Quick Charge 3.0	7.5W
Samsung Galaxy S10+, S10e, S10, S9+, S9, S8+, S8, S7 Edge, S7, Note 8, etc.	12V = 1.5A Quick Charge 3.0	10W
LG G7 ThinQ, V30, V30S ThinQ, V35 ThinQ, V40 ThinQ, etc.	12V = 1.5A Quick Charge 3.0	15W

### 2. Car Air Vent

The vent clip is compatible with horizontal and vertical air vents, not fits arc-shaped or retraction-type air vents.

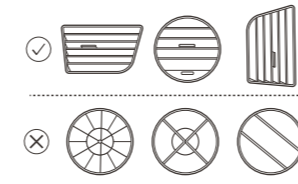

### 3. Phone Case

**Not compatible with:**  
a. Any foreign object between your smartphone and this car mount, such as metal, credit cards, door keys, coins, magnet, or NFC cards.  
b. Phone cases may affect wireless charging, such as ultra-thick (>4mm/0.16inch) phone case or a case with a bumpy surface, stand, etc.  
c. Popsockets, ring holder etc.

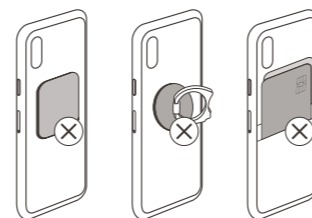

### Overview

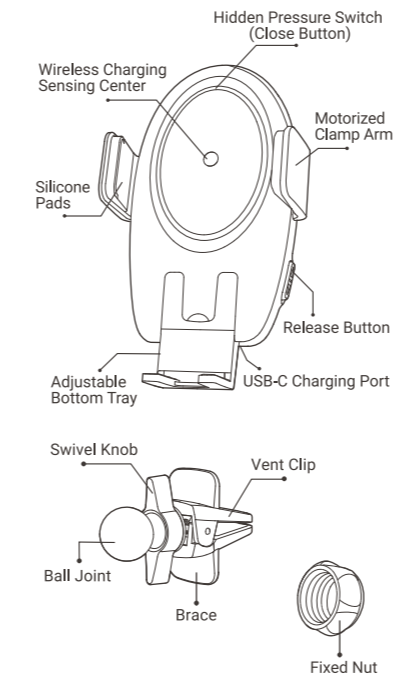

### Installation Steps

1. Unscrew the fixed nut completely, and let the ball joint pass through it. (The thread must face to the groove)

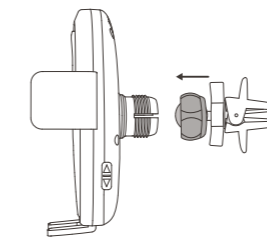

2. Push the ball joint firmly into the groove on the back of the car mount. Then tighten the fixed nut.

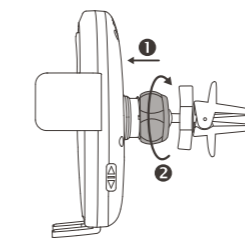

3. Twist swivel knob to adjust opening of this clip to fit your air vent.

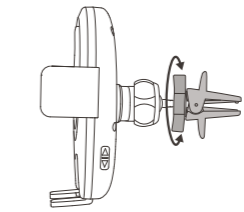

4. Attach the car mount to your air vent. Then tighten the swivel knob to secure the car mount firmly and adjust its angle to fit your view.

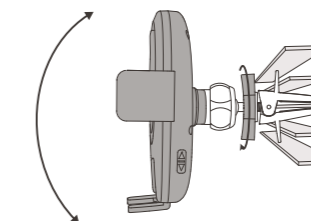

### Power On

Use original power cable included to connect the car mount wireless charger and a QC3.0 car charger adapter.

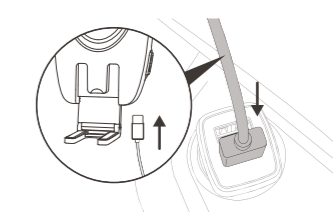

**Note:**  
Do not connect car mount wireless charger to the USB port of your car directly, as it will cause slow charging.

VDPI0022A

### Adjust the Bottom Tray

The wireless charging sensing center is located next to the central circle on this product.

For optimal charging performance, please adjust the height of the bottom tray to align your smartphone center with the central circle.

If there is no grading scale for your smartphone or you are using a phone case, just slightly adjust the bottom tray to align them.

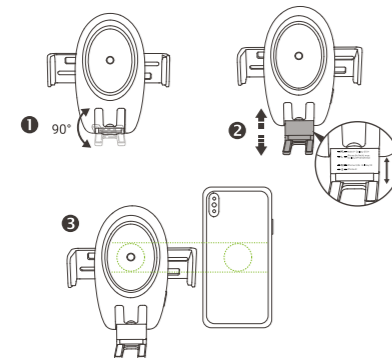

Scale	Phone Models
S	iPhone 8
M	iPhone X / Xs / Samsung Galaxy S7 / S8 / S9
L	iPhone Xs Max / Xr / 8 Plus / Samsung Galaxy S7 Edge / S8+ / S9+ / S10 / S10e
XL	Samsung Note 8 / Note 9 / S10+

### LED Indicator Instruction

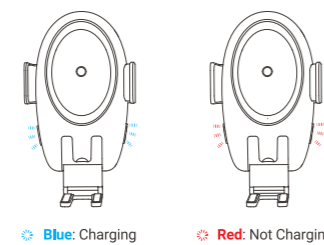

Charging Status	LED Indicator Display
Power on	Solid red for 3 seconds, then off
Standby	Indicator off
Charging	Blue
Foreign Object Detector	Flashing red for 10 times, then off

### Using Steps

1. Touch the release button on either side of the car mount wireless charger and the arms will open automatically.

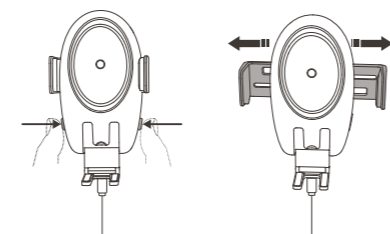

2. Put your phone into the car mount wireless charger (will trigger the hidden pressure switch) and the arms will automatically clamp. It will start to charge wirelessly. The indicator light will turn blue.

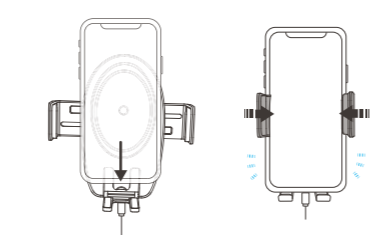

3. If the motorized clamp arms don't close, please press the top half of the phone to trigger the hidden pressure switch (Close Button).

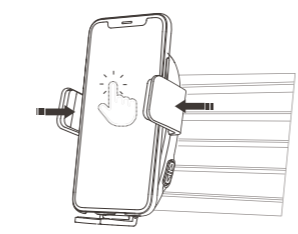

4. Touch the release button again, the arms will open automatically, then remove the phone carefully.

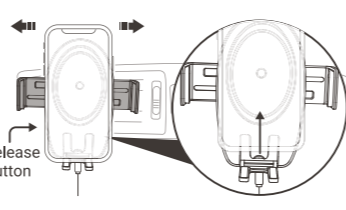

### FAQs

#### 1. Motorized arm not working

a. The built-in battery is designed to power the motorized clamp arms (it does not charge the smartphone), so the motorized clamp arms will work normally even if the car is off. When the battery has run out of power, the car mount wireless charger will beep and stop working. In this occasion, please get this item charged with the charging cable, so the clamps would work immediately, and charging the built-in battery at the same time.  
b. The clamp arm may not work alone in cold days, especially when temperature is 0°C/32°F or below. In this case, get your item charged and it will work as normal immediately. Or you can increase the temperature and wait a few minutes to get it worked well.  
c. Press the hidden pressure switch to check whether there are any abnormal sounds. Please contact VICSEED customer support to get your issue resolved if it sounds abnormal.

#### 2. Not charging or slow charging

a. Please check the status of the LED indicator.  
**Blue: Charging Red: Not Charging.**  
b. Adjust the bottom tray according to the manual to keep your smartphone center and wireless charging sensing center aligned.  
c. Fast charging mode requires a QC3.0 car charger adapter. Do not connect car mount wireless charger to the USB port of your car directly, as it will cause slow charging.  
d. Do not place any foreign object between your smartphone and this car mount, such as metal, credit cards, door keys, coins, magnet, or NFC cards;  
e. Don't use such phone cases that may affect wireless charging, as ultra-thick (>4mm/0.16inch) phone case or a case with a bumpy surface, stand; Do not compatible with popsockets, ring holder etc.

f. High-temperature may cause slow charging. Please turn off navigation and other apps, and lower the in-car temperature at the same time.  
g. Please use the original charging cable.

#### 3. Compatibility of air vents

This car mount wireless charger is suitable for the horizontal and vertical air vents only. For more details, please refer to "Compatibility > 2.Car Air Vent".

#### 4. Compatibility of phone cases

This car mount wireless charger is suitable for phone case thinner than 4mm/0.16inch". For more details please refer to "Compatibility > 3.Phone case".

#### 5. Working temperature

The working temperature range is 0°C-40°C/32°F-104°F. The car mount wireless charger may not work properly while the temperature is too high or too low.

### Safety Information

- Avoid dropping.
- Do not disassemble.
- Do not expose to liquids.
- Please use this car mount wireless charger in working temperature.
- Do not install it while driving.
- When you're choosing a spot to mount your smartphone, be careful not to place it directly in front of the airbags.
- Keep the car mount wireless charger away from children.
- WARNING: keep fingers away from hazardous moving parts.

### FCC ID Statement

Changes or modifications not expressly approved by the party responsible for compliance could void the user's authority to operate the equipment.

This equipment has been tested and found to comply with the limits for a Class B digital device, pursuant to Part 15 of the FCC Rules. These limits are designed to provide reasonable protection against harmful interference in a residential installation. This equipment generates uses and can radiate radio frequency energy and, if not installed and used in accordance with the instructions, may cause harmful interference to radio communications. However, there is no guarantee that interference will not occur in a particular installation. If this equipment does cause harmful interference to radio or television reception, which can be determined by turning the equipment off and on, the user is encouraged to try to correct the interference by one or more of the following measures:

- Reorient or relocate the receiving antenna.
- Increase the separation between the equipment and receiver.
- Connect the equipment into an outlet on a circuit different from that to which the receiver is connected.
- Consult the dealer or an experienced radio/TV technician for help.

This device complies with part 15 of the FCC rules. Operation is subject to the following two conditions (1) this device may not cause harmful interference, and (2) this device must accept any interference received, including interference that may cause undesired operation.



### Customer Service

12-month limited warranty

Lifetime technical support

support@vicseed.com

@vicseedglobal

For more information, please visit [www.vicseed.com](http://www.vicseed.com)

SHENZHEN HOMGMI TECHNOLOGY CO., LTD.

Add : RM 208, No.105-3, Jinyun RD, Buji ST, Longgang DIST, Shenzhen, China

Email: support@vicseed.com  
Web: www.vicseed.com

Shenzhen Homgmi Technology Co., Ltd.  
All Rights Reserved.

Made in China

编 码: VDPI0022A

物料名称: D#Vicseed 盾系列无线充车载支架(NEO全自动版)出风口说明书

材 质: 105克哑粉纸

工 艺: 三色两方, 双面印刷, 折, 上, 啤

备 注: DIECUT PANTONE 368C PANTONNE Black 7C

展开尺寸: 480×110 mm

成品尺寸: 60×110 mm

日 期: 2019.06.15

设 计: 罗清华

修 改:

批 准:

包装工程部

