



# TEST REPORT

## FCC PART 15.247

Report Reference No. ....: **CTL1710101011-WF**

Compiled by: ( position+printed name+signature)	Allen Wang (File administrators)	<u>Allen Wang</u>
Tested by: ( position+printed name+signature)	Nice Nong (Test Engineer)	<u>Nice Nong</u>
Approved by: ( position+printed name+signature)	Ivan Xie (Manager)	<u>Ivan Xie</u>

**Product Name**.....: LCD TV MONITOR

**Model/Type reference** .....: GL-550TV

**List Model(s)**.....: See next page

**Trade Mark**.....: N/A

**FCC ID**.....: 2APTO-GL-550TV

**Applicant's name** .....: **GUANGZHOU GOLD&LUCKY ELECTRONICS TECHNOLOGY CO.,LTD.**

**Address of applicant** .....: No.611th YUNTIAN BUILDING, LONGXINGXILU ROAD SOUTH, BAIYUN DISTRICT, GUANGZHOU, GUANGDONG, CHINA

**Test Firm**.....: **Shenzhen CTL Testing Technology Co., Ltd.**

**Address of Test Firm**.....: Floor 1-A, Baisha Technology Park, No.3011, Shahexi Road, Nanshan District, Shenzhen, China 518055

**Test specification**.....:

Standard.....: **FCC Part 15.247:** Operation within the bands 902-928 MHz, 2400-2483.5 MHz and 5725-5850 MHz.

TRF Originator .....: Shenzhen CTL Testing Technology Co., Ltd.

Master TRF .....: Dated 2011-01

**Date of Receipt**.....: Dec. 20, 2017

**Date of Test Date**.....: Dec. 20, 2017–Mar. 15, 2018

**Data of Issue**.....: Mar. 16, 2018

**Result**.....: Pass

**Shenzhen CTL Testing Technology Co., Ltd. All rights reserved.**

This publication may be reproduced in whole or in part for non-commercial purposes as long as the Shenzhen CTL Testing Technology Co., Ltd. is acknowledged as copyright owner and source of the material. Shenzhen CTL Testing Technology Co., Ltd. takes no responsibility for and will not assume liability for damages resulting from the reader's interpretation of the reproduced material due to its placement and context.

# TEST REPORT

<b>Test Report No. :</b>	<b>CTL1710101011-WF</b>	Mar. 16, 2018
		Date of issue

Equipment under Test : LCD TV MONITOR

Model /Type : GL-550TV

Listed Models : GL-150MT, GL-154MT, GL-156MT, GL-170MT, GL-190MT, GL-200MT, GL-210MT, GL-220MT, GL-240MT, GL-260MT, GL-270MT, GL-280MT, GL-300MT, GL-320MT, GL-400MT, GL-420MT, GL-430MT, GL-460MT, GL-500MT, GL-550MT, GL-580MT, GL-600MT, GL-630MT, GL-650MT, GL-700MT, GL-750MT, GL-800MT, GL-850MT, GL-900MT, GL-150TV, GL-154TV, GL-156TV, GL-170TV, GL-190TV, GL-200TV, GL-210TV, GL-220TV, GL-240TV, GL-260TV, GL-270TV, GL-280TV, GL-300TV, GL-320TV, GL-400TV, GL-420TV, GL-430TV, GL-460TV, GL-500TV, GL-580TV, GL-600TV, GL-630TV, GL-650TV, GL-700TV, GL-750TV, GL-800TV, GL-850TV, GL-900TV

Applicant : **GUANGZHOU GOLD&LUCKY ELECTRONICS TECHNOLOGY CO.,LTD.**

Address : No.611th YUNTIAN BUILDING, LONGXINGXILU ROAD SOUTH, BAIYUN DISTRICT, GUANGZHOU, GUANGDONG, CHINA

Manufacturer : **GUANGZHOU GOLD&LUCKY ELECTRONICS TECHNOLOGY CO.,LTD.**

Address : No.611th YUNTIAN BUILDING, LONGXINGXILU ROAD SOUTH, BAIYUN DISTRICT, GUANGZHOU, GUANGDONG, CHINA

<b>Test result</b>	<b>Pass *</b>
--------------------	---------------

\* In the configuration tested, the EUT complied with the standards specified page 5.

The test report merely corresponds to the test sample.

It is not permitted to copy extracts of these test result without the written permission of the test laboratory.



**T able of Contents**

**Page**

- 1. SUMMARY..... 5**
  - 1.1. TEST STANDARDS.....5
  - 1.2. TEST DESCRIPTION.....5
  - 1.3. TEST FACILITY .....6
  - 1.4. STATEMENT OF THE MEASUREMENT UNCERTAINTY.....6
- 2. GENERAL INFORMATION..... 7**
  - 2.1. ENVIRONMENTAL CONDITIONS .....7
  - 2.2. GENERAL DESCRIPTION OF EUT .....7
  - 2.3. DESCRIPTION OF TEST MODES AND TEST FREQUENCY.....7
  - 2.4. EQUIPMENTS USED DURING THE TEST .....8
  - 2.5. RELATED SUBMITTAL(S) / GRANT (S).....9
  - 2.6. MODIFICATIONS.....9
- 3. TEST CONDITIONS AND RESULTS ..... 10**
  - 3.1. CONDUCTED EMISSIONS TEST .....10
  - 3.2. RADIATED EMISSIONS AND BAND EDGE .....13
  - 3.3. MAXIMUM CONDUCTED OUTPUT POWER.....21
  - 3.4. POWER SPECTRAL DENSITY .....22
  - 3.5. 6dB BANDWIDTH.....25
  - 3.6. OUT-OF-BAND EMISSIONS .....28
  - 3.7. ANTENNA REQUIREMENT.....36
- 4. TEST SETUP PHOTOS OF THE EUT ..... 38**
- 5. PHOTOS OF THE EUT..... 40**

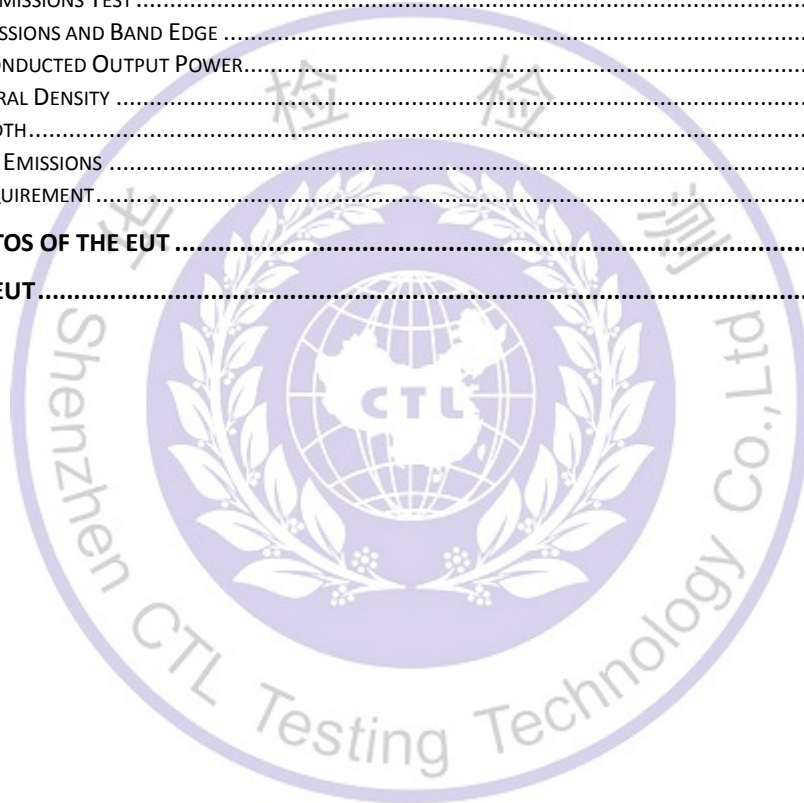

# 1. SUMMARY

## 1.1. TEST STANDARDS

The tests were performed according to following standards:

[FCC Rules Part 15.247](#): Frequency Hopping, Direct Spread Spectrum and Hybrid Systems that are in operation within the bands of 902-928 MHz, 2400-2483.5 MHz, and 5725-5850 MHz

[ANSI C63.10: 2013](#): American National Standard for Testing Unlicensed Wireless Devices

[KDB558074 D01 V03r05](#): Guidance for Performing Compliance Measurements on Digital Transmission Systems (DTS) Operating Under §15.247

## 1.2. Test Description

FCC PART 15.247		
FCC Part 15.207	AC Power Conducted Emission	PASS
FCC Part 15.247(a)(2)	6dB Bandwidth	PASS
FCC Part 15.247(d)	Spurious RF Conducted Emission	PASS
FCC Part 15.247(b)	Maximum Conducted Output Power	PASS
FCC Part 15.247(e)	Power Spectral Density	PASS
FCC Part 15.109/ 15.205/ 15.209	Radiated Emissions	PASS
FCC Part 15.247(d)	Band Edge	PASS
FCC Part 15.203/15.247 (b)	Antenna Requirement	PASS

### 1.3. Test Facility

#### 1.3.1 Address of the test laboratory

Shenzhen CTL Testing Technology Co., Ltd.

Floor 1-A, Baisha Technology Park, No. 3011, Shahexi Road, Nanshan, Shenzhen 518055 China

There is one 3m semi-anechoic chamber and two line conducted labs for final test. The Test Sites meet the requirements in documents ANSI C63.4 and CISPR 22/EN 55022 requirements.

#### 1.3.2 Laboratory accreditation

The test facility is recognized, certified, or accredited by the following organizations:

##### IC Registration No.: 9618B

The 3m alternate test site of Shenzhen CTL Testing Technology Co., Ltd. EMC Laboratory has been registered by Certification and Engineer Bureau of Industry Canada for the performance of with Registration No.: 9618B on November 13, 2013.

##### FCC-Registration No.: 399832

Shenzhen CTL Testing Technology Co., Ltd. EMC Laboratory has been registered and fully described in a report filed with the (FCC) Federal Communications Commission. The acceptance letter from the FCC is maintained in our files. Registration 399832, December 08, 2017.

### 1.4. Statement of the measurement uncertainty

The data and results referenced in this document are true and accurate. The reader is cautioned that there may be errors within the calibration limits of the equipment and facilities. The measurement uncertainty was calculated for all measurements listed in this test report acc. to CISPR 16 - 4 "Specification for radio disturbance and immunity measuring apparatus and methods – Part 4: Uncertainty in EMC Measurements" and is documented in the Shenzhen CTL Testing Technology Co., Ltd. quality system acc. to DIN EN ISO/IEC 17025. Furthermore, component and process variability of devices similar to that tested may result in additional deviation. The manufacturer has the sole responsibility of continued compliance of the device.

Hereafter the best measurement capability for CTL laboratory is reported:

Test	Measurement Uncertainty	Notes
Transmitter power conducted	±0.57 dB	(1)
Transmitter power Radiated	±2.20 dB	(1)
Conducted spurious emission 9KHz-40 GHz	±2.20 dB	(1)
Occupied Bandwidth	±0.01ppm	(1)
Radiated Emission 30~1000MHz	±4.10dB	(1)
Radiated Emission Above 1GHz	±4.32dB	(1)
Conducted Disturbance0.15~30MHz	±3.20dB	(1)

- (1) This uncertainty represents an expanded uncertainty expressed at approximately the 95% confidence level using a coverage factor of k=2.

## 2. GENERAL INFORMATION

### 2.1. Environmental conditions

During the measurement the environmental conditions were within the listed ranges:

Normal Temperature:	25°C
Relative Humidity:	55 %
Air Pressure:	101 kPa

### 2.2. General Description of EUT

Product Name:	LCD TV MONITOR
Model/Type reference:	GL-550TV
Power supply:	AC 120V/60Hz
<b>WIFI :</b>	
Supported type:	802.11b/802.11g/802.11n(H20)/802.11n(H40)
Modulation:	802.11b: DSSS 802.11g/802.11n(H20)/802.11n(H40): OFDM
Operation frequency:	802.11b/802.11g/802.11n(H20): 2412MHz~2462MHz 802.11n(H40): 2422MHz~2452MHz
Channel number:	802.11b/802.11g/802.11n(H20): 11 802.11n(H40): 7
Channel separation:	5MHz
Antenna type:	FPC antenna
Antenna gain:	2dBi

Note: For more details, please refer to the user's manual of the EUT.

### 2.3. Description of Test Modes and Test Frequency

The Applicant provides communication tools software to control the EUT for staying in continuous transmitting (Duty Cycle more than 98%) and receiving mode for testing.

There are 11 channels provided to the EUT and Channel 01/06/11 were selected for WIFI test.

#### Operation Frequency WIFI :

Channel	Frequency(MHz)	Channel	Frequency(MHz)
1	2412	8	2447
2	2417	9	2452
3	2422	10	2457
4	2427	11	2462
5	2432		
6	2437		
7	2442		

Note: The line display in grey were the channel selected for testing

**Data Rate Used:**

Preliminary tests were performed in different data rate to find the worst radiated emission. The data rate shown in the table below is the worst-case rate with respect to the specific test item. Investigation has been done on all the possible configurations for searching the worst cases. The following table is a list of the test modes shown in this test report.

Test Items	Mode	Data Rate	Channel
Maximum Conducted Output Power Power Spectral Density 6dB Bandwidth Spurious RF conducted emission Radiated Emission 9kHz~1GHz& Radiated Emission 1GHz~10th Harmonic	11b/DSSS	1 Mbps	1/6/11
	11g/OFDM	6 Mbps	1/6/11
	11n(20MHz)/OFDM	6.5Mbps	1/6/11
	11n(40MHz)/OFDM	13.5Mbps	3/6/9
Band Edge	11b/DSSS	1 Mbps	1/11
	11g/OFDM	6 Mbps	1/11
	11n(20MHz)/OFDM	6.5Mbps	1/11
	11n(40MHz)/OFDM	13.5Mbps	3/9

**2.4. Equipments Used during the Test**

Test Equipment	Manufacturer	Model No.	Serial No.	Calibration Date	Calibration Due Date
LISN	R&S	ENV216	3560.6550.1 2	2017/06/02	2018/06/01
LISN	R&S	ESH2-Z5	860014/010	2017/06/02	2018/06/01
Bilog Antenna	Sunol Sciences Corp.	JB1	A061713	2017/06/02	2018/06/01
EMI Test Receiver	R&S	ESCI	103710	2017/06/02	2018/06/01
Spectrum Analyzer	Agilent	E4407B	MY41440676	2017/05/21	2018/05/20
Spectrum Analyzer	Agilent	N9020	US46220290	2018/01/16	2019/01/17
Power Meter	Anritsu	ML2487B	110553	2017/06/02	2018/06/01
Power Sensor	Anritsu	MA2411B	100345	2017/05/21	2018/05/20
Controller	EM Electronics	Controller EM 1000	N/A	2017/05/21	2018/05/20
Horn Antenna	Sunol Sciences Corp.	DRH-118	A062013	2017/05/19	2018/05/18
Active Loop Antenna	SCHWARZBECK	FMZB1519	1519-037	2017/05/19	2018/05/18
Amplifier	Agilent	8349B	3008A02306	2017/05/19	2018/05/18
Amplifier	Agilent	8447D	2944A10176	2017/05/19	2018/05/18
Temperature/Humidity Meter	Gangxing	CTH-608	02	2017/05/20	2018/05/19
High-Pass Filter	K&L	9SH10-2700/X1 2750-O/O	N/A	2017/05/20	2018/05/19



High-Pass Filter	K&L	41H10-1375/U1 2750-O/O	N/A	2017/05/20	2018/05/19
Coaxial Cables	HUBER+SUHNER	SUCOFLEX 104PEA-10M	10m	2017/06/02	2018/06/01
Coaxial Cables	HUBER+SUHNER	SUCOFLEX 104PEA-3M	3m	2017/06/02	2018/06/01
Coaxial Cables	HUBER+SUHNER	SUCOFLEX 104PEA-3M	3m	2017/06/02	2018/06/01
RF Cable	Megalon	RF-A303	N/A	2017/06/02	2018/06/01

The calibration interval was one year

## 2.5. Related Submittal(s) / Grant (s)

This submittal(s) (test report) is intended to comply with Section 15.247 of the FCC Part 15, Subpart C Rules.

## 2.6. Modifications

No modifications were implemented to meet testing criteria.

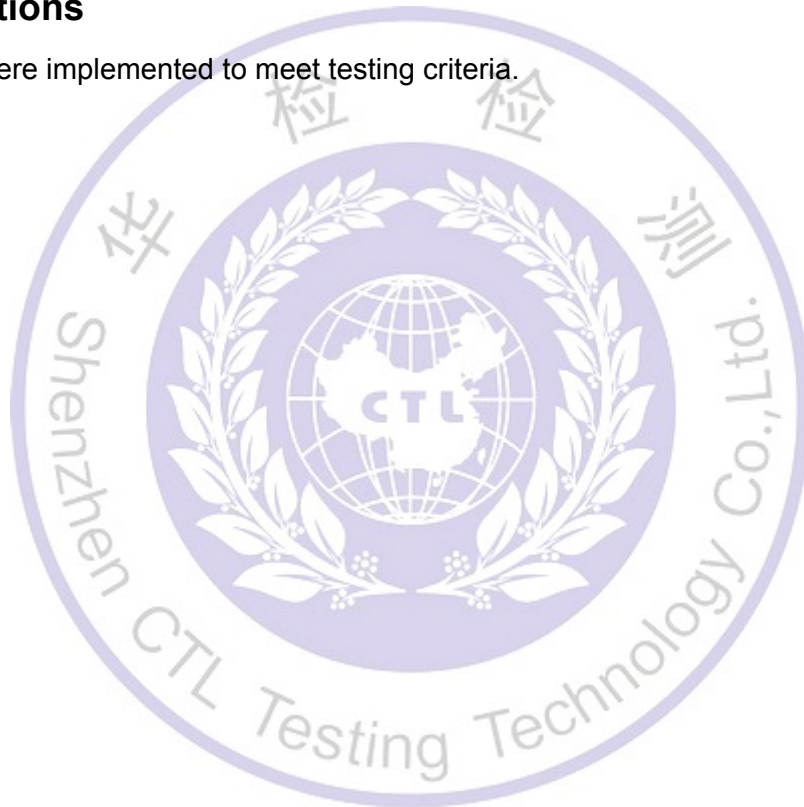

### 3. TEST CONDITIONS AND RESULTS

#### 3.1. Conducted Emissions Test

##### LIMIT

FCC CFR Title 47 Part 15 Subpart C Section 15.207

Frequency range (MHz)	Limit (dBuV)	
	Quasi-peak	Average
0.15-0.5	66 to 56*	56 to 46*
0.5-5	56	46
5-30	60	50

\* Decreases with the logarithm of the frequency.

##### TEST CONFIGURATION



##### TEST PROCEDURE

1. The equipment was set up as per the test configuration to simulate typical actual usage per the user's manual. The EUT is a tabletop system; a wooden table with a height of 0.8 meters is used and is placed on the ground plane as per ANSI C63.10:2013.
2. Support equipment, if needed, was placed as per ANSI C63.10:2013.
3. All I/O cables were positioned to simulate typical actual usage as per ANSI C63.10:2013.
4. The adapter received AC120V/60Hz power through a Line Impedance Stabilization Network (LISN) which supplied power source and was grounded to the ground plane.
5. All support equipments received AC power from a second LISN, if any.
6. The EUT test program was started. Emissions were measured on each current carrying line of the EUT using a spectrum Analyzer / Receiver connected to the LISN powering the EUT. The LISN has two monitoring points: Line 1 (Hot Side) and Line 2 (Neutral Side). Two scans were taken: one with Line 1 connected to Analyzer / Receiver and Line 2 connected to a 50 ohm load; the second scan had Line 1 connected to a 50 ohm load and Line 2 connected to the Analyzer / Receiver.
7. Analyzer / Receiver scanned from 150 KHz to 30MHz for emissions in each of the test modes.
8. During the above scans, the emissions were maximized by cable manipulation.

**TEST RESULTS**

Remark:802.11b/802.11g/802.11n(H20)/802.11n(H40) mode all have been tested ,only worse case of 802.11b High Channel was reported.

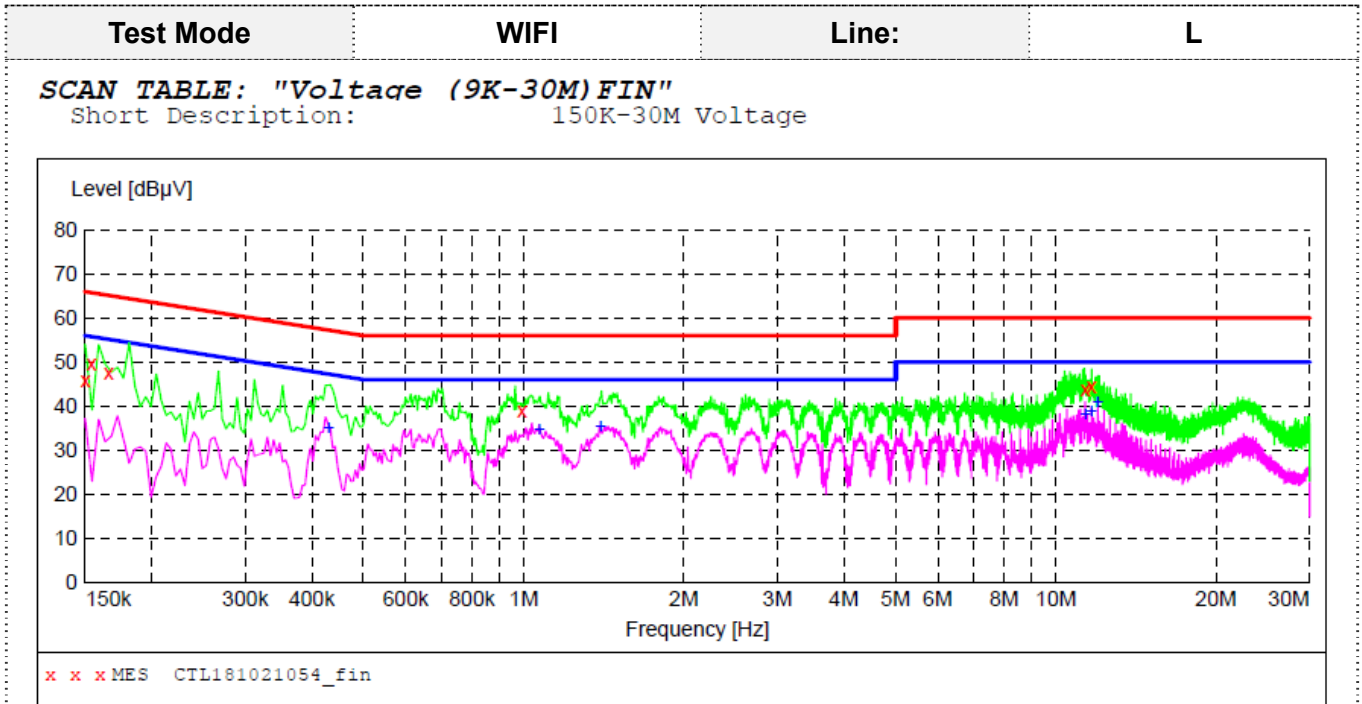

**MEASUREMENT RESULT: "CTL181021054\_fin"**

21/10/2018 19:54

Frequency MHz	Level dBµV	Transd dB	Limit dBµV	Margin dB	Detector	Line	PE
0.150000	45.80	10.2	66	20.2	QP	L1	GND
0.154000	49.80	10.2	66	16.0	QP	L1	GND
0.166000	47.50	10.2	65	17.7	QP	L1	GND
0.992000	38.90	10.3	56	17.1	QP	L1	GND
11.348000	43.90	10.6	60	16.1	QP	L1	GND
11.672000	44.50	10.6	60	15.5	QP	L1	GND

**MEASUREMENT RESULT: "CTL181021054\_fin2"**

21/10/2018 19:54

Frequency MHz	Level dBµV	Transd dB	Limit dBµV	Margin dB	Detector	Line	PE
0.430000	35.10	10.2	47	12.2	AV	L1	GND
1.070000	34.80	10.3	46	11.2	AV	L1	GND
1.394000	35.50	10.3	46	10.5	AV	L1	GND
11.348000	38.10	10.6	50	11.9	AV	L1	GND
11.672000	39.00	10.6	50	11.0	AV	L1	GND
11.996000	41.00	10.6	50	9.0	AV	L1	GND

Test Mode	WIFI	Line:	N
-----------	------	-------	---

**SCAN TABLE: "Voltage (9K-30M)FIN"**  
 Short Description: 150K-30M Voltage

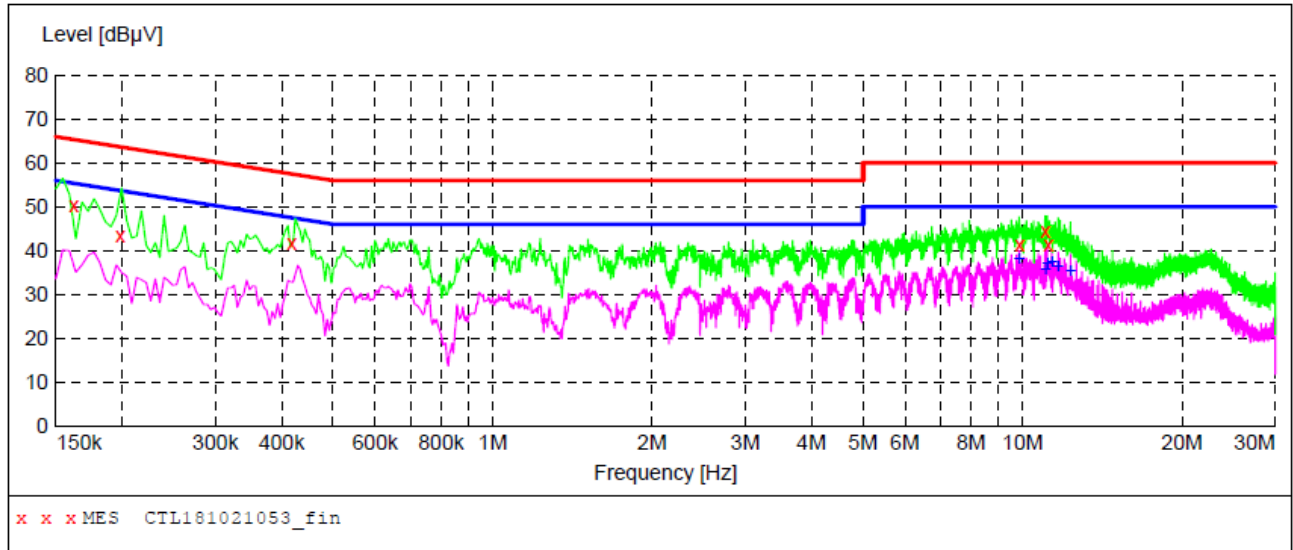

**MEASUREMENT RESULT: "CTL181021053\_fin"**

21/10/2018 19:51

Frequency MHz	Level dBµV	Transd dB	Limit dBµV	Margin dB	Detector	Line	PE
0.162000	50.30	10.2	65	15.1	QP	N	GND
0.198000	43.40	10.2	64	20.3	QP	N	GND
0.418000	41.70	10.2	58	15.8	QP	N	GND
9.866000	41.20	10.6	60	18.8	QP	N	GND
11.030000	44.40	10.6	60	15.6	QP	N	GND
11.180000	41.50	10.6	60	18.5	QP	N	GND

**MEASUREMENT RESULT: "CTL181021053\_fin2"**

21/10/2018 19:51

Frequency MHz	Level dBµV	Transd dB	Limit dBµV	Margin dB	Detector	Line	PE
9.854000	38.30	10.6	50	11.7	AV	N	GND
11.036000	36.00	10.6	50	14.0	AV	N	GND
11.138000	37.20	10.6	50	12.8	AV	N	GND
11.354000	37.40	10.6	50	12.6	AV	N	GND
11.672000	36.40	10.6	50	13.6	AV	N	GND
12.320000	35.40	10.6	50	14.6	AV	N	GND

### 3.2. Radiated Emissions and Band Edge

#### Limit

For intentional device, according to § 15.209(a), the general requirement of field strength of radiated emission out of authorized band shall not exceed the following table at a 3 meters measurement distance.

In addition, radiated emissions which fall in the restricted bands, as defined in §15.205(a), must also comply with the radiated emission limits specified in §15.209(a)

Radiated emission limits

Frequency (MHz)	Distance (Meters)	Radiated (dBµV/m)	Radiated (µV/m)
0.009-0.49	3	$20\log(2400/F(\text{KHz}))+40\log(300/3)$	$2400/F(\text{KHz})$
0.49-1.705	3	$20\log(24000/F(\text{KHz}))+ 40\log(30/3)$	$24000/F(\text{KHz})$
1.705-30	3	$20\log(30)+ 40\log(30/3)$	30
30-88	3	40.0	100
88-216	3	43.5	150
216-960	3	46.0	200
Above 960	3	54.0	500

#### TEST CONFIGURATION

(A) Radiated Emission Test Set-Up, Frequency Below 30MHz



(B) Radiated Emission Test Set-Up, Frequency below 1000MHz

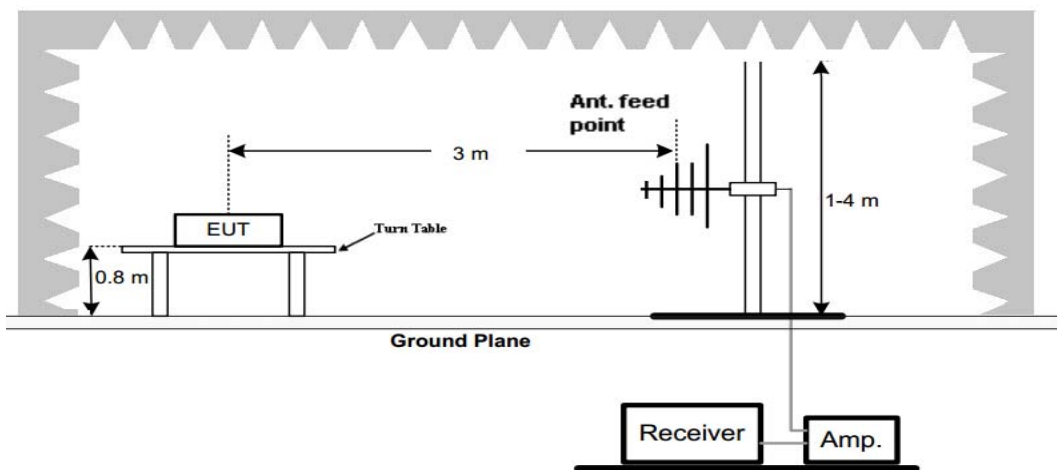

(C) Radiated Emission Test Set-Up, Frequency above 1000MHz



### Test Procedure

1. Below 1GHz measurement the EUT is placed on a turntable which is 0.8m above ground plane, and above 1GHz measurement EUT was placed on a low permittivity and low loss tangent turn table which is 1.5m above ground plane.
2. Maximum procedure was performed by raising the receiving antenna from 1m to 4m and rotating the turn table from 0° to 360° to acquire the highest emissions from EUT
3. And also, each emission was to be maximized by changing the polarization of receiving antenna both horizontal and vertical.
4. Repeat above procedures until all frequency measurements have been completed.

### TEST RESULTS

Remark:

1. All three channels (lowest/middle/highest) of each mode were measured below 1GHz and recorded worst case at 802.11b low channel.
2. All three channels (lowest/middle/highest) of each mode were measured above 1GHz and recorded worst case at 802.11b mode.
3. Radiated emission test from 9 KHz to 10th harmonic of fundamental was verified, and no emission found except system noise floor in 9 KHz to 30MHz and not recorded in this report.

For 30MHz-1GHz

Test mode:	WIFI	Polarization:	Horizontal
------------	------	---------------	------------

**SCAN TABLE: "Voltage (9K-30M)FIN"**

Short Description: 150K-30M Voltage

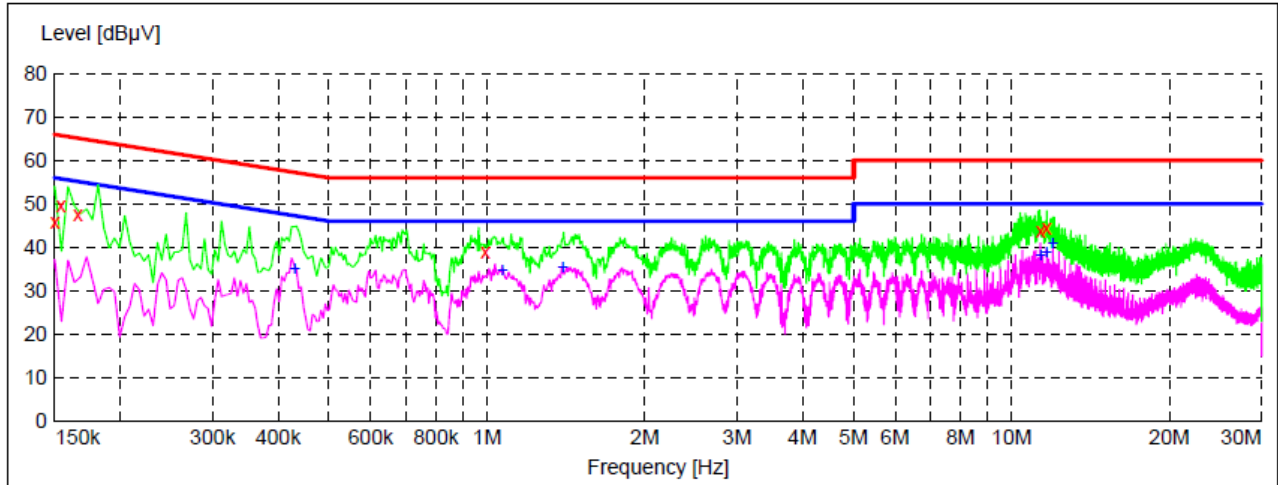

x x x MES CTL171021054\_fin

**MEASUREMENT RESULT: "CTL171021054\_fin"**

21/10/2017 19:54

Frequency MHz	Level dBµV	Transd dB	Limit dBµV	Margin dB	Detector	Line	PE
0.150000	45.80	10.2	66	20.2	QP	L1	GND
0.154000	49.80	10.2	66	16.0	QP	L1	GND
0.166000	47.50	10.2	65	17.7	QP	L1	GND
0.992000	38.90	10.3	56	17.1	QP	L1	GND
11.348000	43.90	10.6	60	16.1	QP	L1	GND
11.672000	44.50	10.6	60	15.5	QP	L1	GND

**MEASUREMENT RESULT: "CTL171021054\_fin2"**

21/10/2017 19:54

Frequency MHz	Level dBµV	Transd dB	Limit dBµV	Margin dB	Detector	Line	PE
0.430000	35.10	10.2	47	12.2	AV	L1	GND
1.070000	34.80	10.3	46	11.2	AV	L1	GND
1.394000	35.50	10.3	46	10.5	AV	L1	GND
11.348000	38.10	10.6	50	11.9	AV	L1	GND
11.672000	39.00	10.6	50	11.0	AV	L1	GND
11.996000	41.00	10.6	50	9.0	AV	L1	GND

Test mode:	WIFI	Polarization:	Vertical
------------	------	---------------	----------

**SCAN TABLE: "Voltage (9K-30M) FIN"**  
 Short Description: 150K-30M Voltage

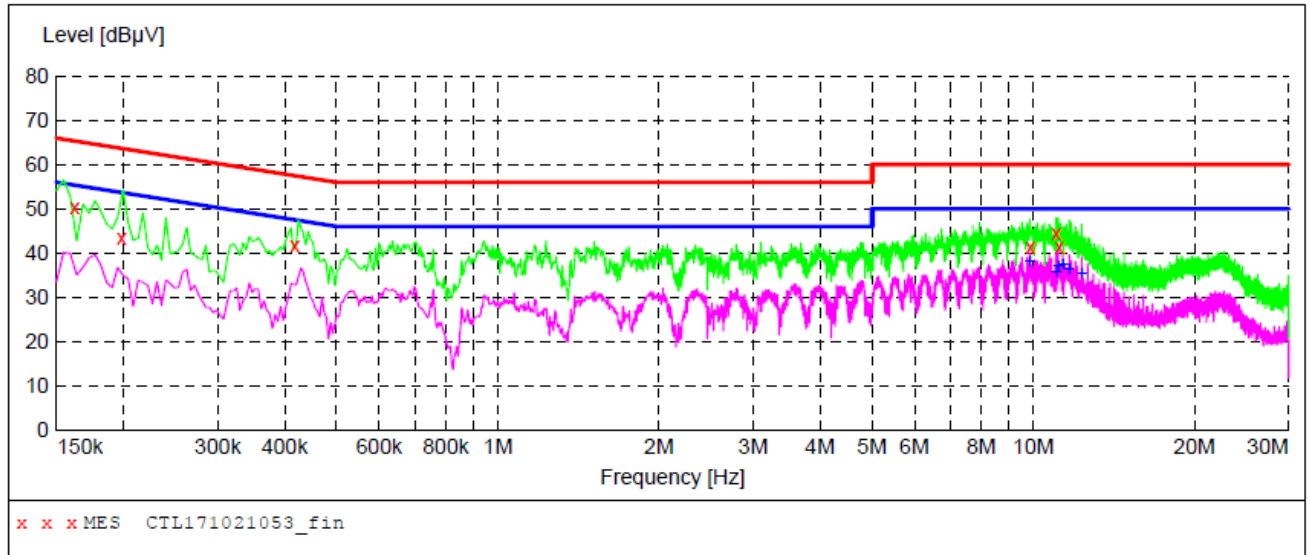

**MEASUREMENT RESULT: "CTL171021053\_fin"**

21/10/2017 19:51

Frequency MHz	Level dBµV	Transd dB	Limit dBµV	Margin dB	Detector	Line	PE
0.162000	50.30	10.2	65	15.1	QP	N	GND
0.198000	43.40	10.2	64	20.3	QP	N	GND
0.418000	41.70	10.2	58	15.8	QP	N	GND
9.866000	41.20	10.6	60	18.8	QP	N	GND
11.030000	44.40	10.6	60	15.6	QP	N	GND
11.180000	41.50	10.6	60	18.5	QP	N	GND

**MEASUREMENT RESULT: "CTL171021053\_fin2"**

21/10/2017 19:51

Frequency MHz	Level dBµV	Transd dB	Limit dBµV	Margin dB	Detector	Line	PE
9.854000	38.30	10.6	50	11.7	AV	N	GND
11.036000	36.00	10.6	50	14.0	AV	N	GND
11.138000	37.20	10.6	50	12.8	AV	N	GND
11.354000	37.40	10.6	50	12.6	AV	N	GND
11.672000	36.40	10.6	50	13.6	AV	N	GND
12.320000	35.40	10.6	50	14.6	AV	N	GND



**For 1GHz to 25GHz****802.11b Mode (above 1GHz)**

Note: 802.11b/802.11g/802.11n (H20)/802.11n (H40) all have been tested, only worse case 802.11b is reported

Frequency(MHz):			2412		Polarity:			HORIZONTAL	
Frequency (MHz)	Emission Level (dBuV/m)		Limit (dBuV/m)	Margin (dB)	Raw Value (dBuV)	Antenna Factor (dB/m)	Cable Factor (dB)	Pre-amplifier (dB)	Correction Factor (dB/m)
4824.00	57.05	PK	74	16.95	52.50	33.52	6.92	35.89	4.55
4824.00	52.11	AV	54	1.89	47.56	33.52	6.92	35.89	4.55
5125.75	48.24	PK	74	25.76	41.04	34.38	7.10	34.28	7.20
5125.75	--	AV	54	--	--	--	--	--	--
7236.00	49.72	PK	74	24.28	38.45	37.1	9.19	35.02	11.27
7236.00	--	AV	54	--	--	--	--	--	--

Frequency(MHz):			2412		Polarity:			VERTICAL	
Frequency (MHz)	Emission Level (dBuV/m)		Limit (dBuV/m)	Margin (dB)	Raw Value (dBuV)	Antenna Factor (dB/m)	Cable Factor (dB)	Pre-amplifier (dB)	Correction Factor (dB/m)
4824.00	58.14	PK	74	15.86	53.59	33.52	6.92	35.89	4.55
4824.00	51.91	AV	54	2.09	47.36	33.52	6.92	35.89	4.55
5125.75	48.08	PK	74	25.92	40.88	34.38	7.10	34.28	7.20
5125.75	--	AV	54	--	--	--	--	--	--
7236.00	49.36	PK	74	24.64	38.09	37.1	9.19	35.02	11.27
7236.00	--	AV	54	--	--	--	--	--	--

Frequency(MHz):			2437		Polarity:			HORIZONTAL	
Frequency (MHz)	Emission Level (dBuV/m)		Limit (dBuV/m)	Margin (dB)	Raw Value (dBuV)	Antenna Factor (dB/m)	Cable Factor (dB)	Pre-amplifier (dB)	Correction Factor (dB/m)
4874.00	57.38	PK	74	16.62	51.14	33.59	6.95	34.3	6.24
4874.00	50.13	AV	54	3.87	43.89	33.59	6.95	34.3	6.24
5215.50	48.02	PK	74	25.98	40.42	34.56	7.15	34.11	7.60
5215.50	--	AV	54	--	--	--	--	--	--
7311.00	47.48	PK	74	26.52	35.82	37.44	9.22	35	11.66
7311.00	--	AV	54	--	--	--	--	--	--

Frequency(MHz):			2437		Polarity:			VERTICAL	
Frequency (MHz)	Emission Level (dBuV/m)		Limit (dBuV/m)	Margin (dB)	Raw Value (dBuV)	Antenna Factor (dB/m)	Cable Factor (dB)	Pre-amplifier (dB)	Correction Factor (dB/m)
4874.00	56.84	PK	74	17.16	50.50	33.59	6.95	34.2	6.34
4874.00	51.61	AV	54	2.39	45.27	33.59	6.95	34.2	6.34
5215.50	47.72	PK	74	26.28	40.82	34.07	7.05	34.22	6.90
5215.50	--	AV	54	--	--	--	--	--	--
7311.00	48.05	PK	74	25.95	36.39	37.44	9.22	35	11.66
7311.00	--	AV	54	--	--	--	--	--	--

Frequency(MHz):			2462		Polarity:			HORIZONTAL	
Frequency (MHz)	Emission Level (dBuV/m)		Limit (dBuV/m)	Margin (dB)	Raw Value (dBuV)	Antenna Factor (dB/m)	Cable Factor (dB)	Pre-amplifier (dB)	Correction Factor (dB/m)
4924.00	57.66	PK	74	16.34	53.55	33.71	6.98	35.91	4.78
4924.00	50.12	AV	54	3.88	43.73	33.71	6.98	35.91	4.78
5110.50	48.27	PK	74	25.73	41.24	34.34	7.09	34.27	7.17
5110.50	--	AV	54	--	--	--	--	--	--
7386.00	48.75	PK	74	25.25	37.4	37.61	9.25	34.98	11.88
7386.00	--	AV	54	--	--	--	--	--	--

Frequency(MHz):			2462		Polarity:			VERTICAL	
Frequency (MHz)	Emission Level (dBuV/m)		Limit (dBuV/m)	Margin (dB)	Raw Value (dBuV)	Antenna Factor (dB/m)	Cable Factor (dB)	Pre-amplifier (dB)	Correction Factor (dB/m)
4924.00	58.28	PK	74	15.72	53.5	33.71	6.98	35.91	4.78
4924.00	52.73	AV	54	1.27	47.95	33.71	6.98	35.91	4.78
5110.50	46.22	PK	74	27.78	39.05	34.34	7.09	34.27	7.17
5110.50	--	AV	54	--	--	--	--	--	--
7386.00	48.81	PK	74	25.19	36.93	37.61	9.25	34.98	11.88
7386.00	--	AV	54	--	--	--	--	--	--

## REMARKS:

1. Emission level (dBuV/m) =Raw Value (dBuV)+Correction Factor (dB/m)
2. Correction Factor (dB/m) = Antenna Factor (dB/m)+Cable Factor (dB)-Pre-amplifier Factor
3. Margin value = Limit value- Emission level.
4. -- Mean the PK detector measured value is below average limit.
5. The other emission levels were very low against the limit.
6. RBW1MHz VBW3MHz Peak detector is for PK value; RMS detector is for AV value.

**Results of Band Edges Test (Radiated)**

Note: 802.11b/802.11g/802.11n (H20)/802.11n (H40) all have been tested, only worse case 802.11b is reported

Frequency(MHz):			2412		Polarity:			HORIZONTAL	
Frequency (MHz)	Emission Level (dBuV/m)		Limit (dBuV/m)	Margin (dB)	Raw Value (dBuV)	Antenna Factor (dB/m)	Cable Factor (dB)	Pre-amplifier (dB)	Correction Factor (dB/m)
2412.00	115.33	PK	--	--	81.94	28.78	4.61	0	33.39
2412.00	109.68	AV	--	--	76.29	28.78	4.61	0	33.39
2357.15	46.29	PK	74	27.71	13.21	28.52	4.56	0	33.08
2357.15	--	AV	54	--	--	--	--	--	--
2390.00	57.07	PK	74	16.93	23.75	28.72	4.60	0	33.32
2390.00	51.84	AV	54	2.16	18.52	28.72	4.60	0	33.32
2400.00	58.62	PK	74	15.38	25.23	28.78	4.61	0	33.39
2400.00	52.01	AV	54	1.99	18.62	28.78	4.61	0	33.39

Frequency(MHz):			2412		Polarity:			VERTICAL	
Frequency (MHz)	Emission Level (dBuV/m)		Limit (dBuV/m)	Margin (dB)	Raw Value (dBuV)	Antenna Factor (dB/m)	Cable Factor (dB)	Pre-amplifier (dB)	Correction Factor (dB/m)
2412.00	115.27	PK	--	--	81.88	28.78	4.61	0	33.39
2412.00	108.96	AV	--	--	75.57	28.78	4.61	0	33.39
2357.15	46.22	PK	74	27.78	13.14	28.52	4.56	0	33.08
2357.15	--	AV	54	--	--	--	--	--	--
2390.00	58.07	PK	74	15.93	24.75	28.72	4.60	0	33.32
2390.00	51.72	AV	54	2.28	18.4	28.72	4.60	0	33.32
2400.00	58.61	PK	74	15.39	25.22	28.78	4.61	0	33.39
2400.00	52.28	AV	54	1.72	18.89	28.78	4.61	0	33.39

Frequency(MHz):			2462		Polarity:			HORIZONTAL	
Frequency (MHz)	Emission Level (dBuV/m)		Limit (dBuV/m)	Margin (dB)	Raw Value (dBuV)	Antenna Factor (dB/m)	Cable Factor (dB)	Pre-amplifier (dB)	Correction Factor (dB/m)
2462.00	116.06	PK	--	--	82.44	28.92	4.7	0	33.62
2462.00	110.71	AV	--	--	77.09	28.92	4.7	0	33.62
2483.50	44.38	PK	74	29.62	10.75	28.93	4.7	0	33.63
2483.50	--	AV	54	--	--	--	--	--	--
2486.75	46.13	PK	74	27.87	12.49	28.94	4.71	0	33.64
2486.75	--	AV	54	--	--	--	--	--	--
2500.00	45.26	PK	74	28.74	11.58	28.96	4.72	0	33.68
2500.00	--	AV	54	--	--	--	--	--	--

Frequency(MHz):			2462		Polarity:			VERTICAL	
Frequency (MHz)	Emission Level (dBuV/m)		Limit (dBuV/m)	Margin (dB)	Raw Value (dBuV)	Antenna Factor (dB/m)	Cable Factor (dB)	Pre-amplifier (dB)	Correction Factor (dB/m)
2462.00	115.95	PK	--	--	82.33	28.92	4.7	0	33.62
2462.00	110.41	AV	--	--	76.79	28.92	4.7	0	33.62
2483.50	43.84	PK	74	30.16	10.21	28.93	4.7	0	33.63
2483.50	--	AV	54	--	--	--	--	--	--
2486.75	44.08	PK	74	29.92	10.44	28.94	4.71	0	33.64
2486.75	--	AV	54	--	--	--	--	--	--
2500.00	44.71	PK	74	29.29	11.03	28.96	4.72	0	33.68
2500.00	--	AV	54	--	--	--	--	--	--

## REMARKS:

1. Emission level (dBuV/m) =Raw Value (dBuV)+Correction Factor (dB/m)
2. Correction Factor (dB/m) = Antenna Factor (dB/m)+Cable Factor (dB)-Pre-amplifier Factor
3. Margin value = Limit value- Emission level.
4. -- Mean the PK detector measured value is below average limit.
5. The other emission levels were very low against the limit.
6. RBW1MHz VBW3MHz Peak detector is for PK value; RMS detector is for AV value.

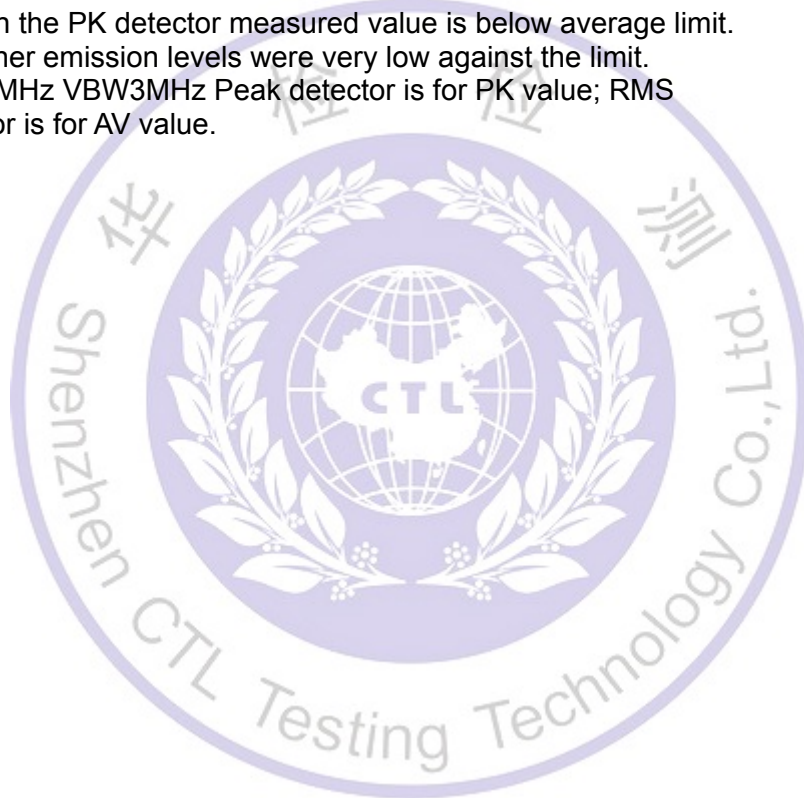

### 3.3. Maximum Conducted Output Power

#### Limit

The Maximum Peak Output Power Measurement is 30dBm.

#### Test Procedure

Remove the antenna from the EUT and then connect a low loss RF cable from the antenna port to the power sensor.

#### Test Configuration

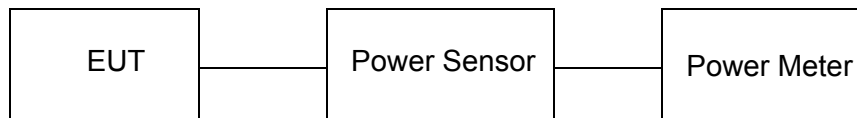

#### Test Results

WIFI				
Type	Channel	Output power PK (dBm)	Limit (dBm)	Result
802.11b	01	22.25	30.00	Pass
	06	22.83		
	11	23.16		
802.11g	01	19.06	30.00	Pass
	06	19.75		
	11	21.04		
802.11n(HT20)	01	20.31	30.00	Pass
	06	19.93		
	11	19.95		
802.11n(HT40)	03	19.65	30.00	Pass
	06	20.27		
	09	19.54		

Note: 1.The test results including the cable lose.

### 3.4. Power Spectral Density

#### Limit

For digitally modulated systems, the power spectral density conducted from the intentional radiator to the antenna shall not be greater than 8 dBm in any 3 kHz band during any time interval of continuous transmission.

#### Test Procedure

1. Use this procedure when the maximum peak conducted output power in the fundamental emission is used to demonstrate compliance.
2. Set the RBW  $\geq$  3 kHz.
3. Set the VBW  $\geq$  3 $\times$  RBW.
4. Set the span to 1.5 times the DTS channel bandwidth.
5. Detector = peak.
6. Sweep time = auto couple.
7. Trace mode = max hold.
8. Allow trace to fully stabilize.
9. Use the peak marker function to determine the maximum power level.
10. If measured value exceeds limit, reduce RBW (no less than 3 kHz) and repeat.
11. The resulting peak PSD level must be 8dBm.

#### Test Configuration



#### Test Results

WIFI				
Type	Channel	Power Spectral Density (dBm/3KHz)	Limit (dBm/3KHz)	Result
802.11b	01	-10.318	8.00	Pass
	06	-9.922		
	11	-9.567		
802.11g	01	-16.034	8.00	Pass
	06	-15.461		
	11	-14.362		
802.11n(HT20)	01	-15.393	8.00	Pass
	06	-15.190		
	11	-15.708		
802.11n(HT40)	03	-16.488	8.00	Pass
	06	-18.380		
	09	-17.019		

Test plot as follows:

802.11b

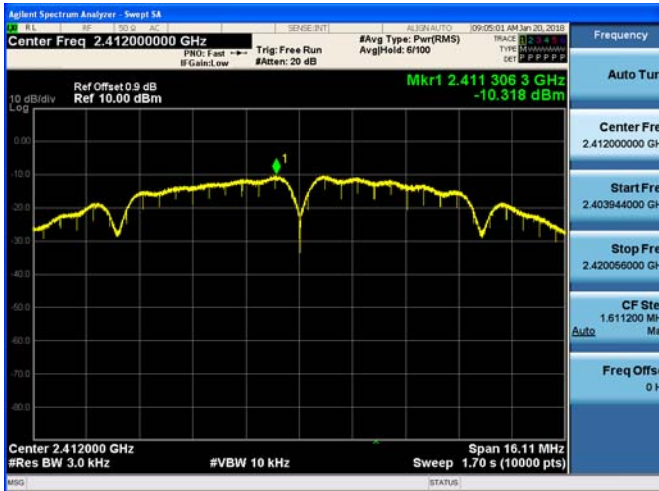

802.11g

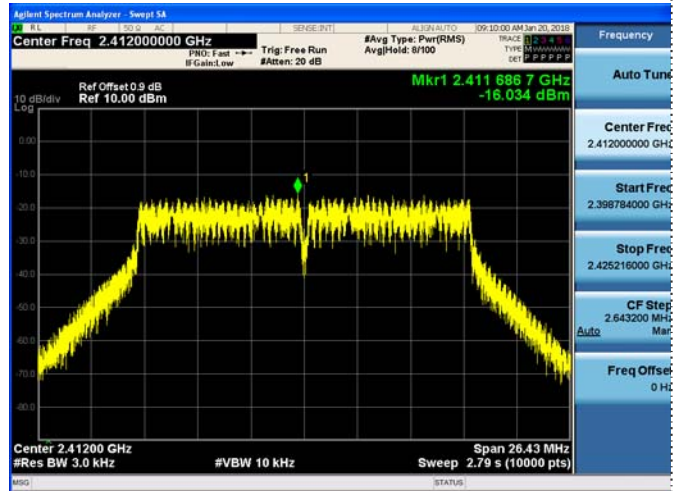

CH01



CH01

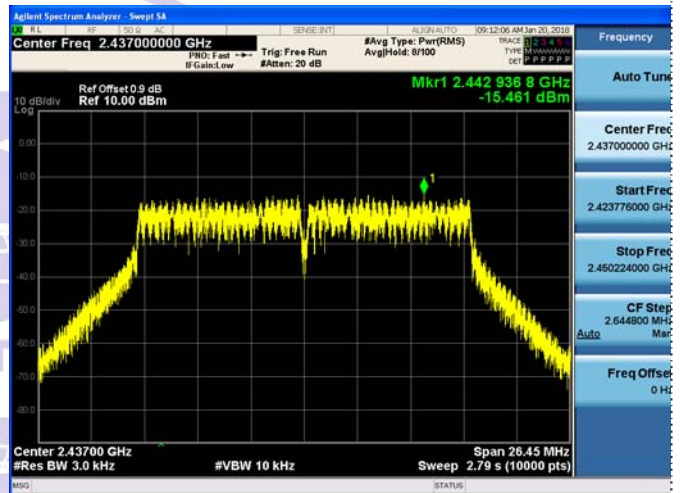

CH06



CH06

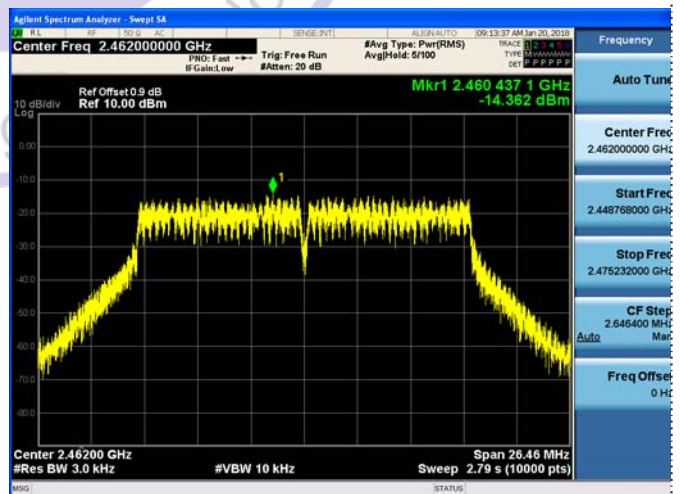

CH11



CH11



802.11n(HT20)

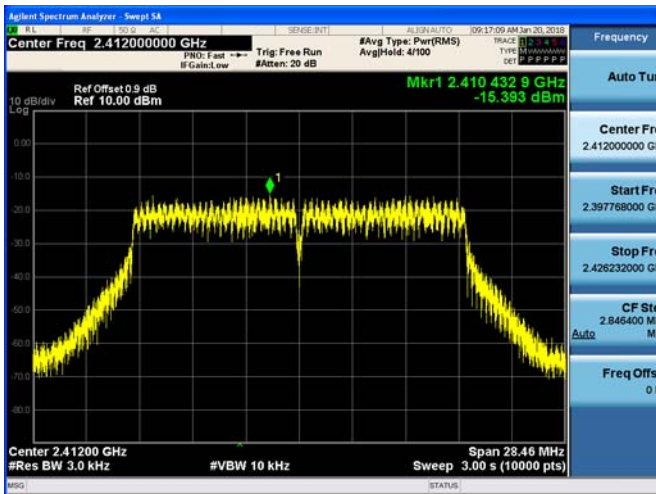

802.11n(HT40)

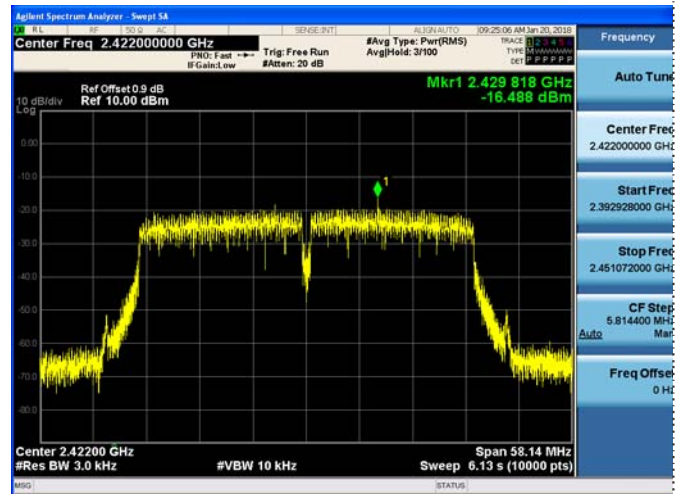

CH01

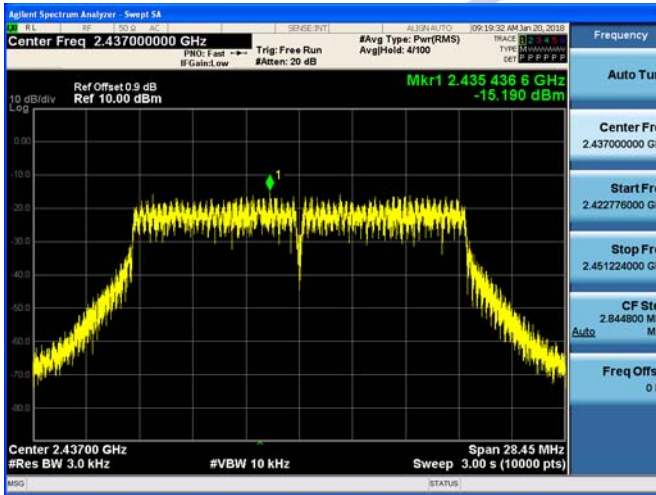

CH03

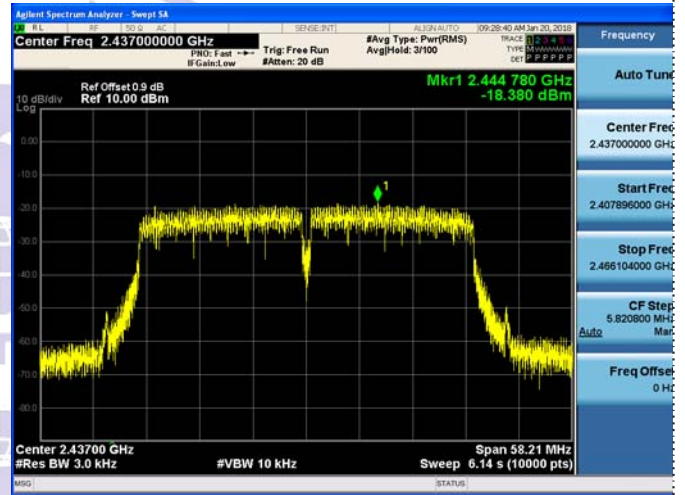

CH06

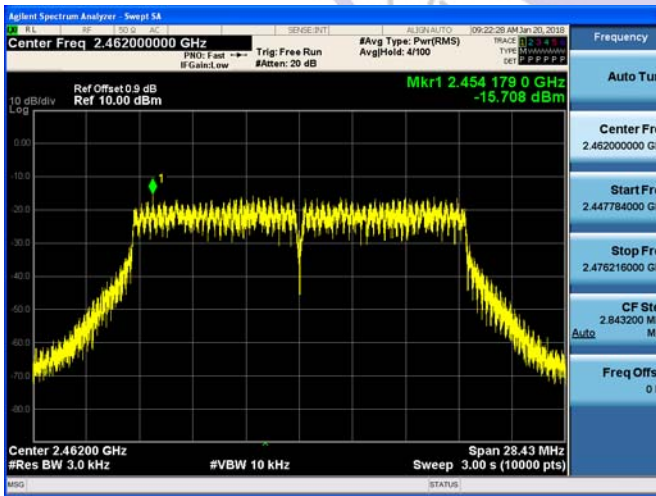

CH06

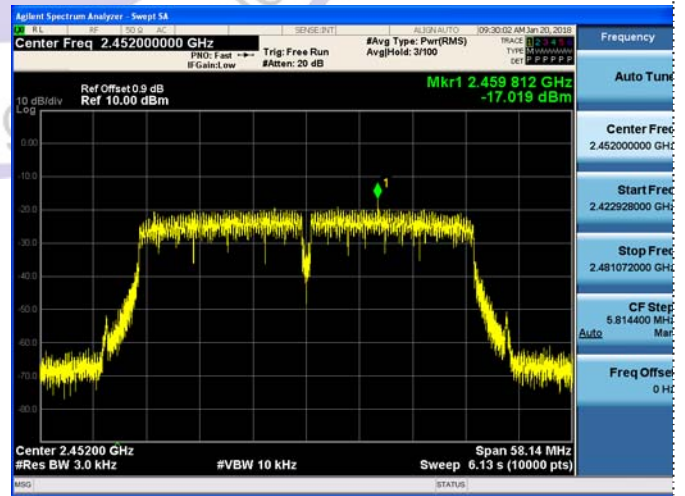

CH11



CH09





### 3.5. 6dB Bandwidth

#### Limit

For digital modulation systems, the minimum 6 dB bandwidth shall be at least 500 kHz

#### Test Procedure

The transmitter output was connected to the spectrum analyzer through an attenuator. The bandwidth of the fundamental frequency was measured by spectrum analyzer with 100 KHz RBW and 300 KHz VBW. The 6dB bandwidth is defined as the total spectrum the power of which is higher than peak power minus 6dB.

#### Test Configuration



#### Test Results

<i>WIFI</i>					
Type	Channel	6dB Bandwidth (MHz)	99% OBW (MHz)	Limit (KHz)	Result
802.11b	01	10.07	15.155	≥500	Pass
	06	10.08	15.199		
	11	10.08	15.331		
802.11g	01	16.52	16.453	≥500	Pass
	06	16.53	16.449		
	11	16.54	16.459		
802.11n(HT20)	01	17.79	17.655	≥500	Pass
	06	17.78	17.656		
	11	17.77	17.649		
802.11n(HT40)	03	36.34	35.900	≥500	Pass
	06	36.38	35.914		
	09	36.34	35.885		

Test plot as follows:

802.11b

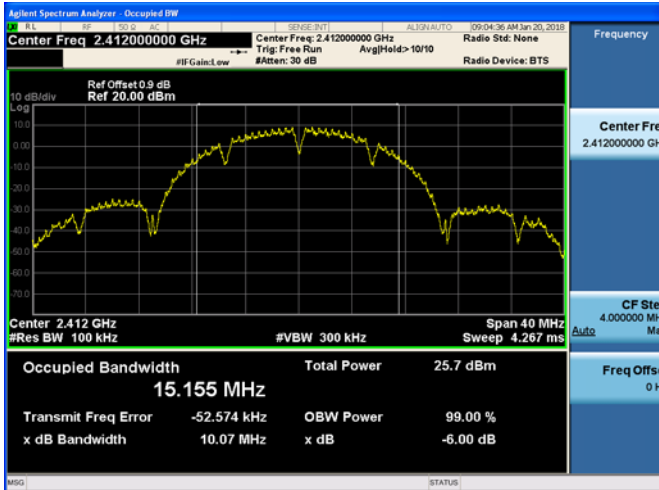

802.11g

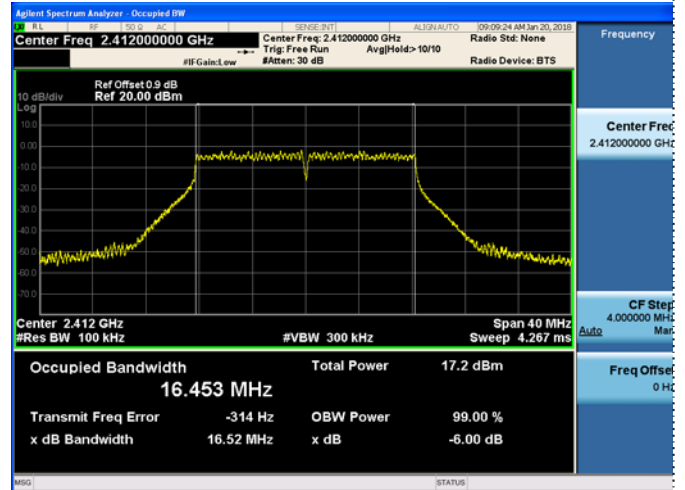

CH01

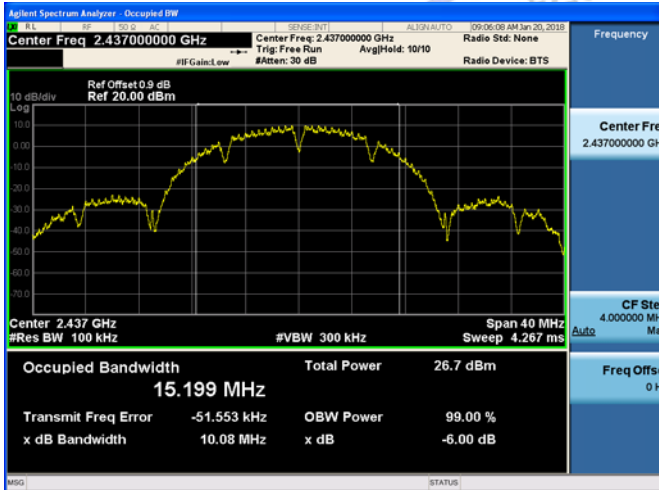

CH01

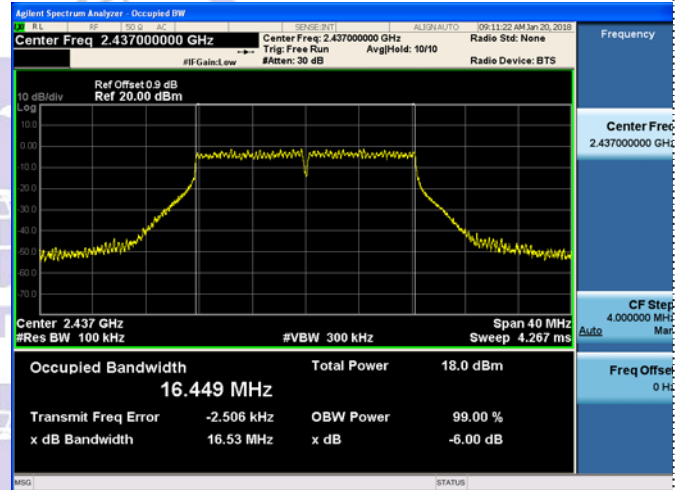

CH06

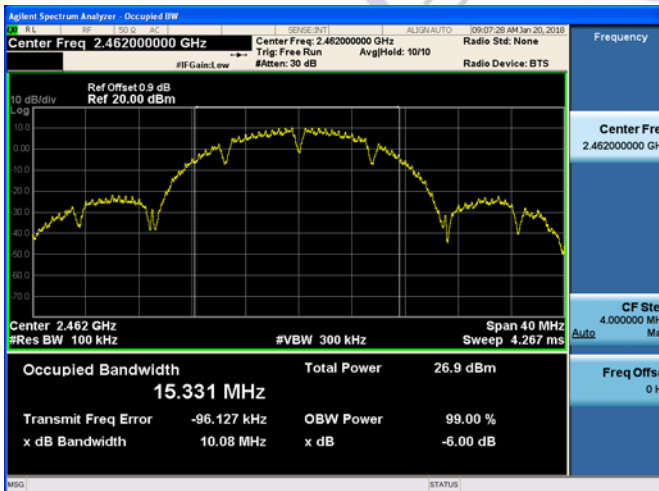

CH06

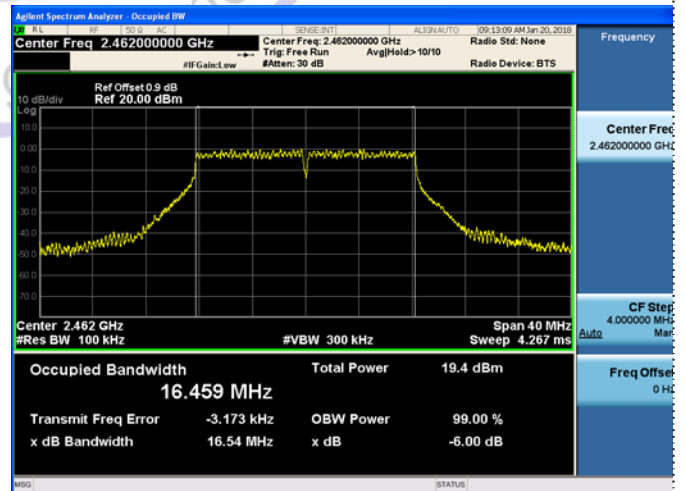

CH11



CH11



802.11n(HT20)

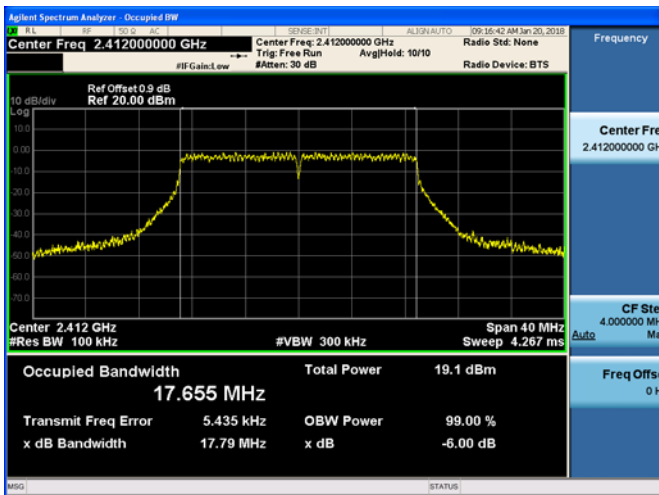

802.11n(HT40)

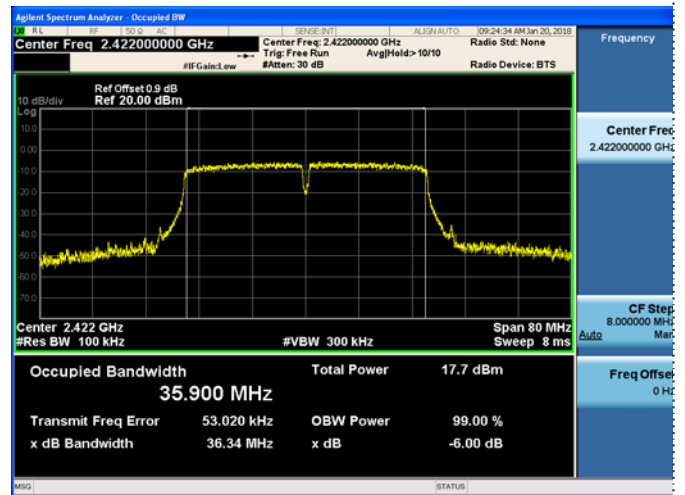

CH01

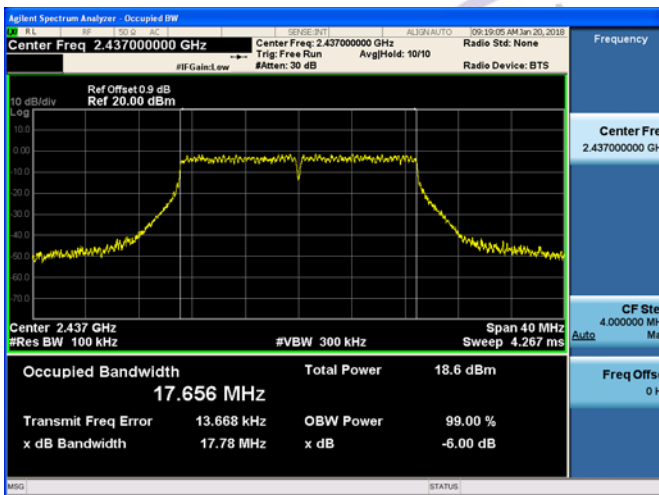

CH03

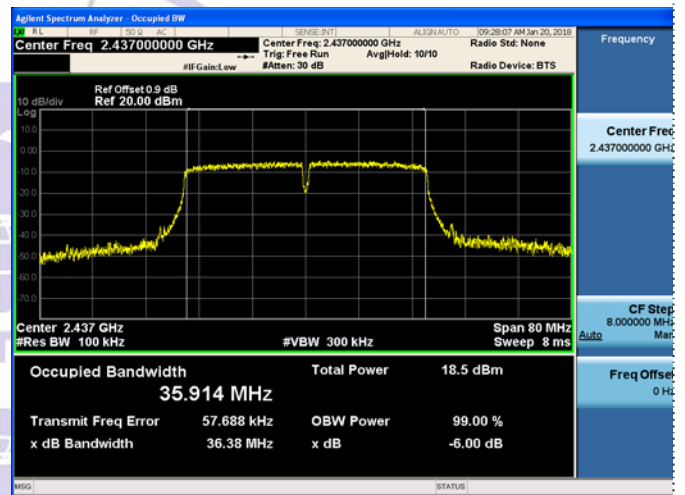

CH06

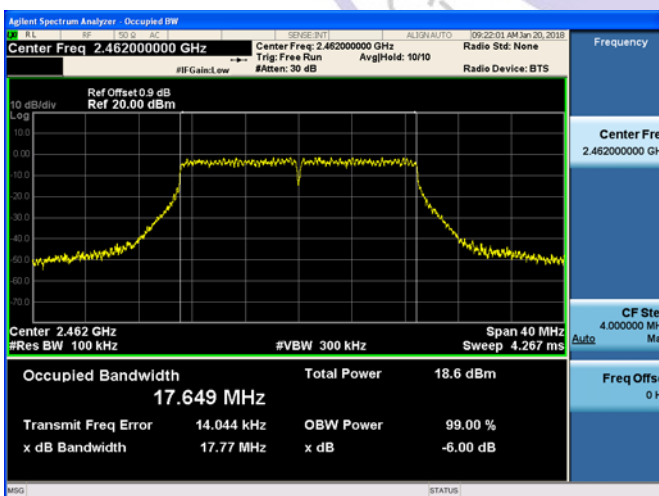

CH06

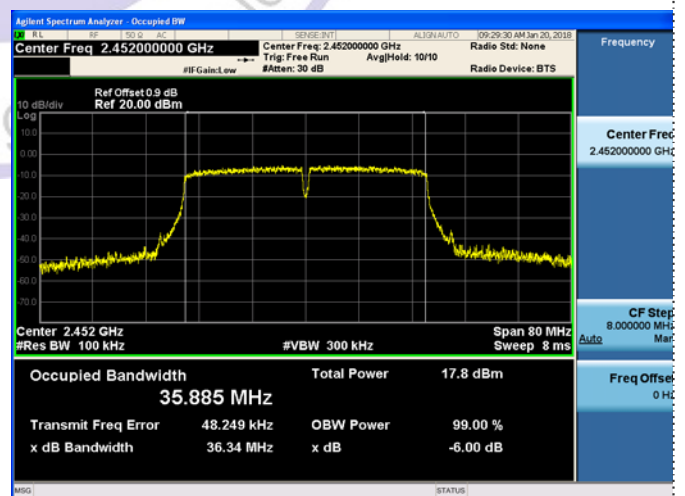

CH11



CH09



### 3.6. Out-of-band Emissions

#### Limit

In any 100 kHz bandwidth outside the frequency band in which the spread spectrum or digitally modulated intentional radiator is operating, the radio frequency power that is produced by the intentional radiator shall be at least 20 dB below that in the 100 kHz bandwidth within the band that contains the highest level of the desired power, based on either an RF conducted or a radiated measurement, provided the transmitter demonstrates compliance with the peak conducted power limits. If the transmitter complies with the conducted power limits based on the use of RMS averaging over a time interval, as permitted under paragraph (b)(3) of this section, the attenuation required under this paragraph shall be 30 dB instead of 20 dB. Attenuation below the general limits specified in §15.209(a) is not required.

#### Test Procedure

Connect the transmitter output to spectrum analyzer using a low loss RF cable, and set the spectrum analyzer to RBW=100 kHz, VBW= 300 kHz, peak detector, and max hold. Measurements utilizing these settings are made of the in-band reference level, band-edge and out-of-band emissions.

#### Test Configuration



#### Test Results

Remark: The measurement frequency range is from 30MHz to the 10th harmonic of the fundamental frequency. The lowest, middle and highest channels are tested to verify the spurious emissions and band-edge measurement data.

Test plot as follows:

802.11b CH01

802.11b CH06



Reference

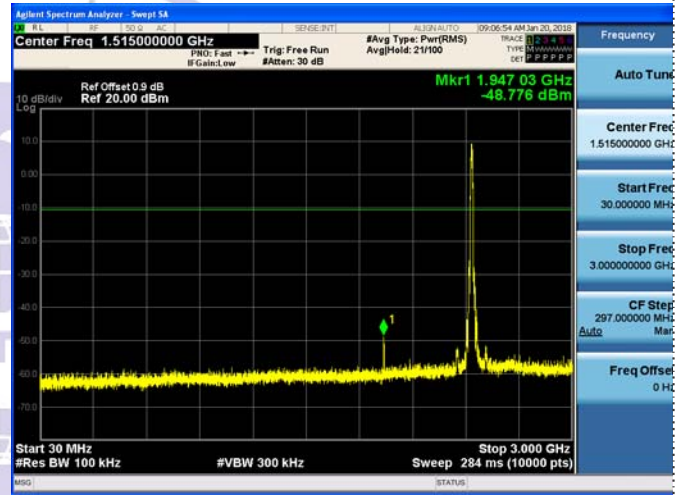
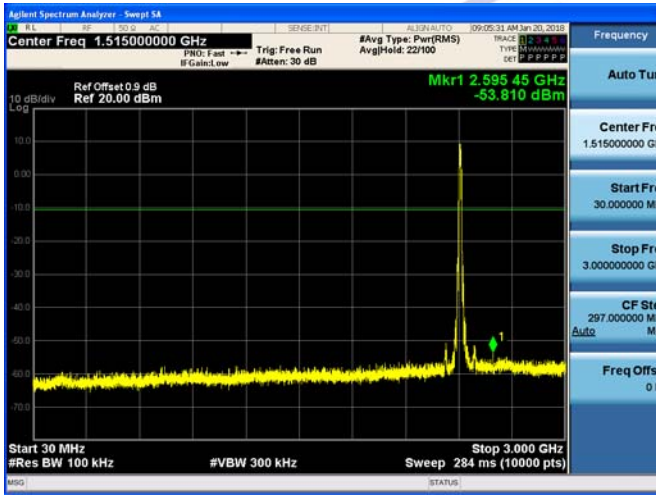

30MHz-3GHz

30MHz-3GHz

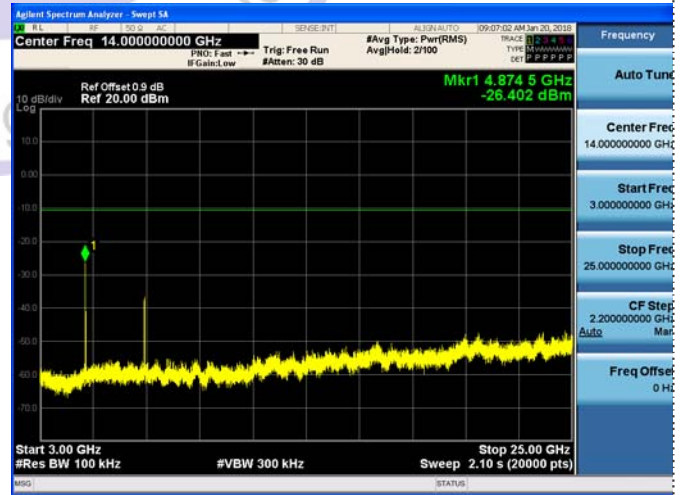
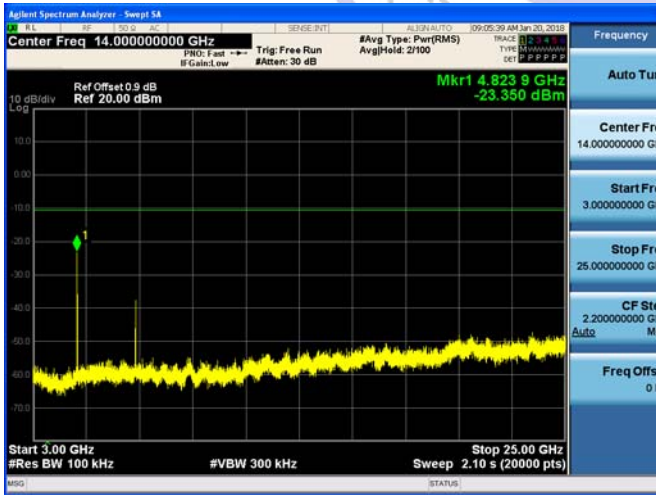

3GHz-25GHz

3GHz-25GHz

802.11b CH11

802.11g CH01

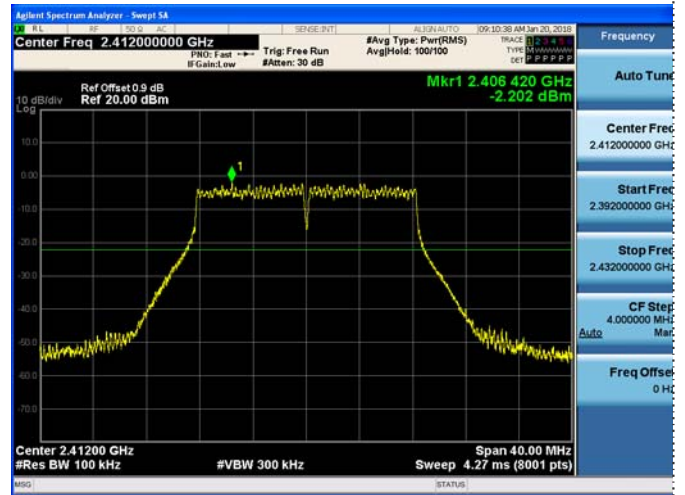

Reference

Reference

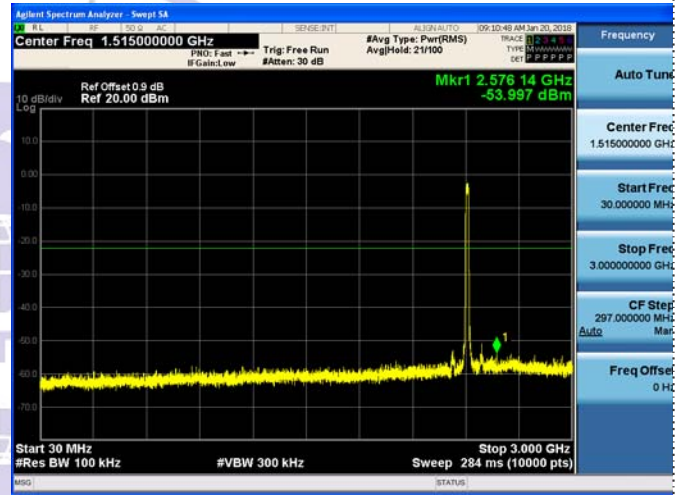
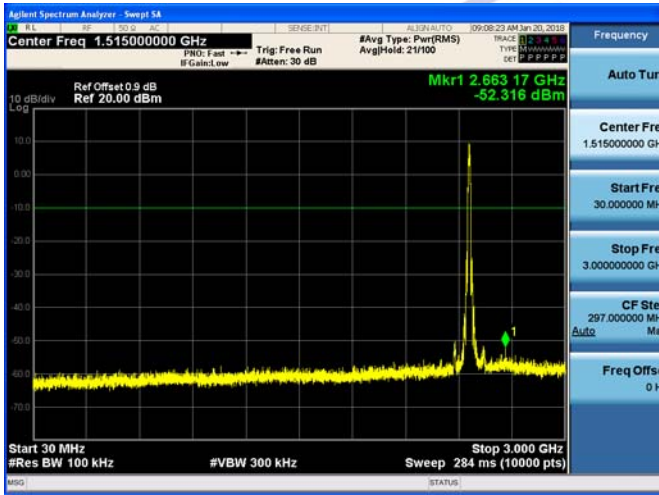

30MHz-3GHz

30MHz-3GHz

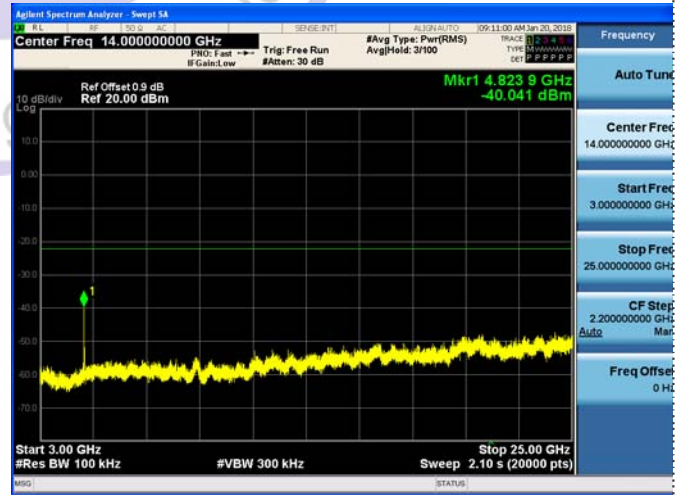
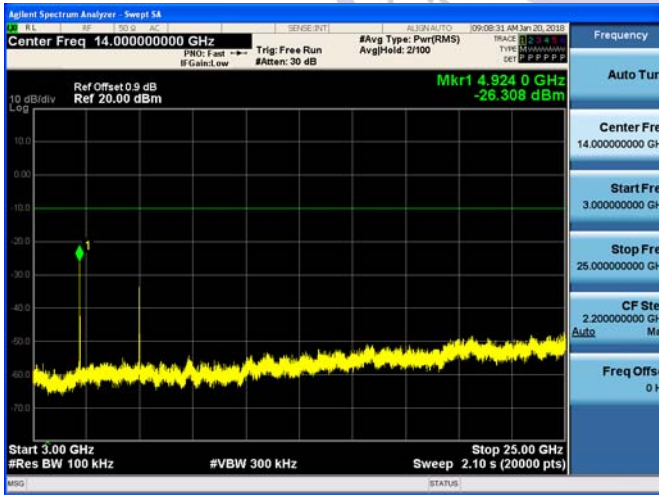

3GHz-25GHz

3GHz-25GHz

802.11g CH06

802.11g CH11

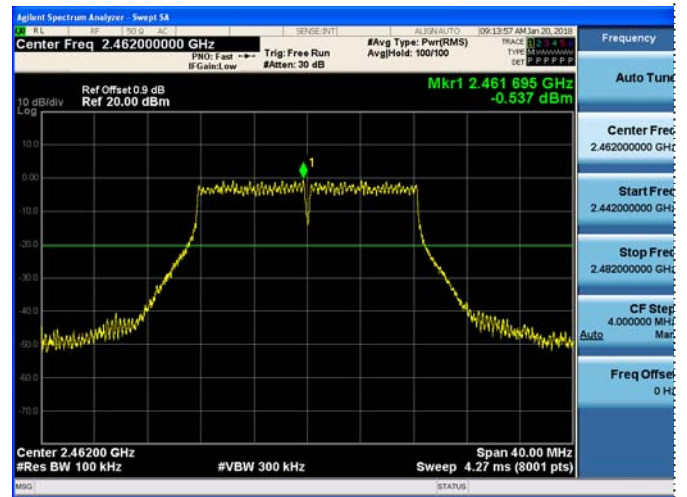
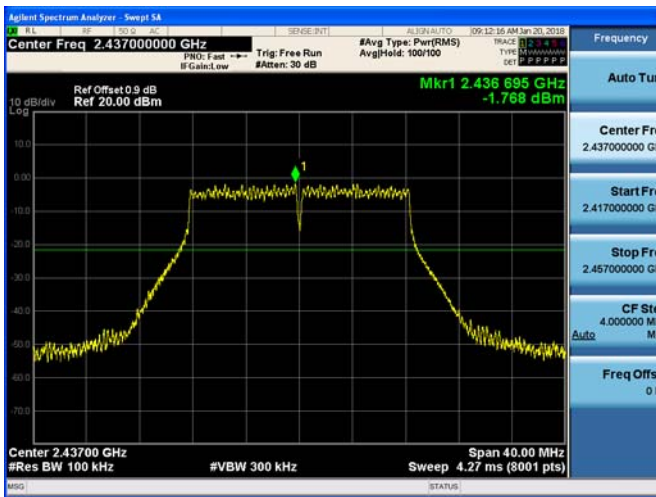

Reference

Reference

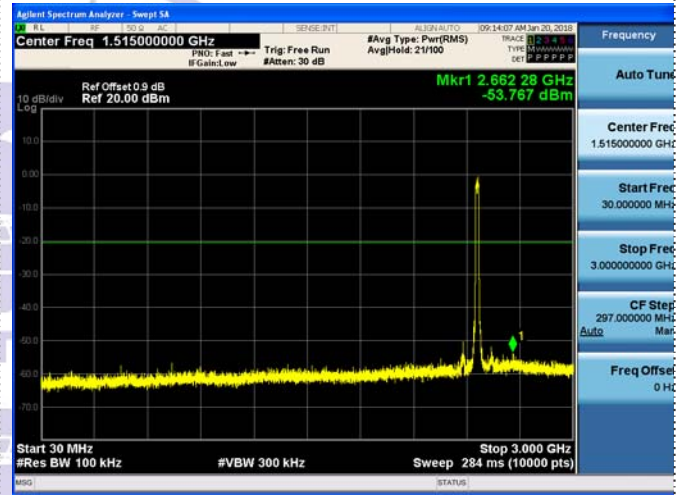
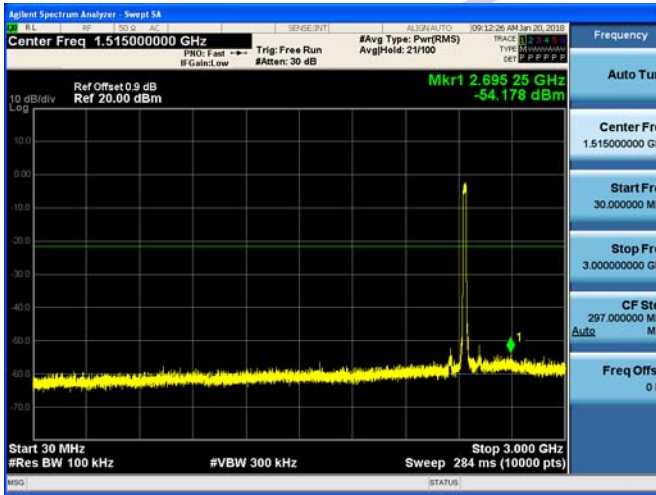

30MHz-3GHz

30MHz-3GHz

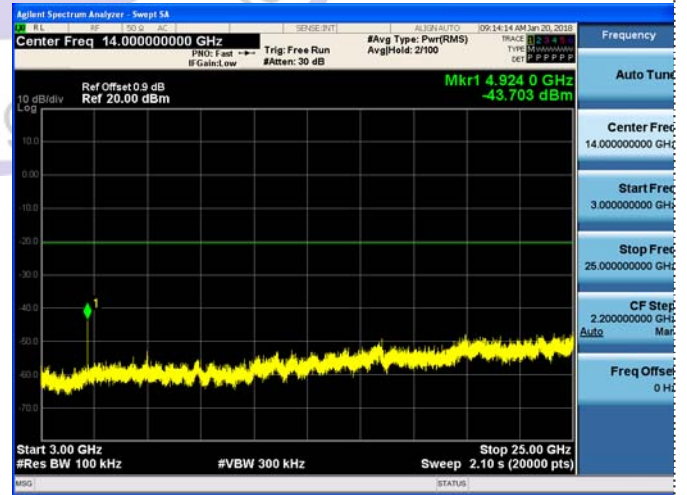
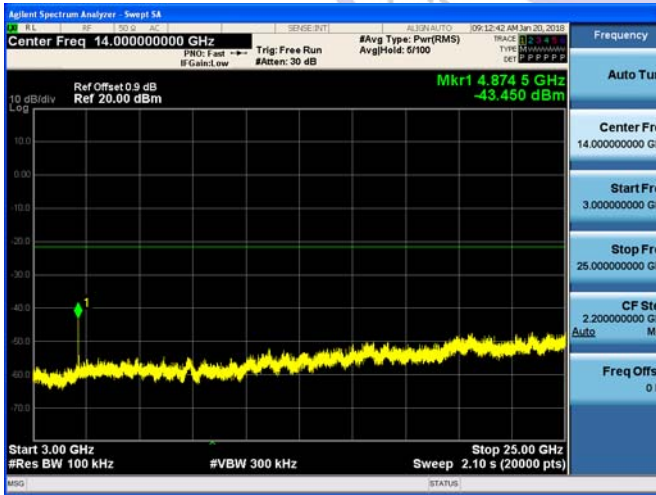

3GHz-25GHz

3GHz-25GHz

802.11n(HT20) CH01

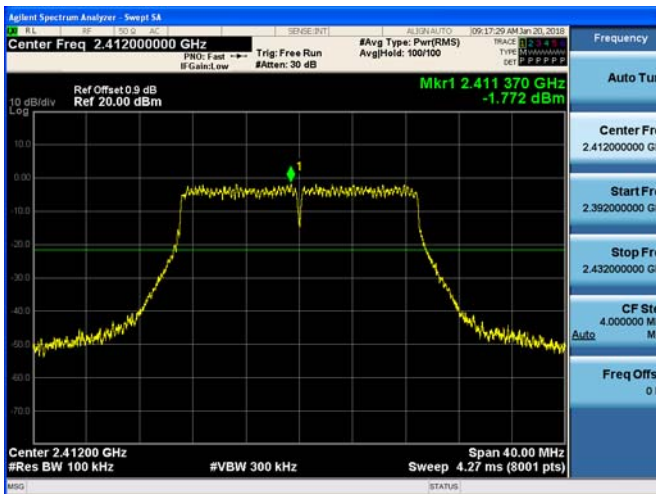

802.11n(HT20) CH06

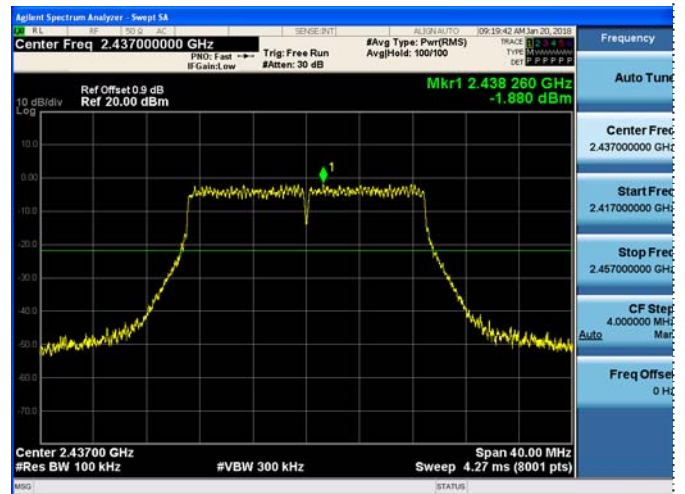

Reference

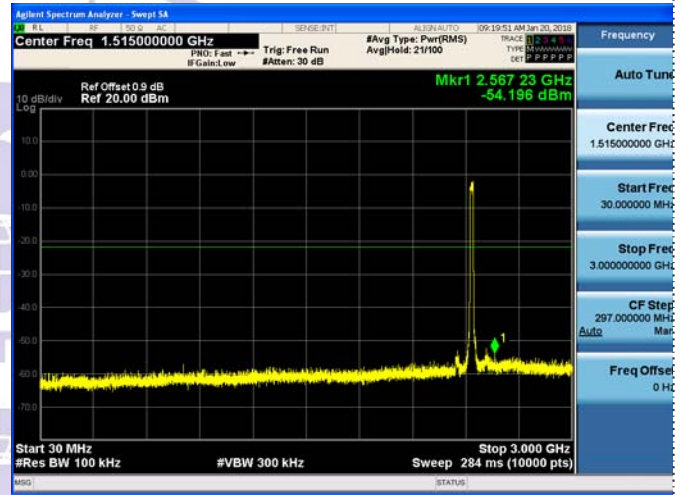
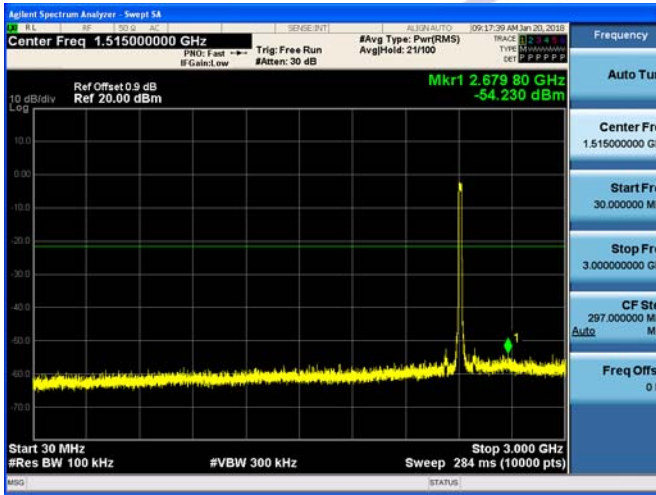

30MHz-3GHz

30MHz-3GHz

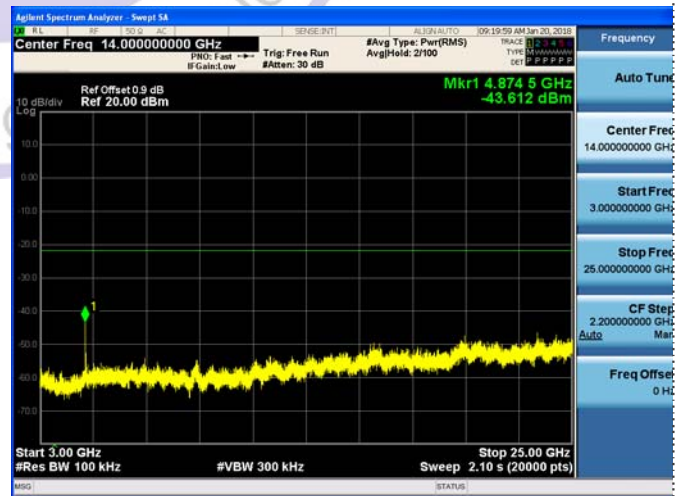
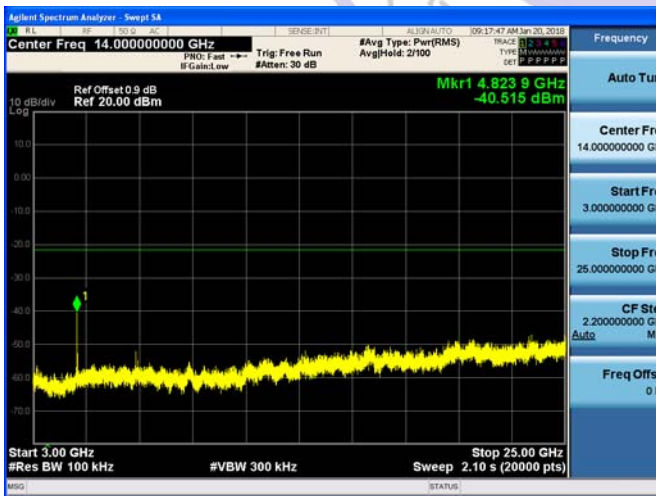

3GHz-25GHz

3GHz-25GHz



802.11n(HT20) CH11

802.11n(HT40) CH03

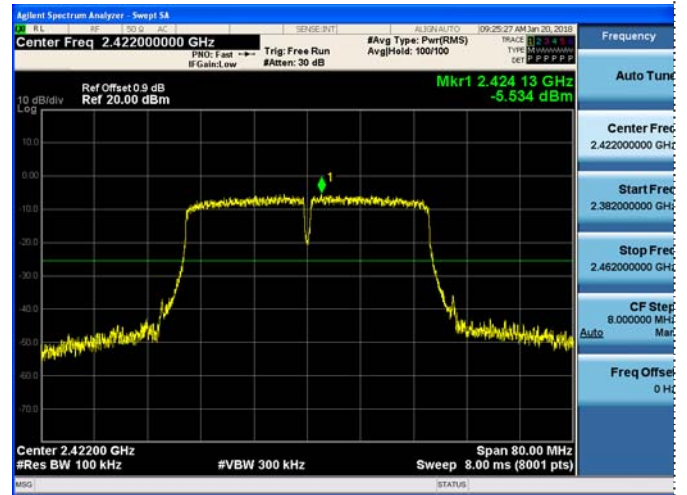
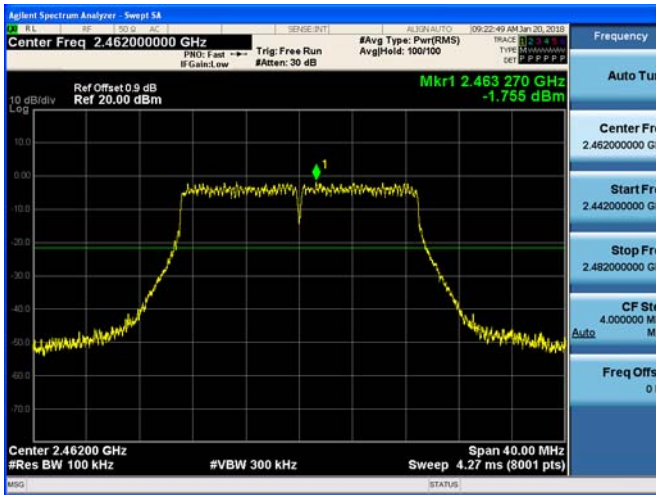

Reference

Reference

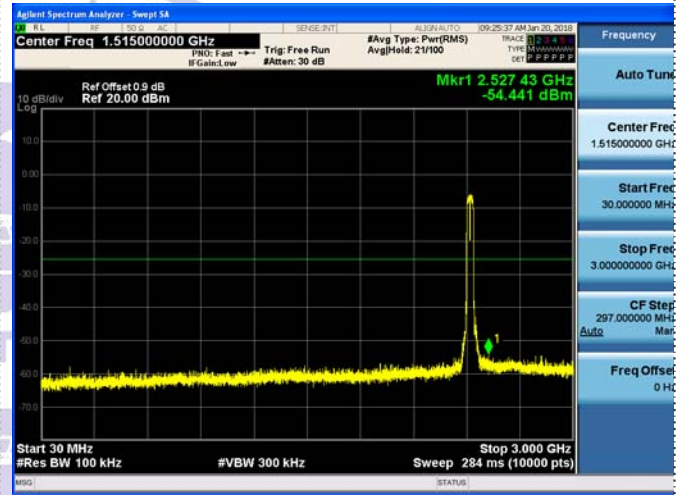
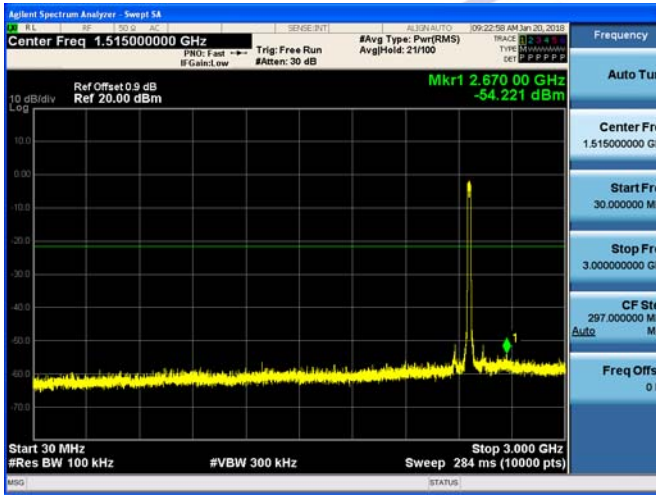

30MHz-3GHz

30MHz-3GHz

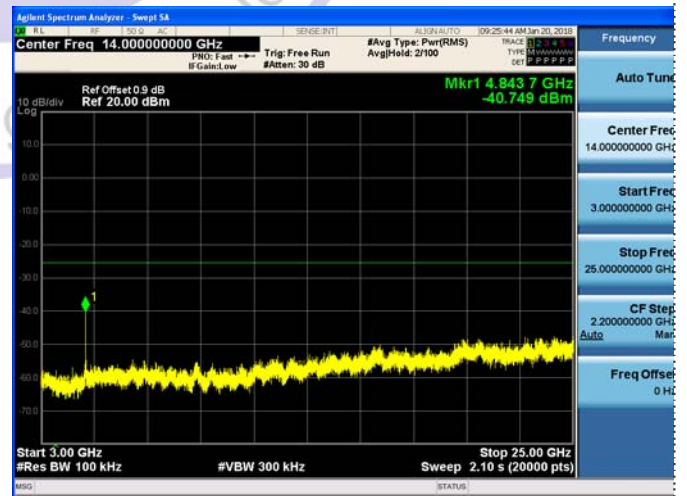
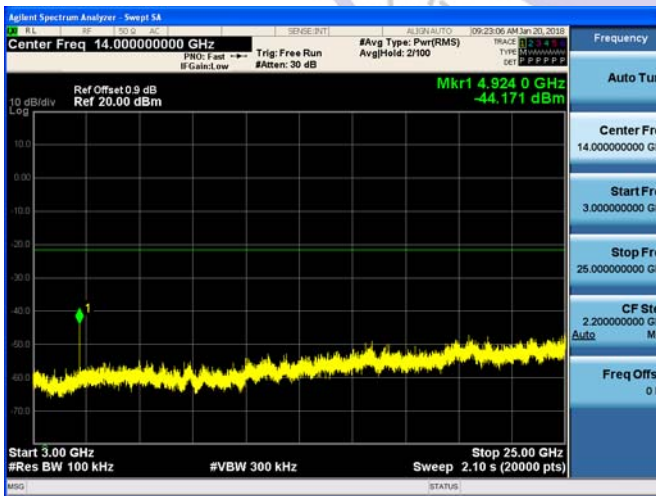

3GHz-25GHz

3GHz-25GHz

802.11n(HT40) CH06

802.11n(HT40) CH09

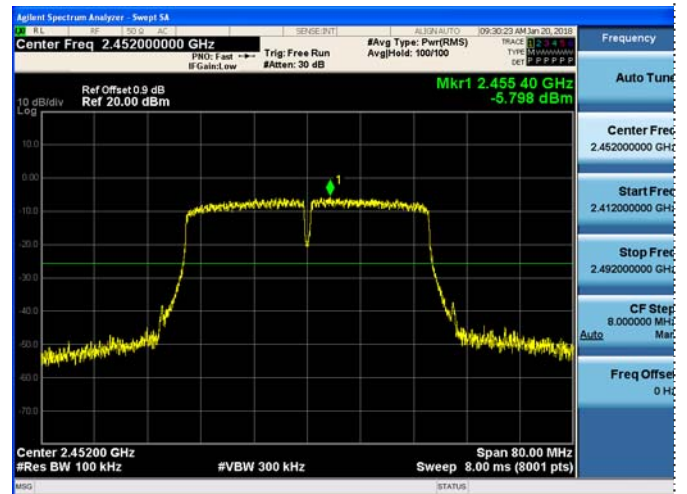
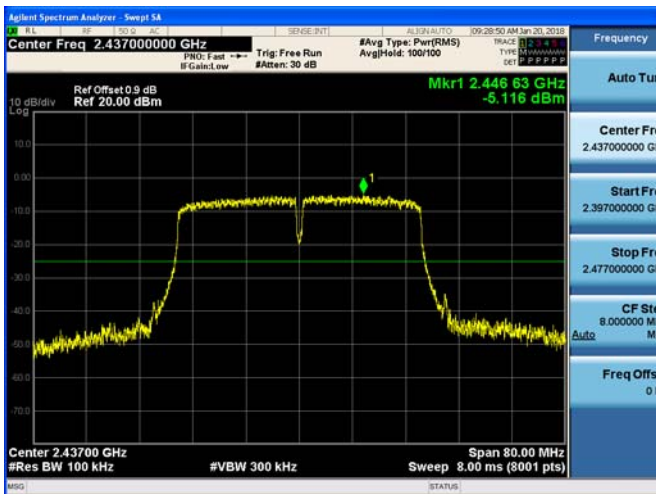

Reference

Reference

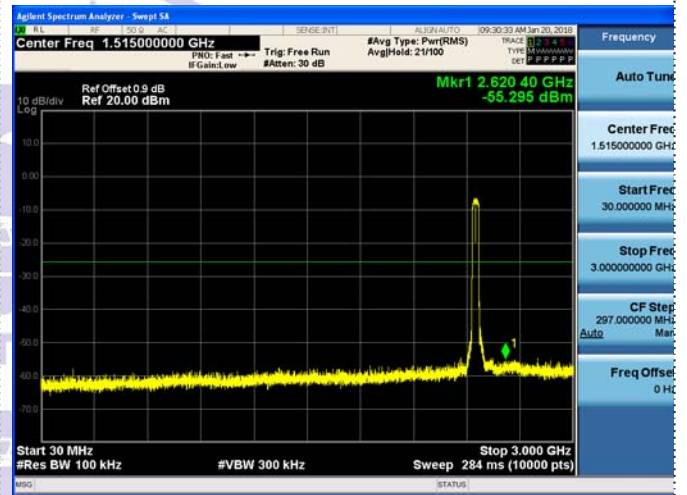
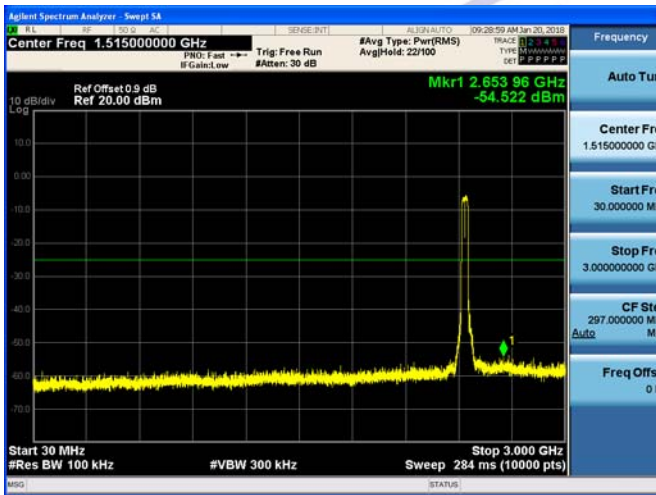

30MHz-3GHz

30MHz-3GHz

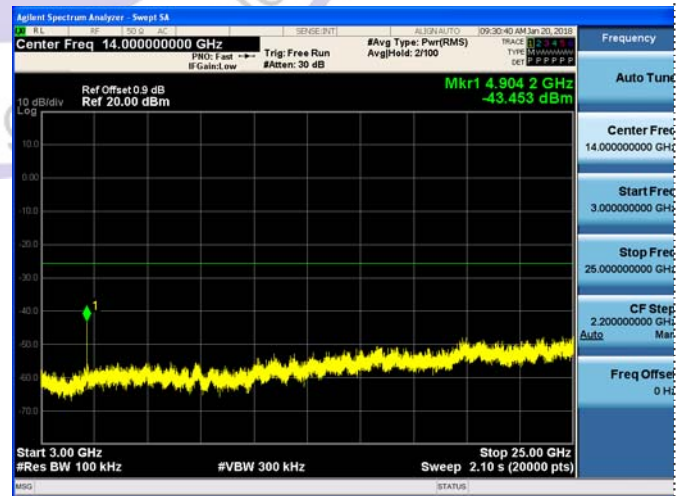
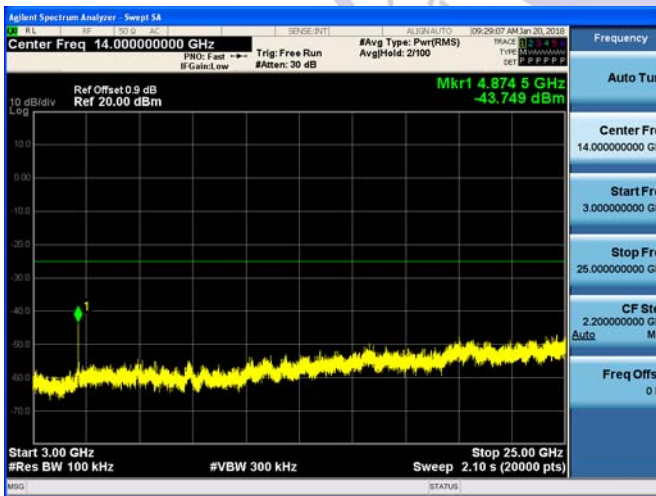

3GHz-25GHz

3GHz-25GHz

**Band-edge Measurements for RF Conducted Emissions:**

**802.11b**



Left bandedge

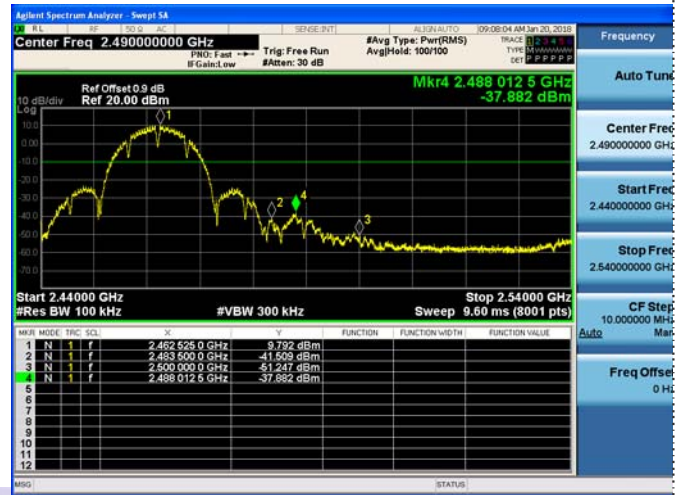

Right bandedge

**802.11g**

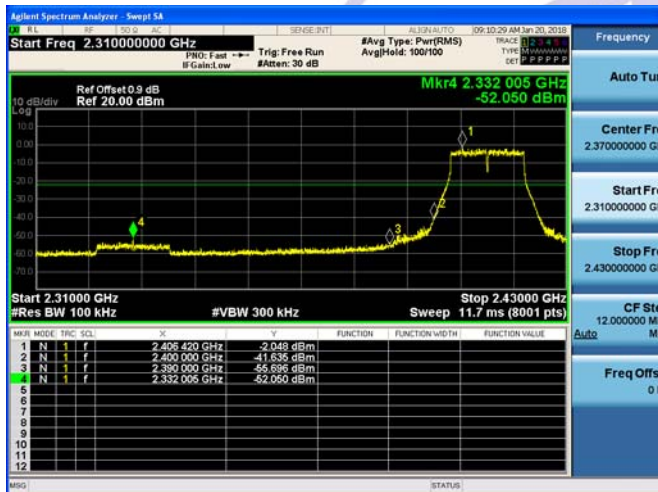

Left bandedge

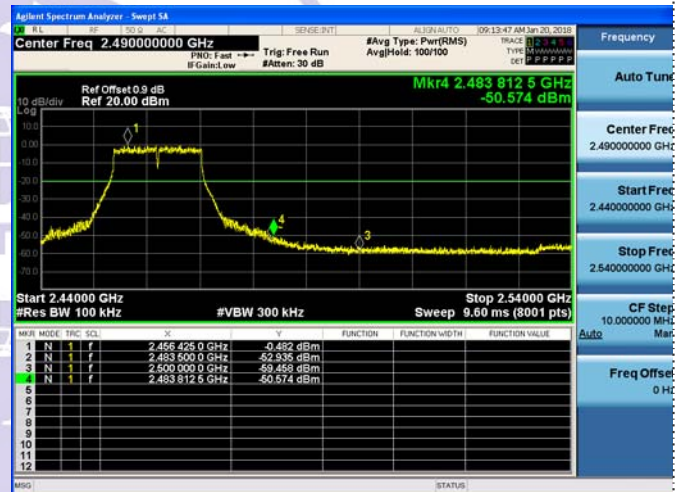

Right bandedge

**802.11n(HT20)**

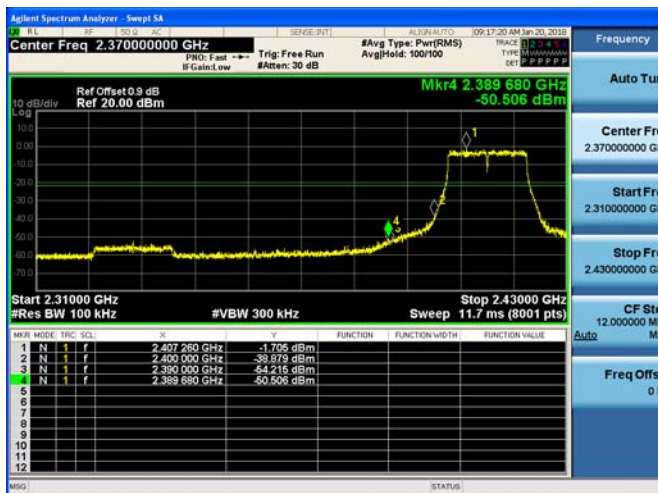

Left bandedge

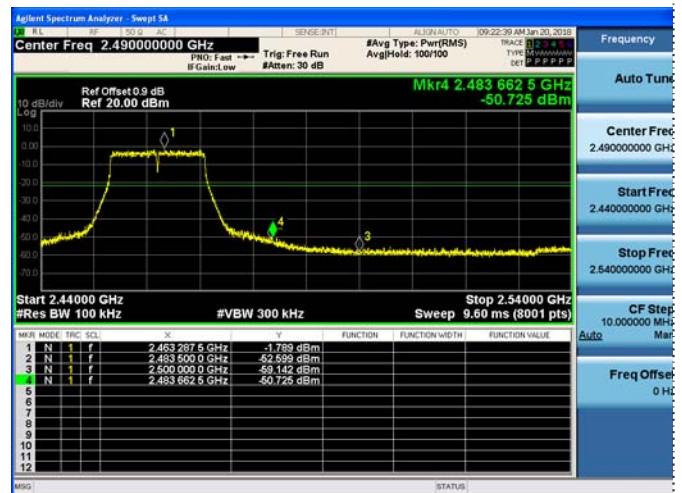

Right bandedge

802.11n(HT40)

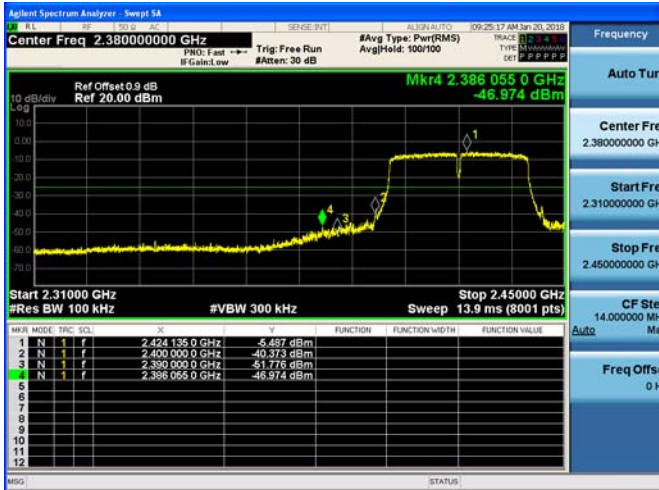

Left bandedge



Right bandedge



### 3.7. Antenna Requirement

#### Standard Applicable

For intentional device, according to FCC 47 CFR Section 15.203:

An intentional radiator shall be designed to ensure that no antenna other than that furnished by the responsible party shall be used with the device. The use of a permanently attached antenna or of an antenna that uses a unique coupling to the intentional radiator, the manufacturer may design the unit so that a broken antenna can be replaced by the user, but the use of a standard antenna jack or electrical connector is prohibited

**FCC CFR Title 47 Part 15 Subpart C Section 15.247(c) (1) (I):**

(i) Systems operating in the 2400-2483.5 MHz band that is used exclusively for fixed. Point-to-point operations may employ transmitting antennas with directional gain greater than 6dBi provided the maximum conducted output power of the intentional radiator is reduced by 1 dB for every 3 dB that the directional gain of the antenna exceeds 6dBi.

#### Test Result:

The maximum gain of antenna was 2dBi.



### 4. Test Setup Photos of the EUT





## 5. Photos of the EUT

### External Photos of EUT











Internal Photos of EUT

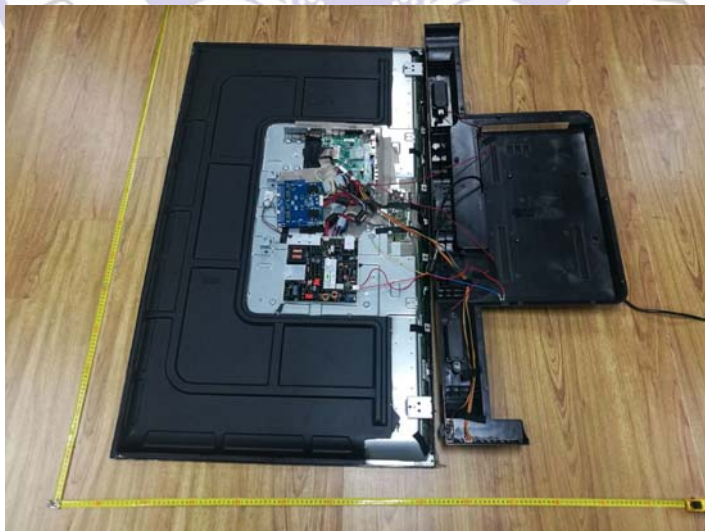

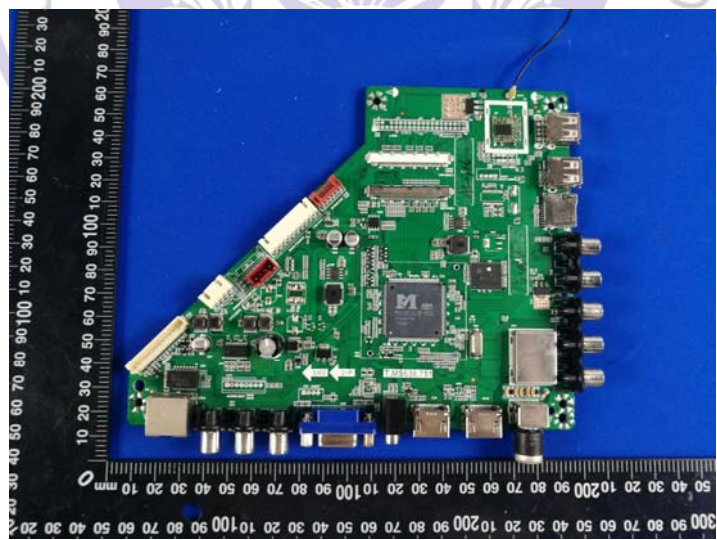
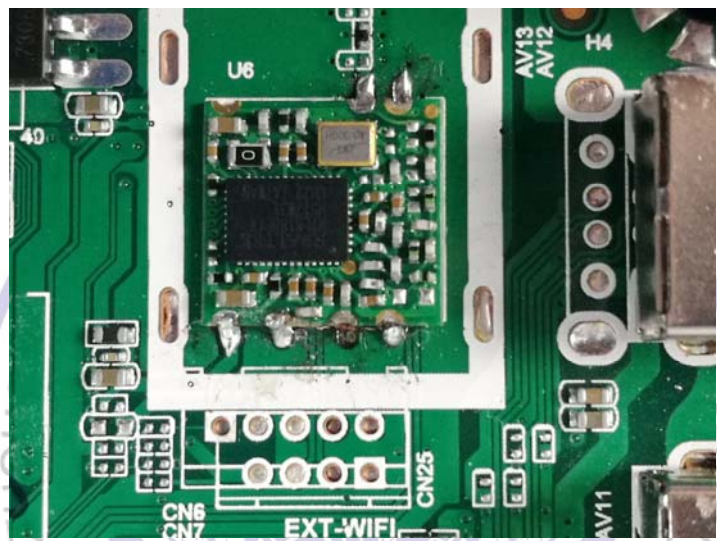
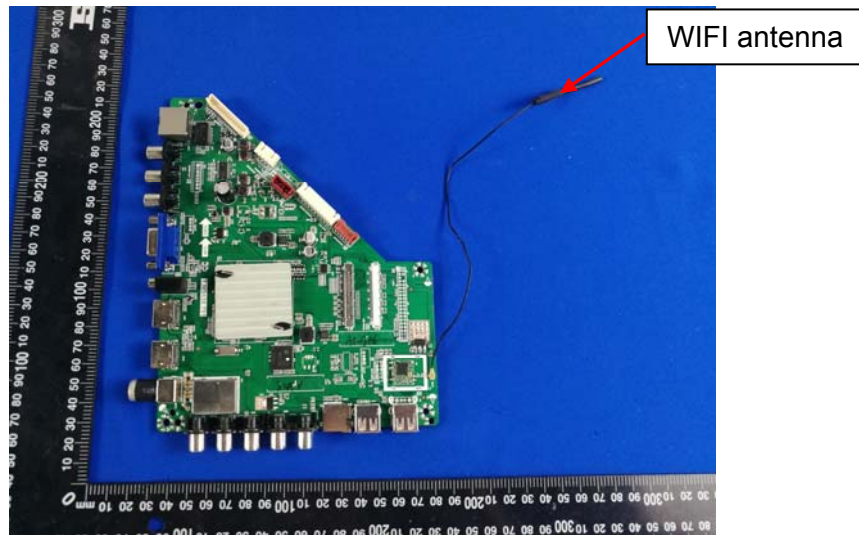

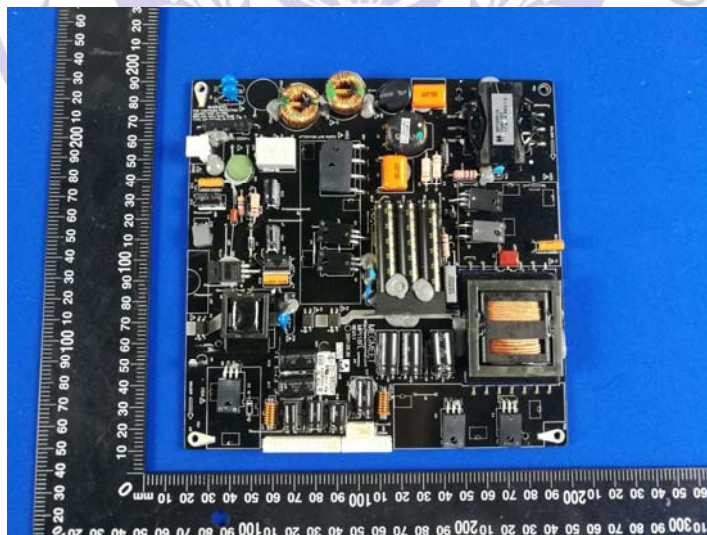

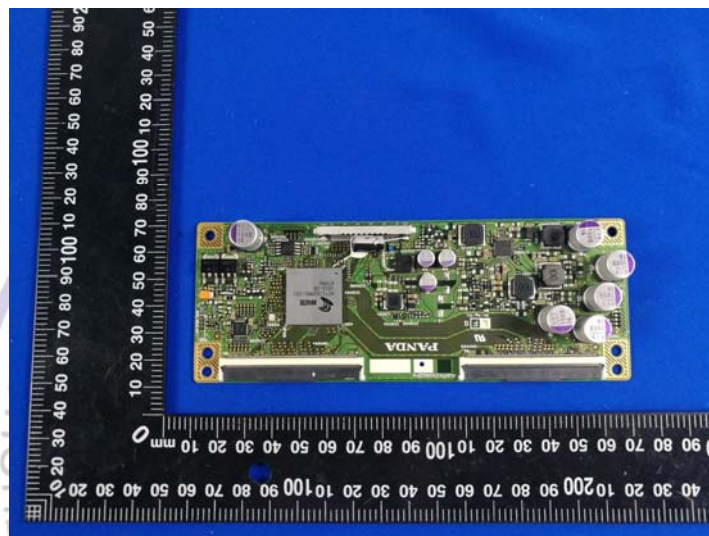
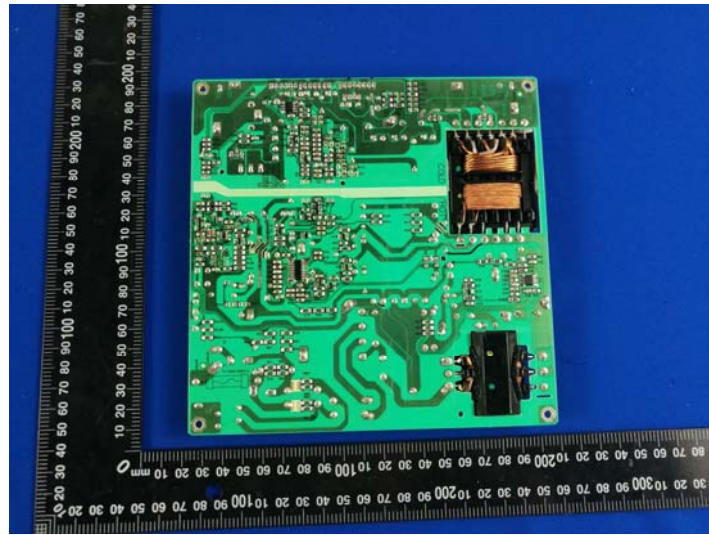

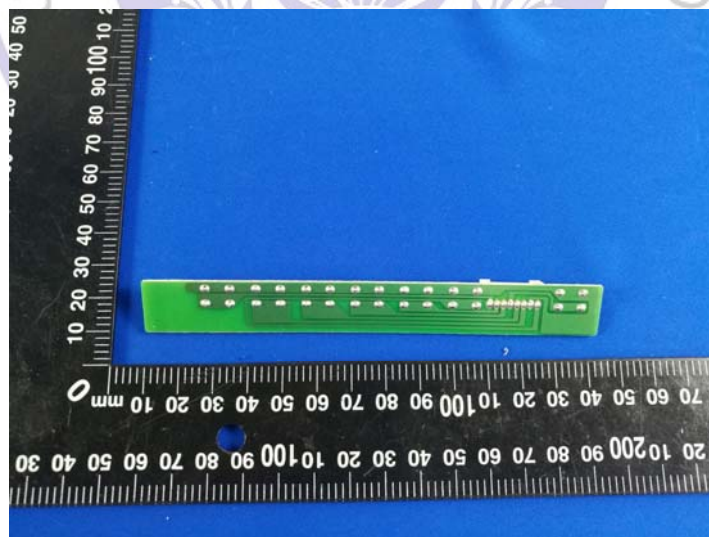
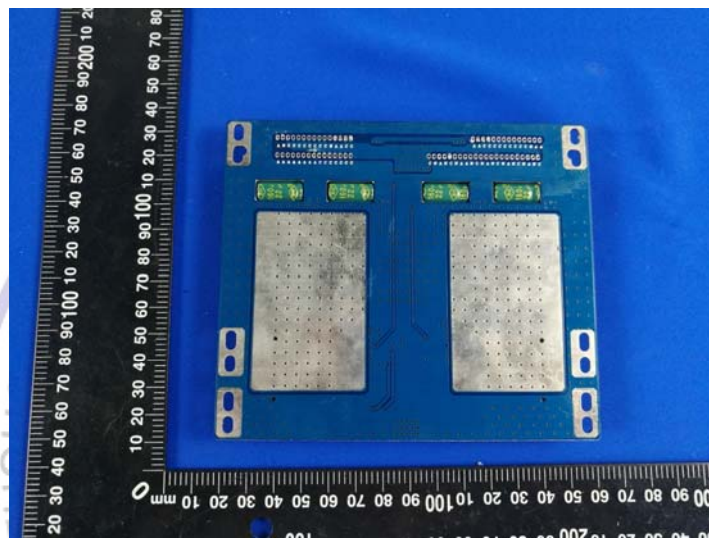
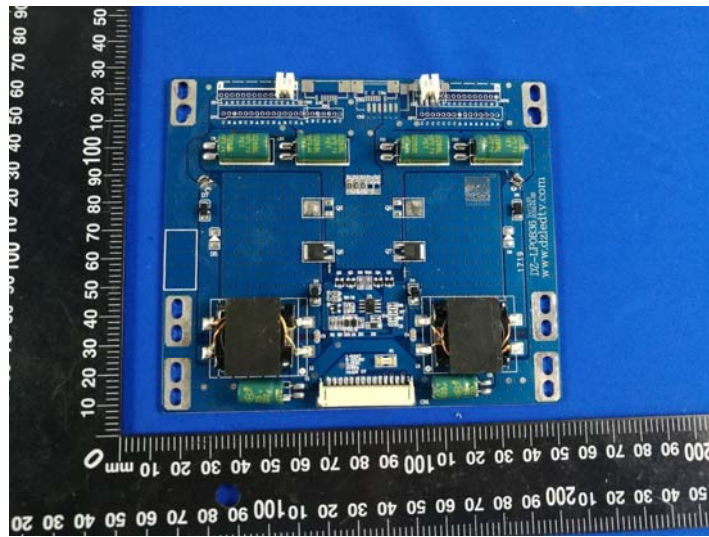



\*\*\*\*\* End of Report \*\*\*\*\*

