

**SAR TEST REPORT**

For

**Panasonic India Pvt Ltd****Smart Phone****Test Model: ELUGA RAY 800****List Model No.: /**

Prepared for : Panasonic India Pvt Ltd  
Address : 12th Floor Ambience Tower, Ambience Island, NH-8,  
Gurgaon, Haryana-122002, India

Prepared by : Shenzhen LCS Compliance Testing Laboratory Ltd.  
Address : 1/F., Xingyuan Industrial Park, Tongda Road, Bao'an  
Avenue, Bao'an District, Shenzhen, Guangdong, China

Tel : (86)755-82591330  
Fax : (86)755-82591332  
Web : www.LCS-cert.com  
Mail : webmaster@LCS-cert.com

Date of receipt of test sample : March 20, 2019  
Number of tested samples : 1  
Serial number : Prototype  
Date of Test : March 20, 2019~April 09, 2019  
Date of Report : April 16, 2019

**SAR TEST REPORT****Report Reference No. .... : LCS190305123AEB**

Date Of Issue ..... : April 16, 2019

**Testing Laboratory Name ..... : Shenzhen LCS Compliance Testing Laboratory Ltd.**Address ..... : 1/F., Xingyuan Industrial Park, Tongda Road, Bao'an Avenue,  
Bao'an District, Shenzhen, Guangdong, ChinaTesting Location/ Procedure ..... : Full application of Harmonised standards   
Partial application of Harmonised standards   
Other standard testing method **Applicant's Name..... : Panasonic India Pvt Ltd**Address ..... : 12th Floor Ambience Tower, Ambience Island, NH-8, Gurgaon,  
Haryana-122002, India**Test Specification:**

Standard ..... : IEEE Std C95.1, 2005&amp; IEEE Std 1528™-2013&amp;FCC Part 2.1093

Test Report Form No. .... : LCSEMC-1.0

TRF Originator ..... : Shenzhen LCS Compliance Testing Laboratory Ltd.

Master TRF ..... : Dated 2014-09

**Shenzhen LCS Compliance Testing Laboratory Ltd. All rights reserved.**

This publication may be reproduced in whole or in part for non-commercial purposes as long as the Shenzhen LCS Compliance Testing Laboratory Ltd. is acknowledged as copyright owner and source of the material. Shenzhen LCS Compliance Testing Laboratory Ltd. takes no responsibility for and will not assume liability for damages resulting from the reader's interpretation of the reproduced material due to its placement and context.

**Test Item Description. .... : Smart Phone**

Trade Mark ..... : Panasonic

Model/Type Reference ..... : ELUGA RAY 800

Operation Frequency ..... : GSM 850/PCS1900, LTE Band5  
WLAN2.4G, Bluetooth4.0

Modulation Type ..... : Refer to page 7

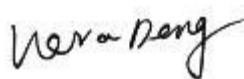
Ratings ..... : DC 3.85V by Rechargeable Li-polymer Battery(4000mAh)  
Recharged by DC 5V Adapter**Result ..... : Positive****Compiled by:**

Vera Deng/ File administrators

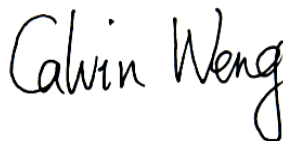
**Supervised by:**

Calvin Weng/ Technique principal

**Approved by:**

Gavin Liang/ Manager

**SAR -- TEST REPORT****Test Report No. : LCS190305123AEB**April 16, 2019  
Date of issue

Test Model..... : ELUGA RAY 800

EUT..... : Smart Phone

**Applicant..... : Panasonic India Pvt Ltd**Address..... : 12th Floor Ambience Tower, Ambience Island, NH-8,  
Gurgaon, Haryana-122002, India

Telephone..... : +91-124-4751300

Fax ..... : +91-124-4751333

**Manufacturer..... : Panasonic India Pvt Ltd**Address..... : 12th Floor Ambience Tower, Ambience Island, NH-8,  
Gurgaon, Haryana-122002, India

Telephone..... : +91-124-4751300

Fax ..... : +91-124-4751333

**Factory 1..... : KONKA SMART TECHNOLOGY CO., LTD.**1#-327 Enterprise Service Centre, No.17 Third Section of  
North Changjiang Road, Lingang Economic Development  
Zone of Yibin, Sichuan Province, P.R.China**Factory 2..... : PADGET Electronics Private Limited**B 18, Phase II, Noida District Gautam Budh Nagar, U.P.,  
India**Test Result****Positive**

The test report merely corresponds to the test sample.

It is not permitted to copy extracts of these test result without the written permission of the test laboratory.

## Revision History

Revision	Issue Date	Revisions	Revised By
000	April 16, 2019	Initial Issue	Gavin Liang

## TABLE OF CONTENTS

<b>1. TEST STANDARDS AND TEST DESCRIPTION.....</b>	<b>6</b>
1.1. TEST STANDARDS .....	6
1.2. TEST DESCRIPTION.....	6
1.3. GENERAL REMARKS .....	6
1.4. PRODUCT DESCRIPTION .....	6
1.5. STATEMENT OF COMPLIANCE .....	8
<b>2. TEST ENVIRONMENT .....</b>	<b>9</b>
2.1. TEST FACILITY.....	9
2.2. ENVIRONMENTAL CONDITIONS .....	9
2.3. SAR LIMITS .....	9
2.4. EQUIPMENTS USED DURING THE TEST .....	10
<b>3. SAR MEASUREMENTS SYSTEM CONFIGURATION .....</b>	<b>11</b>
3.1. SAR MEASUREMENT SET-UP.....	11
3.2. OPENSAR E-FIELD PROBE SYSTEM.....	12
3.3. PHANTOMS.....	13
3.4. DEVICE HOLDER .....	13
3.5. SCANNING PROCEDURE .....	14
3.6. DATA STORAGE AND EVALUATION.....	15
3.7. POSITION OF THE WIRELESS DEVICE IN RELATION TO THE PHANTOM.....	16
3.8. TISSUE DIELECTRIC PARAMETERS FOR HEAD AND BODY PHANTOMS .....	18
3.9. TISSUE EQUIVALENT LIQUID PROPERTIES .....	18
3.10. SYSTEM CHECK .....	19
3.11. SAR MEASUREMENT PROCEDURE .....	20
3.12. POWER REDUCTION .....	24
3.13. POWER DRIFT .....	24
<b>4. TEST CONDITIONS AND RESULTS.....</b>	<b>25</b>
4.1. CONDUCTED POWER RESULTS .....	25
TRANSMIT ANTENNAS AND SAR MEASUREMENT POSITION .....	32
4.2. SAR MEASUREMENT RESULTS .....	33
4.3. SIMULTANEOUS TX SAR CONSIDERATIONS .....	35
4.4. SAR MEASUREMENT VARIABILITY .....	37
4.5. GENERAL DESCRIPTION OF TEST PROCEDURES .....	38
4.6. MEASUREMENT UNCERTAINTY (450MHZ-6GHZ).....	39
4.7. SYSTEM CHECK RESULTS .....	40
4.10 SAR TEST GRAPH RESULTS .....	46
<b>5. CALIBRATION CERTIFICATES.....</b>	<b>54</b>
5.1 PROBE-EPGO324 CALIBRATION CERTIFICATE.....	54
5.2 SID835DIPOLE CALIBRATION CERITICATE.....	64
5.3 SID1900 DIPOLE CALIBRATION CERTIFICATE .....	75
5.4 SID2450 DIPOLE CALIBRATION CERITICATE.....	86
<b>6. EUT TEST PHOTOGRAPHS .....</b>	<b>97</b>
6.1 PHOTOGRAPH OF LIQUID DEPTH.....	97
6.2 PHOTOGRAPH OF THE TEST .....	103
<b>7. EUT PHOTOGRAPHS .....</b>	<b>108</b>

# 1. TEST STANDARDS AND TEST DESCRIPTION

## 1.1. Test Standards

[IEEE Std C95.1, 2005](#): IEEE Standard for Safety Levels with Respect to Human Exposure to Radio Frequency Electromagnetic Fields, 3 KHz to 300 GHz. It specifies the maximum exposure limit of 1.6 W/kg as averaged over any 1 gram of tissue for portable devices being used within 20 cm of the user in the uncontrolled environment.

[IEEE Std 1528™-2013](#): IEEE Recommended Practice for Determining the Peak Spatial-Average Specific Absorption Rate (SAR) in the Human Head from Wireless Communications Devices: Measurement Techniques.

[FCC Part 2.1093](#): Radiofrequency Radiation Exposure Evaluation: Portable Devices

[KDB447498 D01 General RF Exposure Guidance v06](#) : RF Exposure Procedures And Equipment Authorization Policies For Mobile And Portable Devices

[KDB648474 D04 Handset SAR v01r03](#): SAR Evaluation Considerations for Wireless Handsets

[KDB865664 D01](#): SAR Measurement Requirements for 100 MHz to 6 GHz

[KDB865664 D02 RF Exposure Reporting v01r02](#) : RF Exposure Compliance Reporting and Documentation Considerations

[KDB248227 D01 802.11 Wi-Fi SAR v02r02](#): SAR Guidance For IEEE 802.11 (Wi-Fi) Transmitters

[KDB 941225 D06 Hotspot Mode v02r01](#) : SAR Evaluation Procedures For Portable Devices With Wireless Router Capabilities

[KDB 941225 D05A LTE Rel.10 KDB Inquiry Sheet v01r02](#) : REL. 10 LTE SAR Test Guidance And KDB Inquiries

## 1.2. Test Description

The EUT battery must be fully charged and checked periodically during the test to ascertain uniform power . And Test device is identical prototype.

## 1.3. General Remarks

Date of receipt of test sample	:	March 20, 2019
Testing commenced on	:	March 20, 2019
Testing concluded on	:	April 09, 2019

## 1.4. Product Description

The **Panasonic India Pvt Ltd** 's Model: **ELUGA RAY 800** or the "EUT" as referred to in this report; more general information as follows, for more details, refer to the user's manual of the EUT.

General Description	
Product Name:	Smart Phone
Test Model:	ELUGA RAY 800
List Model No.:	/
Modulation Type:	GMSK for GSM/GPRS, 8-PSK for EDGE; QPSK for UMTS; QPSK, 16QAM for LTE
Device category:	Portable Device
Exposure category:	General population/uncontrolled environment
EUT Type:	Production Unit
Hardware Version:	V2.2
Software Version:	EB-90S55ER8v1022
Power supply:	DC 3.85V by Rechargeable Li-polymer Battery(4000mAh) Recharged by DC 5V Adapter
Hotspot:	Supported, power not reduced when Hotspot open
VoIP	Supported
<i>The EUT is GSM, WCDMA, LTE, mobile phone. the mobile phone is intended for speech and Multimedia Message Service (MMS) transmission. It is equipped with GPRS class 12 for GSM850, PCS1900, LTE Band5, and Bluetooth, WiFi2.4G camera functions. For more information see the following datasheet</i>	
Technical Characteristics	
GSM	
Support Networks	GSM, GPRS, EDGE
Support Band	GSM850/DCS1800/GSM900/PCS1900/EGPRS850/EGPRS1900
Frequency	GSM850: 824.2~848.8MHz GSM1900: 1850.2~1909.8MHz

Power Class:	GSM850:Power Class 4 PCS1900:Power Class 1
GSM Release Version:	R99
GPRS Multislot Class:	12
EGPRS Multislot Class:	12
DTM Mode:	Not Supported
Antenna Gain:	-0.89dBi (max.) For GSM 850; -0.75dBi (max.) For GSM 900; 0.72dBi (max.) For DCS 1800; 0.65dBi (max.) For PCS 1900;
Antenna Type:	PIFA Antenna
<b>WCDMA</b>	
UMTS Operation Frequency Band:	UMTS FDD Band I/VIII
WCDMA Release Version:	R8
HSDPA Release Version:	Release 8
HSUPA Release Version:	Release 6
DC-HSUPA Release Version:	Not Supported
Antenna Gain:	0.68dBi for WCDMA Band I; -0.75dBi for WCDMA Band VIII;
Antenna Type:	PIFA Antenna
<b>LTE</b>	
Support Band	LTE Band1, 3, 5, 8
Power Class:	Class 3
Modulation Type:	QPSK/16QAM
LTE Release Version:	R9
Antenna Gain:	0.68dBi for LTE Band 1; 0.72dBi for LTE Band 3; -0.89dBi for LTE Band 5; -0.75dBi for LTE Band 8
Antenna Type:	PIFA Antenna
<b>WIFI 2.4G</b>	
Supported Standards:	IEEE 802.11b/802.11g/802.11n(HT20 and HT40)
Operation frequency:	2412-2462MHz for 11b/g/n(HT20) 2422-2452MHz for 11n(HT40)
WLAN FCC Modulation Type :	IEEE 802.11b: DSSS(CCK,DQPSK,DBPSK) IEEE 802.11g/n: OFDM(64QAM, 16QAM, QPSK, BPSK)
Channel separation:	5MHz
Antenna Description	PIFA Antenna; -0.28dBi (max.) For WLAN
<b>Bluetooth</b>	
Bluetooth Version:	V4.0
Modulation:	GFSK, $\pi/4$ -DQPSK, 8-DPSK(BT V4.0)
Operation frequency:	2402MHz~2480MHz
Channel number:	40/79
Channel separation:	1MHz/2MHz
Antenna Description	PIFA Antenna;-0.28dBi (max.) For BT

## 1.5. Statement of Compliance

The maximum of results of SAR found during testing for **ELUGA RAY 800** are follows:

### <Highest Reported standalone SAR Summary>

Classment Class	Frequency Band	Head (Report SAR <sub>1-g</sub> (W/kg))	Hotspot (Report SAR <sub>1-g</sub> (W/kg))	Body-worn (Report SAR <sub>1-g</sub> (W/kg))
			(Separation Distance 10mm)	
PCE	GSM 850	0.075	0.177	0.177
	GSM1900	0.190	0.349	0.349
	LTE Band 5	0.073	0.212	0.212
DTS	WIFI2.4G	0.437	0.247	0.247

This device is in compliance with Specific Absorption Rate (SAR) for general population/uncontrolled exposure limits (1.6 W/kg) specified in FCC 47 CFR part 2 (2.1093) and ANSI/IEEE C95.1-2005, and had been tested in accordance with the measurement methods and procedures specified in IEEE 1528-2013.

### <Highest Reported simultaneous SAR Summary>

Exposure Position	Frequency Band	Reported SAR <sub>1-g</sub> (W/kg)	Classment Class	Highest Reported Simultaneous Transmission SAR <sub>1-g</sub> (W/kg)
Head	GSM1900	0.190	PCE	<b>0.627</b>
	WIFI2.4G	0.437	DTS	



## 2. TEST ENVIRONMENT

### 2.1. Test Facility

The test facility is recognized, certified, or accredited by the following organizations:

Site Description  
EMC Lab. : FCC Registration Number. is 254912  
Industry Canada Registration Number. is 9642A-1.  
ESMD Registration Number. is ARCB0108.  
UL Registration Number. is 100571-492.  
TUV SUD Registration Number. is SCN1081.  
TUV RH Registration Number. is UA 50296516-001  
NVLAP Registration Code is 600167-0.

### 2.2. Environmental conditions

During the measurement the environmental conditions were within the listed ranges:

Temperature:	18-25 ° C
Humidity:	40-65 %
Atmospheric pressure:	950-1050mbar

### 2.3. SAR Limits

EXPOSURE LIMITS	FCC Limit (1g Tissue)	
	SAR (W/kg)	
	(General Population / Uncontrolled Exposure Environment)	(Occupational / Controlled Exposure Environment)
Spatial Average(averaged over the whole body)	0.08	0.4
Spatial Peak(averaged over any 1 g of tissue)	1.6	8.0
Spatial Peak(hands/wrists/ feet/anklesaveraged over 10 g)	4.0	20.0

Population/Uncontrolled Environments are defined as locations where there is the exposure of individual who have no knowledge or control of their exposure.

Occupational/Controlled Environments are defined as locations where there is exposure that may be incurred by people who are aware of the potential for exposure (i.e. as a result of employment or occupation).

## 2.4. Equipments Used during the Test

Test Equipment	Manufacturer	Type/Model	Serial Number	Calibration	
				Calibration Date	Calibration Due
PC	Lenovo	G5005	MY42081102	N/A	N/A
SAR Measurement system	SATIMO	4014_01	SAR_4014_01	N/A	N/A
Signal Generator	Agilent	E4438C	MY42081396	06/16/2018	06/15/2019
Multimeter	Keithley	MiltiMeter 2000	4059164	06/16/2018	06/15/2019
S-parameter Network Analyzer	Agilent	8753ES	US38432944	11/15/2018	11/14/2019
Wideband Radia Communication Tester	R&S	CMW500	1201.0002K50	11/15/2018	11/14/2019
E-Field PROBE	SATIMO	SSE2	SN 31/17 EPO324	10/08/2018	10/07/2019
DIPOLE 835	SATIMO	SID 835	SN 07/14 DIP 0G835-303	10/01/2018	09/30/2021
DIPOLE 1900	SATIMO	SID 1900	SN 38/18 DIP 1G900-466	09/24/2018	09/23/2021
DIPOLE 2450	SATIMO	SID 2450	SN 07/14 DIP 2G450-306	10/01/2018	09/30/2021
Power meter	Agilent	E4419B	MY45104493	06/16/2018	06/15/2019
Power meter	Agilent	E4418B	GB4331256	06/16/2018	06/15/2019
Power sensor	Agilent	E9301H	MY41497725	06/16/2018	06/15/2019
Power sensor	Agilent	E9301H	MY41495234	06/16/2018	06/15/2019
Directional Coupler	MCLI/USA	4426-20	0D2L51502	06/16/2018	06/15/2019
EUT POSITIONING DEVICE	SATIMO	MSH98	SN 40/14 MSH98	N/A	N/A
SAM PHANTOM	SATIMO	SAM117	SN 40/14 SAM117	N/A	N/A
COMOSAR OPEN Coaxial Probe	SATIMO	OCPG 68	SN 40/14 OCPG68	N/A	N/A
Liquid measurement Kit	HP	85033D	3423A03482	N/A	N/A

### Note:

- 1) Per KDB865664D01 requirements for dipole calibration, the test laboratory has adopted three year extended calibration interval. Each measured dipole is expected to evaluate with following criteria at least on annual interval.
  - a) There is no physical damage on the dipole;
  - b) System check with specific dipole is within 10% of calibrated values;
  - c) The most recent return-loss results, measured at least annually, deviates by no more than 20% from the previous measurement;
  - d) The most recent measurement of the real or imaginary parts of the impedance, measured at least annually is within 5Ω from the previous measurement.
- 2) Network analyzer probe calibration against air, distilled water and a shorting block performed before measuring liquid parameters.

### 3. SAR MEASUREMENTS SYSTEM CONFIGURATION

#### 3.1. SAR Measurement Set-up

The OPENSAR system for performing compliance tests consist of the following items:

A standard high precision 6-axis robot (KUKA) with controller and software.

KUKA Control Panel (KCP)

A dosimetric probe, i.e., an isotropic E-field probe optimized and calibrated for usage in tissue simulating liquid. The probe is equipped with a Video Positioning System(VPS).

The stress sensor is composed with mechanical and electronic when the electronic part detects a change on the electro-mechanical switch,It sends an "Emergency signal" to the robot controller that to stop robot's moves

A computer operating Windows XP.

OPENSAR software

Remote control with teaches pendant and additional circuitry for robot safety such as warning lamps, etc.

The SAM phantom enabling testing left-hand right-hand and body usage.

The Position device for handheld EUT

Tissue simulating liquid mixed according to the given recipes .

System validation dipoles to validate the proper functioning of the system.

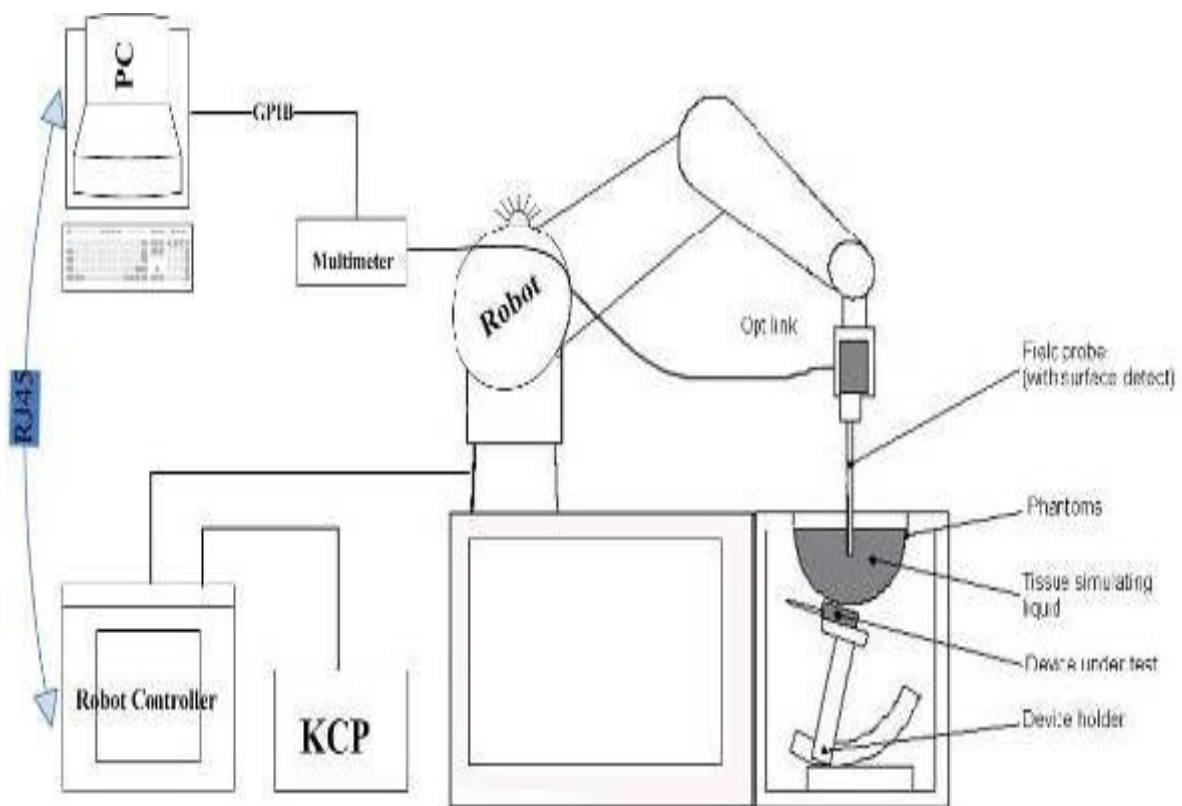

### 3.2. OPENSAR E-field Probe System

The SAR measurements were conducted with the dosimetric probe EPGO324 (manufactured by SATIMO), designed in the classical triangular configuration and optimized for dosimetric evaluation.

#### Probe Specification

Construction Symmetrical design with triangular core  
 Interleaved sensors  
 Built-in shielding against static charges  
 PEEK enclosure material (resistant to organic solvents, e.g., DGBE)

Calibration ISO/IEC 17025 calibration service available.

Frequency	450 MHz to 6 GHz; Linearity: 0.25dB(450 MHz to 6 GHz)
Directivity	0.25 dB in HSL (rotation around probe axis) 0.5 dB in tissue material (rotation normal to probe axis)
Dynamic Range	0.01W/kg to > 100 W/kg; Linearity: 0.25 dB
Dimensions	Overall length: 330 mm (Tip: 16mm) Tip diameter: 5 mm (Body: 8 mm) Distance from probe tip to sensor centers: 2.5 mm
Application	General dosimetry up to 6 GHz Dosimetry in strong gradient fields Compliance tests of Mobile Phones



#### Isotropic E-Field Probe

The isotropic E-Field probe has been fully calibrated and assessed for isotropicity, and boundary effect within a controlled environment. Depending on the frequency for which the probe is calibrated the method utilized for calibration will change.

The E-Field probe utilizes a triangular sensor arrangement as detailed in the diagram below:

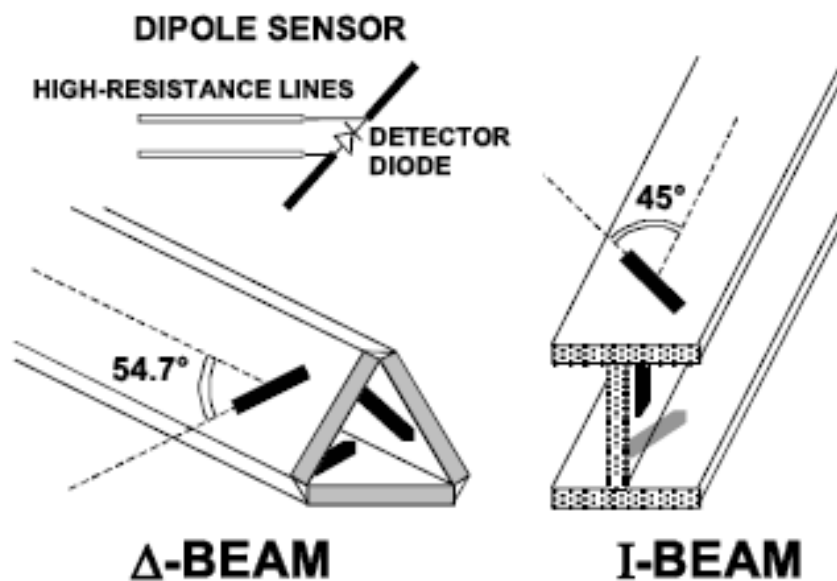

### 3.3. Phantoms

The SAM Phantom SAM117 is constructed of a fiberglass shell integrated in a wooden table. The shape of the shell is in compliance with the specification set in IEEE P1528 and CENELEC EN62209-1, EN62209-2:2010. The phantom enables the dosimetric evaluation of left and right hand phone usage as well as body mounted usage at the flat phantom region. A cover prevents the evaporation of the liquid. Reference markings on the Phantom allow the complete setup of all predefined phantom positions and measurement grids by manually teaching three points in the robot.

System checking was performed using the flat section, whilst Head SAR tests used the left and right head profile sections. Body SAR testing also used the flat section between the head profiles.



SAM Twin Phantom

### 3.4. Device Holder

In combination with the Generic Twin Phantom SAM117, the Mounting Device enables the rotation of the mounted transmitter in spherical coordinates whereby the rotation points is the ear opening. The devices can be easily, accurately, and repeatedly positioned according to the FCC and CENELEC specifications. The device holder can be locked at different phantom locations (left head, right head, flat phantom).



Device holder supplied by SATIMO

### 3.5. Scanning Procedure

The procedure for assessing the peak spatial-average SAR value consists of the following steps

#### Power Reference Measurement

The reference and drift jobs are useful jobs for monitoring the power drift of the device under test in the batch process. Both jobs measure the field at a specified reference position, at a selectable distance from the phantom surface. The reference position can be either the selected section's grid reference point or a user point in this section. The reference job projects the selected point onto the phantom surface, orients the probe perpendicularly to the surface, and approaches the surface using the selected detection method.

#### Area Scan

The Area Scan is used as a fast scan in two dimensions to find the area of high field values before running a detailed measurement around the hot spot. Before starting the area scan a grid spacing of 15 mm x 15 mm is set. During the scan the distance of the probe to the phantom remains unchanged. After finishing area scan, the field maxima within a range of 2 dB will be ascertained.

	≤ 3 GHz	> 3 GHz
Maximum distance from closest measurement point (geometric center of probe sensors) to phantom surface	5 mm ± 1 mm	$\frac{1}{2} \cdot \delta \cdot \ln(2)$ mm ± 0.5 mm
Maximum probe angle from probe axis to phantom surface normal at the measurement location	30° ± 1°	20° ± 1°
Maximum area scan spatial resolution: $\Delta x_{Area}$ , $\Delta y_{Area}$	≤ 2 GHz: ≤ 15 mm 2 – 3 GHz: ≤ 12 mm	3 – 4 GHz: ≤ 12 mm 4 – 6 GHz: ≤ 10 mm
	When the x or y dimension of the test device, in the measurement plane orientation, is smaller than the above, the measurement resolution must be ≤ the corresponding x or y dimension of the test device with at least one measurement point on the test device.	

#### Zoom Scan

Zoom Scans are used to estimate the peak spatial SAR values within a cubic averaging volume containing 1 g and 10 g of simulated tissue. The default Zoom Scan is done by 7x7x7 points within a cube whose base is centered around the maxima found in the preceding area scan.

Maximum zoom scan spatial resolution: $\Delta x_{Zoom}$ , $\Delta y_{Zoom}$		≤ 2 GHz: ≤ 8 mm 2 – 3 GHz: ≤ 5 mm*	3 – 4 GHz: ≤ 5 mm* 4 – 6 GHz: ≤ 4 mm*	
Maximum zoom scan spatial resolution, normal to phantom surface	uniform grid: $\Delta z_{Zoom}(n)$	≤ 5 mm	3 – 4 GHz: ≤ 4 mm 4 – 5 GHz: ≤ 3 mm 5 – 6 GHz: ≤ 2 mm	
	graded grid	$\Delta z_{Zoom}(1)$ : between 1 <sup>st</sup> two points closest to phantom surface	≤ 4 mm	3 – 4 GHz: ≤ 3 mm 4 – 5 GHz: ≤ 2.5 mm 5 – 6 GHz: ≤ 2 mm
		$\Delta z_{Zoom}(n>1)$ : between subsequent points	≤ 1.5 · $\Delta z_{Zoom}(n-1)$ mm	
Minimum zoom scan volume	x, y, z	≥ 30 mm	3 – 4 GHz: ≥ 28 mm 4 – 5 GHz: ≥ 25 mm 5 – 6 GHz: ≥ 22 mm	
Note: $\delta$ is the penetration depth of a plane-wave at normal incidence to the tissue medium; see IEEE Std 1528-2013 for details.				
* When zoom scan is required and the <i>reported</i> SAR from the <i>area scan based 1-g SAR estimation</i> procedures of KDB Publication 447498 is ≤ 1.4 W/kg, ≤ 8 mm, ≤ 7 mm and ≤ 5 mm zoom scan resolution may be applied, respectively, for 2 GHz to 3 GHz, 3 GHz to 4 GHz and 4 GHz to 6 GHz.				



### Power Drift measurement

The drift job measures the field at the same location as the most recent reference job within the same procedure, and with the same settings. The drift measurement gives the field difference in dB from the reading conducted within the last reference measurement. Several drift measurements are possible for one reference measurement. This allows a user to monitor the power drift of the device under test within a batch process. In the properties of the Drift job, the user can specify a limit for the drift and have OPENSAR software stop the measurements if this limit is exceeded.

## 3.6. Data Storage and Evaluation

### Data Storage

The OPENSAR software stores the acquired data from the data acquisition electronics as raw data (in microvolt readings from the probe sensors), together with all necessary software parameters for the data evaluation (probe calibration data, liquid parameters and device frequency and modulation data) in measurement files. The software evaluates the desired unit and format for output each time the data is visualized or exported. This allows verification of the complete software setup even after the measurement and allows correction of incorrect parameter settings. For example, if a measurement has been performed with a wrong crest factor parameter in the device setup, the parameter can be corrected afterwards and the data can be re-evaluated.

The measured data can be visualized or exported in different units or formats, depending on the selected probe type ([V/m], [A/m], [°C], [mW/g], [mW/cm<sup>2</sup>], [dBrel], etc.). Some of these units are not available in certain situations or show meaningless results, e.g., a SAR output in a lossless media will always be zero. Raw data can also be exported to perform the evaluation with other software packages.

### Data Evaluation

The OPENSAR software automatically executes the following procedures to calculate the field units from the microvolt readings at the probe connector. The parameters used in the evaluation are stored in the configuration modules of the software:

Probe parameters:	- Sensitivity	Normi, ai0, ai1, ai2
	- Conversion factor	ConvFi
	- Diode compression point	Dcpi
Device parameters:	- Frequency	f
	- Crest factor	cf
Media parameters:	- Conductivity	σ
	- Density	ρ

These parameters must be set correctly in the software. They can be found in the component documents or they can be imported into the software from the configuration files issued for the OPENSAR components. In the direct measuring mode of the multimeter option, the parameters of the actual system setup are used. In the scan visualization and export modes, the parameters stored in the corresponding document files are used.

The first step of the evaluation is a linearization of the filtered input signal to account for the compression characteristics of the detector diode. The compensation depends on the input signal, the diode type and the DC-transmission factor from the diode to the evaluation electronics. If the exciting field is pulsed, the crest factor of the signal must be known to correctly compensate for peak power. The formula for each channel can be given as:

$$V_i = U_i + U_i^2 \cdot \frac{cf}{dcp_i}$$

With  $V_i$  = compensated signal of channel  $i$  ( $i = x, y, z$ )

$U_i$  = input signal of channel  $i$  ( $i = x, y, z$ )

cf = crest factor of exciting field

dcp<sub>i</sub> = diode compression point

From the compensated input signals the primary field data for each channel can be evaluated:

$$E - \text{fieldprobes} : E_i = \sqrt{\frac{V_i}{Norm_i \cdot ConvF}}$$

$$H - \text{fieldprobes} : H_i = \sqrt{V_i} \cdot \frac{a_{i0} + a_{i1}f + a_{i2}f^2}{f}$$

With  $V_i$  = compensated signal of channel  $i$  ( $i = x, y, z$ )

$Norm_i$  = sensor sensitivity of channel  $i$  ( $i = x, y, z$ )  
[mV/(V/m)<sup>2</sup>] for E-field Probes

ConvF = sensitivity enhancement in solution

- aij = sensor sensitivity factors for H-field probes
- f = carrier frequency [GHz]
- Ei = electric field strength of channel i in V/m
- Hi = magnetic field strength of channel i in A/m

The RSS value of the field components gives the total field strength (Hermitian magnitude):

$$E_{tot} = \sqrt{E_x^2 + E_y^2 + E_z^2}$$

The primary field data are used to calculate the derived field units.

$$SAR = E_{tot}^2 \cdot \frac{\sigma}{\rho \cdot 1'000}$$

- with SAR = local specific absorption rate in mW/g
- Etot = total field strength in V/m
- σ = conductivity in [mho/m] or [Siemens/m]
- ρ = equivalent tissue density in g/cm3

Note that the density is normally set to 1 (or 1.06), to account for actual brain density rather than the density of the simulation liquid.

### 3.7. Position of the wireless device in relation to the phantom

#### General considerations

This standard specifies two handset test positions against the head phantom – the “cheek” position and the “tilt” position.

The power flow density is calculated assuming the excitation field as a free space field

$$P_{(pwe)} = \frac{E_{tot}^2}{3770} \text{ or } P_{(pwe)} = H_{tot}^2 \cdot 37.7$$

Where P<sub>pwe</sub>=Equivalent power density of a plane wave in mW/cm<sup>2</sup>

E<sub>tot</sub>=total electric field strength in V/m

H<sub>tot</sub>=total magnetic field strength in A/m

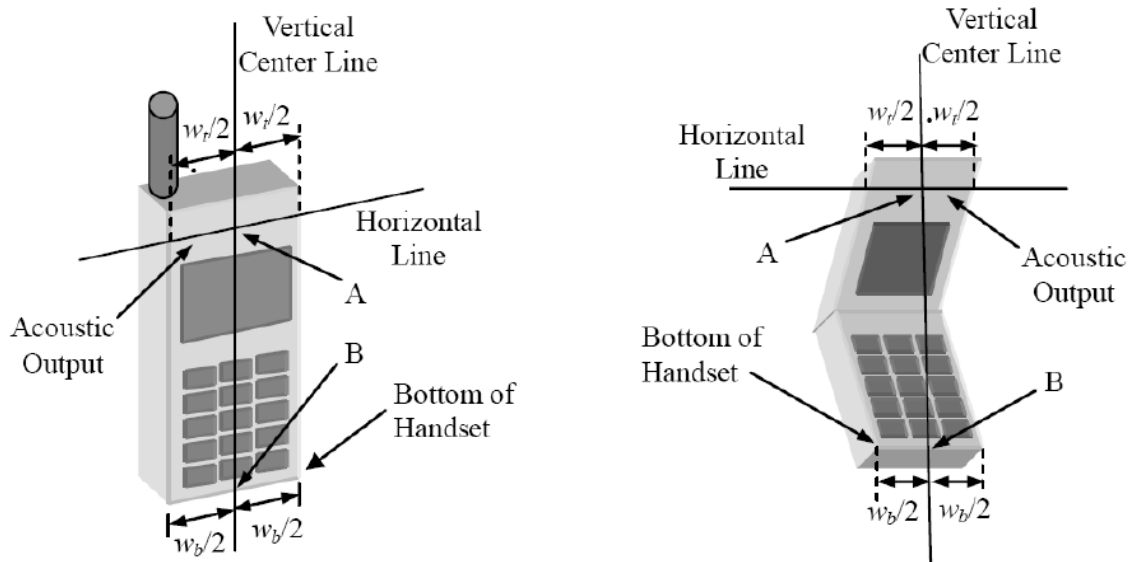

- W<sub>t</sub> Width of the handset at the level of the acoustic
- W<sub>b</sub> Width of the bottom of the handset
- A Midpoint of the width w<sub>t</sub> of the handset at the level of the acoustic output
- B Midpoint of the width w<sub>b</sub> of the bottom of the handset

Picture 1-a Typical “fixed” case handset    Picture 1-b Typical “clam-shell” case handset



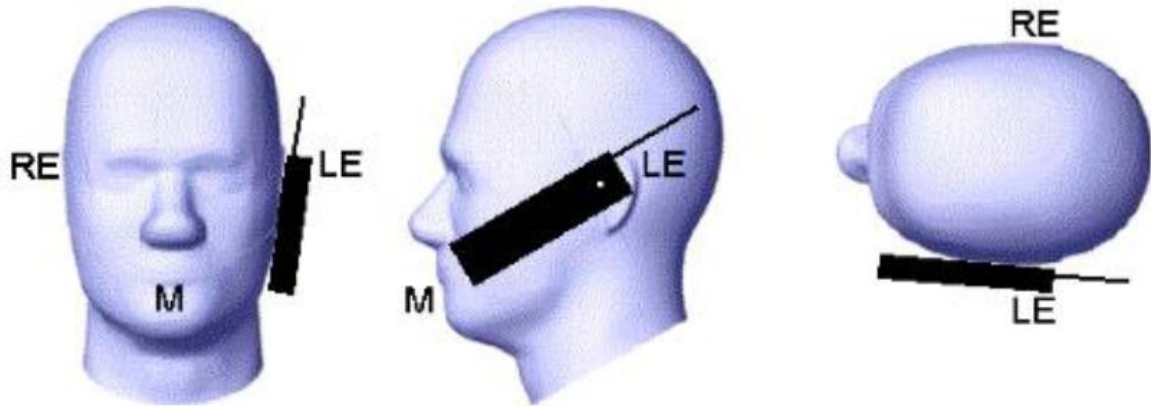

Picture 2 Cheek position of the wireless device on the left side of SAM

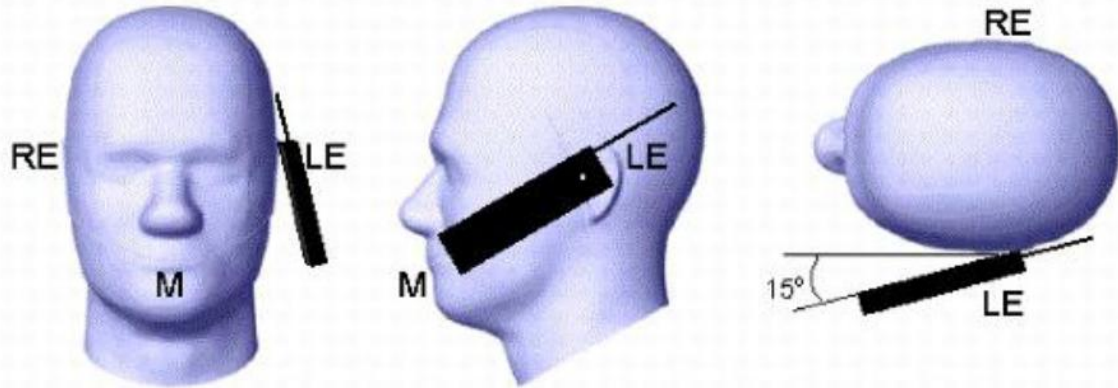

Picture 3 Tilt position of the wireless device on the left side of SAM

For body SAR test we applied to FCC KDB941225, KDB447498, KDB248227, KDB648654;

### 3.8. Tissue Dielectric Parameters for Head and Body Phantoms

The liquid is consisted of water,salt,Glycol,Sugar,Preventol and Cellulose.The liquid has previously been proven to be suited for worst-case.It's satisfying the latest tissue dielectric parameters requirements proposed by the KDB865664.

The composition of the tissue simulating liquid

Ingredient (% Weight)	750MHz		835MHz		1800 MHz		1900 MHz		2450MHz		2600MHz		5000MHz	
	Head	Body	Head	Body	Head	Body	Head	Body	Head	Body	Head	Body	Head	Body
Water	39.28	51.3	41.45	52.5	54.5	40.2	54.9	40.4	62.7	73.2	60.3	71.4	65.5	78.6
Preventol	0.10	0.10	0.10	0.10	0.00	0.00	0.00	0.00	0.00	0.00	0.00	0.00	0.00	0.00
HEC	1.00	1.00	1.00	1.00	0.00	0.00	0.00	0.00	0.00	0.00	0.00	0.00	0.00	0.00
DGBE	0.00	0.00	0.00	0.00	45.33	59.31	44.92	59.10	36.80	26.70	39.10	28.40	0.00	0.00
Triton X-100	0.00	0.00	0.00	0.00	0.00	0.00	0.00	0.00	0.00	0.00	0.00	0.00	17.2	10.7

Target Frequency (MHz)	Head		Body	
	$\epsilon_r$	$\sigma(S/m)$	$\epsilon_r$	$\sigma(S/m)$
150	52.3	0.76	61.9	0.80
300	45.3	0.87	58.2	0.92
450	43.5	0.87	56.7	0.94
835	41.5	0.90	55.2	0.97
900	41.5	0.97	55.0	1.05
915	41.5	0.98	55.0	1.06
1450	40.5	1.20	54.0	1.30
1610	40.3	1.29	53.8	1.40
1800-2000	40.0	1.40	53.3	1.52
2450	39.2	1.80	52.7	1.95
3000	38.5	2.40	52.0	2.73
5800	35.3	5.27	48.2	6.00

### 3.9. Tissue equivalent liquid properties

Dielectric Performance of Head and Body Tissue Simulating Liquid

Test Engineer: Vera Deng									
Tissue Type	Measured Frequency (MHz)	Target Tissue		Measured Tissue				Liquid Temp.	Test Data
		$\sigma$	$\epsilon_r$	$\sigma$	Dev.	$\epsilon_r$	Dev.		
835H	835	0.90	41.50	0.86	-4.44%	42.31	1.95%	21.1	03/20/2019
1900H	1900	1.40	40.00	1.36	-2.86%	41.02	2.55%	20.3	03/25/2019
2450H	2450	1.80	39.20	1.79	-0.56%	39.63	1.10%	20.1	04/04/2019
835B	835	0.97	55.20	0.95	-2.06%	54.28	-1.67%	22.2	03/21/2019
1900B	1900	1.52	53.30	1.56	2.63%	52.06	-2.33%	20.5	04/01/2019
2450B	2450	1.95	52.70	1.99	2.05%	51.62	-2.05%	21.0	04/09/2019

### 3.10. System Check

The purpose of the system check is to verify that the system operates within its specifications at the device test frequency. The system check is simple check of repeatability to make sure that the system works correctly at the time of the compliance test;

System check results have to be equal or near the values determined during dipole calibration with the relevant liquids and test system ( $\pm 10\%$ ).

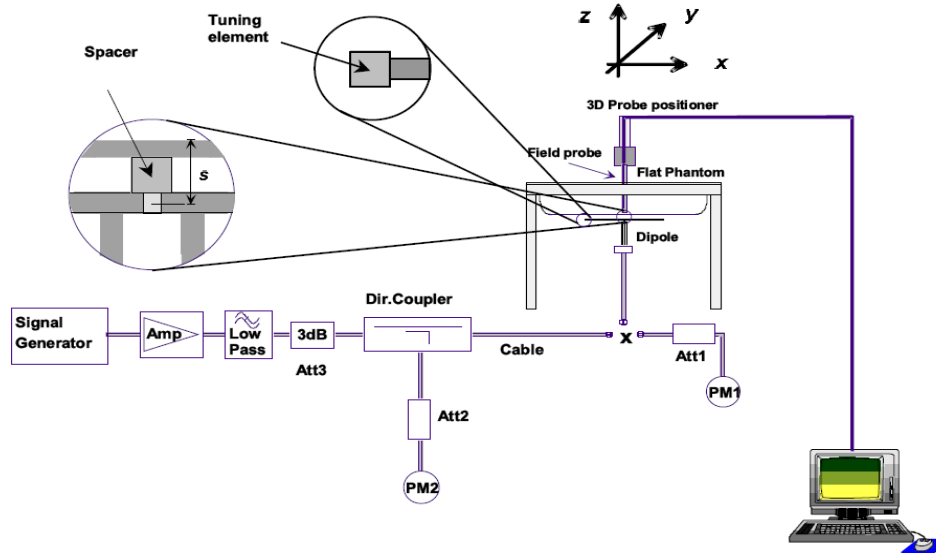

The output power on dipole port must be calibrated to 20 dBm (100mW) before dipole is connected.



Photo of Dipole Setup

**Justification for Extended SAR Dipole Calibrations**

Referring to KDB 865664D01V01r04, if dipoles are verified in return loss (<-20dB, within 20% of prior calibration), and in impedance (within 5 ohm of prior calibration), the annual calibration is not necessary and the calibration interval can be extended. While calibration intervals not exceed 3 years.

**SID835 SN 07/14 DIP 0G835-303 Extend Dipole Calibrations**

Date of Measurement	Return-Loss (dB)	Delta (%)	Real Impedance (ohm)	Delta (ohm)	Imaginary Impedance (ohm)	Delta (ohm)
2018-10-01	-24.49		54.9		2.8	

**SID1900 SN 38/18 DIP 1G900-466 Extend Dipole Calibrations**

Date of Measurement	Return-Loss (dB)	Delta (%)	Real Impedance (ohm)	Delta (ohm)	Imaginary Impedance (ohm)	Delta (ohm)
2018-09-24	-26.43		50.5		4.7	

**SID2450 SN 07/14 DIP 2G450-306 Extend Dipole Calibrations**

Date of Measurement	Return-Loss (dB)	Delta (%)	Real Impedance (ohm)	Delta (ohm)	Imaginary Impedance (ohm)	Delta (ohm)
2018-10-01	-25.59		44.7		-1.1	

Mixture Type	Frequency (MHz)	Power	SAR <sub>1g</sub> (W/kg)	SAR <sub>10g</sub> (W/kg)	Drift (%)	1W Target		Difference percentage		Liquid Temp	Date
						SAR <sub>1g</sub> (W/kg)	SAR <sub>10g</sub> (W/kg)	1g	10g		
Head	835	100 mW	0.910	0.631	-0.31	9.60	6.20	-5.21%	1.77%	21.1	03/20/2019
		Normalize to 1 Watt	9.10	6.31							
Body	835	100 mW	0.975	0.638	1.21	9.90	6.39	-2.02%	-0.16%	22.2	03/21/2019
		Normalize to 1 Watt	9.71	6.38							
Head	1900	100 mW	3.912	2.000	-0.01	39.84	20.20	-1.46%	-2.44%	20.3	03/25/2019
		Normalize to 1 Watt	39.12	20.00							
Body	1900	100 mW	4.274	2.112	2.90	43.33	21.59	4.47%	-1.31%	20.5	04/01/2019
		Normalize to 1 Watt	42.74	21.12							
Head	2450	100 mW	5.256	2.382	-1.54	53.89	24.15	-2.47%	-1.37%	20.1	04/04/2019
		Normalize to 1 Watt	52.56	23.82							
Body	2450	100 mW	5.243	2.387	-0.54	54.65	24.58	-4.06%	-2.89%	21.0	04/09/2019
		Normalize to 1 Watt	52.43	23.87							

**3.11. SAR measurement procedure**

The measurement procedures are as follows:

**3.11.1 Conducted power measurement**

- For WWAN power measurement, use base station simulator connection with RF cable, at maximum power in each supported wireless interface and frequency band.
- Read the WWAN RF power level from the base station simulator.
- For WLAN/BT power measurement, use engineering software to configure EUT WLAN/BT continuously Transmission, at maximum RF power in each supported wireless interface and frequency band.
- Connect EUT RF port through RF cable to the power meter, and measure WLAN/BT output power.

**3.11.2 GSM Test Configuration**

SAR tests for GSM 850 and GSM 1900, a communication link is set up with a System Simulator (SS) by air link. Using CMU200 the power level is set to "5" for GSM 850, set to "0" for GSM 1900. Since the GPRS class is 12 for this EUT, it has at most 4 timeslots in uplink and at most 4 timeslots in downlink, the maximum total timeslots is 4.

the EGPRS class is 12 for this EUT, it has at most 4 timeslots in uplink and at most 4 timeslots in downlink, the maximum total timeslots is 4.

SAR test reduction for GPRS and EDGE modes is determined by the source-based time-averaged output power specified for production units, including tune-up tolerance. The data mode with highest specified time-averaged output power should be tested for SAR compliance in the applicable exposure conditions. For modes with the same specified maximum output power and tolerance, the higher number time-slot configuration should be tested. GSM voice and GPRS data use GMSK, which is a constant amplitude modulation with minimal peak to average power difference within the time-slot burst. For EDGE, GMSK is used for MCS 1 – MCS 4 and 8-PSK is used for MCS 5 – MCS 9; where 8-PSK has an inherently higher peak-to-average power ratio. The GMSK and 8-PSK EDGE configurations are considered separately for SAR compliance. The GMSK EDGE configurations are grouped with GPRS and considered with respect to time-averaged maximum output power to determine compliance. The 3G SAR test reduction procedure is applied to 8-PSK EDGE with GMSK GPRS/EDGE as the primary mode.

### 3.11.3 LTE Test Configuration

QPSK with 1 RB allocation

Start with the largest channel bandwidth and measure SAR for QPSK with 1 RB allocation, using the RB offset and required test channel combination with the highest maximum output power among RB offsets at the upper edge, middle and lower edge of each required test channel. When the reported SAR is  $\leq 0.8$  W/kg, testing of the remaining RB offset configurations and required test channels is not required for 1 RB allocation; otherwise, SAR is required for the remaining required test channels and only for the RB offset configuration with the highest output power for that channel.<sup>8</sup> When the reported SAR of a required test channel is  $> 1.45$  W/kg, SAR is required for all three RB offset configurations for that required test channel.

QPSK with 50% RB allocation

The procedures required for 1 RB allocation in section 4.2.1 are applied to measure the SAR for QPSK with 50% RB allocation.<sup>9</sup>

QPSK with 100% RB allocation

For QPSK with 100% RB allocation, SAR is not required when the highest maximum output power for 100 % RB allocation is less than the highest maximum output power in 50% and 1 RB allocations and the highest reported SAR for 1 RB and 50% RB allocation in sections 4.2.1 and 4.2.2 are  $\leq 0.8$  W/kg. Otherwise, SAR is measured for the highest output power channel; and if the reported SAR is  $> 1.45$  W/kg, the remaining required test channels must also be tested.

### 3.11.4 WIFI Test Configuration

The SAR measurement and test reduction procedures are structured according to either the DSSS or OFDM transmission mode configurations used in each standalone frequency band and aggregated band. For devices that operate in exposure configurations that require multiple test positions, additional SAR test reduction may be applied. The maximum output power specified for production units, including tune-up tolerance, are used to determine initial SAR test requirements for the 802.11 transmission modes in a frequency band. SAR is measured using the highest measured maximum output power channel for the initial test configuration. SAR measurement and test reduction for the remaining 802.11 modes and test channels are determined according to measured or specified maximum output power and reported SAR of the initial measurements. The general test reduction and SAR measurement approaches are summarized in the following:

1. The maximum output power specified for production units are determined for all applicable 802.11 transmission modes in each standalone and aggregated frequency band. Maximum output power is measured for the highest maximum output power configuration(s) in each frequency band according to the default power measurement procedures.
2. For OFDM transmission configurations in the 2.4 GHz and 5 GHz bands, an "initial test configuration" is first determined for each standalone and aggregated frequency band according to the maximum output power and tune-up tolerance specified for production units.
  - a. When the same maximum power is specified for multiple transmission modes in a frequency band, the largest channel bandwidth, lowest order modulation, lowest data rate and lowest order 802.11 a/g/n/ac mode is used for SAR measurement, on the highest measured output power channel in the initial test configuration, for each frequency band.
  - b. SAR is measured for OFDM configurations using the initial test configuration procedures. Additional frequency band specific SAR test reduction may be considered for individual frequency bands
  - c. Depending on the reported SAR of the highest maximum output power channel tested in the initial test configuration, SAR test reduction may apply to subsequent highest output channels in the initial test configuration to reduce the number of SAR measurements.

3. The Initial test configuration does not apply to DSSS. The 2.4 GHz band SAR test requirements and 802.11b DSSS procedures are used to establish the transmission configurations required for SAR measurement.
4. An "initial test position" is applied to further reduce the number of SAR tests for devices operating in next to the ear, UMPC mini-tablet or hotspot mode exposure configurations that require multiple test positions .
  - a. SAR is measured for 802.11b according to the 2.4 GHz DSSS procedure using the exposure condition established by the initial test position.
  - b. SAR is measured for 2.4 GHz and 5 GHz OFDM configurations using the initial test configuration. 802.11b/g/n operating modes are tested independently according to the service requirements in each frequency band. 802.11b/g/n modes are tested on the maximum average output channel.
5. The Initial test position does not apply to devices that require a fixed exposure test position. SAR is measured in a fixed exposure test position for these devices in 802.11b according to the 2.4 GHz DSSS procedure or in 2.4 GHz and 5 GHz OFDM configurations using the initial test configuration procedures .
6. The "subsequent test configuration" procedures are applied to determine if additional SAR measurements are required for the remaining OFDM transmission modes that have not been tested in the initial test configuration. SAR test exclusion is determined according to reported SAR in the initial test configuration and maximum output power specified or measured for these other OFDM configurations.

#### 2.4 GHz and 5GHz SAR Procedures

Separate SAR procedures are applied to DSSS and OFDM configurations in the 2.4 GHz band to simplify DSSS test requirements. For 802.11b DSSS SAR measurements, DSSS SAR procedure applies to fixed exposure test position and initial test position procedure applies to multiple exposure test positions. When SAR measurement is required for an OFDM configuration, the initial test configuration, subsequent test configuration and initial test position procedures are applied. The SAR test exclusion requirements for 802.11g/n OFDM configurations are described in section 5.2.2.

##### 1. 802.11b DSSS SAR Test Requirements

SAR is measured for 2.4 GHz 802.11b DSSS using either a fixed test position or, when applicable, the initial test position procedure. SAR test reduction is determined according to the following:

- a. When the reported SAR of the highest measured maximum output power channel (section 3.1) for the exposure configuration is  $\leq 0.8$  W/kg, no further SAR testing is required for 802.11b DSSS in that exposure configuration.
- b. When the reported SAR is  $> 0.8$  W/kg, SAR is required for that exposure configuration using the next highest measured output power channel. When any reported SAR is  $> 1.2$  W/kg, SAR is required for the third channel; i.e., all channels require testing.

##### 1. 2.4 GHz 802.11g/n OFDM SAR Test Exclusion Requirements

When SAR measurement is required for 2.4 GHz 802.11g/n OFDM configurations, the measurement and test reduction procedures for OFDM are applied (section 5.3). SAR is not required for the following 2.4 GHz OFDM conditions.

- a. When KDB Publication 447498 SAR test exclusion applies to the OFDM configuration
- b. When the highest reported SAR for DSSS is adjusted by the ratio of OFDM to DSSS specified maximum output power and the adjusted SAR is  $\leq 1.2$  W/kg.

##### 2. SAR Test Requirements for OFDM Configurations

When SAR measurement is required for 802.11 a/g/n/ac OFDM configurations, each standalone and frequency aggregated band is considered separately for SAR test reduction. When the same transmitter and antenna(s) are used for U-NII-1 and U-NII-2A bands, additional SAR test reduction applies. When band gap channels between U-NII-2C band and 5.8 GHz U-NII-3 or §15.247 band are supported, the highest maximum output power transmission mode configuration and maximum output power channel across the bands must be used to determine SAR test reduction, according to the initial test configuration and subsequent test configuration requirements.<sup>20</sup> In applying the initial test configuration and subsequent test configuration procedures, the 802.11 transmission configuration with the highest specified maximum output power and the channel within a test configuration with the highest measured maximum output power should be clearly distinguished to apply the procedures.

##### 3. OFDM Transmission Mode SAR Test Configuration and Channel Selection Requirements

The initial test configuration for 2.4 GHz and 5 GHz OFDM transmission modes is determined by the 802.11 configuration with the highest maximum output power specified for production units, including tune-up tolerance, in each standalone and aggregated frequency band. SAR for the initial test configuration is measured using the highest maximum output power channel determined by the default power measurement procedures (section 4). When multiple configurations in a frequency band have the same specified maximum output power, the initial test configuration is determined according to the following steps applied sequentially.

- a. The largest channel bandwidth configuration is selected among the multiple configurations with the same specified maximum output power.
- b. If multiple configurations have the same specified maximum output power and largest channel bandwidth, the lowest order modulation among the largest channel bandwidth configurations is selected.
- c. If multiple configurations have the same specified maximum output power, largest channel bandwidth and lowest order modulation, the lowest data rate configuration among these configurations is selected.

- d. When multiple transmission modes (802.11a/g/n/ac) have the same specified maximum output power, largest channel bandwidth, lowest order modulation and lowest data rate, the lowest order 802.11 mode is selected; i.e., 802.11a is chosen over 802.11n then 802.11ac or 802.11g is chosen over 802.11n.

After an initial test configuration is determined, if multiple test channels have the same measured maximum output power, the channel chosen for SAR measurement is determined according to the following. These channel selection procedures apply to both the initial test configuration and subsequent test configuration(s), with respect to the default power measurement procedures or additional power measurements required for further SAR test reduction. The same procedures also apply to subsequent highest output power channel(s) selection.

- a. Channels with measured maximum output power within  $\frac{1}{4}$  dB of each other are considered to have the same maximum output.
- b. When there are multiple test channels with the same measured maximum output power, the channel closest to mid-band frequency is selected for SAR measurement.
- c. When there are multiple test channels with the same measured maximum output power and equal separation from mid-band frequency; for example, high and low channels or two mid-band channels, the higher frequency (number) channel is selected for SAR measurement.

#### Initial Test Configuration Procedures

An initial test configuration is determined for OFDM transmission modes according to the channel bandwidth, modulation and data rate combination(s) with the highest maximum output power specified for production units in each standalone and aggregated frequency band. SAR is measured using the highest measured maximum output power channel. For configurations with the same specified or measured maximum output power, additional transmission mode and test channel selection procedures are required (see section 5.3.2). SAR test reduction of subsequent highest output test channels is based on the reported SAR of the initial test configuration. For next to the ear, hotspot mode and UMC mini-tablet exposure configurations where multiple test positions are required, the initial test position procedure is applied to minimize the number of test positions required for SAR measurement using the initial test configuration transmission mode.<sup>23</sup> For fixed exposure conditions that do not have multiple SAR test positions, SAR is measured in the transmission mode determined by the initial test configuration. When the reported SAR of the initial test configuration is  $> 0.8$  W/kg, SAR measurement is required for the subsequent next highest measured output power channel(s) in the initial test configuration until the reported SAR is  $\leq 1.2$  W/kg or all required channels are tested.

#### 4. Subsequent Test Configuration Procedures

SAR measurement requirements for the remaining 802.11 transmission mode configurations that have not been tested in the initial test configuration are determined separately for each standalone and aggregated frequency band, in each exposure condition, according to the maximum output power specified for production units. The initial test position procedure is applied to next to the ear, UMPC mini-tablet and hotspot mode configurations. When the same maximum output power is specified for multiple transmission modes, the procedures in section 5.3.2 are applied to determine the test configuration. Additional power measurements may be required to determine if SAR measurements are required for subsequent highest output power channels in a subsequent test configuration. The subsequent test configuration and SAR measurement procedures are described in the following.

- a. When SAR test exclusion provisions of KDB Publication 447498 are applicable and SAR measurement is not required for the initial test configuration, SAR is also not required for the next highest maximum output power transmission mode subsequent test configuration(s) in that frequency band or aggregated band and exposure configuration.
- b. When the highest reported SAR for the initial test configuration (when applicable, include subsequent highest output channels), according to the initial test position or fixed exposure position requirements, is adjusted by the ratio of the subsequent test configuration to initial test configuration specified maximum output power and the adjusted SAR is  $\leq 1.2$  W/kg, SAR is not required for that subsequent test configuration.
- c. The number of channels in the initial test configuration and subsequent test configuration can be different due to differences in channel bandwidth. When SAR measurement is required for a subsequent test configuration and the channel bandwidth is smaller than that in the initial test configuration, all channels in the subsequent test configuration that overlap with the larger bandwidth channel tested in the initial test configuration should be used to determine the highest maximum output power channel. This step requires additional power measurement to identify the highest maximum output power channel in the subsequent test configuration to determine SAR test reduction.
  - 1). SAR should first be measured for the channel with highest measured output power in the subsequent test configuration.
  - 2). SAR for subsequent highest measured maximum output power channels in the subsequent test configuration is required only when the reported SAR of the preceding higher maximum output power channel(s) in the subsequent test configuration is  $> 1.2$  W/kg or until all required channels are tested.
    - a) For channels with the same measured maximum output power, SAR should be measured using the channel closest to the center frequency of the larger channel bandwidth channel in the initial test configuration.
    - d. SAR measurements for the remaining highest specified maximum output power OFDM transmission mode configurations that have not been tested in the initial test configuration (highest maximum output) or subsequent test configuration(s) (subsequent next highest maximum output power) is determined by applying

the subsequent test configuration procedures in this section to the remaining configurations according to the following:

- 1) replace “subsequent test configuration” with “next subsequent test configuration” (i.e., subsequent next highest specified maximum output power configuration)
- 2) replace “initial test configuration” with “all tested higher output power configurations.”

### **3.12. Power Reduction**

The product without any power reduction.

### **3.13. Power Drift**

To control the output power stability during the SAR test, SAR system calculates the power drift by measuring the E-field at the same location at the beginning and at the end of the measurement for each test position. This ensures that the power drift during one measurement is within 5%.



## 4. TEST CONDITIONS AND RESULTS

### 4.1. Conducted Power Results

According KDB 447498 D01 General RF Exposure Guidance v06 Section 4.1 2) states that "Unless it is specified differently in the published RF exposure KDB procedures, these requirements also apply to test reduction and test exclusion considerations. Time-averaged maximum conducted output power applies to SAR and, as required by § 2.1091(c), time-averaged ERP applies to MPE. When an antenna port is not available on the device to support conducted power measurement, such as FRS and certain Part 15 transmitters with built-in integral antennas, the maximum output power allowed for production units should be used to determine RF exposure test exclusion and compliance."

#### <GSM Conducted Power>

General Note:

1. Per KDB 447498 D01v06, the maximum output power channel is used for SAR testing and for further SAR test reduction.
2. According to October 2013TCB Workshop, for GSM / GPRS / EGPRS, the number of time slots to test for SAR should correspond to the highest frame-average maximum output power configuration, considering the possibility of e.g. 3rd party VoIP operation for head and body-worn SAR testing, the EUT was set in GPRS (3Tx slot) for GSM850/GSM1900 band due to their highest frame-average power.
3. For hotspot mode SAR testing, GPRS should be evaluated, therefore the EUT was set in GPRS (3Tx slots) for GSM850/GSM1900 band due to its highest frame-average power.

#### <SIM2>

#### Conducted power measurement results for GSM850/PCS1900

GSM 850	Tune-up	Burst Conducted power (dBm)			Division Factors	Tune-up	Average power (dBm)			
		Channel/Frequency(MHz)					Channel/Frequency(MHz)			
	Max	128/824.2	190/836.6	251/848.8		Max	128/824.2	190/836.6	251/848.8	
GSM	33.00	32.27	32.55	32.17	-9.03dB	23.97	23.24	23.52	23.14	
GPRS (GMSK)	1TX slot	32.50	32.21	32.42	31.96	-9.03dB	23.47	23.18	23.39	22.93
	2TX slot	31.00	30.61	30.84	30.38	-6.02dB	24.98	24.59	24.82	24.36
	<b>3TX slot</b>	<b>30.00</b>	<b>29.58</b>	<b>29.83</b>	<b>29.35</b>	<b>-4.26dB</b>	<b>25.74</b>	<b>25.32</b>	<b>25.57</b>	<b>25.09</b>
	4TX slot	28.50	28.16	28.22	27.84	-3.01dB	25.49	25.15	25.21	24.83
EGPRS (8PSK)	1TX slot	26.50	26.19	26.44	25.90	-9.03dB	17.47	17.16	17.41	16.87
	2TX slot	24.50	23.92	24.09	23.77	-6.02dB	18.48	17.90	18.07	17.75
	3TX slot	23.00	22.46	22.53	22.23	-4.26dB	18.74	18.20	18.27	17.97
	4TX slot	21.50	20.95	21.20	20.75	-3.01dB	18.49	17.94	18.19	17.74
GSM 1900	Tune-up	Burst Conducted power (dBm)			Division Factors	Tune-up	Average power (dBm)			
		Channel/Frequency(MHz)					Channel/Frequency(MHz)			
	Max	512/1850.2	661/1880	810/1909.8		Max.	512/1850.2	661/1880	810/1909.8	
GSM	29.50	29.34	29.48	29.12	-9.03dB	20.97	20.31	20.45	20.09	
GPRS (GMSK)	1TX slot	29.50	29.17	29.32	28.96	-9.03dB	20.47	20.14	20.29	19.93
	2TX slot	28.00	27.55	27.68	27.34	-6.02dB	21.98	21.53	21.66	21.32
	<b>3TX slot</b>	<b>27.00</b>	<b>26.74</b>	<b>26.80</b>	<b>26.42</b>	<b>-4.26dB</b>	<b>22.74</b>	<b>22.48</b>	<b>22.54</b>	<b>22.16</b>
	4TX slot	25.50	25.24	25.40	24.92	-3.01dB	22.49	22.23	22.39	21.91
EGPRS (8PSK)	1TX slot	26.00	25.70	25.78	25.45	-9.03dB	16.97	16.67	16.75	16.42
	2TX slot	24.00	23.47	23.57	23.13	-6.02dB	17.98	17.45	17.55	17.11
	3TX slot	22.50	22.01	22.10	21.79	-4.26dB	18.24	17.75	17.84	17.53
	4TX slot	21.50	20.49	20.62	20.19	-3.01dB	18.49	17.48	17.61	17.18

## &lt;SIM1&gt;

GSM 850		Burst Average Conducted power (dBm)		
		Channel/Frequency(MHz)		
		128/824.2	190/836.6	251/848.8
GSM		32.33	32.52	32.18
GPRS (GMSK)	1TX slot	32.28	32.45	32.02
	2TX slot	30.65	30.86	30.45
	3TX slot	29.64	29.79	29.42
	4TX slot	28.17	28.22	27.86
EGPRS (8PSK)	1TX slot	26.21	26.45	25.97
	2TX slot	23.97	24.09	23.79
	3TX slot	22.51	22.53	22.27
	4TX slot	21.02	21.17	20.78
GSM 1900		Burst Average Conducted power (dBm)		
		Channel/Frequency(MHz)		
		512/1850.2	661/1880	810/1909.8
GSM		29.40	29.48	29.13
GPRS (GMSK)	1TX slot	29.18	29.33	29.02
	2TX slot	27.55	27.67	27.38
	3TX slot	26.75	26.82	26.47
	4TX slot	25.26	25.40	24.96
EGPRS (8PSK)	1TX slot	25.71	25.78	25.46
	2TX slot	23.50	23.59	23.16
	3TX slot	22.01	22.11	21.80
	4TX slot	20.51	20.58	20.20

**Notes:**

## 1. Division Factors

To average the power, the division factor is as follows:

1TX-slot = 1 transmit time slot out of 8 time slots=> conducted power divided by (8/1) => -9.00dB

2TX-slots = 2 transmit time slots out of 8 time slots=> conducted power divided by (8/2) => -6.00dB

3TX-slots = 3 transmit time slots out of 8 time slots=> conducted power divided by (8/3) => -4.26dB

4TX-slots = 4 transmit time slots out of 8 time slots=> conducted power divided by (8/4) => -3.00dB

2. According to the conducted power as above, the GPRS measurements are performed with 3Txslot for GPRS850 and 3Txslot GPRS1900.

<SIM1>  
LTE Band5

BW (MHz)	Frequency (MHz)	RB Configuration		Average Power [dBm]	
		Size	Offset	QPSK	16QAM
1.4	824.7	1	0	23.80	22.90
		1	3	23.61	22.95
		1	5	23.55	22.92
		3	0	23.67	22.80
		3	2	23.76	22.86
		3	3	23.75	22.83
	836.5	6	0	22.73	21.71
		1	0	23.12	22.19
		1	3	22.93	22.42
		1	5	22.96	22.06
		3	0	22.97	21.78
		3	2	23.10	22.02
	848.3	3	3	22.99	22.15
		6	0	22.36	21.13
		1	0	23.26	22.80
		1	3	23.29	22.41
		1	5	23.20	22.37
		3	0	23.26	22.34
3	825.5	3	2	23.46	22.38
		3	3	23.36	22.63
		6	0	22.52	21.45
		1	0	23.66	22.94
		1	7	23.54	22.78
		1	14	23.52	22.77
	836.5	8	0	22.78	21.87
		8	4	22.68	21.79
		8	7	22.63	21.72
		15	0	22.74	21.75
		1	0	22.80	21.91
		1	7	22.76	21.79
	847.5	1	14	22.66	21.96
		8	0	22.19	21.17
		8	4	22.15	21.18
		8	7	22.27	21.05
		15	0	22.03	21.10
		1	0	23.14	22.51
5	826.5	1	7	23.11	22.45
		1	14	23.51	22.32
		8	0	22.49	21.43
		8	4	22.50	21.38
		8	7	22.55	21.60
		15	0	22.30	21.45
	836.5	1	0	23.62	22.91
		1	12	23.52	22.72
		1	24	23.50	22.74
		12	0	22.80	21.92
		12	6	22.74	21.87
		12	13	22.62	21.75
836.5	25	0	22.70	21.73	
	1	0	22.96	22.46	
	1	12	22.47	21.82	
	1	24	22.17	21.61	
	12	0	22.08	21.26	
	12	6	22.19	21.16	
		12	13	22.07	21.07
		25	0	22.11	21.06

	846.5	1	0	23.31	22.17
		1	12	23.49	22.45
		1	24	23.20	21.62
		12	0	22.28	21.30
		12	6	22.46	21.52
		12	13	22.50	21.41
		25	0	22.61	21.48
10	829.0	1	0	23.76	22.94
		1	24	23.60	22.75
		1	49	23.55	22.90
		25	0	22.87	21.86
		25	12	22.69	21.50
		25	25	22.54	21.57
		50	0	22.71	21.74
	836.5	1	0	23.38	22.63
		1	24	22.69	22.35
		1	49	22.00	21.07
		25	0	22.08	21.24
		25	12	22.11	21.08
		25	25	22.08	21.02
		50	0	22.39	21.34
	844.0	1	0	23.22	22.49
		1	24	23.62	22.86
		1	49	22.77	22.18
		25	0	22.17	21.28
		25	12	22.34	21.38
		25	25	22.46	21.49
		50	0	22.40	21.42

**<SIM2>  
LTE Band5**

BW (MHz)	Frequency (MHz)	RB Configuration		Average Power [dBm]	
		Size	Offset	QPSK	16QAM
1.4	824.7	1	0	23.85	22.73
		1	3	23.64	22.74
		1	5	23.57	22.69
		3	0	23.63	22.59
		3	2	23.73	22.61
		3	3	23.79	22.59
		6	0	22.75	21.54
	836.5	1	0	23.14	22.02
		1	3	22.95	22.19
		1	5	22.93	21.81
		3	0	23.00	21.59
		3	2	23.15	21.81
		3	3	23.01	21.97
		6	0	22.70	21.17
	848.3	1	0	23.24	22.59
		1	3	23.31	22.21
		1	5	23.18	22.15
		3	0	23.21	22.17
		3	2	23.42	22.17
		3	3	23.37	22.45
		6	0	22.47	21.26
3	825.5	1	0	23.69	22.71
		1	7	23.53	22.59
		1	14	23.54	22.61
		8	0	22.79	21.62
		8	4	22.64	21.57
		8	7	22.60	21.51
		15	0	22.72	21.56

	836.5	1	0	22.78	21.66
		1	7	22.75	21.63
		1	14	22.71	21.71
		8	0	22.10	21.06
		8	4	22.06	21.02
		8	7	22.15	21.09
		15	0	22.24	21.15
	847.5	1	0	23.14	22.28
		1	7	23.15	22.28
		1	14	23.48	22.09
		8	0	22.51	21.22
		8	4	22.49	21.22
		8	7	22.55	21.43
		15	0	22.26	21.27
5	826.5	1	0	23.62	22.67
		1	12	23.53	22.55
		1	24	23.47	22.49
		12	0	22.76	21.72
		12	6	22.72	21.68
		12	13	22.58	21.51
		25	0	22.69	21.51
	836.5	1	0	22.94	22.28
		1	12	22.43	21.63
		1	24	22.21	21.38
		12	0	22.10	21.02
		12	6	22.33	21.05
		12	13	22.34	21.08
		25	0	22.33	21.02
	846.5	1	0	23.34	21.95
		1	12	23.49	22.24
		1	24	23.17	21.44
		12	0	22.24	21.05
		12	6	22.51	21.33
		12	13	22.48	21.24
		25	0	22.61	21.24
10	829.0	1	0	23.77	22.69
		1	24	23.61	22.54
		1	49	23.56	22.73
		25	0	22.85	21.61
		25	12	22.72	21.31
		25	25	22.56	21.36
		50	0	22.74	21.53
	836.5	1	0	23.43	22.40
		1	24	22.67	22.11
		1	49	22.41	21.15
		25	0	22.12	21.08
		25	12	22.35	21.04
		25	25	22.40	21.08
		50	0	22.36	21.11
844.0	1	0	23.22	22.26	
	1	24	23.63	22.61	
	1	49	22.74	21.96	
	25	0	22.19	21.06	
	25	12	22.30	21.20	
	25	25	22.46	21.29	
	50	0	22.43	21.17	

## &lt;WLAN 2.4GHz Conducted Power&gt;

Mode	Channel	Frequency (MHz)	Data rate (Mbps)	Average Output Power (dBm)
IEEE 802.11b	1	2412	1	9.34
			2	9.26
			5.5	9.15
			11	9.10
	6	2437	1	8.97
			2	8.78
			5.5	8.71
			11	8.63
	11	2462	1	8.22
			2	8.20
			5.5	8.16
			11	8.10
IEEE 802.11g	1	2412	6	9.16
			9	9.15
			12	9.11
			18	9.08
			24	9.05
			36	9.04
			48	9.00
			54	8.68
	6	2437	6	10.64
			9	10.60
			12	10.51
			18	10.46
			24	10.42
			36	10.35
			48	10.33
			54	10.30
	11	2462	6	10.07
			9	10.03
			12	9.86
			18	9.85
			24	9.62
			36	9.45
			48	9.42
			54	9.40
IEEE 802.11n HT20	1	2412	MCS0	9.36
			MCS1	9.32
			MCS2	9.30
			MCS3	9.25
			MCS4	9.21
			MCS5	9.20
			MCS6	9.16
	6	2437	MCS7	9.14
			MCS0	10.21
			MCS1	10.16
			MCS2	10.15
			MCS3	10.12
			MCS4	10.01
			MCS5	9.32
	11	2462	MCS6	9.22
			MCS7	9.21
			MCS0	9.72
			MCS1	9.71
			MCS2	9.46
			MCS3	9.41
		MCS4	9.24	

			MCS5	9.21
			MCS6	9.13
			MCS7	9.00
IEEE 802.11n HT40	3	2422	MCS0	8.80
			MCS1	8.64
			MCS2	8.61
			MCS3	8.63
			MCS4	8.51
			MCS5	8.50
			MCS6	8.42
	6	2437	MCS7	8.40
			MCS0	8.16
			MCS1	8.15
			MCS2	8.14
			MCS3	8.10
			MCS4	8.06
			MCS5	8.04
	9	2452	MCS6	8.00
			MCS7	7.68
			MCS0	8.74
			MCS1	8.62
			MCS2	8.54
			MCS3	8.50
			MCS4	8.41
			MCS5	7.85
			MCS6	7.73
			MCS7	7.66

**Note:** SAR is not required for the following 2.4 GHz OFDM conditions as the highest reported SAR for DSSS is adjusted by the ratio of OFDM to DSSS specified maximum output power and the adjusted SAR is  $\leq 1.2$  W/kg.

**<BT Conducted Power>**

Mode	channel	Frequency (MHz)	Conducted AVG output power (dBm)
GFSK-BLE	0	2402	0.051
	19	2440	0.647
	39	2480	0.070
GFSK	0	2402	0.401
	39	2441	0.779
	78	2480	0.116
$\pi/4$ -DQPSK	0	2402	-0.011
	39	2441	0.307
	78	2480	-0.373
8DPSK	0	2402	0.131
	39	2441	0.537
	78	2480	-0.163

Per KDB 447498 D01v06, the 1-g and 10-g SAR test exclusion thresholds for 100 MHz to 6 GHz at test separation distances  $\leq 50$  mm are determined by:

$[(\text{max. power of channel, including tune-up tolerance, mW}) / (\text{min. test separation distance, mm})] \cdot [\sqrt{f(\text{GHz})}] \leq 3.0$   
for 1-g SAR and  $\leq 7.5$  for 10-g extremity SAR

- $f(\text{GHz})$  is the RF channel transmit frequency in GHz
- Power and distance are rounded to the nearest mW and mm before calculation
- The result is rounded to one decimal place for comparison

Bluetooth Turn up Power (dBm)	Separation Distance (mm)	Frequency (GHz)	Exclusion Thresholds
1.0	5	2.45	0.4

Per KDB 447498 D01v06, when the minimum test separation distance is  $< 5$  mm, a distance of 5 mm is applied to determine SAR test exclusion. The test exclusion threshold is  $0.4 < 3.0$ , SAR testing is not required.

### Transmit Antennas and SAR Measurement Position

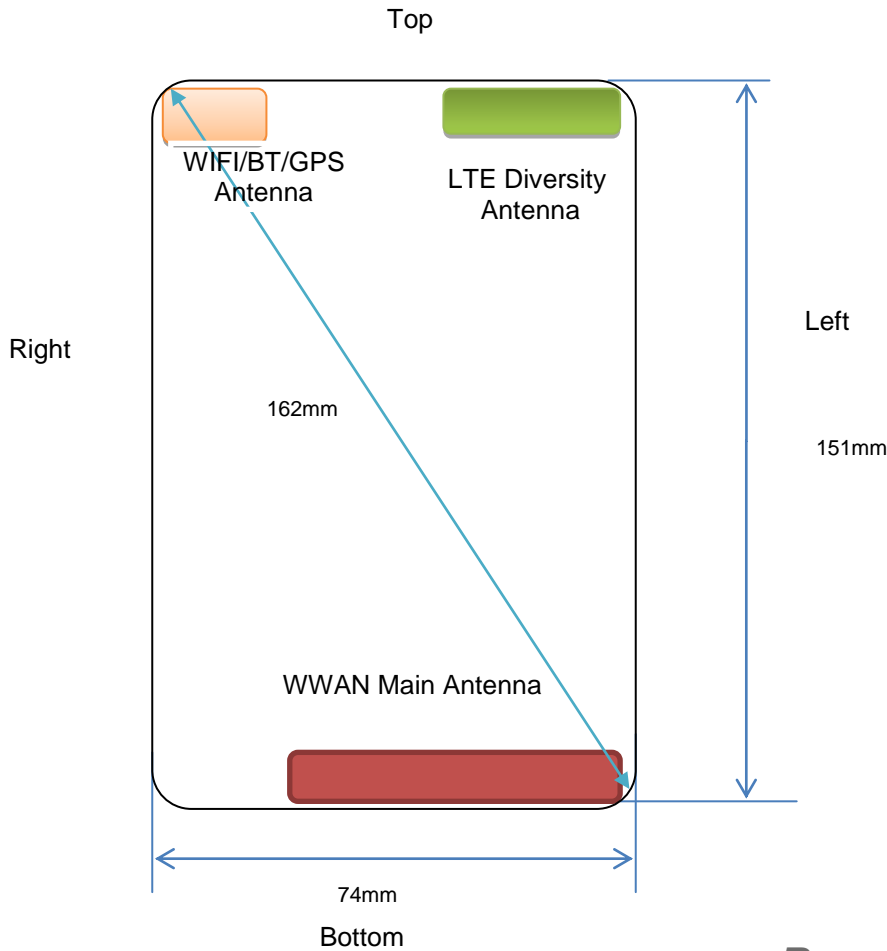

**Rear View**

Antenna information:

WWAN Main Antenna	GSM/UMTS/LTE TX/RX
LTE Diversity antenna	Only RX
WLAN/GPS/BT Antenna	WLAN/BT TX/RX

Note:

- 1). Per KDB648474 D04, because the overall diagonal distance of this devices is 162mm >160mm, it is considered as “Phablet” device.
- 2). Per KDB648474 D04, 10-g extremity SAR is not required when Body-Worn mode 1-g reported SAR < 1.2 W/Kg.
- 3). According to the KDB941225 D06 Hot Spot SAR v02, the edges with less than 25 mm distance to the antennas need to be tested for SAR.

Distance of The Antenna to the EUT surface and edge (mm)						
Antennas	Front	Back	Top Side	Bottom Side	Left Side	Right Side
WWAN	<5	<5	141	<5	<5	10
BT/WLAN	<5	<5	<5	143	53	<5

Positions for SAR tests; Hotspot mode						
Antennas	Front	Back	Top Side	Bottom Side	Left Side	Right Side
WWAN	Yes	Yes	No	Yes	Yes	Yes
BT/WLAN	Yes	Yes	Yes	No	No	Yes

**General Note:** Referring to KDB 941225 D06 v02, When the overall device length and width are ≥9cm\*5cm, the test distance is 10mm, SAR must be measured for all sides and surfaces with a transmitting antenna located with 25mm from that surface or edge.



## 4.2. SAR Measurement Results

The calculated SAR is obtained by the following formula:

$$\text{Reported SAR} = \text{Measured SAR} * 10^{(P_{\text{target}} - P_{\text{measured}})/10}$$

$$\text{Scaling factor} = 10^{(P_{\text{target}} - P_{\text{measured}})/10}$$

$$\text{Reported SAR} = \text{Measured SAR} * \text{Scaling factor}$$

Where

$P_{\text{target}}$  is the power of manufacturing upper limit;

$P_{\text{measured}}$  is the measured power;

Measured SAR is measured SAR at measured power which including power drift)

Reported SAR which including Power Drift and Scaling factor

### Duty Cycle

Test Mode	Duty Cycle
Speech for GSM850/1900	1:8
GPRS850	1:2.67
GPRS1900	1:2.67
LTE	1:1
WLAN2450	1:1

## 4.4.1 SAR Results

### SAR Values [GSM 850]

Ch.	Freq. (MHz)	Time slots	Test Position	Conducted Power (dBm)	Maximum Allowed Power (dBm)	Power Drift (%)	Scaling Factor	SAR <sub>1-g</sub> results(W/kg)		Graph Results
								Measured	Reported	
measured / reported SAR numbers – Head <SIM2>										
190	836.6	Voice	Left Cheek	32.55	33.00	0.09	1.109	0.035	0.039	
190	836.6	Voice	Left Tilt	32.55	33.00	-1.42	1.109	0.029	0.032	
190	836.6	Voice	Right Cheek	32.55	33.00	0.30	1.109	<b>0.068</b>	<b>0.075</b>	Plot 1
190	836.6	Voice	Right Tilt	32.55	33.00	0.03	1.109	0.049	0.054	
measured / reported SAR numbers - Body (hotspot open, distance 10mm) <SIM2>										
190	836.6	4Txslots	Front	29.83	30.00	-3.52	1.040	0.113	0.118	
190	836.6	4Txslots	Rear	29.83	30.00	-4.90	1.040	<b>0.170</b>	<b>0.177</b>	Plot 2
190	836.6	4Txslots	Left	29.83	30.00	-1.42	1.040	0.063	0.066	
190	836.6	4Txslots	Right	29.83	30.00	-3.64	1.040	0.050	0.052	
190	836.6	4Txslots	Bottom	29.83	30.00	1.74	1.040	0.071	0.074	

Remark:

- The value with black color is the maximum SAR Value of each test band.
- The frame average of GPRS (4Tx slots) higher than GSM and sample can support VoIP function, tested at GPRS (4Tx slots) mode for head.
- Per FCC KDB Publication 447498 D01, if the reported (scaled) SAR measured at the middle channel or highest output power channel for each test configuration is  $\leq 0.8$  W/kg then testing at the other channels is optional for such test configuration(s).

### SAR Values [GSM 1900]

Ch.	Freq. (MHz)	time slots	Test Position	Conducted Power (dBm)	Maximum Allowed Power (dBm)	Power Drift (%)	Scaling Factor	SAR <sub>1-g</sub> results(W/kg)		Graph Results
								Measured	Reported	
measured / reported SAR numbers – Head<SIM2>										
661	1880.0	Voice	Left Cheek	29.48	29.50	-2.40	1.005	<b>0.189</b>	<b>0.190</b>	Plot 3
661	1880.0	Voice	Left Tilt	29.48	29.50	0.11	1.005	0.093	0.093	
661	1880.0	Voice	Right Cheek	29.48	29.50	-1.82	1.005	0.122	0.123	
661	1880.0	Voice	Right Tilt	29.48	29.50	2.17	1.005	0.076	0.076	
measured / reported SAR numbers – Body (hotspot open, distance 10mm) <SIM2>										
661	1880.0	4Txslots	Front	26.80	27.00	0.02	1.047	<b>0.333</b>	<b>0.349</b>	Plot 4
661	1880.0	4Txslots	Rear	26.80	27.00	-2.05	1.047	0.269	0.282	
661	1880.0	4Txslots	Left	26.80	27.00	2.91	1.047	0.083	0.087	
661	1880.0	4Txslots	Right	26.80	27.00	-1.46	1.047	0.051	0.053	
661	1880.0	4Txslots	Bottom	26.80	27.00	0.33	1.047	0.106	0.111	

Remark:

- The value with black color is the maximum SAR Value of each test band.

2. The frame average of GPRS (4Tx slots) higher than GSM and sample can support VoIP function, tested at GPRS (4Tx slots) mode for head.

3. Per FCC KDB Publication 447498 D01, if the reported (scaled) SAR measured at the middle channel or highest output power channel for each test configuration is  $\leq 0.8$  W/kg then testing at the other channels is optional for such test configuration(s).

### SAR Values [LTE Band 5]

Ch.	Freq. (MHz)	Channel Type (10M)	Test Position	Conducted Power (dBm)	Maximum Allowed Power (dBm)	Power Drift (%)	Scaling Factor	SAR <sub>1-g</sub> results(W/kg)		Graph Results
								Measured	Reported	
<i>measured / reported SAR numbers - Head&lt;SIM2&gt;</i>										
20450	829.0	1RB	Left Cheek	23.77	24.00	2.87	1.054	0.037	0.039	
20450	829.0	1RB	Left Tilt	23.77	24.00	-2.41	1.054	0.026	0.027	
20450	829.0	1RB	Right Cheek	23.77	24.00	1.65	1.054	<b>0.069</b>	<b>0.073</b>	<b>Plot 5</b>
20450	829.0	1RB	Right Tilt	23.77	24.00	-1.54	1.054	0.040	0.042	
20450	829.0	50%RB	Left Cheek	22.74	23.00	2.13	1.062	0.036	0.038	
20450	829.0	50%RB	Left Tilt	22.74	23.00	-1.05	1.062	0.022	0.023	
20450	829.0	50%RB	Right Cheek	22.74	23.00	2.41	1.062	0.060	0.064	
20450	829.0	50%RB	Right Tilt	22.74	23.00	-2.84	1.062	0.033	0.035	
<i>measured / reported SAR numbers - Body (hotspot open, distance 10mm) &lt;SIM2&gt;</i>										
20450	829.0	1RB	Front	23.77	24.00	1.96	1.054	0.160	0.169	
20450	829.0	1RB	Rear	23.77	24.00	0.82	1.054	<b>0.201</b>	<b>0.212</b>	<b>Plot 6</b>
20450	829.0	1RB	Left	23.77	24.00	-1.54	1.054	0.076	0.080	
20450	829.0	1RB	Right	23.77	24.00	-0.61	1.054	0.050	0.053	
20450	829.0	1RB	Bottom	23.77	24.00	2.64	1.054	0.101	0.106	
20450	829.0	50%RB	Front	22.74	23.00	2.13	1.062	0.086	0.091	
20450	829.0	50%RB	Rear	22.74	23.00	2.97	1.062	0.193	0.205	
20450	829.0	50%RB	Left	22.74	23.00	0.60	1.062	0.045	0.048	
20450	829.0	50%RB	Right	22.74	23.00	-2.84	1.062	0.039	0.041	
20450	829.0	50%RB	Bottom	22.74	23.00	0.05	1.062	0.082	0.087	

### SAR Values [WIFI2.4G]

Ch.	Freq. (MHz)	Service	Test Position	Conducted Power (dBm)	Maximum Allowed Power (dBm)	Power Drift (%)	Scaling Factor	SAR <sub>1-g</sub> results(W/kg)		Graph Results
								Measured	Reported	
<i>measured / reported SAR numbers - Head</i>										
6	2437.0	DSSS	Left Cheek	10.64	11.00	-0.24	1.086	<b>0.402</b>	<b>0.437</b>	<b>Plot 7</b>
6	2437.0	DSSS	Left Tilt	10.64	11.00	2.11	1.086	0.179	0.194	
6	2437.0	DSSS	Right Cheek	10.64	11.00	0.17	1.086	0.261	0.284	
6	2437.0	DSSS	Right Tilt	10.64	11.00	1.79	1.086	0.151	0.164	
<i>measured / reported SAR numbers - Body (hotspot open, distance 10mm)</i>										
6	2437.0	DSSS	Front	10.64	11.00	-4.92	1.086	<b>0.227</b>	<b>0.247</b>	<b>Plot 8</b>
6	2437.0	DSSS	Rear	10.64	11.00	-0.47	1.086	0.213	0.231	
6	2437.0	DSSS	Right	10.64	11.00	1.75	1.086	0.061	0.066	
6	2437.0	DSSS	Top	10.64	11.00	0.64	1.086	0.085	0.092	

Remark:

- The value with blue color is the maximum SAR Value of each test band.
- Per FCC KDB Publication 447498 D01, if the reported (scaled) SAR measured at the middle channel or highest output power channel for each test configuration is  $\leq 0.8$  W/kg then testing at the other channels is optional for such test configuration(s).

#### 4.4.2 Standalone SAR Test Exclusion Considerations and Estimated SAR

Per KDB447498 requires when the standalone SAR test exclusion of section 4.3.1 is applied to an antenna that transmits simultaneously with other antennas, the standalone SAR must be estimated according to the following to determine simultaneous transmission SAR test exclusion;

• (max. power of channel, including tune-up tolerance, mW)/(min. test separation distance, mm) • [ $\sqrt{f(\text{GHz})}$ ]/x  
W/kg for test separation distances  $\leq 50$  mm;

where x = 7.5 for 1-g SAR, and x = 18.75 for 10-g SAR.

• 0.4 W/kg for 1-g SAR and 1.0 W/kg for 10-g SAR, when the test separation distances is > 50 mm

Per FCC KD B447498 D01, simultaneous transmission SAR test exclusion may be applied when the sum of the 1-g SAR for all the transmitting antenna in a specific a physical test configuration is  $\leq 1.6$  W/Kg. When the sum is greater than the SAR limit, SAR test exclusion is determined by the SAR to peak location separation ratio.

$$\text{Ratio} = \frac{(\text{SAR}_1 + \text{SAR}_2)^{1.5}}{(\text{peak location separation, mm})} < 0.04$$

Estimated stand alone SAR					
Communication system	Frequency (MHz)	Configuration	Maximum Power (dBm)	Separation Distance (mm)	Estimated SAR <sub>1-g</sub> (W/kg)
Bluetooth*	2450	Head	1.00	5	0.053
Bluetooth*	2450	Hotspot	1.00	10	0.026
Bluetooth*	2450	Body-worn	1.00	10	0.026

Remark:

1. Bluetooth\*- Including Lower power Bluetooth
2. Maximum average power including tune-up tolerance;
3. When the minimum test separation distance is < 5 mm, a distance of 5 mm is applied to determine SAR test exclusion
4. Body as body use distance is 10mm from manufacturer declaration of user manual

#### 4.3. Simultaneous TX SAR Considerations

##### 4.5.1 Introduction

The following procedures adopted from "FCC SAR Considerations for Cell Phones with Multiple Transmitters" are applicable to handsets with built-in unlicensed transmitters such as 802.11 a/b/g/n and Bluetooth devices which may simultaneously transmit with the licensed transmitter.

For the DUT, the BT and WiFi modules sharing same antenna, GSM and LTE modules sharing a single antenna; BT/WLAN and GSM /LTE can simultaneous transmit;

Application Simultaneous Transmission information:

Air-Interface	Band (MHz)	Type	Simultaneous Transmissions	Voice over Digital Transport(Data)
GSM	850	VO	Yes, WLAN or BT/BLE	N/A
	1900	VO		
	GPRS, EGPRS	DT	Yes, WLAN or BT/BLE	N/A
LTE	Band5	DT	Yes, WLAN or BT/BLE	N/A
WLAN	2450	DT	Yes, GSM, GPRS, UMTS, LTE	Yes
BT/BLE	2450	DT	Yes, GSM, GPRS, UMTS, LTE	N/A

Note: VO-Voice Service only; DT-Digital Transport

Note:

BT and WLAN can be active at the same time, but only with interleaving of packages switched on board level. That means that they don't transmit at the same time.

BLE-Bluetooth low energy;

BT- Classical Bluetooth;

## 4.5.2 Evaluation of Simultaneous SAR

### Head Exposure Conditions

#### Simultaneous transmission SAR for WiFi and GSM

Test Position	GSM850 Reported SAR <sub>1-g</sub> (W/kg)	GSM1900 Reported SAR <sub>1-g</sub> (W/kg)	WiFi2.4G Reported SAR <sub>1-g</sub> (W/kg)	MAX. $\Sigma$ SAR <sub>1-g</sub> (W/kg)	SAR <sub>1-g</sub> Limit (W/kg)	Peak location separation ratio	Simut Meas. Required
Left Cheek	0.039	<b>0.190</b>	<b>0.437</b>	<b>0.627</b>	1.6	no	no
Left Tilt	0.032	0.093	0.194	0.287	1.6	no	no
Right Cheek	<b>0.075</b>	0.123	0.284	0.407	1.6	no	no
Right Tilt	0.054	0.076	0.164	0.240	1.6	no	no

#### Simultaneous transmission SAR for WiFi and LTE

Test Position	LTE Band5 Reported SAR <sub>1-g</sub> (W/kg)	WiFi2.4G Reported SAR <sub>1-g</sub> (W/kg)	MAX. $\Sigma$ SAR <sub>1-g</sub> (W/kg)	SAR <sub>1-g</sub> Limit (W/kg)	Peak location separation ratio	Simut Meas. Required
Left Cheek	0.039	<b>0.437</b>	<b>0.476</b>	1.6	no	no
Left Tilt	0.027	0.194	0.221	1.6	no	no
Right Cheek	<b>0.073</b>	0.284	0.357	1.6	no	no
Right Tilt	0.042	0.164	0.206	1.6	no	no

#### Simultaneous transmission SAR for BT and GSM

Test Position	GSM850 Reported SAR <sub>1-g</sub> (W/kg)	GSM1900 Reported SAR <sub>1-g</sub> (W/kg)	BT Estimated SAR <sub>1-g</sub> (W/kg)	MAX. $\Sigma$ SAR <sub>1-g</sub> (W/kg)	SAR <sub>1-g</sub> Limit (W/kg)	Peak location separation ratio	Simut Meas. Required
Left Cheek	0.039	<b>0.190</b>	0.053	<b>0.243</b>	1.6	no	no
LeftTilt	0.032	0.093	0.053	0.146	1.6	no	no
Right Cheek	<b>0.075</b>	0.123	0.053	0.176	1.6	no	no
Right Tilt	0.054	0.076	0.053	0.129	1.6	no	no

#### Simultaneous transmission SAR for BT and LTE

Test Position	LTE Band5 Reported SAR <sub>1-g</sub> (W/kg)	BT Reported SAR <sub>1-g</sub> (W/kg)	MAX. $\Sigma$ SAR <sub>1-g</sub> (W/kg)	SAR <sub>1-g</sub> Limit (W/kg)	Peak location separation ratio	Simut Meas. Required
Left Cheek	0.039	0.053	0.092	1.6	no	no
Left Tilt	0.027	0.053	0.080	1.6	no	no
Right Cheek	<b>0.073</b>	0.053	0.126	1.6	no	no
Right Tilt	0.042	0.053	<b>0.095</b>	1.6	no	no

### Body Hotspot Exposure Conditions

#### Simultaneous transmission SAR for WiFi and GSM

Test Position	GSM850 Reported SAR <sub>1-g</sub> (W/kg)	GSM1900 Reported SAR <sub>1-g</sub> (W/kg)	WiFi2.4G Reported SAR <sub>1-g</sub> (W/kg)	MAX. $\Sigma$ SAR <sub>1-g</sub> (W/kg)	SAR <sub>1-g</sub> Limit (W/kg)	Peak location separation ratio	Simut Meas. Required
Front	0.118	<b>0.349</b>	<b>0.247</b>	<b>0.596</b>	1.6	no	no
Rear	<b>0.177</b>	0.282	0.231	0.513	1.6	no	no
Left	0.066	0.087	/	0.087	1.6	no	no
Right	0.052	0.053	0.066	0.119	1.6	no	no
Bottom	0.074	0.111	/	0.111	1.6	no	no
Top	/	/	0.092	0.092	1.6	no	no

**Simultaneous transmission SAR for WiFi and LTE**

Test Position	LTE Band5 Reported SAR <sub>1-g</sub> (W/kg)	WiFi2.4G Reported SAR <sub>1-g</sub> (W/kg)	MAX. $\Sigma$ SAR <sub>1-g</sub> (W/kg)	SAR <sub>1-g</sub> Limit (W/kg)	Peak location separation ratio	Simut Meas. Required
Front	0.169	<b>0.247</b>	0.416	1.6	no	no
Rear	<b>0.212</b>	0.231	<b>0.443</b>	1.6	no	no
Left	0.080	/	0.080	1.6	no	no
Right	0.053	0.066	0.119	1.6	no	no
Bottom	0.106	/	0.106	1.6	no	no
Top	/	0.092	0.092	1.6	no	no

**Simultaneous transmission SAR for BT and GSM**

Test Position	GSM850 Reported SAR <sub>1-g</sub> (W/kg)	GSM1900 Reported SAR <sub>1-g</sub> (W/kg)	BT Estimated SAR <sub>1-g</sub> (W/kg)	MAX. $\Sigma$ SAR <sub>1-g</sub> (W/kg)	SAR <sub>1-g</sub> Limit (W/kg)	Peak location separation ratio	Simut Meas. Required
Front	0.118	<b>0.349</b>	0.026	<b>0.375</b>	1.6	no	no
Rear	<b>0.177</b>	0.282	0.026	0.308	1.6	no	no
Left	0.066	0.087	/	0.087	1.6	no	no
Right	0.052	0.053	0.026	0.079	1.6	no	no
Bottom	0.074	0.111	/	0.111	1.6	no	no
Top	/	/	0.026	0.026	1.6	no	no

**Simultaneous transmission SAR for BT and LTE**

Test Position	LTE Band5 Reported SAR <sub>1-g</sub> (W/kg)	BT Estimated SAR <sub>1-g</sub> (W/kg)	MAX. $\Sigma$ SAR <sub>1-g</sub> (W/kg)	SAR <sub>1-g</sub> Limit (W/kg)	Peak location separation ratio	Simut Meas. Required
Front	0.169	0.026	0.195	1.6	no	no
Rear	<b>0.212</b>	0.026	<b>0.238</b>	1.6	no	no
Left	0.080	/	0.080	1.6	no	no
Right	0.053	0.026	0.079	1.6	no	no
Bottom	0.106	/	0.106	1.6	no	no
Top	/	0.026	0.026	1.6	no	no

Note:

1. The WiFi and BT share same antenna, so cannot transmit at same time.
2. The value with **block** color is the maximum values of standalone
3. The value with blue color is the maximum values of  $\Sigma$ SAR<sub>1-g</sub>

**4.4. SAR Measurement Variability**

According to KDB865664, Repeated measurements are required only when the measured SAR is  $\geq 0.80$  W/kg. If the measured SAR value of the initial repeated measurement is  $< 1.45$  W/kg with  $\leq 20\%$  variation, only one repeated measurement is required to reaffirm that the results are not expected to have substantial variations, which may introduce significant compliance concerns. A second repeated measurement is required only if the measured result for the initial repeated measurement is within 10% of the SAR limit and vary by more than 20%, which are often related to device and measurement setup difficulties. The following procedures are applied to determine if repeated measurements are required. The same procedures should be adapted for measurements according to extremity and occupational exposure limits by applying a factor of 2.5 for extremity exposure and a factor of 5 for occupational exposure to the corresponding SAR thresholds.<sup>19</sup> The repeated measurement results must be clearly identified in the SAR report. All measured SAR, including the repeated results, must be considered to determine compliance and for reporting according to KDB 690783. Repeated measurement is not required when the original highest measured SAR is  $< 0.80$  W/kg; steps 2) through 4) do not apply.

- 1) When the original highest measured SAR is  $\geq 0.80$  W/kg, repeat that measurement once.



- 2) Perform a second repeated measurement only if the ratio of largest to smallest SAR for the original and first repeated measurements is  $> 1.20$  or when the original or repeated measurement is  $\geq 1.45$  W/kg ( $\sim 10\%$  from the 1-g SAR limit).
- 3) Perform a third repeated measurement only if the original, first or second repeated measurement is  $\geq 1.5$  W/kg and the ratio of largest to smallest SAR for the original, first and second repeated measurements is  $> 1.20$ .
- 4) Perform a third repeated measurement only if the original, first or second repeated measurement is  $\geq 1.5$  W/kg and the ratio of largest to smallest SAR for the original, first and second repeated measurements is  $> 1.20$ .

Frequency Band (MHz)	Air Interface	RF Exposure Configuration	Test Position	Repeated SAR (yes/no)	Highest Measured SAR <sub>1-g</sub> (W/kg)	First Repeated	
						Measured SAR <sub>1-g</sub> (W/kg)	Largest to Smallest SAR Ratio
850	GSM850	Standalone	Body-Rear	no	0.170	n/a	n/a
	LTE Band 5	Standalone	Body-Rear	no	0.201	n/a	n/a
1900	GSM1900	Standalone	Body-Rear	no	0.333	n/a	n/a
2450	2.4GWLAN	Standalone	Cheek-Left	no	0.402	n/a	n/a

**Remark:**

1. Second Repeated Measurement is not required since the ratio of the largest to smallest SAR for the original and first repeated measurement is not  $> 1.20$  or 3 (1-g or 10-g respectively)

#### 4.5. General description of test procedures

1. The DUT is tested using CMU 200 communications testers as controller unit to set test channels and maximum output power to the DUT, as well as for measuring the conducted peak power.
2. Test positions as described in the tables above are in accordance with the specified test standard.
3. Tests in body position were performed in that configuration, which generates the highest time based averaged output power (see conducted power results).
4. Tests in head position with GSM were performed in voice mode with 1 timeslot unless GPRS/EGPRS/DTM function allows parallel voice and data traffic on 2 or more timeslots.
5. UMTS was tested in RMC mode with 12.2 kbit/s and TPC bits set to 'all 1'.
6. WiFi was tested in 802.11b/g/n mode with 1 Mbit/s and 6 Mbit/s. According to KDB 248227 the SAR testing for 802.11g/n is not required since When the highest reported SAR for DSSS is adjusted by the ratio of OFDM to DSSS specified maximum output power and the adjusted SAR is  $\leq 1.2$  W/kg.
7. Required WiFi test channels were selected according to KDB 248227
8. According to FCC KDB pub 248227 D01, When there are multiple test channels with the same measured maximum output power, the channel closest to mid-band frequency is selected for SAR measurement and when there are multiple test channels with the same measured maximum output power and equal separation from mid-band frequency; for example, high and low channels or two mid-band channels, the higher frequency (number) channel is selected for SAR measurement.
9. According to FCC KDB pub 941225 D06 this device has been tested with 10 mm distance to the phantom for operation in WiFi hot spot mode.
10. Per FCC KDB pub 941225 D06 the edges with antennas within 2.5 cm are required to be evaluated for SAR to cover WiFi hot spot function.
11. According to IEEE 1528 the SAR test shall be performed at middle channel. Testing of top and bottom channel is optional.
12. According to KDB 447498 D01 testing of other required channels within the operating mode of a frequency band is not required when the reported 1-g or 10-g SAR for the mid-band or highest output power channel is:
  - $\leq 0.8$  W/kg or 2.0 W/kg, for 1-g or 10-g respectively, when the transmission band is  $\leq 100$  MHz
  - $\leq 0.6$  W/kg or 1.5 W/kg, for 1-g or 10-g respectively, when the transmission band is between 100 MHz and 200 MHz
  - $\leq 0.4$  W/kg or 1.0 W/kg, for 1-g or 10-g respectively, when the transmission band is  $\geq 200$  MHz
13. IEEE 1528-2003 require the middle channel to be tested first. This generally applies to wireless devices that are designed to operate in technologies with tight tolerances for maximum output power variations across channels in the band.
14. Per KDB648474 D04 require when the reported SAR for a body-worn accessory, measured without a headset connected to the handset, is  $< 1.2$  W/kg.
15. Per KDB648474 D04 require when the separation distance required for body-worn accessory testing is larger than or equal to that tested for hotspot mode, using the same wireless mode test configuration for voice and data, such as UMTS, LTE and Wi-Fi, and for the same surface of the phone, the hotspot mode

SAR data may be used to support body-worn accessory SAR compliance for that particular configuration (surface)

16. 10-g extremity SAR is required only for the surfaces and edges with hotspot mode 1-g SAR > 1.2 W/kg.
17. Per KDB648474 D04 require for phablet SAR test considerations. For Smart Phones with a display diagonal dimension > 15.0 cm or an overall diagonal dimension > 16.0 cm, When hotspot mode applies, 10-g extremity SAR is required only for the surfaces and edges with hotspot mode 1-g reported SAR > 1.2 W/kg.
18. 10-g extremity SAR is required only for the surfaces and edges with hotspot mode 1-g SAR > 1.2 W/kg.

#### **4.6. Measurement Uncertainty (450MHz-6GHz)**

Not required as SAR measurement uncertainty analysis is required in SAR reports only when the highest measured SAR in a frequency band is  $\geq 1.5$  W/kg for 1-g SAR according to KDB865664D01.

### 4.7. System Check Results

Test mode:835MHz(Head)  
 Product Description:Validation  
 Model:Dipole SID835  
 E-Field Probe:SSE2(SN 31/17 EPGO324)  
 Test Date:March 20, 2019

Medium(liquid type)	HSL_850
Frequency (MHz)	835.0000
Relative permittivity (real part)	42.31
Conductivity (S/m)	0.86
Input power	100mW
Crest Factor	1.0
Conversion Factor	1.55
Variation (%)	-1.460000
SAR 10g (W/Kg)	0.631560
SAR 1g (W/Kg)	0.912164

#### SURFACE SAR

#### VOLUME SAR

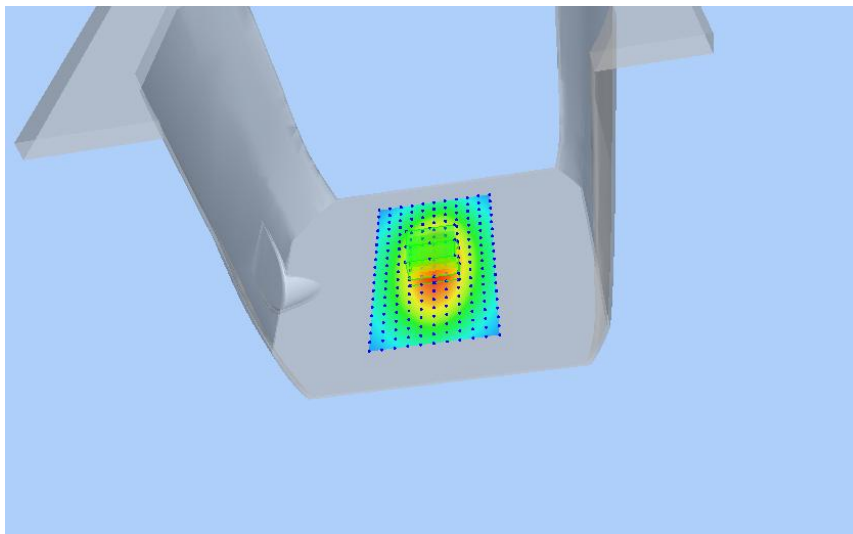
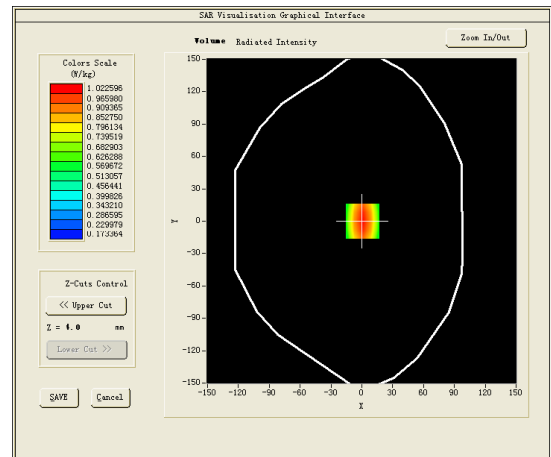
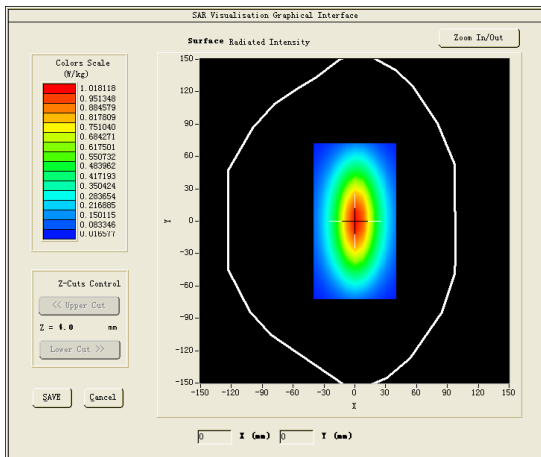



Test mode:835MHz(Body)  
 Product Description:Validation  
 Model:Dipole SID835  
 E-Field Probe:SSE2(SN 31/17 EPGO324)  
 Test Date: March 21, 2019

Medium(liquid type)	MSL_850
Frequency (MHz)	835.0000
Relative permittivity (real part)	54.28
Conductivity (S/m)	0.95
Input power	100mW
Crest Factor	1.0
Conversion Factor	1.59
Variation (%)	0.440000
SAR 10g (W/Kg)	0.631046
SAR 1g (W/Kg)	0.970397

**SURFACE SAR**

**VOLUME SAR**

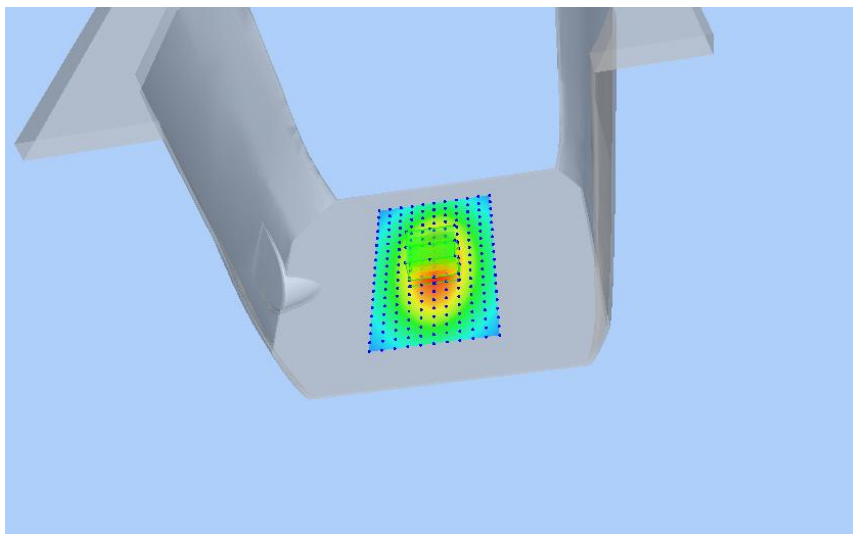
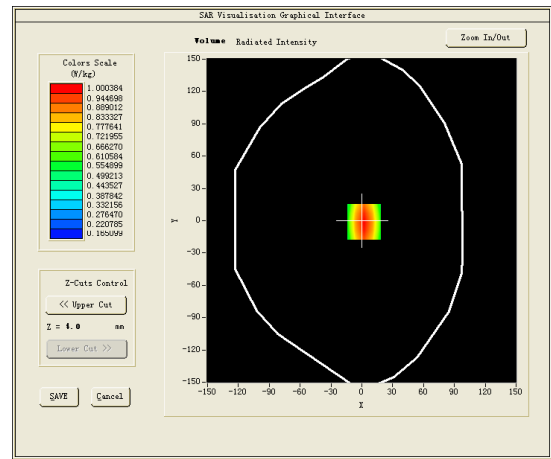
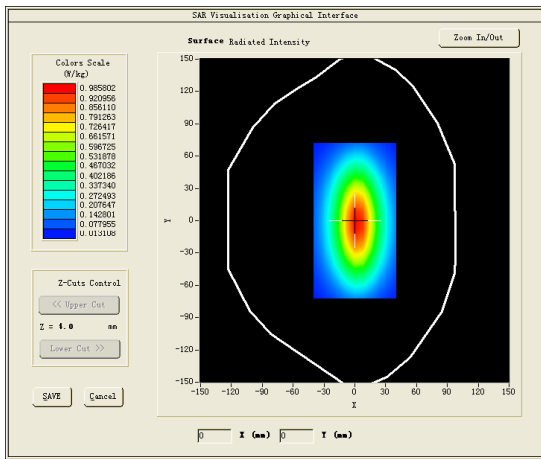

Test mode:1900MHz(Head)  
 Product Description:Validation  
 Model :Dipole SID1900  
 E-Field Probe: SSE2(SN 31/17 EPGO324)  
 Test Date: March 25, 2019

Medium(liquid type)	HSL_1900
Frequency (MHz)	1900.0000
Relative permittivity (real part)	41.02
Conductivity (S/m)	1.36
Input power	100mW
Crest Factor	1.0
Conversion Factor	1.86
Variation (%)	-2.110000
SAR 10g (W/Kg)	2.003978
SAR 1g (W/Kg)	3.913429

**SURFACE SAR**

**VOLUME SAR**

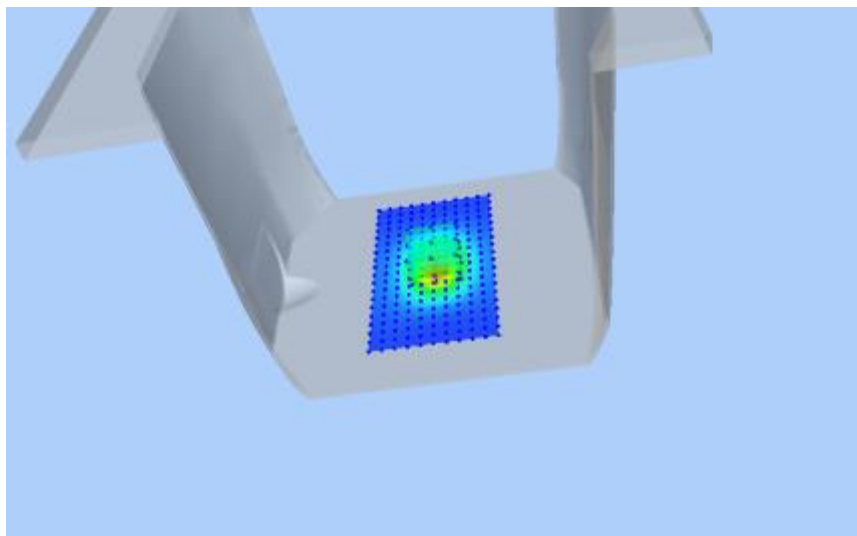
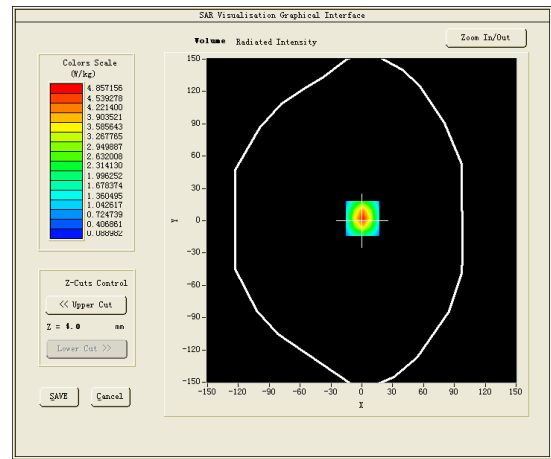
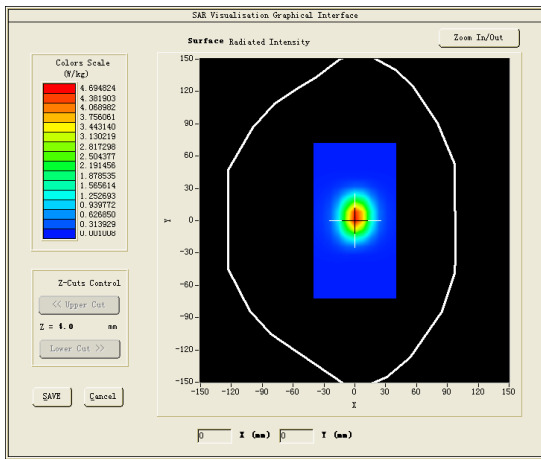

Test mode:1900MHz(Body)  
 Product Description:Validation  
 Model :Dipole SID1900  
 E-Field Probe: SSE2(SN 31/17 EPGO324)  
 Test Date: April 01, 2019

Medium(liquid type)	MSL_1900
Frequency (MHz)	1900.0000
Relative permittivity (real part)	52.06
Conductivity (S/m)	1.56
Input power	100mW
Crest Factor	1.0
Conversion Factor	1.93
Variation (%)	3.460000
SAR 10g (W/Kg)	2.113964
SAR 1g (W/Kg)	4.271420

**SURFACE SAR**

**VOLUME SAR**

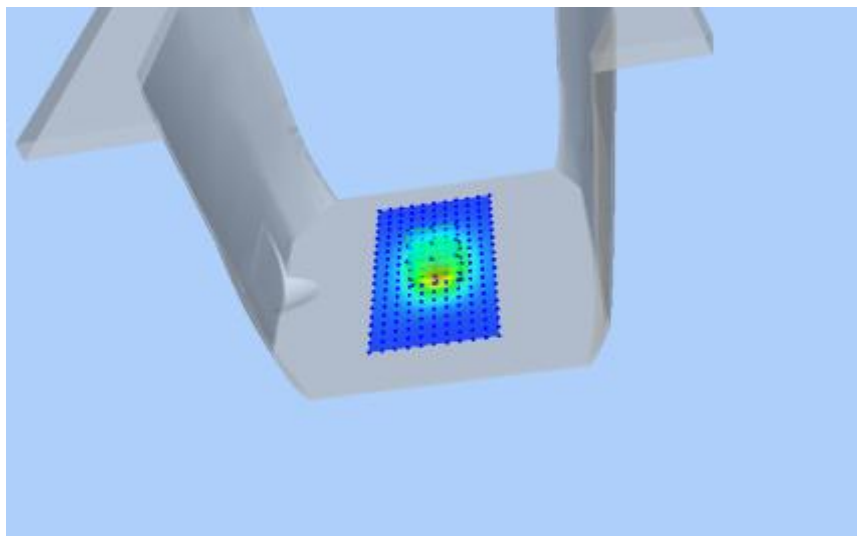
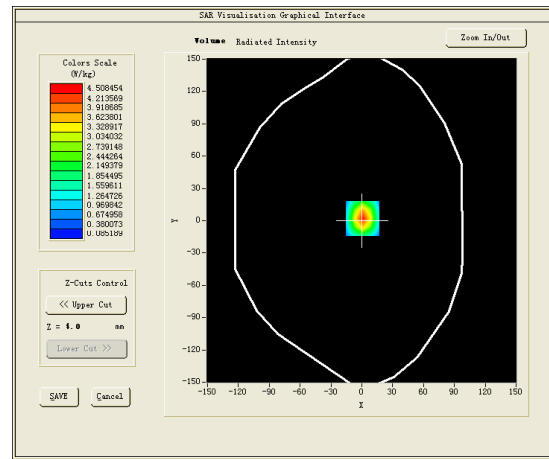
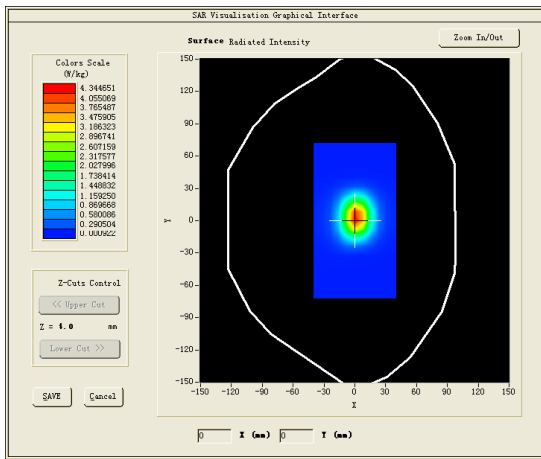

Test mode:2450MHz(Head)  
 Product Description:Validation  
 Model:Dipole SID2450  
 E-Field Probe:SSE2(SN 31/17 EPGO324)  
 Test Date: April 04, 2019

Medium(liquid type)	HSL_2450
Frequency (MHz)	2450.0000
Relative permittivity (real part)	39.63
Conductivity (S/m)	1.79
Input power	100mW
Crest Factor	1.0
Conversion Factor	1.91
Variation (%)	-2.160000
SAR 10g (W/Kg)	2.386975
SAR 1g (W/Kg)	5.252169

**SURFACE SAR**

**VOLUME SAR**

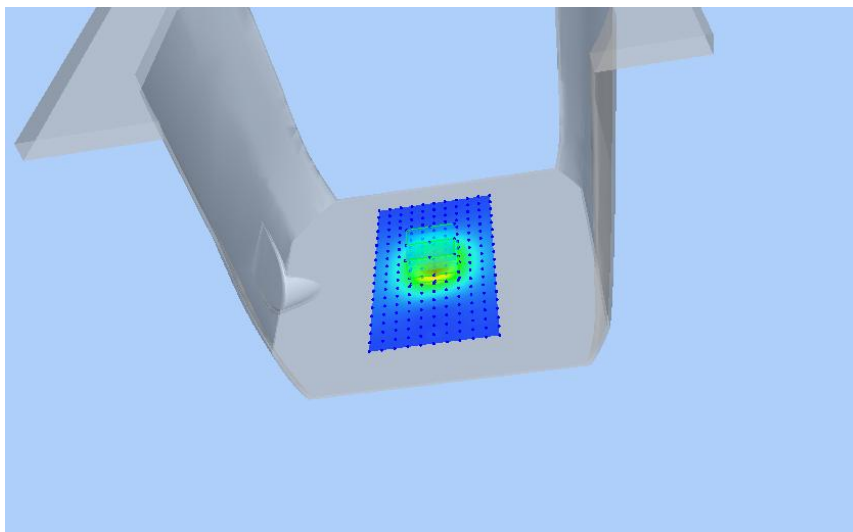
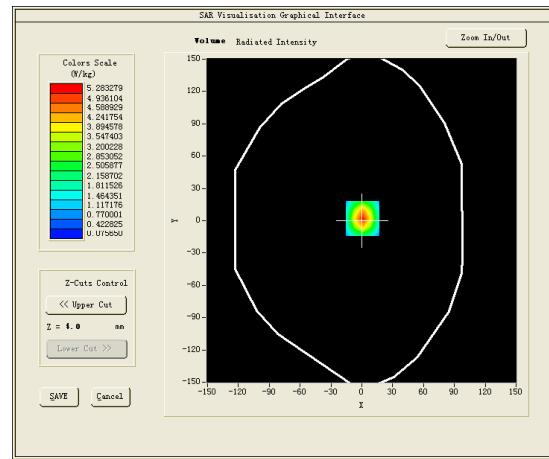
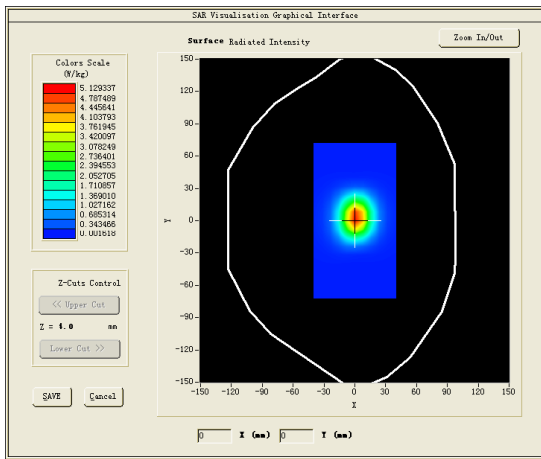

Test mode:2450MHz(Body)  
 Product Description:Validation  
 Model:Dipole SID2450  
 E-Field Probe:SSE2(SN 31/17 EPGO324)  
 Test Date: April 09, 2019

Medium(liquid type)	MSL_2450
Frequency (MHz)	2450.0000
Relative permittivity (real part)	51.62
Conductivity (S/m)	1.99
Input power	100mW
Crest Factor	1.0
Conversion Factor	1.95
Variation (%)	-1.430000
SAR 10g (W/Kg)	2.381436
SAR 1g (W/Kg)	5.240063

**SURFACE SAR**

**VOLUME SAR**

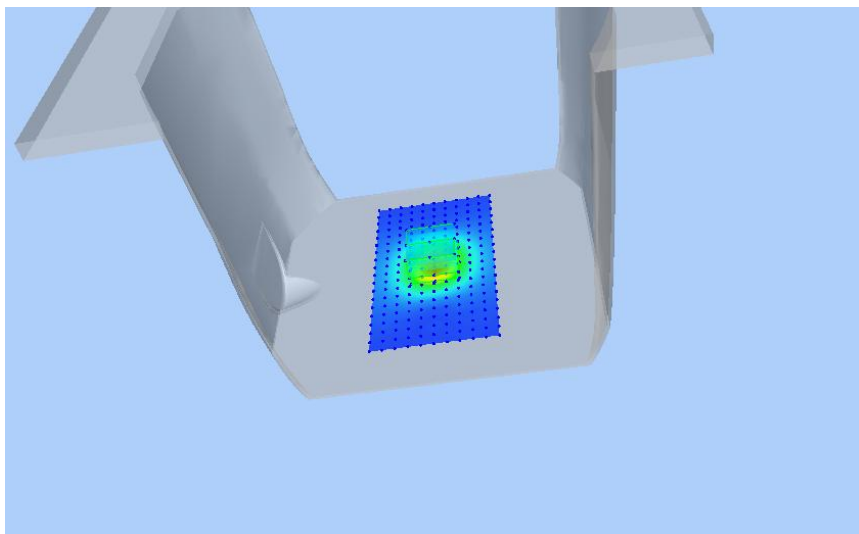
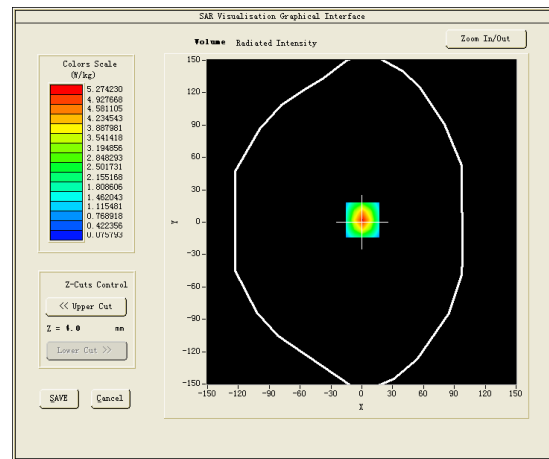
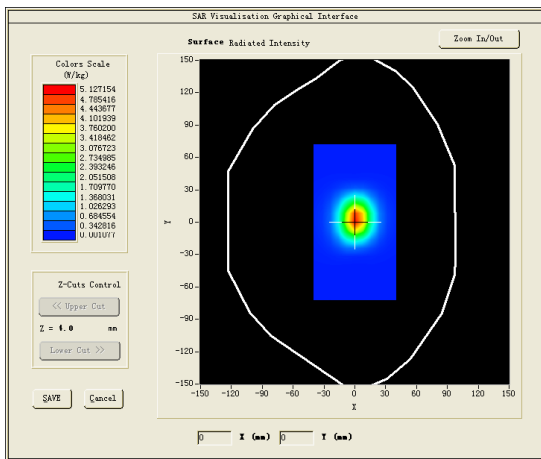

### 4.10 SAR Test Graph Results

SAR plots for the highest measured SAR in each exposure configuration, wireless mode and frequency band combination according to FCC KDB 865664 D02;

#1

Test Mode:GSM 850MHz,Middle channel(Head Right Cheek)

Product Description: Smart Phone

Model: ELUGA RAY 800

Test Date:March 20, 2019

Medium(liquid type)	HSL_850
Frequency (MHz)	836.6000
Relative permittivity (real part)	42.31
Conductivity (S/m)	0.86
E-Field Probe	SN 31/17 EPGO324
Crest Factor	8.0
Conversion Factor	1.55
Sensor	4mm
Area Scan	dx=8mm dy=8mm
Zoom Scan	5x5x7,dx=8mm dy=8mm dz=5mm
Variation (%)	0.300000
SAR 10g (W/Kg)	0.046616
SAR 1g (W/Kg)	0.067633

#### SURFACE SAR

#### VOLUME SAR

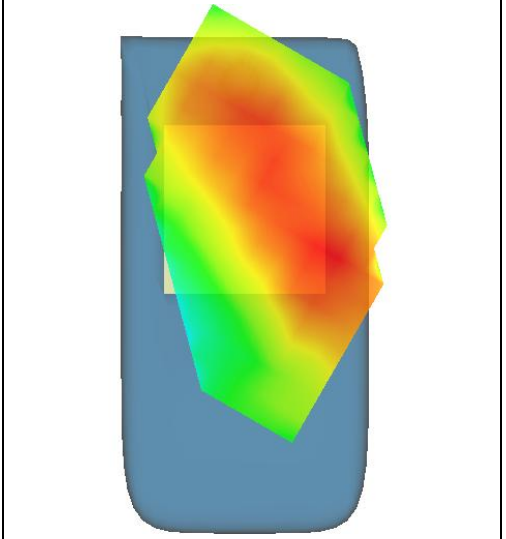
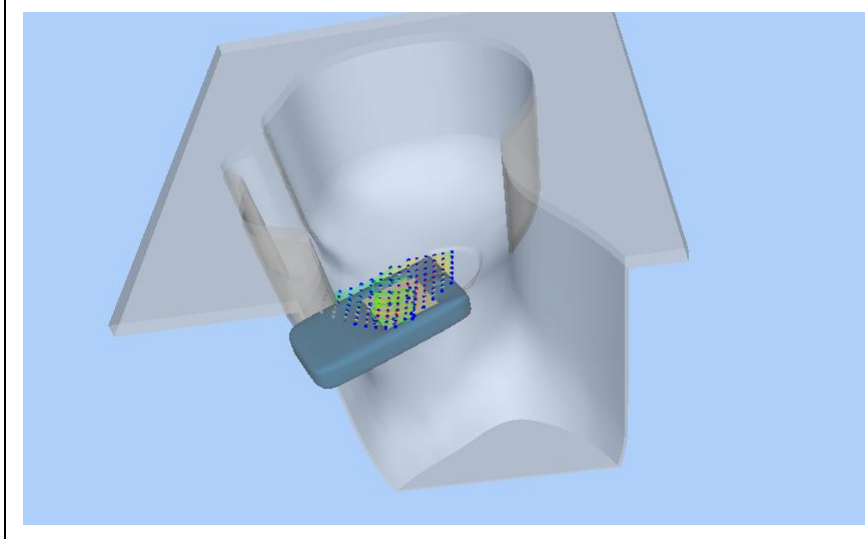
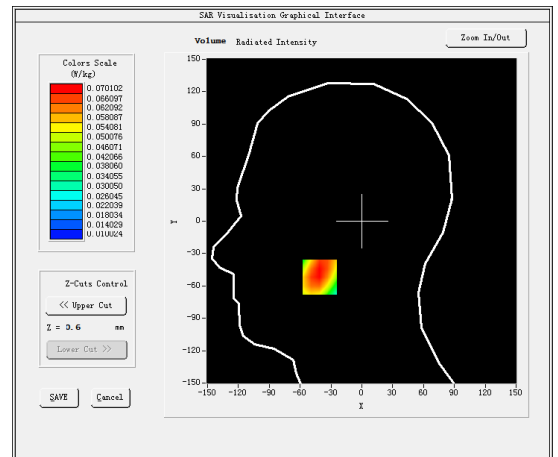
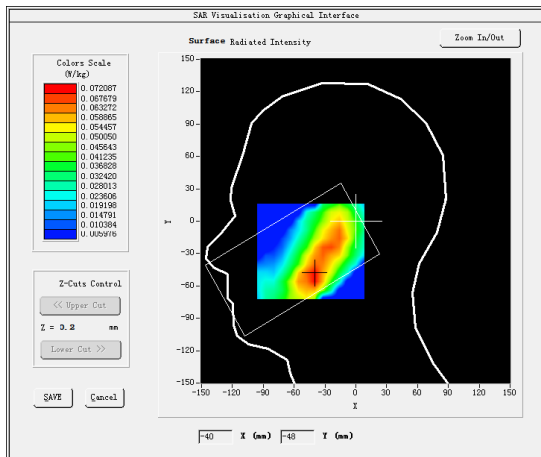

#2

Test Mode: Hotspot GSM850MHz,Middle channel(Body Rear Side)

Product Description: Smart Phone

Model: ELUGA RAY 800

Test Date: March 21, 2019

Medium(liquid type)	MSL_850
Frequency (MHz)	836.6000
Relative permittivity (real part)	54.28
Conductivity (S/m)	0.95
E-Field Probe	SN 31/17 EPG0324
Crest Factor	2.0
Conversion Factor	1.59
Sensor	4mm
Area Scan	dx=8mm dy=8mm
Zoom Scan	5x5x7,dx=8mm dy=8mm dz=5mm
Variation (%)	-4.900000
SAR 10g (W/Kg)	0.121881
SAR 1g (W/Kg)	0.169520
SURFACE SAR	VOLUME SAR

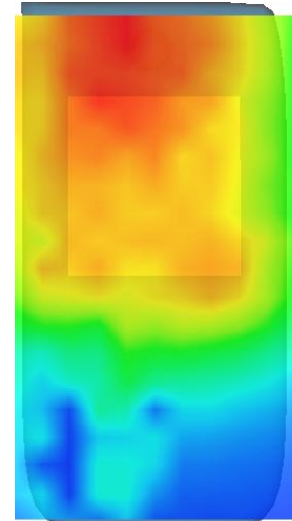
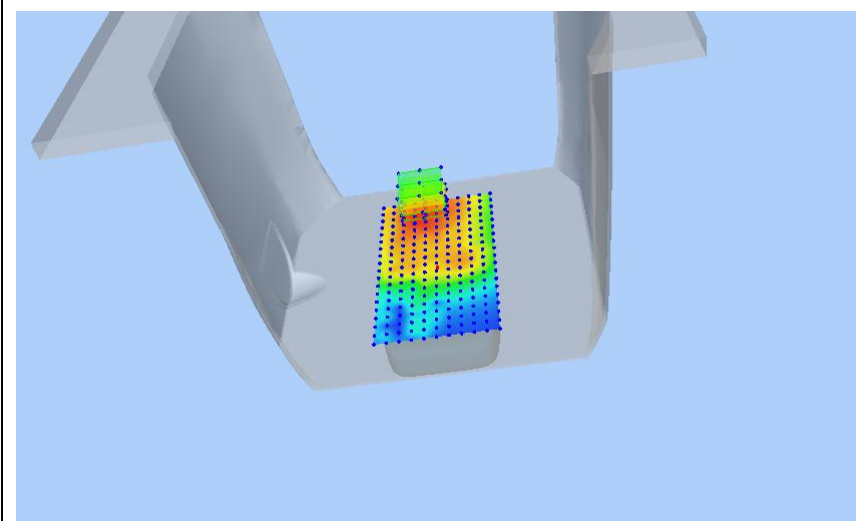
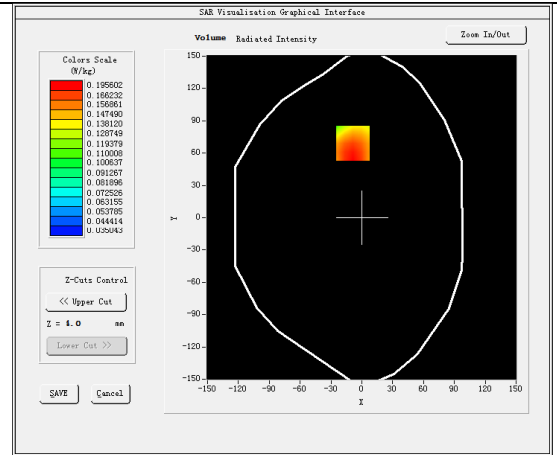
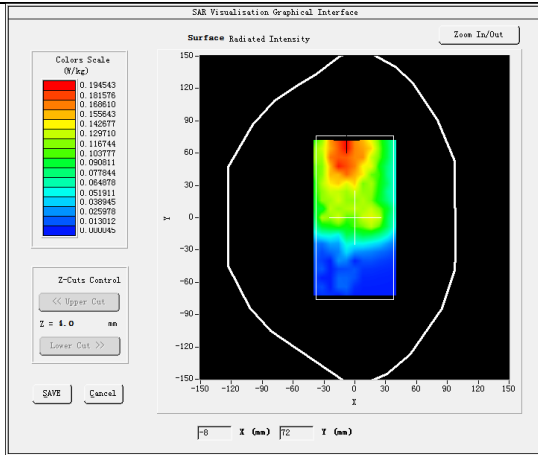

#3

Test Mode:GSM 1900MHz,Middle channel(Head Left Cheek)

Product Description: Smart Phone

Model: ELUGA RAY 800

Test Date: March 25, 2019

Medium(liquid type)	HSL_1900
Frequency (MHz)	188.0000
Relative permittivity (real part)	41.02
Conductivity (S/m)	1.36
E-Field Probe	SN 31/17 EPGO324
Crest Factor	8.0
Conversion Factor	1.86
Sensor	4mm
Area Scan	dx=8mm dy=8mm
Zoom Scan	5x5x7,dx=8mm dy=8mm dz=5mm
Variation (%)	-2.400000
SAR 10g (W/Kg)	0.110768
SAR 1g (W/Kg)	0.189268

**SURFACE SAR**

**VOLUME SAR**

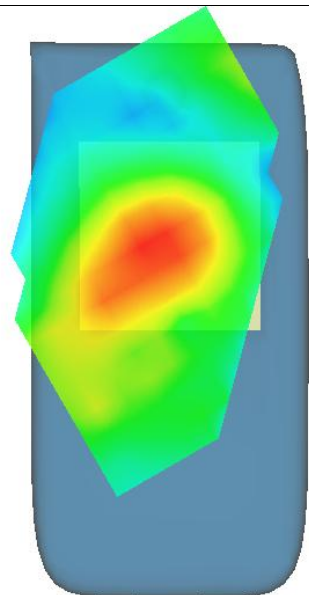
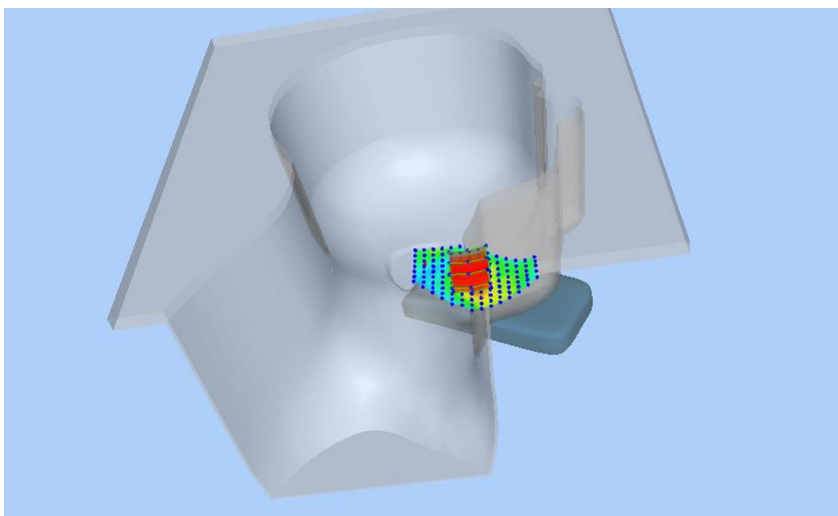
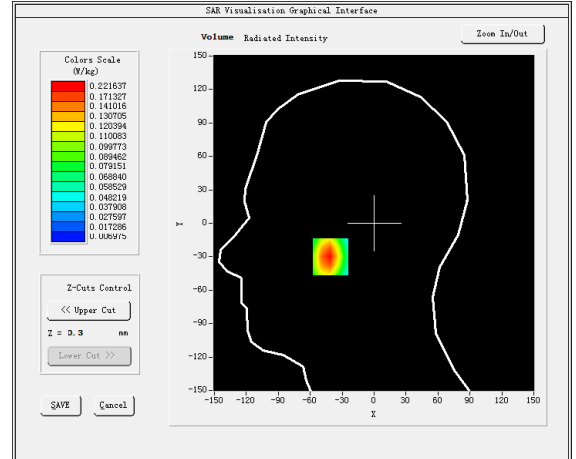
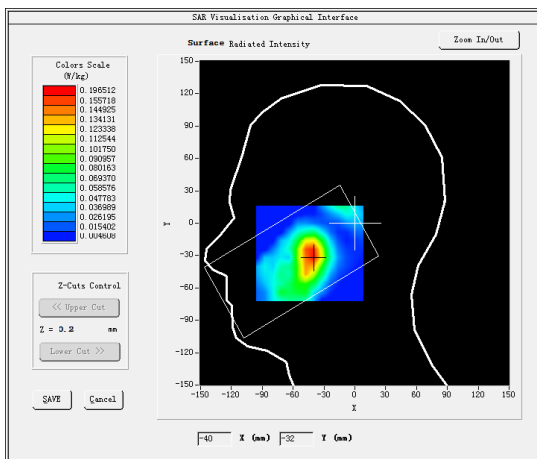



#4

Test Mode: Hotspot GPRS1900MHz,Middle channel(Body Front Side)

Product Description: Smart Phone

Model: ELUGA RAY 800

Test Date: April 01, 2019

Medium(liquid type)	MSL_1900
Frequency (MHz)	1880.0000
Relative permittivity (real part)	52.06
Conductivity (S/m)	1.56
E-Field Probe	SN 31/17 EPGO324
Crest Factor	2.0
Conversion Factor	1.93
Sensor	4mm
Area Scan	dx=8mm dy=8mm
Zoom Scan	5x5x7,dx=8mm dy=8mm dz=5mm
Variation (%)	0.020000
SAR 10g (W/Kg)	0.189734
SAR 1g (W/Kg)	0.332944
<b>SURFACE SAR</b>	<b>VOLUME SAR</b>

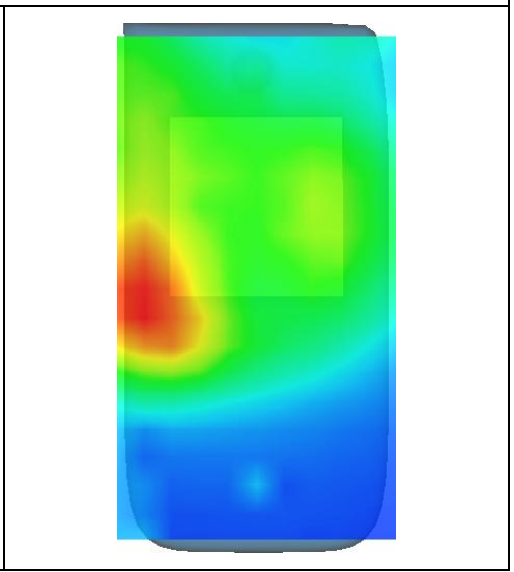
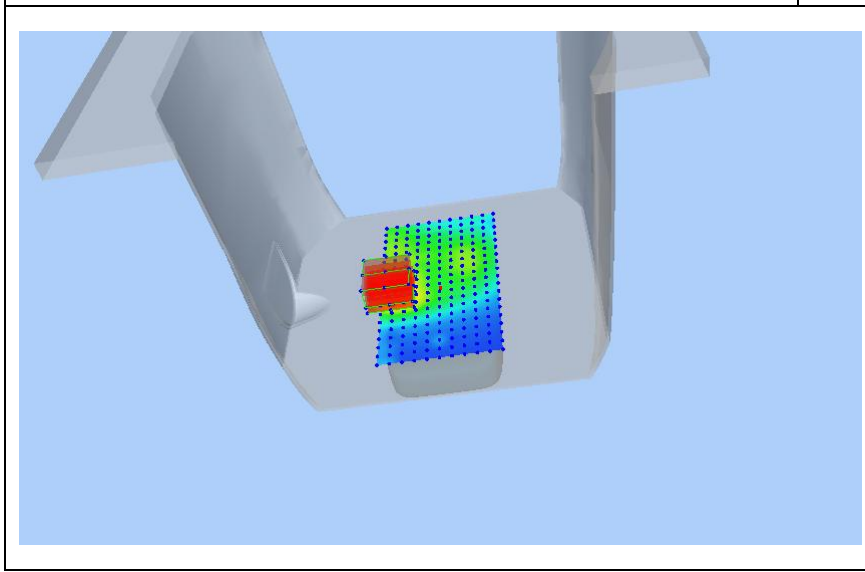
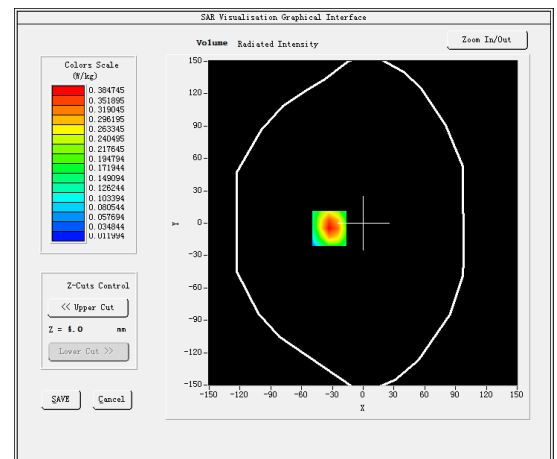
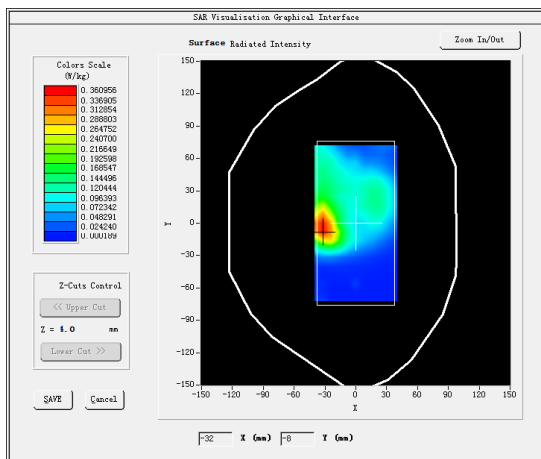

#5

Test Mode: LTE Band 5, 1RB, Low channel (Head Right Cheek)

Product Description: Smart Phone

Model: ELUGA RAY 800

Test Date: March 20, 2019

Medium (liquid type)	HSL_850
Frequency (MHz)	829.0000
Relative permittivity (real part)	42.31
Conductivity (S/m)	0.86
E-Field Probe	SN 31/17 EPGO324
Crest Factor	1.0
Conversion Factor	1.55
Sensor	4mm
Area Scan	dx=8mm dy=8mm
Zoom Scan	5x5x7, dx=8mm dy=8mm dz=5mm
Variation (%)	1.650000
SAR 10g (W/Kg)	0.049604
SAR 1g (W/Kg)	0.069343

**SURFACE SAR**

**VOLUME SAR**

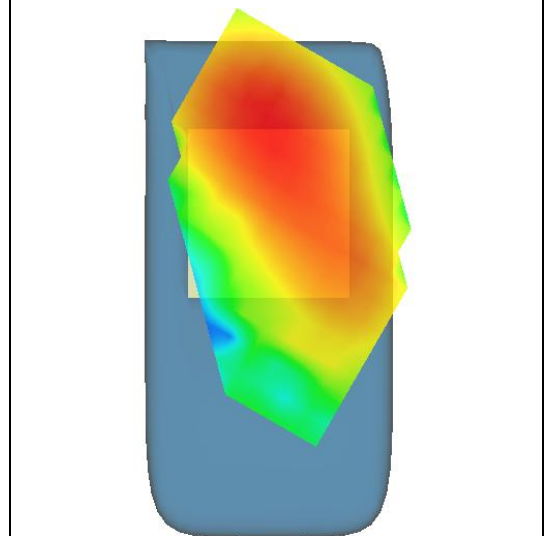
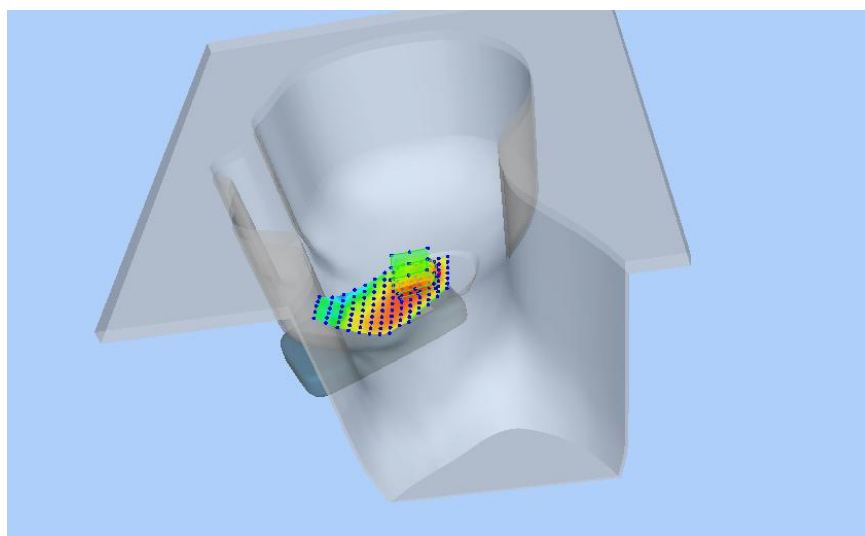
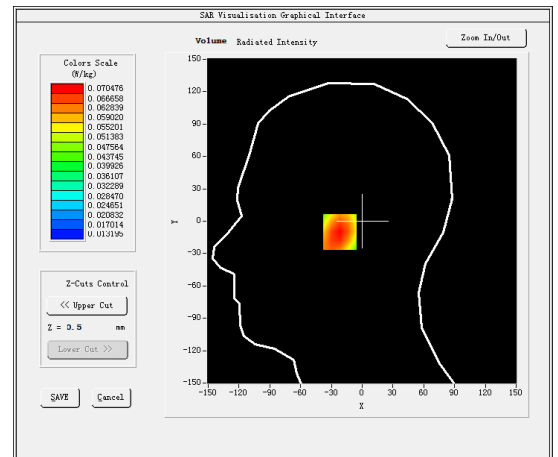
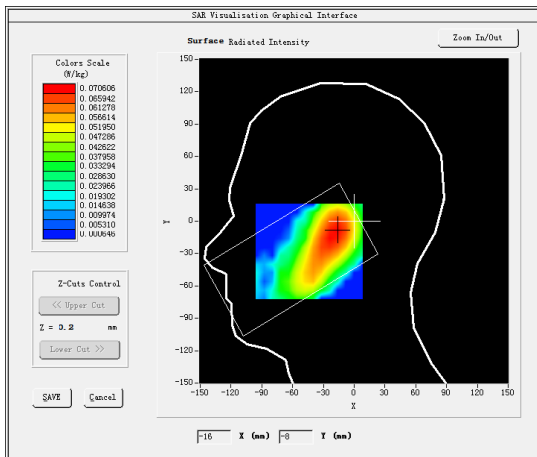

#6

Test Mode: Hotspot LTE Band 5, 1RB, Low channel (Body Rear Side)

Product Description: Smart Phone

Model: ELUGA RAY 800

Test Date: March 21, 2019

Medium(liquid type)	MSL_850
Frequency (MHz)	829.0000
Relative permittivity (real part)	54.28
Conductivity (S/m)	0.95
E-Field Probe	SN 31/17 EPGO324
Crest Factor	1.0
Conversion Factor	1.59
Sensor	4mm
Area Scan	dx=8mm dy=8mm
Zoom Scan	5x5x7, dx=8mm dy=8mm dz=5mm
Variation (%)	0.820000
SAR 10g (W/Kg)	0.146347
SAR 1g (W/Kg)	0.201222

**SURFACE SAR**

**VOLUME SAR**

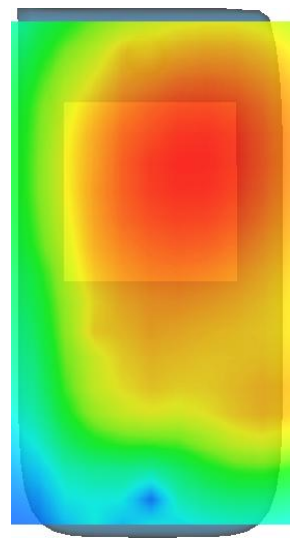
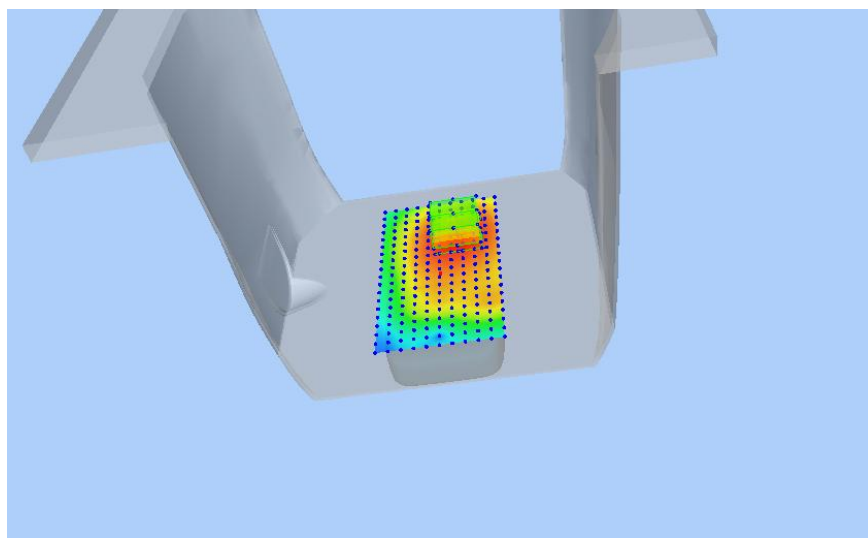
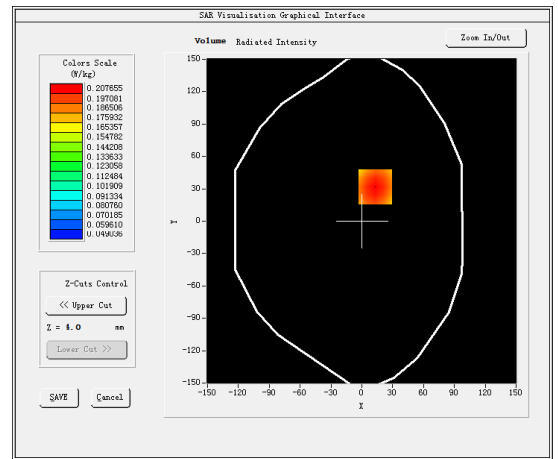
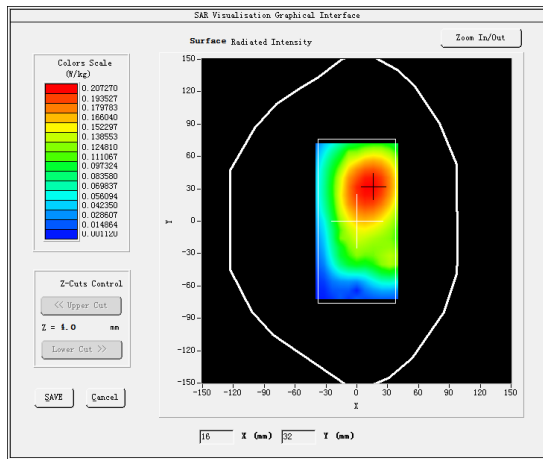

#7

Test Mode:802.11b(WiFi2.4G),Middle channel (Head Left Cheek)

Product Description: Smart Phone

Model: ELUGA RAY 800

Test Date: April 04, 2019

Medium(liquid type)	HSL_2450
Frequency (MHz)	2437.0000
Relative permittivity (real part)	39.63
Conductivity (S/m)	1.79
E-Field Probe	SN 31/17 EPGO324
Crest Factor	1.0
Conversion Factor	1.91
Sensor	4mm
Area Scan	dx=8mm dy=8mm
Zoom Scan	5x5x7,dx=8mm dy=8mm dz=5mm
Variation (%)	-0.240000
SAR 10g (W/Kg)	0.190613
SAR 1g (W/Kg)	0.402015

**SURFACE SAR**

**VOLUME SAR**

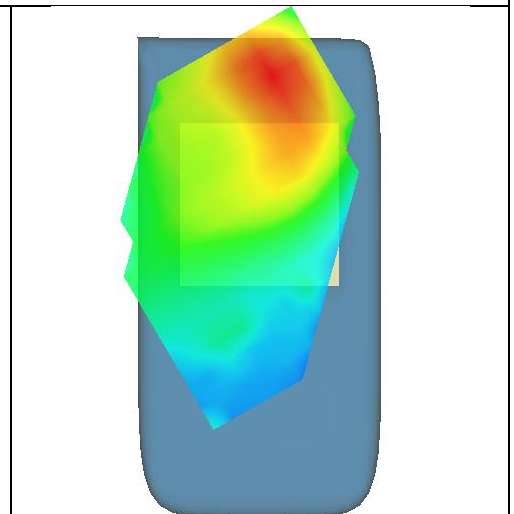
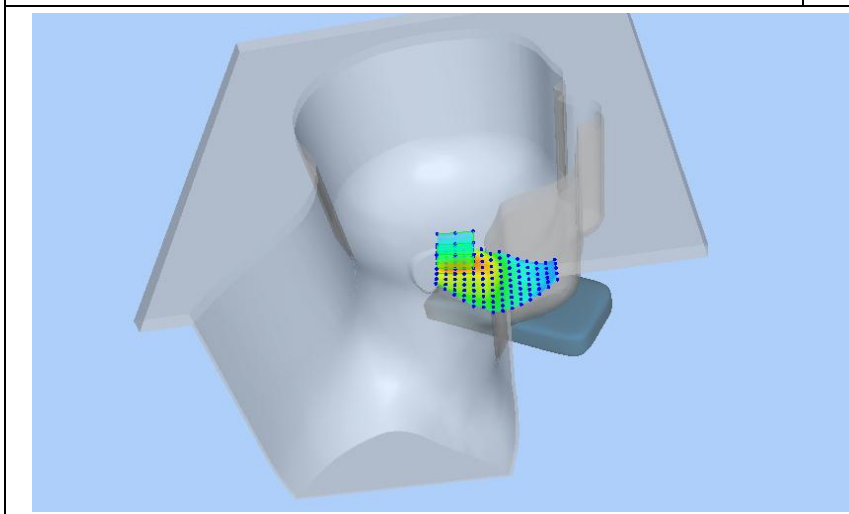
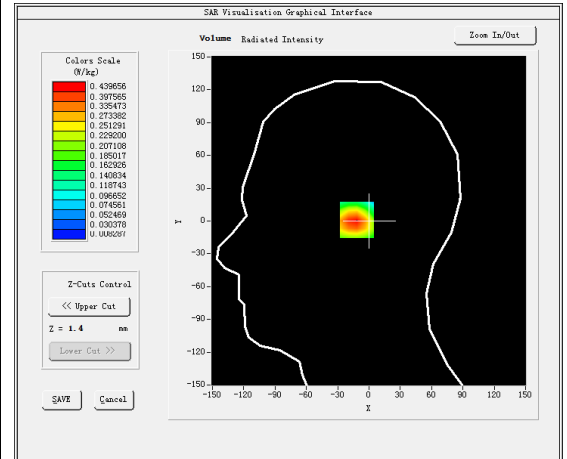
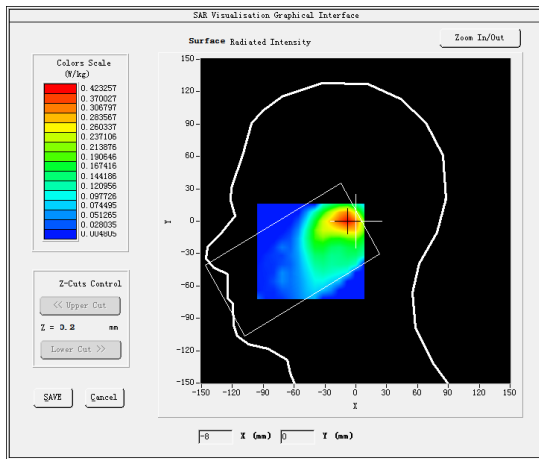

#8

Test Mode: Hotspot 802.11b(WiFi2.4G),Middle channel (Body Front Side)

Product Description: Smart Phone

Model: ELUGA RAY 800

Test Date: April 09, 2019

Medium(liquid type)	MSL_2450
Frequency (MHz)	2437.0000
Relative permittivity (real part)	51.62
Conductivity (S/m)	1.99
E-Field Probe	SN 31/17 EPGO324
Crest Factor	1.0
Conversion Factor	1.95
Sensor	4mm
Area Scan	dx=8mm dy=8mm
Zoom Scan	5x5x7,dx=8mm dy=8mm dz=5mm
Variation (%)	-4.920000
SAR 10g (W/Kg)	0.112264
SAR 1g (W/Kg)	0.227030

**SURFACE SAR**

**VOLUME SAR**

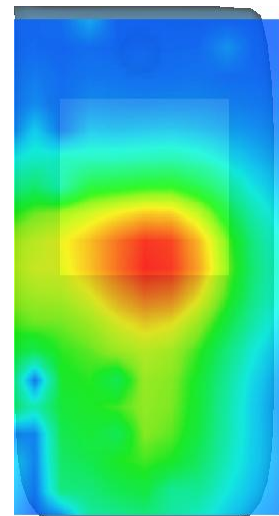
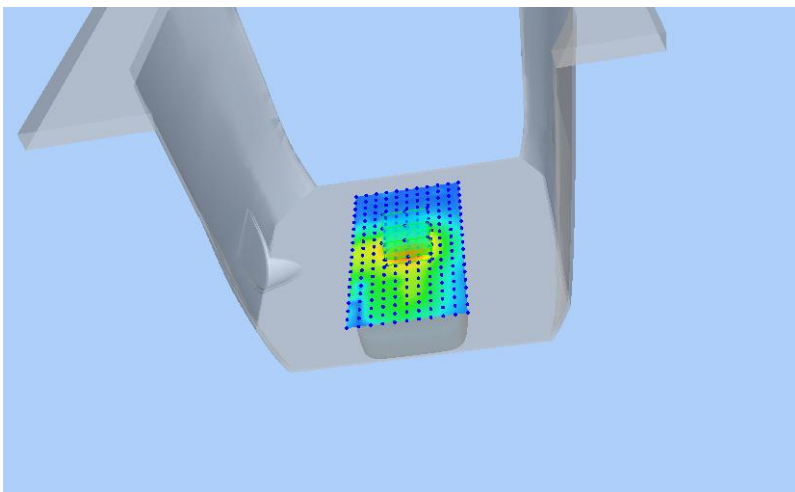
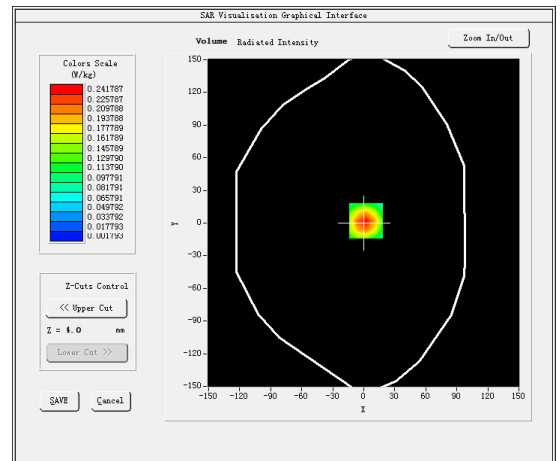
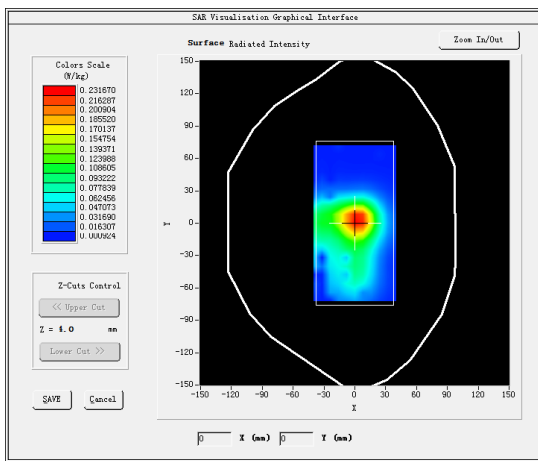

## 5. CALIBRATION CERTIFICATES

### 5.1 Probe-EPGO324 Calibration Certificate



## COMOSAR E-Field Probe Calibration Report

Ref : ACR.281.2.18.SATU.A

**SHENZHEN LCS COMPLIANCE TESTING  
LABORATORY LTD.**  
1F., XINGYUAN INDUSTRIAL PARK, TONGDA ROAD,  
BAO'AN BLVD  
BAO'AN DISTRICT, SHENZHEN, GUANGDONG, CHINA  
**MVG COMOSAR DOSIMETRIC E-FIELD PROBE**  
SERIAL NO.: SN 31/17 EPGO324

Calibrated at MVG US  
2105 Barrett Park Dr. - Kennesaw, GA 30144



Calibration Date: 10/08/2018

#### *Summary:*

This document presents the method and results from an accredited COMOSAR Dosimetric E-Field Probe calibration performed in MVG USA using the CALISAR / CALIBAIR test bench, for use with a COMOSAR system only. All calibration results are traceable to national metrology institutions.



## COMOSAR E-FIELD PROBE CALIBRATION REPORT

Ref: ACR.281.2.18.SATU.A

	<i>Name</i>	<i>Function</i>	<i>Date</i>	<i>Signature</i>
<i>Prepared by :</i>	Jérôme LUC	Product Manager	10/8/2018	<i>JS</i>
<i>Checked by :</i>	Jérôme LUC	Product Manager	10/8/2018	<i>JS</i>
<i>Approved by :</i>	Kim RUTKOWSKI	Quality Manager	10/8/2018	<i>Kim Rutkowski</i>

	<i>Customer Name</i>
<i>Distribution :</i>	Shenzhen LCS Compliance Testing Laboratory Ltd.

<i>Issue</i>	<i>Date</i>	<i>Modifications</i>
A	10/8/2018	Initial release

Page: 2/10

*This document shall not be reproduced, except in full or in part, without the written approval of MVG.  
The information contained herein is to be used only for the purpose for which it is submitted and is not to be released in whole or part without written approval of MVG.*