

## TEST REPORT

**Report Number: 18070923HKG-001**

Application for Original Grant of 47 CFR Part 15 Certification

This report contains the data of Bluetooth 4.0 & 5.0 BLE portion only.

BLE Beacon - Wallet Tracker

**FCC ID: 2APTI-WL01BK**

**Prepared and Checked by:**

**Approved by:**

Signed On File

Kung Wing Cheong, Steven  
Senior Lead Engineer

---

Chan Chi Hung, Terry  
Manager

Date: August 24, 2018

---

Intertek's standard Terms and Conditions can be obtained at our website <http://www.intertek.com/terms/>.

This test report only allows to be revised within the retention period unless further standard or the requirement was noticed.

This report is for the exclusive use of Intertek's Client and is provided pursuant to the agreement between Intertek and its Client. Intertek's responsibility and liability are limited to the terms and conditions of the agreement. Intertek assumes no liability to any party, other than to the Client in accordance with the agreement, for any loss, expense or damage occasioned by the use of this report. Only the Client is authorized to permit copying or distribution of this report and then only in its entirety. Any use of the Intertek name or one of its marks for the sale or advertisement of the tested material, product or service must first be approved in writing by Intertek. The observations and test results in this report are relevant only to the sample tested. This report by itself does not imply that the material, product, or service is or has ever been under an Intertek certification program.

© 2017 Intertek

## TEST REPORT

### GENERAL INFORMATION

<b>Applicant Name:</b>	Panasonic India Private Limited
<b>Applicant Address:</b>	12th Floor Ambience Tower, Ambience Island, NH-8, Gurgaon, Haryana-122002, India.
<b>FCC Specification Standard:</b>	FCC Part 15, October 1, 2016 Edition
<b>FCC ID:</b>	2APTI-WL01BK
<b>FCC Model(s):</b>	IC-BCWL01BK
<b>Type of EUT:</b>	Spread Spectrum Transmitter
<b>Description of EUT:</b>	BLE Beacon - Wallet Tracker
<b>Serial Number:</b>	N/A
<b>Sample Receipt Date:</b>	July 17, 2018
<b>Date of Test:</b>	July 17, 2018 to August 22, 2018
<b>Report Date:</b>	August 24, 2018
<b>Environmental Conditions:</b>	Temperature: +10 to 40°C Humidity: 10 to 90%

## TEST REPORT

### TABLE OF CONTENTS

<b>1.0</b>	<b>TEST RESULTS SUMMARY &amp; STATEMENT OF COMPLIANCE .....</b>	<b>4</b>
	1.1 Summary of Test Results .....	4
	1.2 Statement of Compliance .....	4
<b>2.0</b>	<b>GENERAL DESCRIPTION .....</b>	<b>5</b>
	2.1 Product Description.....	5
	2.2 Test Methodology .....	5
	2.3 Test Facility .....	5
	2.4 Related Submittal(s) Grants.....	5
<b>3.0</b>	<b>SYSTEM TEST CONFIGURATION .....</b>	<b>6</b>
	3.1 Justification .....	6
	3.2 EUT Exercising Software .....	7
	3.3 Details of EUT and Description of Accessories.....	8
	3.4 Measurement Uncertainty .....	8
<b>4.0</b>	<b>TEST RESULTS .....</b>	<b>9</b>
	4.1 Maximum Conducted Output Power at Antenna Terminals.....	9
	4.2 Minimum 6dB RF Bandwidth .....	10
	4.3 Maximum Power Spectral Density .....	15
	4.4 Out of Band Conducted Emissions .....	20
	4.5 Field Strength Calculation .....	27
	4.6 Transmitter Radiated Emissions in Restricted Bands and Spurious Emissions.....	28
	4.6.1 Radiated Emission Configuration Photograph .....	28
	4.6.2 Radiated Emission Data .....	28
	4.6.3 Radiated Emission Test Setup .....	36
	4.6.4 Transmitter Duty Cycle Calculation .....	37
<b>5.0</b>	<b>EQUIPMENT LIST.....</b>	<b>39</b>

## TEST REPORT

### 1.0 TEST RESULTS SUMMARY & STATEMENT OF COMPLIANCE

#### 1.1 Summary of Test Results

Test Items	FCC Part 15 Section	Results	Details See Section
Antenna Requirement	15.203	Pass	2.1
Max. Conducted Output Power (Peak)	15.247(b)(3)&(4)	Pass	4.1
Min. 6dB RF Bandwidth	15.247(a)(2)	Pass	4.2
Max. Power Density (average)	15.247(e)	Pass	4.3
Out of Band Antenna Conducted Emission	15.247(d)	Pass	4.4
Radiated Emission in Restricted Bands and Spurious Emissions	15.247(d), 15.209 & 15.109	Pass	4.6

Note: Pursuant to FCC Part 15 Section 15.215(c), the 20dB bandwidth of the emission was contained within the frequency band designated (mentioned as above) which the EUT operated. The effects, if any, from frequency sweeping, frequency hopping, other modulation techniques and frequency stability over expected variations in temperature and supply voltage were considered.

#### 1.2 Statement of Compliance

The equipment under test is found to be complying with the following standard:

FCC Part 15, October 1, 2016 Edition

## TEST REPORT

### 2.0 GENERAL DESCRIPTION

#### 2.1 Product Description

The Equipment Under Test (EUT) is a portable 2.4GHz Bluetooth device (Bluetooth 4.0 & 5.0) operating at frequency range of 2402MHz to 2480MHz with 2MHz channel spacing. The EUT is powered by 2 x 3.0V CR2016 battery.

##### For Bluetooth module:

For Bluetooth 4.0 and 5.0 mode, it occupies a frequency range from 2402MHz to 2480MHz (40 channels with channel spacing of 2MHz). It transmits via GFSK modulation.

The antenna(s) used in the EUT is internal, integral.

The circuit description is saved with filename: descri.pdf.

This report contains the data of Bluetooth 4.0 & 5.0 BLE portion only.

#### 2.2 Test Methodology

Both AC power line-conducted and radiated emission measurements were performed according to the procedures in ANSI C63.10 (2013). Preliminary radiated scans and all radiated measurements were performed in radiated emission test sites. All Radiated tests were performed at an antenna to EUT distance of 3 meters, unless stated otherwise in the "**Justification Section**" of this Application. Antenna port conducted measurements were performed according to ANSI C63.10 (2013) and KDB Publication No.558074 D01 v04 (05-April-2017) All other measurements were made in accordance with the procedures in 47 CFR Part 2.

#### 2.3 Test Facility

The radiated emission test site and antenna port conducted measurement facility used to collect the radiated data and conductive data are at Workshop No. 3, G/F., World-Wide Industrial Centre, 43-47 Shan Mei Street, Fo Tan, Sha Tin, N.T., Hong Kong. This test facility and site measurement data have been fully placed on file with the FCC.

#### 2.4 Related Submittal(s) Grants

This is a single application for certification of a transceiver (Bluetooth portion)

## TEST REPORT

### 3.0 SYSTEM TEST CONFIGURATION

#### 3.1 Justification

For radiated emissions testing, the equipment under test (EUT) was setup to transmit / receive continuously to simplify the measurement methodology. Care was taken to ensure proper power supply voltages during testing. During testing, all cables (if any) were manipulated to produce worst case emissions.

The EUT was powered by 2 x 3.0V CR2016 batteries.

For the measurements, the EUT was attached to a plastic stand if necessary and placed on the wooden turntable which is four feet in diameter and approximately 0.8m in height above the ground plane for emission measurement at or below 1GHz and 1.5m in height above the ground plane for emission measurement above 1GHz. If the base unit attached to peripherals, they were connected and operational to simulate typical use. The handset was remotely located as far from the antenna and the base as possible to ensure full power transmission from the base. Else, the base was wired to transmit full power.

The signal was maximized through rotation and placement in the three orthogonal axes. The antenna height and polarization were varied during the search for maximum signal level. The antenna height was varied from 1 to 4 meters. Radiated emissions were taken at three meters unless the signal level was too low for measurement at that distance. If necessary, a pre-amplifier was used and/or the test was conducted at a closer distance.

For any intentional radiator powered by AC power line, measurements of the radiated signal level of the fundamental frequency component of the emission was performed with the supply voltage varied between 85% and 115% of the nominal rated supply voltage.

Radiated emission measurement for transmitter were performed from the lowest radio frequency signal generated in the device which is greater than 9 kHz to the tenth harmonic of the highest fundamental frequency or to 40 GHz, whichever is lower.

Emission that are directly caused by digital circuits in the transmit path and transmitter portion were measured, and the limit are according to FCC Part 15 Section 15.209. Digital circuitries used to control additional functions other than the operation of the transmitter are subject to FCC Part 15 Section 15.109 Limits.

## TEST REPORT

### 3.1 Justification – Cont'd

Detector function for radiated emissions was in peak mode. Average readings, when required, were taken by measuring the duty cycle of the equipment under test and subtracting the corresponding amount in dB from the measured peak readings. A detailed description for the calculation of the average factor can be found in section 4.8.3.

Determination of pulse desensitization was made according to *Hewlett Packard Application Note 150-2, Spectrum Analysis... Pulsed RF*. The effective period (Teff) was referred to Exhibit 4.8.3. With the resolution bandwidth 1MHz and spectrum analyzer IF bandwidth 3dB, the pulse desensitization factor was 0dB.

For AC line conducted emission test, the EUT along with its peripherals were placed on a 1.0m(W)x1.5m(L) and 0.8m in height wooden table and the EUT was adjusted to maintain a 0.4 meter space from a vertical reference plane. The EUT was connected to power mains through a line impedance stabilization network (LISN), which provided 50ohm coupling impedance for measuring instrument. The LISN housing, measuring instrument case, reference ground plane, and vertical ground plane were bounded together. The excess power cable between the EUT and the LISN was bundled.

All connecting cables of EUT and peripherals were manipulated to find the maximum emission.

Different data rates have been tested. Worst case is reported only.

### 3.2 EUT Exercising Software

The EUT exercise program (if any) used during radiated and conducted testing was designed to exercise the various system components in a manner similar to a typical use.

## TEST REPORT

### 3.3 Details of EUT and Description of Accessories

Details of EUT:

A battery (provided with the unit) was used to power the device. Their description are listed below.

- (1) 2 x 3.0V CR2016 battery (Supplied by Intertek)

Description of Accessories:

- (1) Samsung S6 (model: G9200) (Provided by Intertek)

### 3.4 Measurement Uncertainty

When determining of the test conclusion, the Measurement Uncertainty of test at a level of confidence of 95% has been considered. The values of the Measurement uncertainty for radiated emission test and RF conducted measurement test are  $\pm 5.3\text{dB}$  and  $\pm 0.99\text{dB}$  respectively. The value of the Measurement uncertainty for conducted emission test is  $\pm 4.2\text{dB}$ .

Uncertainty and Compliance - Unless the standard specifically states that measured values are to be extended by the measurement uncertainty in determining compliance, all compliance determinations are based on the actual measured value.



## TEST REPORT

### 4.0 TEST RESULTS

#### 4.1 Maximum Conducted (peak) Output Power at Antenna Terminals

##### RF Conduct Measurement Test Setup

The figure below shows the test setup, which is utilized to make these measurements.

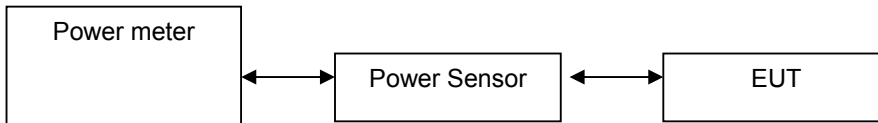

The antenna port of the EUT was connected to the input of a spectrum analyzer.

- The antenna power of the EUT was connected to the input of a power meter. Power was read directly and cable loss correction was added to the reading to obtain power at the EUT antenna terminals. The measurement procedure 9.1.2 was used.
- The EUT should be configured to transmit continuously (at a minimum duty cycle of 98%) at full power over the measurement duration. The measurement procedure AVG1 was used.

LE 1Mbps		Antenna Gain = 0 dBi	
Frequency (MHz)	Output in dBm	Output in mWatt	
Low Channel:	2402	-1.68	0.68
Middle Channel:	2440	-1.62	0.69
High Channel:	2480	-2.67	0.54

LE 2Mbps		Antenna Gain = 0 dBi	
Frequency (MHz)	Output in dBm	Output in mWatt	
Low Channel:	2402	-1.91	0.64
Middle Channel:	2440	-1.81	0.66
High Channel:	2480	-2.82	0.52

Cable loss : 0.5 dB External Attenuation : 0 dB

Cable loss, external attenuation:  included in OFFSET function  
 added to SA raw reading

Max. conducted (peak) output level = -1.62 dBm

Limits:

1W (30dBm) for antennas with gains of 6dBi or less

\_\_\_W (\_\_\_dBm) for antennas with gains more than 6dBi

## TEST REPORT

### 4.2 Minimum 6dB RF Bandwidth

The antenna port of the EUT was connected to the input of a spectrum analyzer. The EBW measurement procedure was used. A PEAK output reading was taken, a DISPLAY line was drawn 6dB lower than PEAK level. The 6dB bandwidth was determined from where the channel output spectrum intersected the display line.

#### LE 1Mbps

	Frequency (MHz)	6dB Bandwidth (MHz)
Low Channel:	2402	0.600
Middle Channel:	2440	0.600
High Channel:	2480	0.600

#### LE 2Mbps

	Frequency (MHz)	6dB Bandwidth (MHz)
Low Channel:	2402	0.900
Middle Channel:	2440	0.780
High Channel:	2480	0.900

#### Limits

6 dB bandwidth shall be at least 500kHz

The plots of 6dB RF bandwidth are saved as below.

**TEST REPORT**

**PLOTS OF 6dB RF BANDWIDTH (LE 1Mbps)**

**Lowest Channel**

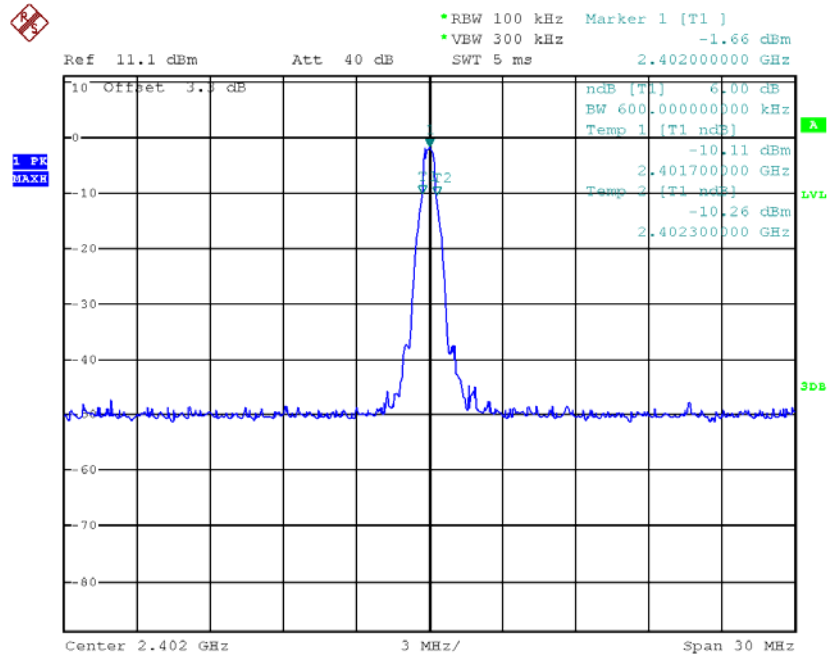

**Middle Channel**

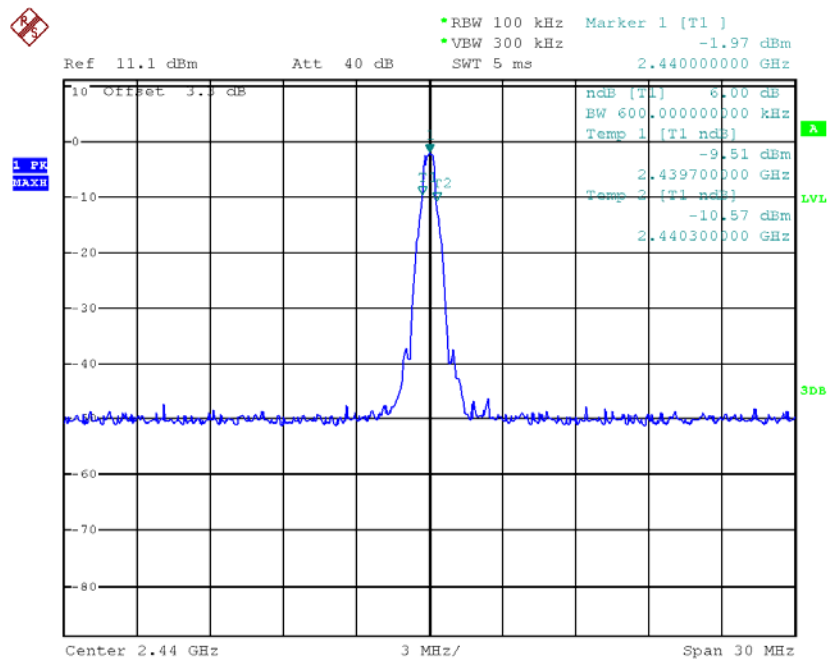

**TEST REPORT**

**PLOTS OF 6dB RF BANDWIDTH (LE 1Mbps)**  
Highest Channel

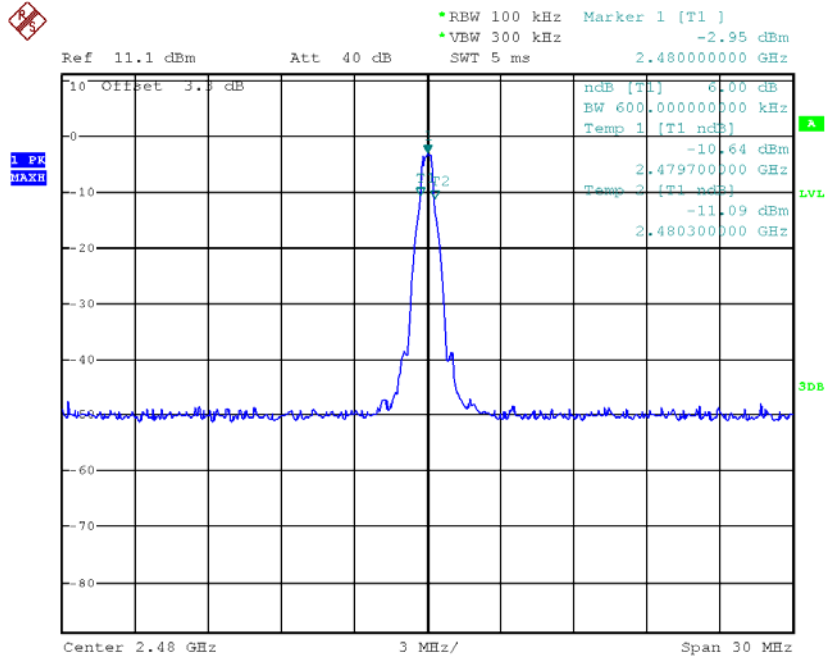

**TEST REPORT**

**PLOTS OF 6dB RF BANDWIDTH (LE 2Mbps)**

**Lowest Channel**

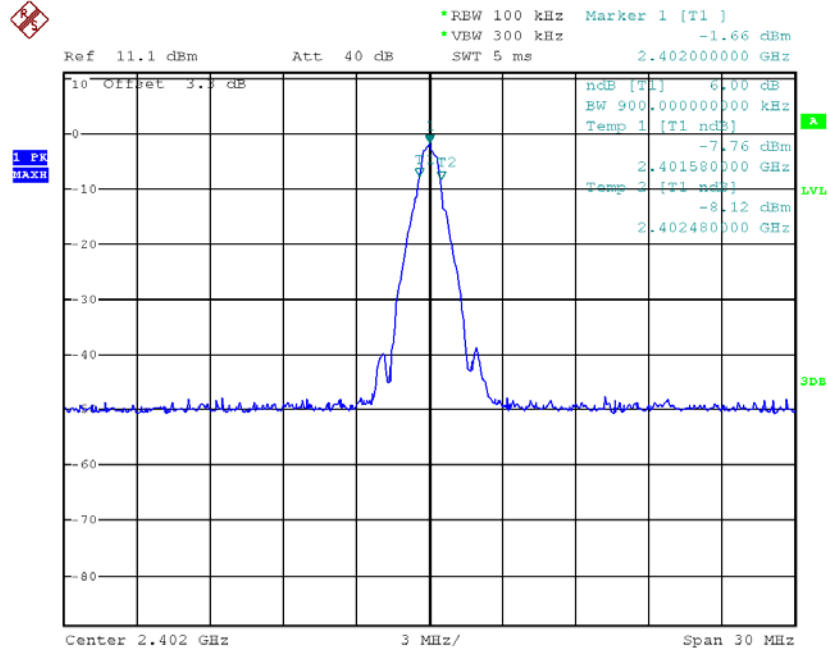

**Middle Channel**

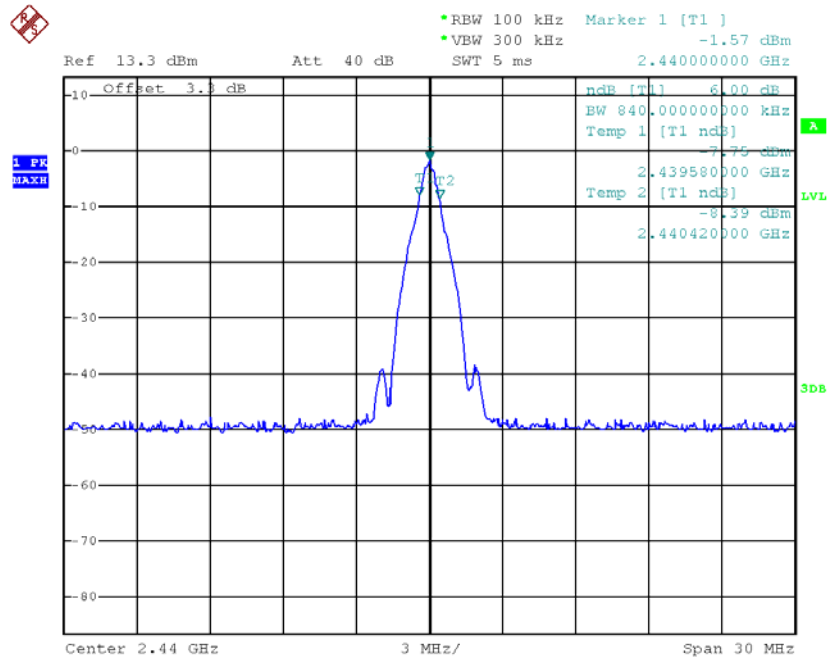

**TEST REPORT**

**PLOTS OF 6dB RF BANDWIDTH (LE 2Mbps)**  
Highest Channel

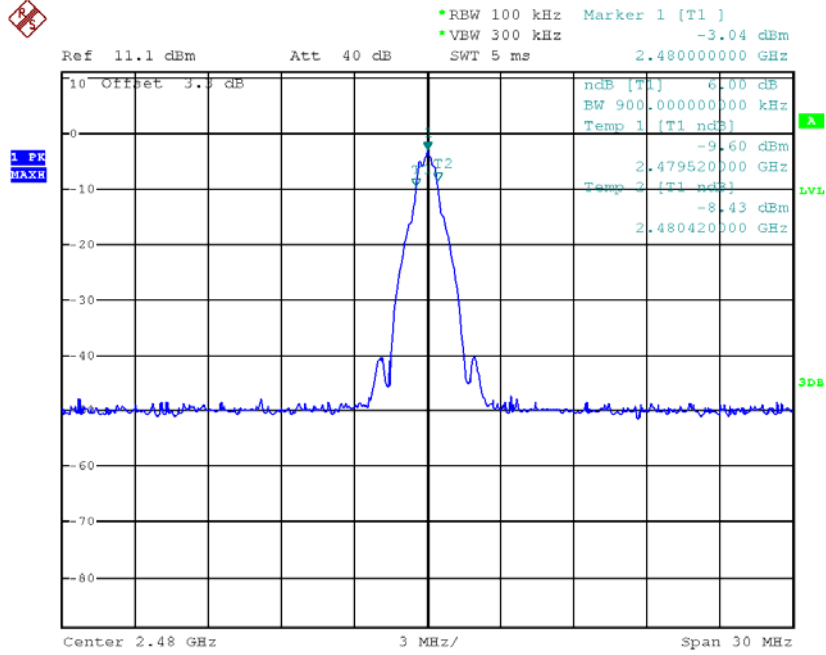

## TEST REPORT

### 4.3 Maximum Power Spectral Density

Antenna output of the EUT was coupled directly to spectrum analyzer. The measurement procedure 10.2 PKPSD was used. If an external attenuator and/or cable was used, these losses are compensated for using the OFFSET function of the analyser.

LE 1Mbps

	<b>Frequency (MHz)</b>	<b>PSD in 100kHz (dBm)</b>
Low Channel:	2402	-1.65
Middle Channel:	2440	-1.87
High Channel:	2480	-2.99

LE 2Mbps

	<b>Frequency (MHz)</b>	<b>PSD in 100kHz (dBm)</b>
Low Channel:	2402	-1.66
Middle Channel:	2440	-1.61
High Channel:	2480	-2.89

Cable Loss: 0.5 dB

Limit:  
8dBm

The plots of power spectral density are as below.

**TEST REPORT**

**PLOTS OF POWER SPECTRAL DENSITY (LE 1Mbps)**

Lowest channel

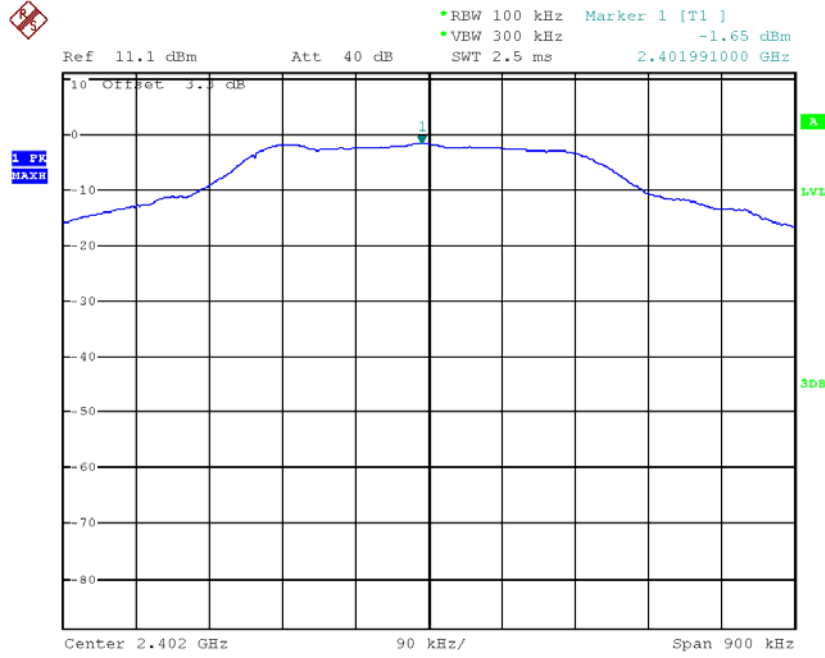

Middle channel

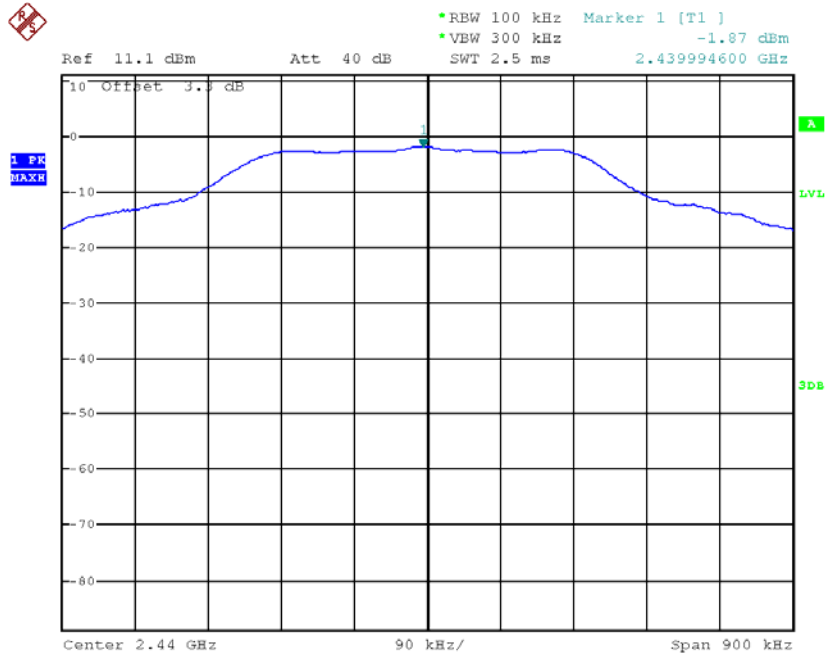



## TEST REPORT

### PLOTS OF POWER SPECTRAL DENSITY (LE 1Mbps)

Highest channel

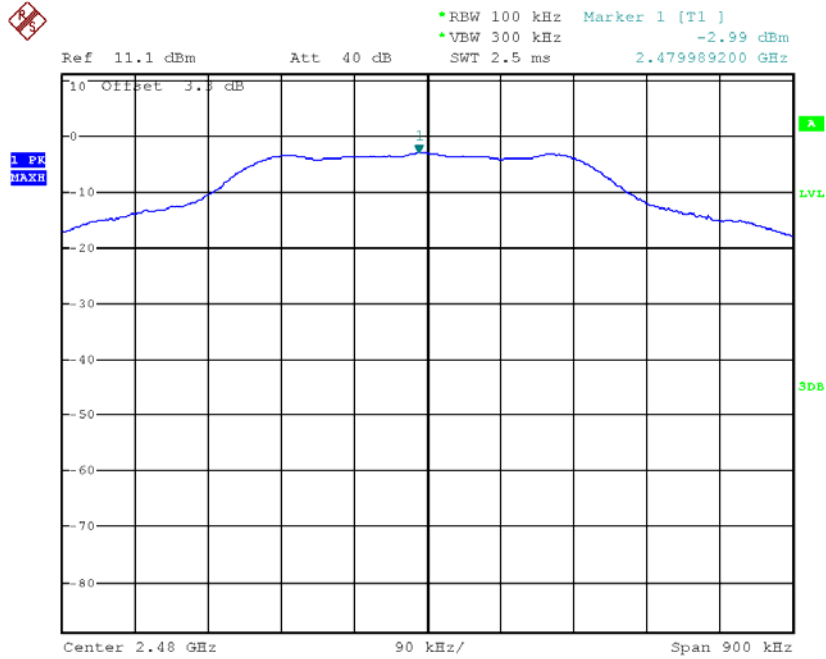



## TEST REPORT

### PLOTS OF POWER SPECTRAL DENSITY (LE 2Mbps)

Highest channel

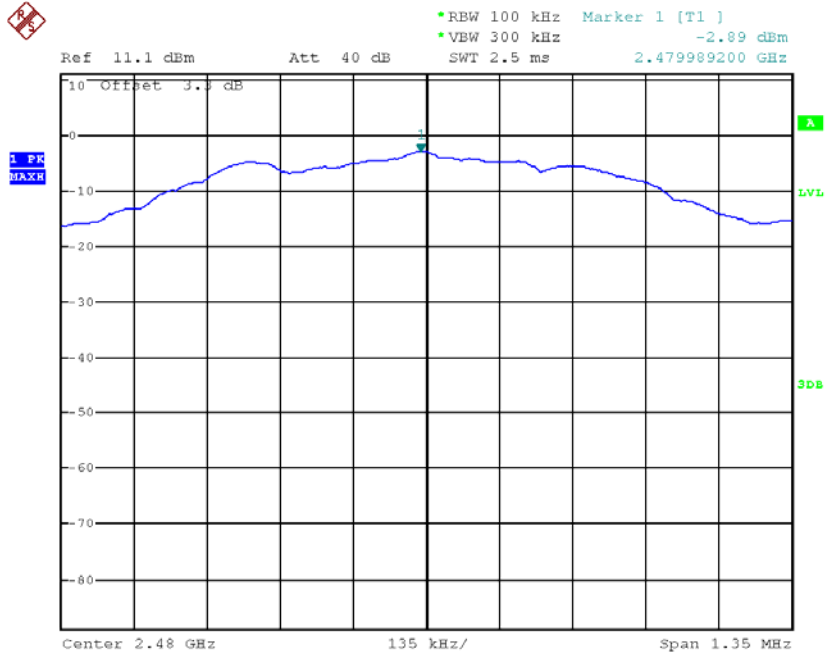

## TEST REPORT

### 4.4 Out of Band Conducted Emissions

For Bluetooth 4.0 and 5.0 BLE, the maximum conducted (peak) output power was used to demonstrate compliance as described in 9.1. Then the display line (in red) shown in the following plots denotes the limit at 20dB below maximum measured in-band peak PSD level in 100 KHz bandwidth for Bluetooth 4.0 BLE.

The measurement procedures under sections 11 of KDB558074 D01 v04 (05-April-2017) were used.

Furthermore, delta measurement technique for measuring bandedge emissions was incorporated in the test of the edge at 2483.5MHz.

#### Limits:

All spurious emission and up to the tenth harmonic was measured and they were found to be at least for Bluetooth 4.0 and 5.0 BLE below the maximum measured in-band peak PSD level.



**TEST REPORT**

**PLOTS OF OUT OF BAND CONDUCTED EMISSIONS (LE 1Mbps)**

Middle Channel, Plot A

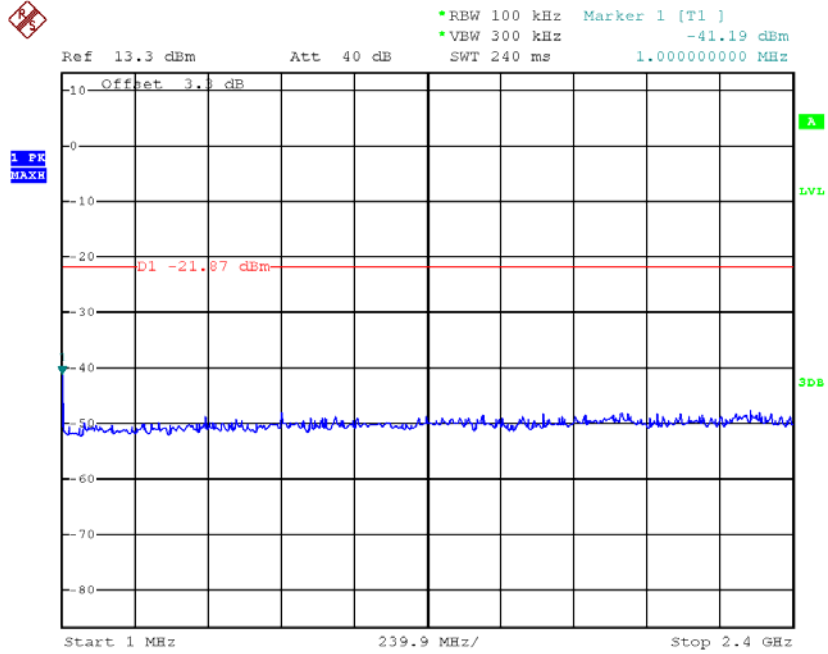

Middle Channel, Plot B

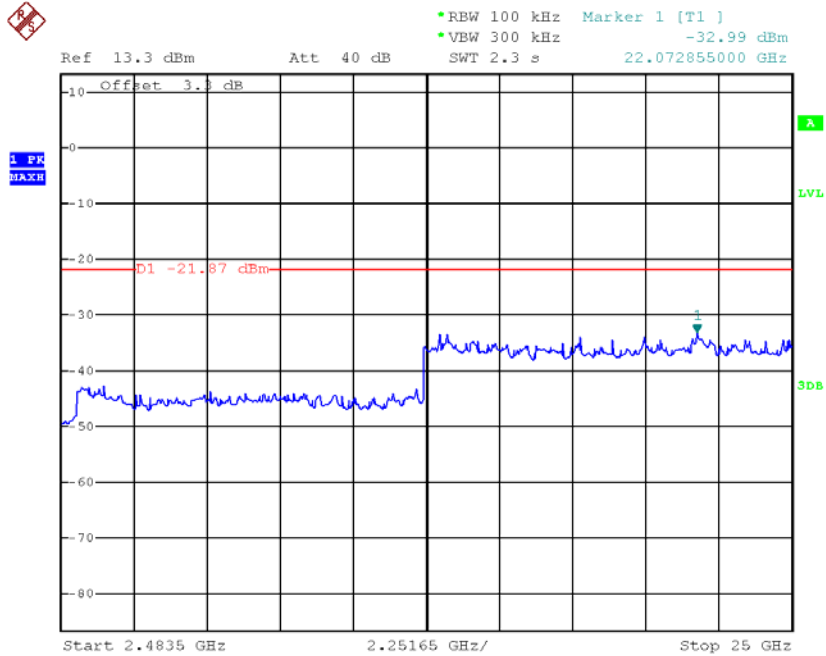

**TEST REPORT**

**PLOTS OF OUT OF BAND CONDUCTED EMISSIONS (LE 1Mbps)**

Highest Channel, Plot A

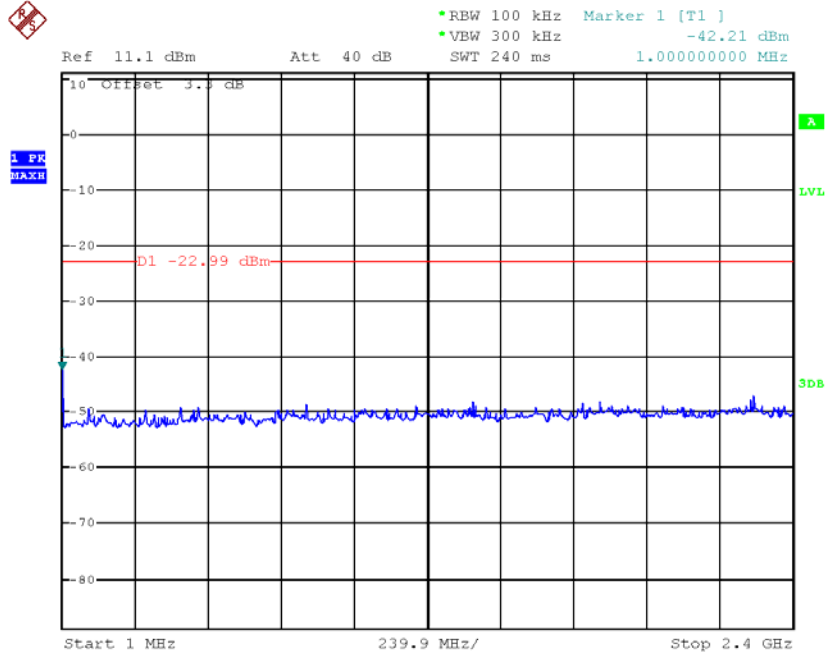

Highest Channel, Plot B

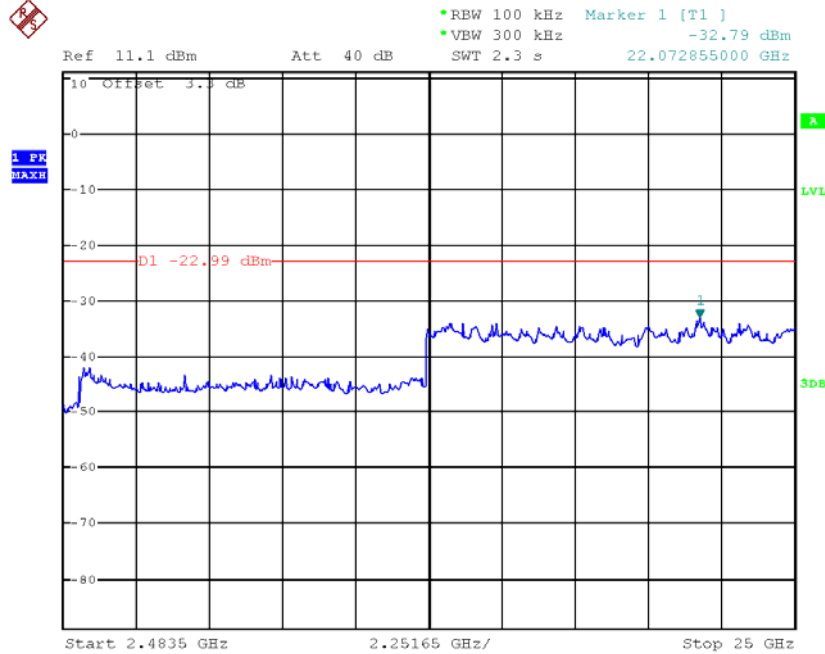

**TEST REPORT**

**PLOTS OF OUT OF BAND CONDUCTED EMISSIONS (LE 2Mbps)**

Lowest Channel, Plot A

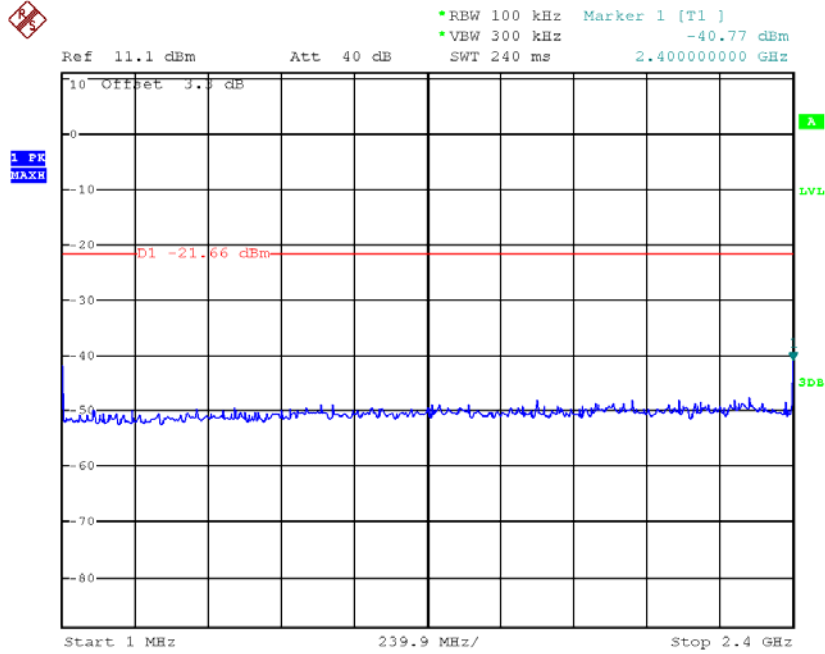

Lowest Channel, Plot B

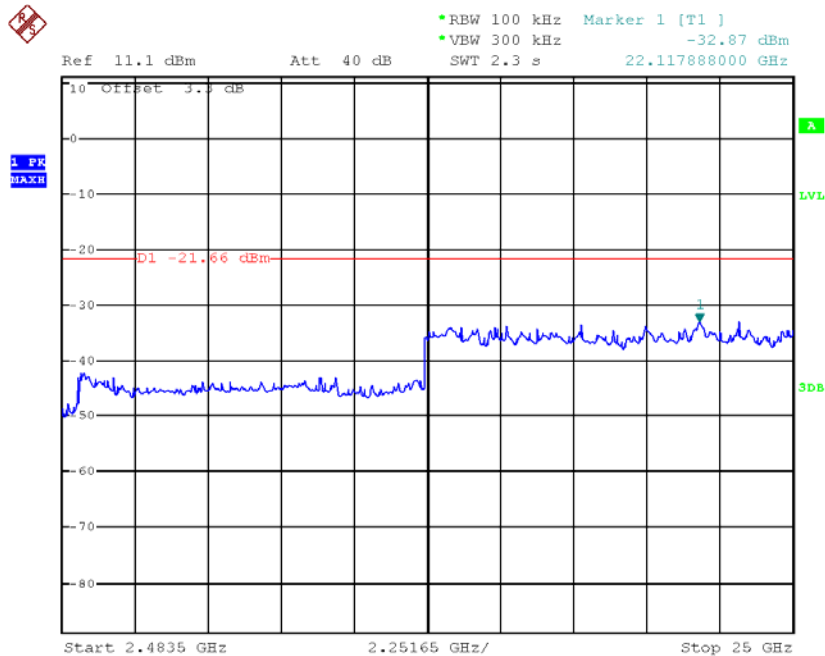



**TEST REPORT**

**PLOTS OF OUT OF BAND CONDUCTED EMISSIONS (LE 2Mbps)**

Middle Channel, Plot A

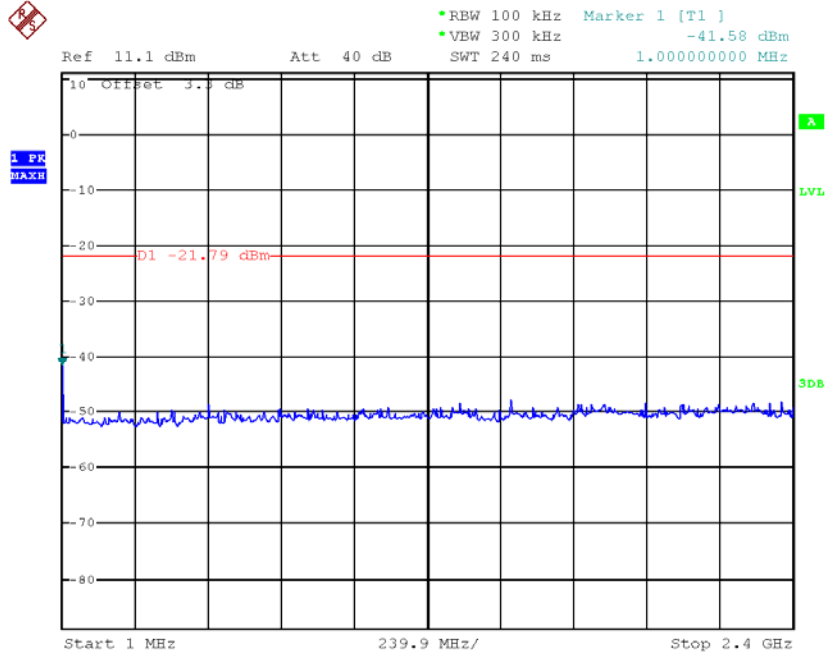

Middle Channel, Plot B

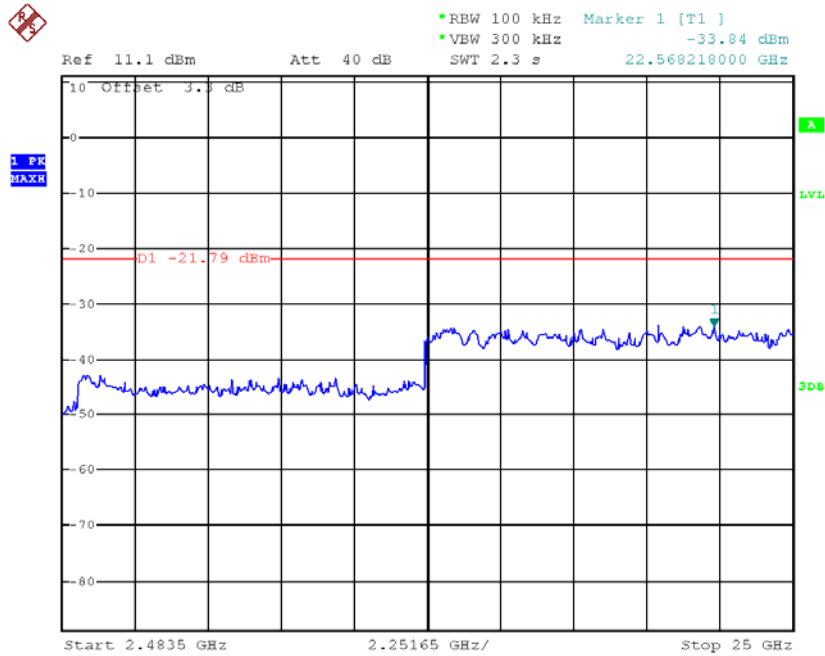

**TEST REPORT**

**PLOTS OF OUT OF BAND CONDUCTED EMISSIONS (LE 2Mbps)**

Highest Channel, Plot A

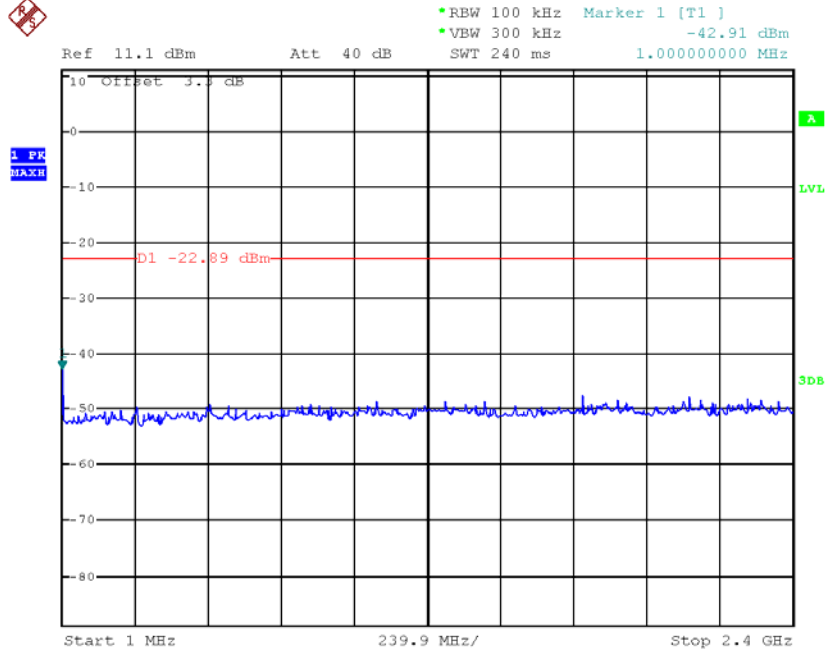

Highest Channel, Plot B

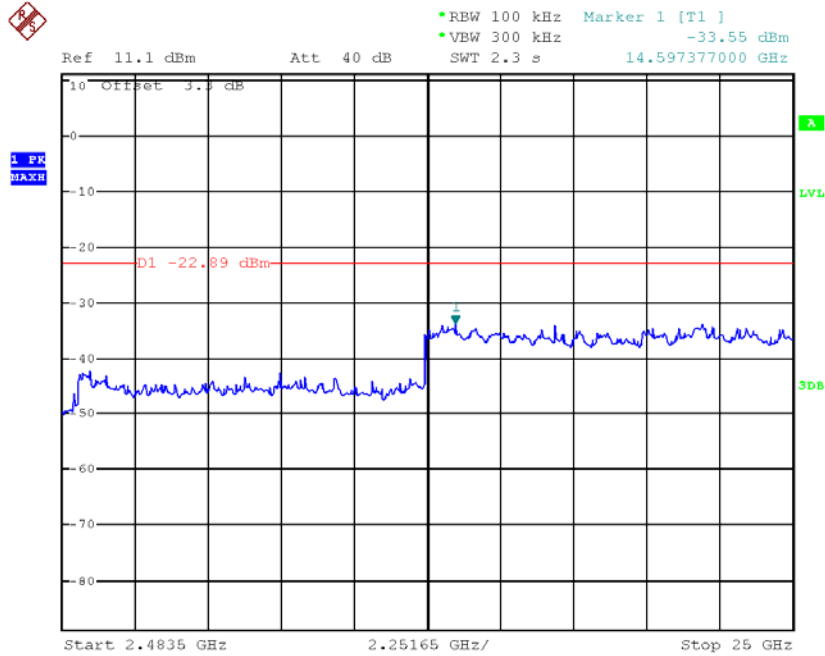

## TEST REPORT

### 4.5 Field Strength Calculation

The field strength is calculated by adding the reading on the Spectrum Analyzer to the factors associated with preamplifiers (if any), antennas, cables, pulse desensitization and average factors (when specified limit is in average and measurements are made with peak detectors). A sample calculation is included below.

$$FS = RA + AF + CF - AG + PD + AV$$

Where FS = Field Strength in dB $\mu$ V/m

RA = Receiver Amplitude (including preamplifier) in dB $\mu$ V

CF = Cable Attenuation Factor in dB

AF = Antenna Factor in dB

AG = Amplifier Gain in dB

PD = Pulse Desensitization in dB

AV = Average Factor in -dB

In the radiated emission table which follows, the reading shown on the data table may reflect the preamplifier gain. An example of the calculations, where the reading does not reflect the preamplifier gain, follows:

$$FS = RA + AF + CF - AG + PD + AV$$

#### Example

Assume a receiver reading of 62.0 dB $\mu$ V is obtained. The antenna factor of 7.4 dB and cable factor of 1.6 dB is added. The amplifier gain of 29.0 dB is subtracted. The pulse desensitization factor of the spectrum analyzer is 0.0 dB, and the resultant average factor is -10.0 dB. The net field strength for comparison to the appropriate emission limit is 32.0 dB $\mu$ V/m. This value in dB $\mu$ V/m is converted to its corresponding level in  $\mu$ V/m.

$$RA = 62.0 \text{ dB}\mu\text{V}$$

$$AF = 7.4 \text{ dB}$$

$$CF = 1.6 \text{ dB}$$

$$AG = 29.0 \text{ dB}$$

$$PD = 0.0 \text{ dB}$$

$$AV = -10 \text{ dB}$$

$$FS = 62.0 + 7.4 + 1.6 - 29.0 + 0.0 + (-10.0) = 32.0 \text{ dB}\mu\text{V/m}$$

$$\text{Level in } \mu\text{V/m} = \text{Common Antilogarithm } [(32.0 \text{ dB}\mu\text{V/m})/20] = 39.8 \mu\text{V/m}$$

## TEST REPORT

### 4.6 Transmitter Radiated Emissions in Restricted Bands and Spurious Emissions

Data is included of the worst case configuration (the configuration which resulted in the highest emission levels). A sample calculation, configuration photographs and data tables of the emissions are included.

The data on the following pages list the significant emission frequencies, the limit and the margin of compliance.

#### 4.6.1 Radiated Emission Configuration Photograph

Worst Case Restricted Band Radiated Emission  
at

4804.000 MHz

The worst case radiated emission configuration photographs are saved with filename: config photos.pdf

#### 4.6.2 Radiated Emission Data

The data in tables 1-4 list the significant emission frequencies, the limit and the margin of compliance.

Judgement -

Passed by 0.5 dB margin

**TEST REPORT**

**RADIATED EMISSION DATA**

Mode: TX-Channel 00 (LE 1Mbps)

Table 1

Polarization	Frequency (MHz)	Reading	Correction Factor	Net at 3m - Peak (dBµV/m)	Average Factor (dB)	Calculated at 3m (dBµV/m)	Average Limit at 3m (dBµV/m)	Margin (dB)
H	2390.000	54.0	-3.5	50.5	48.4	2.1	54.0	-51.9
H	4804.000	54.0	6.5	60.5	48.4	12.1	54.0	-41.9
H	7206.000	46.2	11.0	57.2	48.4	8.8	54.0	-45.2
H	9608.000	32.7	15.5	48.2	48.4	-0.2	54.0	-54.2
H	12010.000	31.7	20.1	51.8	48.4	3.4	54.0	-50.6

Polarization	Frequency (MHz)	Reading	Correction Factor	Net at 3m - Peak (dBµV/m)	Peak Limit at 3m (dBµV/m)	Margin (dB)
H	2390.000	54.0	-3.5	50.5	74.0	-23.5
H	4804.000	54.0	6.5	60.5	74.0	-13.5
H	7206.000	46.2	11.0	57.2	74.0	-16.8
H	9608.000	32.7	15.5	48.2	74.0	-25.8
H	12010.000	31.7	20.1	51.8	74.0	-22.2

- NOTES:
1. Peak detector is used for the emission measurement.
  2. All measurements were made at 3 meters. Radiated emissions not detected at the 3-meter distance were measured at 0.3-meter and an inverse proportional extrapolation was performed to compare the signal level to the 3-meter limit. No other radiated emissions than those reported were detected at a test distance of 0.3-meter.
  3. Negative value in the margin column shows emission below limit.
  4. Horn antenna is used for the emission over 1000MHz.
  5. Emission within the restricted band meets the requirement of FCC Part 15 Section 15.205.

**TEST REPORT**

**RADIATED EMISSION DATA**

Mode: TX-Channel 00 (LE 2Mbps)

Table 2

Polarization	Frequency (MHz)	Reading	Correction Factor	Net at 3m - Peak (dBµV/m)	Average Limit at 3m (dBµV/m)	Margin (dB)
H	2390.000	53.9	-3.5	50.4	54.0	-3.6
H	4804.000	47.0	6.5	53.5	54.0	-0.5
H	7206.000	40.0	11.0	51.0	54.0	-3.0
H	9608.000	36.4	15.5	51.9	54.0	-2.1
H	12010.000	31.4	20.1	51.5	54.0	-2.5

Polarization	Frequency (MHz)	Reading	Correction Factor	Net at 3m - Peak (dBµV/m)	Peak Limit at 3m (dBµV/m)	Margin (dB)
H	2390.000	54.5	-3.5	51.0	74.0	-23.0
H	4804.000	54.0	6.5	60.5	74.0	-13.5
H	7206.000	46.2	11.0	57.2	74.0	-16.8
H	9608.000	33.0	15.5	48.5	74.0	-25.5
H	12010.000	31.9	20.1	52.0	74.0	-22.0

- NOTES:
1. Peak detector is used for the emission measurement.
  2. All measurements were made at 3 meters. Radiated emissions not detected at the 3-meter distance were measured at 0.3-meter and an inverse proportional extrapolation was performed to compare the signal level to the 3-meter limit. No other radiated emissions than those reported were detected at a test distance of 0.3-meter.
  3. Negative value in the margin column shows emission below limit.
  4. Horn antenna is used for the emission over 1000MHz.
  5. Emission within the restricted band meets the requirement of FCC Part 15 Section 15.205.
  6. Average measurement method is according to ANSI C63.10.

**TEST REPORT**

Mode: TX-Channel 38 (LE 1Mbps)

Table 3

Polarization	Frequency (MHz)	Reading	Correction Factor	Net at 3m - Peak (dBµV/m)	Average Factor (dB)	Calculated at 3m (dBµV/m)	Average Limit at 3m (dBµV/m)	Margin (dB)
H	4880.000	54.3	6.5	60.8	48.4	12.4	54.0	-41.6
H	7320.000	47.0	11.0	58.0	48.4	9.6	54.0	-44.4
H	9760.000	32.8	15.5	48.3	48.4	-0.1	54.0	-54.1
H	12200.000	31.6	20.1	51.7	48.4	3.3	54.0	-50.7

Polarization	Frequency (MHz)	Reading	Correction Factor	Net at 3m - Peak (dBµV/m)	Peak Limit at 3m (dBµV/m)	Margin (dB)
H	4880.000	54.3	6.5	60.8	74.0	-13.2
H	7320.000	47.0	11.0	58.0	74.0	-16.0
H	9760.000	32.8	15.5	48.3	74.0	-25.7
H	12200.000	31.6	20.1	51.7	74.0	-22.3

- NOTES:
1. Peak detector is used for the emission measurement.
  2. All measurements were made at 3 meters. Radiated emissions not detected at the 3-meter distance were measured at 0.3-meter and an inverse proportional extrapolation was performed to compare the signal level to the 3-meter limit. No other radiated emissions than those reported were detected at a test distance of 0.3-meter.
  3. Negative value in the margin column shows emission below limit.
  4. Horn antenna is used for the emission over 1000MHz.
  5. Emission within the restricted band meets the requirement of FCC Part 15 Section 15.205.

**TEST REPORT**

Mode: TX-Channel 38 (LE 2Mbps)

Table 4

Polari- zation	Frequency (MHz)	Reading	Correction Factor	Net at 3m - Peak (dB $\mu$ V/m)	Average Limit at 3m (dB $\mu$ V/m)	Margin (dB)
H	4880.000	46.0	6.5	52.5	54.0	-1.5
H	7320.000	40.6	11.0	51.6	54.0	-2.4
H	9760.000	26.5	15.5	42.0	54.0	-12.0
H	12200.000	25.0	20.1	45.1	54.0	-8.9

Polari- zation	Frequency (MHz)	Reading	Correction Factor	Net at 3m - Peak (dB $\mu$ V/m)	Peak Limit at 3m (dB $\mu$ V/m)	Margin (dB)
H	4880.000	54.0	6.5	60.5	74.0	-13.5
H	7320.000	46.4	11.0	57.4	74.0	-16.6
H	9760.000	32.7	15.5	48.2	74.0	-25.8
H	12200.000	31.8	20.1	51.9	74.0	-22.1

- NOTES:
1. Peak detector is used for the emission measurement.
  2. All measurements were made at 3 meters. Radiated emissions not detected at the 3-meter distance were measured at 0.3-meter and an inverse proportional extrapolation was performed to compare the signal level to the 3-meter limit. No other radiated emissions than those reported were detected at a test distance of 0.3-meter.
  3. Negative value in the margin column shows emission below limit.
  4. Horn antenna is used for the emission over 1000MHz.
  5. Emission within the restricted band meets the requirement of FCC Part 15 Section 15.205.
  6. Average measurement method is according to ANSI C63.10.



**TEST REPORT**

Mode: TX-Channel 78(LE 1Mbps)

Table 5

Polarization	Frequency (MHz)	Reading	Correction Factor	Net at 3m - Peak (dB $\mu$ V/m)	Average Factor (dB)	Calculated at 3m (dB $\mu$ V/m)	Average Limit at 3m (dB $\mu$ V/m)	Margin (dB)
H	2483.500	60.5	-3.5	57.0	48.4	8.6	94.0	-85.4
H	4960.000	53.4	6.5	59.9	48.4	11.5	54.0	-42.5
H	7440.000	46.9	11.0	57.9	48.4	9.5	54.0	-44.5
H	9920.000	32.6	15.5	48.1	48.4	-0.3	54.0	-54.3
H	12400.000	32.0	20.1	52.1	48.4	3.7	54.0	-50.3

Polarization	Frequency (MHz)	Reading	Correction Factor	Net at 3m - Peak (dB $\mu$ V/m)	Peak Limit at 3m (dB $\mu$ V/m)	Margin (dB)
H	2483.500	60.5	-3.5	57.0	114.0	-57.0
H	4960.000	53.4	6.5	59.9	74.0	-14.1
H	7440.000	46.9	11.0	57.9	74.0	-16.1
H	9920.000	32.6	15.5	48.1	74.0	-25.9
H	12400.000	32.0	20.1	52.1	74.0	-21.9

- NOTES:
1. Peak detector is used for the emission measurement.
  2. All measurements were made at 3 meters. Radiated emissions not detected at the 3-meter distance were measured at 0.3-meter and an inverse proportional extrapolation was performed to compare the signal level to the 3-meter limit. No other radiated emissions than those reported were detected at a test distance of 0.3-meter.
  3. Negative value in the margin column shows emission below limit.
  4. Horn antenna is used for the emission over 1000MHz.
  5. Emission within the restricted band meets the requirement of FCC Part 15 Section 15.205.

**TEST REPORT**

Mode: TX-Channel 78(LE 2Mbps)

Table 6

Polarization	Frequency (MHz)	Reading	Correction Factor	Net at 3m - Peak (dB $\mu$ V/m)	Average Limit at 3m (dB $\mu$ V/m)	Margin (dB)
H	2483.500	53.9	-3.5	50.4	54.0	-3.6
H	4960.000	46.8	6.5	53.3	54.0	-0.7
H	7440.000	40.0	11.0	51.0	54.0	-3.0
H	9920.000	27.1	15.5	42.6	54.0	-11.4
H	12400.000	25.4	20.1	45.5	54.0	-8.5

Polarization	Frequency (MHz)	Reading	Correction Factor	Net at 3m - Peak (dB $\mu$ V/m)	Peak Limit at 3m (dB $\mu$ V/m)	Margin (dB)
H	2483.500	60.3	-3.5	56.8	74.0	-17.2
H	4960.000	53.8	6.5	60.3	74.0	-13.7
H	7440.000	46.1	11.0	57.1	74.0	-16.9
H	9920.000	32.7	15.5	48.2	74.0	-25.8
H	12400.000	31.5	20.1	51.6	74.0	-22.4

- NOTES:
1. Peak detector is used for the emission measurement.
  2. All measurements were made at 3 meters. Radiated emissions not detected at the 3-meter distance were measured at 0.3-meter and an inverse proportional extrapolation was performed to compare the signal level to the 3-meter limit. No other radiated emissions than those reported were detected at a test distance of 0.3-meter.
  3. Negative value in the margin column shows emission below limit.
  4. Horn antenna is used for the emission over 1000MHz.
  5. Emission within the restricted band meets the requirement of FCC Part 15 Section 15.205.
  6. Average measurement method is according to ANSI C63.10.

## TEST REPORT

Mode: Bluetooth communication with beep sound

Table 7

Polarization	Frequency (MHz)	Reading (dB $\mu$ V)	Pre-amp (dB)	Antenna Factor (dB)	Net at 3m (dB $\mu$ V/m)	Limit at 3m (dB $\mu$ V/m)	Margin (dB)
V	112.719	25.7	16	14.0	23.7	43.5	-19.8
V	144.000	25.0	16	14.0	23.0	43.5	-20.5
V	200.574	22.7	16	16.0	22.7	43.5	-20.8
V	219.408	20.5	16	17.0	21.5	46.0	-24.5
H	844.956	16.8	16	31.0	31.8	46.0	-14.2
H	962.136	15.9	16	33.0	32.9	54.0	-21.1

- NOTES:
1. Quasi-Peak detector is used for the emission measurement.
  2. All measurements were made at 3 meters. Radiated emissions not detected at the 3-meter distance were measured at 0.3-meter and an inverse proportional extrapolation was performed to compare the signal level to the 3-meter limit. No other radiated emissions than those reported were detected at a test distance of 0.3-meter.
  3. Negative value in the margin column shows emission below limit.
  4. Emission within the restricted band meets the requirement of FCC Part 15 Section 15.205.

**TEST REPORT**

4.6.3 Radiated Emission Test Setup

The figure below shows the test setup, which is utilized to make these measurements.

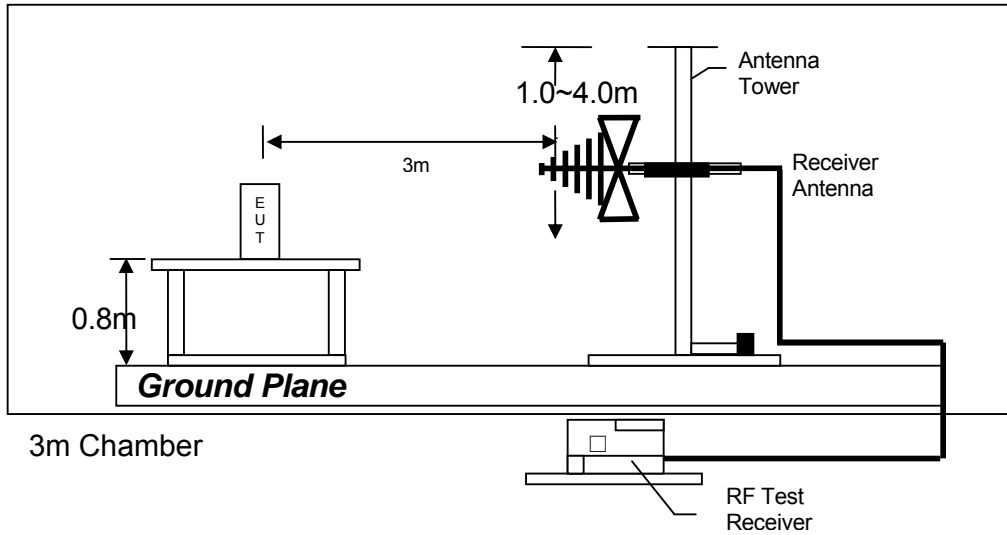

Test setup of radiated emissions up to 1GHz

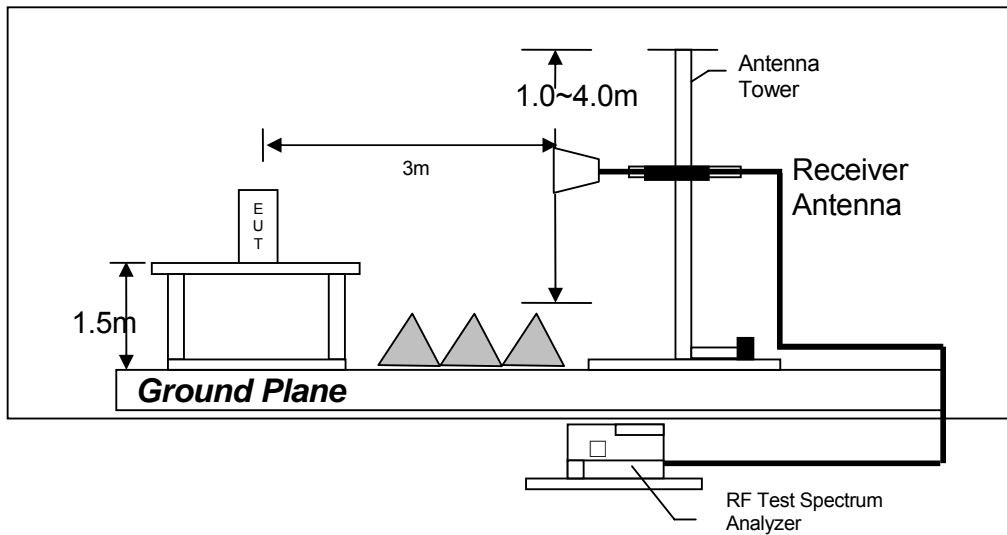

Test setup of radiated emissions above 1GHz

## TEST REPORT

### 4.6.4 Transmitter Duty Cycle Calculation

The duty cycle (LE1M) is simply the on-time divided by the period:

The duration of one cycle = 100 ms

Effective period of the cycle =  $1 * 380\mu\text{s} = 380 \mu\text{s}$

$DC = 0.38 / 100 = 0.0038$

Therefore, the averaging factor is found by  $20\log 0.0038 = -48.4\text{dB}$ .

## TEST REPORT

### AVERAGE FACTOR

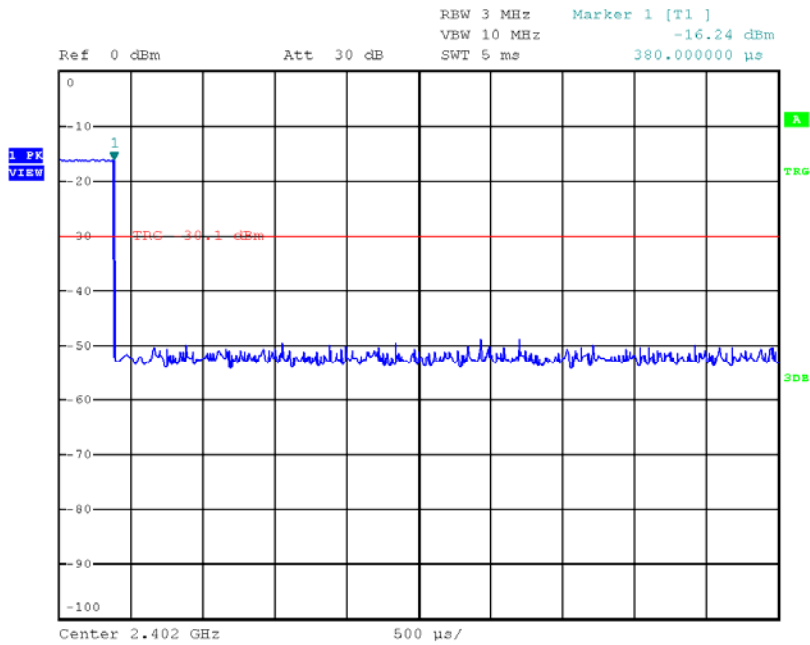
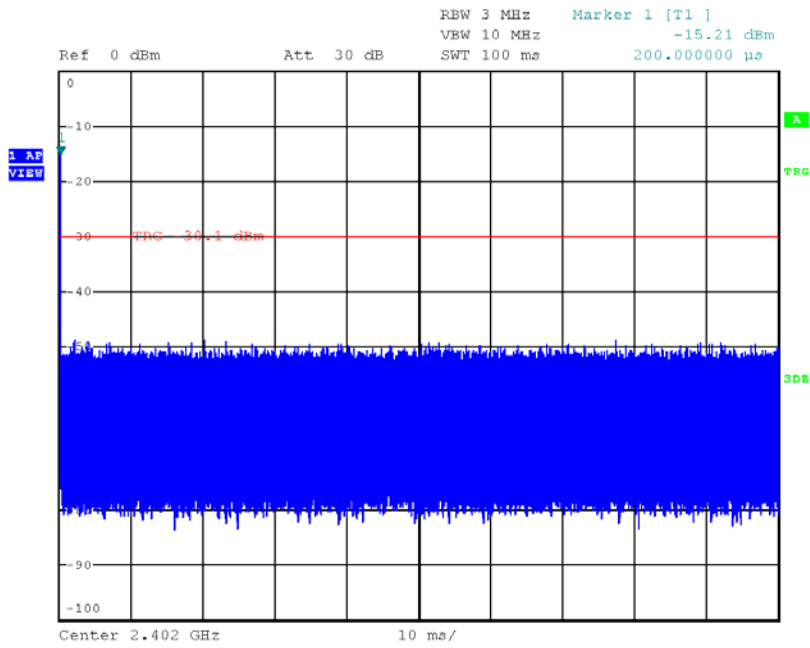

## TEST REPORT

### 5.0 EQUIPMENT LIST

#### 1) Radiated Emissions Test

Equipment	EMI Test Receiver	Double Ridged Guide Antenna	BiConiLog Antenna
Registration No.	EW-3156	EW-0194	EW-3061
Manufacturer	ROHDESCHWARZ	EMCO	EMCO
Model No.	ESR26	3115	3142E
Calibration Date	November 10, 2017	March 14, 2018	November 02, 2017
Calibration Due Date	November 10, 2018	September 14, 2019	November 02, 2018

Equipment	Spectrum Analyzer	12m Double Shield RF Cable (20MHz to 6GHz)	RF Cable (up to 40GHz)
Registration No.	EW-3281	EW-1852	EW-3155
Manufacturer	ROHDESCHWARZ	RADIALL	N/A
Model No.	FSV40	N(m)-RG142 - N(m)	1-40 GHz
Calibration Date	January 02, 2018	January 19, 2018	January 29, 2018
Calibration Due Date	January 02, 2019	January 19, 2019	January 29, 2019

Equipment	Notch Filter (cutoff frequency 2.4GHz to 2.5GHz)	Solid State Low Noise Preamplifier Assembly (1 - 18)GHz	RF Pre-amplifier (9kHz to 40GHz)
Registration No.	EW-2213	EW-3229	EW-3006
Manufacturer	MICROTRONICS	BONN ELEKTRO	SCHWARZBECK
Model No.	BRM50701-02	BLMA 0118-5G	BBV 9744
Calibration Date	May 24, 2018	January 30, 2018	April 26, 2018
Calibration Due Date	May 24, 2019	January 30, 2019	April 26, 2019

#### 2) Conductive Measurement Test

Equipment	Spectrum Analyzer	RF Cable (up to 40GHz) 1.5m length	RF Power Meter with Power Sensor (N1921A)
Registration No.	EW-2329	EW-3104	EW-2270
Manufacturer	R&S	N/A	N/A
Model No.	FSP3	SMA-M to SMA-M	AGILENTTECH
Calibration Date	September 28, 2017	July 03, 2018	January 15, 2018
Calibration Due Date	September 28, 2018	July 03, 2019	January 15, 2019

#### 3) Bandedge/Bandwidth Measurement

Equipment	Spectrum Analyzer
Registration No.	EW-2329
Manufacturer	R&S
Model No.	FSP3
Calibration Date	September 28, 2017
Calibration Due Date	September 28, 2018

**END OF TEST REPORT**