



TEST REPORT NUMBER: (8519)077-1052

TEST REPORT

TO:	GOODLY TOYS LTD	FAX:	--
ATTN:	KENT LEE	E-MAIL:	KENT@GOODLYTOYS.COM
ADDRESS	ROOM 502A,HARBOUR CRYSTAL CENTRE,100 GRANVILLE ROAD,TST EAST, KOWLOON ,HONGKONG		
TEST DATE	20 MARCH, 2019---17 APRIL, 2019		

MANUFACTURER OR SUPPLIER NAME	MEKBAO PLASTIC ELECTRONIC INDUSTRIAL CO LTD.
MANUFACTURER OR SUPPLIER ADDRESS:	Mekbao Plastic Electronic Industrial Co., Ltd. Jiaoxi Industry Areas, Lianxia Chenghai, Shantou City, Guangdong China
SAMPLE DESCRIPTION:	2.4G Slide N Stunt Tri-Wheeler RTR
MODEL OR STYLE NUMBER:	5588-617
RATED VOLTAGE:	2*1.5V
ADDITIONAL MODELS:	5588-613, 5588-614, 5588-615
FCC ID :	2APSK-5588004
IC:	24953-5588004
The submitted sample of the above equipment has been tested according to following standard(s)	
FCC Rules and Regulations Part 15 Subpart C 15.249, ANSI C63.10:2013 RSS-210 Issue 9 August 2016, RSS-Gen Issue 5	
CONCLUSION: The submitted sample was found to COMPLY with the test requirement	

Assistant Manager



Name: Nick Lung
Date: 17 APRIL, 2019



TEST REPORT NUMBER: (8519)077-1052

1. Summary of test results

The EUT have been tested according to the applicable standards as referenced below.		
Description of Test Item	Standard	Results
20dB Bandwidth and 99% Bandwidth	FCC Part 15: 15.215 ANSI C63.10:2013 RSS-210 Issue 9	PASS
Radiated Emission	FCC Part 15: 15.209 FCC Part 15: 15.249 ANSI C63.10:2013 RSS-210 Issue 9 RSS-Gen Issue 5	PASS
Band Edge Compliance	FCC Part 15: 15.249 ANSI C63.10:2013 RSS-210 Issue 9 RSS-Gen Issue 5	PASS
Power Line Conducted Emission	FCC Part 15: 15.207 ANSI C63.10: 2013 RSS-Gen Issue 5	N/A
Antenna requirement	FCC Part 15: 15.203 RSS-Gen Issue 5	PASS
N/A is an abbreviation for Not Applicable.		



TEST REPORT NUMBER: (8519)077-1052

2. General test information

2.1. Description of EUT

Power supply	: DC 3V from batteries (2*1.5V "AA" batteries)
Operation frequency	: 2405MHz-2480MHz
Modulation	: GFSK
Antenna Type	: Dedicated Antenna, maximum PK gain: 0dBi

EUT channels and frequencies list:

Channel	Frequency	Channel	Frequency	Channel	Frequency
0	2405MHz	24	2430MHz	48	2454MHz
1	2407MHz	25	2431MHz	49	2455MHz
2	2408MHz	26	2432MHz	50	2456MHz
3	2409MHz	27	2433MHz	51	2457MHz
4	2410MHz	28	2434MHz	52	2458MHz
5	2411MHz	29	2435MHz	53	2459MHz
6	2412MHz	30	2436MHz	54	2460MHz
7	2413MHz	31	2437MHz	55	2461MHz
8	2414MHz	32	2438MHz	56	2462MHz
9	2415MHz	33	2439MHz	57	2463MHz
10	2416MHz	34	2440MHz	58	2464MHz
11	2417MHz	35	2441MHz	59	2465MHz
12	2418MHz	36	2442MHz	60	2466MHz
13	2419MHz	37	2443MHz	61	2467MHz
14	2420MHz	38	2444MHz	62	2468MHz
15	2421MHz	39	2445MHz	63	2469MHz
16	2422MHz	40	2446MHz	64	2470MHz
17	2423MHz	41	2447MHz	65	2471MHz
18	2424MHz	42	2448MHz	66	2472MHz
19	2425MHz	43	2449MHz	67	2473MHz
20	2426MHz	44	2450MHz	68	2474MHz
21	2427MHz	45	2451MHz	69	2475MHz
22	2428MHz	46	2452MHz	70	2480MHz
23	2429MHz	47	2453MHz		

2.2. Accessories of EUT

Description of Accessories	Manufacturer	Model number	Serial No.	Other
N/A	N/A	N/A	N/A	N/A



TEST REPORT NUMBER: (8519)077-1052

2.3. Assistant equipment used for test

Assistant equipment	Manufacturer	Model number	Serial No.	Other
N/A	N/A	N/A	N/A	N/A

2.4. Block diagram of EUT configuration for test

Tx Mode:



For Tx Mode, A special test firmware was installed in EUT and which can exercise the EUT work in continues RF test mode at specified test channel as below:

Note: New battery is used during all test

Tested mode, channel, information		
Mode	Channel	Frequency (MHz)
GFSK Tx mode	Low	2405
	Middle	2448
	High	2480

2.5. Test environment conditions

During the measurement the environmental conditions were within the listed ranges:

Temperature range:	21-25°C
Humidity range:	40-75%
Pressure range:	86-106kPa

2.6. Deviations of test standard

No Deviation.

2.7. Test laboratory

Dongguan Dongdian Testing Service Co., Ltd

Add: No. 17, Zongbu Road 2, Songshan Lake Sci&Tech, Industry Park, Dongguan City, Guangdong Province, China, 523808

Tel: +86-0769-38826678, <http://www.dgddt.com>, Email: ddt@dgddt.com

CNAS Accreditation No. L6451; A2LA Accreditation No. 3870.01

FCC Designation Number: CN1182; FCC Test Firm Registration Number: 540522

Industry Canada site registration number: 10288A-1

Result reviewed by Centre of Testing Service (Ningbo) Co, Ltd Guangzhou Branch - a Bureau Veritas Company

Address: Building A, No.65 Zhuji Highway, Jishancun, Tianhe District, Guangzhou, China



TEST REPORT NUMBER: (8519)077-1052

2.8. Measurement uncertainty

Test Item	Uncertainty
Bandwidth	1.1%
Peak Output Power(Conducted)(Spectrum analyzer)	0.86dB (10MHz ≤ f < 3.6GHz);
	1.38dB (3.6GHz ≤ f < 8GHz)
Peak Output Power(Conducted)(Power Sensor)	0.74dB
Power Spectral Density	0.74dB (10MHz ≤ f < 3.6GHz);
	1.38dB (3.6GHz ≤ f < 8GHz)
Conducted spurious emissions	0.86dB (10MHz ≤ f < 3.6GHz);
	1.40dB (3.6GHz ≤ f < 8GHz)
	1.66dB (8GHz ≤ f < 22GHz)
Uncertainty for radio frequency (RBW<20kHz)	3×10 ⁻⁸
Temperature	0.4°C
Humidity	2%
Uncertainty for Radiation Emission test (30MHz-1GHz)	4.70dB (Antenna Polarize: V)
	4.84dB (Antenna Polarize: H)
Uncertainty for Radiation Emission test (1GHz-18GHz)	4.10dB (1-6GHz)
	4.40dB (6GHz-18Gz)
Uncertainty for Power line conduction emission test	3.32dB (150kHz-30MHz)
Note: This uncertainty represents an expanded uncertainty expressed at approximately the 95% confidence level using a coverage factor of k=2.	



TEST REPORT NUMBER: (8519)077-1052

3. Equipment used during test

Equipment	Manufacturer	Model No.	Serial No.	Last Cal.	Cal. Interval
RF Connected Test (Tonscend RF Measurement System)					
Spectrum analyzer	R&S	FSU26	200071	Oct. 12, 2018	1 Year
Wideband Radio Communication tester	R&S	CMW500	117491	Jun. 29, 2018	1 Year
Vector Signal Generator	Agilent	E8267D	US49060192	Oct. 12, 2018	1 Year
Vector Signal Generator	Agilent	N5182A	MY48180737	Jun. 29, 2018	1 Year
Power Sensor	Agilent	U2021XA	MY55150010	Oct. 21, 2018	1 Year
Power Sensor	Agilent	U2021XA	MY55150011	Oct. 23, 2018	1 Year
DC Power Source	MATRIS	MPS-3005L-3	D813058W	Aug. 18, 2018	1 Year
Attenuator	Mini-Circuits	BW-S10W2	101109	Aug. 18, 2018	1 Year
RF Cable	Micable	C10-01-01-1	100309	Oct. 21, 2018	1 Year
Temp&Humi Programmable	ZHIXIANG	ZXGDJS-150L	ZX170110-A	Oct. 21, 2018	1 Year
Test Software	JS Tonscend	JS1120-3	Ver.2.7	N/A	N/A
Radiated Emission Test Chamber 1#					
EMI Test Receiver	R&S	ESU8	100316	Oct. 12, 2018	1 Year
Spectrum analyzer	Agilent	E4447A	MY50180031	Jun. 29, 2018	1 Year
Trilog Broadband Antenna	Schwarzbeck	VULB9163	9163-462	Nov. 09, 2018	1 Year
Active Loop antenna	Schwarzbeck	FMZB-1519	1519-038	Oct. 20, 2018	1 Year
Double Ridged Horn Antenna	R&S	HF907	100276	Nov. 16, 2018	1 Year
Broad Band Horn Antenna	Schwarzbeck	BBHA 9170	790	Oct. 25, 2018	1 Year
Pre-amplifier	A.H.	PAM-0118	360	Oct. 12, 2018	1 Year
Pre-amplifier	TERA-MW	TRLA-0040 G35	101303	Oct. 12, 2018	1 Year
RF Cable	HUBSER	CP-X2+ CP-X1	W11.03+ W12.02	Oct. 21, 2018	1 Year
RF Cable	N/A	SMAJ-SMA J-1M+ 11M	17070133+17070131	Nov. 08, 2018	1 Year
MI Cable	HUBSER	C10-01-01-1 M	1091629	Oct. 21, 2018	1 Year
Test software	Audix	E3	V 6.11111b	N/A	N/A

TEST REPORT NUMBER: (8519)077-1052

4. 20dB Bandwidth and 99% Bandwidth

4.1. Block diagram of test setup

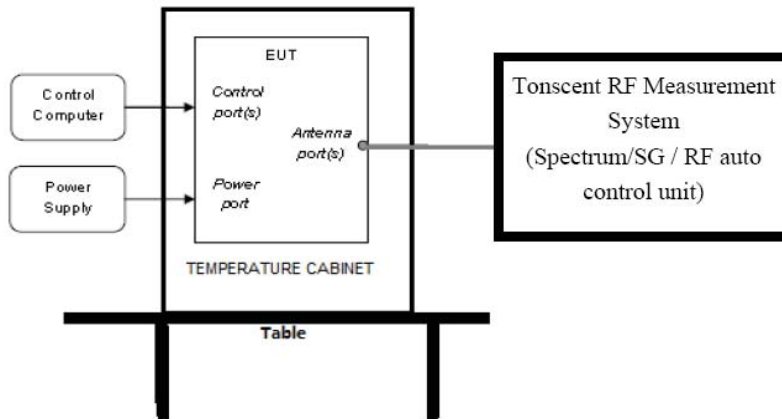

4.2. Limits

Intentional radiators operating under the alternative provisions to the general emission limits, as contained in § 15.217 through 15.257 and in Subpart E of this part, must be designed to ensure that the 20 dB bandwidth of the emission, or whatever bandwidth may otherwise be specified in the specific rule section under which the equipment operates, is contained within the frequency band designated in the rule section under which the equipment is operated.

4.3. Test Procedure

(1) Connect EUT's antenna output to spectrum analyzer by RF cable.

(2) Set the spectrum analyzer as follows:

RBW:	30kHz
VBW:	100kHz
Detector Mode:	Peak
Sweep time:	auto
Trace mode	Max hold

(3) Allow the trace to stabilize, measure the 20dB bandwidth of signal.

4.4. Test Result

Mode	Freq (MHz)	20dB bandwidth Result (MHz)	99% bandwidth Result (MHz)	Conclusion
GFSK	2405	1.250	1.442	PASS
	2448	1.242	1.202	PASS
	2480	1.242	1.218	PASS

TEST REPORT NUMBER: (8519)077-1052

4.5. Original test data

20dB Bandwidth:

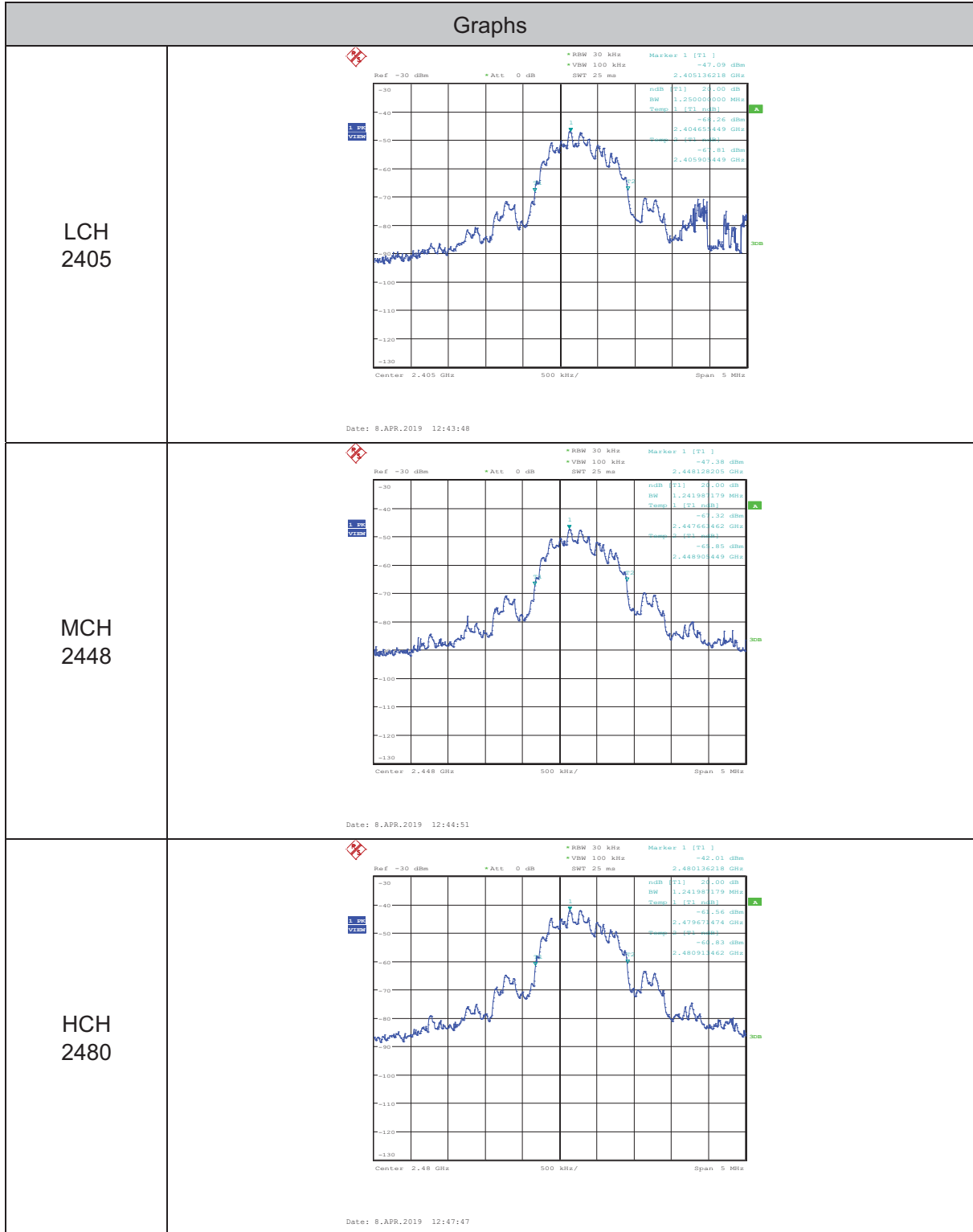

TEST REPORT NUMBER: (8519)077-1052

99% Bandwidth:

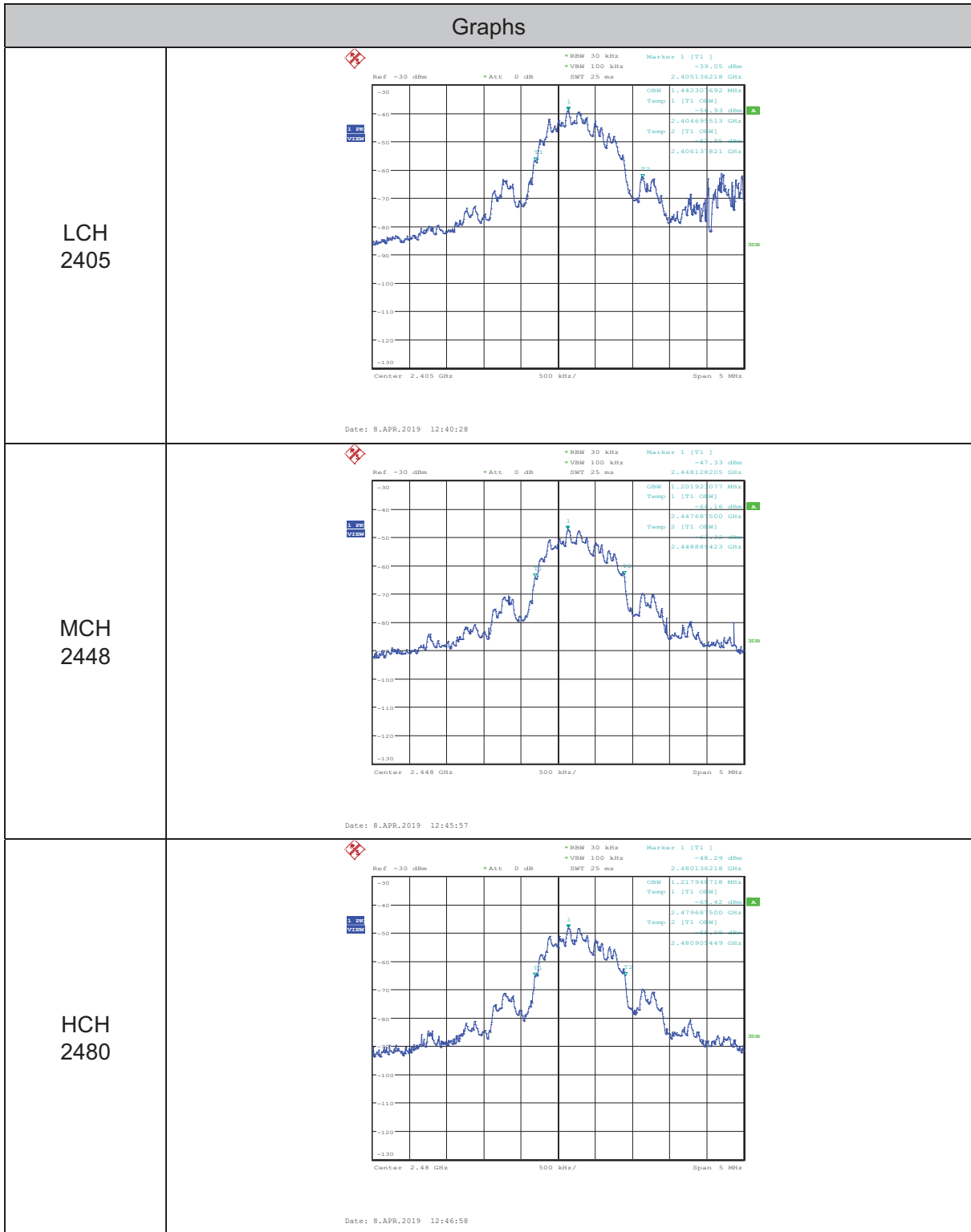

TEST REPORT NUMBER: (8519)077-1052

5. Radiated emission

5.1. Block diagram of test setup

In 3m Anechoic Chamber Test Setup Diagram for 9kHz-30MHz

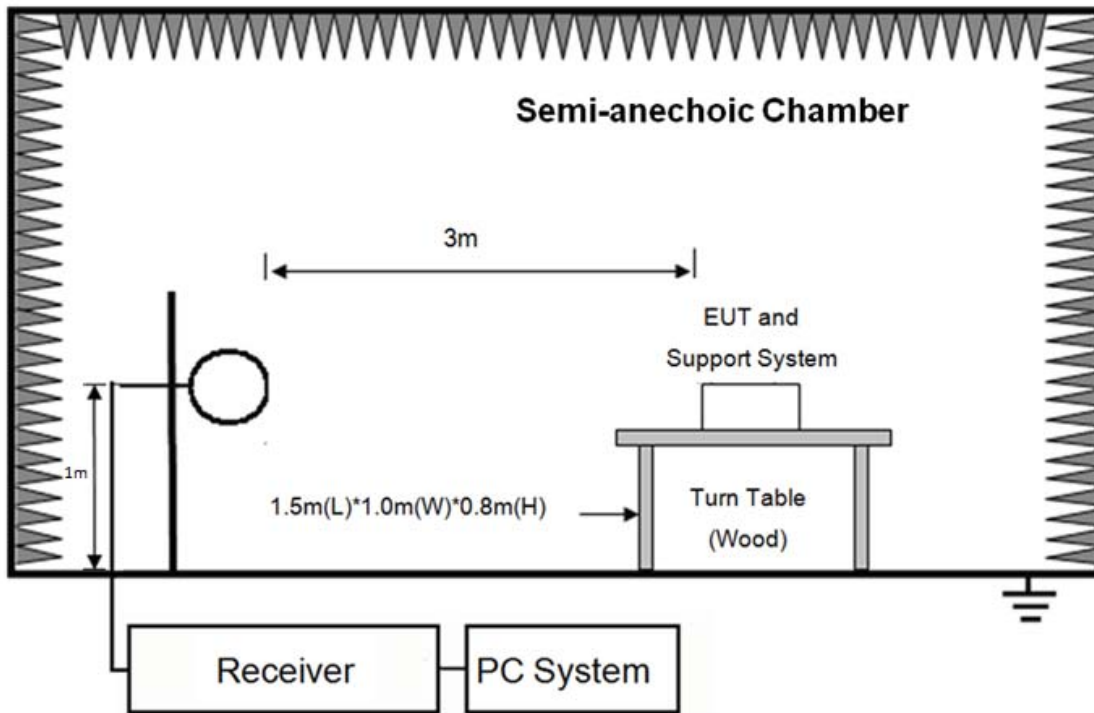

In 3m Anechoic Chamber Test Setup Diagram for 30MHz-1GHz

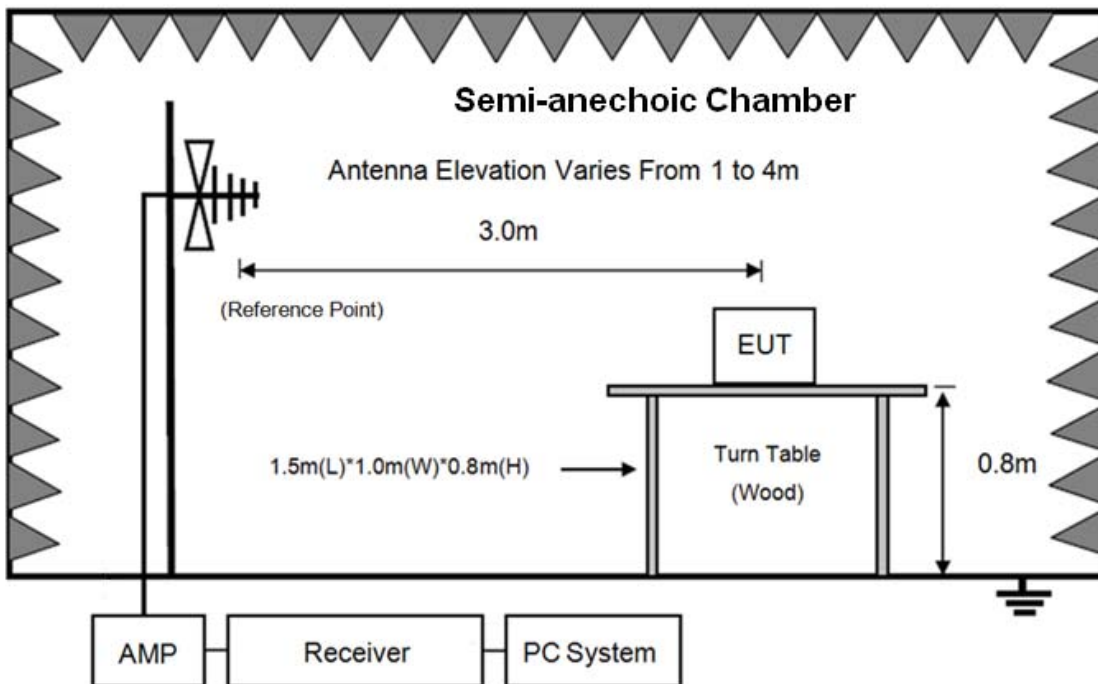

TEST REPORT NUMBER: (8519)077-1052

In 3m Anechoic Chamber Test Setup Diagram for frequency above 1GHz

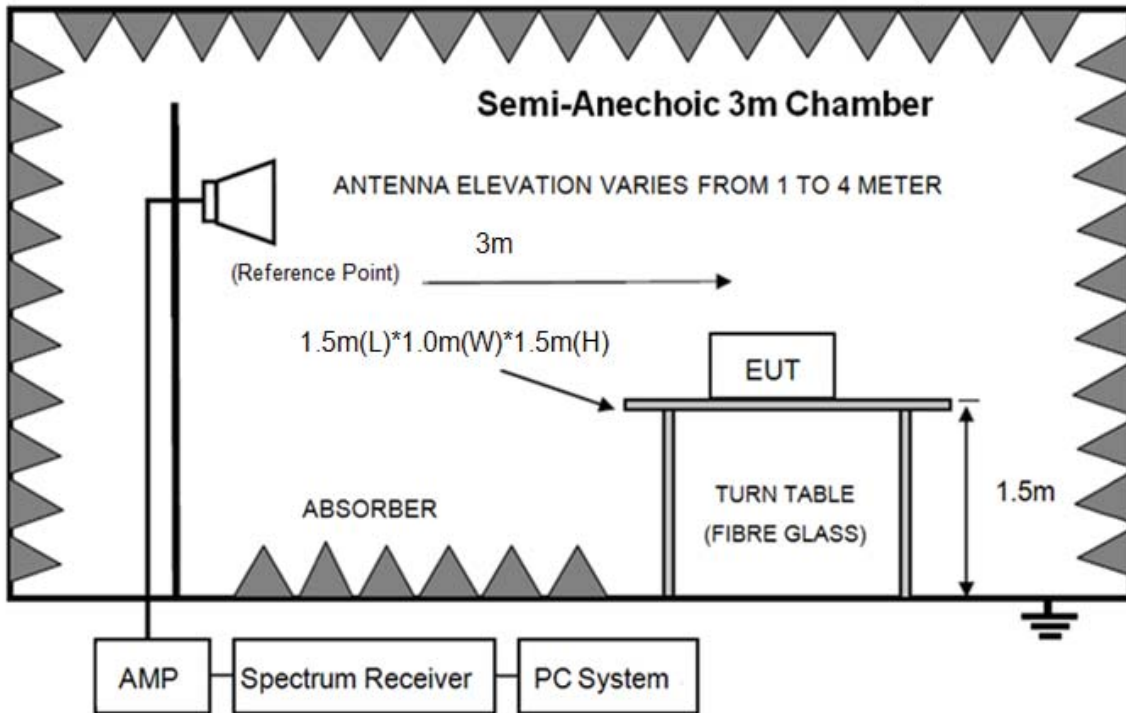

Note: For harmonic emissions test an appropriate high pass filter was inserted in the input port of AMP.

5.2. Limit

FREQUENCY MHz	DISTANCE Meters	FIELD STRENGTHS LIMIT	
		$\mu\text{V}/\text{m}$	$\text{dB}(\mu\text{V})/\text{m}$
30 ~ 88	3	100	40.0
88 ~ 216	3	150	43.5
216 ~ 960	3	200	46.0
960 ~ 1000	3	500	54.0
Above 1000MHz	3	74.0 $\text{dB}(\mu\text{V})/\text{m}$ (Peak) 54.0 $\text{dB}(\mu\text{V})/\text{m}$ (Average)	
Field Strength of Fundamental emission for 2.4GHz-2.4835GHz	3	94.0 $\text{dB}(\mu\text{V})/\text{m}$ (Average) 114.0 $\text{dB}(\mu\text{V})/\text{m}$ (Peak)	
Field Strength of Harmonics	3	74.0 $\text{dB}(\mu\text{V})/\text{m}$ (Peak) 54.0 $\text{dB}(\mu\text{V})/\text{m}$ (Average)	

Remark:

- (1) Emission level $\text{dB}\mu\text{V} = 20 \log$ Emission level $\mu\text{V}/\text{m}$
- (2) The smaller limit shall apply at the cross point between two frequency bands.
- (3) Distance is the distance in meters between the measuring instrument, antenna and the closest point of any part of the device or system.
- (4) The emission limits shown in the above table are based on measurements employing a



TEST REPORT NUMBER: (8519)077-1052

CISPR quasi-peak detector except for the frequency bands 9-90 kHz, 110-490 kHz and above 1000 MHz. Radiated emission limits in these three bands are based on measurements employing an average detector.

5.3. Test Procedure

- (1) EUT was placed on a non-metallic table, 80 cm above the ground plane inside a semi-anechoic chamber.
- (2) Setup EUT and assistant system according clause 2.3 and 4.2
- (3) Test antenna was located 3m from the EUT on an adjustable mast. Below pre-scan procedure was first performed in order to find prominent radiated emissions.
 - (a) Change work frequency or channel of device if practicable.
 - (b) Change modulation type of device if practicable.
 - (c) Change power supply range from 85% to 115% of the rated supply voltage
 - (d) Rotated EUT though three orthogonal axes to determine the attitude of EUT arrangement produces highest emissions
- (4) Spectrum frequency from 9kHz to 25GHz (tenth harmonic of fundamental frequency) was investigated, and no any obvious emission were detected from 9kHz to 30MHz and 18GHz to 25GHz, so below final test was performed with frequency range from 30MHz to 18GHz.
- (5) For final emissions measurements at each frequency of interest, the EUT were rotated and the antenna height was varied between 1m and 4m in order to maximize the emission. Measurements in both horizontal and vertical polarities were made and the data was recorded. In order to find the maximum emission, the relative positions of equipments and all of the interface cables were changed according to ANSI C63.10:2013 on Radiated Emission test.
- (6) For emissions from 30MHz to 1GHz, Quasi-Peak values were measured with EMI Receiver and the bandwidth of Receiver is 120 kHz.
- (7) For emissions above 1GHz, both Peak and Average level were measured with Spectrum Analyzer, and the RBW is set at 1MHz, VBW is set at 3MHz for Peak measure; RBW is set at 1MHz, VBW is set at 10Hz for Average measure. Peak detector is used for both PK and AV test.
- (8) For fundamental frequency test, set spectrum analyzer's RBW=3MHz, VBW=10MHz. peak detector for PK, RMS detector for AV, Read the Level in spectrum analyzer and record.
- (9) X axis, Y axis, Z axis are tested, and worse setup X axis is reported.



TEST REPORT NUMBER: (8519)077-1052

5.4 Test result

PASS. (See below detailed test result)

All the emissions except fundamental emission from 9kHz to 25GHz were comply with 15.209 limit.

Note1: According exploratory test no any obvious emission were detected from 9kHz to 30MHz and 18GHz to 25GHz, so the final test was performed with frequency range from 30MHz to 18GHz and recorded in below.

Note2: For emissions below 1GHz, according exploratory explorer test, when change Tx mode and channel, have no distinct influence on emissions level, so for emissions below 1GHz, the final test was only performed with EUT working in GFSK, Tx 2405MHz mode.

Note3: For emissions above 1GHz. If peak results comply with AV limit, AV Result is deemed to comply with AV limit.



TEST REPORT NUMBER: (8519)077-1052

Radiated Emission test (below 1GHz)

TR-4-E-009 Radiated Emission Test Result

: DDT 3m Chamber 1# D:\2019 RE1# Report Data\BV Report\85190771052
2.4G\RF.EM6
Test Date : 2019-03-21 **Tested By** : Sunny
EUT : 2.4G Slide N Stunt Tri-Wheeler RTR **Model Number** : 5588-617
Power Supply : DC 3V **Test Mode** : Tx mode
Condition : Temp:24.5°C, Humi:55%, Press:101.4kPa **Antenna/Distance** : 2018 VULB 9163 1#/3m/HORIZONTAL
Memo :

Data: 1

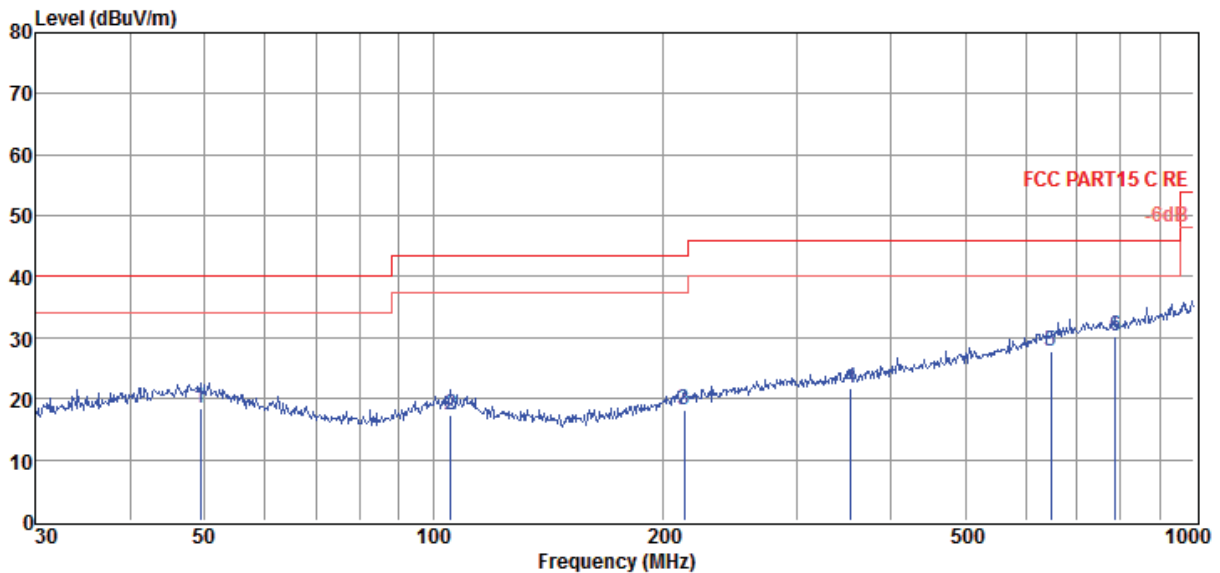

Item (Mark)	Freq. (MHz)	Read Level (dBμV)	Antenna Factor (dB/m)	Cable Loss dB	Result Level (dBμV/m)	Limit Line (dBμV/m)	Over Limit (dB)	Detector	Polarization
1	49.36	0.15	14.53	3.86	18.54	40.00	-21.46	QP	HORIZONTAL
2	105.27	1.40	11.75	4.23	17.38	43.50	-26.12	QP	HORIZONTAL
3	213.76	1.47	11.83	4.86	18.16	43.50	-25.34	QP	HORIZONTAL
4	354.18	1.41	14.92	5.37	21.70	46.00	-24.30	QP	HORIZONTAL
5	647.39	2.22	19.29	6.23	27.74	46.00	-18.26	QP	HORIZONTAL
6	787.85	3.01	20.63	6.58	30.22	46.00	-15.78	QP	HORIZONTAL

- Note: 1. Result Level = Read Level + Antenna Factor + Cable loss.
 2. If Peak Result complies with QP limit, QP Result is deemed to comply with QP limit.
 3. Test setup: RBW: 120 kHz, VBW: 300 kHz, Sweep time: auto.



TEST REPORT NUMBER: (8519)077-1052

TR-4-E-009 Radiated Emission Test Result

: DDT 3m Chamber 1#

D:\2019 RE1# Report Data\BV Report\85190771052
2.4GIRF.EM6

Test Date : 2019-03-21

Tested By : Sunny

EUT : 2.4G Slide N Stunt Tri-Wheeler RTR

Model Number : 5588-617

Power Supply : DC 3V

Test Mode : Tx mode

Condition : Temp:24.5'C, Humi:55%, Press:101.4kPa Antenna/Distance : 2018 VULB 9163 1#/3m/VERTICAL

Memo :

Data: 2

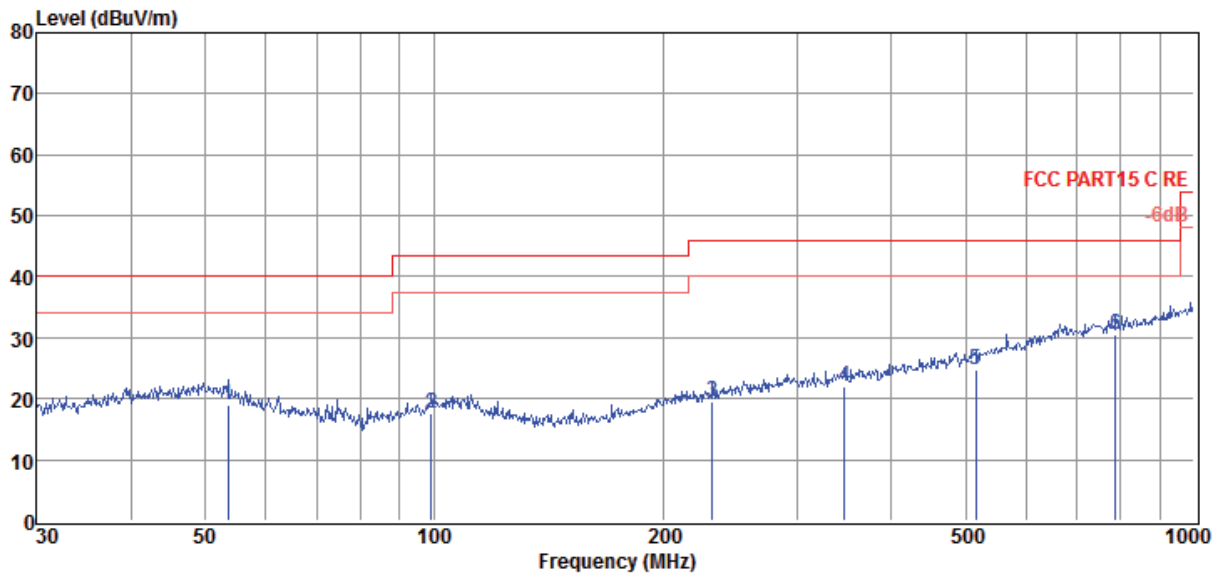

Item (Mark)	Freq. (MHz)	Read Level (dB μ V)	Antenna Factor (dB/m)	Cable Loss dB	Result Level (dB μ V/m)	Limit Line (dB μ V/m)	Over Limit (dB)	Detector	Polarization
1	53.51	1.65	13.41	3.90	18.96	40.00	-21.04	QP	VERTICAL
2	99.18	1.81	11.57	4.20	17.58	43.50	-25.92	QP	VERTICAL
3	232.53	2.12	12.37	4.93	19.42	46.00	-26.58	QP	VERTICAL
4	346.81	1.91	14.81	5.34	22.06	46.00	-23.94	QP	VERTICAL
5	515.44	1.47	17.33	5.87	24.67	46.00	-21.33	QP	VERTICAL
6	787.85	3.44	20.63	6.58	30.65	46.00	-15.35	QP	VERTICAL

Note: 1. Result Level = Read Level + Antenna Factor + Cable loss.

2. If Peak Result complies with QP limit, QP Result is deemed to comply with QP limit.

3. Test setup: RBW: 120 kHz, VBW: 300 kHz, Sweep time: auto.



TEST REPORT NUMBER: (8519)077-1052

Radiated Emission test (above 1GHz)

Freq. (MHz)	Read level (dBµV)	Antenna Factor (dB/m)	PRM Factor (dB)	Cable Loss (dB)	Result Level (dBµV/m)	Limit (dBµV/m)	Margin (dB)	Detector type	Polarization
GFSK Tx mode 2405MHz									
2405.00	83.44	29.13	44.18	4.58	72.97	114.00	-41.03	Peak	HORIZONTAL
2405.00	48.89	29.13	44.18	4.58	38.42	94.00	-55.58	Average	HORIZONTAL
4806.00	52.24	33.79	44.24	11.26	53.05	74.00	-20.95	Peak	HORIZONTAL
5741.00	50.38	34.50	44.05	11.29	52.12	74.00	-21.88	Peak	HORIZONTAL
7413.00	45.69	35.85	43.34	13.09	51.29	74.00	-22.71	Peak	HORIZONTAL
8953.00	44.15	36.80	43.60	14.18	51.53	74.00	-22.47	Peak	HORIZONTAL
10064.00	38.55	37.44	44.08	15.49	47.40	74.00	-26.60	Peak	HORIZONTAL
10702.00	38.17	37.62	43.90	15.86	47.75	74.00	-26.25	Peak	HORIZONTAL
2405.00	76.73	29.13	44.18	4.58	66.26	114.00	-47.74	Peak	VERTICAL
2405.00	47.59	29.13	44.18	4.58	37.12	94.00	-56.88	Average	VERTICAL
4806.00	47.17	33.79	44.24	11.26	47.98	74.00	-26.02	Peak	VERTICAL
5741.00	48.49	34.50	44.05	11.29	50.23	74.00	-23.77	Peak	VERTICAL
6819.00	44.93	35.49	43.60	12.35	49.17	74.00	-24.83	Peak	VERTICAL
8414.00	44.06	36.72	43.33	13.63	51.08	74.00	-22.92	Peak	VERTICAL
9536.00	45.16	37.13	43.89	14.74	53.14	74.00	-20.86	Peak	VERTICAL
10647.00	40.02	37.64	43.91	15.79	49.54	74.00	-24.46	Peak	VERTICAL
GFSK Tx mode 2448MHz									
2448.00	82.62	29.21	44.20	4.75	72.38	114.00	-41.62	Peak	HORIZONTAL
2448.00	48.54	29.21	44.20	4.75	38.30	94.00	-55.70	Average	HORIZONTAL
4806.00	49.85	33.79	44.24	11.26	50.66	74.00	-23.34	Peak	HORIZONTAL
6214.00	45.04	34.96	43.89	12.23	48.34	74.00	-25.66	Peak	HORIZONTAL
7369.00	44.62	35.82	43.36	12.96	50.04	74.00	-23.96	Peak	HORIZONTAL
8491.00	44.07	36.79	43.37	14.02	51.51	74.00	-22.49	Peak	HORIZONTAL
9426.00	45.38	37.06	43.84	14.82	53.42	74.00	-20.58	Peak	HORIZONTAL
10713.00	39.14	37.61	43.90	15.88	48.73	74.00	-25.27	Peak	HORIZONTAL
2448.00	77.71	29.21	44.20	4.75	67.47	114.00	-46.53	Peak	VERTICAL
2448.00	47.56	29.21	44.20	4.75	37.32	94.00	-56.68	Average	VERTICAL
5609.00	45.92	34.39	44.07	11.18	47.42	74.00	-26.58	Peak	VERTICAL
6786.00	44.10	35.47	43.61	12.32	48.28	74.00	-25.72	Peak	VERTICAL
7919.00	43.71	36.24	43.13	13.85	50.67	74.00	-23.33	Peak	VERTICAL
8986.00	44.01	36.80	43.62	14.31	51.50	74.00	-22.50	Peak	VERTICAL
9800.00	38.59	37.28	44.01	14.76	46.62	74.00	-27.38	Peak	VERTICAL
10735.00	37.69	37.60	43.89	15.91	47.31	74.00	-26.69	Peak	VERTICAL
GFSK Tx mode 2480MHz									
2480.00	82.49	29.26	44.21	4.88	72.42	114.00	-41.58	Peak	HORIZONTAL
2480.00	48.74	29.26	44.21	4.88	38.67	94.00	-55.33	Average	HORIZONTAL
5741.00	48.83	34.50	44.05	11.29	50.57	74.00	-23.43	Peak	HORIZONTAL
6808.00	44.36	35.49	43.60	12.36	48.61	74.00	-25.39	Peak	HORIZONTAL
7930.00	45.25	36.25	43.13	13.88	52.25	74.00	-21.75	Peak	HORIZONTAL



TEST REPORT NUMBER: (8519)077-1052

9404.00	45.64	37.05	43.82	14.89	53.76	74.00	-20.24	Peak	HORIZONTAL
10658.00	38.06	37.64	43.91	15.81	47.60	74.00	-26.40	Peak	HORIZONTAL
11296.00	34.71	38.16	43.74	16.71	45.84	74.00	-28.16	Peak	HORIZONTAL
2480.00	75.77	29.27	44.21	4.88	65.71	114.00	-48.29	Peak	VERTICAL
2480.00	47.48	29.27	44.21	4.88	37.42	94.00	-56.58	Average	VERTICAL
5939.00	45.99	34.65	44.01	11.39	48.02	74.00	-25.98	Peak	VERTICAL
7358.00	43.68	35.82	43.36	12.91	49.05	74.00	-24.95	Peak	VERTICAL
8480.00	42.94	36.78	43.36	13.97	50.33	74.00	-23.67	Peak	VERTICAL
9382.00	44.60	37.04	43.81	14.85	52.68	74.00	-21.32	Peak	VERTICAL
9965.00	38.30	37.38	44.08	15.47	47.07	74.00	-26.93	Peak	VERTICAL
10647.00	39.54	37.64	43.91	15.79	49.06	74.00	-24.94	Peak	VERTICAL
Result: Pass									

Note: 1. Result Level = Read Level + Antenna Factor + Cable loss - PRM Factor.

2. For emissions above 1GHz. If peak results comply with AV limit, AV Result is deemed to comply with AV limit.

TEST REPORT NUMBER: (8519)077-1052

6. Band Edge Compliance

6.1. Block diagram of test setup

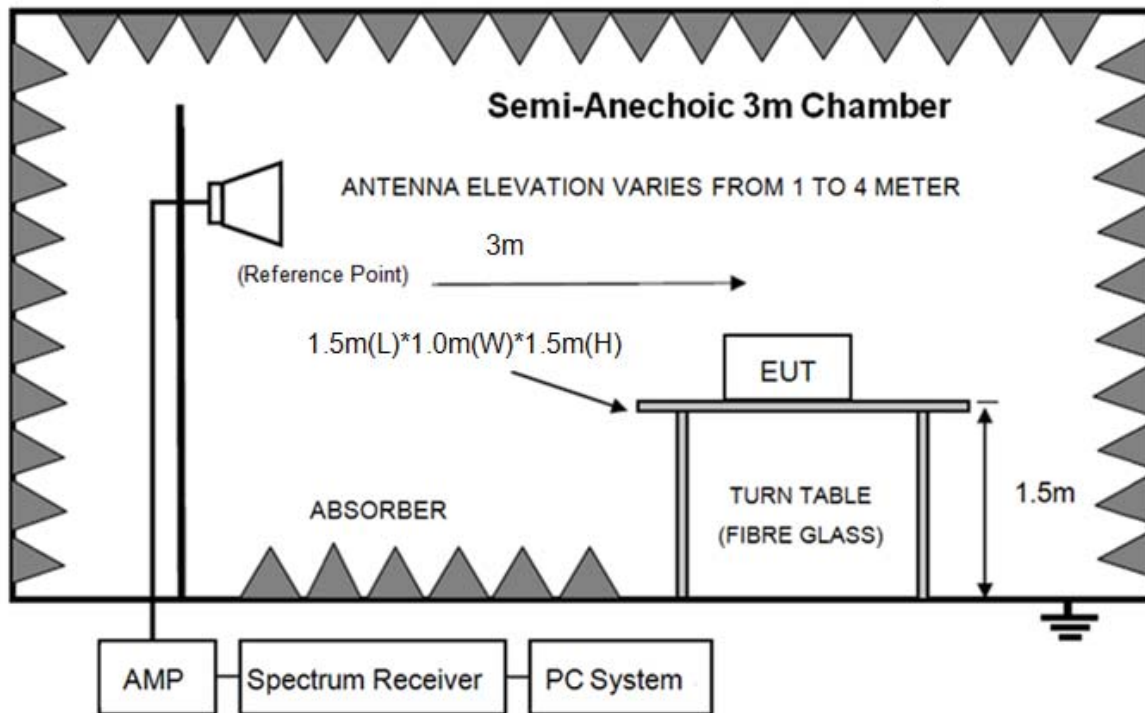

6.2. Limit

All the lower and upper band-edges emissions appearing within 2310MHz to 2390MHz and 2483.5MHz to 2500MHz restricted frequency bands shall not exceed the limits shown in 15.209, all the other emissions outside operation frequency band 2400MHz to 2483.5MHz and 5725MHz to 5850MHz shall be at least 20dB below the fundamental emissions, or comply with 15.209 limits.

6.3. Test Procedure

Same with clause 8.3 except change investigated frequency range from 2310MHz to 2415MHz and 2475MHz to 2500MHz.

Remark: All restriction band have been tested, and only the worst case is shown in report.

6.4. Test result

PASS. (See below detailed test result)



TEST REPORT NUMBER: (8519)077-1052

TR-4-E-009 Radiated Emission Test Result

Test Site : DDT 3m Chamber 1# D:\2019 RE1# Report Data\BV Report\85190771052
2.4G\RF.EM6
Test Date : 2019-04-08 **Tested By** : Sunny
EUT : 2.4G Slide N Stunt Tri-Wheeler RTR **Model Number** : 5588-617
Power Supply : DC 3V **Test Mode** : Tx mode
Condition : Temp:24.5°C, Humi:55%, Press:101.4kPa **Antenna/Distance** : 2018 HF 907/3m/HORIZONTAL
Memo : 2405MHz

Data: 42

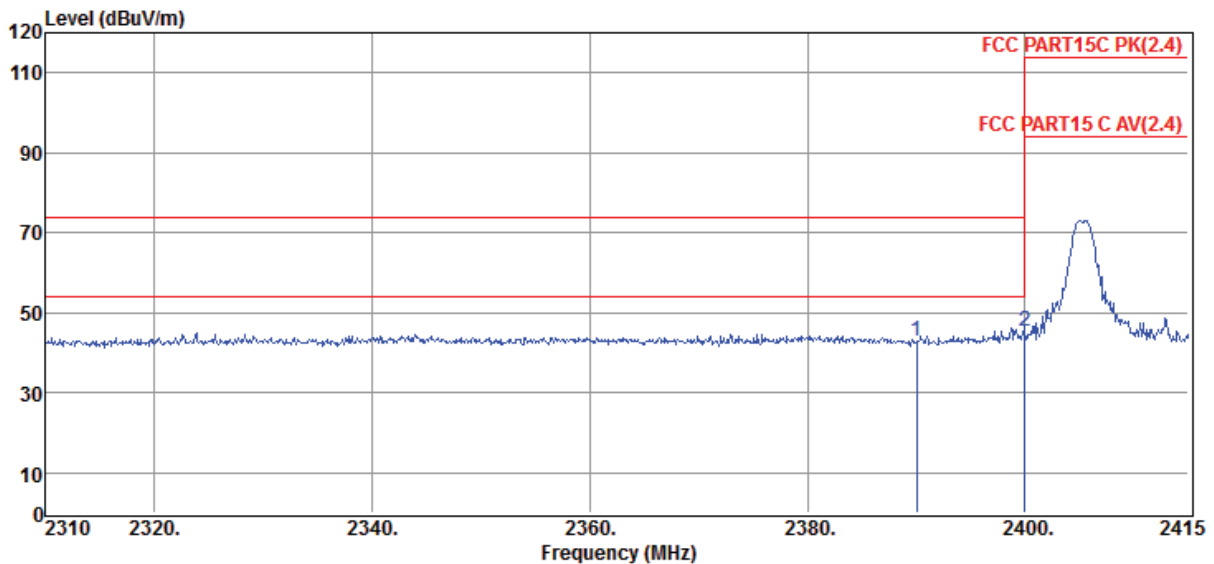

Item (Mark)	Freq. (MHz)	Read Level (dBμV)	Antenna Factor (dB/m)	PRM Factor dB	Cable Loss dB	Result Level (dBμV/m)	Limit Line (dBμV/m)	Over Limit (dB)	Detector	Polarization
1	2390.00	53.35	29.10	44.18	4.56	42.83	74.00	-31.17	Peak	HORIZONTAL
2	2400.00	55.83	29.12	44.18	4.56	45.33	74.00	-28.67	Peak	HORIZONTAL

- Note: 1. Result Level = Read Level + Antenna Factor + Cable loss - PRM Factor.
 2. If Peak Result complies with AV limit, AV Result is deemed to comply with AV limit.
 3. Test setup: RBW: 1 MHz, VBW: 3 MHz, Sweep time: auto.



TEST REPORT NUMBER: (8519)077-1052

TR-4-E-009 Radiated Emission Test Result

Test Site : DDT 3m Chamber 1# D:\2019 RE1# Report Data\BV Report\85190771052
2.4G\RF.EM6
Test Date : 2019-04-08 **Tested By** : Sunny
EUT : 2.4G Slide N Stunt Tri-Wheeler RTR **Model Number** : 5588-617
Power Supply : DC 3V **Test Mode** : Tx mode
Condition : Temp:24.5°C, Humi:55%, Press:101.4kPa **Antenna/Distance** : 2018 HF 907/3m/VERTICAL
Memo : 2405MHz

Data: 43

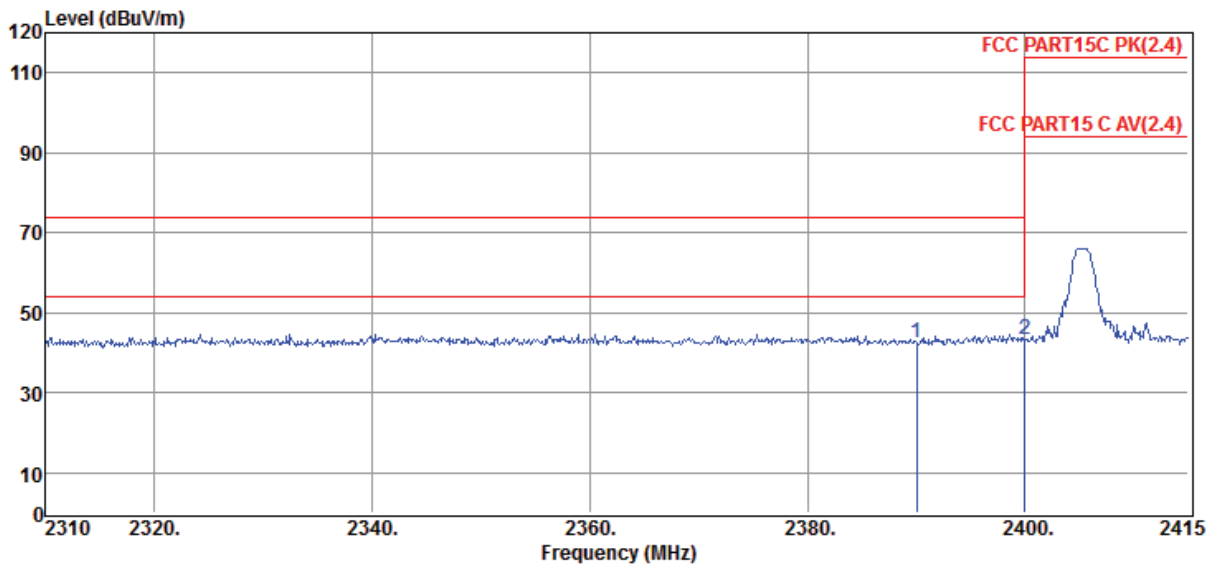

Item (Mark)	Freq. (MHz)	Read Level (dBμV)	Antenna Factor (dB/m)	PRM Factor (dB)	Cable Loss (dB)	Result Level (dBμV/m)	Limit Line (dBμV/m)	Over Limit (dB)	Detector	Polarization
1	2390.00	53.08	29.10	44.18	4.56	42.56	74.00	-31.44	Peak	VERTICAL
2	2400.00	53.98	29.12	44.18	4.56	43.48	74.00	-30.52	Peak	VERTICAL

- Note: 1. Result Level = Read Level + Antenna Factor + Cable loss - PRM Factor.
 2. If Peak Result complies with AV limit, AV Result is deemed to comply with AV limit.
 3. Test setup: RBW: 1 MHz, VBW: 3 MHz, Sweep time: auto.



TEST REPORT NUMBER: (8519)077-1052

TR-4-E-009 Radiated Emission Test Result

Test Site : DDT 3m Chamber 1# D:\2019 RE1# Report Data\BV Report\85190771052
2.4G\RF.EM6
Test Date : 2019-04-08 **Tested By** : Sunny
EUT : 2.4G Slide N Stunt Tri-Wheeler RTR **Model Number** : 5588-617
Power Supply : DC 3V **Test Mode** : Tx mode
Condition : Temp:24.5'C, Humi:55%, Press:101.4kPa **Antenna/Distance** : 2018 HF 907/3m/HORIZONTAL
Memo : 2480MHz

Data: 44

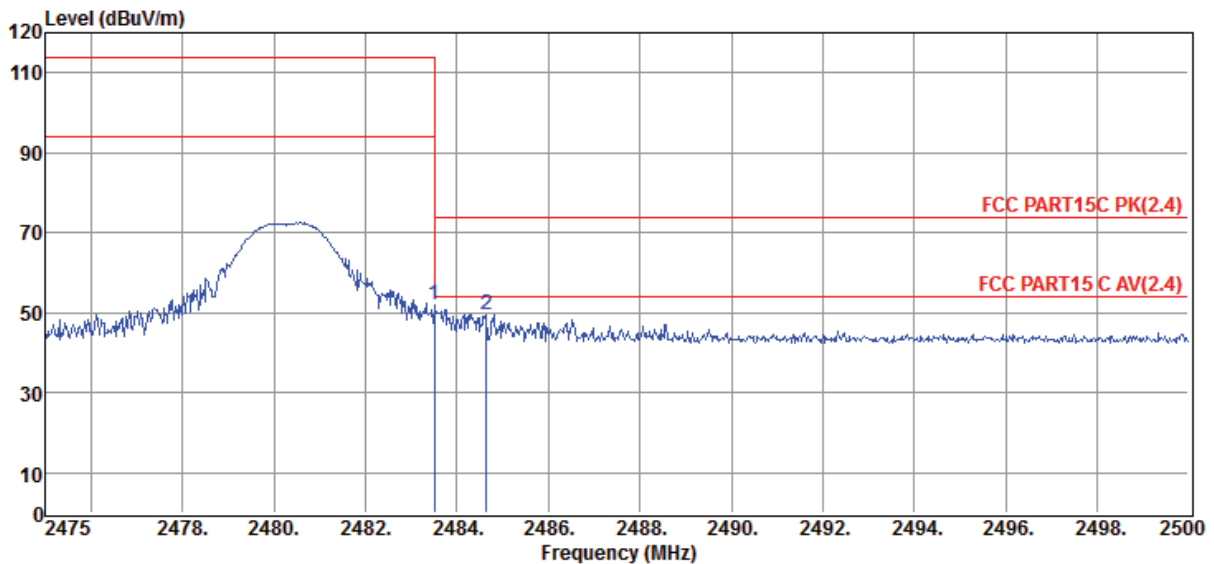

Item (Mark)	Freq. (MHz)	Read Level (dBμV)	Antenna Factor (dB/m)	PRM Factor dB	Cable Loss dB	Result Level (dBμV/m)	Limit Line (dBμV/m)	Over Limit (dB)	Detector	Polarization
1	2483.50	61.85	29.27	44.21	4.89	51.80	74.00	-22.20	Peak	HORIZONTAL
2	2484.65	59.49	29.27	44.21	4.90	49.45	74.00	-24.55	Peak	HORIZONTAL

- Note: 1. Result Level = Read Level + Antenna Factor + Cable loss - PRM Factor.
 2. If Peak Result complies with AV limit, AV Result is deemed to comply with AV limit.
 3. Test setup: RBW: 1 MHz, VBW: 3 MHz, Sweep time: auto.



TEST REPORT NUMBER: (8519)077-1052

TR-4-E-009 Radiated Emission Test Result

Test Site : DDT 3m Chamber 1# D:\2019 RE1# Report Data\BV Report\85190771052
2.4G\RF.EM6
Test Date : 2019-04-08 **Tested By** : Sunny
EUT : 2.4G Slide N Stunt Tri-Wheeler RTR **Model Number** : 5588-617
Power Supply : DC 3V **Test Mode** : Tx mode
Condition : Temp:24.5°C, Humi:55%, Press:101.4kPa **Antenna/Distance** : 2018 HF 907/3m/VERTICAL
Memo : 2480MHz

Data: 45

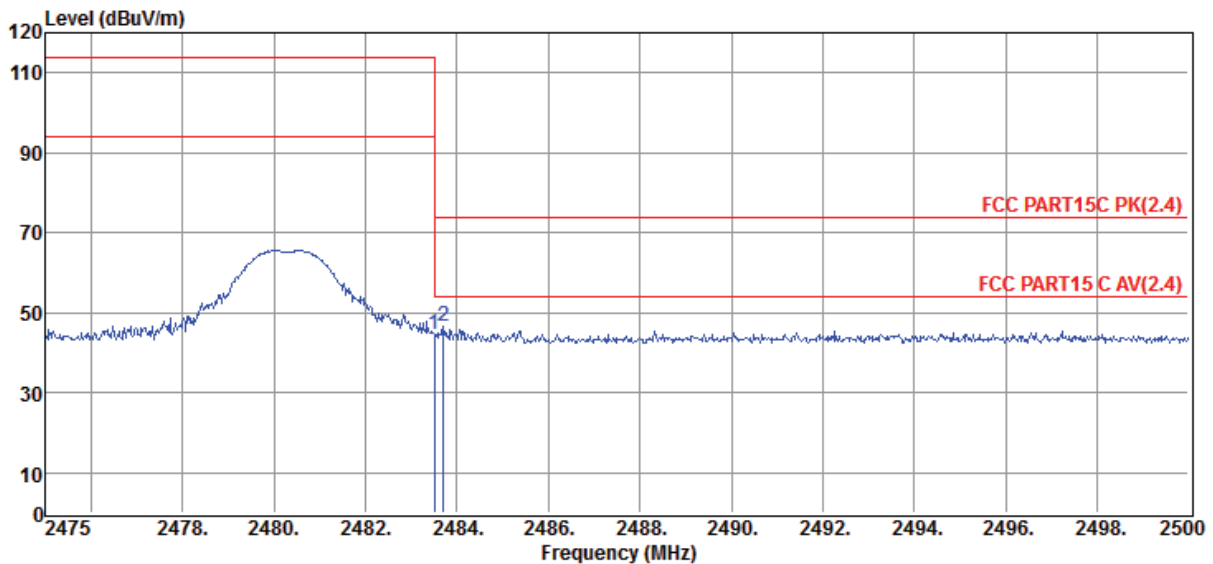

Item (Mark)	Freq. (MHz)	Read Level (dBμV)	Antenna Factor (dB/m)	PRM Factor dB	Cable Loss dB	Result Level (dBμV/m)	Limit Line (dBμV/m)	Over Limit (dB)	Detector	Polarization
1	2483.50	54.45	29.27	44.21	4.89	44.40	74.00	-29.60	Peak	VERTICAL
2	2483.70	56.48	29.27	44.21	4.89	46.43	74.00	-27.57	Peak	VERTICAL

- Note: 1. Result Level = Read Level + Antenna Factor + Cable loss - PRM Factor.
 2. If Peak Result complies with AV limit, AV Result is deemed to comply with AV limit.
 3. Test setup: RBW: 1 MHz, VBW: 3 MHz, Sweep time: auto.

TEST REPORT NUMBER: (8519)077-1052

7. Power Line Conducted Emission

7.1. Block diagram of test setup

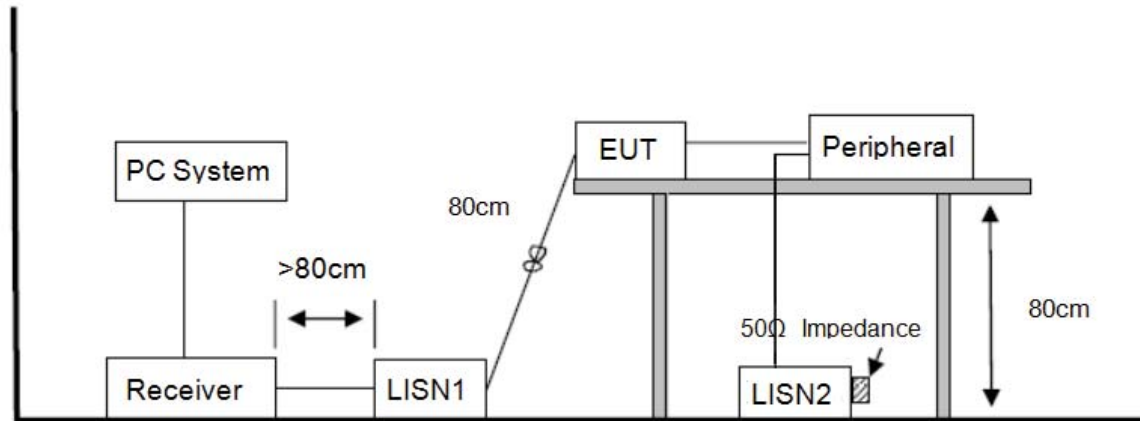

7.2. Power Line Conducted Emission Limits

Frequency	Quasi-Peak Level dB(μ V)	Average Level dB(μ V)
150kHz ~ 500kHz	66 ~ 56*	56 ~ 46*
500kHz ~ 5MHz	56	46
5MHz ~ 30MHz	60	50

Note 1: * Decreasing linearly with logarithm of frequency.

Note 2: The lower limit shall apply at the transition frequencies.

7.3. Test Procedure

The EUT and Support equipment, if needed, were put placed on a non-metallic table, 80cm above the ground plane.

Configuration EUT to simulate typical usage as described in clause 2.4 and test equipment as described in clause 10.2 of this report.

All I/O cables were positioned to simulate typical actual usage as per ANSI C63.10.

All support equipment power received from a second LISN.

Emissions were measured on each current carrying line of the EUT using an EMI Test Receiver connected to the LISN powering the EUT.

The Receiver scanned from 150 kHz to 30MHz for emissions in each of the test modes.

During the above scans, the emissions were maximized by cable manipulation.
The test mode(s) described in clause 2.4 were scanned during the preliminary test.



TEST REPORT NUMBER: (8519)077-1052

After the preliminary scan, we found the test mode producing the highest emission level. The EUT configuration and worse cable configuration of the above highest emission levels were recorded for reference of the final test.

EUT and support equipment were set up on the test bench as per the configuration with highest emission level in the preliminary test.

A scan was taken on both power lines, Neutral and Line, recording at least the six highest emissions.

Emission frequency and amplitude were recorded into a computer in which correction factors were used to calculate the emission level and compare reading to the applicable limit.

The test data of the worst-case condition(s) was recorded.

The bandwidth of test receiver is set at 9 kHz.

7.4. Test Result

Not Applicable, since the EUT is only battery-operated device.

8. Antenna Requirements

8.1. Limit

For intentional device, according to FCC 47 CFR Section 15.203, an intentional radiator shall be designed to ensure that no antenna other than that furnished by the responsible party shall be used with the device.

8.2. Result

The antennas used for this product are integral PCB Antenna and that no antenna other than that furnished by the responsible party shall be used with the device, the maximum peak gain of the transmit antenna is only 0dBi.