

TEST REPORT

Report No.: BCTC2202878990E

Applicant: Roo Inc

Product Name: Doorbell USB chime

Model/Type Ref.: Echo2

Tested Date: 2022-02-11 to 2022-02-23

Issued Date: 2022-02-23

Shenzhen BCTC Testing Co., Ltd.



FCC ID: 2APSE-ECHO-U

Product Name: Doorbell USB chime
Trademark: Kangaroo
Model/Type Ref.: Echo2
Prepared For: Roo Inc
Address: 6 W 18th Street, 8th Floor, New York City, United States, 10003
Manufacturer: Roo Inc
Address: 6 W 18th Street, 8th Floor, New York City, United States, 10003
Prepared By: Shenzhen BCTC Testing Co., Ltd.
Address: 1-2/F., Building B, Pengzhou Industrial Park, No.158, Fuyuan 1st Road, Tangwei, Fuhai Subdistrict, Bao'an District, Shenzhen, Guangdong, China
Sample Received Date: 2022-02-11
Sample tested Date: 2022-02-11 to 2022-02-23
Issue Date: 2022-02-23
Report No.: BCTC2202878990E
Test Standards: FCC Part15.247
ANSI C63.10-2013
Test Results: PASS
Remark: This is WIFI-2.4GHz band radio test report.

Tested by:

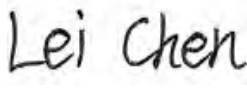

Lei Chen/Project Handler

Approved by:



Zero Zhou/Reviewer

The test report is effective only with both signature and specialized stamp. This result(s) shown in this report refer only to the sample(s) tested. Without written approval of Shenzhen BCTC Testing Co., Ltd, this report can't be reproduced except in full. The tested sample(s) and the sample information are provided by the client.

Table Of Content

Test Report Declaration	Page
1. Version	5
2. Test Summary	6
3. Measurement Uncertainty	7
4. Product Information And Test Setup	8
4.1 Product Information.....	8
4.2 Test Setup Configuration	8
4.3 Support Equipment	8
4.4 Channel List.....	9
4.5 Test Mode.....	9
4.6 Table Of Parameters Of Text Software Setting.....	9
5. Test Facility And Test Instrument Used.....	10
5.1 Test Facility.....	10
5.2 Test Instrument Used.....	10
6. Conducted Emissions.....	12
6.1 Block Diagram Of Test Setup.....	12
6.2 Limit	12
6.3 Test Procedure	12
6.4 EUT Operating Conditions	13
6.5 Test Result.....	14
7. Radiated Emissions.....	16
7.1 Block Diagram Of Test Setup.....	16
7.2 Limit	17
7.3 Test Procedure	18
7.4 EUT Operating Conditions	19
7.5 Test Result.....	20
8. Radiated Band Emission Measurement And Restricted Bands Of Operation	27
8.1 Block Diagram Of Test Setup.....	27
8.2 Limit	27
8.3 Test Procedure	28
8.4 EUT operating Conditions	28
8.5 Test Result.....	29
9. Power Spectral Density Test	31
9.1 Block Diagram Of Test Setup.....	31
9.2 Limit	31
9.3 Test Procedure	31
9.4 EUT Operating Conditions	31
9.5 Test Result.....	32
10. Bandwidth Test.....	39
10.1 Block Diagram Of Test Setup.....	39
10.2 Limit	39
10.3 Test Procedure	39
10.4 EUT Operating Conditions	39

10.5	Test Result.....	40
11.	Peak Output Power Test	47
11.1	Block Diagram Of Test Setup.....	47
11.2	Limit	47
11.3	Test Procedure	47
11.4	EUT Operating Conditions	47
11.5	Test Result.....	48
12.	100 KHz Bandwidth Of Frequency Band Edge.....	49
12.1	Block Diagram Of Test Setup.....	49
12.2	Limit	49
12.3	Test Procedure	49
12.4	EUT Operating Conditions	49
12.5	Test Result.....	50
13.	Duty Cycle Of Test Signal	70
13.1	Standard Requirement.....	70
13.2	Formula.....	70
13.3	Test Procedure	70
13.4	Test Result.....	70
14.	Antenna Requirement	77
14.1	Limit	77
14.2	Test Result.....	77
15.	EUT Photographs.....	78
16.	EUT Test Setup Photographs.....	79

(Note: N/A means not applicable)

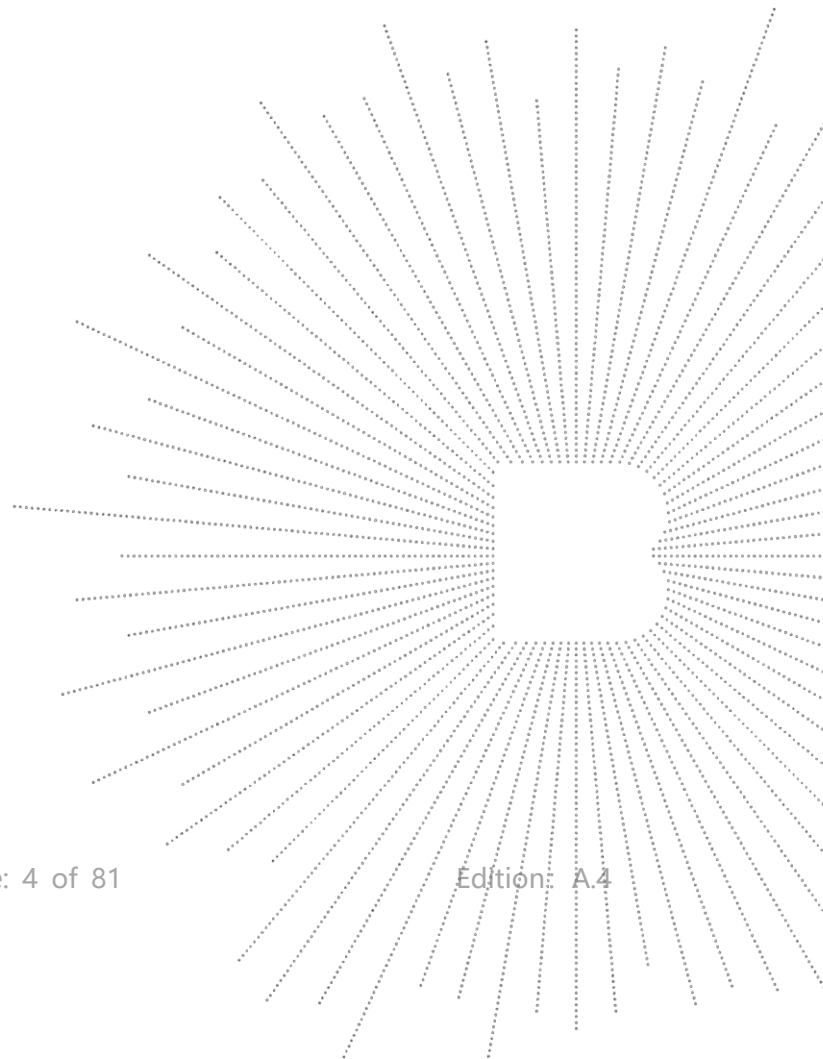

1. Version

Report No.	Issue Date	Description	Approved
BCTC2202878990E	2022-02-23	Original	Valid

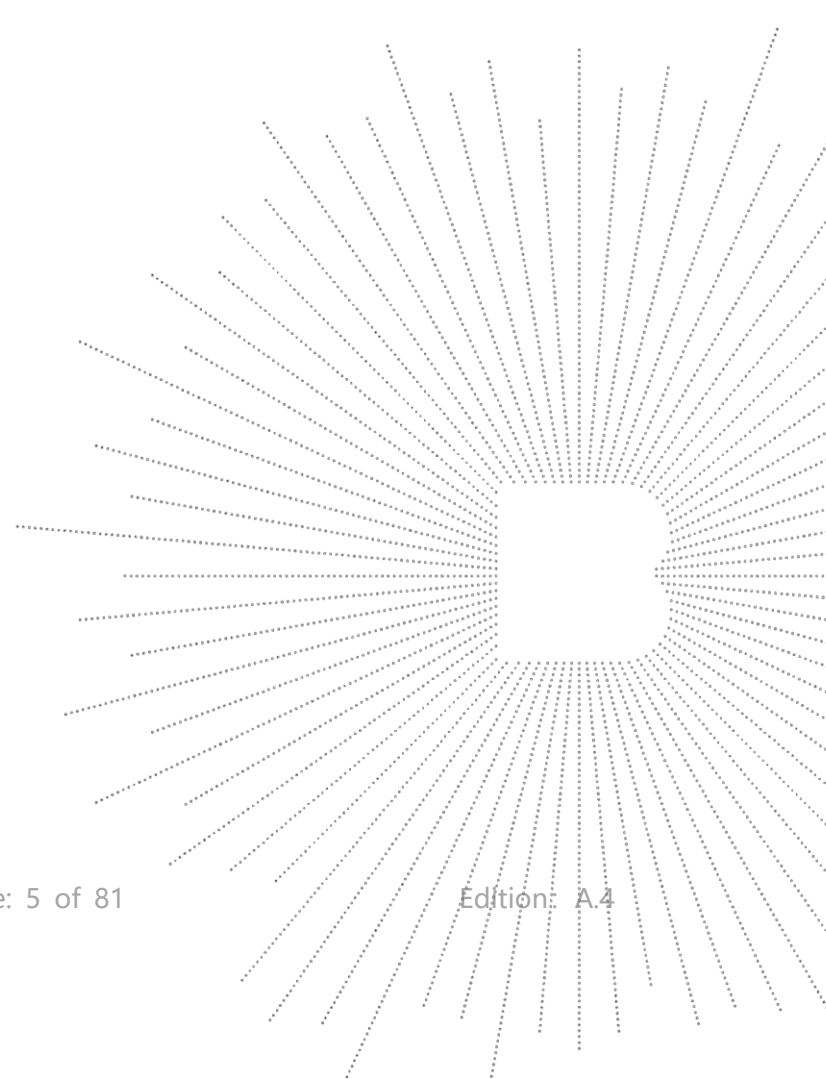

2. Test Summary

The Product has been tested according to the following specifications:

No.	Test Parameter	Clause No	Results
1	Conducted Emission	15.207	PASS
2	6dB Bandwidth	15.247 (a)(2)	PASS
3	Peak Output Power	15.247 (b)	PASS
4	Radiated Spurious Emission	15.247 (d)	PASS
5	Power Spectral Density	15.247 (e)	PASS
6	Restricted Band of Operation	15.205	PASS
7	Band Edge (Out of Band Emissions)	15.247 (d)	PASS
8	Antenna Requirement	15.203	PASS

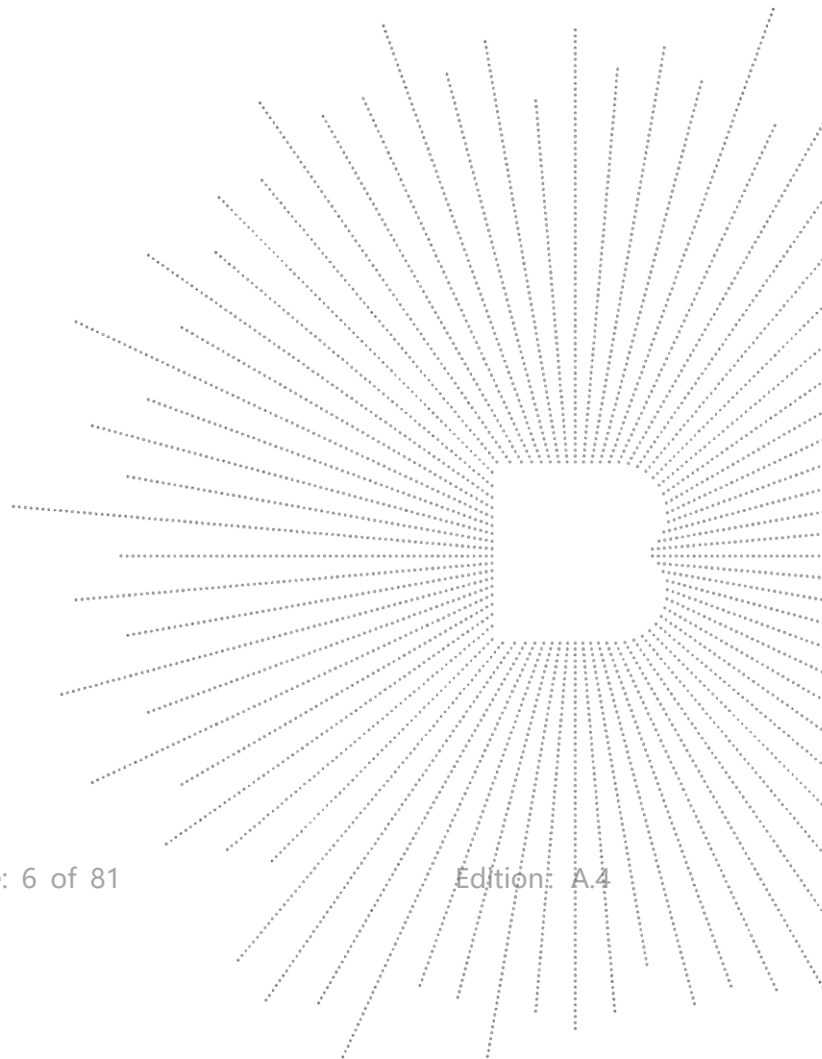

3. Measurement Uncertainty

Where relevant, the following measurement uncertainty levels have been estimated for tests performed on the Product as specified in CISPR 16-4-2. This uncertainty represents an expanded uncertainty expressed at approximately the 95% confidence level using a coverage factor of k=2.

No.	Item	Uncertainty
1	3m chamber Radiated spurious emission(9kHz-30MHz)	U=3.7dB
2	3m chamber Radiated spurious emission(30MHz-1GHz)	U=4.3dB
3	3m chamber Radiated spurious emission(1GHz-18GHz)	U=4.5dB
4	3m chamber Radiated spurious emission(18GHz-40GHz)	U=3.34dB
5	Conducted Emission(150kHz-30MHz)	U=3.20dB
6	Conducted Adjacent channel power	U=1.38dB
7	Conducted output power uncertainty Above 1G	U=1.576dB
8	Conducted output power uncertainty below 1G	U=1.28dB
9	humidity uncertainty	U=5.3%
10	Temperature uncertainty	U=0.59°C

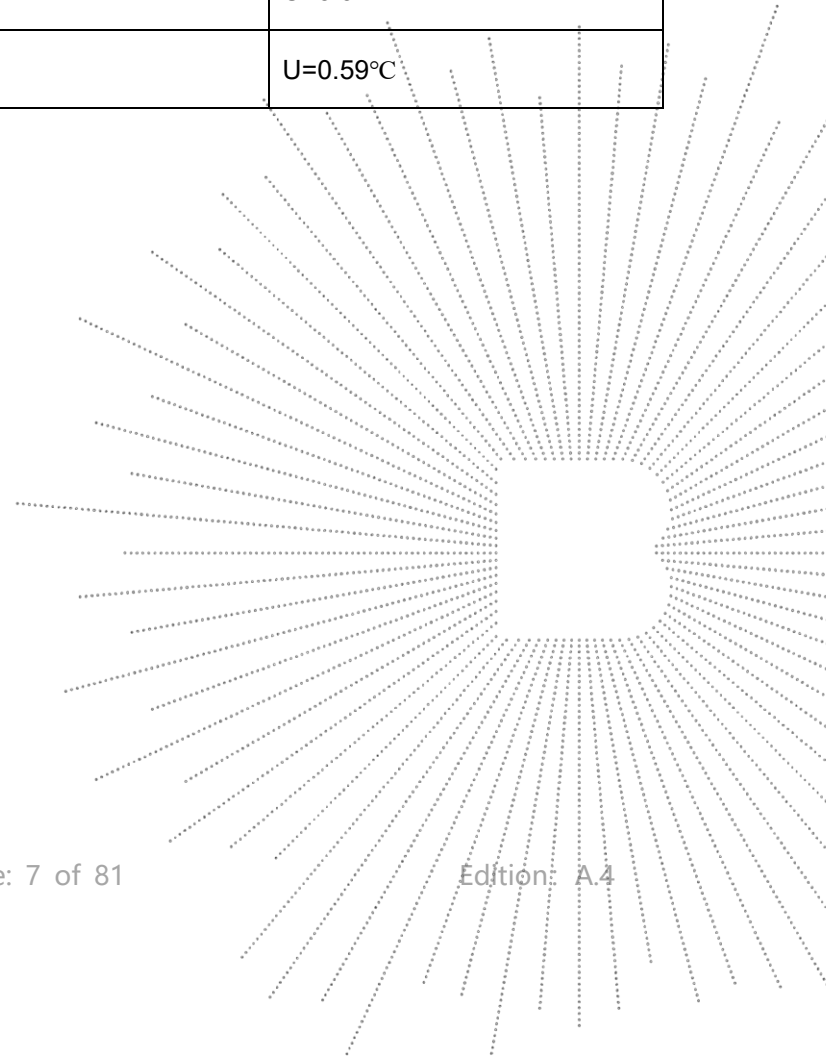

4. Product Information And Test Setup

4.1 Product Information

Model/Type Ref.:	Echo2
Model differences:	N/A
Operation Frequency:	802.11b/g/n20MHz:2412~2462 MHz 802.11n40MHz:2422~2452 MHz
Bit Rate of Transmitter	802.11b:11/5.5/2/1 Mbps 802.11g:54/48/36/24/18/12/9/6Mbps 802.11n Up to 150Mbps
Type of Modulation:	WIFI: OFDM/DSSS
Number Of Channel	802.11b/g/n20MHz:11 CH 802.11n40MHz: 7 CH
Antenna Gain:	1.55dBi
Ratings:	DC 5V from adapter Model: RJ49-W050100US
Adapter:	Input: AC100-240V 50/60Hz 250mA Output: DC5V/1A

4.2 Test Setup Configuration

See test photographs attached in *EUT TEST SETUP PHOTOGRAPHS* for the actual connections between Product and support equipment.

Conducted Emission:

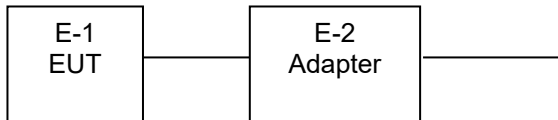

Radiated Spurious Emission

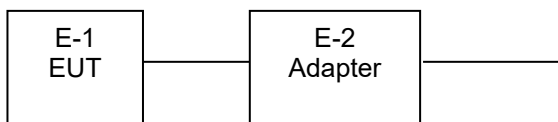

4.3 Support Equipment

No.	Device Type	Brand	Model	Series No.	Note
E-1	Doorbell USB chime	Kangaroo	Echo2	N/A	EUT
E-2	Adapter	N/A	RJ49-W050100US	N/A	Auxiliary

Notes:

- All the equipment/cables were placed in the worst-case configuration to maximize the emission during the test.
- Grounding was established in accordance with the manufacturer's requirements and conditions for the intended use.

4.4 Channel List

Channel List for 802.11b/g/n(20)					
Channel	Frequency (MHz)	Channel	Frequency (MHz)	Channel	Frequency (MHz)
01	2412	02	2417	03	2422
04	2427	05	2432	06	2437
07	2442	08	2447	09	2452
10	2457	11	2462		

Channel List for 802.11n(40)					
Channel	Frequency (MHz)	Channel	Frequency (MHz)	Channel	Frequency (MHz)
03	2422	04	2427	05	2432
06	2437	07	2442	08	2447
09	2452				

4.5 Test Mode

To investigate the maximum EMI emission characteristics generates from EUT, the test system was pre-scanning tested base on the consideration of following EUT operation mode or test configuration mode which possible have effect on EMI emission level. Each of these EUT operation mode(s) or test configuration mode(s) mentioned above was evaluated respectively.

Pretest Mode	Description
Mode 1	802.11b CH1/ CH6/ CH11
Mode 2	802.11g CH1/ CH6/ CH11
Mode 3	802.11n20 CH1/ CH6/ CH11
Mode 4	802.11n40 CH3/ CH6/ CH9
Mode 5	Link Mode

Radiated Emission	
Final Test Mode	Description
Mode 5	Link Mode

For Radiated Emission	
Final Test Mode	Description
Mode 1	802.11b CH1/ CH6/ CH11
Mode 2	802.11g CH1/ CH6/ CH11
Mode 3	802.11n20 CH1/ CH6/ CH11
Mode 4	802.11n40 CH3/ CH6/ CH9

Note:

(1) The measurements are performed at all Bit Rate of Transmitter, the worst data was reported.

4.6 Table Of Parameters Of Text Software Setting

During testing channel & power controlling software provided by the customer was used to control the operating channel as well as the output power level. The RF output power selection is for the setting of RF output power expected by the customer and is going to be fixed on the firmware of the final end product power parameters

Test software Version	ESP_RF_test_tool		
Frequency	2412 MHz	2437 MHz	2462 MHz
Parameters	DEF	DEF	DEF
Frequency	2422MHz	2437MHz	2452MHz
Parameters	DEF	DEF	DEF

5. Test Facility And Test Instrument Used

5.1 Test Facility

All measurement facilities used to collect the measurement data are located at Shenzhen BCTC Testing Co., Ltd. Address: 1-2/F., Building B, Pengzhou Industrial Park, No.158, Fuyuan 1st Road, Tangwei, Fuhai Subdistrict, Bao'an District, Shenzhen, Guangdong, China. The site and apparatus are constructed in conformance with the requirements of ANSI C63.4 and CISPR 16-1-1 other equivalent standards. FCC Test Firm Registration Number: 712850 IC Registered No.: 23583

5.2 Test Instrument Used

Conducted emissions Test					
Equipment	Manufacturer	Model#	Serial#	Last Cal.	Next Cal.
Receiver	R&S	ESR3	102075	May 28, 2021	May 27, 2022
LISN	R&S	ENV216	101375	May 28, 2021	May 27, 2022
Software	Frad	EZ-EMC	EMC-CON 3A1	\	\
Attenuator	\	10dB DC-6GHz	1650	May 28, 2021	May 27, 2022

RF Conducted Test					
Equipment	Manufacturer	Model#	Serial#	Last Cal.	Next Cal.
Power Metter	Keysight	E4419	\	May 28, 2021	May 27, 2022
Power Sensor (AV)	Keysight	E9300A	\	May 28, 2021	May 27, 2022
Signal Analyzer20kHz-26.5GHz	Keysight	N9020A	MY49100060	May 28, 2021	May 27, 2022
Spectrum Analyzer9kHz-40GHz	R&S	FSP40	\	May 28, 2021	May 27, 2022

Radiated emissions Test (966 chamber)					
Equipment	Manufacturer	Model#	Serial#	Last Cal.	Next Cal.
966 chamber	ChengYu	966 Room	966	Jun. 06. 2020	Jun. 05, 2023
Receiver	R&S	ESR3	102075	May 28, 2021	May 27, 2022
Receiver	R&S	ESRP	101154	May 28, 2021	May 27, 2022
Amplifier	SKET	LAPA_01G18 G-45dB	\	May 28, 2021	May 27, 2022
Amplifier	Schwarzbeck	BBV9744	9744-0037	May 28, 2021	May 27, 2022
TRILOG Broadband Antenna	Schwarzbeck	VULB9163	942	Jun. 01, 2021	May 31, 2022
Horn Antenna	Schwarzbeck	BBHA9120D	1541	Jun. 02, 2021	Jun. 01, 2022
Horn Antenn(18GHz -40GHz)	Schwarzbeck	BBHA9170	00822	Jun. 15, 2021	Jun. 14, 2022
Amplifier(18G Hz-40GHz)	MITEQ	TTA1840-35- HG	2034381	May 28, 2021	May 27, 2022
Loop Antenna(9kHz -30MHz)	Schwarzbeck	FMZB1519B	00014	Jun. 02, 2021	Jun. 01, 2022
RF cables1(9kHz- 30MHz)	Huber+Suhnar	9kHz-30MHz	B1702988-00 08	May 28, 2021	May 27, 2022
RF cables2(30MH z-1GHz)	Huber+Suhnar	30MHz-1GH z	1486150	May 28, 2021	May 27, 2022
RF cables3(1GHz- 40GHz)	Huber+Suhnar	1GHz-40GHz	1607106	May 28, 2021	May 27, 2022
Power Metter	Keysight	E4419	\	May 28, 2021	May 27, 2022
Power Sensor (AV)	Keysight	E9300A	\	May 28, 2021	May 27, 2022
Signal Analyzer20kHz -26.5GHz	Keysight	N9020A	MY49100060	May 28, 2021	May 27, 2022
Spectrum Analyzer9kHz- 40GHz	R&S	FSP40	\	May 28, 2021	May 27, 2022
Software	Frad	EZ-EMC	FA-03A2 RE	\	\

6. Conducted Emissions

6.1 Block Diagram Of Test Setup

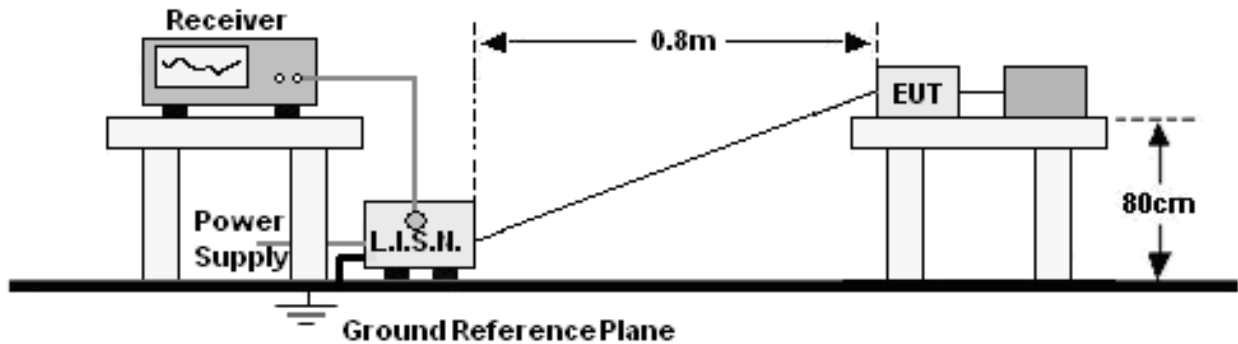

6.2 Limit

FREQUENCY (MHz)	Limit (dBuV)	
	Quas-peak	Average
0.15 -0.5	66 - 56 *	56 - 46 *
0.50 -5.0	56.00	46.00
5.0 -30.0	60.00	50.00

Notes:

- *Decreasing linearly with logarithm of frequency.
- The lower limit shall apply at the transition frequencies.

6.3 Test Procedure

Receiver Parameters	Setting
Attenuation	10 dB
Start Frequency	0.15 MHz
Stop Frequency	30 MHz
IF Bandwidth	9 kHz

- The Product was placed on a nonconductive table 0.8 m above the horizontal ground reference plane, and 0.4 m from the vertical ground reference plane, and connected to the main through Line Impedance Stability Network (L.I.S.N).
- The RBW of the receiver was set at 9 kHz in 150 kHz ~ 30MHz with Peak and AVG detector in Max Hold mode. Run the receiver's pre-scan to record the maximum disturbance generated from Product in all power lines in the full band.
- For each frequency whose maximum record was higher or close to limit, measure its QP and AVG values and record.

6.4 EUT Operating Conditions

The EUT was configured for testing in a typical fashion (as a customer would normally use it). The EUT has been programmed to continuously transmit during test. This operating condition was tested and used to collect the included data.

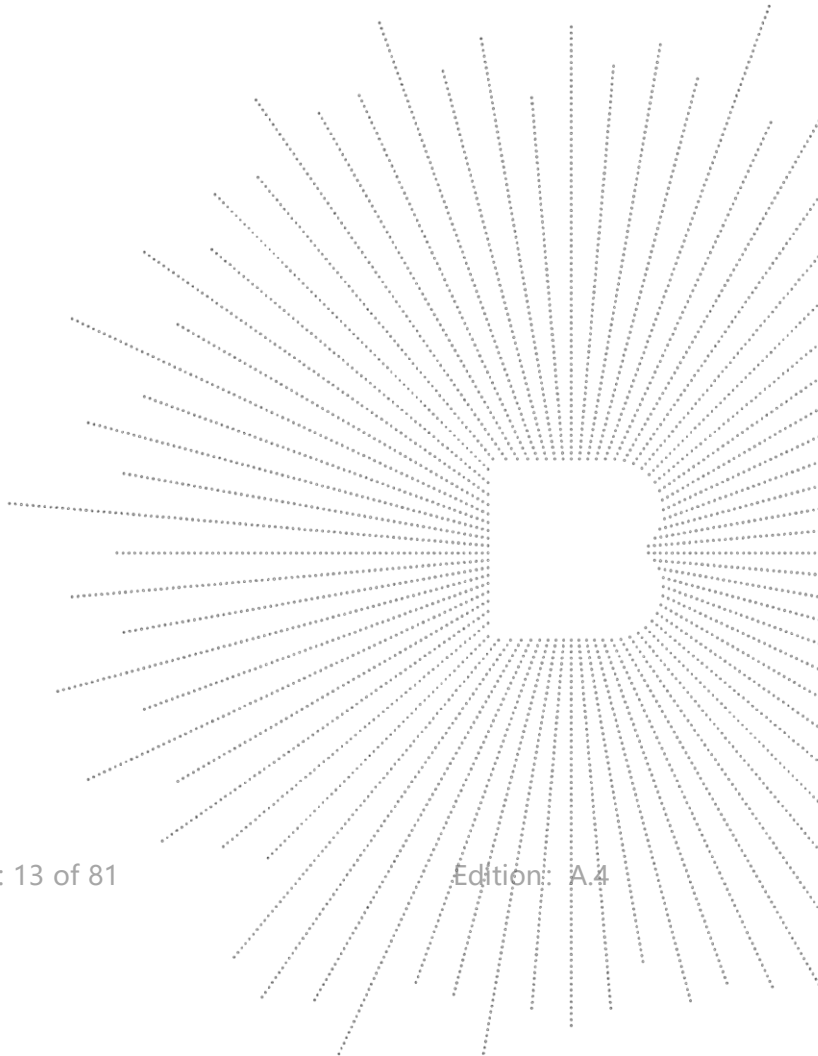

6.5 Test Result

Temperature :	26 °C	Relative Humidity :	54%
Pressure :	101kPa	Phase :	Line
Test Voltage :	AC 120V/60Hz	Test Mode :	Mode 5

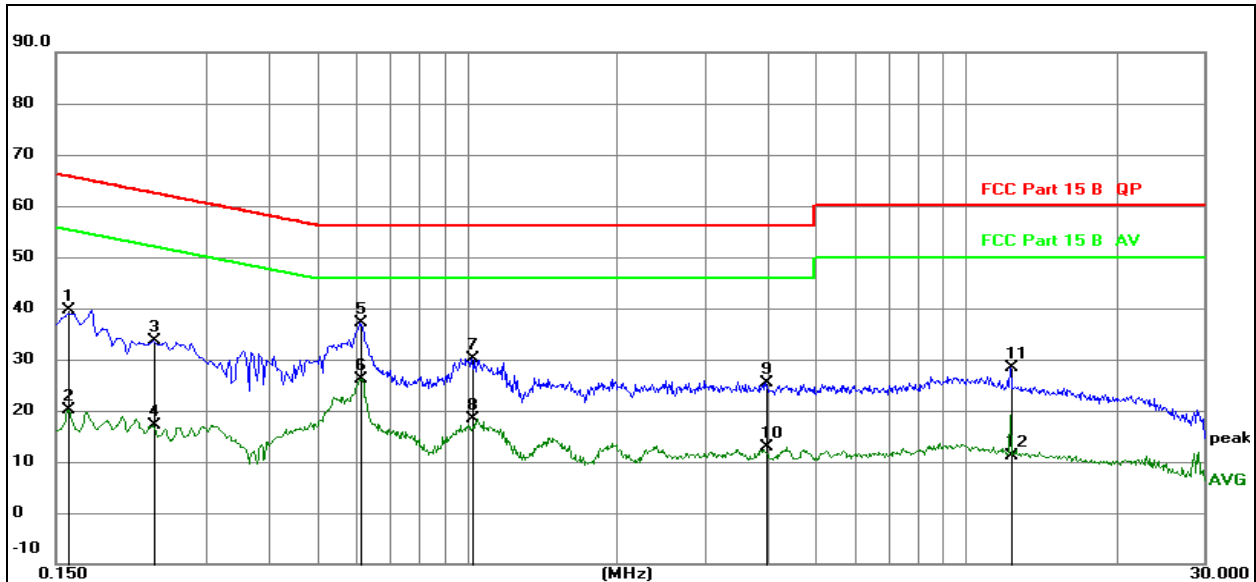

Remark:

1. All readings are Quasi-Peak and Average values.
2. Factor = Insertion Loss + Cable Loss.
3. Measurement=Reading Level+ Correct Factor
4. Over=Measurement-Limit

No.	Mk.	Freq. MHz	Reading Level	Correct Factor dB	Measure- ment dBuV	Limit dBuV	Over dB	Detector
1		0.1590	19.95	19.60	39.55	65.52	-25.97	QP
2		0.1590	0.49	19.60	20.09	55.52	-35.43	AVG
3		0.2355	14.08	19.60	33.68	62.25	-28.57	QP
4		0.2355	-2.47	19.60	17.13	52.25	-35.12	AVG
5	*	0.6134	17.54	19.61	37.15	56.00	-18.85	QP
6		0.6134	6.43	19.61	26.04	46.00	-19.96	AVG
7		1.0230	10.59	19.62	30.21	56.00	-25.79	QP
8		1.0230	-1.35	19.62	18.27	46.00	-27.73	AVG
9		3.9705	5.59	19.67	25.26	56.00	-30.74	QP
10		3.9705	-6.71	19.67	12.96	46.00	-33.04	AVG
11		12.2865	8.58	19.78	28.36	60.00	-31.64	QP
12		12.2865	-8.55	19.78	11.23	50.00	-38.77	AVG

Temperature :	26 °C	Relative Humidity :	54%
Pressure :	101kPa	Phase :	Neutral
Test Voltage :	AC 120V/60Hz	Test Mode :	Mode 5

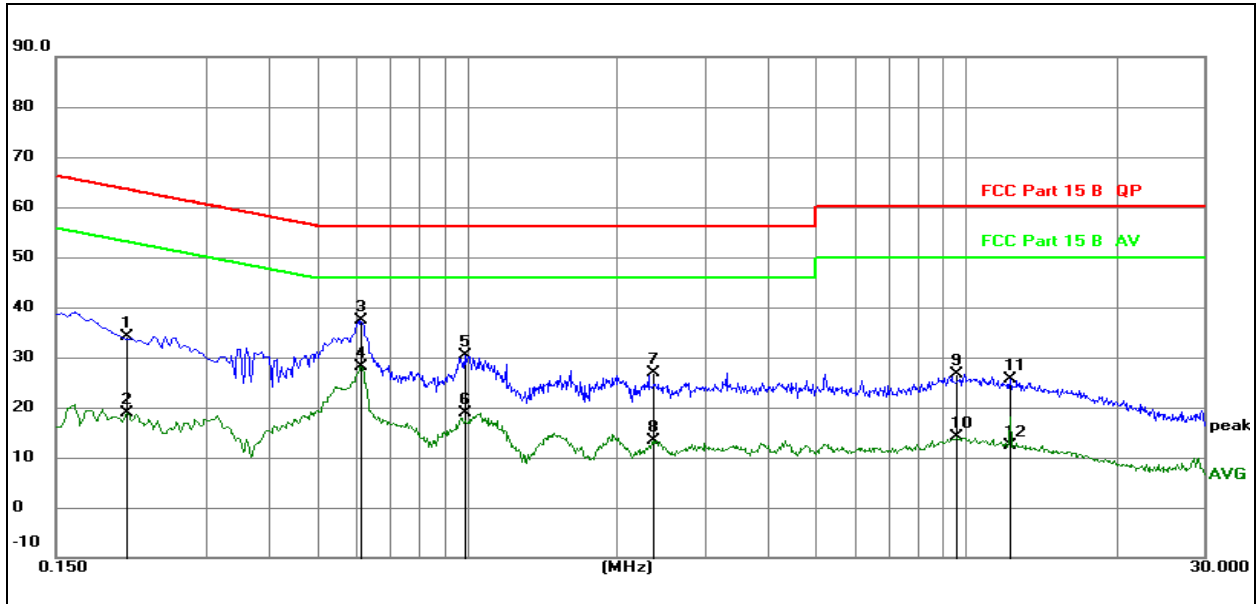
Remark:

1. All readings are Quasi-Peak and Average values.
2. Factor = Insertion Loss + Cable Loss.
3. Measurement=Reading Level+ Correct Factor
4. Over=Measurement-Limit

No.	Mk.	Freq.	Reading Level	Correct Factor	Measurement	Limit	Over	Detector
		MHz		dB	dBuV	dBuV	dB	
1		0.2083	14.64	19.60	34.24	63.27	-29.03	QP
2		0.2083	-0.63	19.60	18.97	53.27	-34.30	AVG
3		0.6108	17.67	19.61	37.28	56.00	-18.72	QP
4	*	0.6108	8.46	19.61	28.07	46.00	-17.93	AVG
5		0.9891	10.74	19.62	30.36	56.00	-25.64	QP
6		0.9891	-0.78	19.62	18.84	46.00	-27.16	AVG
7		2.3585	7.26	19.63	26.89	56.00	-29.11	QP
8		2.3585	-6.26	19.63	13.37	46.00	-32.63	AVG
9		9.6028	6.94	19.78	26.72	60.00	-33.28	QP
10		9.6028	-5.60	19.78	14.18	50.00	-35.82	AVG
11		12.2531	5.84	19.78	25.62	60.00	-34.38	QP
12		12.2531	-7.36	19.78	12.42	50.00	-37.58	AVG

7. Radiated Emissions

7.1 Block Diagram Of Test Setup

(A) Radiated Emission Test-Up Frequency Below 30MHz

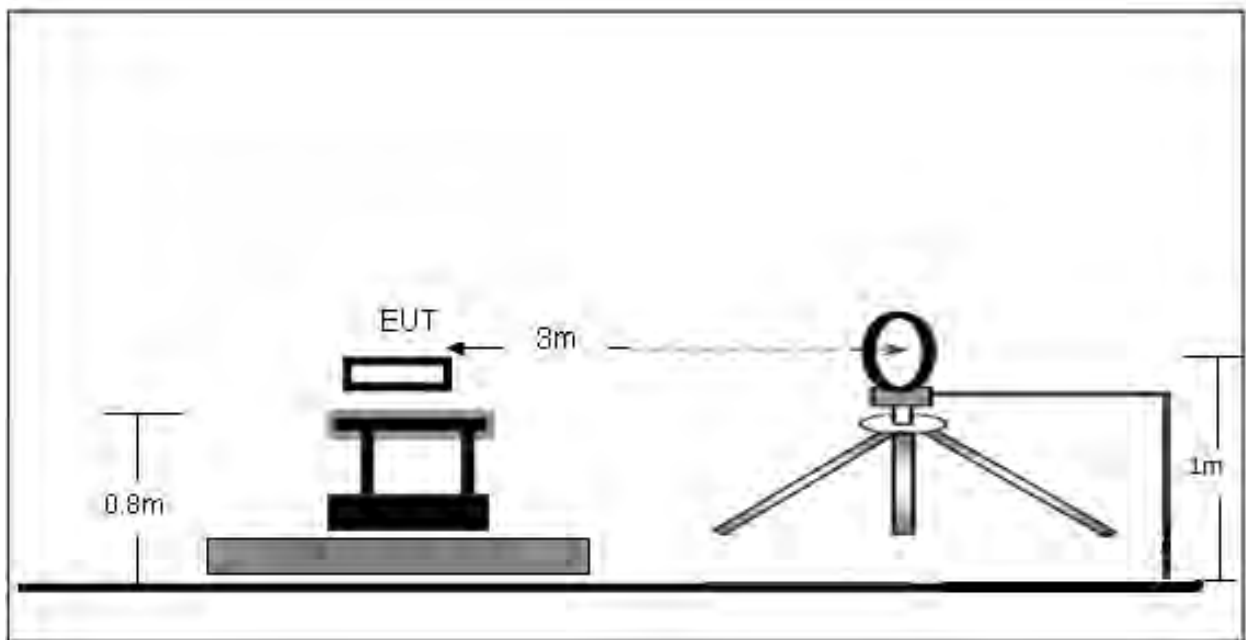

(B) Radiated Emission Test-Up Frequency 30MHz~1GHz

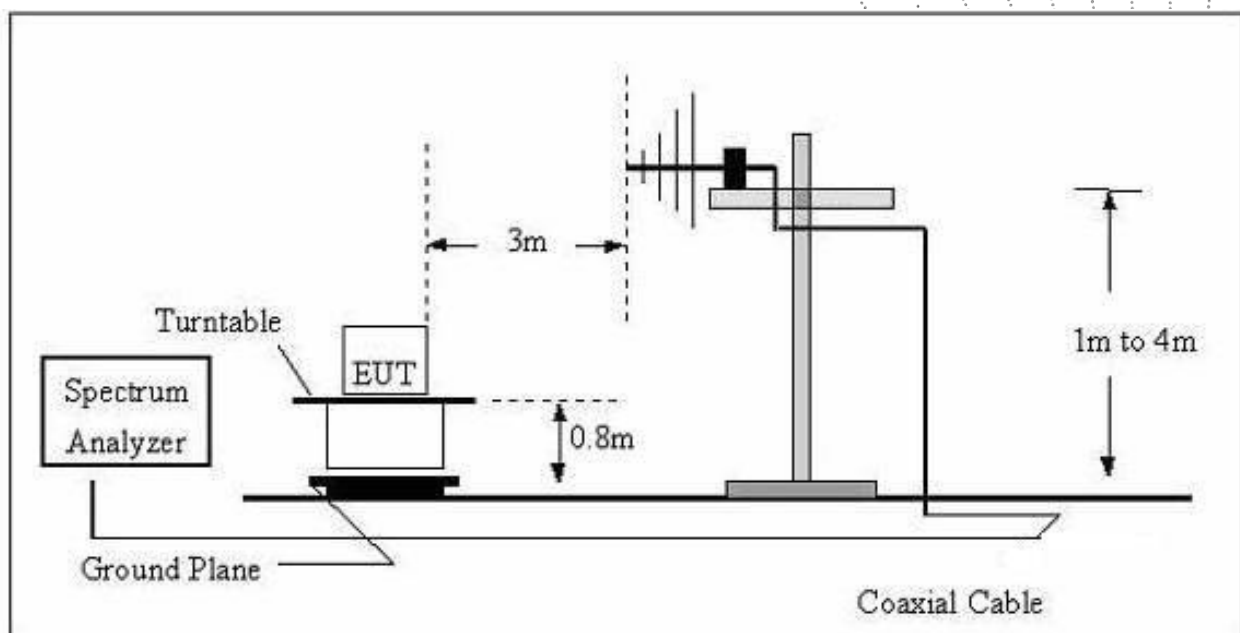

(C) Radiated Emission Test-Up Frequency Above 1GHz

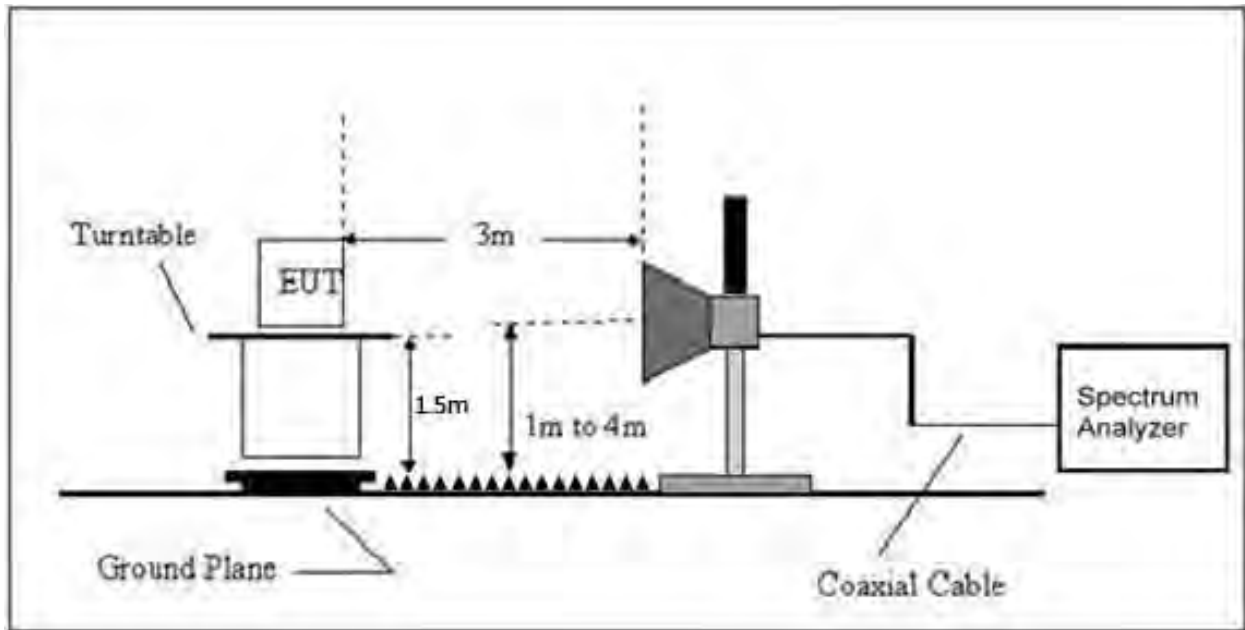

7.2 Limit

20dBc in any 100 kHz bandwidth outside the operating frequency band. In case the emission fall within the restricted band specified on 15.205(a), then the 15.209(a) limit in the table below has to be followed:

Frequency (MHz)	Field Strength uV/m	Distance (m)	Field Strength Limit at 3m Distance	
			uV/m	dBuV/m
0.009 ~ 0.490	$2400/F(\text{kHz})$	300	$10000 * 2400/F(\text{kHz})$	$20\log^{(2400/F(\text{kHz}))} + 80$
0.490 ~ 1.705	$24000/F(\text{kHz})$	30	$100 * 24000/F(\text{kHz})$	$20\log^{(24000/F(\text{kHz}))} + 40$
1.705 ~ 30	30	30	$100 * 30$	$20\log^{(30)} + 40$
30 ~ 88	100	3	100	$20\log^{(100)}$
88 ~ 216	150	3	150	$20\log^{(150)}$
216 ~ 960	200	3	200	$20\log^{(200)}$
Above 960	500	3	500	$20\log^{(500)}$

LIMITS OF RADIATED EMISSION MEASUREMENT (Above 1000MHz)

FREQUENCY (MHz)	Limit (dBuV/m) (at 3M)	
	PEAK	AVERAGE
Above 1000	74	54

Notes:

- (1) The limit for radiated test was performed according to FCC PART 15C.
- (2) The tighter limit applies at the band edges.
- (3) Emission level (dBuV/m) = 20log Emission level (uV/m).

FREQUENCY RANGE OF RADIATED MEASUREMENT (For unintentional radiators)

Highest frequency generated or Upper frequency of measurement used in the device or on which the device operates or tunes (MHz)	Range (MHz)
Below 1.705	30
1.705 – 108	1000
108 – 500	2000
500 – 1000	5000
Above 1000	5 th harmonic of the highest frequency or 40 GHz, whichever is lower

7.3 Test Procedure

Receiver Parameter	Setting
Attenuation	Auto
9kHz~150kHz	RBW 200Hz for QP
150kHz~30MHz	RBW 9kHz for QP
30MHz~1000MHz	RBW 120kHz for QP

Spectrum Parameter	Setting
1-25GHz	RBW 1-MHz /VBW 1-MHz for Peak, RBW 1-MHz / VBW 10Hz for Average

Below 1GHz test procedure as below:

- a. The EUT was placed on the top of a rotating table 0.8 meters above the ground at a 3 meter semi-anechoic chamber. The table was rotated 360 degrees to determine the position of the highest radiation.
- b. The EUT was set 3 meters away from the interference-receiving antenna, which was mounted on the top of a variable-height antenna tower.
- c. The antenna height is varied from one meter to four meters above the ground to determine the maximum value of the field strength. Both horizontal and vertical polarizations of the antenna are set to make the measurement.

d. For each suspected emission, the EUT was arranged to its worst case and then the antenna was tuned to heights from 1 meter to 4 meters (for the test frequency of below 30MHz, the antenna was tuned to heights 1 meter) and the rotatable table was turned from 0 degrees to 360 degrees to find the maximum reading.

e. The test-receiver system was set to Peak Detect Function and Specified Bandwidth with Maximum Hold Mode.

f. If the emission level of the EUT in peak mode was 10dB lower than the limit specified, then testing could be stopped and the peak values of the EUT would be reported. Otherwise the emissions that did not have 10dB margin would be re-tested one by one using peak, quasi-peak or average method as specified and then reported in a data sheet.

Above 1GHz test procedure as below:

g. Different between above is the test site, change from Semi- Anechoic Chamber to fully Anechoic Chamber and change form table 0.8 metre to 1.5 metre(Above 18GHz the distance is 1 meter and table is 1.5 metre).

h. Test the EUT in the lowest channel ,the middle channel ,the Highest channel.

Note:

Both horizontal and vertical antenna polarities were tested and performed pretest to three orthogonal axis. The worst case emissions were reported.

Above 1GHz test procedure as below:

a. The EUT was placed on the top of a rotating table 1.5 meters above the ground at a 3 meter chamber. The table was rotated 360 degrees to determine the position of the highest radiation.

b. The EUT was set 3 meters away from the interference-receiving antenna, which was mounted on the top of a variable-height antenna tower.

c. The antenna height is varied from one meter to four meters above the ground to determine the maximum value of the field strength. Both horizontal and vertical polarizations of the antenna are set to make the measurement.

d. For each suspected emission, the EUT was arranged to its worst case and then the antenna was tuned to heights from 1 meter to 4 meters and the rota table was turned from 0 degrees to 360 degrees to find the maximum reading.

e. The test-receiver system was set to Peak Detect Function and Specified Bandwidth with Maximum Hold Mode.

f. If the emission level of the EUT in peak mode was 10dB lower than the limit specified, then testing could be stopped and the peak values of the EUT would be reported. Otherwise the emissions that did not have 10dB margin would be re-tested one by one using peak, quasi-peak or average method as specified and then reported in a data sheet.

g. Test the EUT in the lowest channel, the Highest channel.

Note:

Both horizontal and vertical antenna polarities were tested and performed pretest to three orthogonal axis. The worst case emissions were reported.

7.4 EUT Operating Conditions

The EUT was configured for testing in a typical fashion (as a customer would normally use it). The EUT has been programmed to continuously transmit during test. This operating condition was tested and used to collect the included data.

7.5 Test Result

Below 30MHz

Temperature:	26°C	Relative Humidity:	24%
Pressure:	101 kPa	Test Voltage :	AC120V/60Hz
Test Mode :	Mode 5	Polarization :	--

Freq. (MHz)	Reading (dBuV/m)	Limit (dBuV/m)	Margin (dB)	State P/F
--	--	--	--	PASS
--	--	--	--	PASS

Note:

The amplitude of spurious emissions which are attenuated by more than 20dB below the permissible value has no need to be reported.

Distance extrapolation factor = $40 \log(\text{specific distance}/\text{test distance})(\text{dB})$;

Limit line = specific limits(dBuV) + distance extrapolation factor.

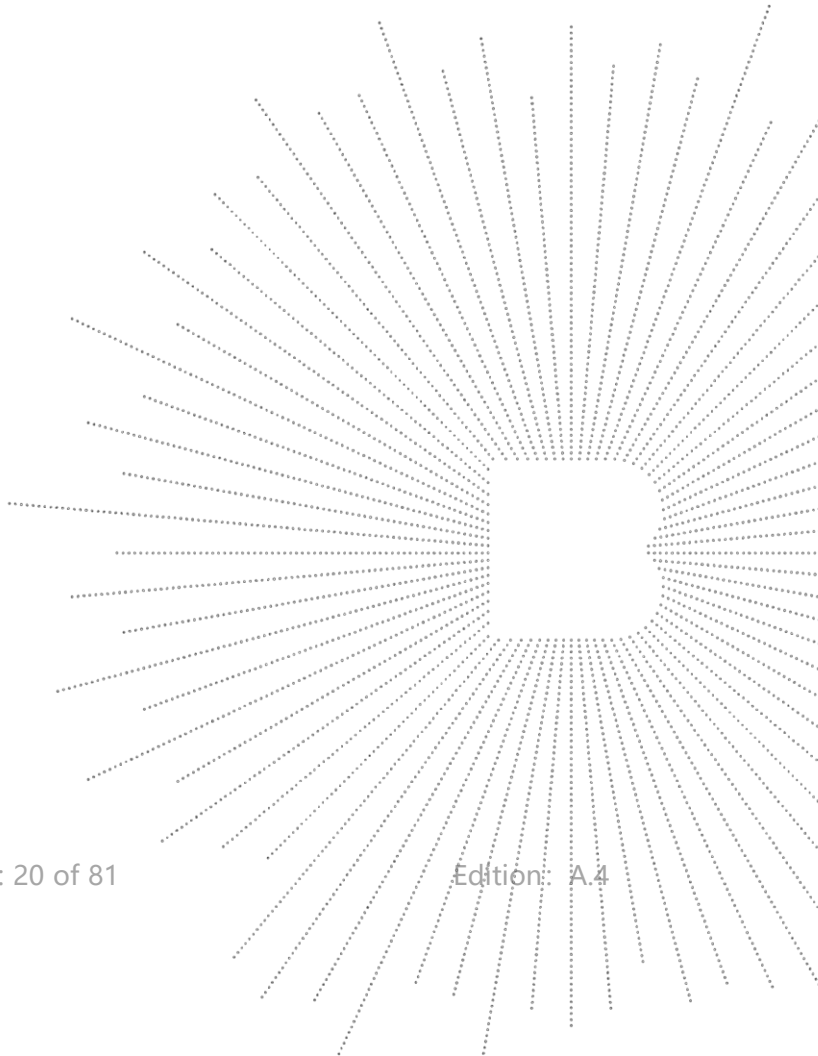

Between 30MHz – 1GHz

Temperature:	26°C	Relative Humidity:	54%
Pressure:	101 kPa	Test Voltage :	AC120V/60Hz
Test Mode :	Mode 5	Polarization :	Horizontal

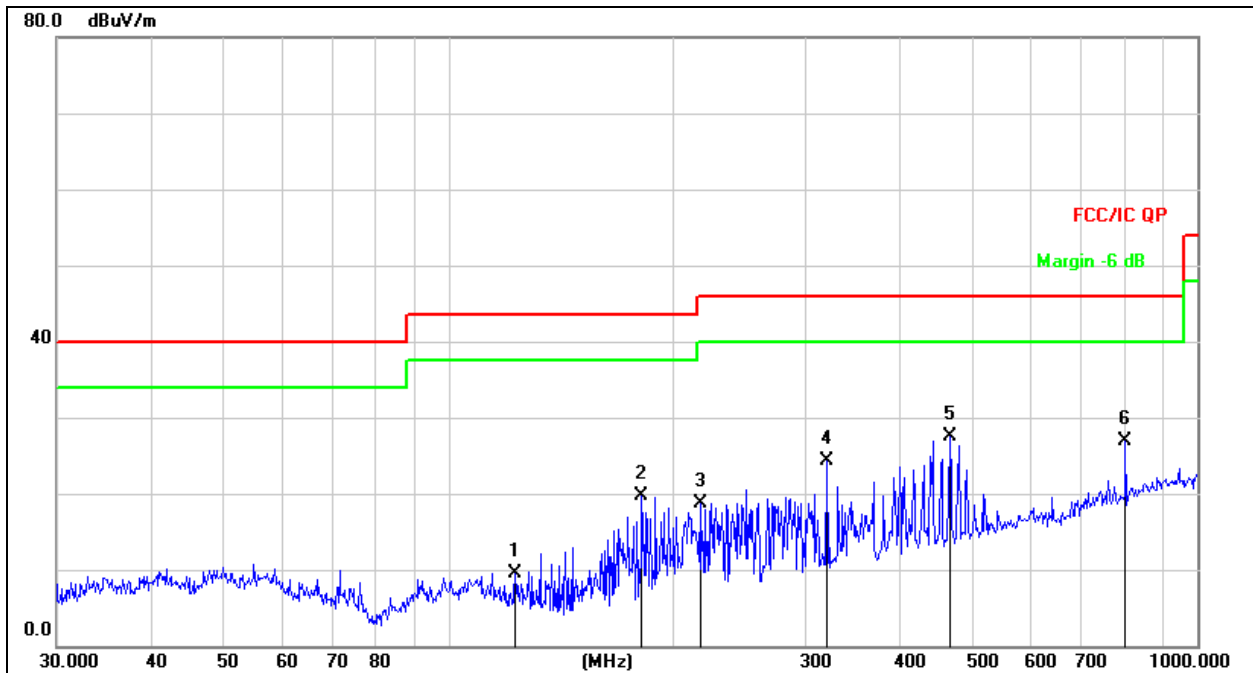

Remark:

1. Factor = Antenna Factor + Cable Loss – Pre-amplifier.
2. Measurement=Reading Level+ Correct Factor
3. Over= Measurement-Limit

No.	Mk.	Freq. MHz	Reading Level dBuV	Correct Factor dB	Measure- ment dBuV/m	Limit dB/m	Over dB	Detector
1		122.8340	27.30	-17.75	9.55	43.50	-33.95	QP
2		181.2834	37.25	-17.50	19.75	43.50	-23.75	QP
3		216.7828	34.67	-15.91	18.76	46.00	-27.24	QP
4		319.9370	37.38	-13.05	24.33	46.00	-21.67	QP
5	*	467.2349	37.20	-9.61	27.59	46.00	-18.41	QP
6		801.7863	30.43	-3.60	26.83	46.00	-19.17	QP

Temperature:	26°C	Relative Humidity:	54%
Pressure:	101 kpa	Test Voltage :	AC120V/60Hz
Test Mode :	Mode 1	Polarization :	Vertical

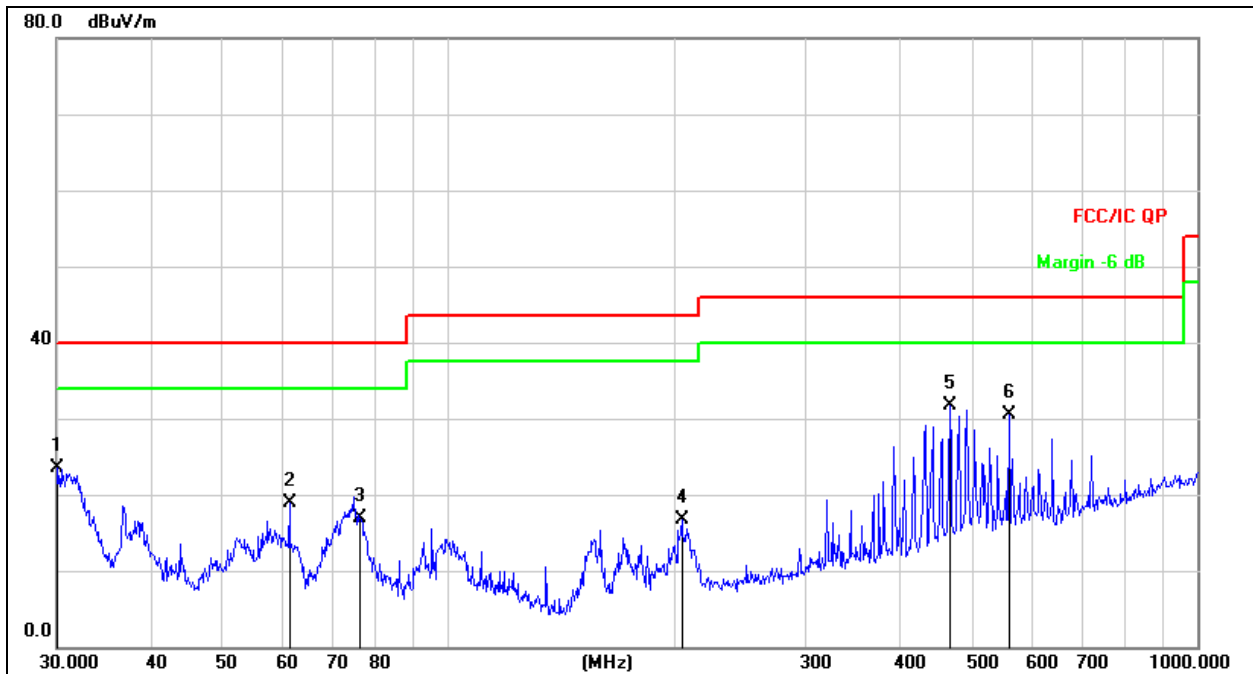
Remark:

1. Factor = Antenna Factor + Cable Loss – Pre-amplifier.
2. Measurement=Reading Level+ Correct Factor
3. Over= Measurement-Limit

No.	Mk.	Freq. MHz	Reading Level dBuV	Correct Factor dB	Measure- ment dBuV/m	Limit dB/m	Over dB	Detector
1		30.1054	40.78	-17.26	23.52	40.00	-16.48	QP
2		61.3463	35.09	-16.22	18.87	40.00	-21.13	QP
3		76.2442	36.52	-19.58	16.94	40.00	-23.06	QP
4		204.9551	32.95	-16.19	16.76	43.50	-26.74	QP
5	*	467.2349	41.37	-9.61	31.76	46.00	-14.24	QP
6		560.6928	38.03	-7.43	30.60	46.00	-15.40	QP

Between 1GHz – 25GHz
802.11b

Polar (H/V)	Frequency	Reading Level	Correct Factor	Measure- ment	Limits	Over	Detector Type
	(MHz)	(dBuV/m)	(dB)	(dBuV/m)	(dBuV/ m)	(dB)	
Low channel:2412MHz							
V	4824.00	54.63	-0.43	54.20	74.00	-19.80	PK
V	4824.00	46.02	-0.43	45.59	54.00	-8.41	AV
V	7236.00	45.87	8.31	54.18	74.00	-19.82	PK
V	7236.00	36.55	8.31	44.86	54.00	-9.14	AV
H	4824.00	53.06	-0.43	52.63	74.00	-21.37	PK
H	4824.00	43.23	-0.43	42.80	54.00	-11.20	AV
H	7236.00	43.96	8.31	52.27	74.00	-21.73	PK
H	7236.00	36.61	8.31	44.92	54.00	-9.08	AV
Middle channel:2437MHz							
V	4874.00	50.69	-0.38	50.31	74.00	-23.69	PK
V	4874.00	42.78	-0.38	42.40	54.00	-11.60	AV
V	7311.00	41.16	8.83	49.99	74.00	-24.01	PK
V	7311.00	33.11	8.83	41.94	54.00	-12.06	AV
H	4874.00	46.41	-0.38	46.03	74.00	-27.97	PK
H	4874.00	35.86	-0.38	35.48	54.00	-18.52	AV
H	7311.00	39.92	8.83	48.75	74.00	-25.25	PK
H	7311.00	32.36	8.83	41.19	54.00	-12.81	AV
High channel:2462MHz							
V	4924.00	53.04	-0.32	52.72	74.00	-21.28	PK
V	4924.00	43.79	-0.32	43.47	54.00	-10.53	AV
V	7386.00	46.29	9.35	55.64	74.00	-18.36	PK
V	7386.00	35.75	9.35	45.10	54.00	-8.90	AV
H	4924.00	51.01	-0.32	50.69	74.00	-23.31	PK
H	4924.00	41.01	-0.32	40.69	54.00	-13.31	AV
H	7386.00	43.96	9.35	53.31	74.00	-20.69	PK
H	7386.00	36.50	9.35	45.85	54.00	-8.15	AV

Remark:

1. Emission Level = Meter Reading + Factor,
Factor = Antenna Factor + Cable Loss – Pre-amplifier.
Over = Emission Level - Limit
2. If peak below the average limit, the average emission was no test.
3. In restricted bands of operation, The spurious emissions below the permissible value more than 20dB
4. The amplitude of spurious emissions which are attenuated by more than 20dB below the permissible value has no need to be reported.

802.11g

Polar (H/V)	Frequency	Reading Level	Correct Factor	Measure- ment	Limits	Over	Detector Type
	(MHz)	(dBuV/m)	(dB)	(dBuV/m)	(dBuV/ m)	(dB)	
Low channel:2412MHz							
V	4824.00	52.13	-0.43	51.70	74.00	-22.30	PK
V	4824.00	44.09	-0.43	43.66	54.00	-10.34	AV
V	7236.00	43.49	8.31	51.80	74.00	-22.20	PK
V	7236.00	33.81	8.31	42.12	54.00	-11.88	AV
H	4824.00	49.26	-0.43	48.83	74.00	-25.17	PK
H	4824.00	39.50	-0.43	39.07	54.00	-14.93	AV
H	7236.00	42.29	8.31	50.60	74.00	-23.40	PK
H	7236.00	34.10	8.31	42.41	54.00	-11.59	AV
Middle channel:2437MHz							
V	4874.00	50.02	-0.38	49.64	74.00	-24.36	PK
V	4874.00	42.10	-0.38	41.72	54.00	-12.28	AV
V	7311.00	40.52	8.83	49.35	74.00	-24.65	PK
V	7311.00	31.66	8.83	40.49	54.00	-13.51	AV
H	4874.00	47.41	-0.38	47.03	74.00	-26.97	PK
H	4874.00	37.57	-0.38	37.19	54.00	-16.81	AV
H	7311.00	39.26	8.83	48.09	74.00	-25.91	PK
H	7311.00	31.98	8.83	40.81	54.00	-13.19	AV
High channel:2462MHz							
V	4924.00	51.64	-0.32	51.32	74.00	-22.68	PK
V	4924.00	42.91	-0.32	42.59	54.00	-11.41	AV
V	7386.00	43.21	9.35	52.56	74.00	-21.44	PK
V	7386.00	34.01	9.35	43.36	54.00	-10.64	AV
H	4924.00	50.41	-0.32	50.09	74.00	-23.91	PK
H	4924.00	39.87	-0.32	39.55	54.00	-14.45	AV
H	7386.00	41.26	9.35	50.61	74.00	-23.39	PK
H	7386.00	33.30	9.35	42.65	54.00	-11.35	AV

Remark:

1.Emission Level = Meter Reading + Factor,

Factor = Antenna Factor + Cable Loss – Pre-amplifier.

Over= Emission Level - Limit

2.If peak below the average limit, the average emission was no test.

3. In restricted bands of operation, The spurious emissions below the permissible value more than 20dB

4. The amplitude of spurious emissions which are attenuated by more than 20dB below the permissible value has no need to be reported.

802.11n20

Polar (H/V)	Frequency	Reading Level	Correct Factor	Measure- ment	Limits	Over	Detector Type
	(MHz)	(dBuV/m)	(dB)	(dBuV/m)	(dBuV/ m)	(dB)	
Low channel:2412MHz							
V	4824.00	54.23	-0.43	53.80	74.00	-20.20	PK
V	4824.00	46.04	-0.43	45.61	54.00	-8.39	AV
V	7236.00	44.12	8.31	52.43	74.00	-21.57	PK
V	7236.00	35.05	8.31	43.36	54.00	-10.64	AV
H	4824.00	49.47	-0.43	49.04	74.00	-24.96	PK
H	4824.00	38.51	-0.43	38.08	54.00	-15.92	AV
H	7236.00	42.70	8.31	51.01	74.00	-22.99	PK
H	7236.00	35.56	8.31	43.87	54.00	-10.13	AV
Middle channel:2437MHz							
V	4874.00	53.22	-0.38	52.84	74.00	-21.16	PK
V	4874.00	46.24	-0.38	45.86	54.00	-8.14	AV
V	7311.00	42.89	8.83	51.72	74.00	-22.28	PK
V	7311.00	33.18	8.83	42.01	54.00	-11.99	AV
H	4874.00	51.48	-0.38	51.10	74.00	-22.90	PK
H	4874.00	41.79	-0.38	41.41	54.00	-12.59	AV
H	7311.00	40.22	8.83	49.05	74.00	-24.95	PK
H	7311.00	31.59	8.83	40.42	54.00	-13.58	AV
High channel:2462MHz							
V	4924.00	55.01	-0.32	54.69	74.00	-19.31	PK
V	4924.00	44.92	-0.32	44.60	54.00	-9.40	AV
V	7386.00	46.70	9.35	56.05	74.00	-17.95	PK
V	7386.00	37.39	9.35	46.74	54.00	-7.26	AV
H	4924.00	52.60	-0.32	52.28	74.00	-21.72	PK
H	4924.00	41.70	-0.32	41.38	54.00	-12.62	AV
H	7386.00	45.34	9.35	54.69	74.00	-19.31	PK
H	7386.00	37.98	9.35	47.33	54.00	-6.67	AV

Remark:

1. Emission Level = Meter Reading + Factor,
Factor = Antenna Factor + Cable Loss – Pre-amplifier;
Over = Emission Level - Limit
2. If peak below the average limit, the average emission was no test.
3. In restricted bands of operation, The spurious emissions below the permissible value more than 20dB
4. The amplitude of spurious emissions which are attenuated by more than 20dB below the permissible value has no need to be reported.

802.11n40

Polar (H/V)	Frequency	Reading Level	Correct Factor	Measure- ment	Limits	Over	Detector Type
	(MHz)	(dBuV/m)	(dB)	(dBuV/m)	(dBuV/ m)	(dB)	
Low channel:2422MHz							
V	4844.00	53.89	-0.43	53.46	74.00	-20.54	PK
V	4844.00	43.88	-0.43	43.45	54.00	-10.55	AV
V	7266.00	45.02	8.31	53.33	74.00	-20.67	PK
V	7266.00	34.64	8.31	42.95	54.00	-11.05	AV
H	4844.00	50.09	-0.43	49.66	74.00	-24.34	PK
H	4844.00	40.03	-0.43	39.60	54.00	-14.40	AV
H	7266.00	42.18	8.31	50.49	74.00	-23.51	PK
H	7266.00	35.11	8.31	43.42	54.00	-10.58	AV
Middle channel:2437MHz							
V	4874.00	52.15	-0.38	51.77	74.00	-22.23	PK
V	4874.00	45.93	-0.38	45.55	54.00	-8.45	AV
V	7311.00	43.65	8.83	52.48	74.00	-21.52	PK
V	7311.00	35.61	8.83	44.44	54.00	-9.56	AV
H	4874.00	48.18	-0.38	47.80	74.00	-26.20	PK
H	4874.00	37.20	-0.38	36.82	54.00	-17.18	AV
H	7311.00	42.16	8.83	50.99	74.00	-23.01	PK
H	7311.00	33.18	8.83	42.01	54.00	-11.99	AV
High channel:2452MHz							
V	4904.00	53.20	-0.32	52.88	74.00	-21.12	PK
V	4904.00	42.46	-0.32	42.14	54.00	-11.86	AV
V	7356.00	45.71	9.35	55.06	74.00	-18.94	PK
V	7356.00	36.01	9.35	45.36	54.00	-8.64	AV
H	4904.00	50.33	-0.32	50.01	74.00	-23.99	PK
H	4904.00	40.57	-0.32	40.25	54.00	-13.75	AV
H	7356.00	43.63	9.35	52.98	74.00	-21.02	PK
H	7356.00	34.63	9.35	43.98	54.00	-10.02	AV

Remark:

1. Emission Level = Meter Reading + Factor,
Factor = Antenna Factor + Cable Loss – Pre-amplifier;
Over = Emission Level - Limit
2. If peak below the average limit, the average emission was no test.
3. In restricted bands of operation, The spurious emissions below the permissible value more than 20dB
4. The amplitude of spurious emissions which are attenuated by more than 20dB below the permissible value has no need to be reported.

8. Radiated Band Emission Measurement And Restricted Bands Of Operation

8.1 Block Diagram Of Test Setup

Radiated Emission Test-Up Frequency Above 1GHz

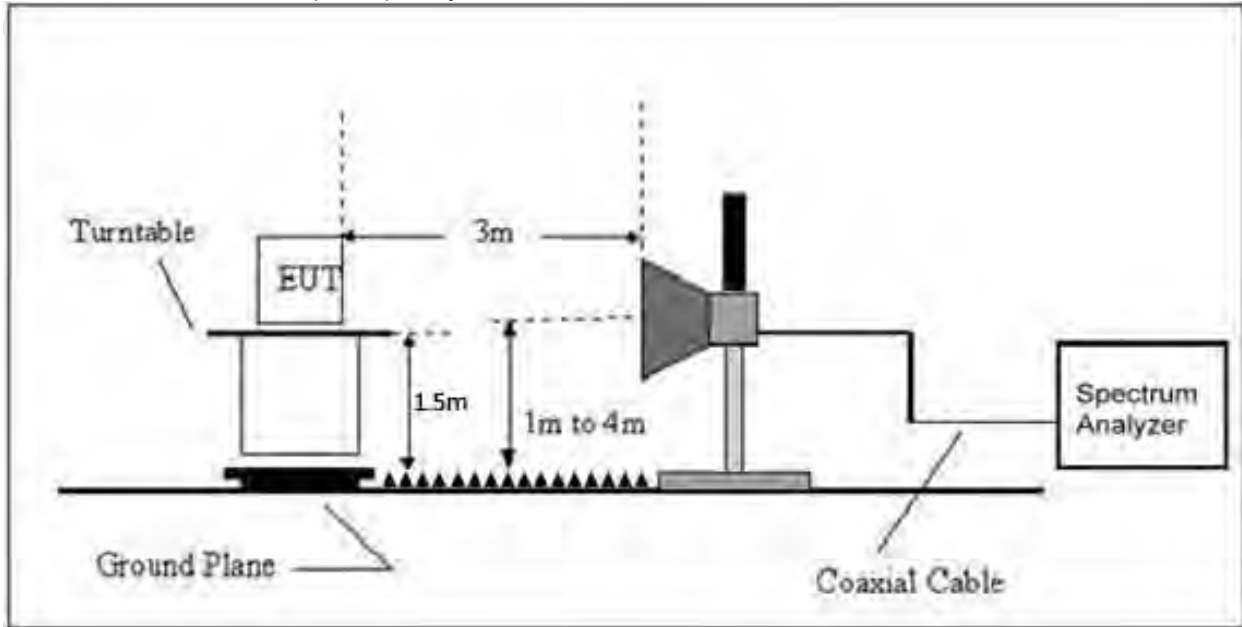

8.2 Limit

FCC Part15 C Section 15.209 and 15.205

(a) Except as shown in paragraph (d) of this section, only spurious emissions are permitted in any of the frequency bands listed below:

MHz	MHz	MHz	GHz
0.090-0.110	16.42-16.423	399.9-410	4.5-5.15
0.495-0.505	16.69475-16.69525	608-614	5.35-5.46
2.1735-2.1905	16.80425-16.80475	960-1240	7.25-7.75
4.125-4.128	25.5-25.67	1300-1427	8.025-8.5
4.17725-4.17775	37.5-38.25	1435-1626.5	9.0-9.2
4.20725-4.20775	73-74.6	1645.5-1646.5	9.3-9.5
6.215-6.218	74.8-75.2	1660-1710	10.6-12.7
6.26775-6.26825	108-121.94	1718.8-1722.2	13.25-13.4
6.31175-6.31225	123-138	2200-2300	14.47-14.5
8.291-8.294	149.9-150.05	2310-2390	15.35-16.2
8.362-8.366	156.52475-156.52525	2483.5-2500	17.7-21.4
8.37625-8.38675	156.7-156.9	2690-2900	22.01-23.12
8.41425-8.41475	162.0125-167.17	3260-3267	23.6-24.0
12.29-12.293	167.72-173.2	3332-3339	31.2-31.8
12.51975-12.52025	240-285	3345.8-3358	36.43-36.5
12.57675-12.57725	322-335.4	3600-4400	(²)
13.36-13.41			

LIMITS OF RADIATED EMISSION MEASUREMENT (Above 1000MHz)

FREQUENCY (MHz)	Limit (dBuV/m) (at 3M)	
	PEAK	AVERAGE
Above 1000	74	54

Notes:

- (1)The limit for radiated test was performed according to FCC PART 15C.
- (2)The tighter limit applies at the band edges.
- (3)Emission level (dBuV/m)=20log Emission level (uV/m).

8.3 Test Procedure

Receiver Parameter	Setting
Attenuation	Auto
Start Frequency	2300MHz
Stop Frequency	2520
RB / VB (emission in restricted band)	1 MHz / 1 MHz for Peak, 1 MHz / 10Hz for Average

Above 1GHz test procedure as below:

- a. The EUT was placed on the top of a rotating table 1.5 meters above the ground at a 3 meter chamber. The table was rotated 360 degrees to determine the position of the highest radiation.
- b. The EUT was set 3 meters away from the interference-receiving antenna, which was mounted on the top of a variable-height antenna tower.
- c. The antenna height is varied from one meter to four meters above the ground to determine the maximum value of the field strength. Both horizontal and vertical polarizations of the antenna are set to make the measurement.
- d. For each suspected emission, the EUT was arranged to its worst case and then the antenna was tuned to heights from 1 meter to 4 meters and the rota table was turned from 0 degrees to 360 degrees to find the maximum reading.
- e. The test-receiver system was set to Peak Detect Function and Specified Bandwidth with Maximum Hold Mode.
- f. If the emission level of the EUT in peak mode was 10dB lower than the limit specified, then testing could be stopped and the peak values of the EUT would be reported. Otherwise the emissions that did not have 10dB margin would be re-tested one by one using peak, quasi-peak or average method as specified and then reported in a data sheet.
- g. Test the EUT in the lowest channel, the Highest channel.

Note:

Both horizontal and vertical antenna polarities were tested and performed pretest to three orthogonal axis. The worst case emissions were reported.

8.4 EUT operating Conditions

The EUT was configured for testing in a typical fashion (as a customer would normally use it). The EUT has been programmed to continuously transmit during test. This operating condition was tested and used to collect the included data.

8.5 Test Result

	Polar (H/V)	Frequency (MHz)	Reading Level (dBuV/m)	Correct Factor (dB)	Measurement (dBuV/m)	Limits (dBuV/m)		Result
					PK	PK	AV	
802.11b	Low Channel 2412MHz							
	H	2390.00	53.47	-6.70	46.77	74.00	54.00	PASS
	H	2400.00	56.84	-6.71	50.13	74.00	54.00	PASS
	V	2390.00	54.44	-6.70	47.74	74.00	54.00	PASS
	V	2400.00	57.81	-6.71	51.10	74.00	54.00	PASS
	High Channel 2462MHz							
	H	2483.50	55.90	-6.79	49.11	74.00	54.00	PASS
	H	2500.00	50.68	-6.81	43.87	74.00	54.00	PASS
	V	2483.50	57.95	-6.79	51.16	74.00	54.00	PASS
	V	2500.00	53.04	-6.81	46.23	74.00	54.00	PASS
802.11g	Low Channel 2412MHz							
	H	2390.00	53.89	-6.70	47.19	74.00	54.00	PASS
	H	2400.00	57.01	-6.71	50.30	74.00	54.00	PASS
	V	2390.00	53.31	-6.70	46.61	74.00	54.00	PASS
	V	2400.00	57.81	-6.71	51.10	74.00	54.00	PASS
	High Channel 2462MHz							
	H	2483.50	58.26	-6.79	51.47	74.00	54.00	PASS
	H	2500.00	53.38	-6.81	46.57	74.00	54.00	PASS
	V	2483.50	57.07	-6.79	50.28	74.00	54.00	PASS
	V	2500.00	53.02	-6.81	46.21	74.00	54.00	PASS

Remark:

- Emission Level = Meter Reading + Factor,
Factor = Antenna Factor + Cable Loss – Pre-amplifier.
Over= Emission Level – Limit
- If the PK measured levels comply with average limit, then the average level were deemed to comply with average limit.
- In restricted bands of operation, The spurious emissions below the permissible value more than 20dB
- The amplitude of spurious emissions which are attenuated by more than 20dB below the permissible value has no need to be reported.

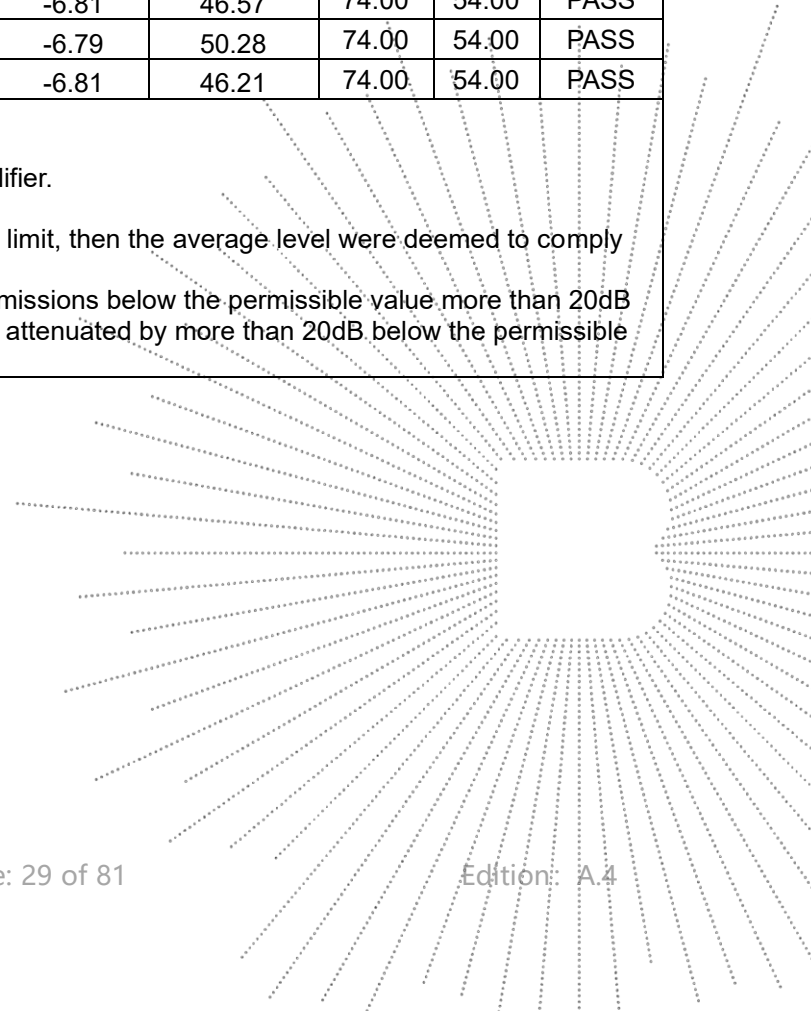

	Polar (H/V)	Frequency (MHz)	Reading Level (dBuV/m)	Correct Factor (dB)	Measurement (dBuV/m)	Limits (dBuV/m)		Result
					PK	PK	AV	
802.11 n20	Low Channel 2412MHz							
	H	2390.00	54.48	-6.70	47.78	74.00	54.00	PASS
	H	2400.00	58.06	-6.71	51.35	74.00	54.00	PASS
	V	2390.00	54.60	-6.70	47.90	74.00	54.00	PASS
	V	2400.00	57.74	-6.71	51.03	74.00	54.00	PASS
	High Channel 2462MHz							
	H	2483.50	58.88	-6.79	52.09	74.00	54.00	PASS
	H	2500.00	52.02	-6.81	45.21	74.00	54.00	PASS
	V	2483.50	57.61	-6.79	50.82	74.00	54.00	PASS
	V	2500.00	52.77	-6.81	45.96	74.00	54.00	PASS
802.11 n40	Low Channel 2422MHz							
	H	2390.00	54.61	-6.70	47.91	74.00	54.00	PASS
	H	2400.00	58.21	-6.71	51.50	74.00	54.00	PASS
	V	2390.00	53.64	-6.70	46.94	74.00	54.00	PASS
	V	2400.00	56.99	-6.71	50.28	74.00	54.00	PASS
	High Channel 2452MHz							
	H	2483.50	58.45	-6.79	51.66	74.00	54.00	PASS
	H	2500.00	51.72	-6.81	44.91	74.00	54.00	PASS
	V	2483.50	58.12	-6.79	51.33	74.00	54.00	PASS
	V	2500.00	55.25	-6.81	48.44	74.00	54.00	PASS

Remark:

- Emission Level = Meter Reading + Factor,
Factor = Antenna Factor + Cable Loss – Pre-amplifier.
Over= Emission Level – Limit
- If the PK measured levels comply with average limit, then the average level were deemed to comply with average limit.
- In restricted bands of operation, The spurious emissions below the permissible value more than 20dB
- The amplitude of spurious emissions which are attenuated by more than 20dB below the permissible value has no need to be reported.

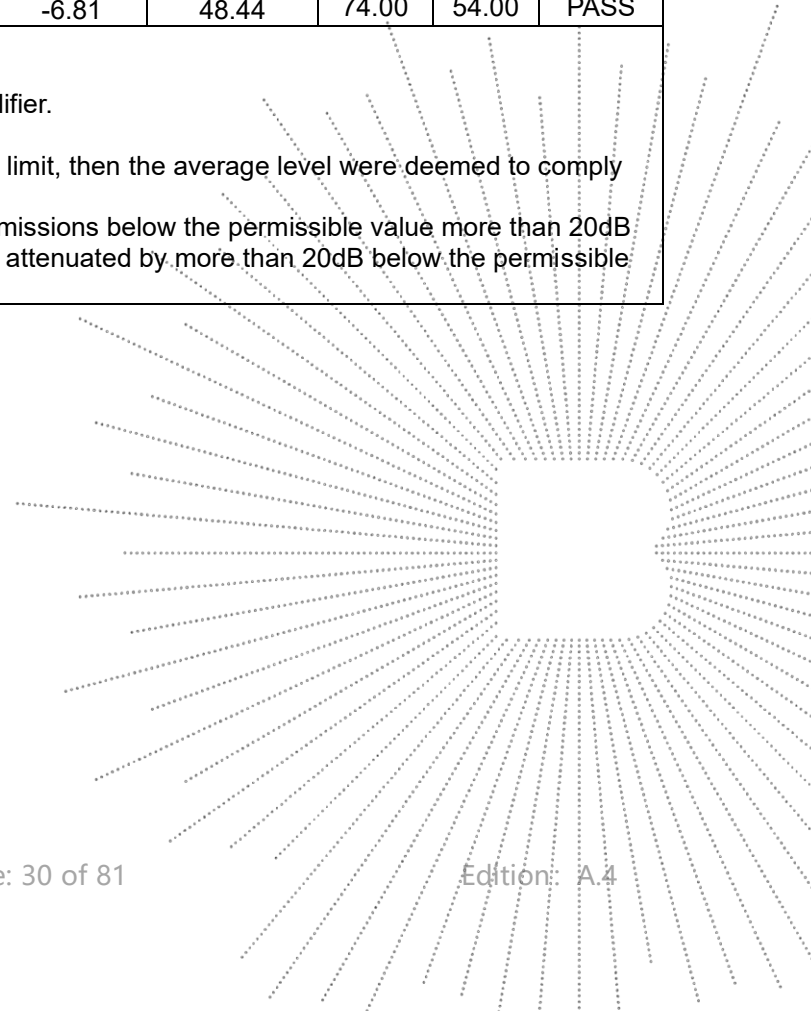

9. Power Spectral Density Test

9.1 Block Diagram Of Test Setup

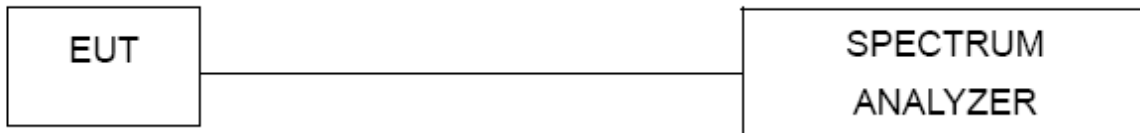

9.2 Limit

FCC Part15 (15.247) , Subpart C				
Section	Test Item	Limit	Frequency Range (MHz)	Result
15.247	Power Spectral Density	8 dBm (in any 3KHz)	2400-2483.5	PASS

LIMITS OF RADIATED EMISSION MEASUREMENT (Above 1000MHz)

9.3 Test Procedure

1. Set analyzer center frequency to DTS channel center frequency.
2. Set the span to 1.5 times the DTS bandwidth.
3. Set the RBW to: 3 kHz
4. Set the VBW $\geq 3 \times$ RBW.
5. Detector = peak.
6. Sweep time = auto couple.
7. Trace mode = max hold.
8. Allow trace to fully stabilize.
9. Use the peak marker function to determine the maximum amplitude level within the RBW.
10. If measured value exceeds limit, reduce RBW (no less than 3 kHz) and repeat.

9.4 EUT Operating Conditions

The EUT tested system was configured as the statements of 4.6. Unless otherwise a special operating condition is specified in the follows during the testing.

Note: Power Spectral Density(dBm)=Reading+Cable Loss

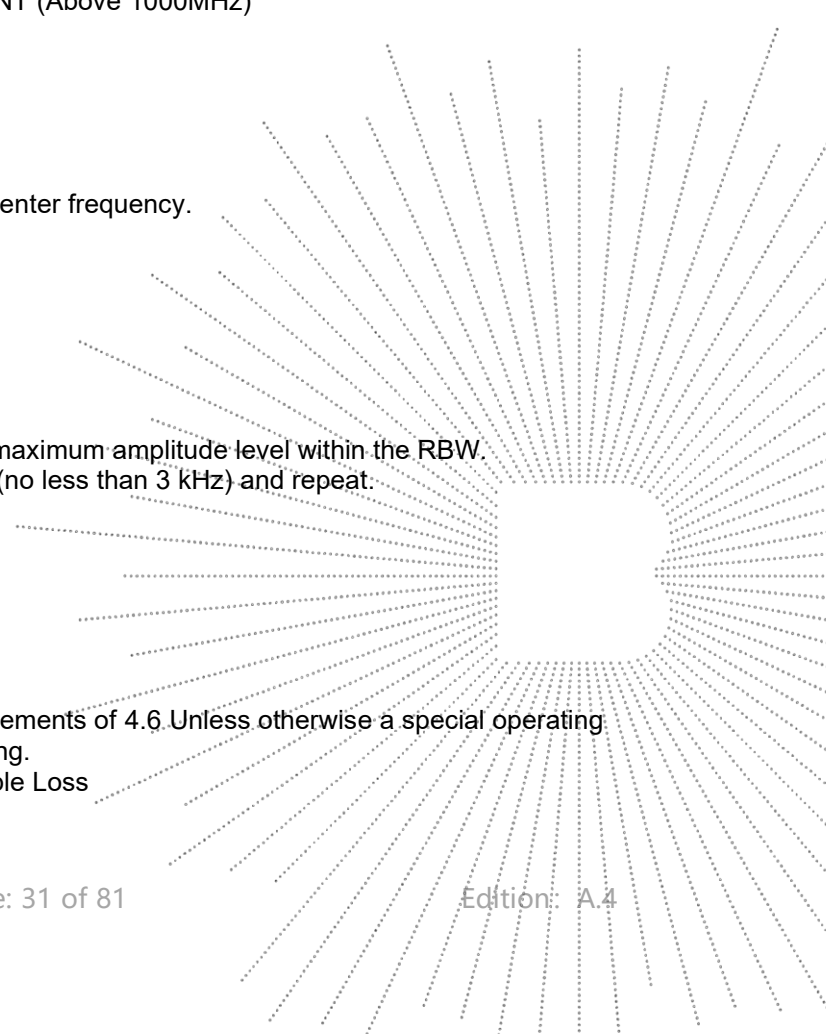

9.5 Test Result

Temperature :	26°C	Relative Humidity :	54%
Pressure :	101kPa	Test Voltage :	AC120V/60Hz

Condition	Mode	Frequency (MHz)	Power Spectral Density(dBm/10kHz)	Power Spectral Density(dBm/3kHz)	Limit (dBm/3kHz)	Verdict
NVNT	b	2412	-5.35	-10.58	8	Pass
NVNT	b	2437	-6.3	-11.53	8	Pass
NVNT	b	2462	-7.55	-12.78	8	Pass
NVNT	g	2412	-13.37	-18.60	8	Pass
NVNT	g	2437	-14.13	-19.36	8	Pass
NVNT	g	2462	-15.34	-20.57	8	Pass
NVNT	n20	2412	-12.66	-17.89	8	Pass
NVNT	n20	2437	-13.27	-18.50	8	Pass
NVNT	n20	2462	-14.5	-19.73	8	Pass
NVNT	n40	2422	-15.83	-21.06	8	Pass
NVNT	n40	2437	-15.89	-21.12	8	Pass
NVNT	n40	2452	-16.89	-22.12	8	Pass

Note: Correction Factor = $10\log(3\text{kHz}/\text{RBW in measurement}) = -5.23$

Power Spectral Density(dBm/3kHz) = Power Spectral Density(dBm/10kHz) + Correction Factor

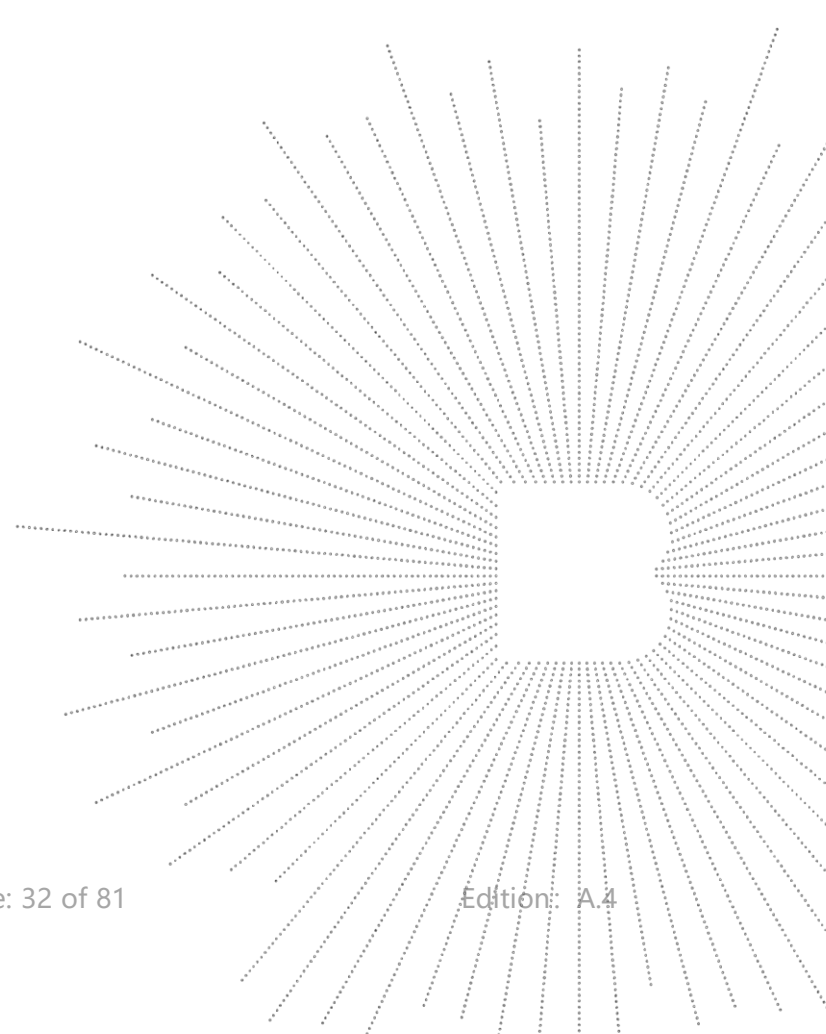

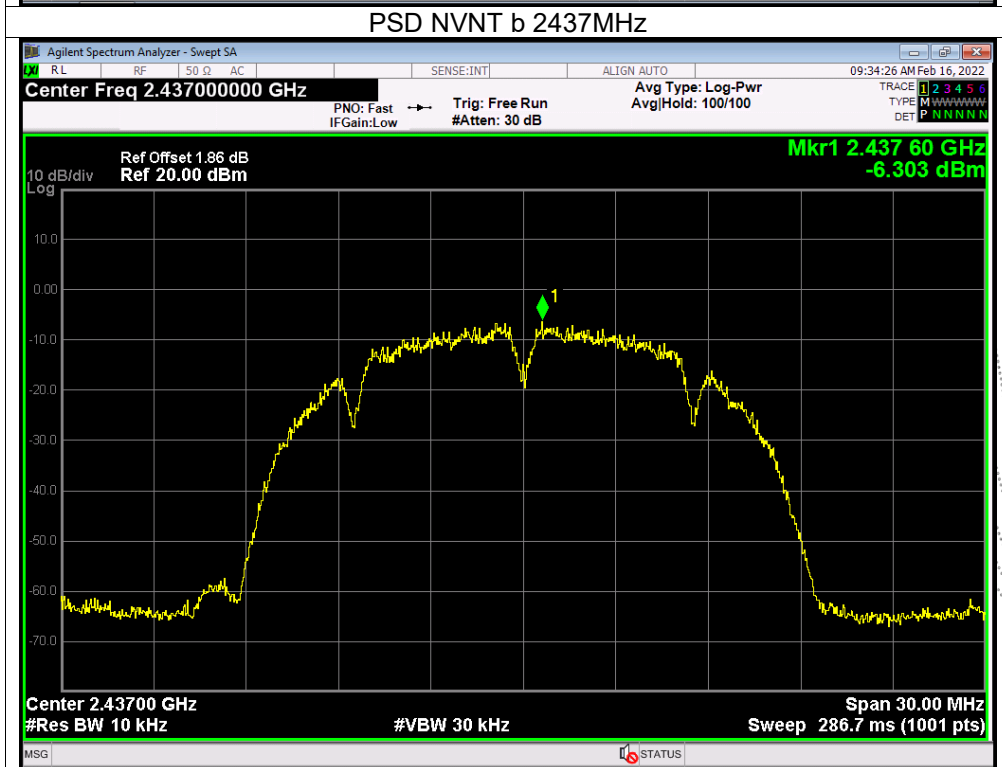
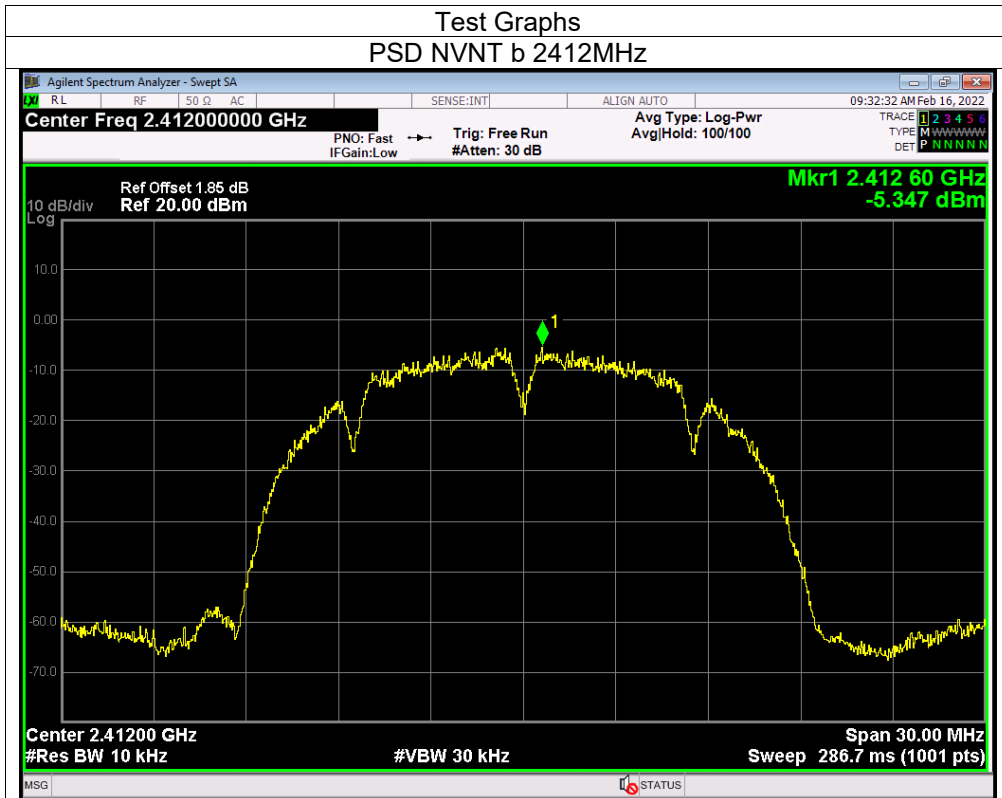

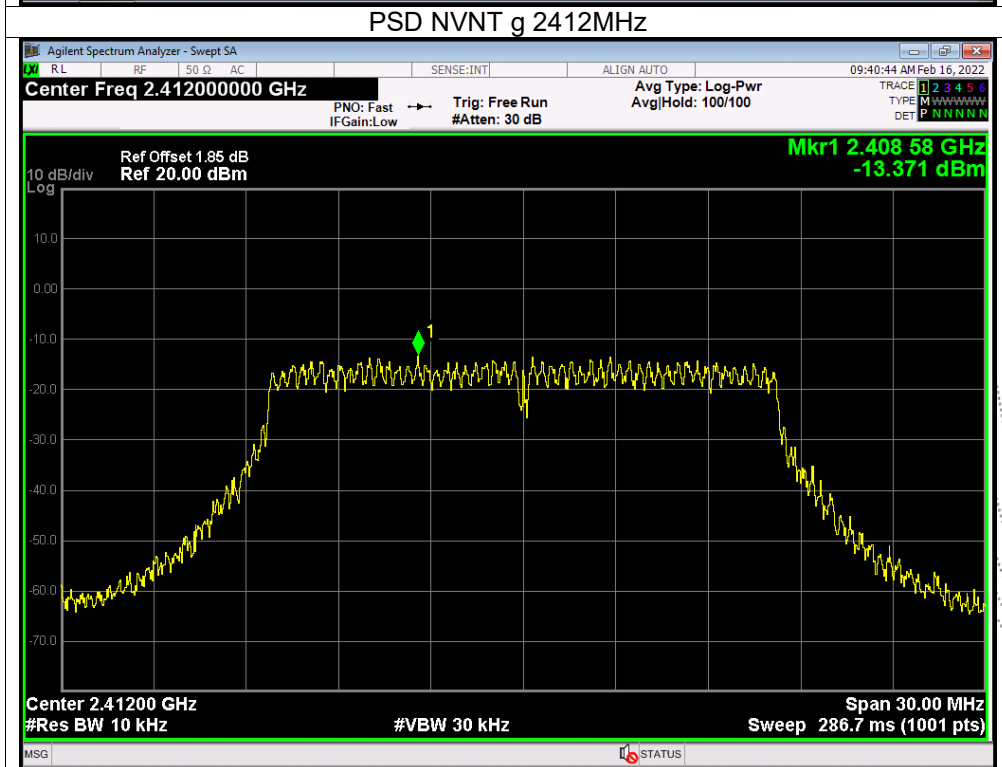
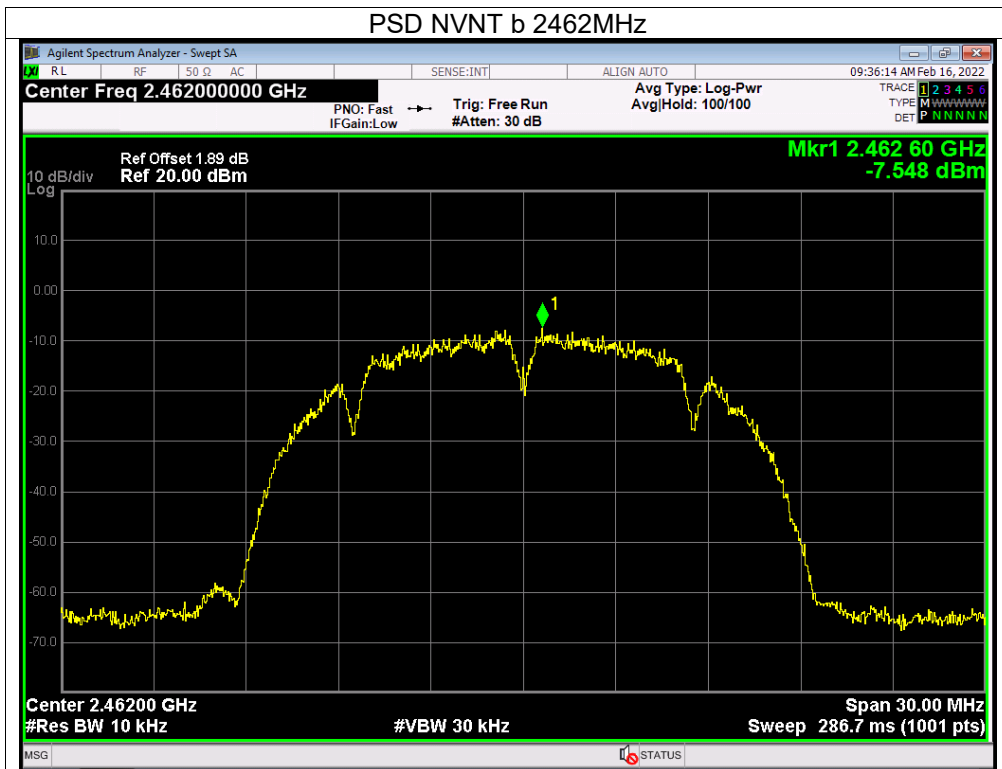

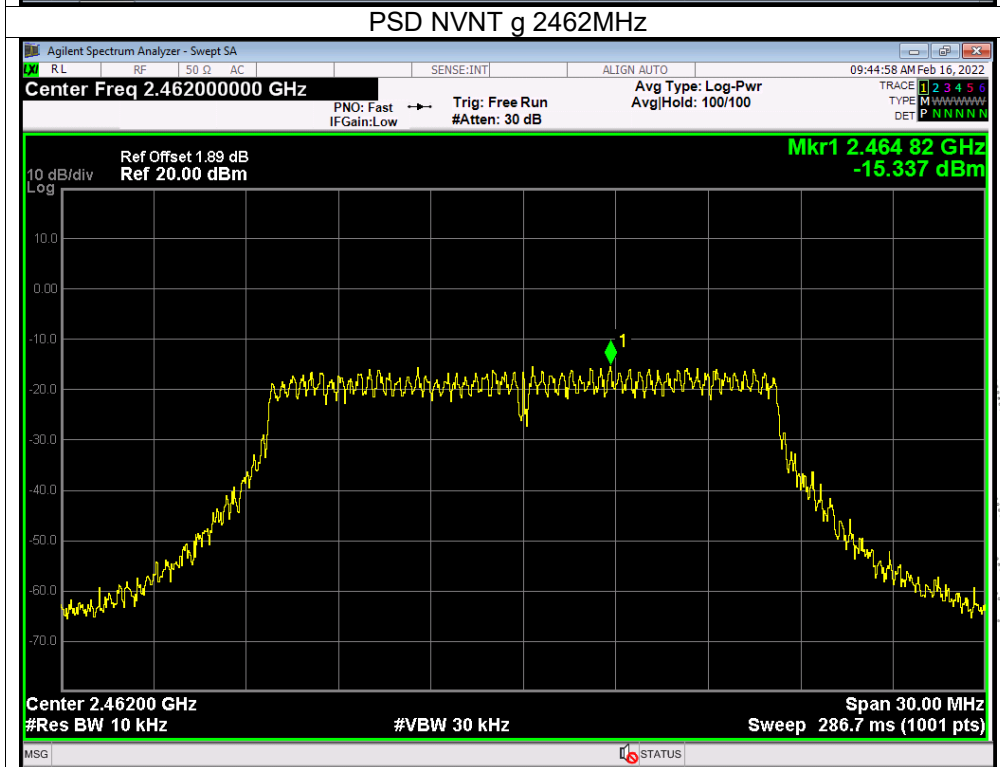
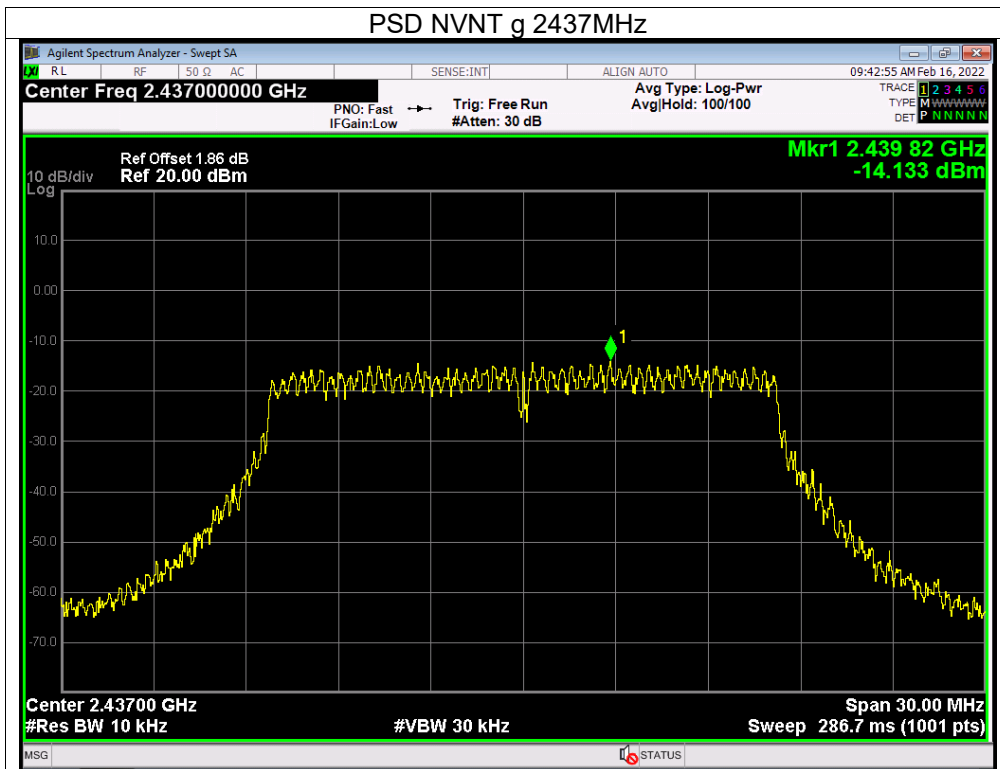

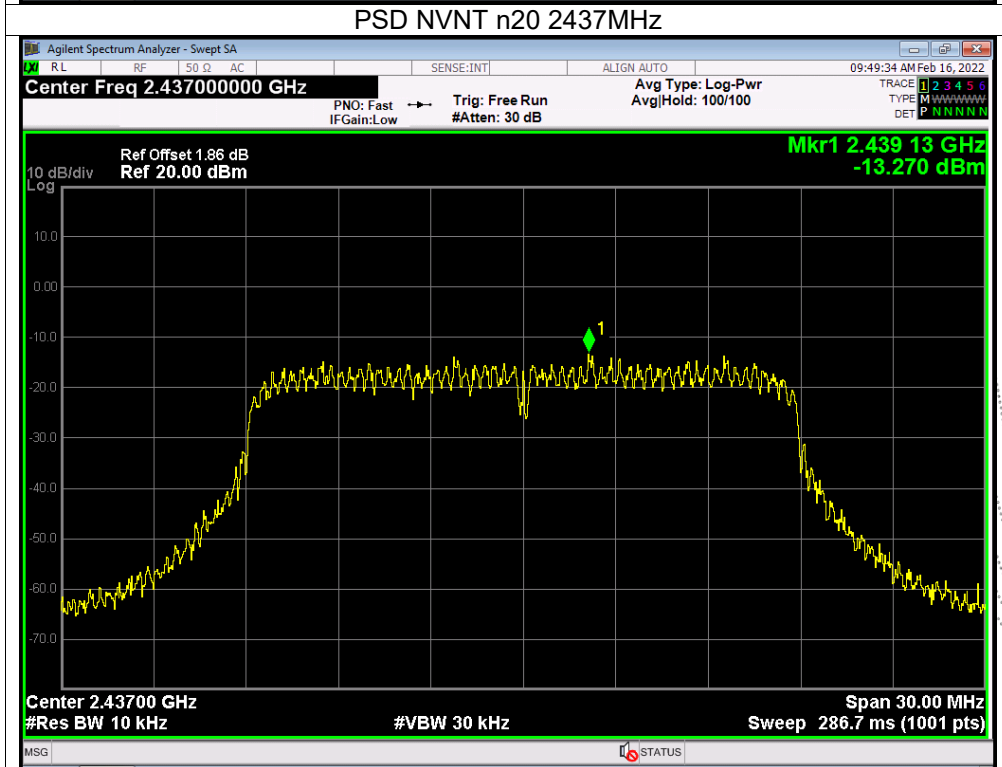
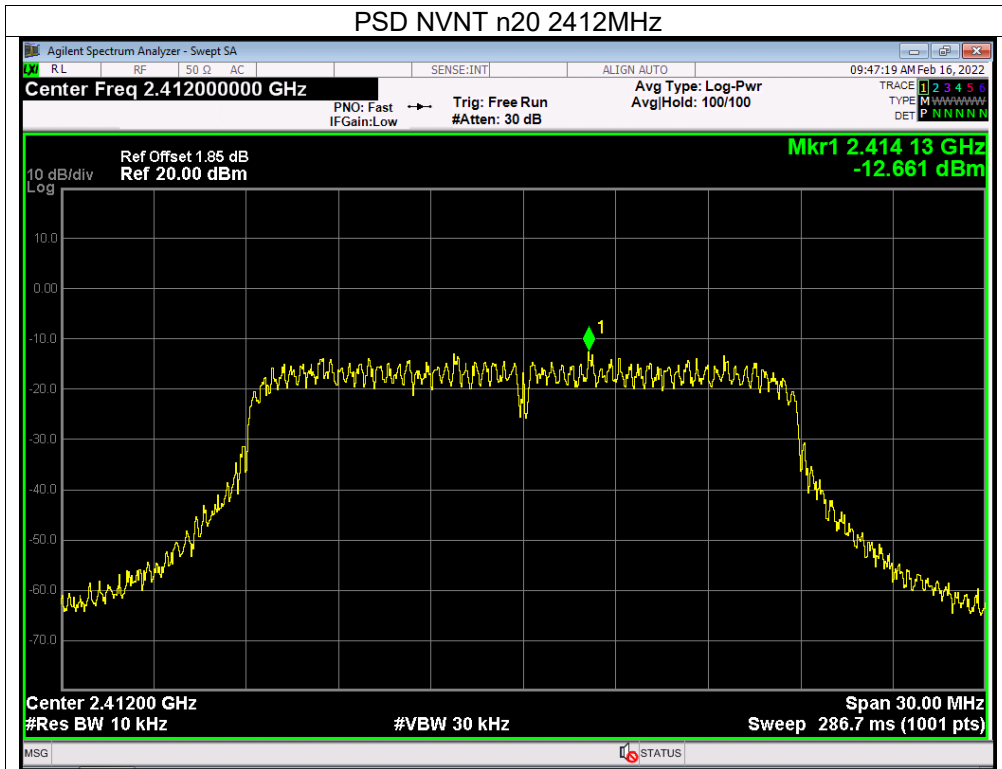

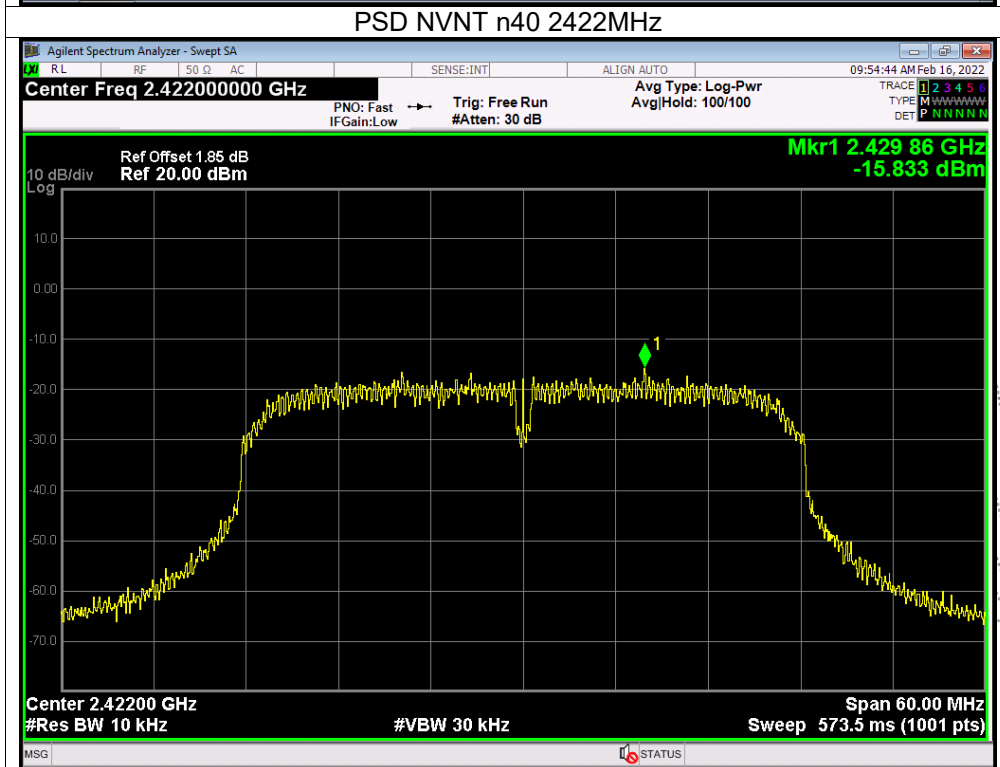
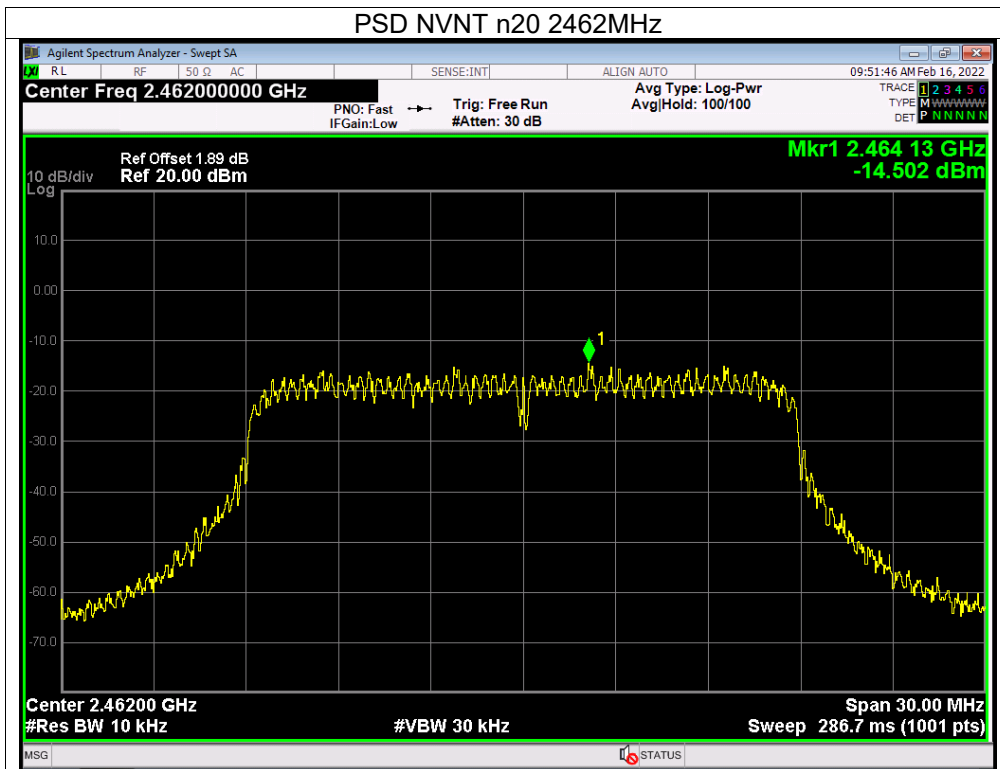

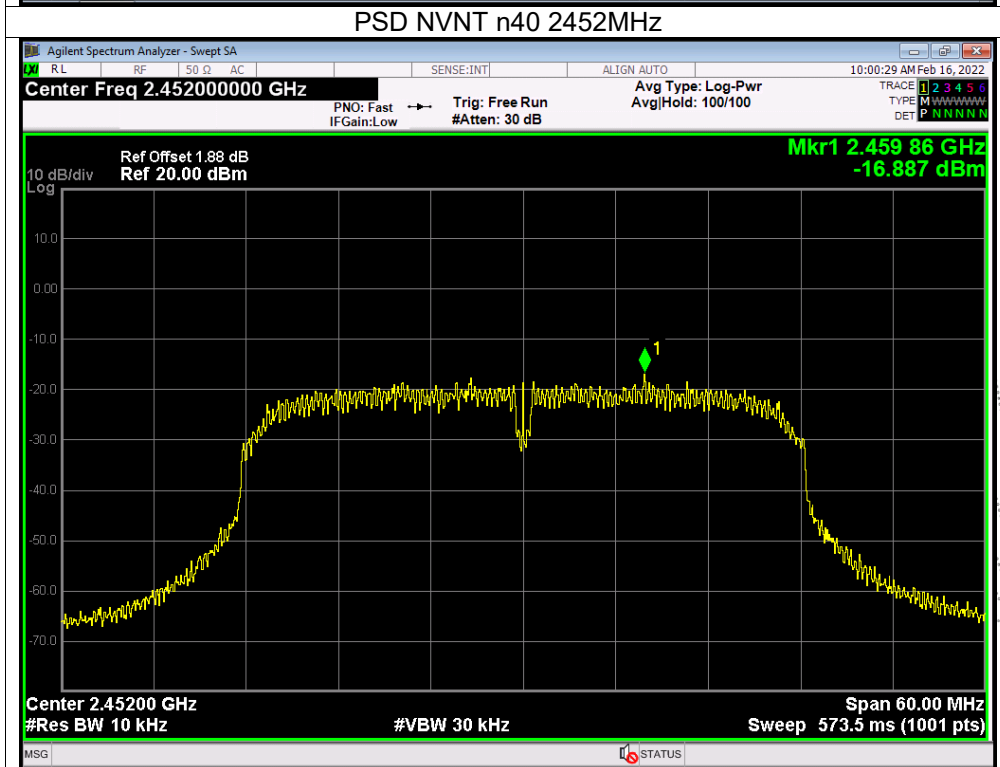
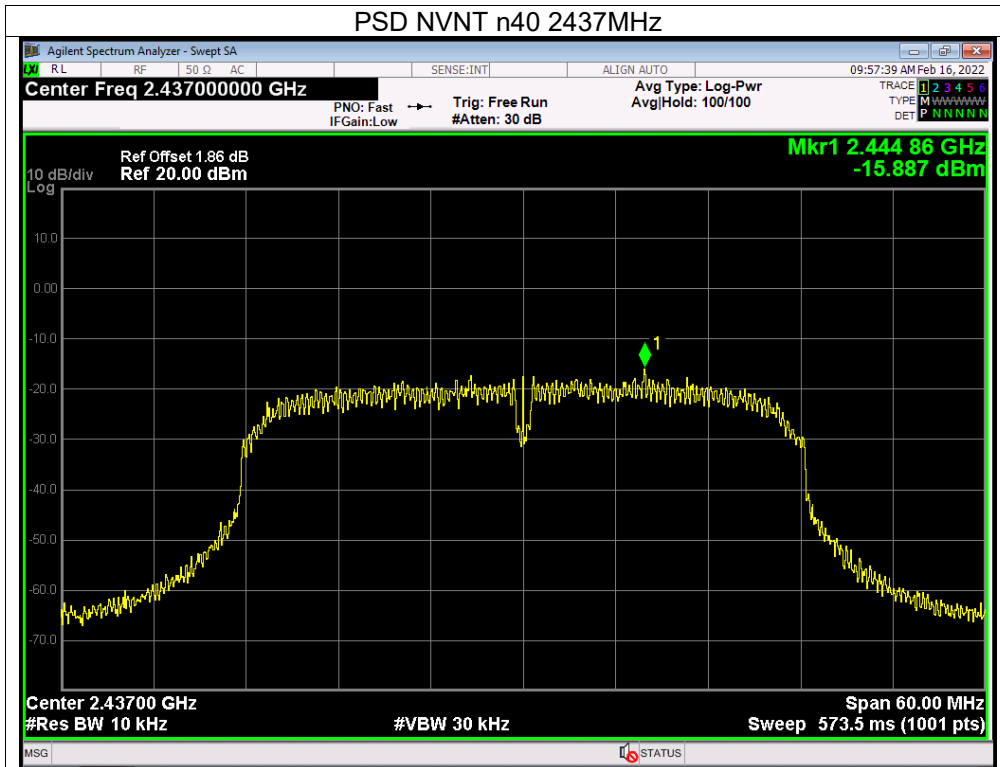

10. Bandwidth Test

10.1 Block Diagram Of Test Setup



10.2 Limit

FCC Part15 (15.247) , Subpart C				
Section	Test Item	Limit	Frequency Range (MHz)	Result
15.247(a)(2)	Bandwidth	$\geq 500\text{KHz}$ (6dB bandwidth)	2400-2483.5	PASS

10.3 Test Procedure

1. Set RBW = 100 kHz.
2. Set the video bandwidth (VBW) $\geq 3 \times$ RBW.
3. Detector = Peak.
4. Trace mode = max hold.
5. Sweep = auto couple.
6. Allow the trace to stabilize.
7. Measure the maximum width of the emission that is constrained by the frequencies associated with the two outermost amplitude points (upper and lower frequencies) that are attenuated by 6 dB relative to the maximum level measured in the fundamental emission.

10.4 EUT Operating Conditions

The EUT tested system was configured as the statements of 4.6 Unless otherwise a special operating condition is specified in the follows during the testing.

Note: Power Spectral Density(dBm)=Reading+Cable Loss

10.5 Test Result

Temperature :	26°C	Relative Humidity :	54%
Pressure :	101kPa	Test Voltage :	AC120V/60Hz

Condition	Mode	Frequency (MHz)	-6 dB Bandwidth (MHz)	Limit -6 dB Bandwidth (MHz)	Verdict
NVNT	b	2412	9.089	0.5	Pass
NVNT	b	2437	9.019	0.5	Pass
NVNT	b	2462	8.613	0.5	Pass
NVNT	g	2412	16.385	0.5	Pass
NVNT	g	2437	16.356	0.5	Pass
NVNT	g	2462	16.366	0.5	Pass
NVNT	n20	2412	17.299	0.5	Pass
NVNT	n20	2437	17.323	0.5	Pass
NVNT	n20	2462	17.309	0.5	Pass
NVNT	n40	2422	32.898	0.5	Pass
NVNT	n40	2437	32.899	0.5	Pass
NVNT	n40	2452	32.298	0.5	Pass

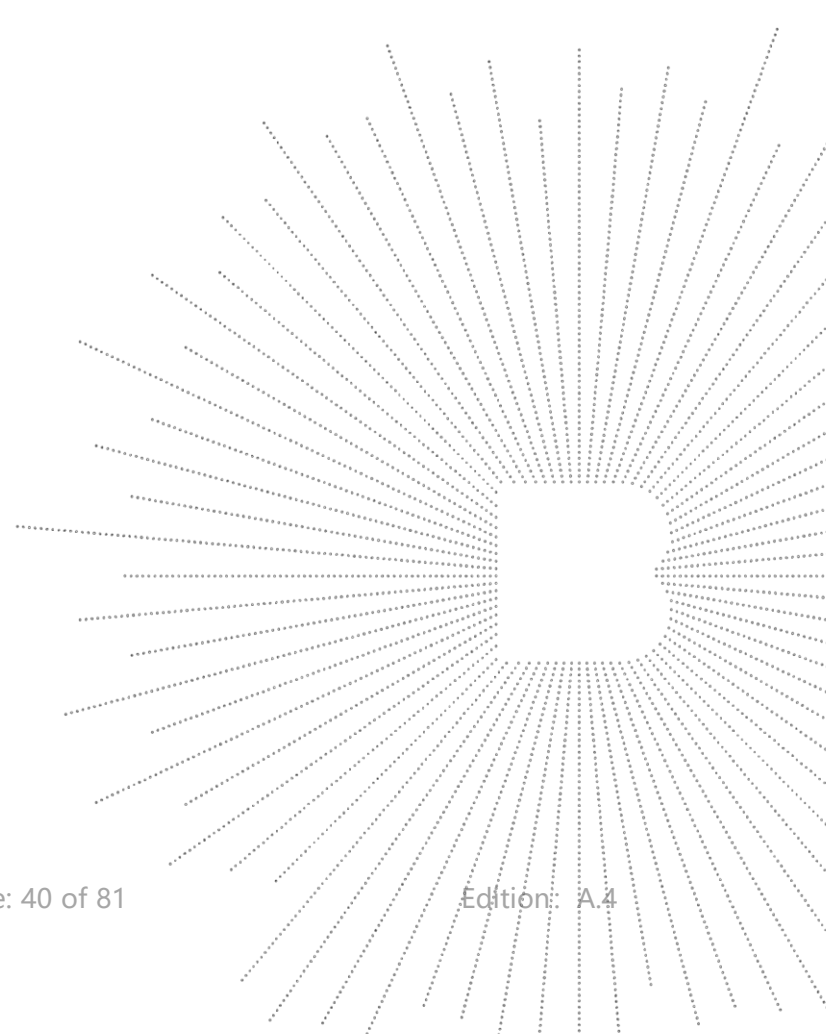

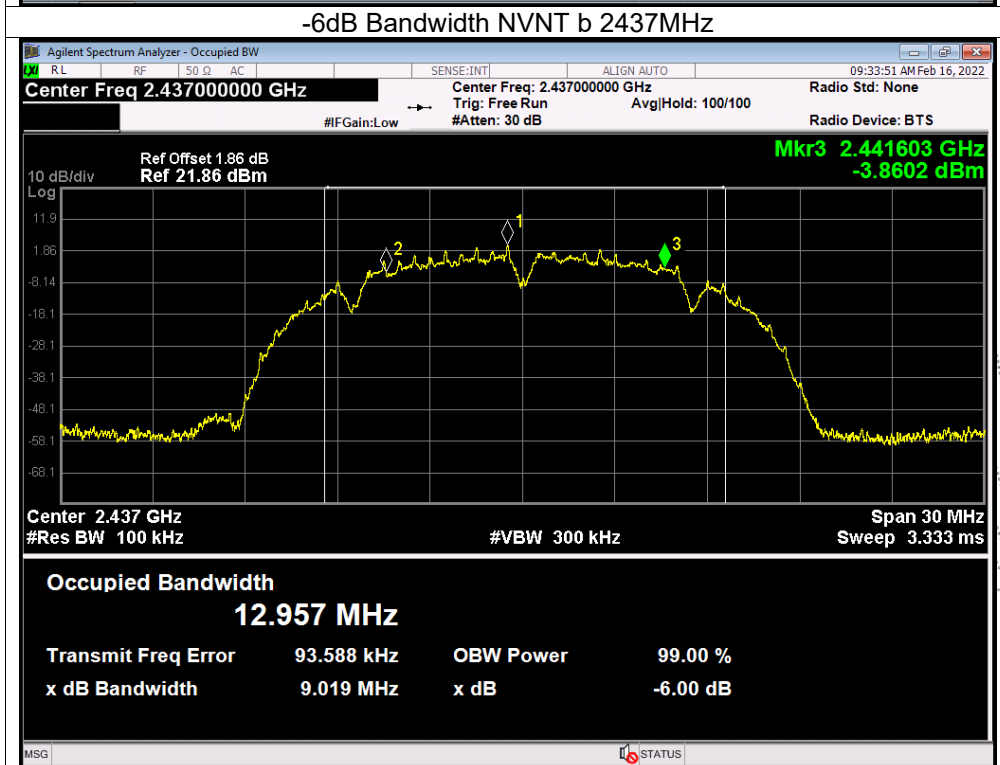
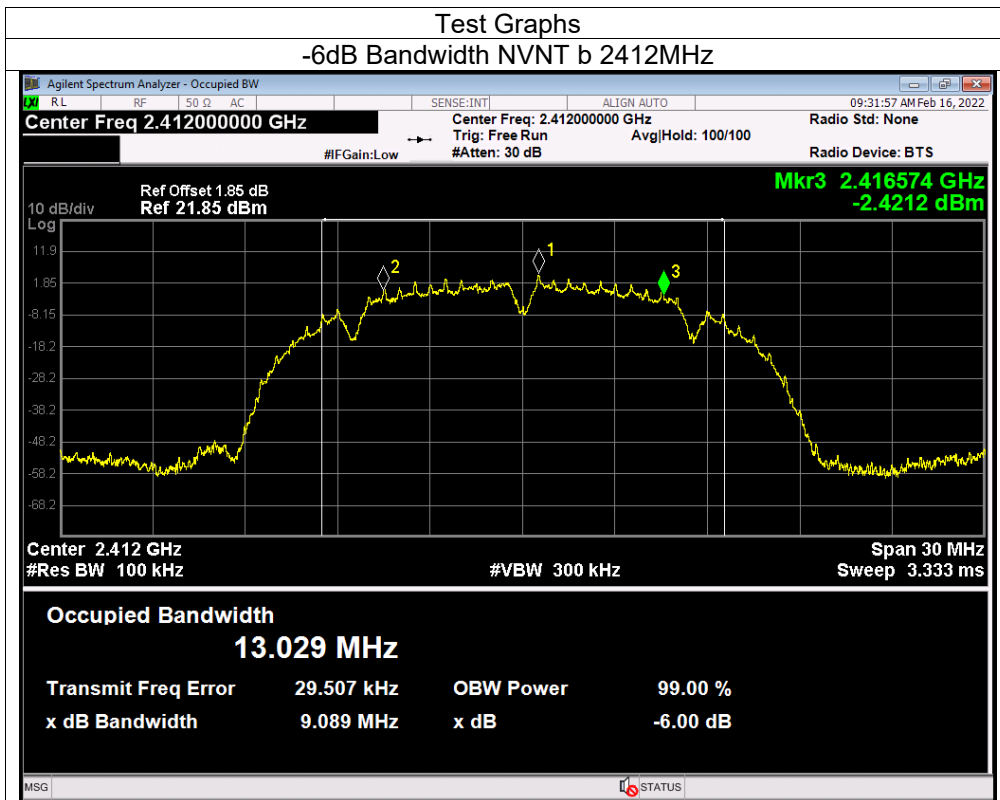

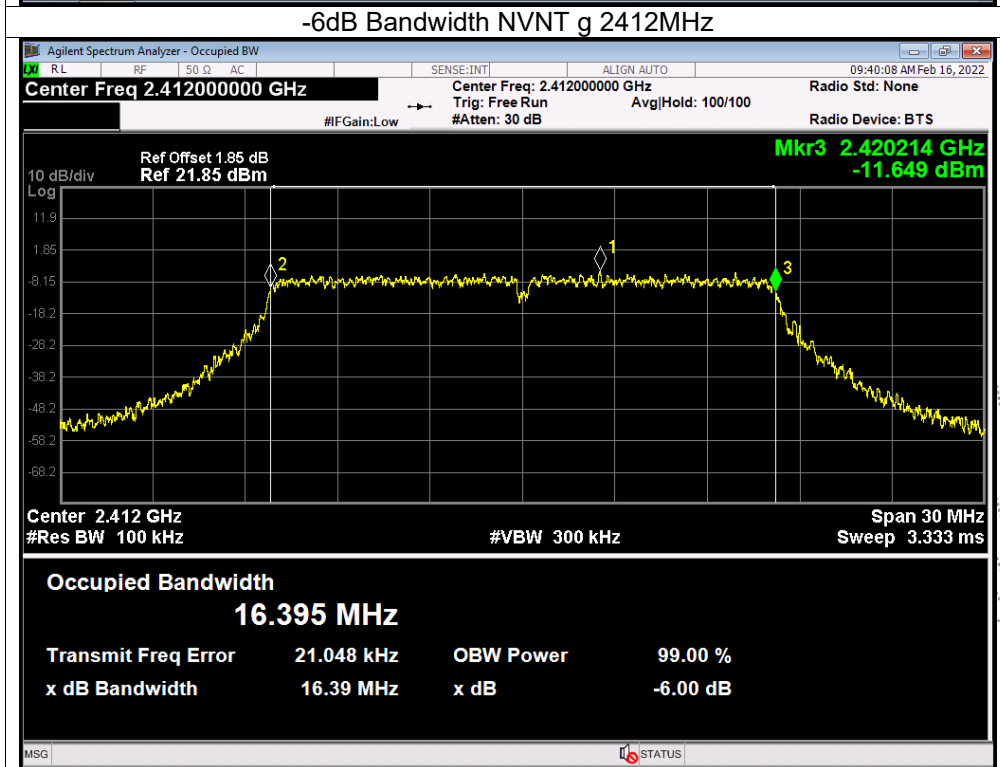
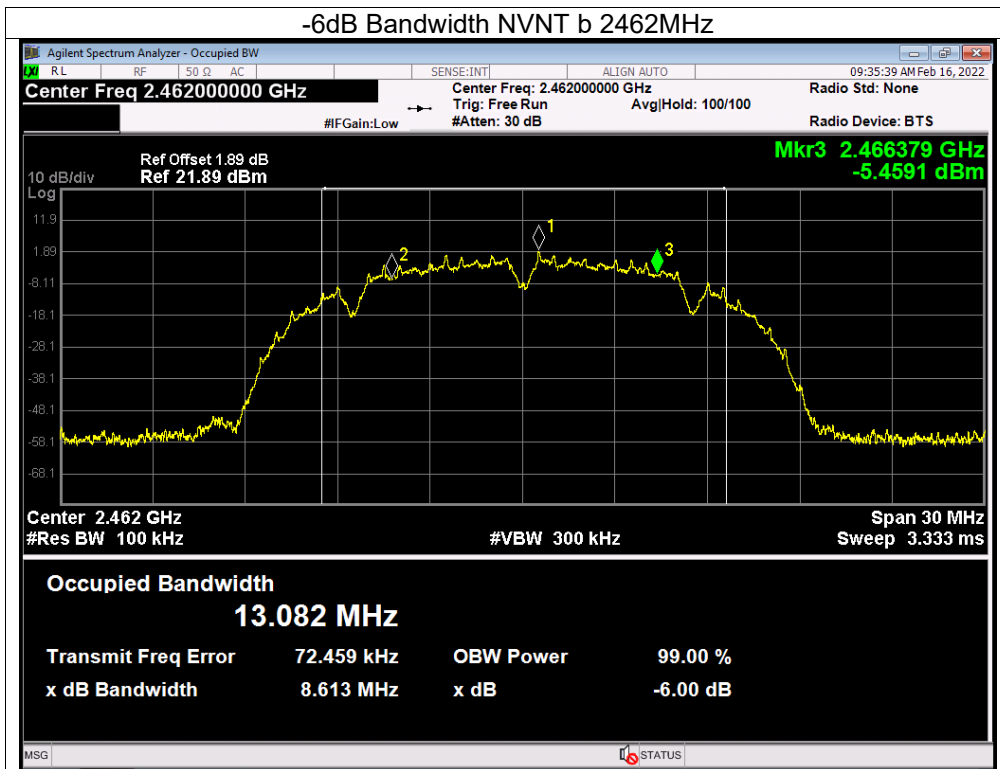

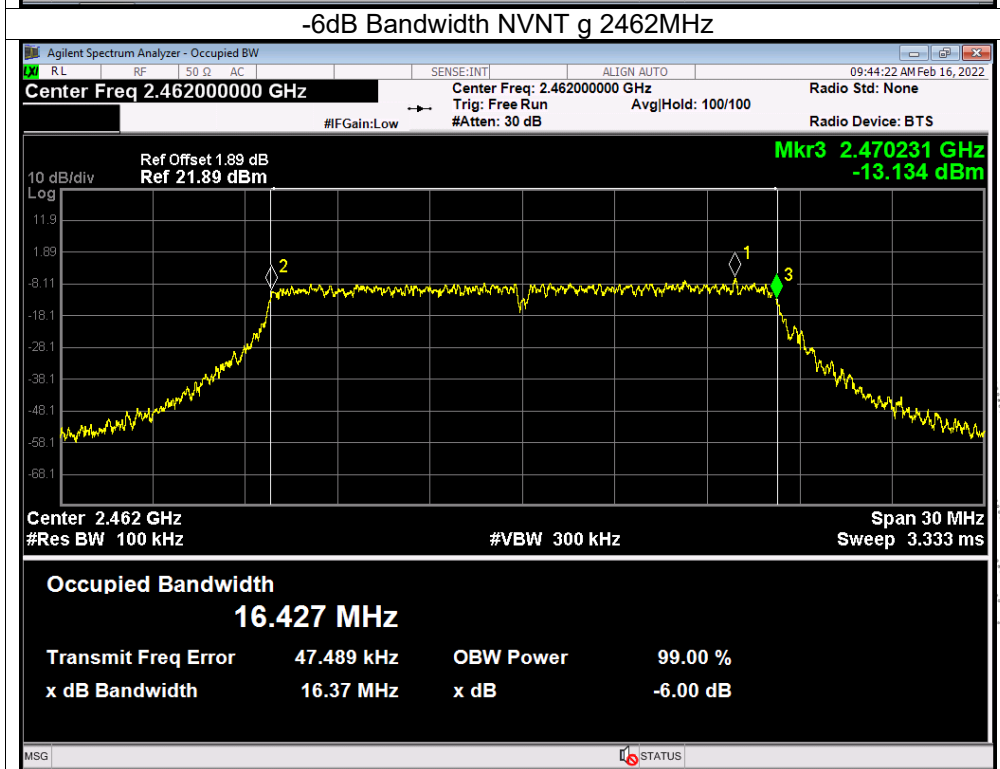
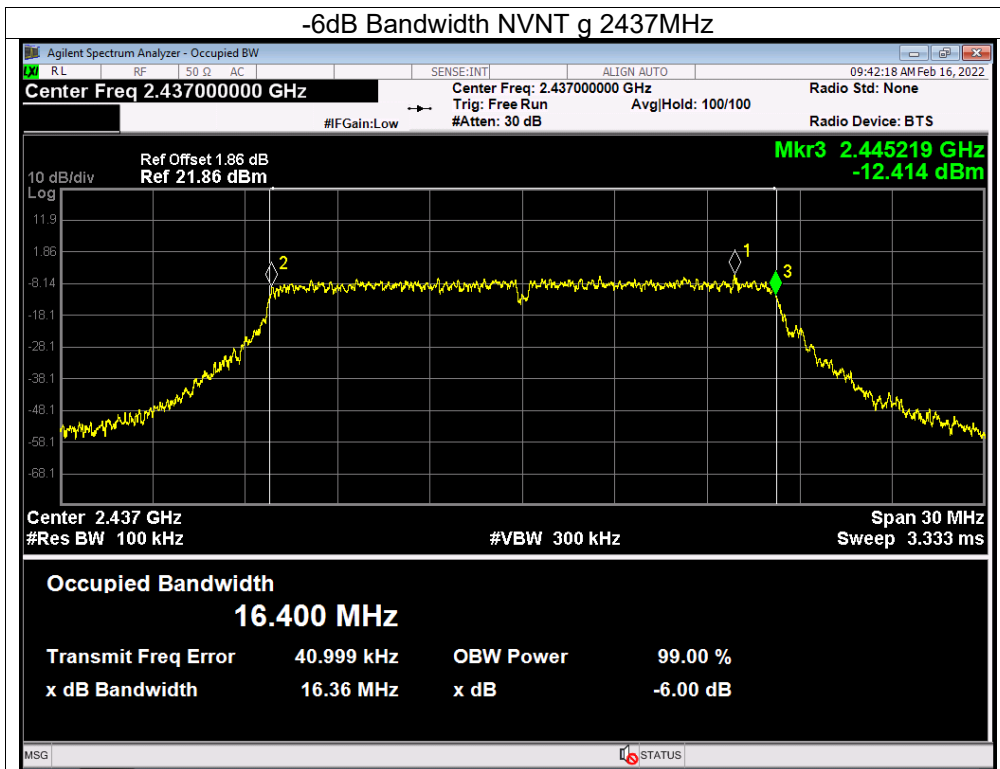

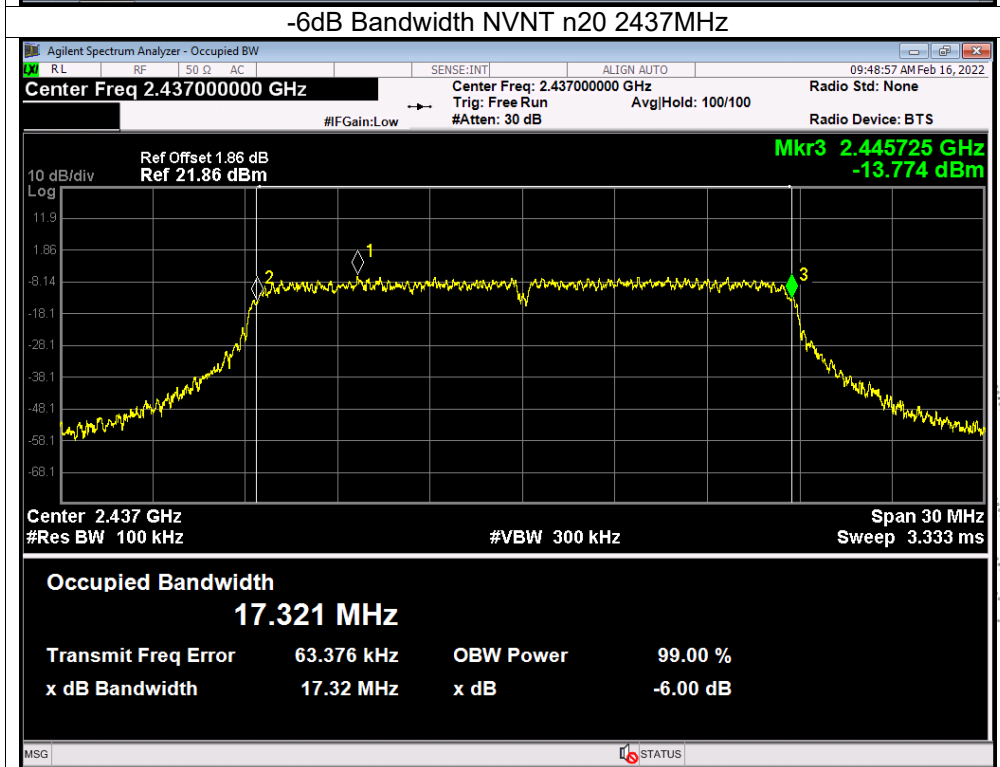
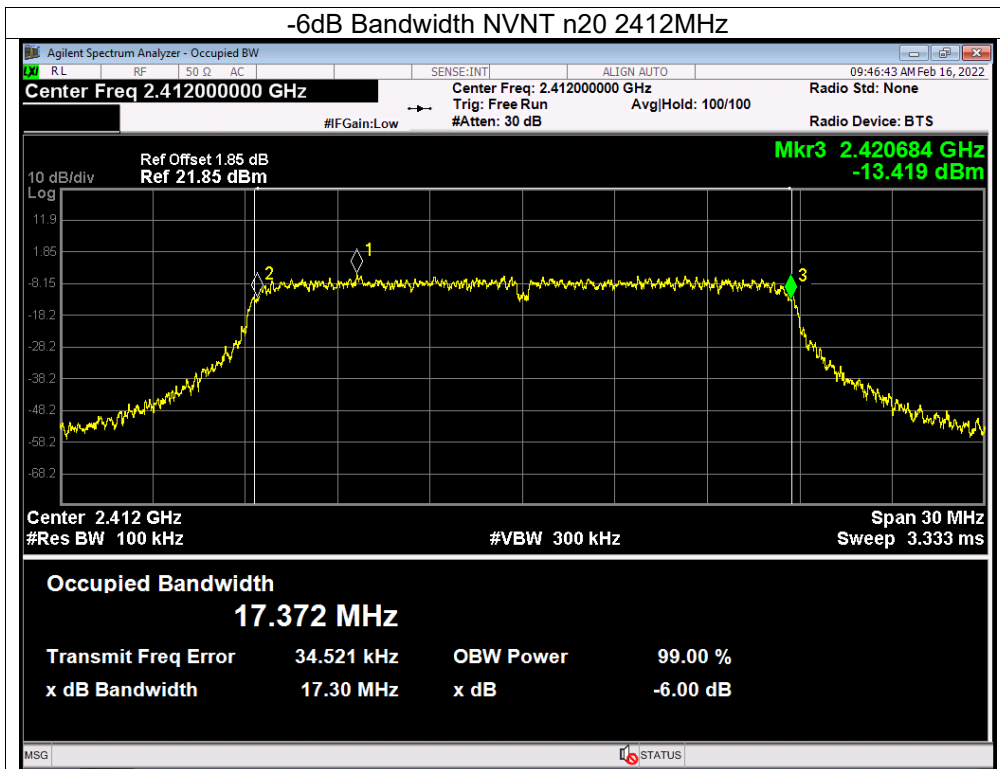

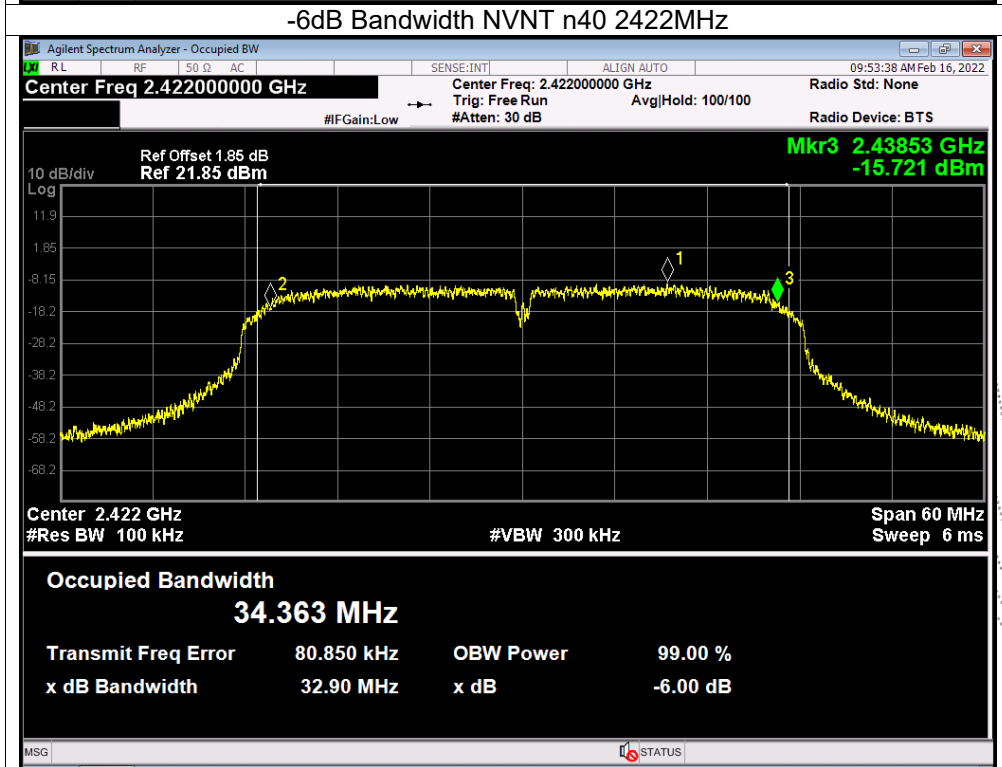
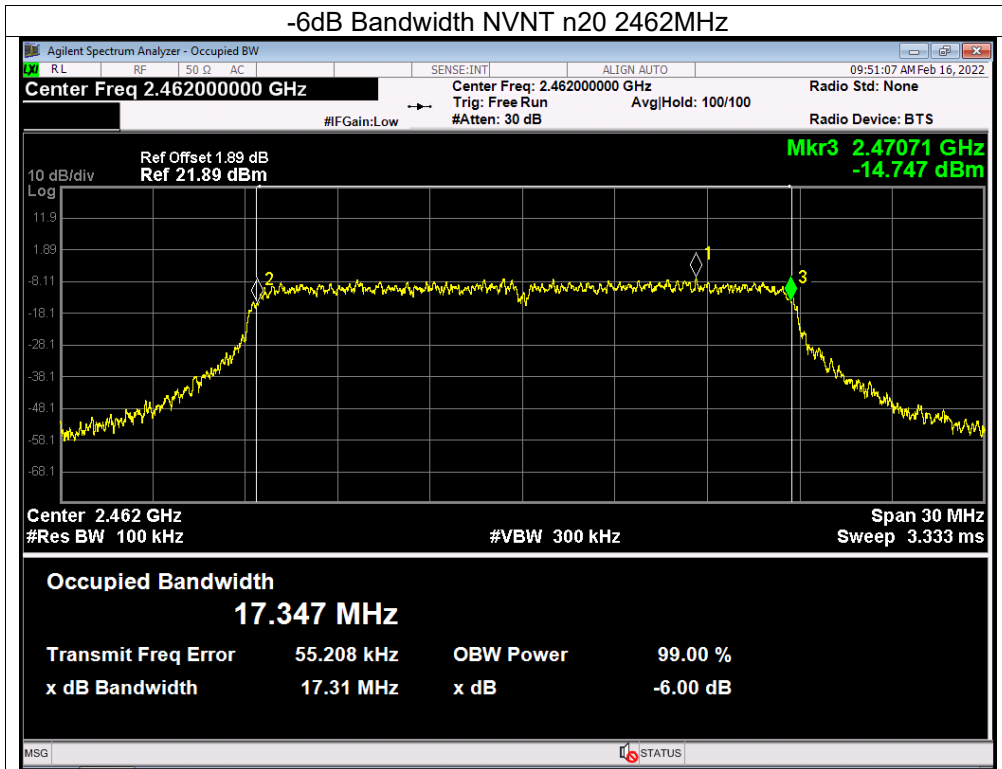

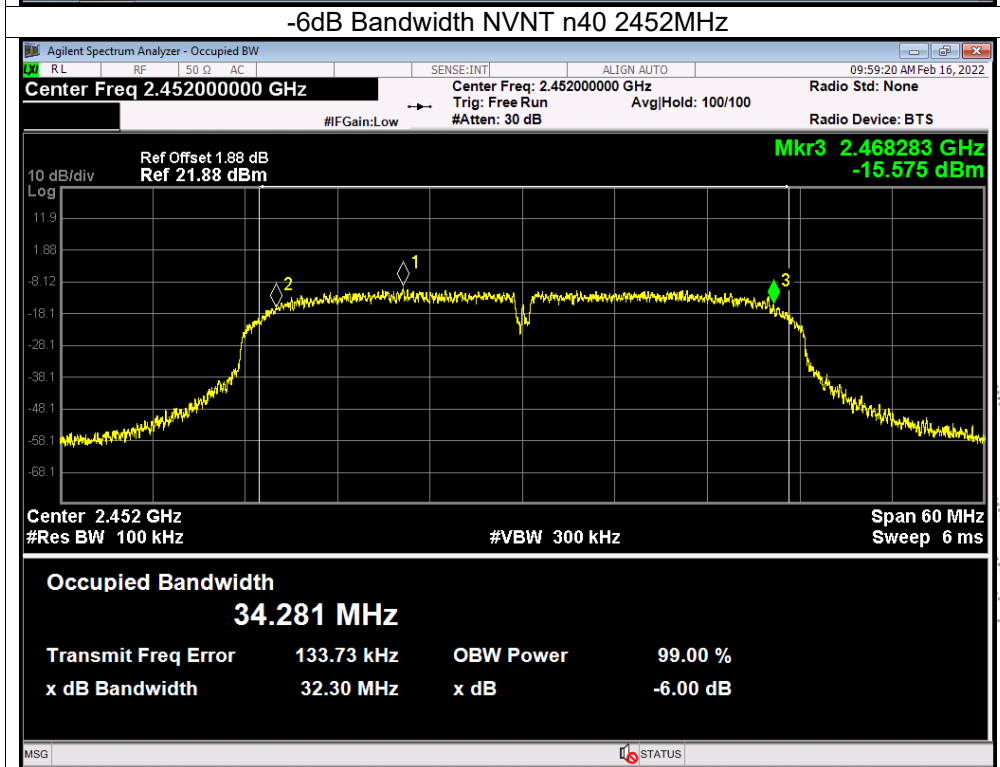
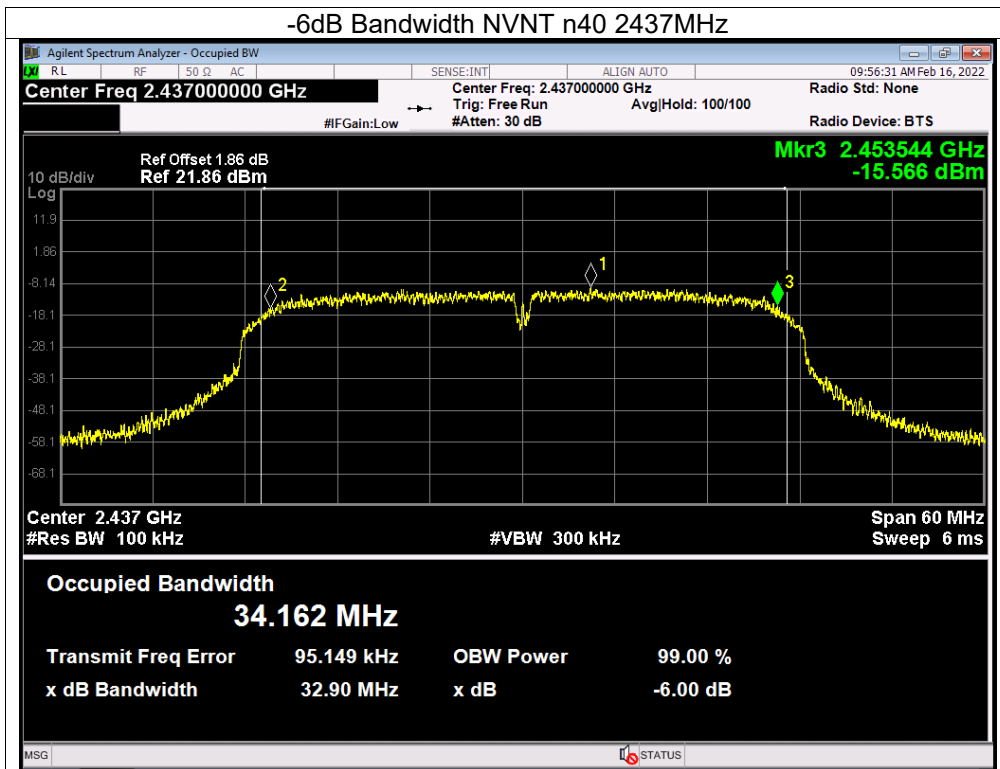

11. Peak Output Power Test

11.1 Block Diagram Of Test Setup



11.2 Limit

FCC Part15 (15.247) , Subpart C				
Section	Test Item	Limit	Frequency Range (MHz)	Result
15.247(b)(3)	Peak Output Power	1 watt or 30dBm	2400-2483.5	PASS

11.3 Test Procedure

- a. The EUT was directly connected to the Power meter

11.4 EUT Operating Conditions

The EUT tested system was configured as the statements of 4.6 Unless otherwise a special operating condition is specified in the follows during the testing.

Note: Power Spectral Density(dBm)=Reading+Cable Loss

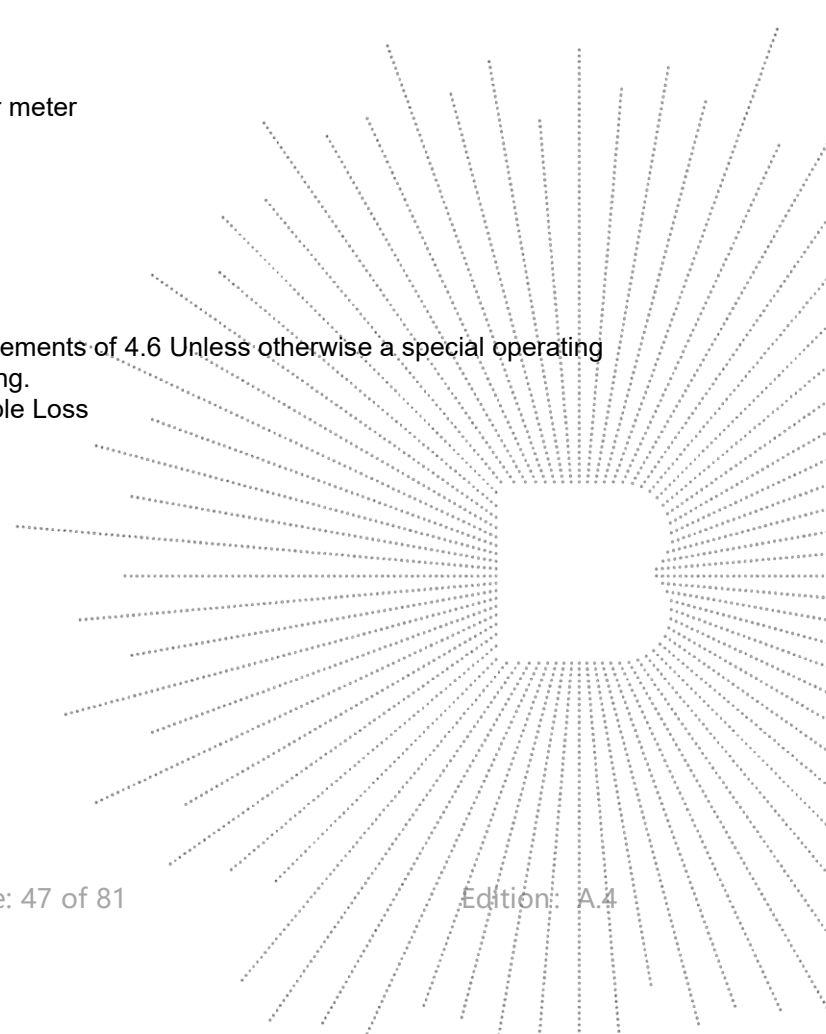

11.5 Test Result

Temperature :	26°C	Relative Humidity :	54%
Pressure :	101kPa	Test Voltage :	AC120V/60Hz

Condition	Mode	Frequency (MHz)	Conducted Power (dBm)	Limit (dBm)	Verdict
NVNT	b	2412	14.39	30	Pass
NVNT	b	2437	13.33	30	Pass
NVNT	b	2462	12.11	30	Pass
NVNT	g	2412	12.8	30	Pass
NVNT	g	2437	11.95	30	Pass
NVNT	g	2462	10.86	30	Pass
NVNT	n20	2412	12.55	30	Pass
NVNT	n20	2437	11.69	30	Pass
NVNT	n20	2462	10.66	30	Pass
NVNT	n40	2422	11.5	30	Pass
NVNT	n40	2437	10.93	30	Pass
NVNT	n40	2452	10.41	30	Pass

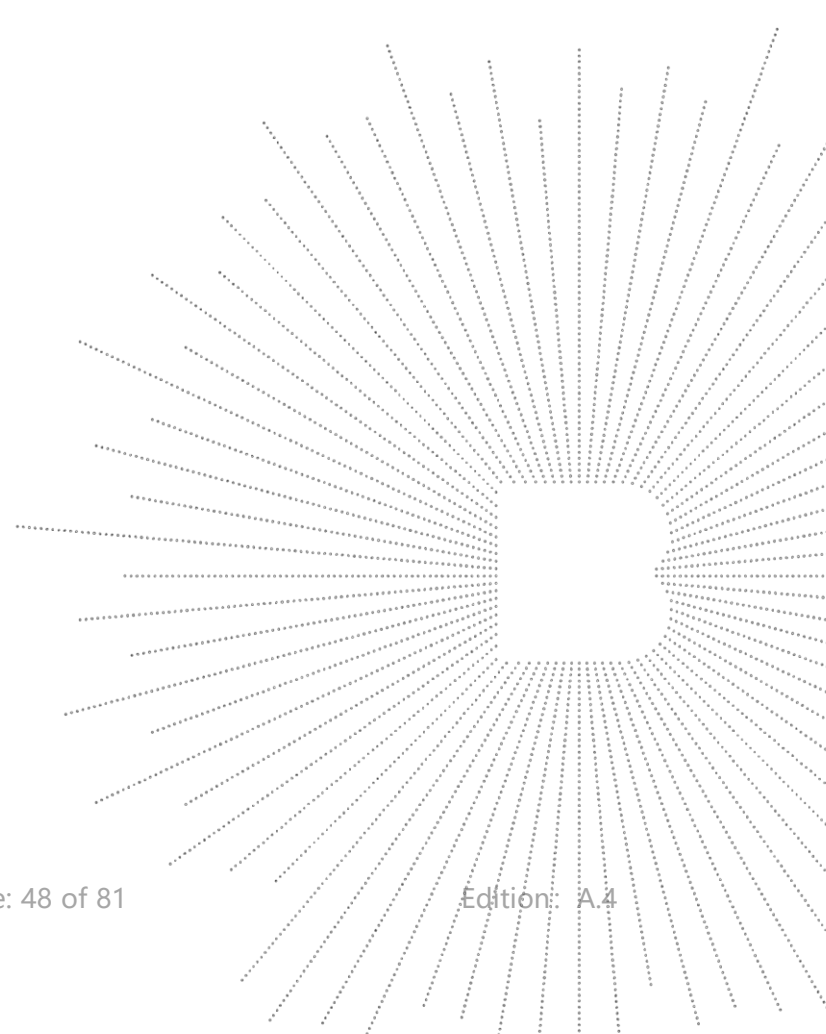

12. 100 KHz Bandwidth Of Frequency Band Edge

12.1 Block Diagram Of Test Setup

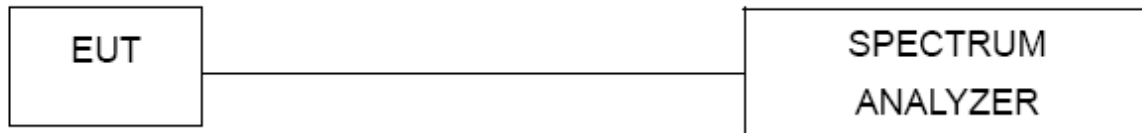

12.2 Limit

In any 100 kHz bandwidth outside the frequency band in which the spread spectrum intentional radiator is operating, the radio frequency power that is produced by the intentional radiator shall be at least 20 dB below that in the 100 kHz bandwidth within the band that contains the highest level of the desired power, based on either an RF conducted or a radiated measurement.

12.3 Test Procedure

Using the following spectrum analyzer setting:

- Set the RBW = 100KHz.
- Set the VBW = 300KHz.
- Sweep time = auto couple.
- Detector function = peak.
- Trace mode = max hold.
- Allow trace to fully stabilize..

12.4 EUT Operating Conditions

The EUT tested system was configured as the statements of 4.6 Unless otherwise a special operating condition is specified in the follows during the testing.

Note: Power Spectral Density(dBm)=Reading+Cable Loss

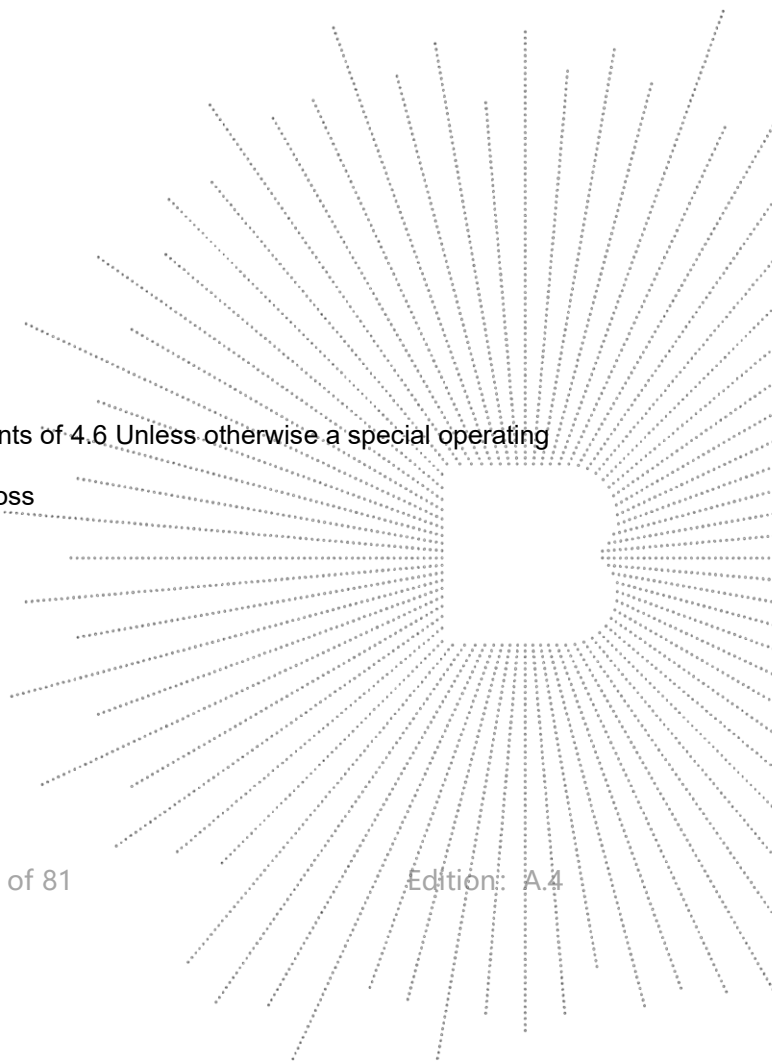

12.5 Test Result

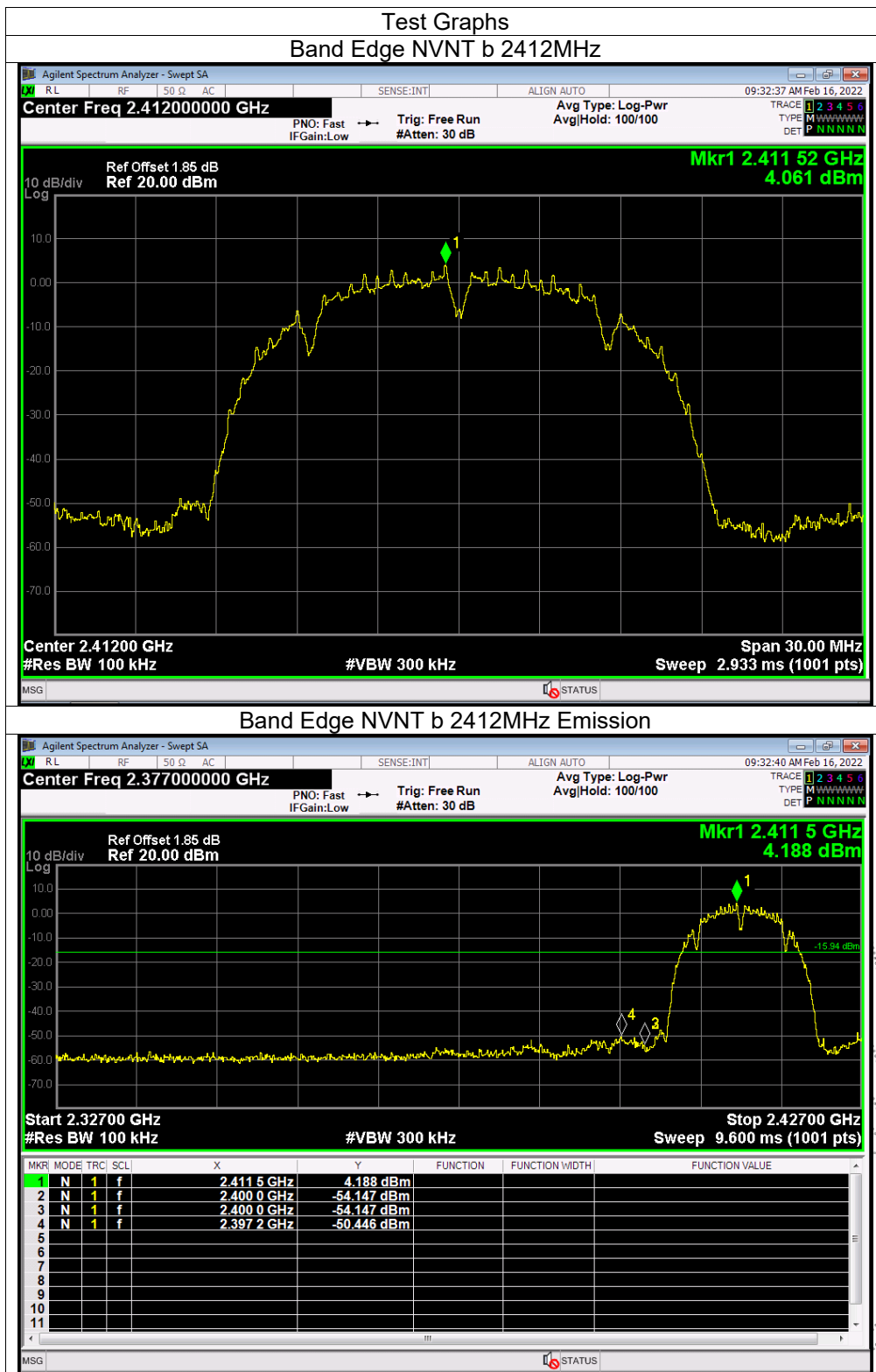

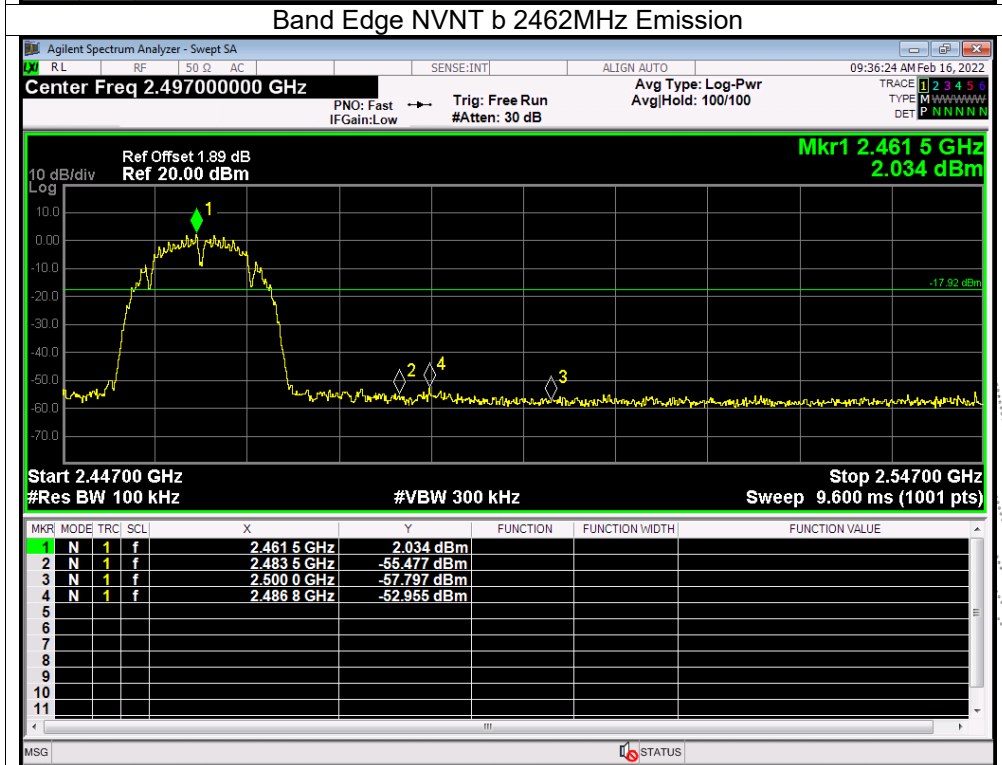
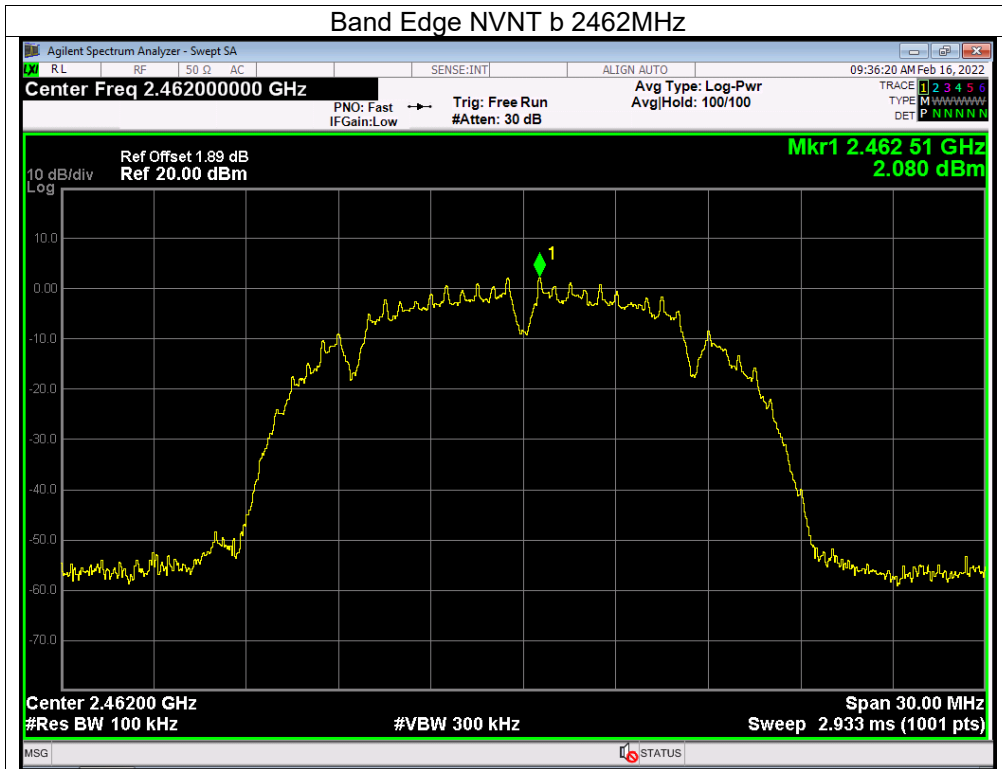

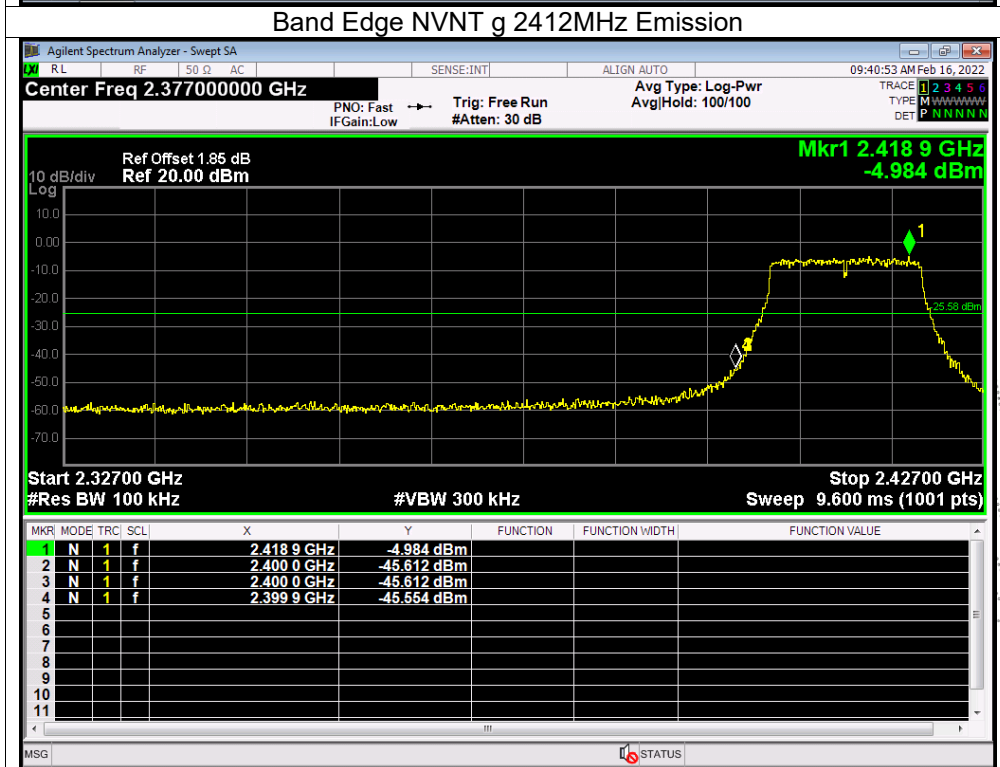
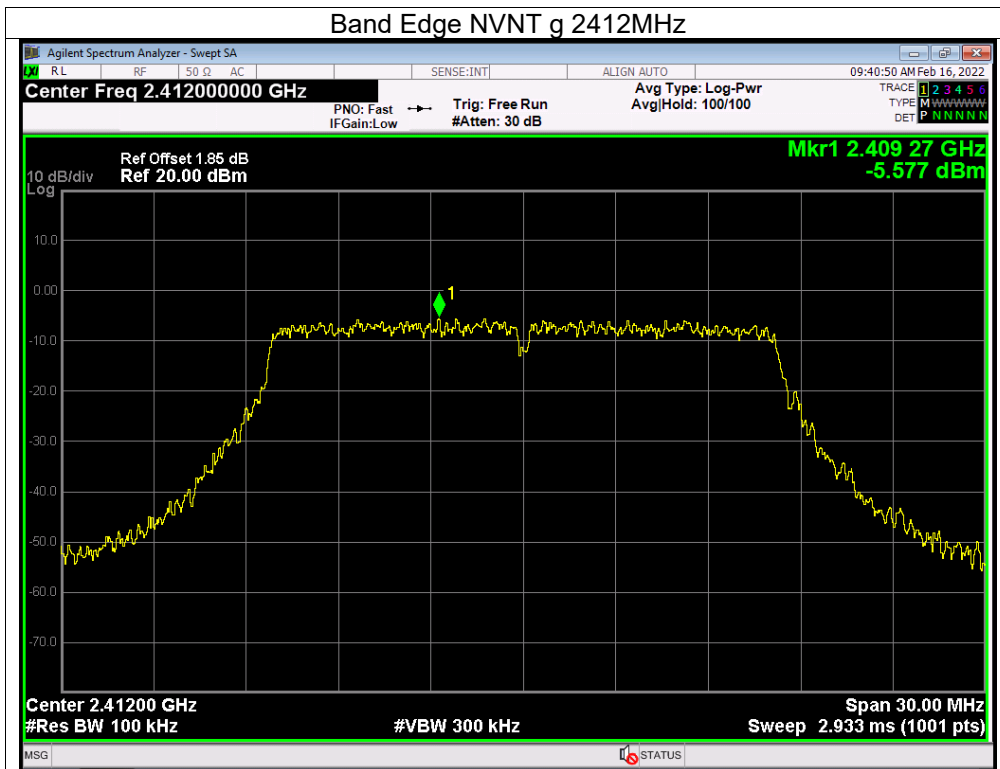

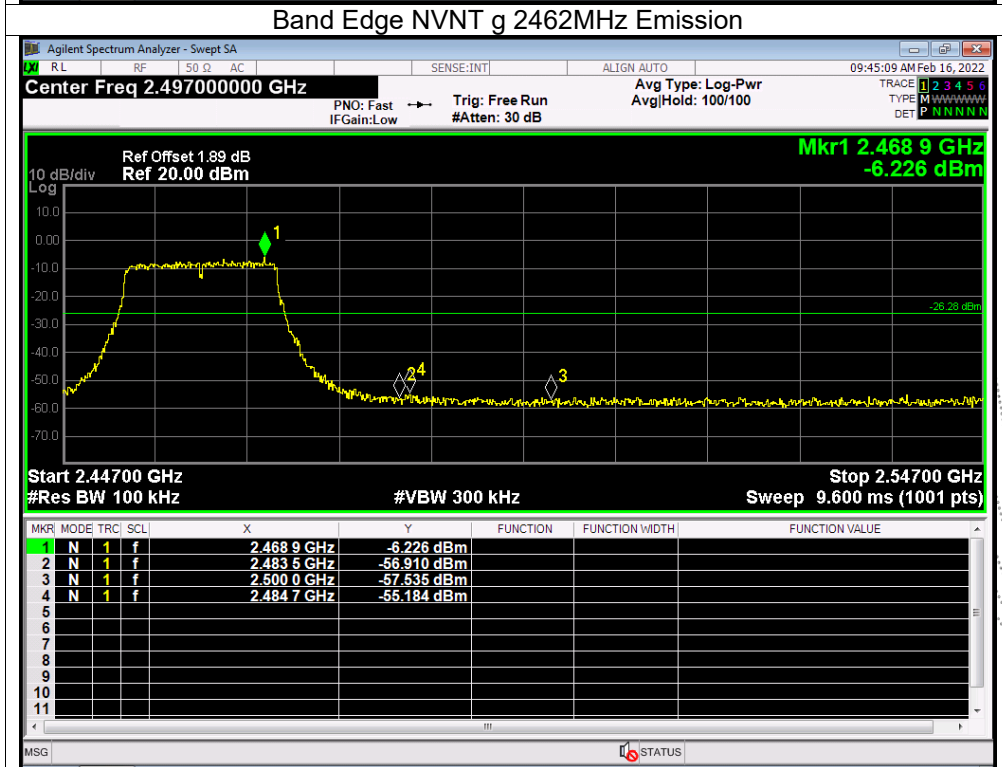
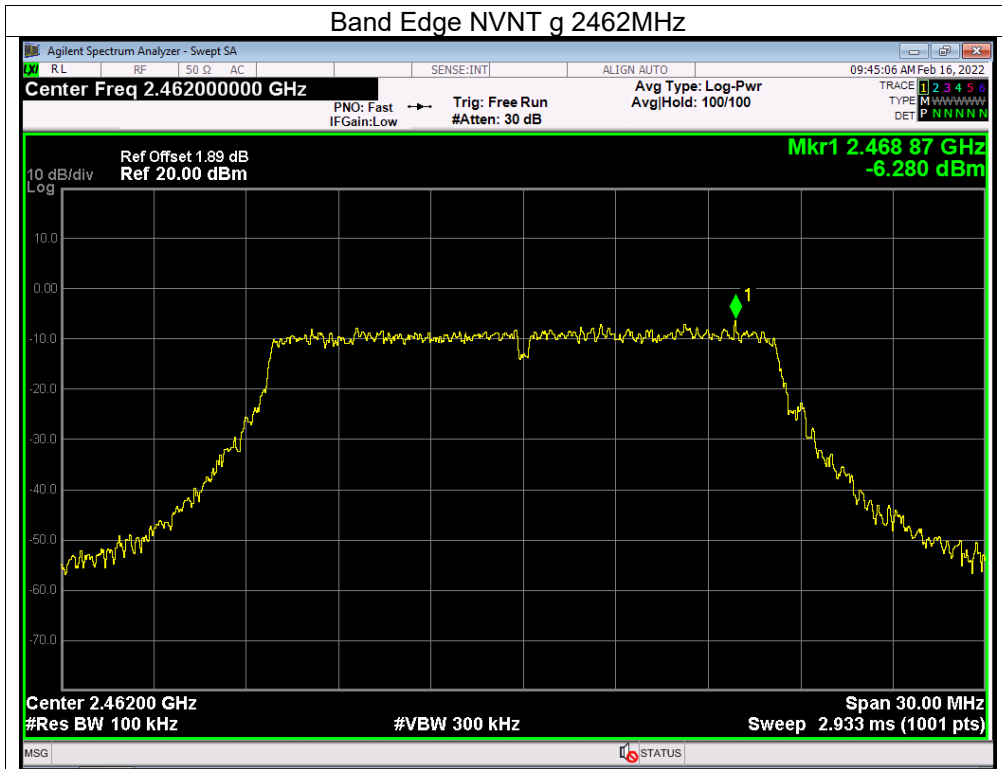

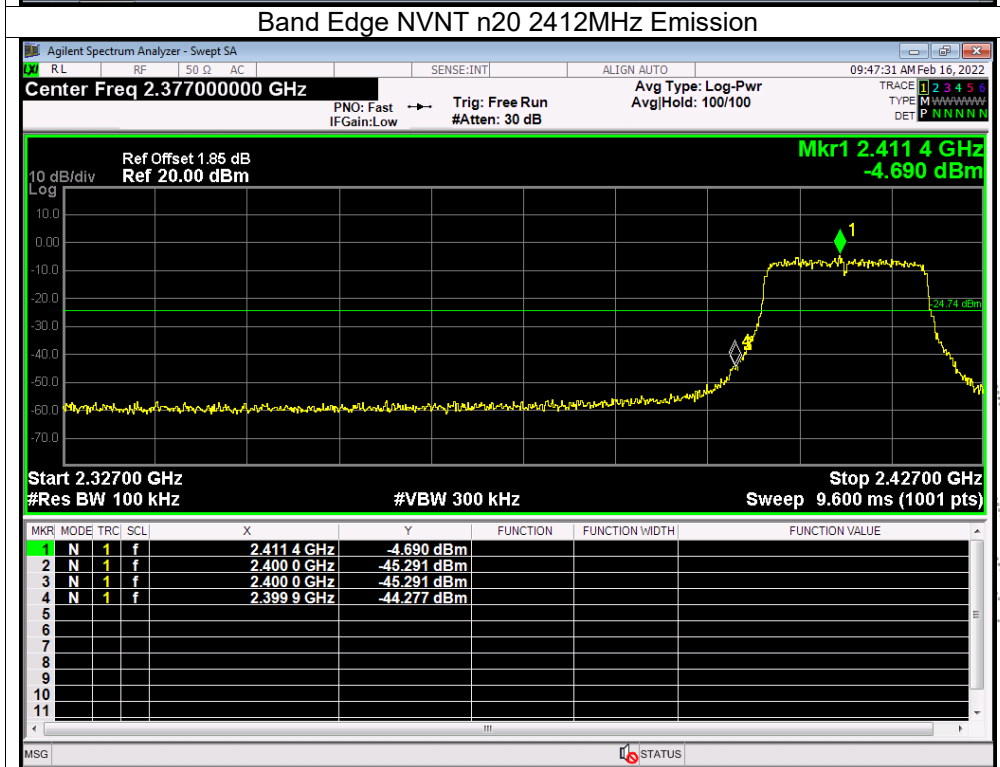
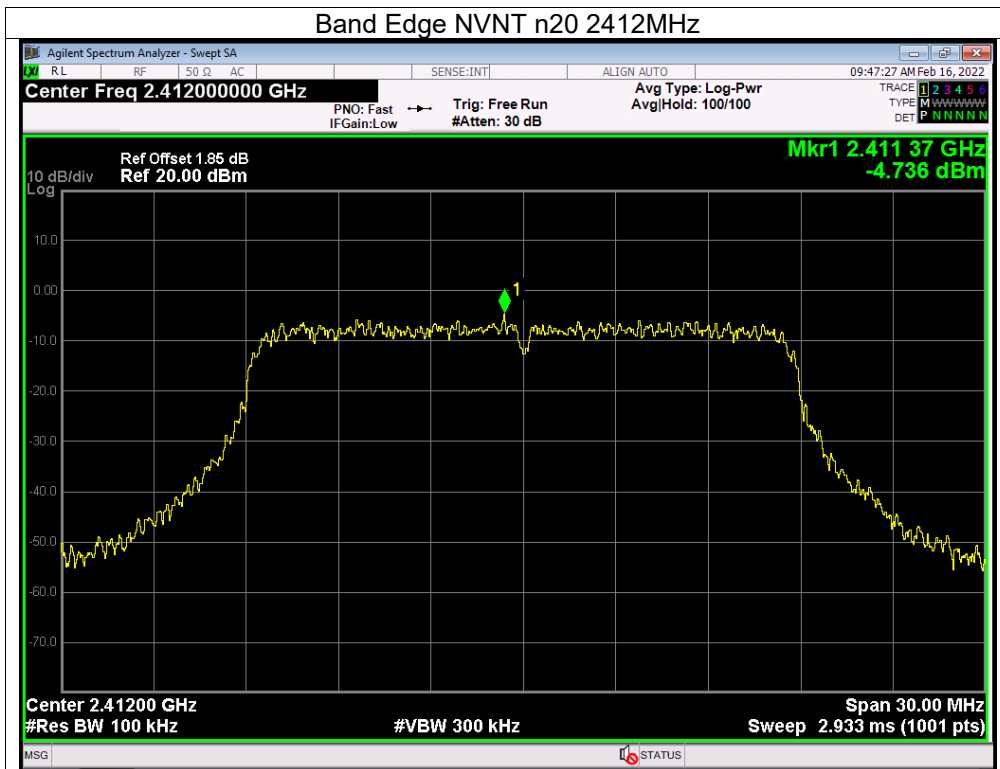

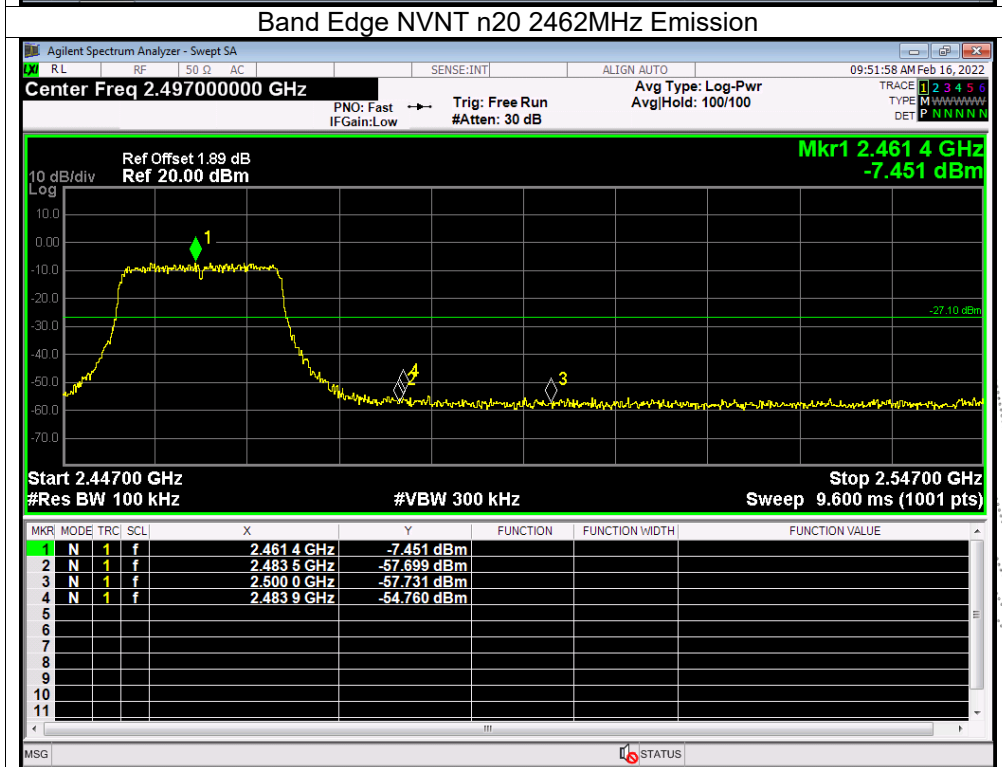
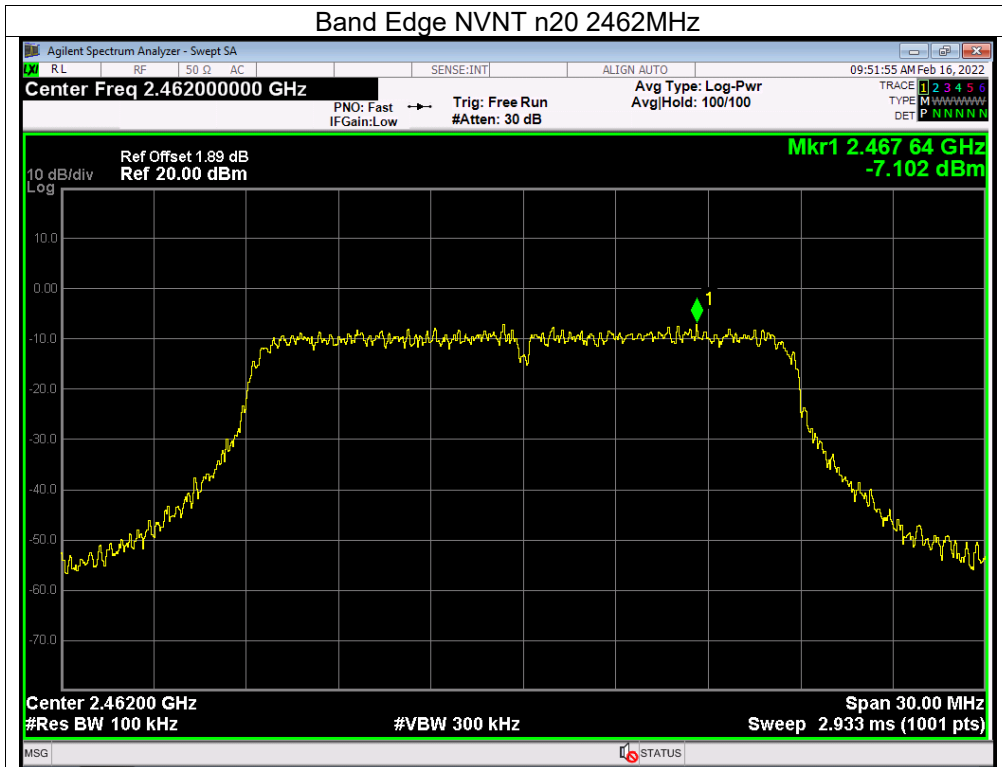

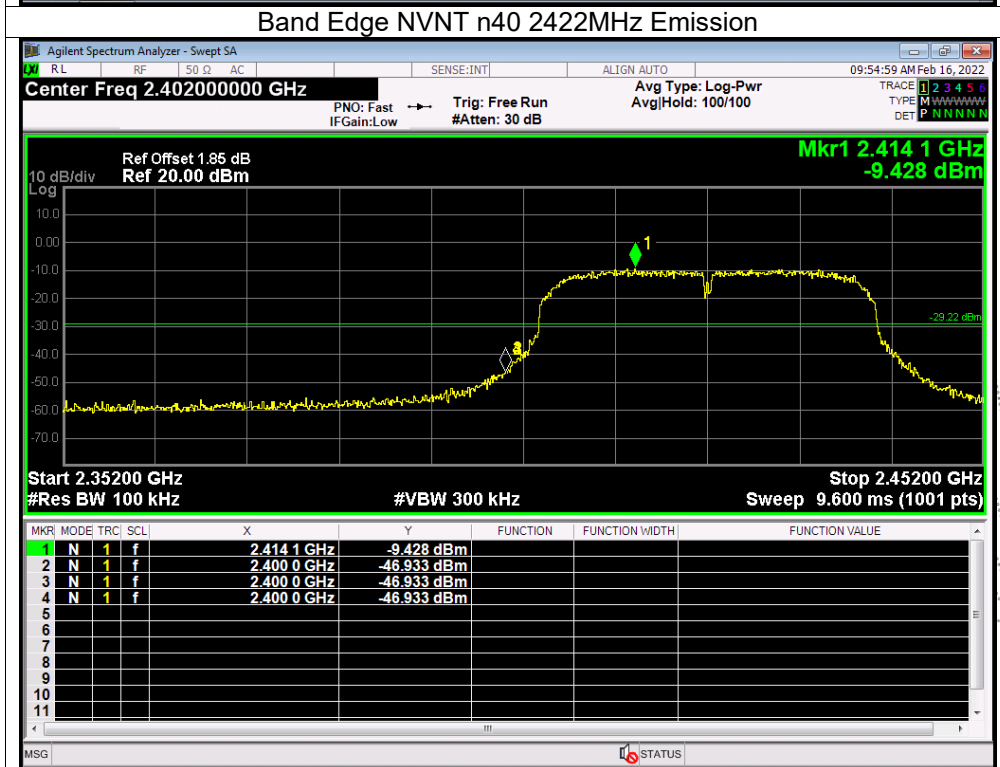
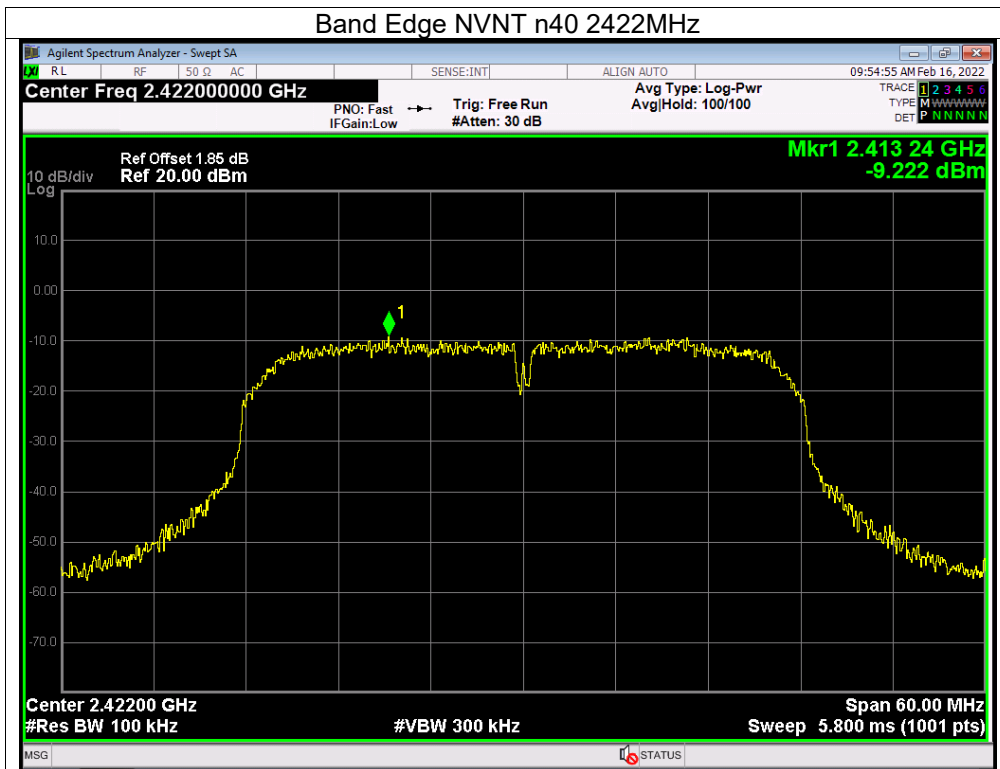

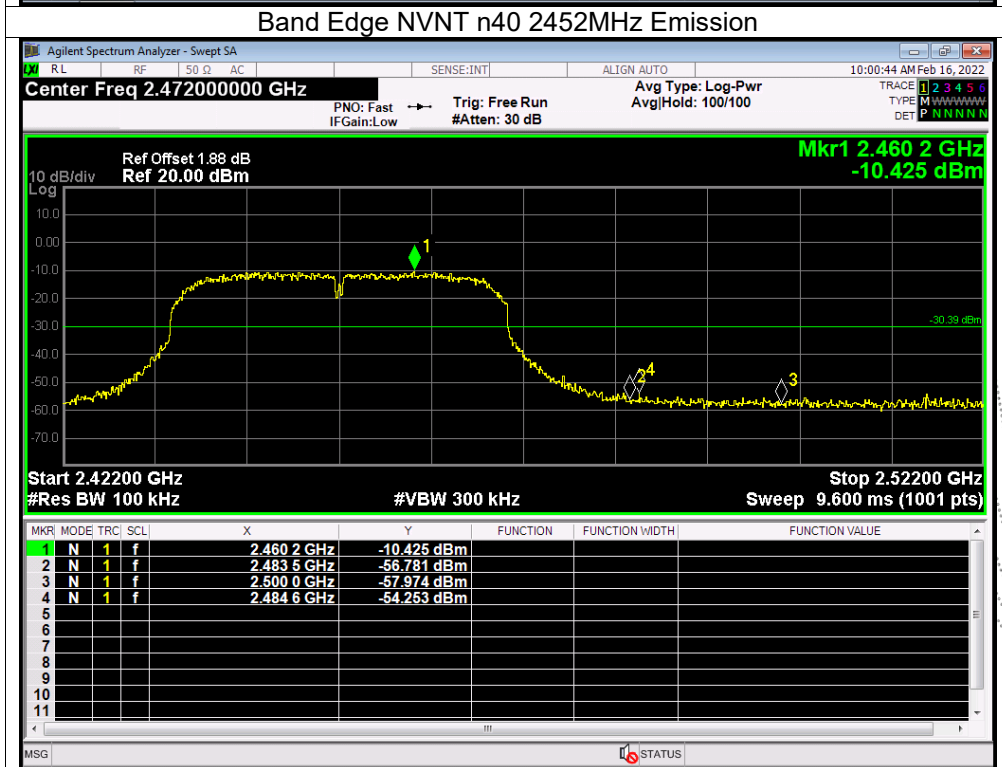
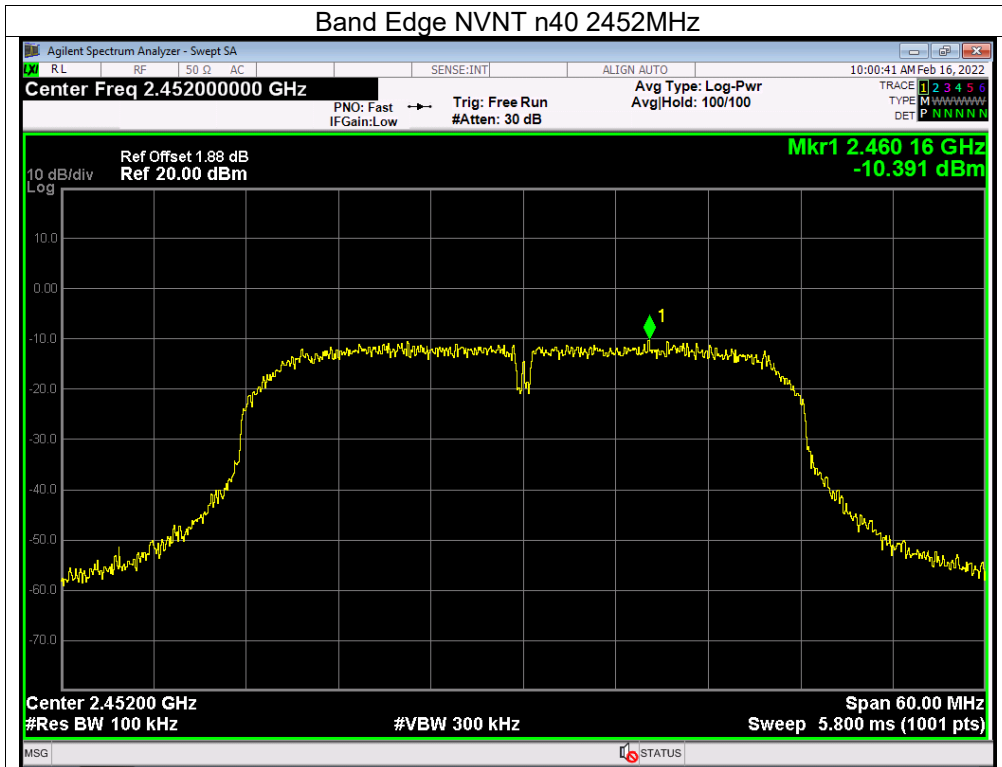

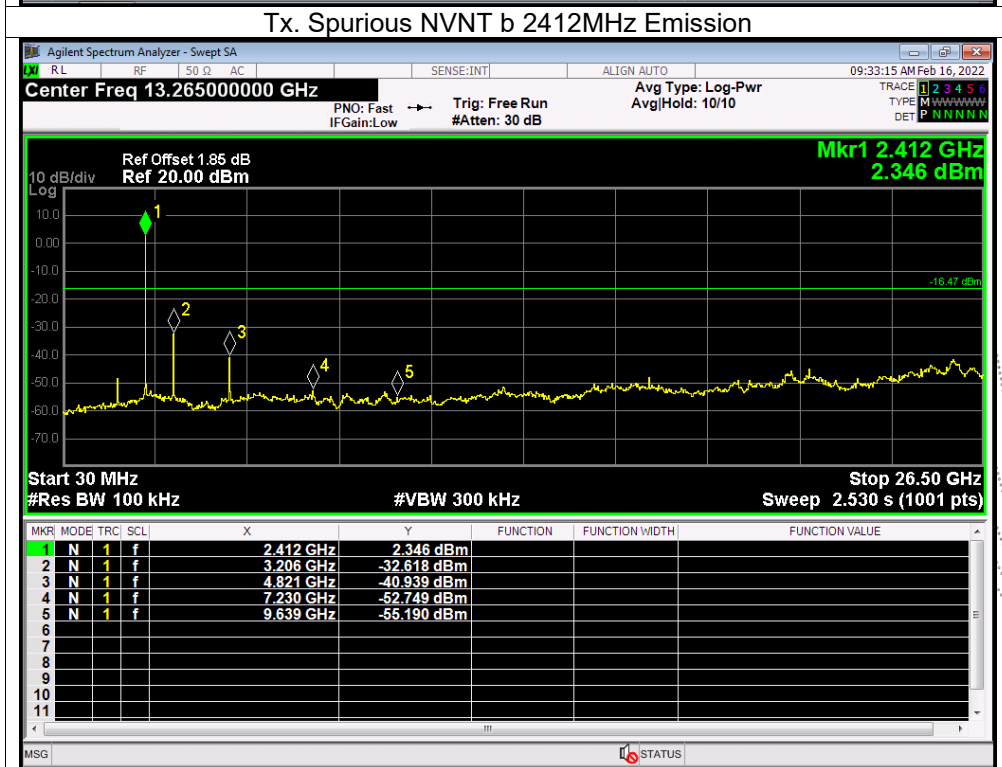
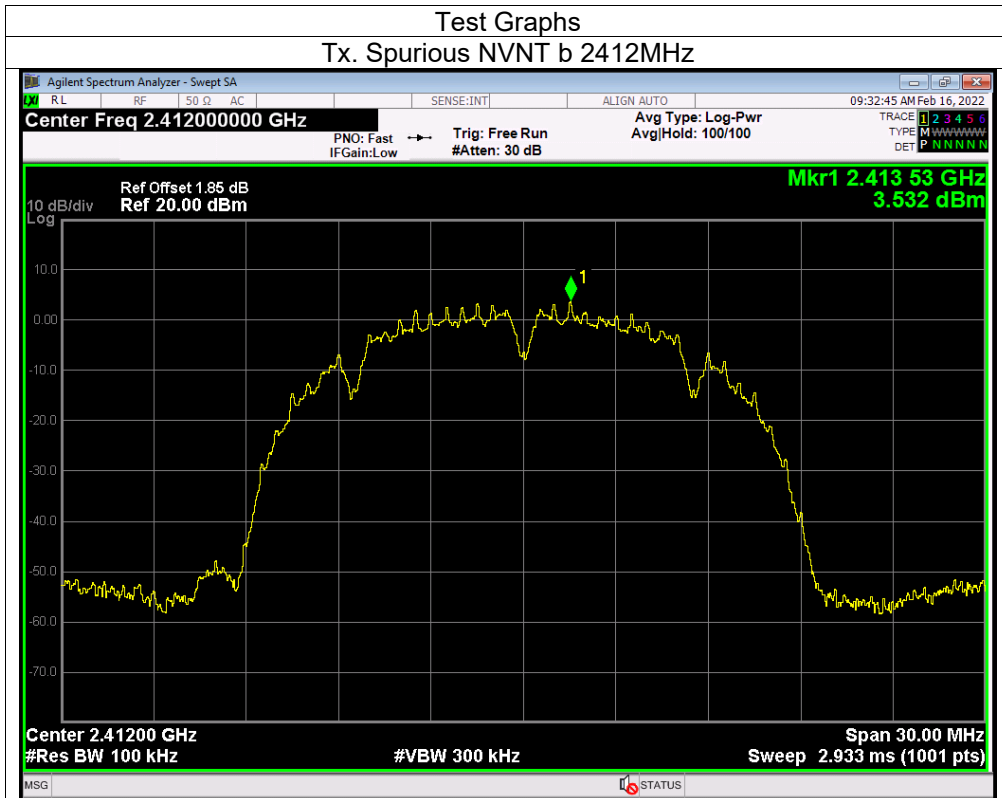

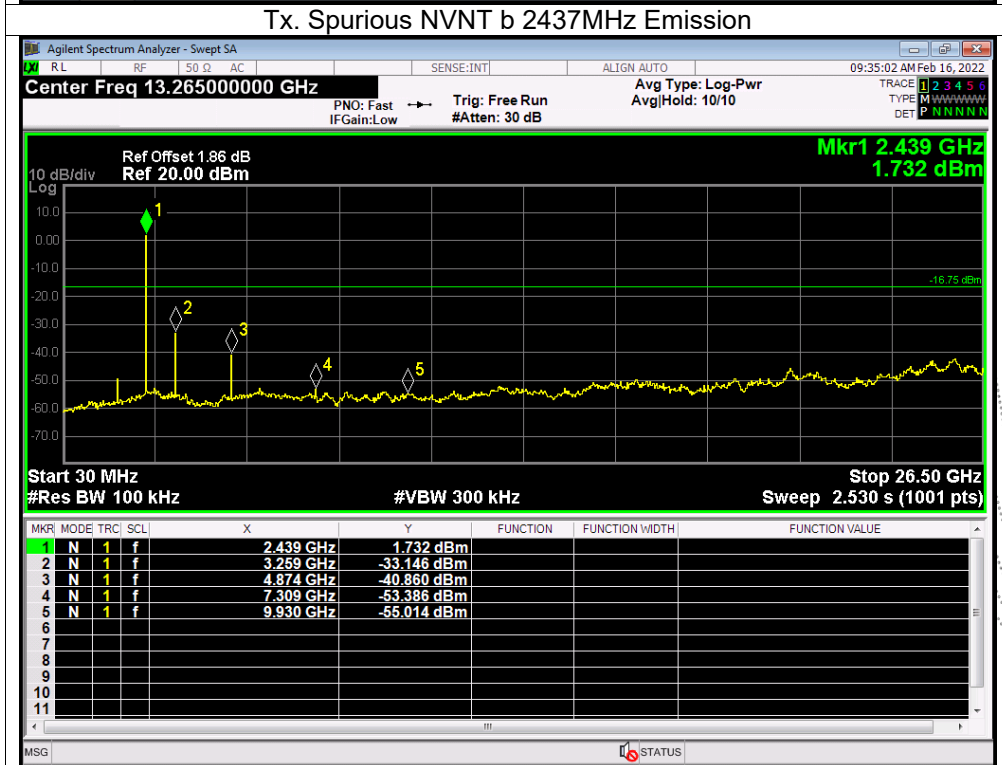
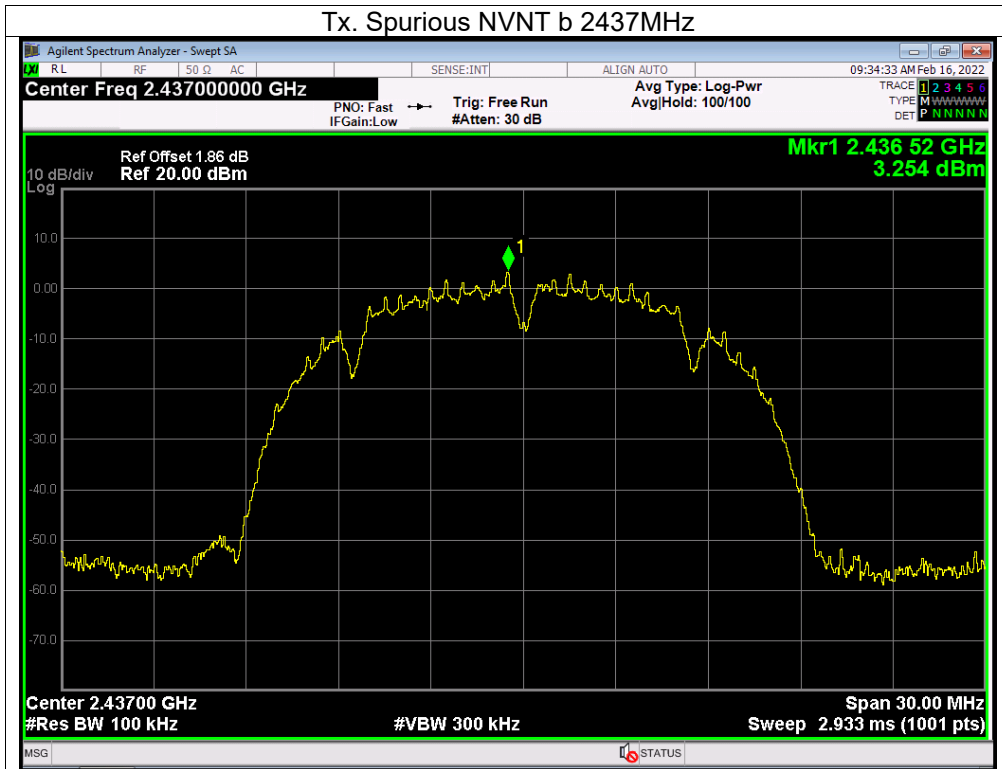

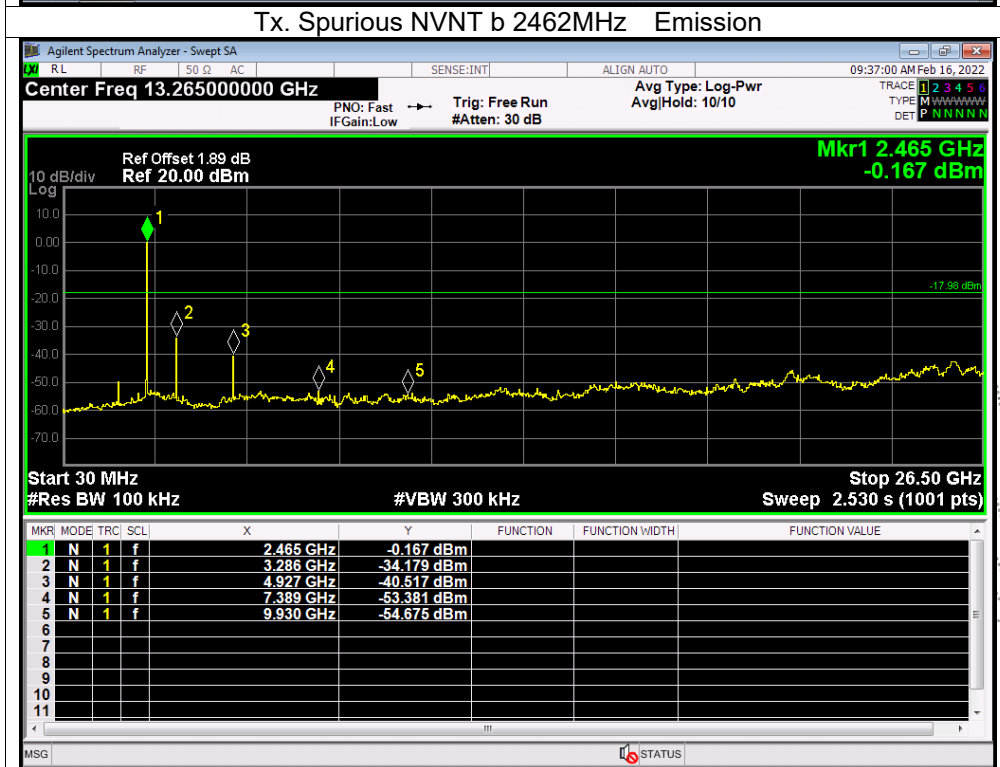
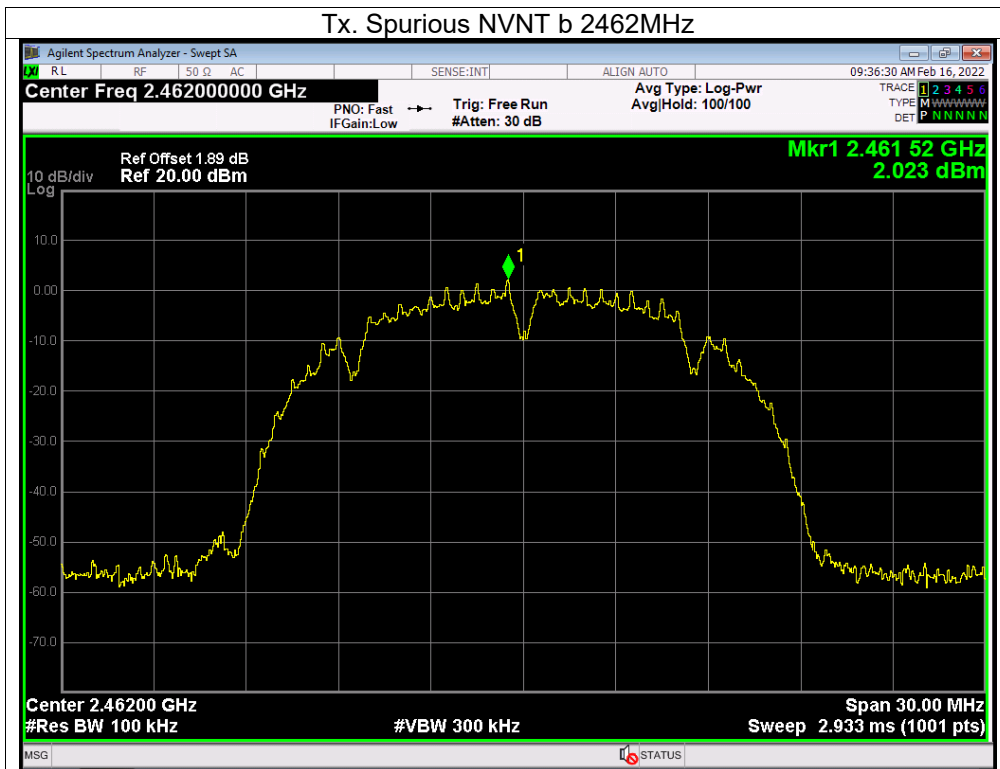

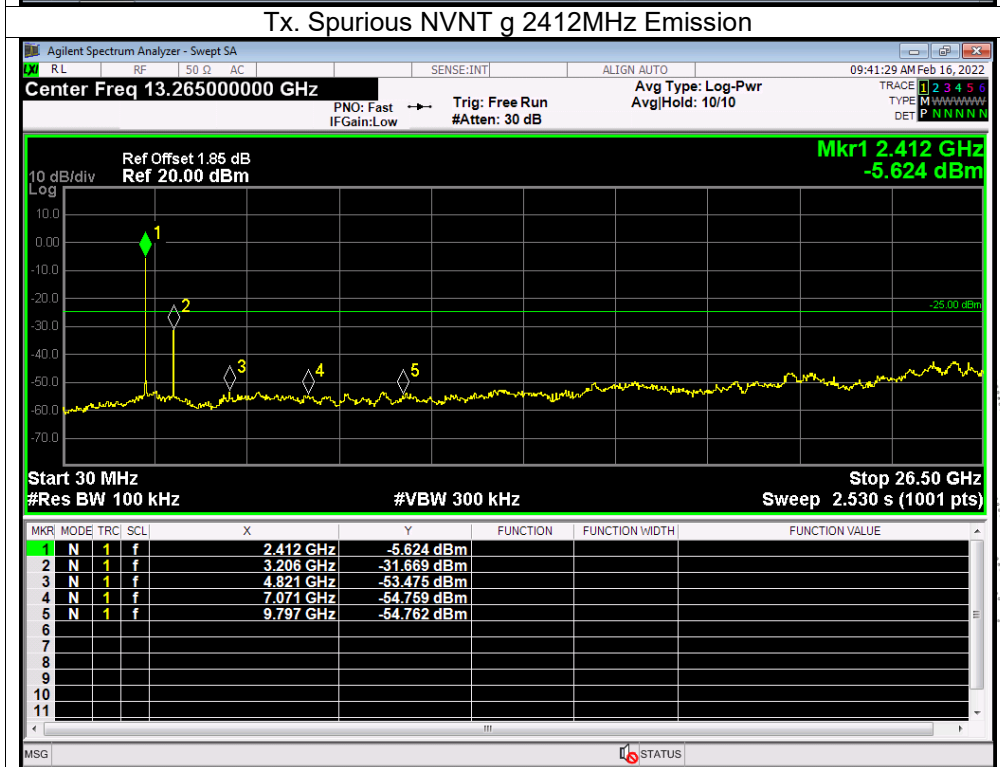
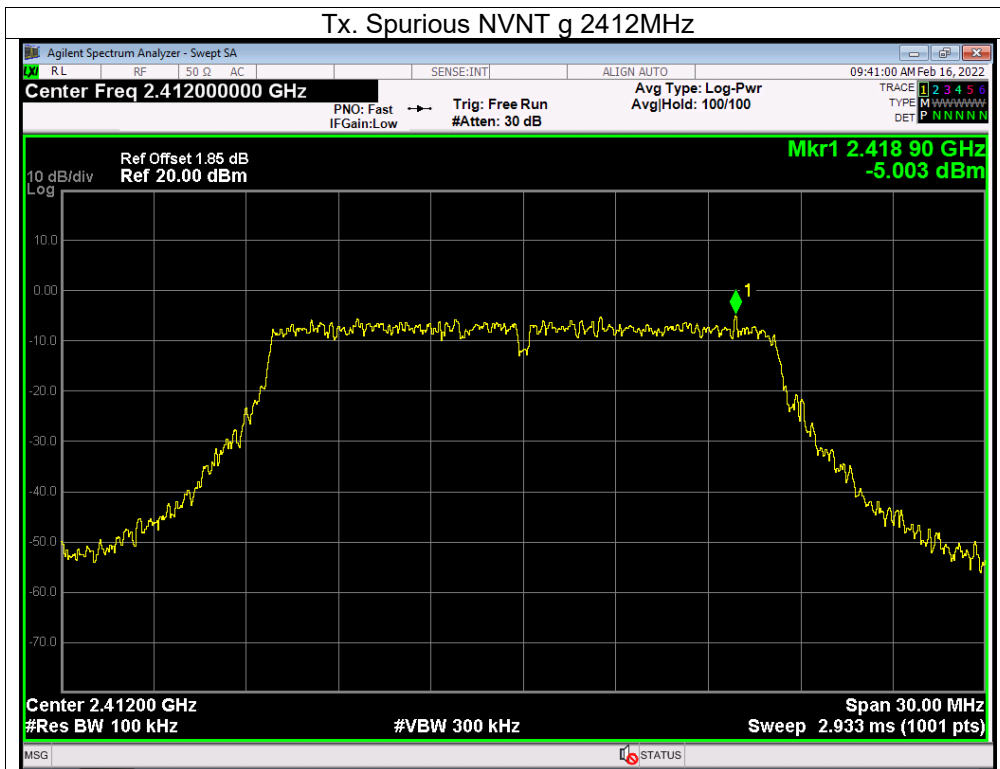

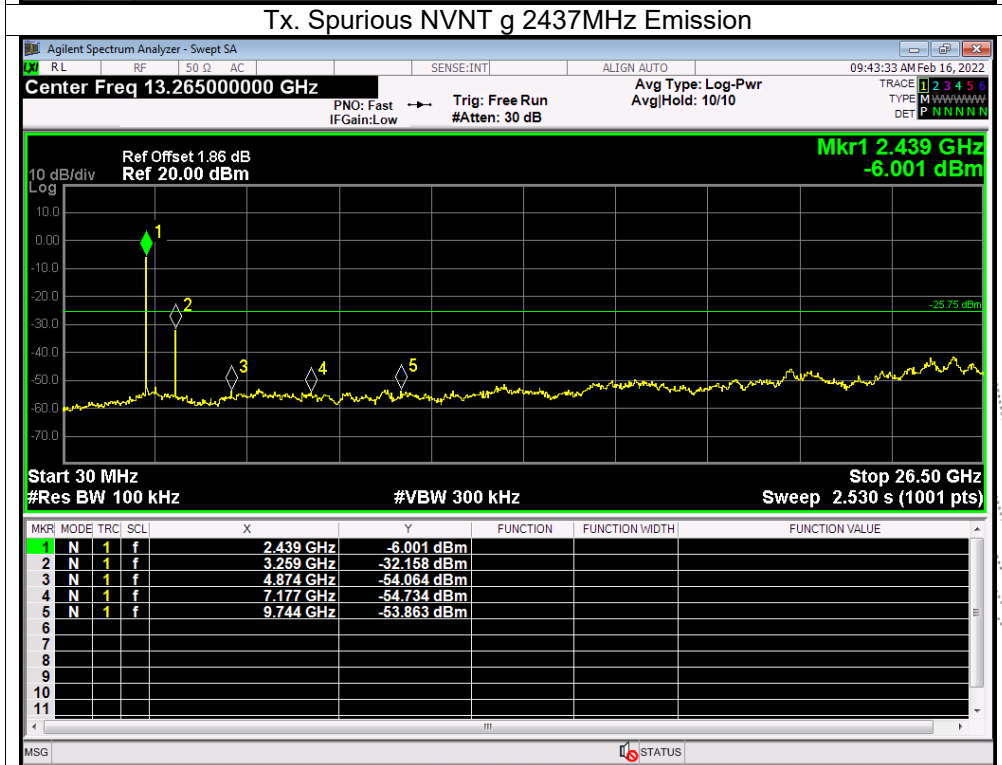
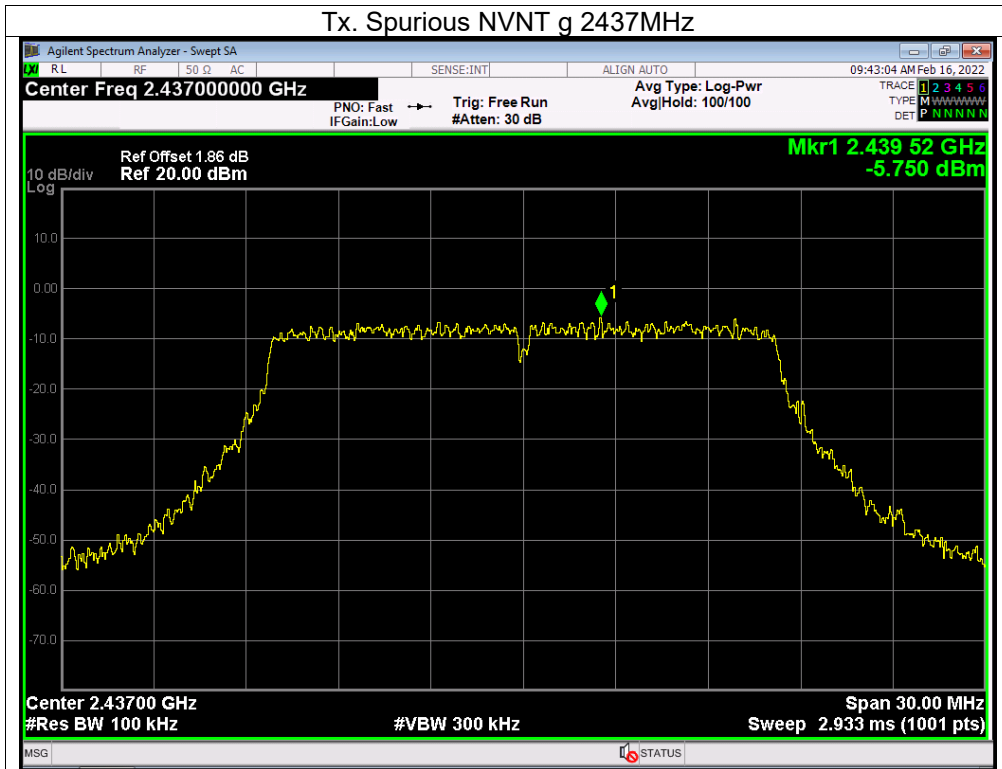

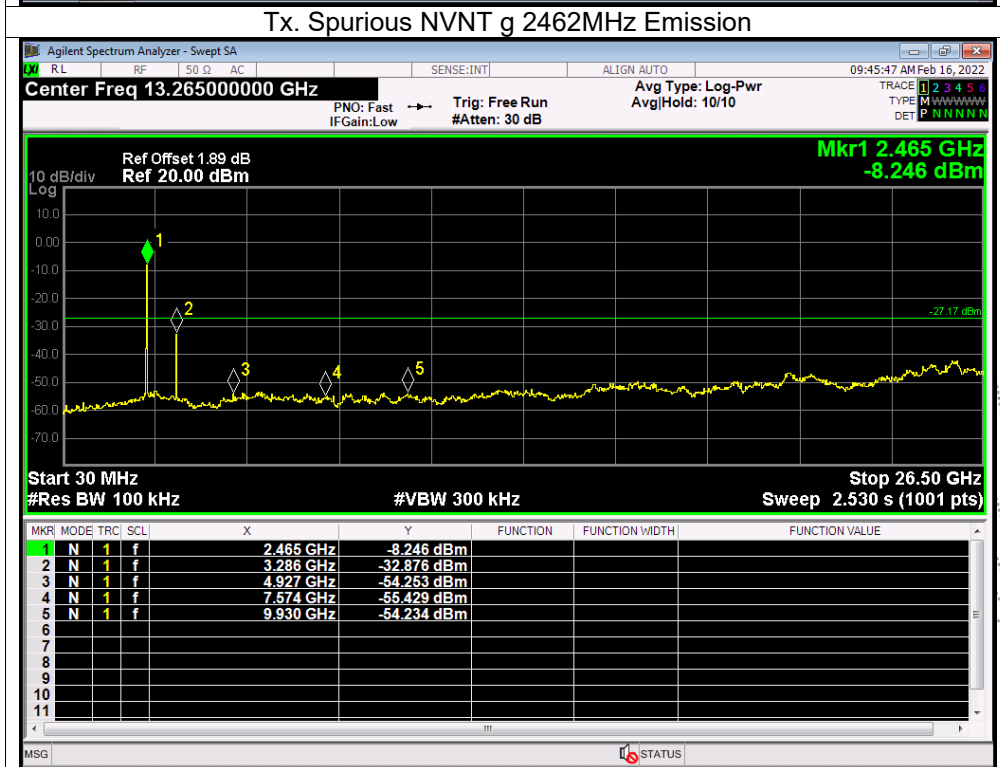
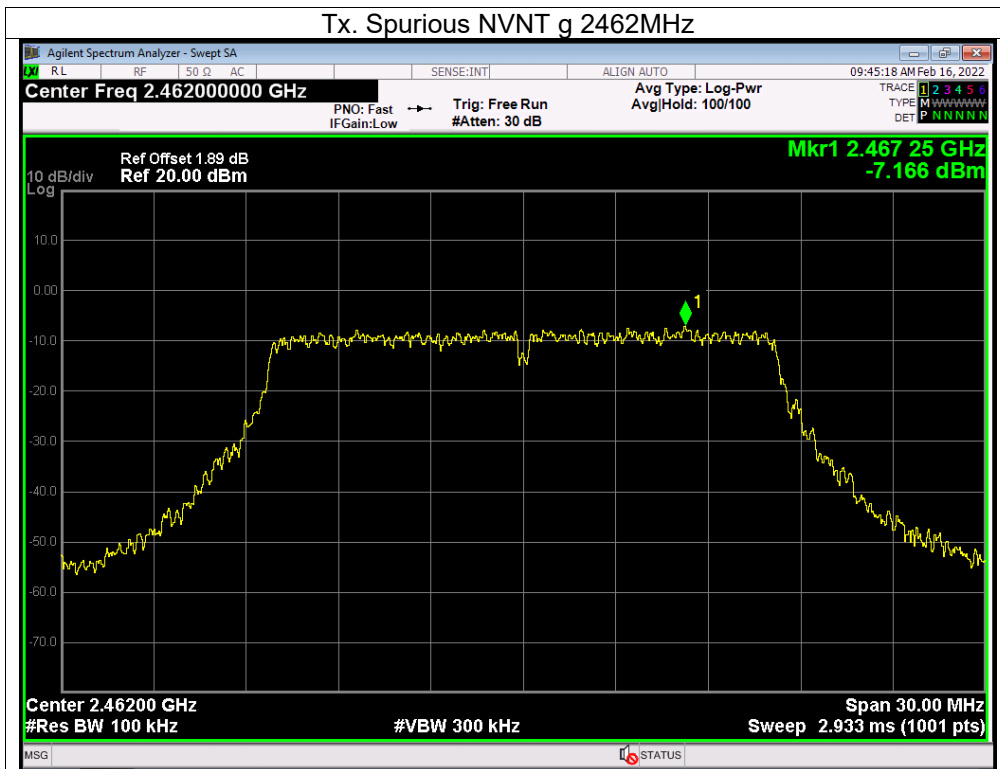

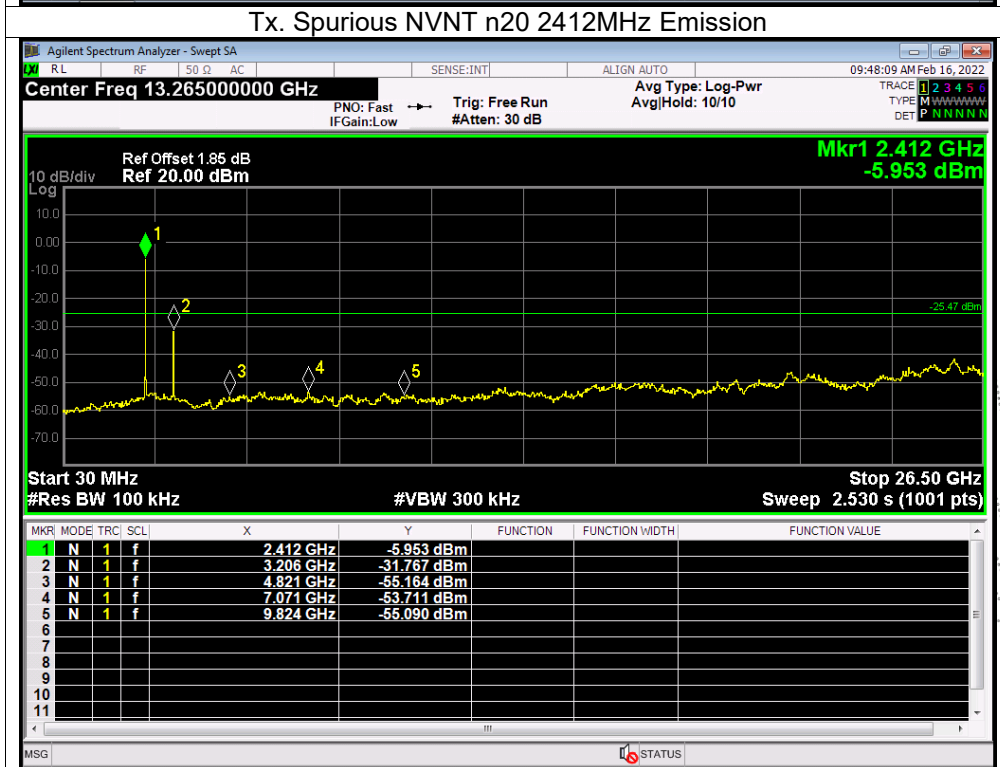
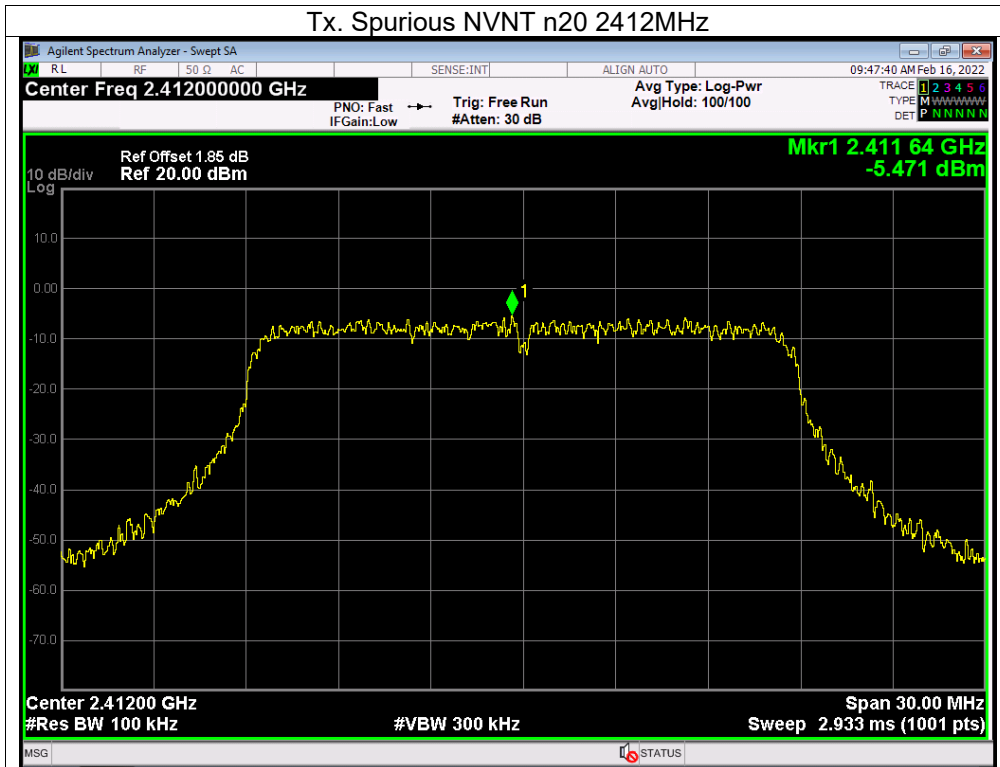

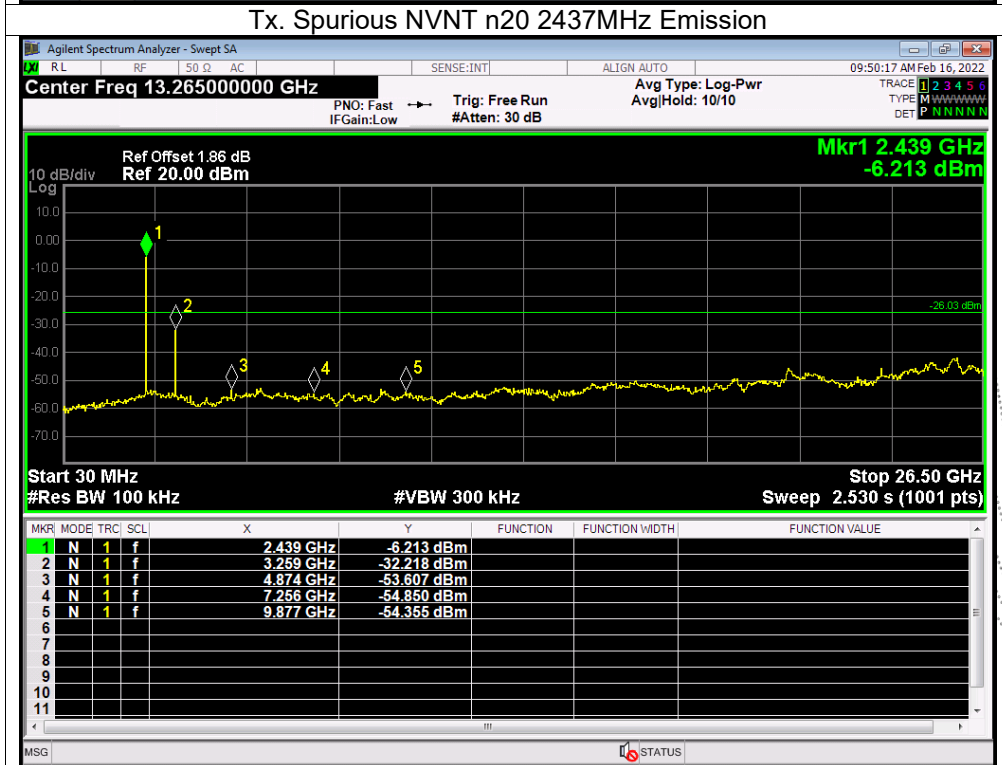
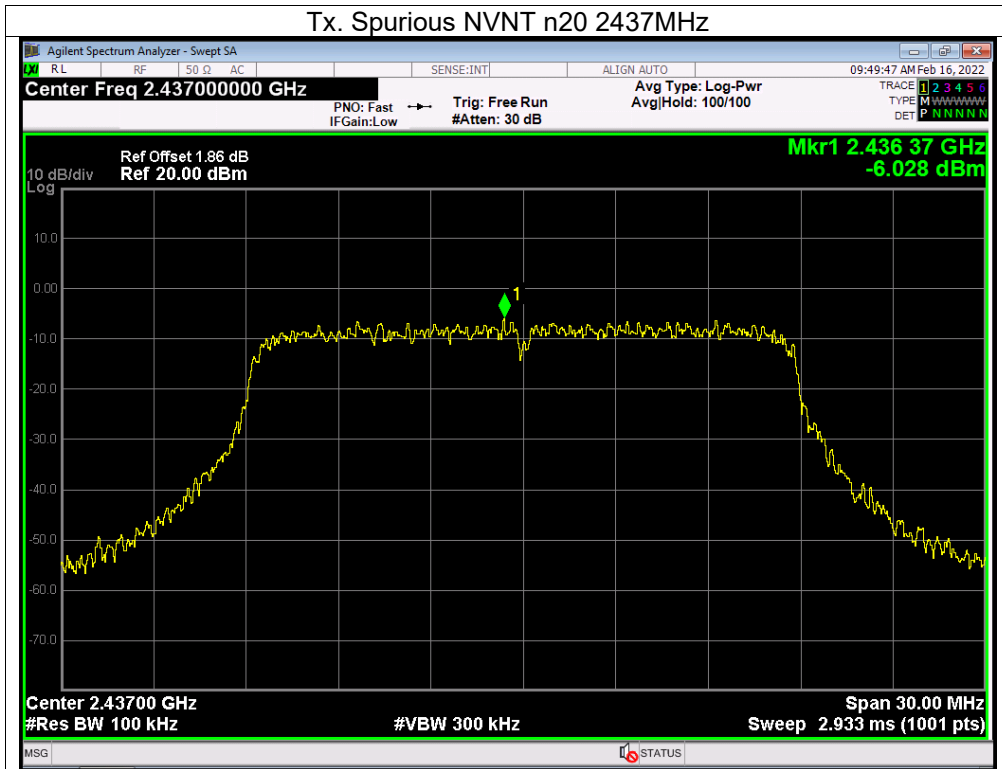

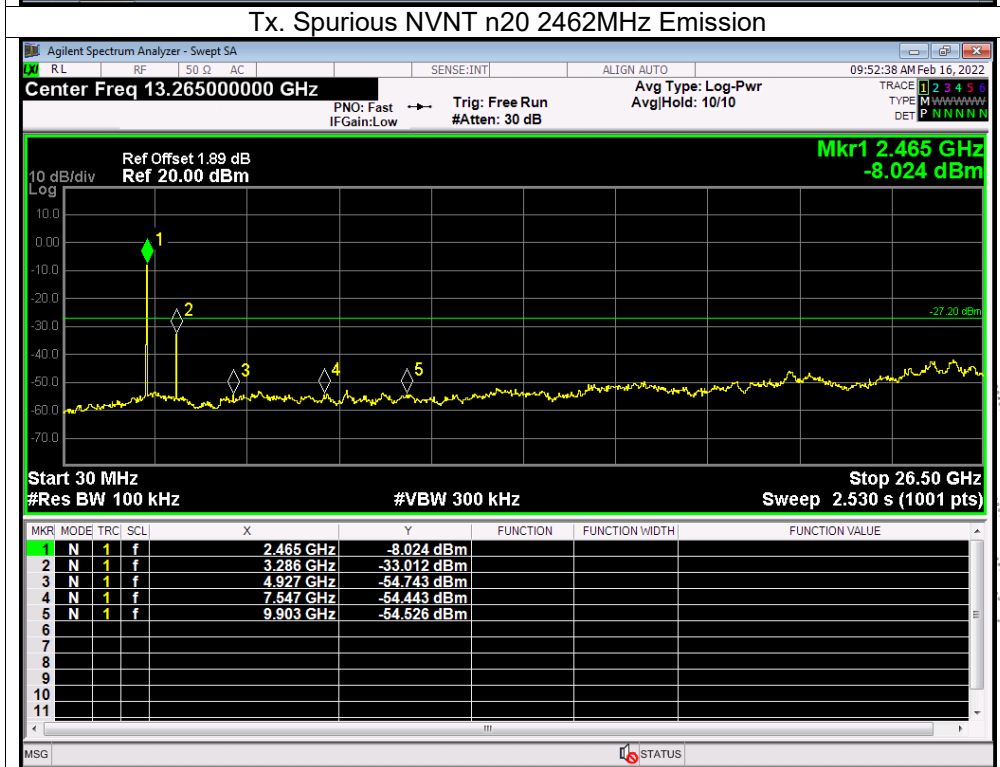
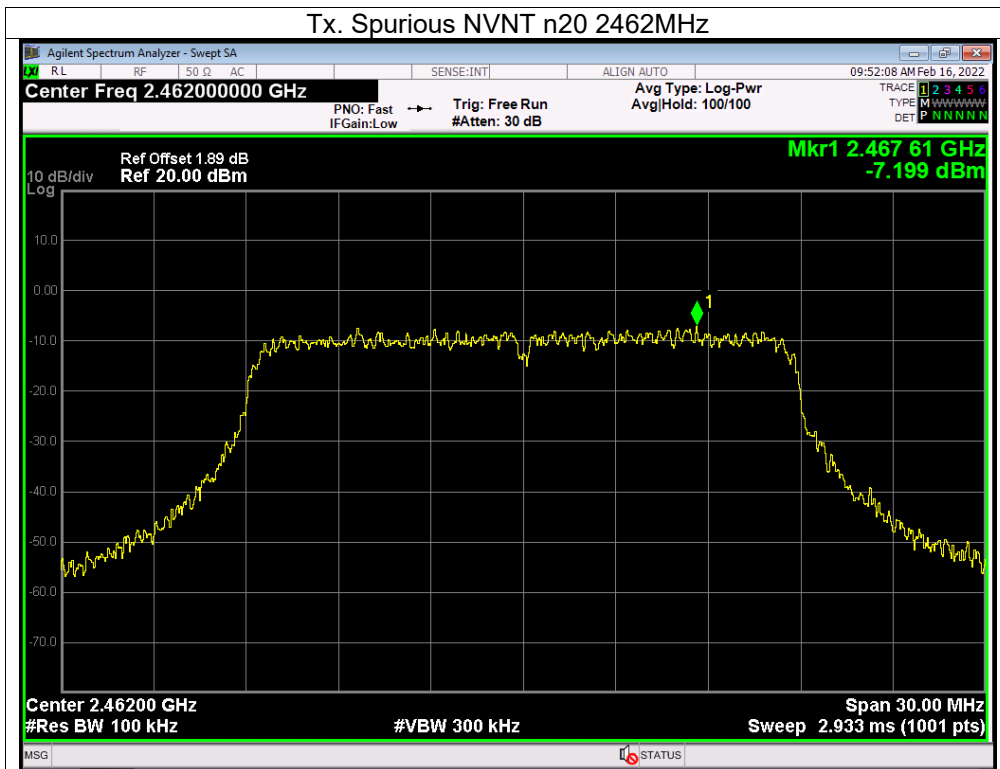

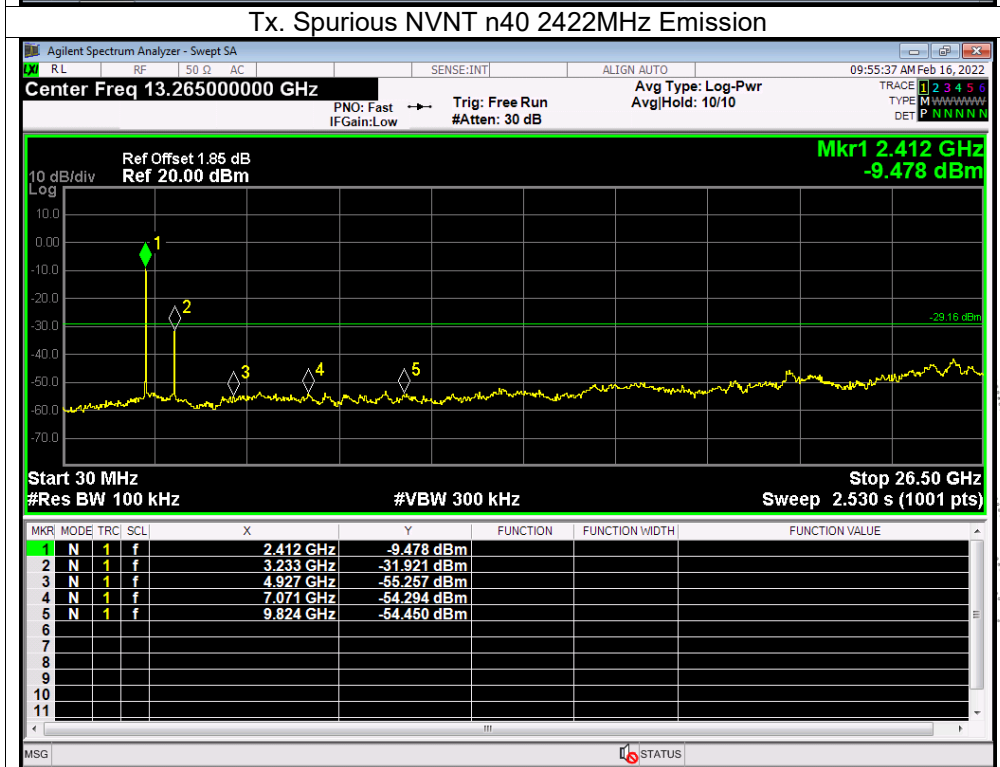
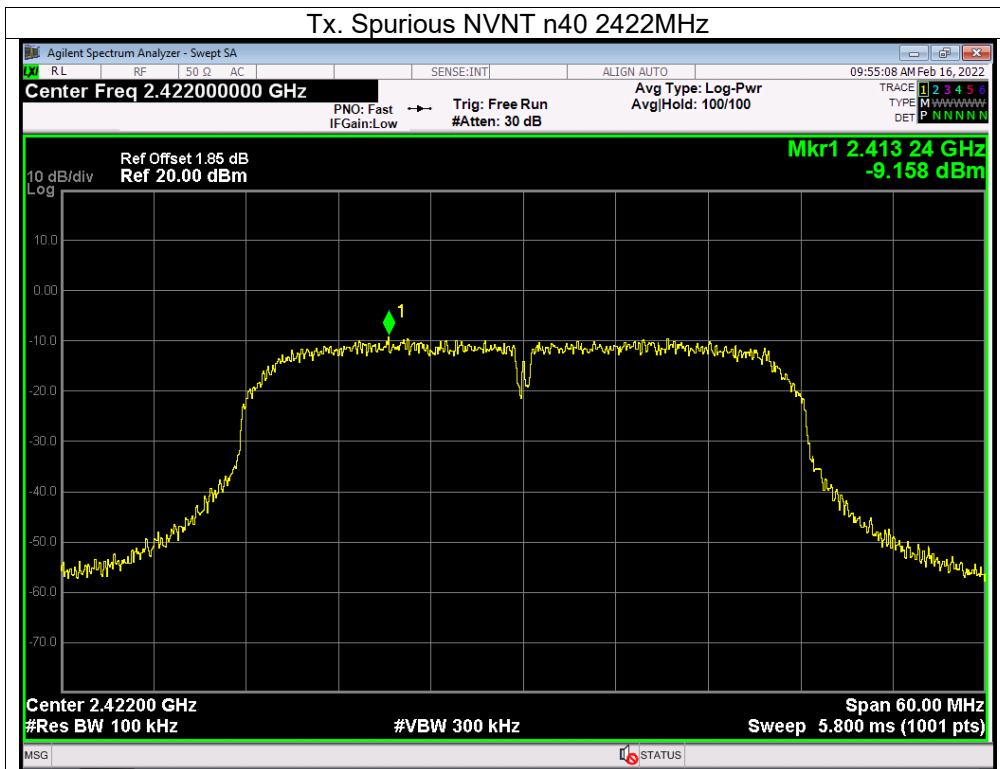

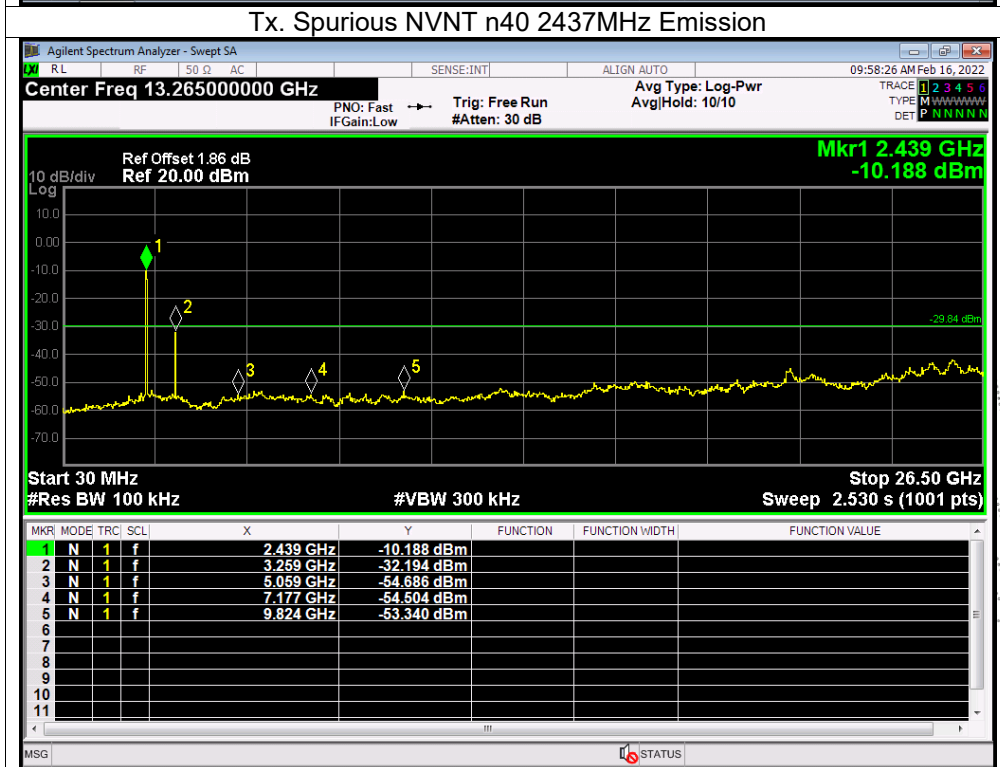
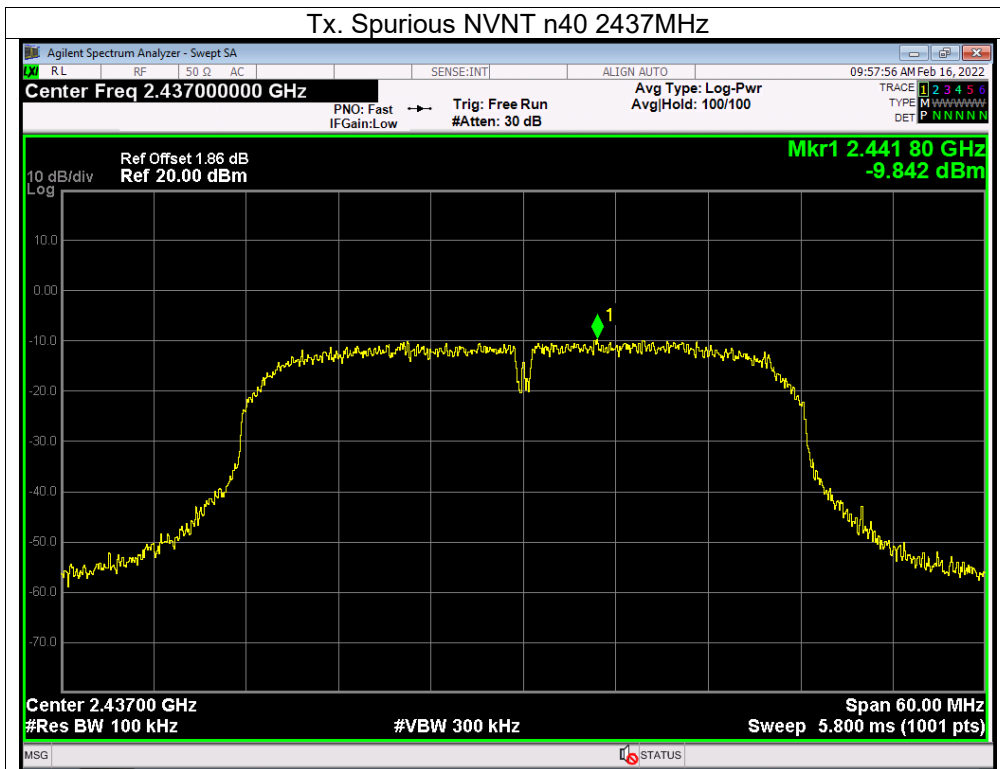

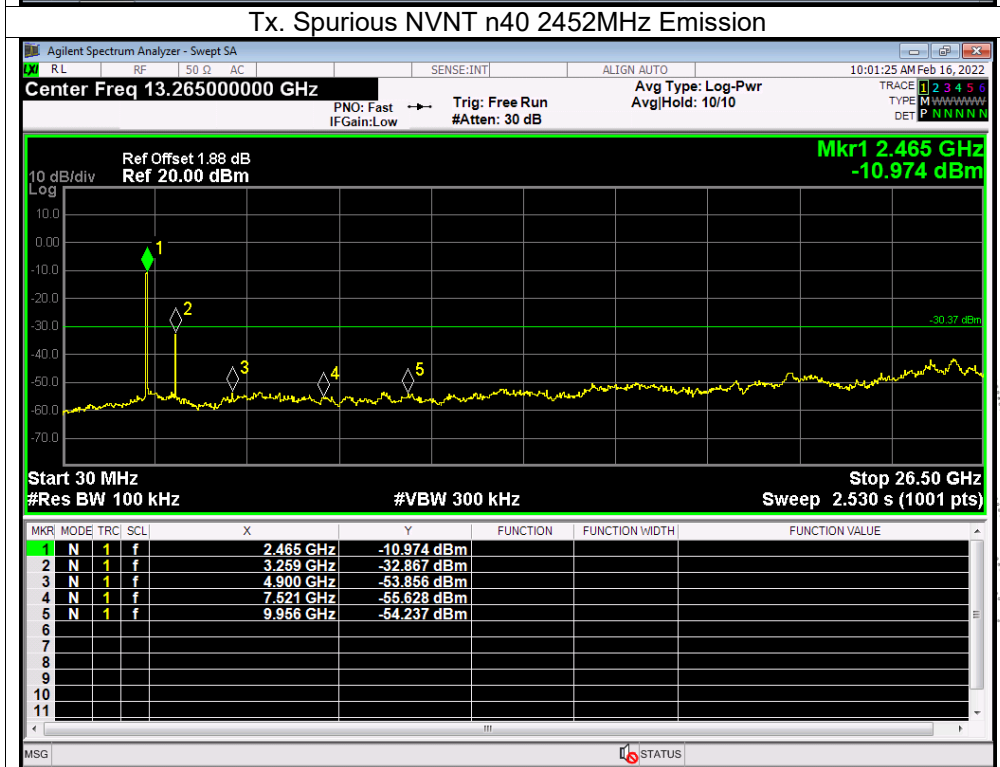
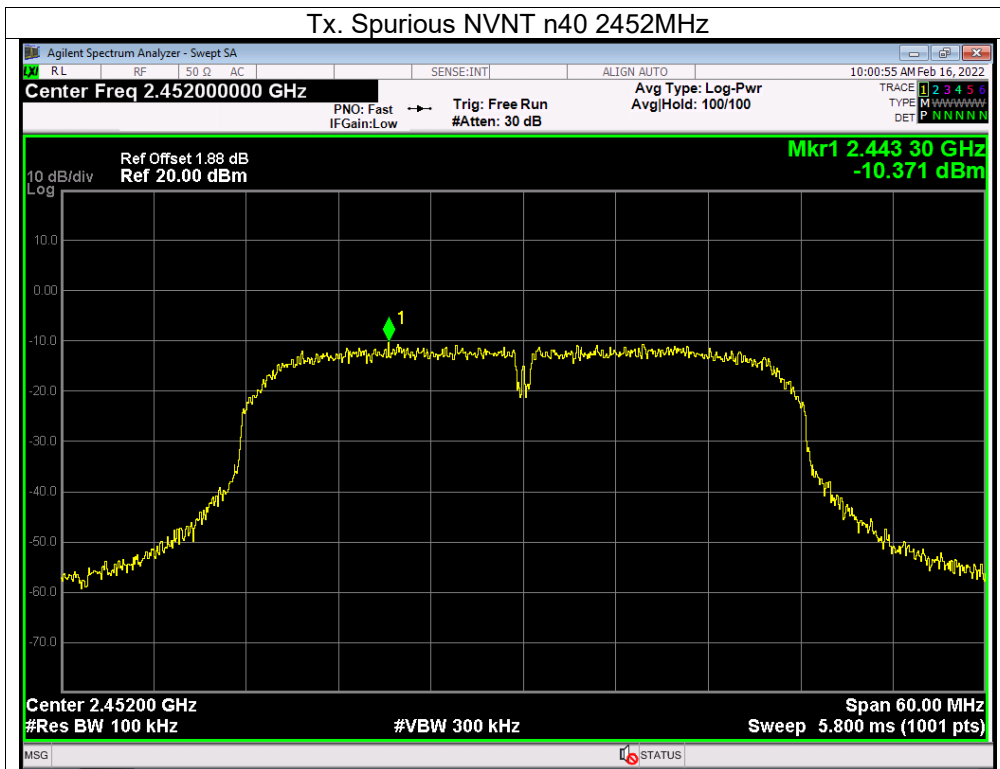

13. Duty Cycle Of Test Signal

13.1 Standard Requirement

Pre-analysis Check: While conducting average power measurement, duty cycle of each mode shall be checked to ensure its duty cycle in order to compensate for the loss due to insufficient ratio of duty cycle. All duty cycle is pre-scanned, and result as obtained below shows only the most representative ones where duty cycle is conducted as the given transmission with given virtual operation that expresses the percentage.

13.2 Formula

$$\text{Duty Cycle} = \text{Ton} / (\text{Ton} + \text{Toff})$$

13.3 Test Procedure

1. Set span = Zero
2. RBW = 8MHz
3. VBW = 8MHz,
4. Detector = Peak

13.4 Test Result

Condition	Mode	Frequency (MHz)	Duty Cycle (%)	Correction Factor (dB)	1/T (kHz)
NVNT	b	2412	100	0	0
NVNT	b	2437	100	0	0
NVNT	b	2462	100	0	0
NVNT	g	2412	100	0	0
NVNT	g	2437	100	0	0
NVNT	g	2462	100	0	0
NVNT	n20	2412	100	0	0
NVNT	n20	2437	100	0	0
NVNT	n20	2462	100	0	0
NVNT	n40	2422	100	0	0
NVNT	n40	2437	100	0	0
NVNT	n40	2452	100	0	0

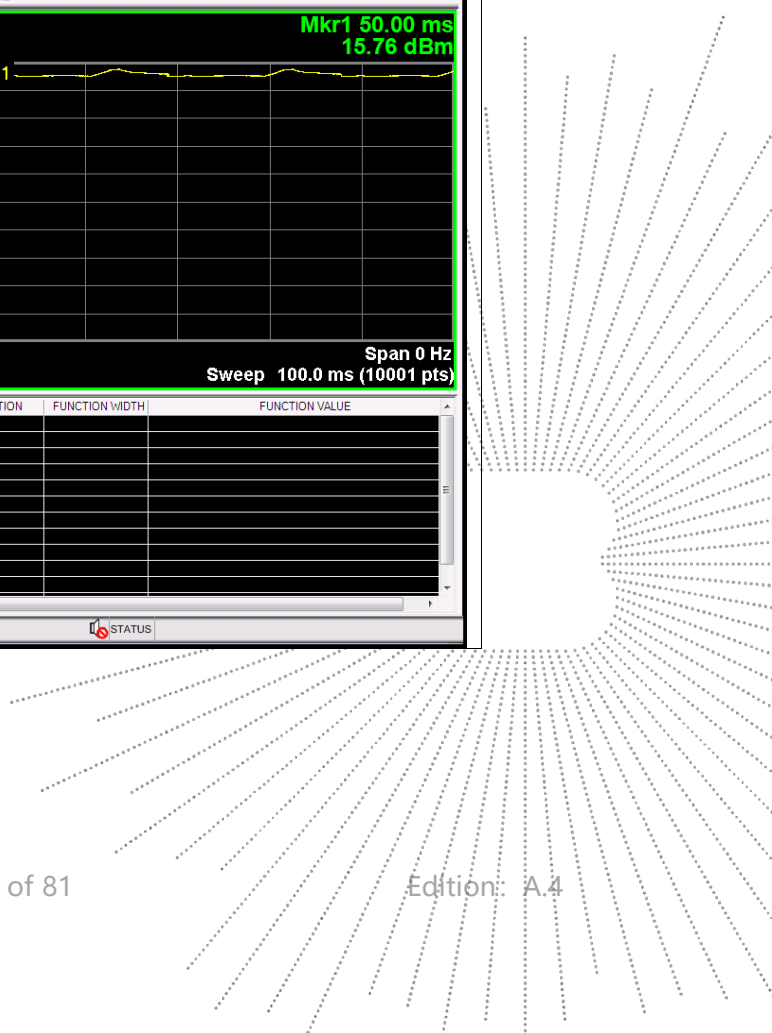
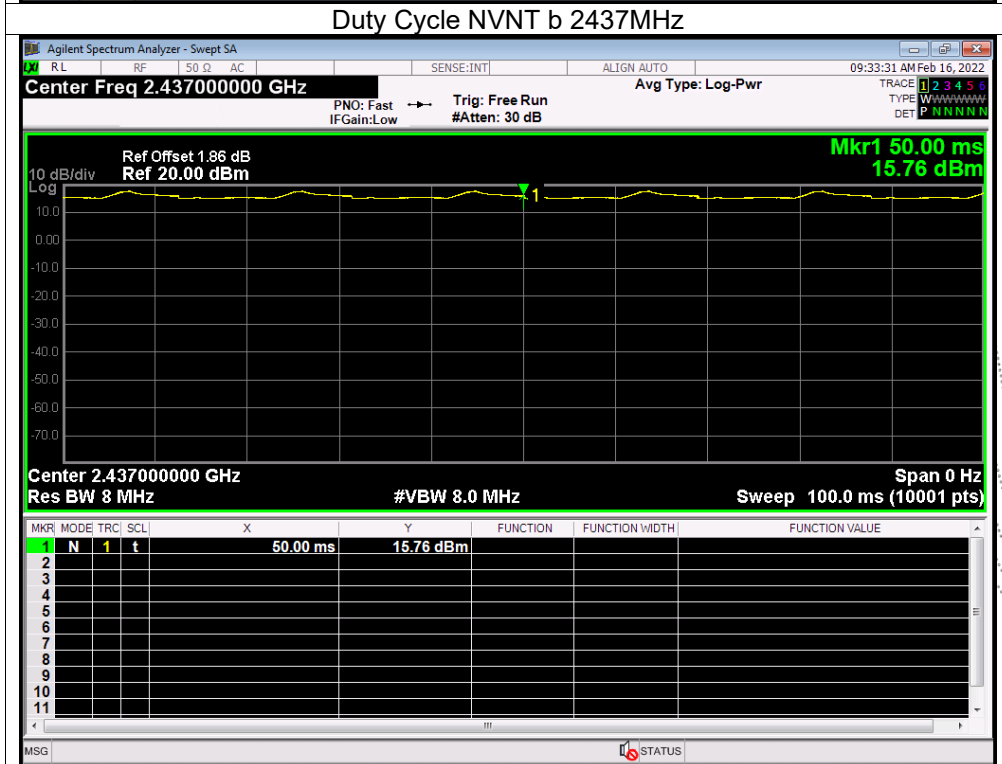
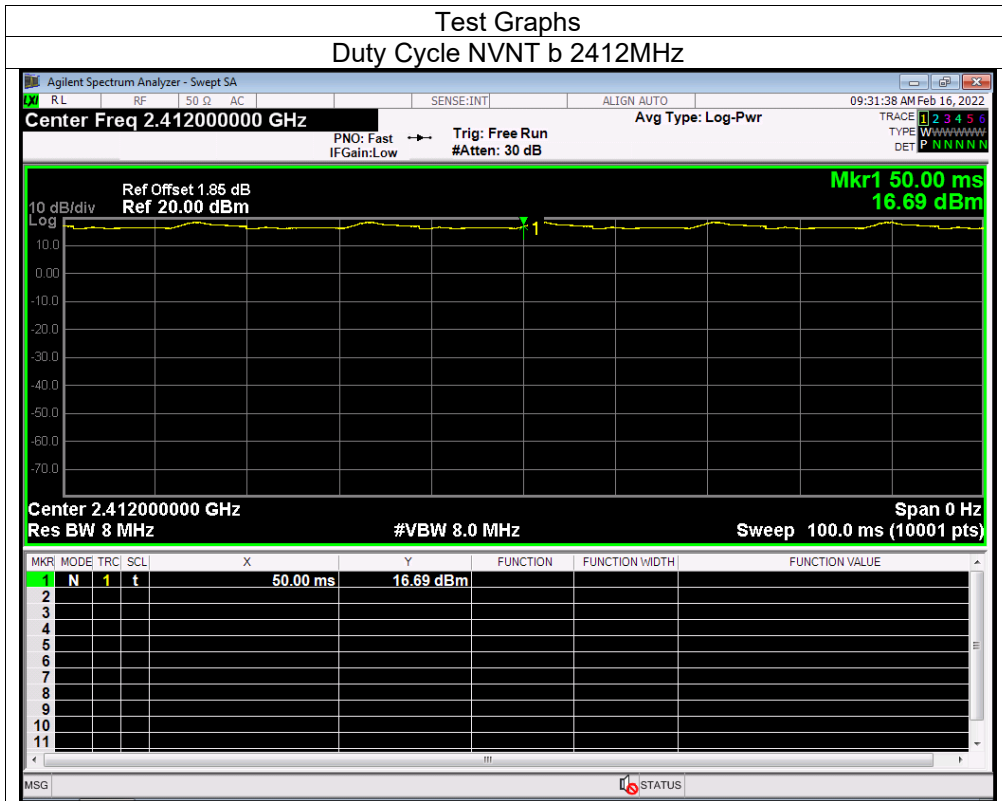

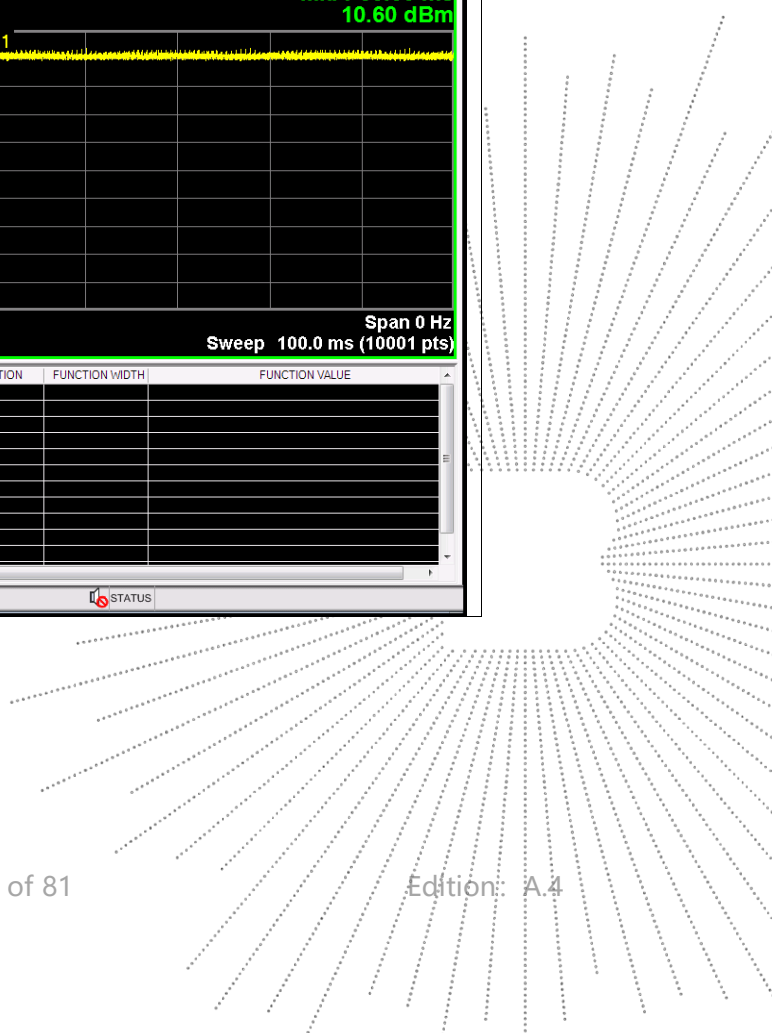
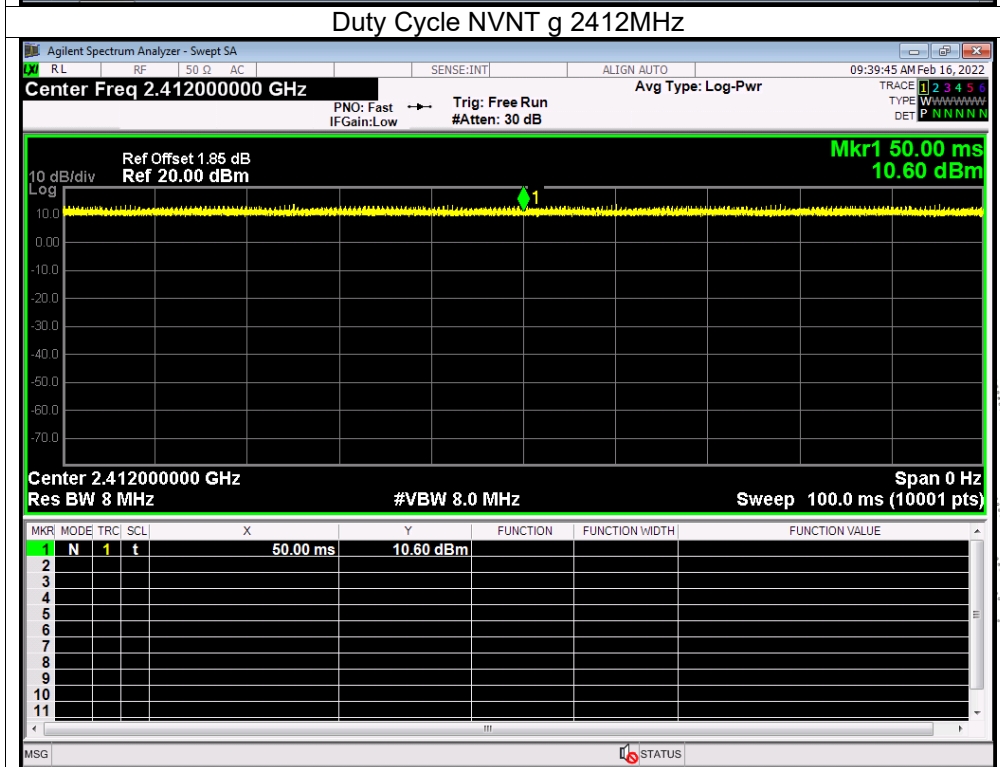
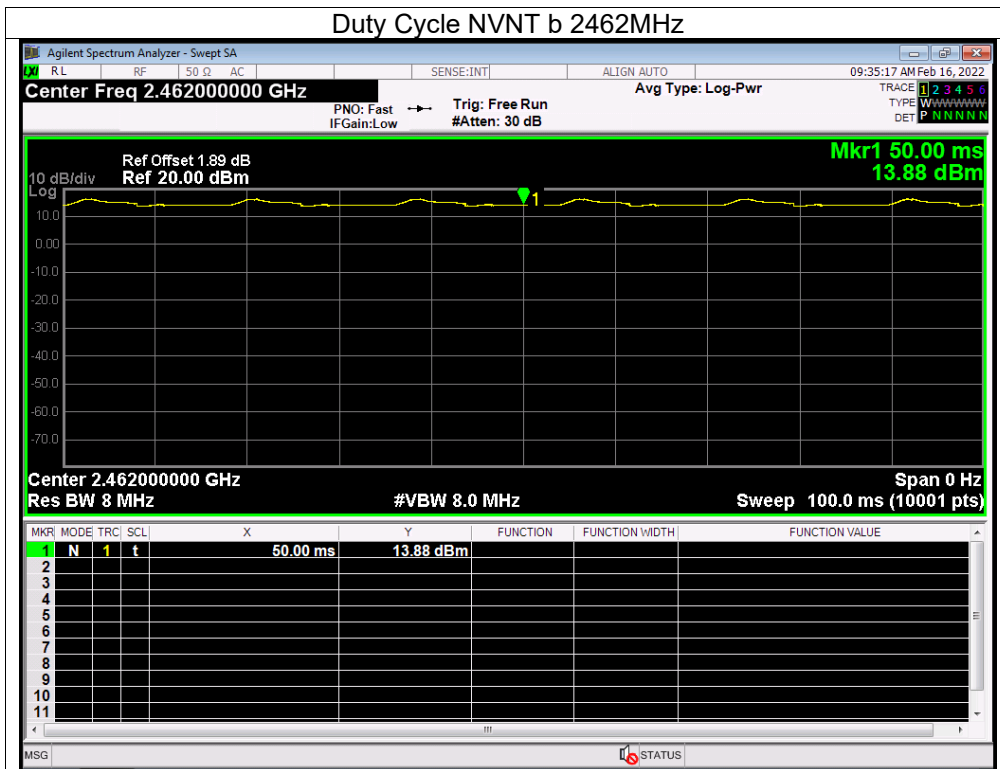

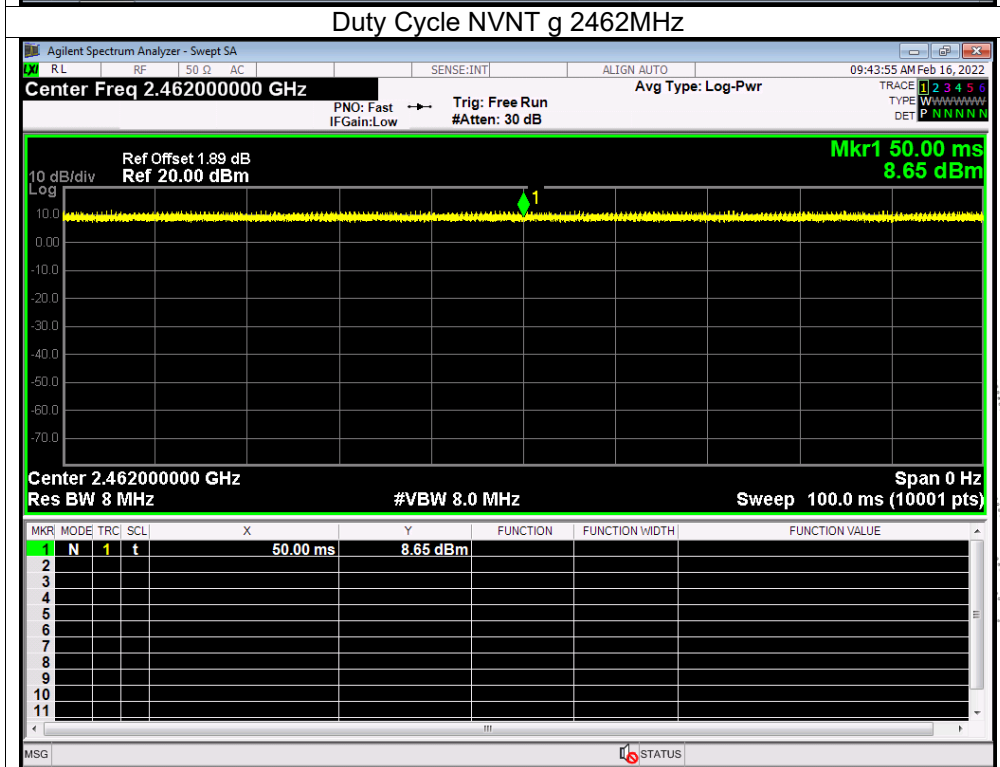
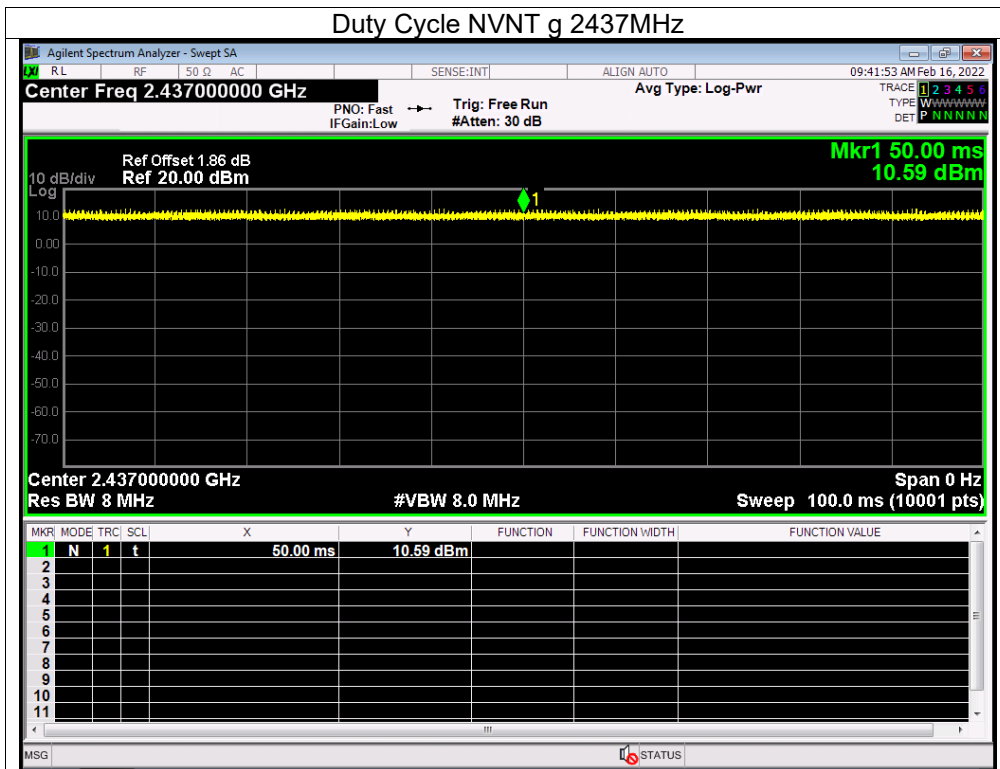

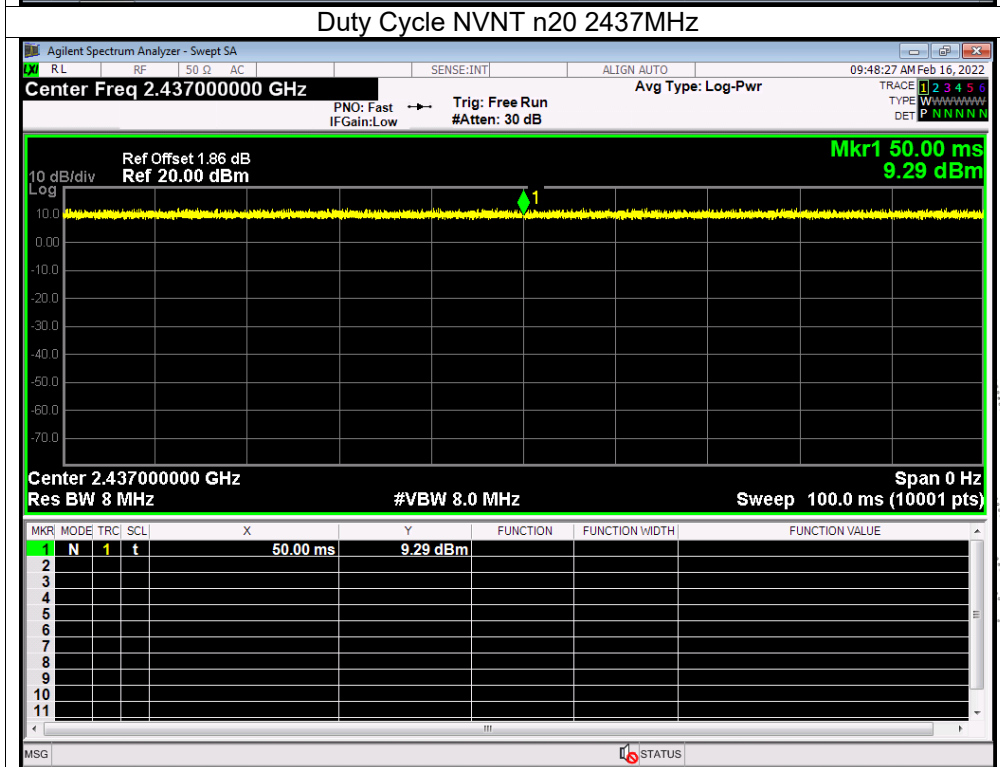
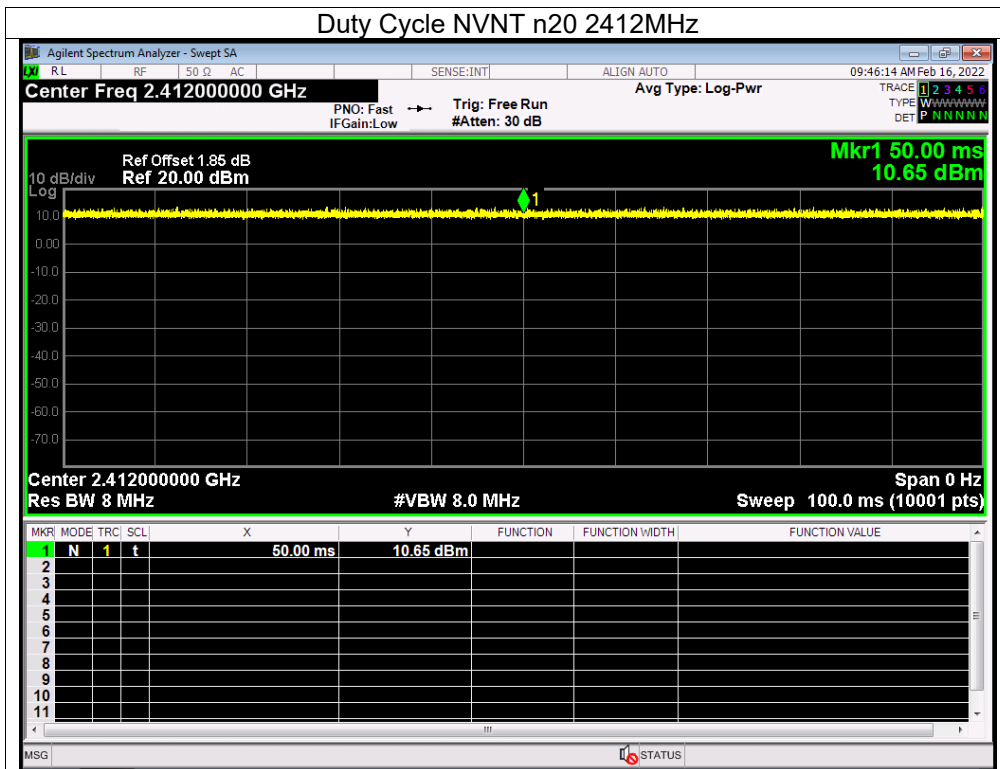

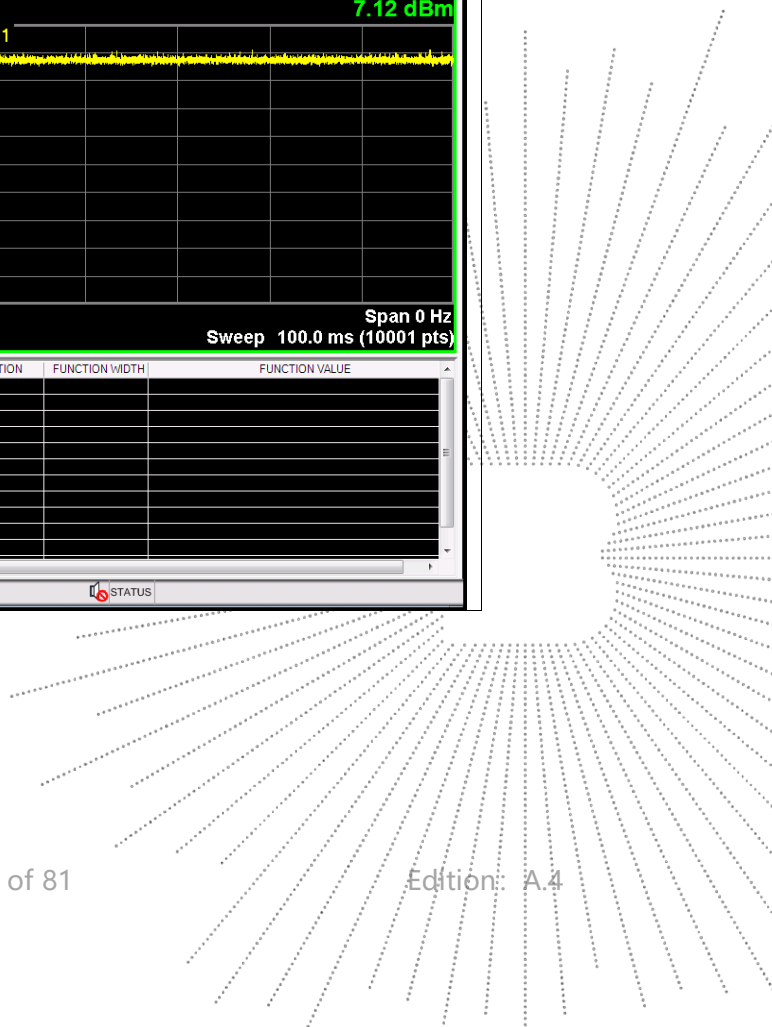
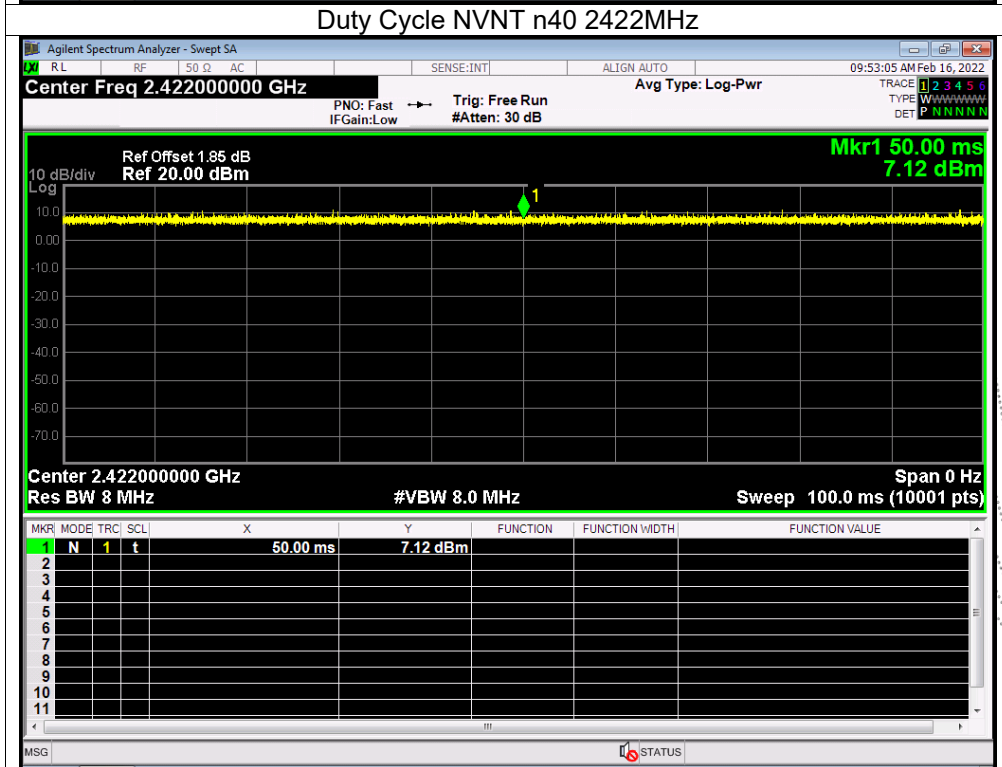
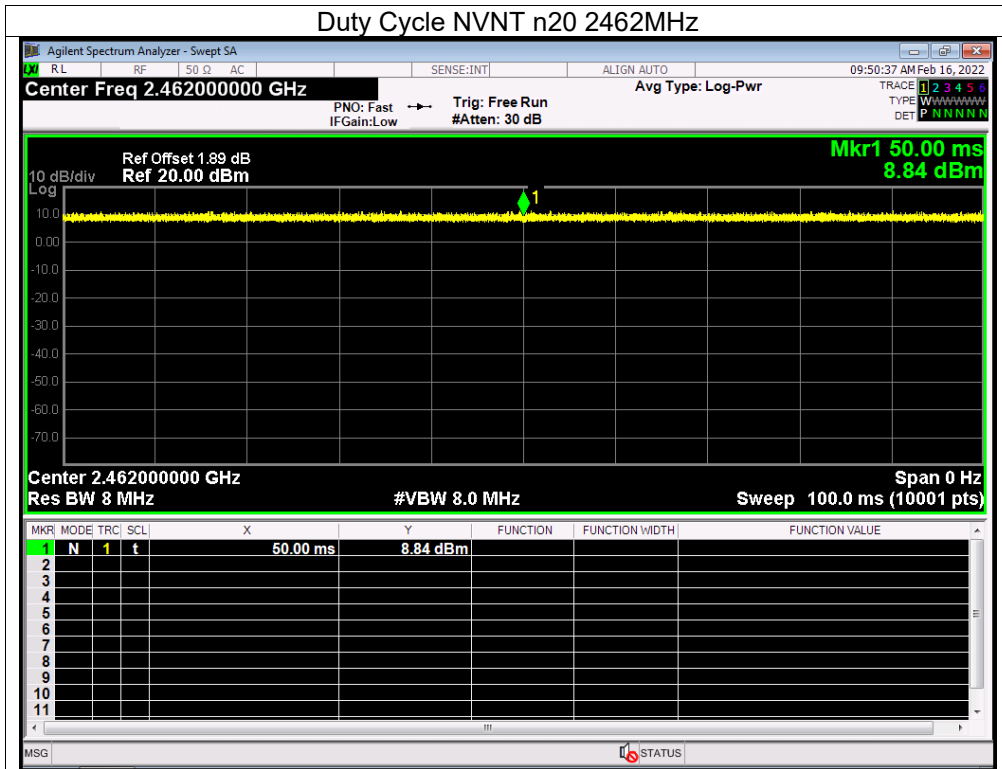

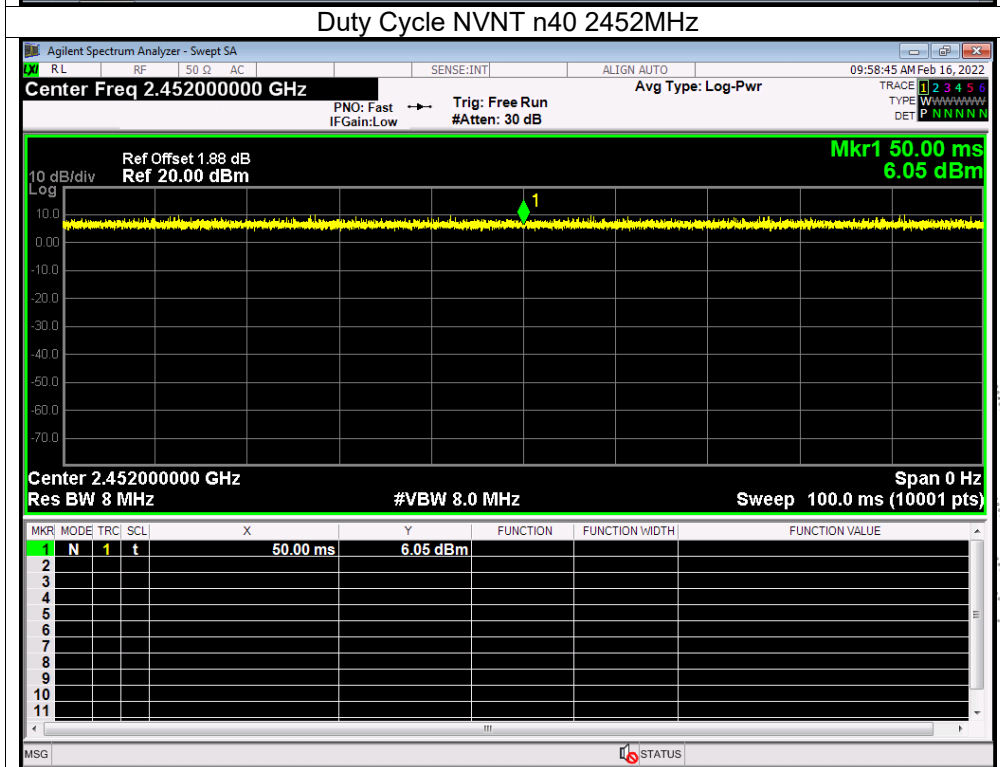
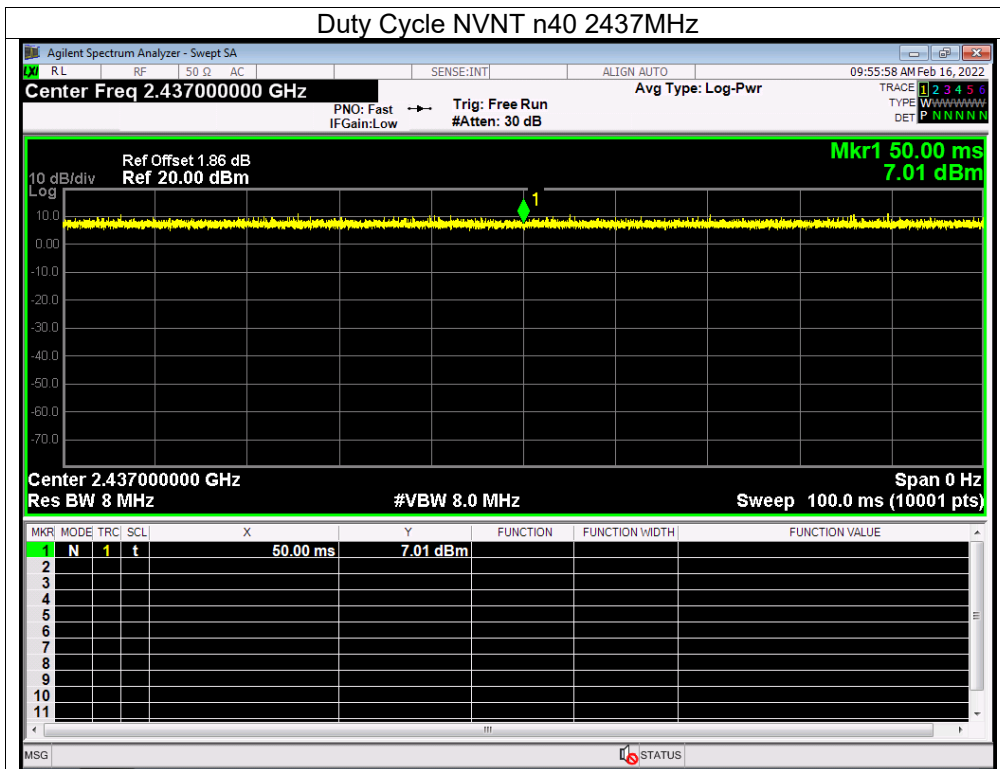

14. Antenna Requirement

14.1 Limit

15.203 requirement: For intentional device, according to 15.203: an intentional radiator shall be designed to ensure that no antenna other than that furnished by the responsible party shall be used with the device.

14.2 Test Result

The EUT antenna is PCB antenna, fulfill the requirement of this section.

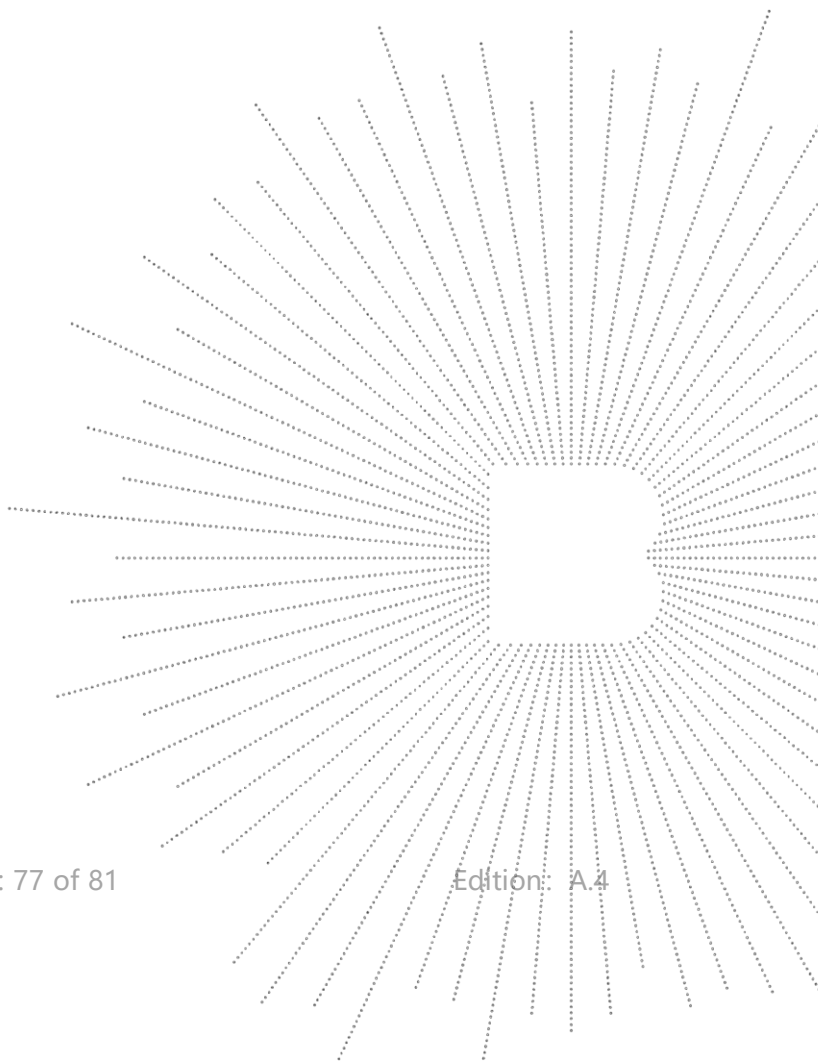

15. EUT Photographs

EUT Photo 1



EUT Photo 2

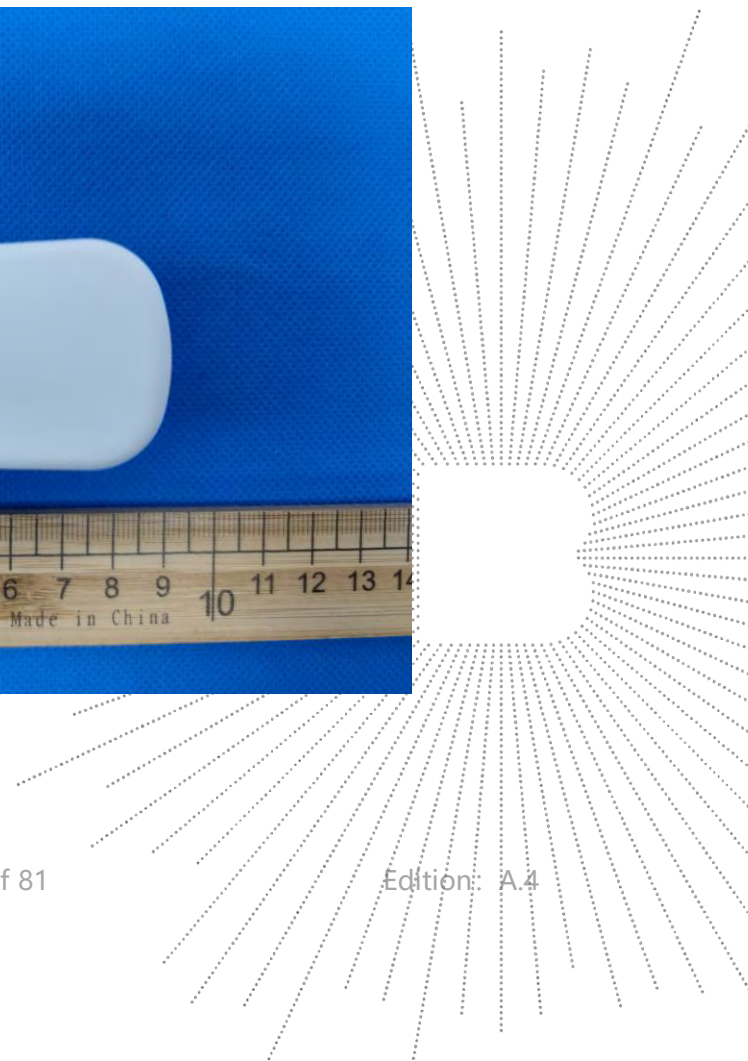

16. EUT Test Setup Photographs

Conducted emissions



Radiated Measurement Photos



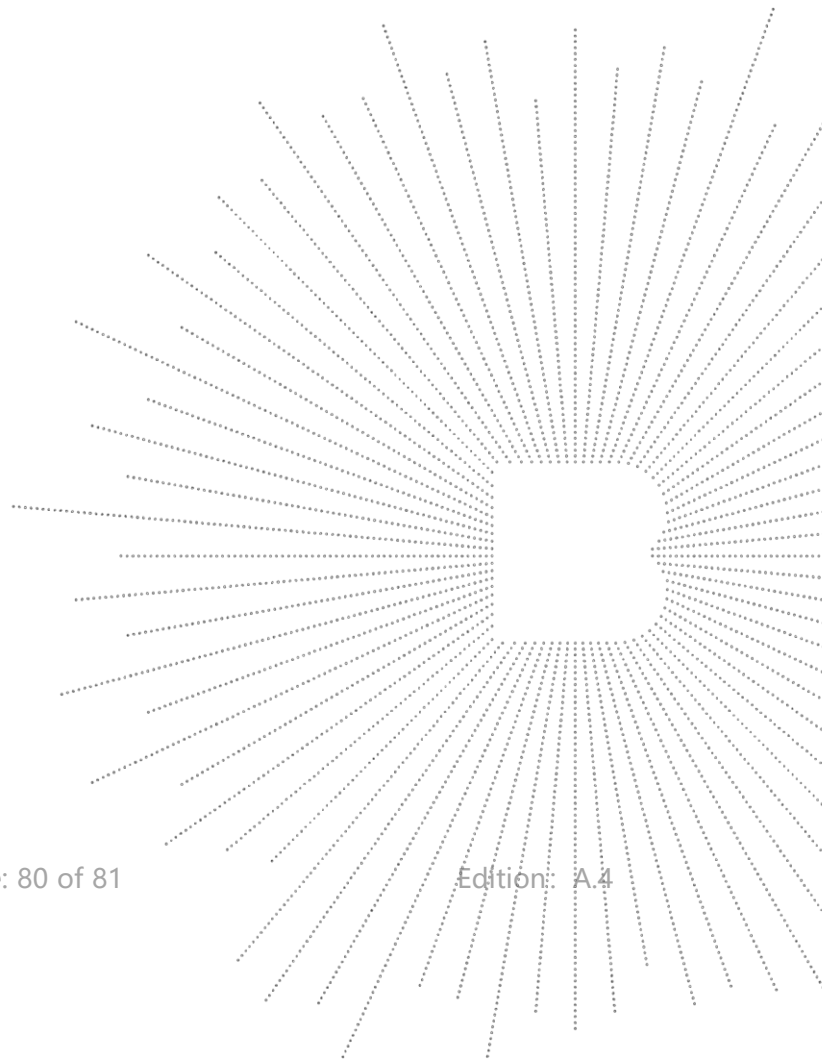
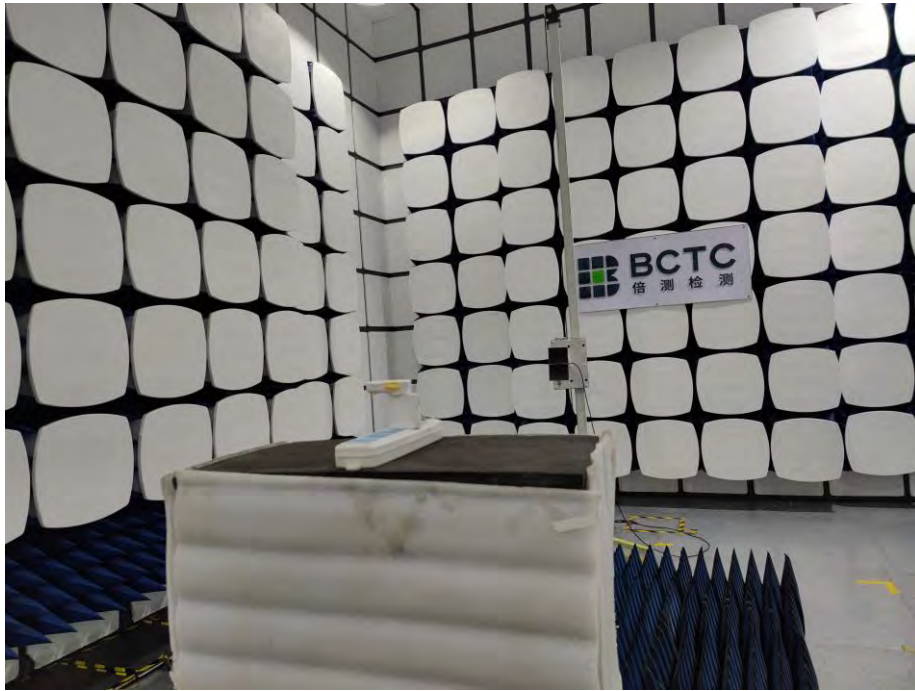

STATEMENT

- 1.The equipment lists are traceable to the national reference standards.
- 2.The test report can not be partially copied unless prior written approval is issued from our lab.
- 3.The test report is invalid without stamp of laboratory.
- 4.The test report is invalid without signature of person(s) testing and authorizing.
- 5.The test process and test result is only related to the Unit Under Test.
- 6.The quality system of our laboratory is in accordance with ISO/IEC17025.
- 7.If there is any objection to report, the client should inform issuing laboratory within 15 days from the date of receiving test report.

Address:

1-2/F., Building B, Pengzhou Industrial Park, No.158, Fuyuan 1st Road, Tangwei, Fuhai Subdistrict, Bao'an District, Shenzhen, Guangdong, China

TEL: 400-788-9558

P.C.: 518103

FAX: 0755-33229357

Website: <http://www.chnbctc.com>

E-Mail: bctc@bctc-lab.com.cn

***** END *****

