

Antenna test report

1. 规格

EUT Name	Antenna
Wireless type	BLE
Antenna Type	PCB antenna
Dimensions	Appendix A

2. Technical Information

Frequency Range	2402MHz~2480MHz
Test Frequency	2400, 2410.....2500MHz

3. Appendix A Antenna Dimension

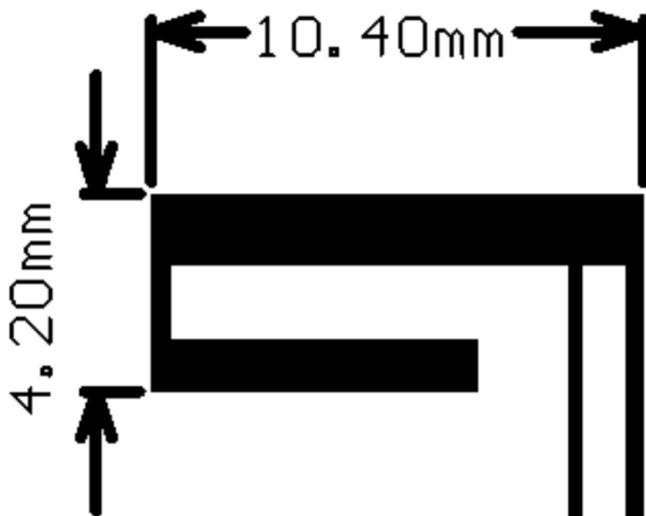

4. Appendix C Gain and Efficiency

Passive Test For BT2.4												
Freq (MHz)	Effi (%)	Effi (dB)	Gain (dBi)	Gain (dBd)	UHIS (%)	DHIS (%)	Max (dB)	Min (dB)	irectivity (dBi)	Beamwidth (3dB)	AttH (dB)	AttV (dB)
2400	14.59	-8.36	-5.4	-7.55	0	0	-5.4	-15.03	8.36	0	46.98	46.74
2410	14.93	-8.26	-5.29	-7.44	0	0	-5.29	-15.74	8.26	0	47.02	46.81
2420	15.43	-8.12	-4.89	-7.04	0	0	-4.89	-16	8.12	0	47.61	47.33
2430	16.83	-7.74	-4.49	-6.64	0	0	-4.49	-16.08	7.74	0	47.09	46.89
2440	21.14	-6.75	-3.6	-5.75	0	0	-3.6	-15.35	6.75	0	47.31	47.09
2450	22	-6.57	-3.43	-5.58	0	0	-3.43	-15.13	6.57	45	47.33	47.06
2460	23	-6.38	-3.14	-5.29	0	0	-3.14	-14.84	6.38	45	47.74	47.47
2470	24.35	-6.13	-2.9	-5.05	0	0	-2.9	-14.85	6.13	0	47.62	47.29
2480	26.83	-5.71	-2.31	-4.46	0	0	-2.31	-15	5.71	0	47.53	47.33
2490	35.81	-4.46	-0.85	-3	0	0	-0.85	-14.08	4.46	0	47.51	47.26
2500	34.38	-4.64	-0.91	-3.06	0	0	-0.91	-13.93	4.64	0	47.26	47.03

5. Appendix D Radiation Pattern

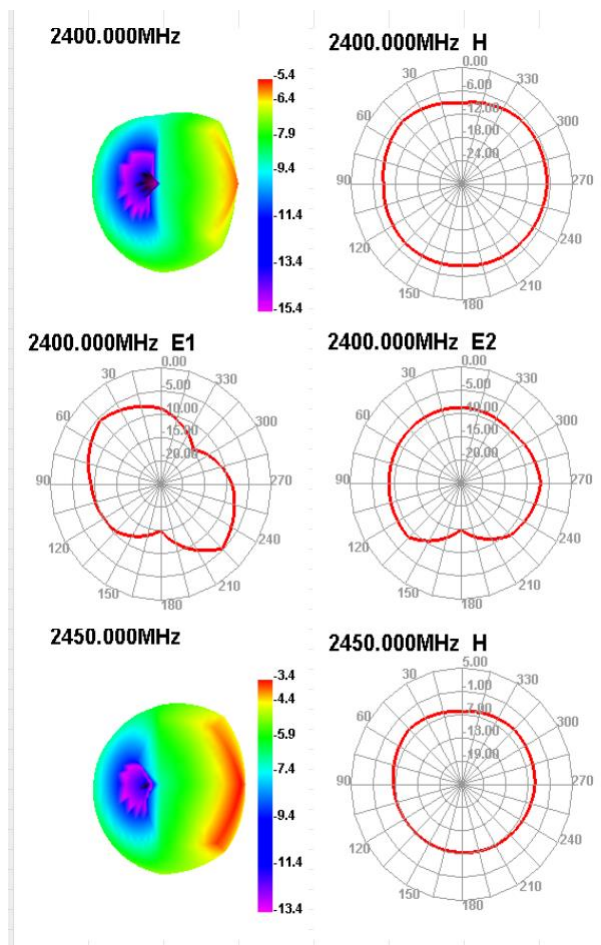

2450.000MHz E1

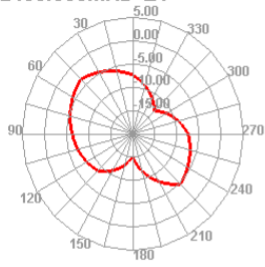

2450.000MHz E2

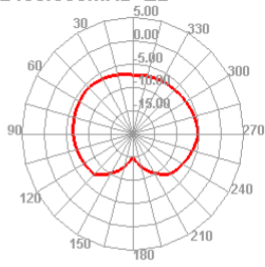

2500.000MHz

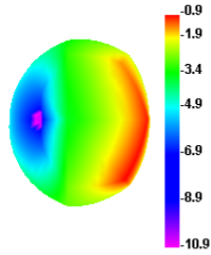

2500.000MHz H

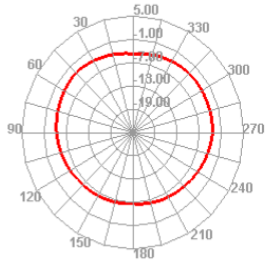

2500.000MHz E1

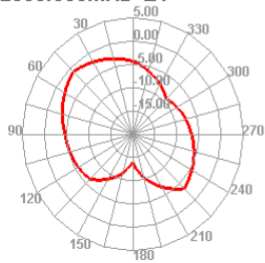

2500.000MHz E2

