



东莞市仁丰电子科技有限公司

Dongguan RF Electronic Technology Co., Ltd

公司地址：东莞市塘厦镇清湖头三坑工业区1号 电话：0769-38940168 传真：0769-39010966 网址：http://rflink.net.cn

规格书

SPECIFICATION FOR APPROVAL

客户名称

CUSTOMER NAME: 多好

产品名称

PRODUCT NAME: 2.4G/5G 黑色天线 外露=105mm

客户料号

CUSTOMER P/N:

仁丰料号

Ren Feng P/N: U00T01S004N03482 REV: A

内部结构

Internal structure: PCB+弹簧

	MANUFACTURER SIGNATURE	CUSTOMER SIGNATURE
CHECKED BY:	杨振	
AUDITOR BY:	刘小林	
APPROVED BY:	姚定军	
DATE:	2023-06-01	



东莞市仁丰电子科技有限公司

Dongguan RF Electronic Technology Co., Ltd

公司地址：东莞市塘厦镇清湖头三坑工业区1号 电话：0769-38940168 传真：0769-39010966 网址：<http://rflink.net.cn>

Contents

<i>Description</i>	<i>Page</i>
1、封面 Cover -----	1
2、履历表 Resume -----	2
3、目录 Contents-----	3
4、规格表 Specifications sheets -----	4
5、成品图 End product chart -----	5
6、测试报告 Testing report -----	6



东莞市仁丰电子科技有限公司

Dongguan RF Electronic Technology Co., Ltd

公司地址：东莞市塘厦镇清湖头三坑工业区1号 电话：0769-38940168 传真：0769-39010966 网址：<http://rflink.net.cn>

产品主要技术参数

Main technical specifications

主要技术指标		Main technical specifications	
频率范围 (MHZ)	2400-2500	Frequency Range (MHZ)	2400-2500
	5150-5850		5150-5850
中心频率 特性阻抗(Ω)	50 \pm 10	Impedance(Ω)	50 \pm 10
增益(dBi)	3 \pm 0.5	Gain(dBi)	3 \pm 0.5
反射损耗	-9.5	ReTurnLoss(dB)	-9.5
输出电压 驻波比	2.0	VSWR	2.0
最大功率	1W	Admitted Power	1W
极化方式	垂直极化	Polarization	Linear, Vertical
方向性	全向性	Radiation	Omni-directional
连接方式	端子	Connector Type	MHF Plug
物理性能		Physical Properties	
天线本体材 料	ABS	Antenna Base	ABS
工作温度	-20 $^{\circ}$ C \sim +60 $^{\circ}$ C	Operating Temp	-20 $^{\circ}$ C \sim +60 $^{\circ}$ C
保存温度	-20 $^{\circ}$ C \sim +70 $^{\circ}$ C	Storage Temp	-20 $^{\circ}$ C \sim +70 $^{\circ}$ C

5.成品图

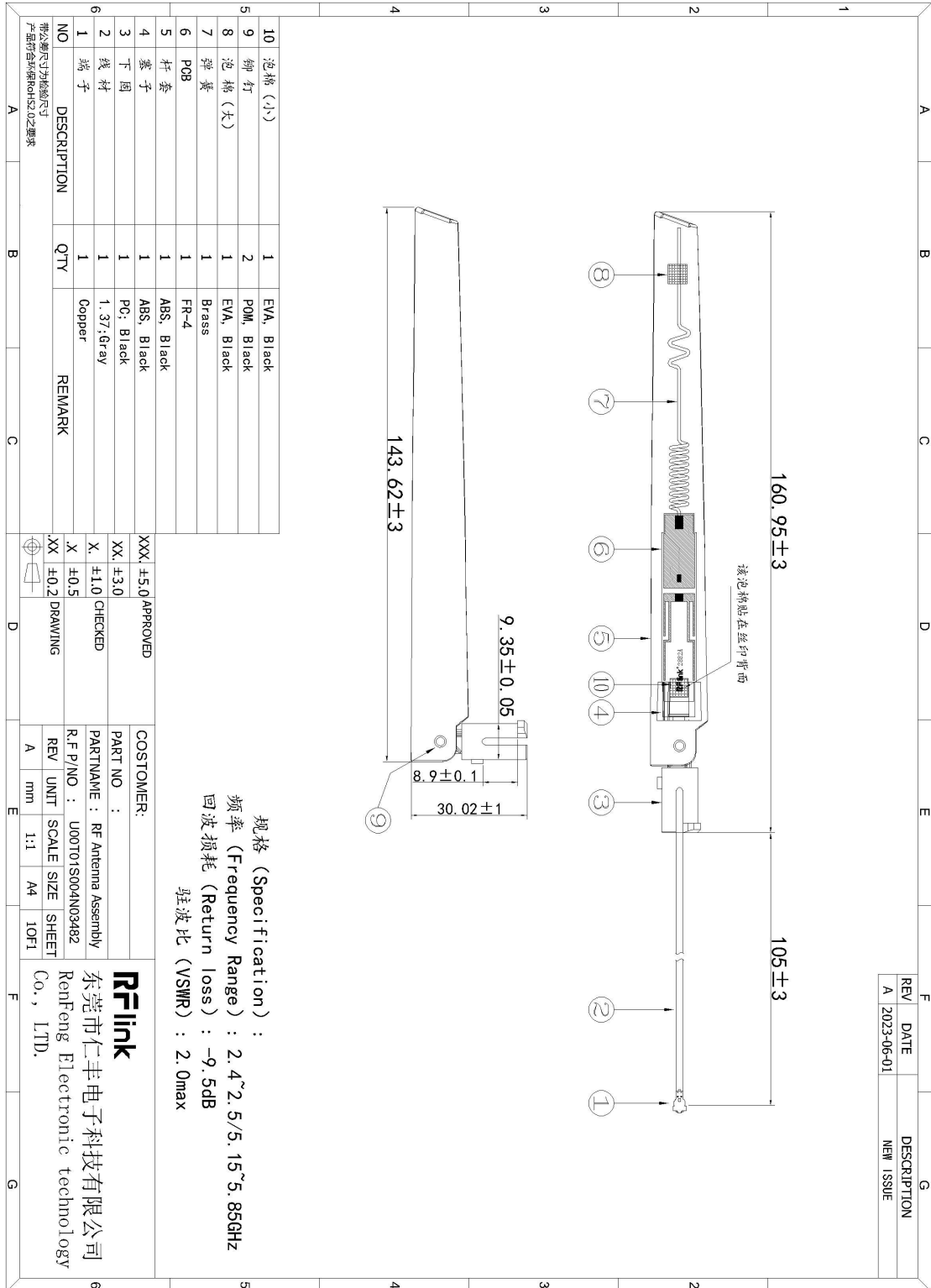

产品包装

REV	DATE	DESCRIPTION
A	2023-06-02	NEW ISSUE

单个产品



内袋包装说明:

1. 每袋装入50pcs产品.
2. 用珍珠棉袋/橡皮筋固定线材
3. 每袋需贴相应标签



内袋包装

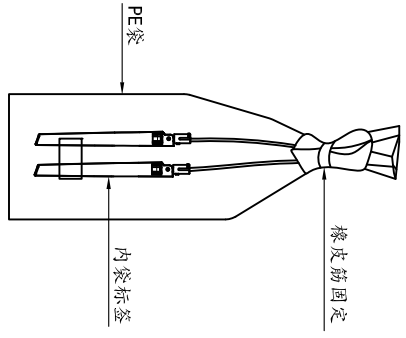

外箱包装



- ### 外箱包装说明:
1. 外箱需RoHS标识及1pc外箱标签.
 2. 每箱装18袋, 共装900pcs产品.

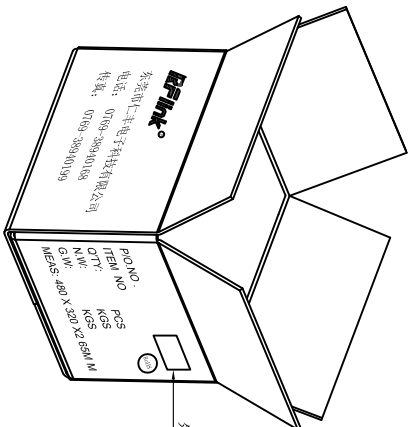

外箱标签

<p>尺寸范围 (mm) 公差 (mm)</p> <table border="1"> <tr> <td>001 ≤ L < 30</td> <td>±0.10</td> </tr> <tr> <td>30 ≤ L < 50</td> <td>±0.15</td> </tr> <tr> <td>50 ≤ L < 80</td> <td>±0.20</td> </tr> <tr> <td>80 ≤ L < 115</td> <td>±0.25</td> </tr> <tr> <td>115 ≤ L < 300</td> <td>±0.35</td> </tr> </table>		001 ≤ L < 30	±0.10	30 ≤ L < 50	±0.15	50 ≤ L < 80	±0.20	80 ≤ L < 115	±0.25	115 ≤ L < 300	±0.35	APPROVED	COSTOMER:	
001 ≤ L < 30	±0.10													
30 ≤ L < 50	±0.15													
50 ≤ L < 80	±0.20													
80 ≤ L < 115	±0.25													
115 ≤ L < 300	±0.35													
<p>角度</p>		CHECKED	PART NO :											
<p>产品符合环保RoHS2.0之要求</p>		DRAWING	PARTNAME : 外置天线出线式包装											
			R.F P/NO : U00T01S004N03482											
			REV											
			UNIT											
			SCALE											
			SIZE											
			SHEET											
			10F1											



东莞市仁丰电子科技有限公司
RenFeng Electronic technology
Co., LTD.

RF link
东莞市仁丰电子科技有限公司
电话: 0769-39810188
传真: 0769-39810159

P/NO :
ITEM NO :
P/S :
K/S :
C/TY :
N/W :
G.W : 480 X 200 X2 65MM
MENS :

6、测试报告

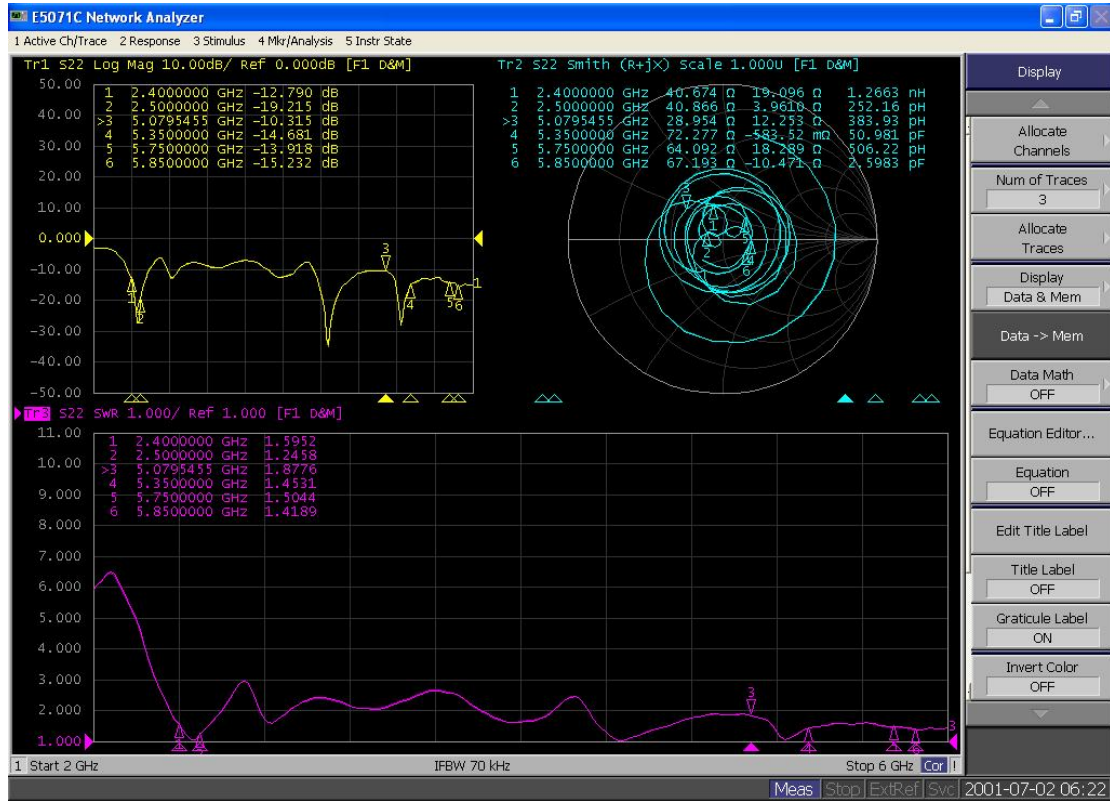

专业无线终端天线供应商

线长105mm-3D

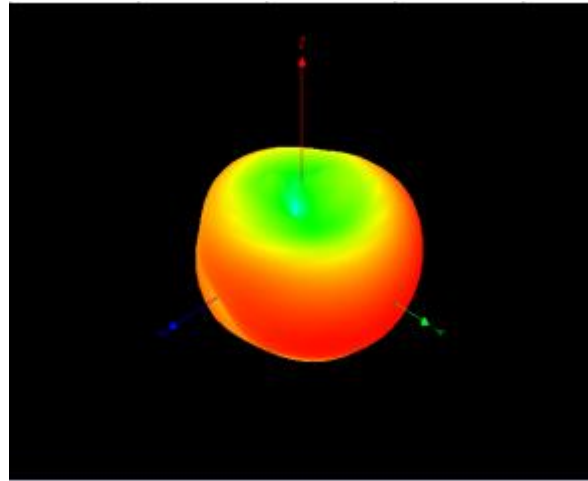

2400MHZ

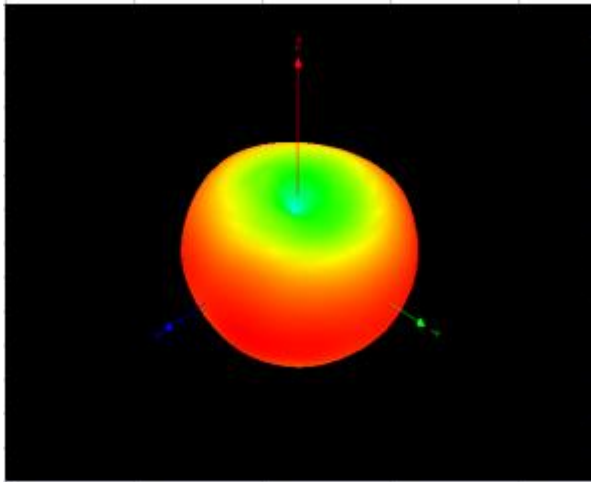

2450MHZ

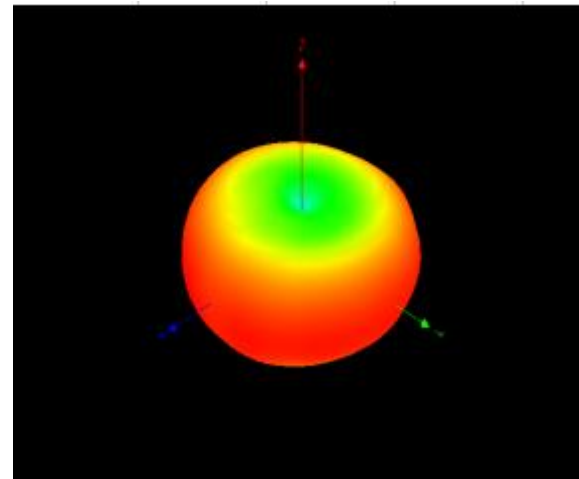

2500MHZ

专业无线终端天线供应商

线长105mm-3D

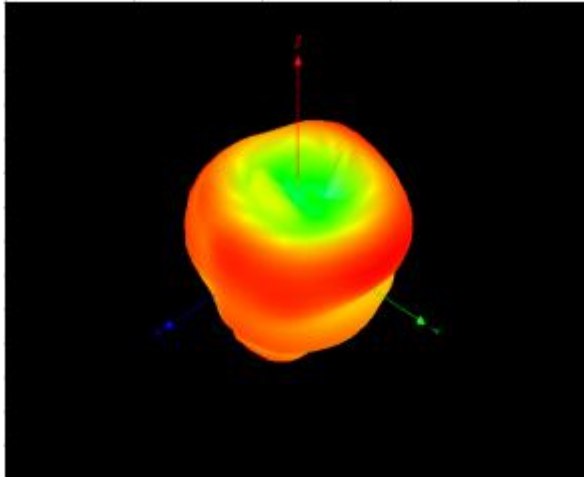

5150MHZ

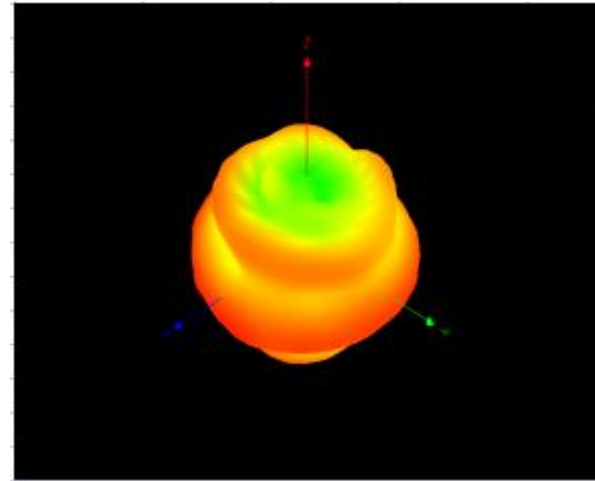

5350MHZ

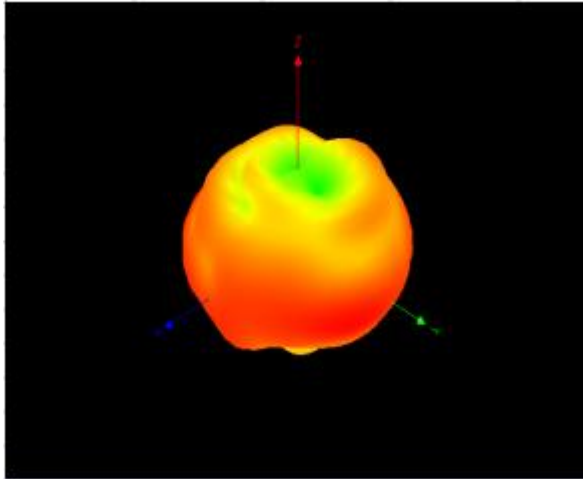

5750MHZ

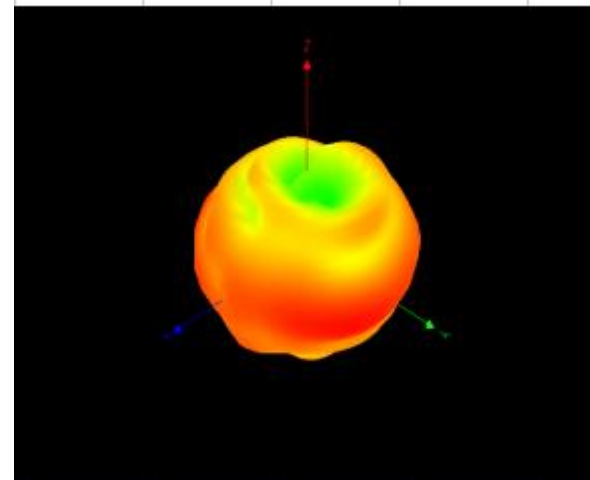

5850MHZ

专业无线终端天线供应商

线长105mm-2D

仁丰
天线

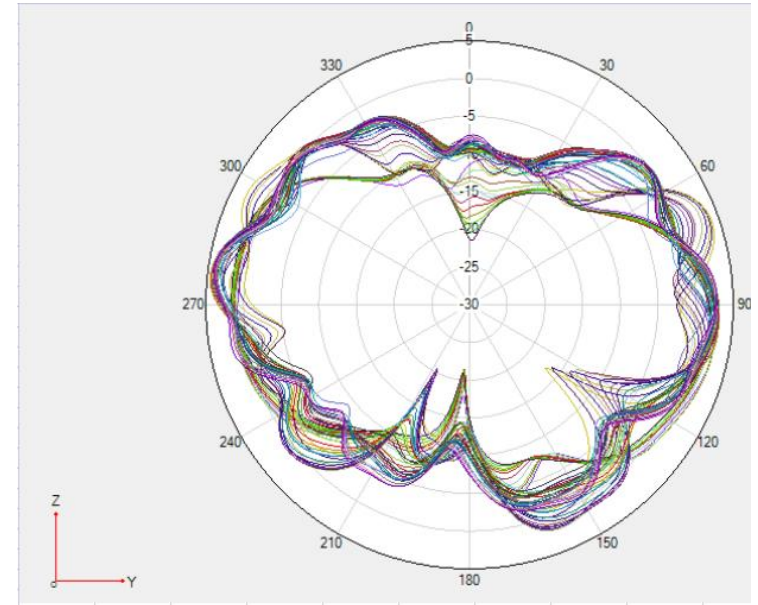
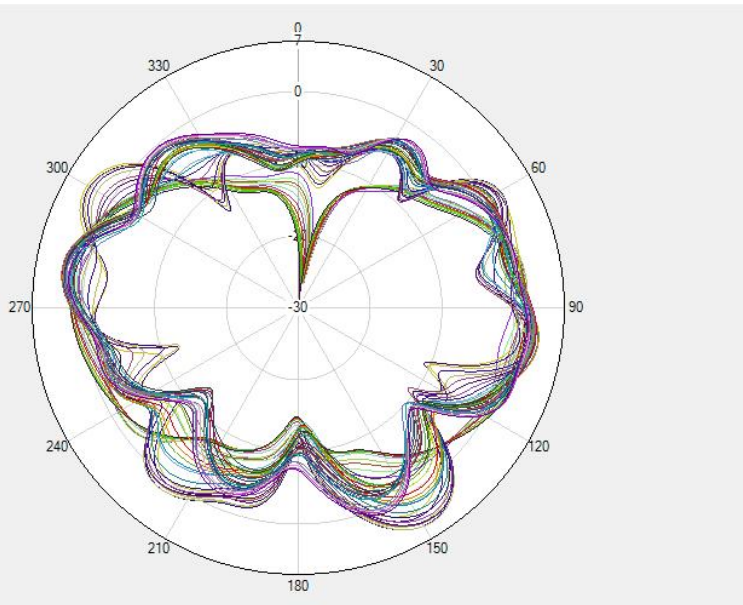
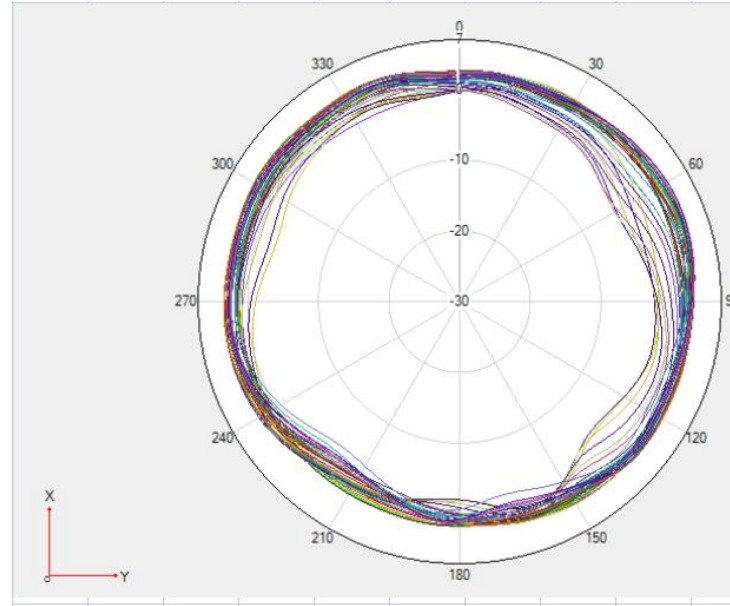

线长105mm

2.4G

Freq (MHz)	Effi (%)	Gain (dBi)
2400	76.38	3.18
2410	79.98	3.15
2420	82.41	3.09
2430	85.11	3.16
2440	84.72	2.72
2450	83.18	2.62
2460	80.72	2.51
2470	80.54	2.56
2480	79.98	2.55
2490	78.34	2.52
2500	77.27	2.65

5G

Freq (MHz)	Effi (%)	Gain (dBi)
5150	69.02	4.07
5200	73.79	5.18
5250	74.82	5.07
5300	74.47	4.65
5350	73.28	3.91
5400	75.86	4.6
5450	74.64	3.88
5500	73.79	3.94
5550	73.79	3.17
5600	76.56	4.42
5650	77.09	3.95
5700	73.96	4.08
5750	69.82	3.36
5800	71.61	4.13
5850	72.28	3.28