

# SMD CERAMIC ANTENNA

## Data Sheet

---

---

# HZ3216WA02

## CA-2450-31-A

For 2400-2484MHz

3.2x1.6mm [EIA1206]

## Feature

- Light weight, compact
- Wide bandwidth, low cost
- Built-in antenna with high gain

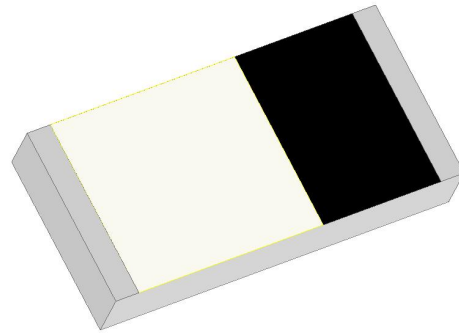

## Application

- Bluetooth
- IEEE802.11g/b
- Zigbee systems
- etc...

## Shapes And Dimensions Dimensions in mm

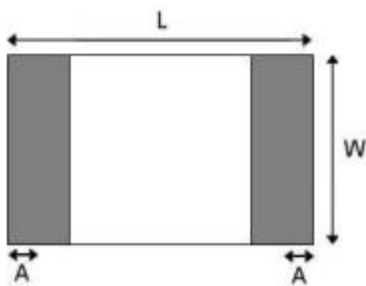

L	W	A	H
3.10±0.10	1.55±0.10	0.40±0.20	0.55±0.1



■ Evaluation Board

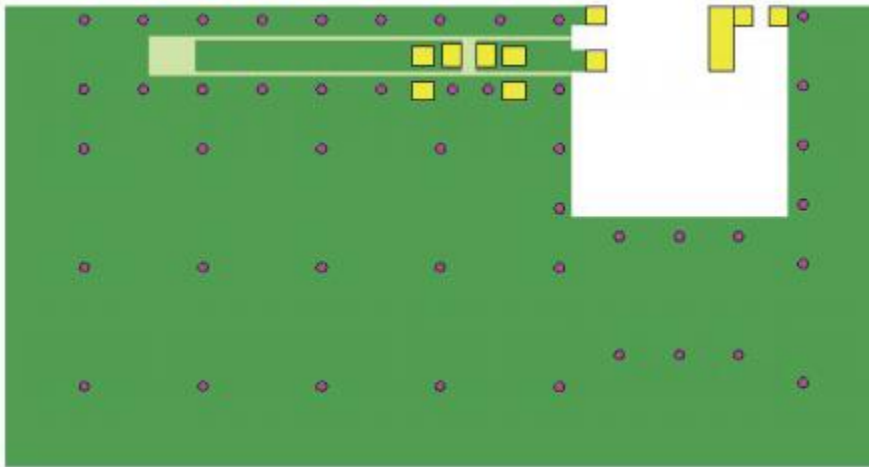

- ANT
- PAD
- TOP
- BOTTOM
- VIA

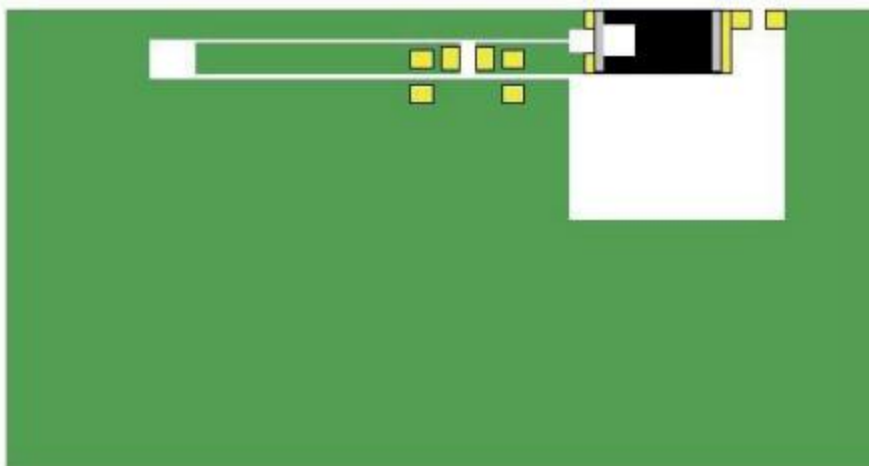

- ANT
- PAD
- TOP
- BOTTOM

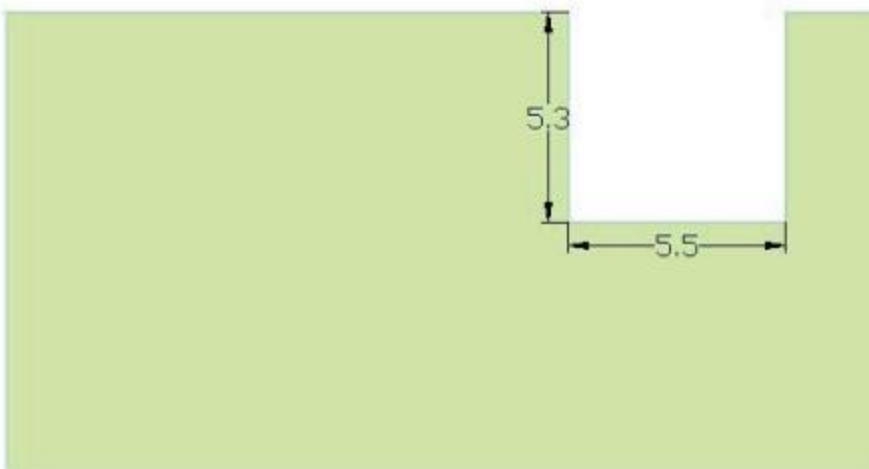

### Electrical Characteristics per line(TA=25°C)

Parameter	Specification	Units
Frequency Band	2400~2483	MHz
Polar ization	Line	
* Peak Gain	2.67	dBi
* Efficiency	72.30	%
Im pendance	50	$\Omega$

### ■ Part Numbering System

CA - 2450 - 31 - A  
 Material Frequency Size Type

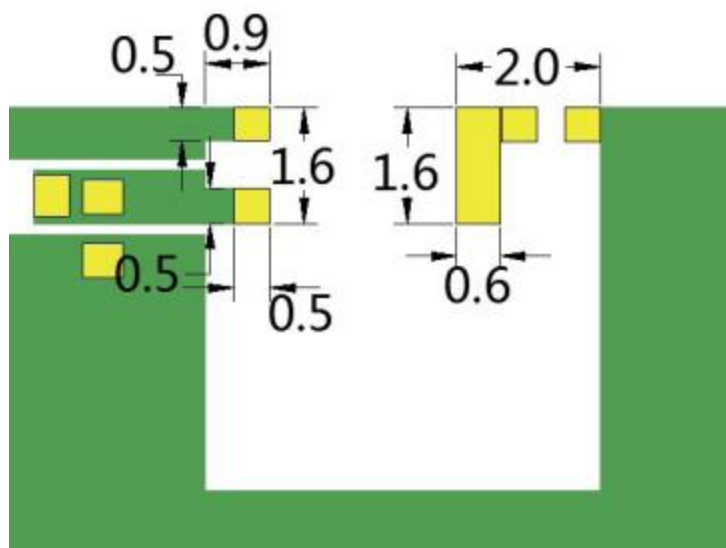

## Radiation Patterns

2.4GHz WLAN BAND

3D Gain Pattern (2400 MHz)

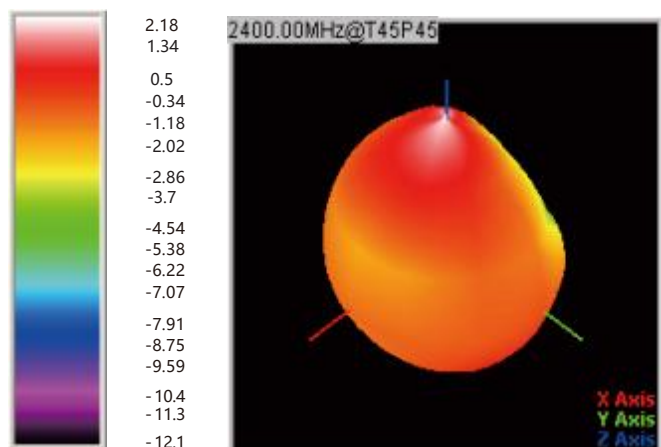

3D Gain Pattern (2440 MHz)

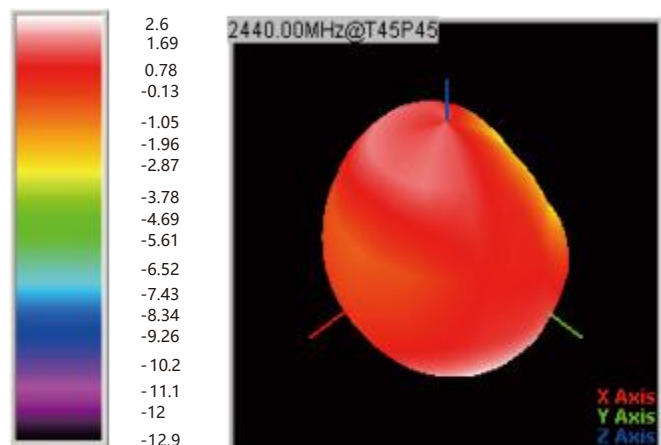

3D Gain Pattern (2480 MHz)

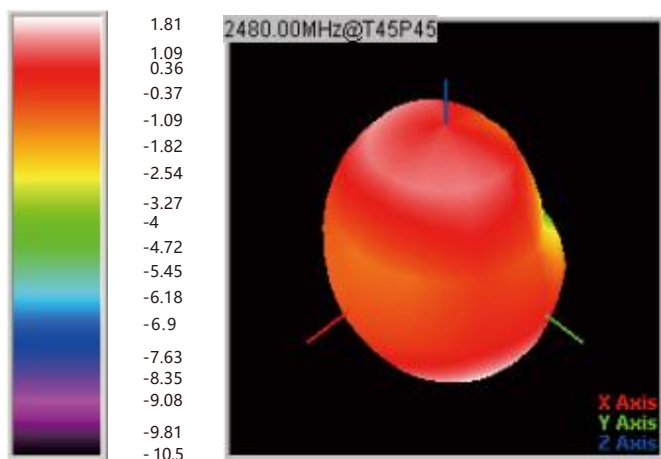

Freq (MHz)	Effi (%)	Gain (dBi)
2400	74.8	2.67
2410	72.59	2.54
2420	71.6	2.25
2430	70.29	2.07
2440	71.23	2.16
2450	72.3	2.37
2460	71.04	2.52
2470	65.95	2.35
2480	64.42	2.42
2490	62.59	2.31
2500	60.01	2.07

■ Frequency Characteristics

□ EFFICIENCY AND VSWR

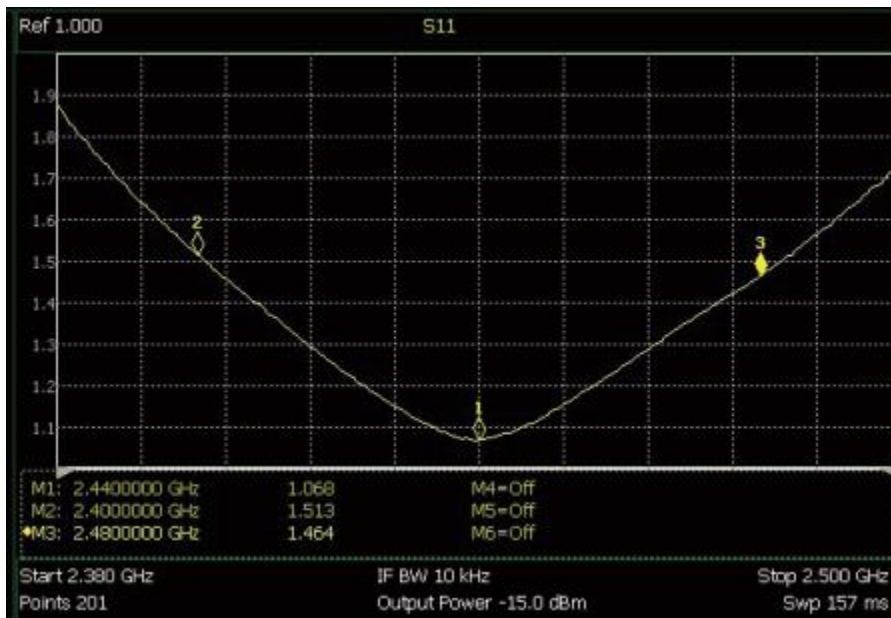
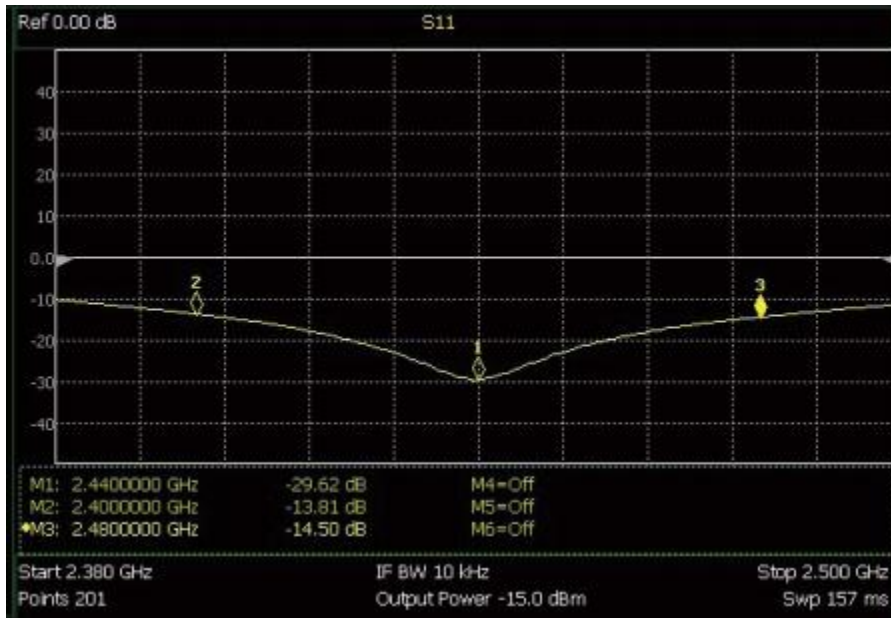

■ RECOMMENDED REFLOW PROFILE

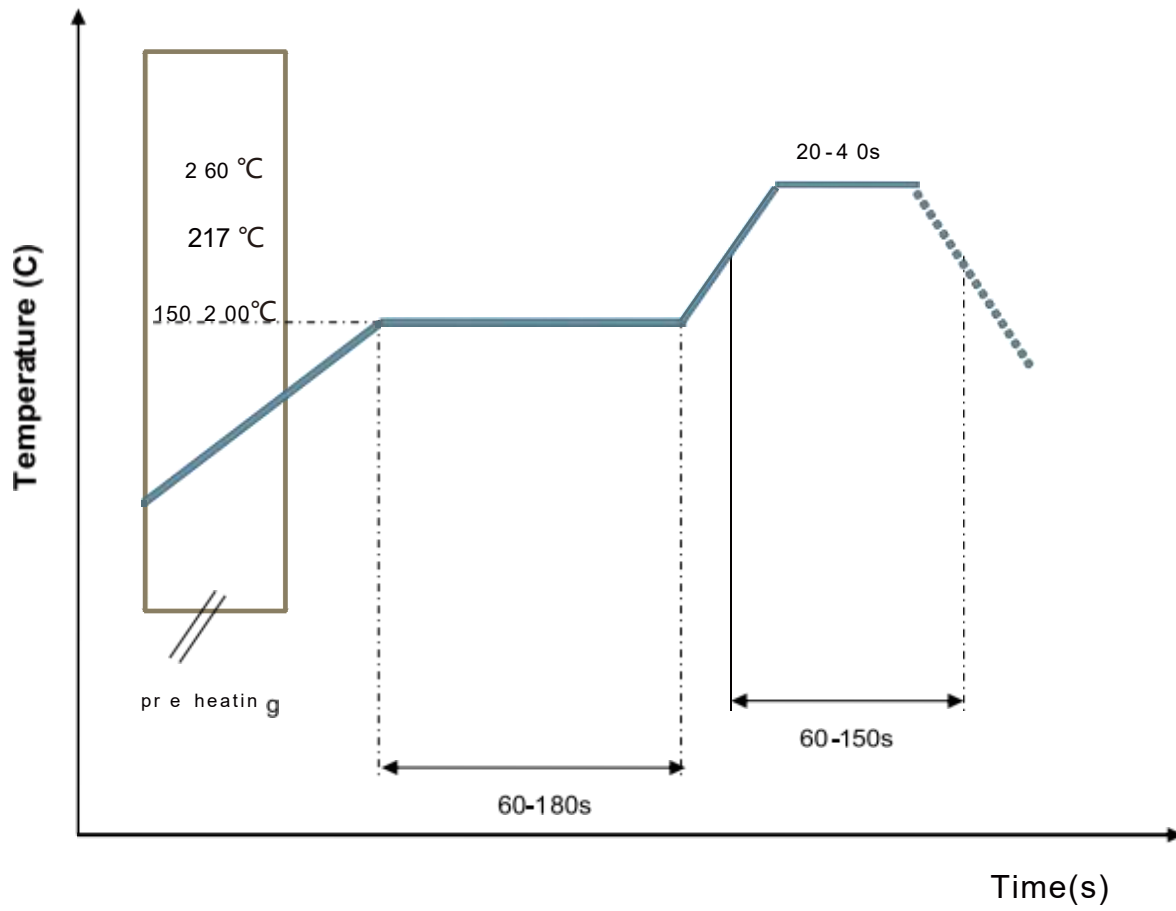

■ Packaging Style

□ REEL DIMENSIONS

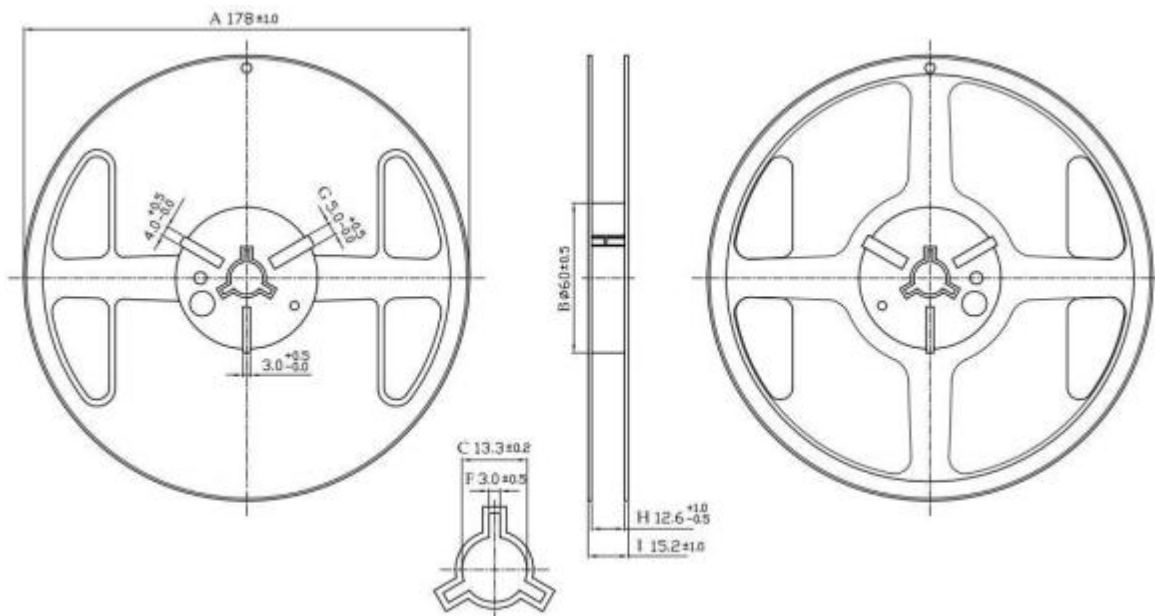

□ TAPE DIMENSIONS

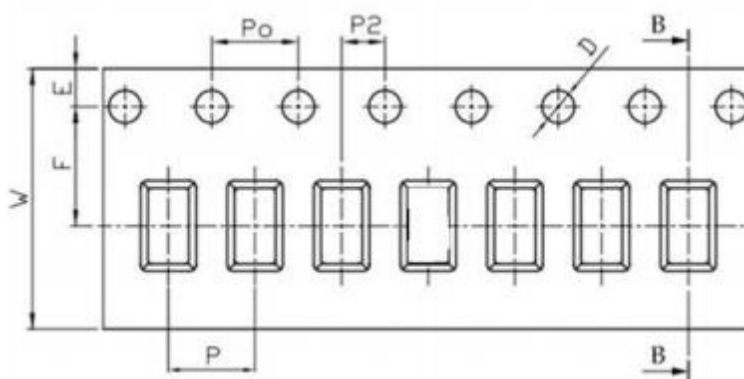

Feature	Specifications	Tolerances
W	8.00	±0.30
P	4.00	±0.10
E	1.75	±0.10
F	3.50	±0.10
P2	2.00	±0.10
D	1.50	+0.10 -0.00
P0	4.00	±0.10
10P0	40.00	±0.20

Quantity:5000pieces per 7 reel