



# FCC Radio Test Report

## FCC ID: 2APRB-WNVR-WNIP2

### Original Grant

**Report No.** : TB-FCC172675  
**Applicant** : Guangzhou Juan Intelligent Tech Joint Stock Co.,Ltd  
**Equipment Under Test (EUT)**  
**EUT Name** : Wireless Network Video Recorder  
**Model No.** : WNVR-WNIP2  
**Series Model No.** : WNIP2-4L1, CL-2WNP1-2L, CL-2WNP1-4L, CL-2WNP1-8L, WNIP21L-2-B, WNIP21L-4-B, WNIP21L-8-B  
**Brand Name** : NIGHT OWL  
**Receipt Date** : 2020-04-24  
**Test Date** : 2020-04-25 to 2020-05-22  
**Issue Date** : 2020-05-22  
**Standards** : FCC Part 15, Subpart C 15.247  
**Test Method** : ANSI C63.10: 2013  
**Conclusions** : **PASS**

In the configuration tested, the EUT complied with the standards specified above,  
The EUT technically complies with the FCC and IC requirements

**Test/Witness Engineer** :  Jack Deng  
**Engineer Supervisor** :  Ivan Su  
**Authorized Signatory** :  Ray Lai



This report details the results of the testing carried out on one sample. The results contained in this test report do not relate to other samples of the same product. The manufacturer should ensure that all products in series production are in conformity with the product sample detailed in the report.

## Contents

<b>CONTENTS.....</b>	<b>2</b>
<b>1. GENERAL INFORMATION ABOUT EUT .....</b>	<b>5</b>
1.1 Client Information.....	5
1.2 General Description of EUT (Equipment Under Test) .....	5
1.3 Block Diagram Showing the Configuration of System Tested.....	7
1.4 Description of Support Units .....	7
1.5 Description of Test Mode.....	8
1.6 Description of Test Software Setting .....	9
1.7 Measurement Uncertainty .....	10
1.8 Test Facility.....	10
<b>2. TEST SUMMARY .....</b>	<b>11</b>
<b>3. TEST SOFTWARE.....</b>	<b>11</b>
<b>4. TEST EQUIPMENT .....</b>	<b>12</b>
<b>5. CONDUCTED EMISSION TEST .....</b>	<b>13</b>
5.1 Test Standard and Limit.....	13
5.2 Test Setup.....	13
5.3 Test Procedure.....	14
5.4 Deviation From Test Standard.....	14
5.5 EUT Operating Mode .....	14
5.6 Test Data.....	14
<b>6. RADIATED EMISSION TEST .....</b>	<b>15</b>
6.1 Test Standard and Limit.....	15
6.2 Test Setup.....	16
6.3 Test Procedure.....	17
6.4 Deviation From Test Standard.....	18
6.5 EUT Operating Condition .....	18
6.6 Test Data.....	18
<b>7. RESTRICTED BANDS REQUIREMENT .....</b>	<b>19</b>
7.1 Test Standard and Limit.....	19
7.2 Test Setup.....	19
7.3 Test Procedure.....	20
7.4 Deviation From Test Standard.....	20
7.5 EUT Operating Condition .....	20
7.6 Test Data.....	20
<b>8. BANDWIDTH TEST .....</b>	<b>21</b>
8.1 Test Standard and Limit.....	21
8.2 Test Setup.....	21
8.3 Test Procedure.....	21
8.4 Deviation From Test Standard.....	21

---

8.5 EUT Operating Condition .....	21
8.6 Test Data.....	21
<b>9. PEAK OUTPUT POWER TEST.....</b>	<b>22</b>
9.1 Test Standard and Limit.....	22
9.2 Test Setup.....	22
9.3 Test Procedure.....	22
9.4 Deviation From Test Standard.....	22
9.5 EUT Operating Condition .....	22
9.6 Test Data.....	22
<b>10. POWER SPECTRAL DENSITY TEST .....</b>	<b>23</b>
10.1 Test Standard and Limit .....	23
10.2 Test Setup.....	23
10.3 Test Procedure.....	23
10.4 Deviation From Test Standard.....	23
10.5 EUT Operating Condition .....	23
10.6 Test Data.....	23
<b>11. ANTENNA REQUIREMENT.....</b>	<b>24</b>
11.1 Standard Requirement.....	24
11.2 Deviation From Test Standard.....	24
11.3 Antenna Connected Construction.....	24
<b>ATTACHMENT A-- CONDUCTED EMISSION TEST DATA .....</b>	<b>25</b>
<b>ATTACHMENT B-- RADIATED EMISSION TEST DATA .....</b>	<b>27</b>
<b>ATTACHMENT C-- RESTRICTED BANDS REQUIREMENT AND BAND-EDGE TEST DATA .....</b>	<b>53</b>
<b>ATTACHMENT D-- BANDWIDTH TEST DATA.....</b>	<b>77</b>
<b>ATTACHMENT E-- PEAK OUTPUT POWER TEST DATA.....</b>	<b>93</b>
<b>ATTACHMENT F-- POWER SPECTRAL DENSITY TEST DATA.....</b>	<b>97</b>

## Revision History

Report No.	Version	Description	Issued Date
TB-FCC172675	Rev.01	Initial issue of report	2020-05-22

# 1. General Information about EUT

## 1.1 Client Information

<b>Applicant</b>	:	Guangzhou Juan Intelligent Tech Joint Stock Co.,Ltd
<b>Address</b>	:	No.2 Plant ,West of Shanxi country , Dashi street, Panyu District, Guangzhou City, China
<b>Manufacturer</b>	:	Guangzhou Juan Intelligent Tech Joint Stock Co.,Ltd
<b>Address</b>	:	No.2 Plant ,West of Shanxi country , Dashi street, Panyu District, Guangzhou City, China

## 1.2 General Description of EUT (Equipment Under Test)

<b>EUT Name</b>	:	Wireless Network Video Recorder	
<b>Models No.</b>	:	WNVR-WNIP2, WNIP2-4L1, CL-2WNP1-2L, CL-2WNP1-4L, CL-2WNP1-8L, WNIP21L-2-B, WNIP21L-4-B, WNIP21L-8-B	
<b>Model Different</b>	:	All these model product are identical the same, for commercial use with different model number.	
<b>Product Description</b>	:	Operation Frequency:	802.11b/g/n(HT20): 2412MHz~2462MHz 802.11n(HT40): 2422MHz~2452MHz
		Number of Channel:	802.11b/g/n(HT20):11 channels see note(3) 802.11n(HT40): 7 channels see note(3)
		RF Output Power:	802.11b:18.373dBm 802.11g:18.377dBm 802.11n (HT20):18.265dBm 802.11n (HT40):18.265dBm
		Antenna Gain:	Please see Note(4)
		Modulation Type:	802.11b: DSSS(CCK, DQPSK, DBPSK) 802.11g/n:OFDM(BPSK,QPSK,16QAM,64QAM)
		Bit Rate of Transmitter:	Using 20MHz bandwidth, data rate up to 173.3 Mbps Using 40MHz bandwidth, data rate up to 400 Mbps
		<b>Power Rating</b>	:
<b>Software Version</b>	:	WNVR-WNIP2_20200420	
<b>Hardware Version</b>	:	Hi3536D_V125P	

**Note:**

- (1) This Test Report is FCC Part 15.247 for 802.11b/g/n, the test procedure follows the FCC KDB 558074 D01 v05r02 and KDB 662911 D01 Multiple Transmitter Output v02r01.
- (2) For a more detailed features description, please refer to the User's Manual.

(3) Channel List:

Channel	Frequency (MHz)	Channel	Frequency (MHz)	Channel	Frequency (MHz)
01	2412	05	2432	09	2452
02	2417	06	2437	10	2457
03	2422	07	2442	11	2462
04	2427	08	2447		

Note: CH 01~CH 11 for 802.11b/g/n(HT20)  
CH 03~CH 09 for 802.11n(HT40)

(4) Antenna information

Mode	TX Antenna (s)	Remark
802.11b	2	ANT. A+ ANT. B
802.11g	2	ANT. A+ ANT. B
802.11n(HT20)	2	ANT. A+ ANT. B
802.11n(HT40)	2	ANT. A+ ANT. B

Antenna	Brand	Type	Antenna Gain(dBi)
ANT. A	N/A	External Ant	5.0
ANT. B	N/A	External Ant	5.0

Note:  
For MIMO mode: Directional Gain=ANT. Gain+10\*LOG(N<sub>ANT</sub>) =8.01dBi  
2.4G working with 802.11b/g/n(HT20/HT40) has MIMO mode.

### 1.3 Block Diagram Showing the Configuration of System Tested

#### Conducted Test

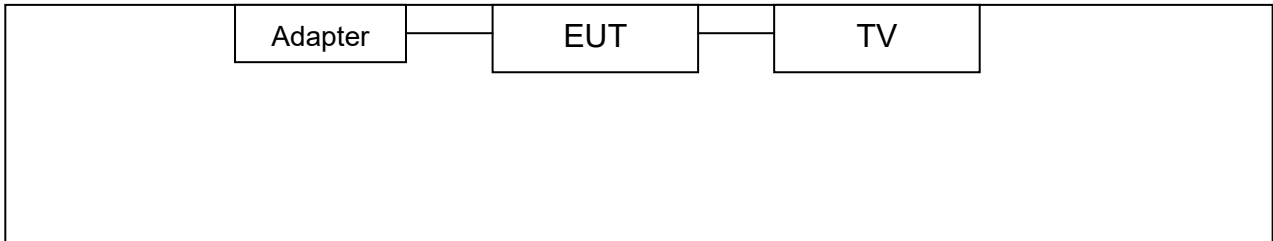

#### Radiated Test

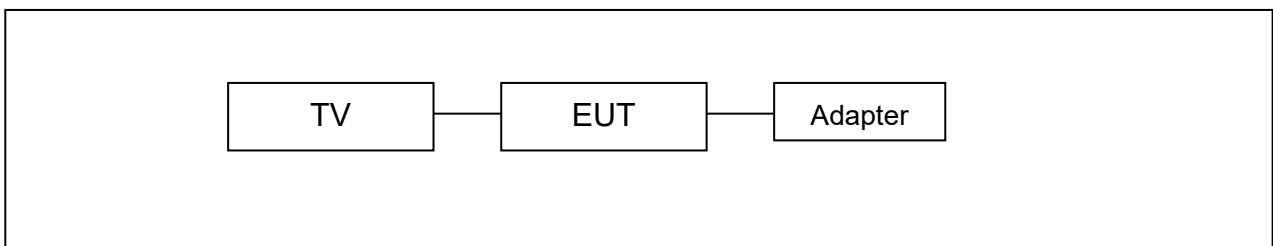

### 1.4 Description of Support Units

Name	Model	S/N	Manufacturer	Used “√”
TV	/	/	/	√
Adapter	CS-1202000			√

## 1.5 Description of Test Mode

To investigate the maximum EMI emission characteristics generates from EUT, the test system was pre-scanning tested base on the consideration of following EUT operation mode or test configuration mode which possible have effect on EMI emission level. Each of these EUT operation mode(s) or test configuration mode(s) mentioned follow was evaluated respectively.

For Conducted Test	
Final Test Mode	Description
Mode 1	Charging with TX B Mode
For Radiated and RF Conducted Test	
Final Test Mode	Description
Mode 2	TX Mode B Mode Channel 01/06/11
Mode 3	TX Mode G Mode Channel 01/06/11
Mode 4	TX Mode N(HT20) Mode Channel 01/06/11
Mode 5	TX Mode N(HT40) Mode Channel 03/06/09
<p><b>Note :</b> (1)The adapter and antenna gain provided by the applicant, the verified for the RF conduction test provided by TOBY test lab.</p> <p>(2)There are Only one prototypes of model WNVR-WNIP2 which are 20200401-20, For the Conducted Emission and Radiated test used the 20200401-20. For the RF Conduction test used the 20200401-20.</p>	

**Note:**

- (1) For all test, we have verified the construction and function in typical operation. And all the test modes were carried out with the EUT in transmitting operation in maximum power with all kinds of data rate.  
According to ANSI C63.10 standards, the measurements are performed at the highest, Middle, lowest available channels, and the worst case data rate as follows:
  - 802.11b Mode: CCK (1 Mbps)
  - 802.11g Mode: OFDM (6 Mbps)
  - 802.11n (HT20) Mode: MCS 0 (6.5 Mbps)
  - 802.11n (HT40) Mode: MCS 0 (30 Mbps)
- (2) During the testing procedure, the continuously transmitting with the maximum power mode was programmed by the customer.
- (3) The EUT is considered a Mobile device; in normal use it was positioned on X-plane. The worst case was found positioned on X-plane. Therefore only the test data of this X-plane was used for radiated emission measurement test.



## 1.6 Description of Test Software Setting

During testing channel & Power controlling software provided by the customer was used to control the operating channel as well as the output power level. The RF output power selection is for the setting of RF output power expected by the customer and is going to be fixed on the firmware of the final end product power parameters of WLAN.

<b>Test Software: Xshell</b>				
<b>Test Mode:</b> Continuously transmitting				
<b>Mode</b>	<b>Data Rate</b>	<b>Channel</b>	<b>Parameters</b>	
			<b>ANT. A</b>	<b>ANT. B</b>
<b>802.11b</b>	CCK/ 1Mbps	01	43	23
	CCK/ 1Mbps	06	44	23
	CCK/ 1Mbps	11	45	25
			<b>Parameters</b>	
			<b>ANT. A</b>	<b>ANT. B</b>
<b>802.11g</b>	OFDM/ 6Mbps	01	46	27
	OFDM/ 6Mbps	06	46	27
	OFDM/ 6Mbps	11	46	27
<b>802.11n(20)</b>	MCS 0	01	46	27
	MCS 0	06	46	27
	MCS 0	11	48	27
<b>802.11n(40)</b>	MCS 0	03	46	25
	MCS 0	06	46	25
	MCS 0	09	46	25
Note:(1) The report only showed the worst case.				

## 1.7 Measurement Uncertainty

The reported uncertainty of measurement  $y \pm U$ , where expanded uncertainty  $U$  is based on a standard uncertainty multiplied by a coverage factor of  $k=2$ , providing a level of confidence of approximately 95 %.

Test Item	Parameters	Expanded Uncertainty ( $U_{Lab}$ )
Conducted Emission	Level Accuracy: 9kHz~150kHz 150kHz to 30MHz	$\pm 3.50$ dB $\pm 3.10$ dB
Radiated Emission	Level Accuracy: 9kHz to 30 MHz	$\pm 4.60$ dB
Radiated Emission	Level Accuracy: 30MHz to 1000 MHz	$\pm 4.50$ dB
Radiated Emission	Level Accuracy: Above 1000MHz	$\pm 4.20$ dB

## 1.8 Test Facility

The testing was performed by the Shenzhen Toby Technology Co., Ltd., in their facilities located at: 1A/F., Bldg.6, Yusheng Industrial Zone, The National Road No.107 Xixiang Section 467, Xixiang, Bao'an, Shenzhen, Guangdong, China.

At the time of testing, the following bodies accredited the Laboratory:

### **CNAS (L5813)**

The Laboratory has been accredited by CNAS to ISO/IEC 17025: 2005 General Requirements for the Competence of Testing and Calibration Laboratories for the competence in the field of testing. And the Registration No.: CNAS L5813.

### **A2LA Certificate No.: 4750.01**

The laboratory has been accredited by American Association for Laboratory Accreditation(A2LA) to ISO/IEC 17025: 2005 General Requirements for the Competence of Testing and Calibration Laboratories for the technical competence in the field of Electrical Testing. And the A2LA Certificate No.: 4750.01.FCC Accredited Test Site Number: 854351.

### **IC Registration No.: (11950A-1)**

The Laboratory has been registered by Certification and Engineering Bureau of Industry Canada for radio equipment testing. The site registration: Site# 11950A-1.

## 2. Test Summary

FCC Part 15 Subpart C(15.247)			
Standard Section FCC	Test Item	Judgment	Remark
15.203	Antenna Requirement	PASS	N/A
15.207	Conducted Emission	PASS	N/A
15.205	Restricted Bands	PASS	N/A
15.247(a)(2)	6dB Bandwidth	PASS	N/A
15.247(b)	Peak Output Power	PASS	N/A
15.247(e)	Power Spectral Density	PASS	N/A
15.247(d)	Band Edge	PASS	N/A
15.247(d)&15.209	Transmitter Radiated Spurious Emission	PASS	N/A
<b>Note:</b> “/” for no requirement for this test item. N/A is an abbreviation for Not Applicable.			

## 3. Test Software

Test Item	Test Software	Manufacturer	Version No.
Conducted Emission	EZ-EMC	EZ	CDI-03A2
Radiation Emission	EZ-EMC	EZ	FA-03A2RE
RF Conducted Measurement	MTS-8310	MWRFtest	V2.0.0.0

## 4. Test Equipment

Conducted Emission Test					
Equipment	Manufacturer	Model No.	Serial No.	Last Cal.	Cal. Due Date
EMI Test Receiver	Rohde & Schwarz	ESCI	100321	Jul. 13, 2019	Jul. 12, 2020
RF Switching Unit	Compliance Direction Systems Inc	RSU-A4	34403	Jul. 13, 2019	Jul. 12, 2020
AMN	SCHWARZBECK	NNBL 8226-2	8226-2/164	Jul. 13, 2019	Jul. 12, 2020
LISN	Rohde & Schwarz	ENV216	101131	Jul. 13, 2019	Jul. 12, 2020
Radiation Emission Test					
Equipment	Manufacturer	Model No.	Serial No.	Last Cal.	Cal. Due Date
Spectrum Analyzer	Agilent	E4407B	MY45106456	Jul. 13, 2019	Jul. 12, 2020
EMI Test Receiver	Rohde & Schwarz	ESPI	100010/007	Jul. 13, 2019	Jul. 12, 2020
Spectrum Analyzer	Rohde & Schwarz	FSV40-N	102197	Mar.07, 2020	Mar. 06, 2021
Bilog Antenna	ETS-LINDGREN	3142E	00117537	Mar.01, 2020	Feb. 28, 2021
Horn Antenna	ETS-LINDGREN	3117	00143207	Mar.01, 2020	Feb. 28, 2021
Horn Antenna	ETS-LINDGREN	BBHA 9170	BBHA9170582	Mar.01, 2020	Feb. 28, 2021
Loop Antenna	SCHWARZBECK	FMZB 1519 B	1519B-059	Jul. 13, 2019	Jul. 12, 2020
Pre-amplifier	Sonoma	310N	185903	Mar.01, 2020	Feb. 28, 2021
Pre-amplifier	HP	8449B	3008A00849	Mar.01, 2020	Feb. 28, 2021
Pre-amplifier	SKET	LNPA_1840G-50	SK201904032	Jul. 27, 2019	Jul. 26, 2020
Cable	HUBER+SUHNER	100	SUCOFLEX	Mar.07, 2020	Mar. 06, 2021
Positioning Controller	ETS-LINDGREN	2090	N/A	N/A	N/A
Antenna Conducted Emission					
Equipment	Manufacturer	Model No.	Serial No.	Last Cal.	Cal. Due Date
Spectrum Analyzer	Agilent	E4407B	MY45106456	Jul. 13, 2019	Jul. 12, 2020
Spectrum Analyzer	Rohde & Schwarz	ESCI	100010/007	Jul. 13, 2019	Jul. 12, 2020
MXA Signal Analyzer	Agilent	N9020A	MY49100060	Sep. 16, 2019	Sep. 15, 2020
Vector Signal Generator	Agilent	N5182A	MY50141294	Sep. 16, 2019	Sep. 15, 2020
Analog Signal Generator	Agilent	N5181A	MY50141953	Sep. 16, 2019	Sep. 15, 2020
RF Power Sensor	DARE!! Instruments	RadiPowerRPR3006W	17100015SNO26	Sep. 16, 2019	Sep. 15, 2020
	DARE!! Instruments	RadiPowerRPR3006W	17100015SNO29	Sep. 16, 2019	Sep. 15, 2020
	DARE!! Instruments	RadiPowerRPR3006W	17100015SNO31	Sep. 16, 2019	Sep. 15, 2020
	DARE!! Instruments	RadiPowerRPR3006W	17100015SNO33	Sep. 16, 2019	Sep. 15, 2020

## 5. Conducted Emission Test

### 5.1 Test Standard and Limit

#### 5.1.1 Test Standard

FCC Part 15.207

#### 5.1.2 Test Limit

**Conducted Emission Test Limit**

Frequency	Maximum RF Line Voltage (dB $\mu$ V)	
	Quasi-peak Level	Average Level
150kHz~500kHz	66 ~ 56 *	56 ~ 46 *
500kHz~5MHz	56	46
5MHz~30MHz	60	50

Notes:

- (1) \*Decreasing linearly with logarithm of the frequency.
- (2) The lower limit shall apply at the transition frequencies.
- (3) The limit decrease in line with the logarithm of the frequency in the range of 0.15 to 0.50MHz.

### 5.2 Test Setup

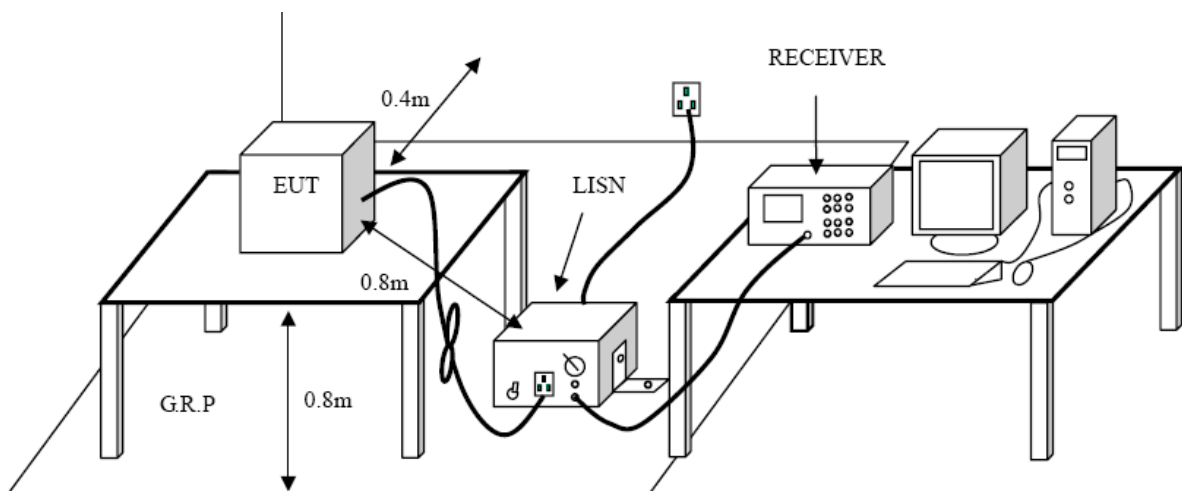

### 5.3 Test Procedure

- (1) The EUT was placed 0.8 meters from the horizontal ground plane with EUT being connected to the power mains through a line impedance stabilization network (LISN). All other support equipments powered from additional LISN(s). The LISN provide 50 Ohm/ 50uH of coupling impedance for the measuring instrument.
- (2) Interconnecting cables that hang closer than 40 cm to the ground plane shall be folded back and forth in the center forming a bundle 30 to 40 cm long.
- (3) I/O cables that are not connected to a peripheral shall be bundled in the center. The end of the cable may be terminated, if required, using the correct terminating impedance. The overall length shall not exceed 1 m.
- (4) LISN at least 80 cm from nearest part of EUT chassis.
- (5) The bandwidth of EMI test receiver is set at 9kHz, and the test frequency band is from 0.15MHz to 30MHz.

### 5.4 Deviation From Test Standard

No deviation

### 5.5 EUT Operating Mode

Please refer to the description of test mode.

### 5.6 Test Data

Please refer to the Attachment A.

## 6. Radiated Emission Test

### 6.1 Test Standard and Limit

#### 6.1.1 Test Standard

FCC Part 15.209

#### 6.1.2 Test Limit

#### Radiated Emission Limits ( 9 kHz~1000 MHz)

Frequency (MHz)	Field Strength (microvolt/meter)	Measurement Distance (meters)
0.009~0.490	2400/F(KHz)	300
0.490~1.705	24000/F(KHz)	30
1.705~30.0	30	30
30~88	100	3
88~216	150	3
216~960	200	3
Above 960	500	3

#### Radiated Emission Limit (Above 1000MHz)

Frequency (MHz)	Distance of 3m (dBuV/m)	
	Peak	Average
Above 1000	74	54

**Note:**

- (1) The tighter limit applies at the band edges.
- (2) Emission Level(dBuV/m)=20log Emission Level(uV/m)

6.2 Test Setup

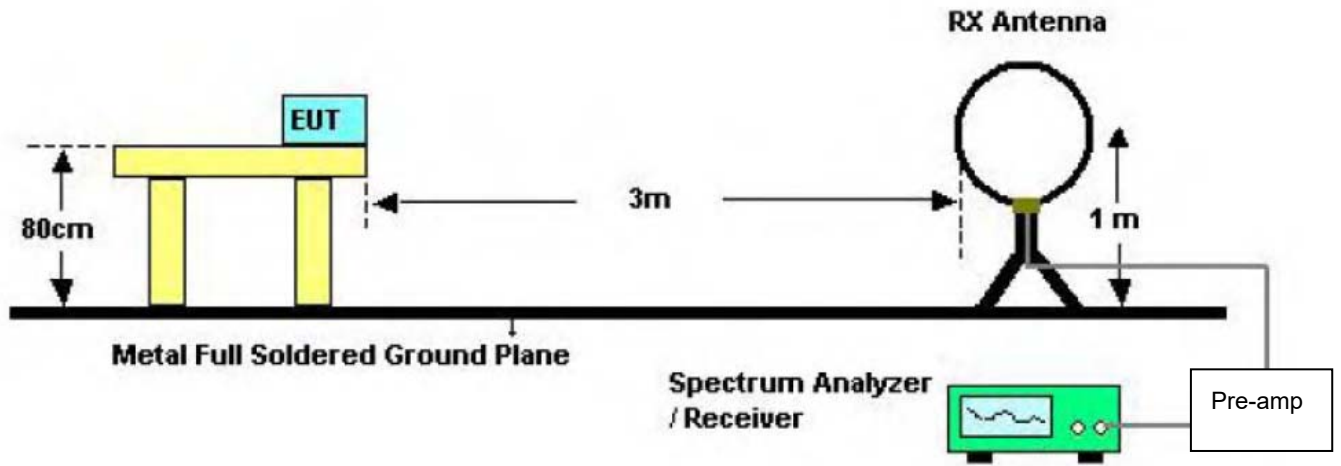

Below 30MHz Test Setup

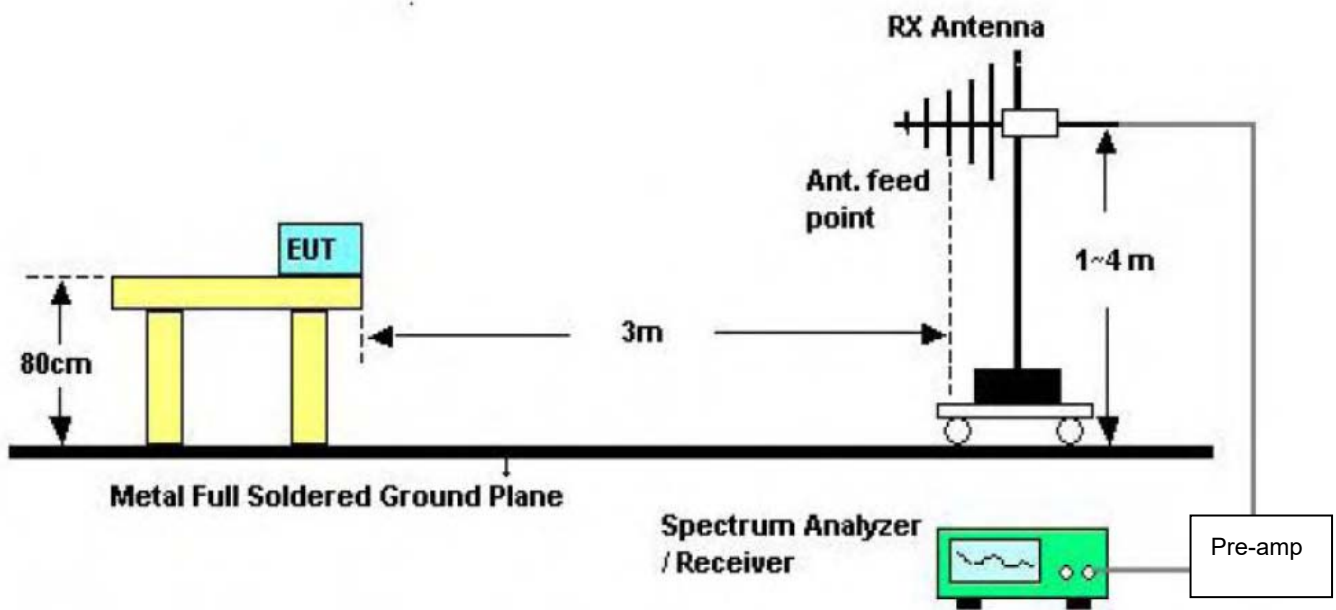

Below 1000MHz Test Setup



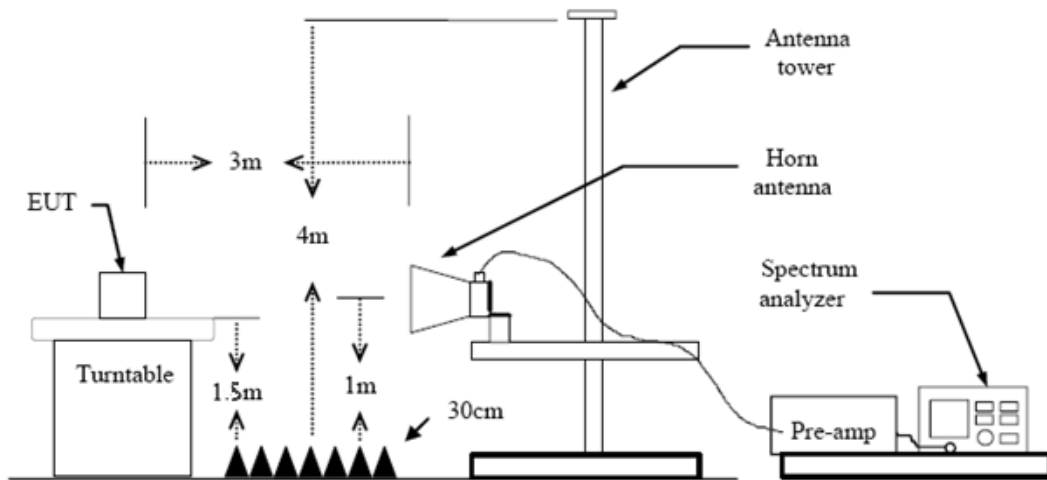

Above 1GHz Test Setup

### 6.3 Test Procedure

- (1) Measurements at frequency above 1GHz. The EUT was placed on a rotating 1.5m high above the ground. RF absorbers covered the ground plane with a minimum area of 3.0m by 3.0m between the EUT and measurement receiver antenna. The RF absorber shall not exceed 30cm in high above the conducting floor. The table was rotated 360 degrees to determine the position of the highest radiation.
- (2) Measurements at frequency Below 1GHz. The EUT was placed on a rotating 0.8m high above the ground. RF absorbers covered the ground plane with a minimum area of 3.0m by 3.0m between the EUT and measurement receiver antenna. The RF absorber shall not exceed 30cm in high above the conducting floor. The table was rotated 360 degrees to determine the position of the highest radiation.
- (3) The Test antenna shall vary between 1m and 4m, Both Horizontal and Vertical antenna are set to make measurement.
- (4) The initial step in collecting conducted emission data is a spectrum analyzer peak detector mode pre-scanning the measurement frequency range. Significant peaks are then marked and then Quasi Peak detector mode re-measured.
- (5) If the Peak Mode measured value compliance with and lower than Quasi Peak Mode Limit Bellow 1 GHz, the EUT shall be deemed to meet QP Limits and then no additional QP Mode measurement performed. But the Peak Value and average value both need to comply with applicable limit above 1 GHz.
- (6) Testing frequency range below 1GHz the measuring instrument use VBW=120 kHz with Quasi-peak detection.
- (7) Testing frequency range above 1GHz the measuring instrument use RBW=1 MHz and VBW=3 MHz with Peak Detector for Peak Values, and use RBW=1 MHz and VBW=10 Hz with Peak Detector for Average Values.
- (8) For the actual test configuration, please see the test setup photo.

#### 6.4 Deviation From Test Standard

No deviation

#### 6.5 EUT Operating Condition

The Equipment Under Test was set to Continual Transmitting in maximum power.

#### 6.6 Test Data

Remark: During testing above 1GHz the measuring instrument use RBW=1 MHz and VBW=3 MHz with Peak Detector for Peak Values, and use RBW=1 MHz and VBW=10 Hz with Peak Detector for Average Values.

Please refer to the Attachment B.

## 7. Restricted Bands Requirement

### 7.1 Test Standard and Limit

#### 7.1.1 Test Standard

FCC Part 15.247(d)  
FCC Part 15.209  
FCC Part 15.205

#### 7.1.2 Test Limit

Restricted Frequency Band (MHz)	Distance of 3m (dBuV/m)	
	Peak	Average
2310 ~2390	74	54
2483.5 ~2500	74	54

### 7.2 Test Setup

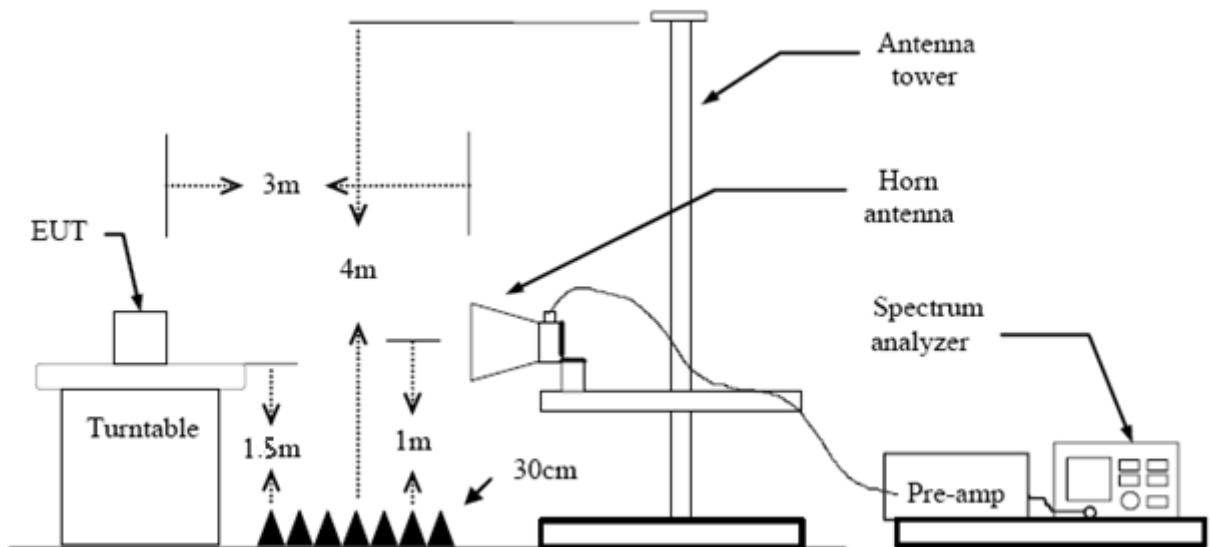

### 7.3 Test Procedure

- (1) The measuring distance of 3m shall be used for measurements at frequency Below 1GHz and above 1 GHz. The EUT was placed on a rotating 0.8m high above ground, the table was rotated 360 degrees to determine the position of the highest radiation.
- (2) Measurements at frequency above 1GHz. The EUT was placed on a rotating 1.5m high above the ground. RF absorbers covered the ground plane with a minimum area of 3.0m by 3.0m between the EUT and measurement receiver antenna. The RF absorber shall not exceed 30cm in high above the conducting floor. The table was rotated 360 degrees to determine the position of the highest radiation.
- (3) The Test antenna shall vary between 1m and 4m, Both Horizontal and Vertical antenna are set to make measurement.
- (4) The initial step in collecting conducted emission data is a spectrum analyzer peak detector mode pre-scanning the measurement frequency range. Significant peaks are then marked and then Quasi Peak detector mode re-measured.
- (5) If the Peak Mode measured value compliance with and lower than Quasi Peak Mode Limit Bellow 1 GHz, the EUT shall be deemed to meet QP Limits and then no additional QP Mode measurement performed. But the Peak Value and average value both need to comply with applicable limit above 1 GHz.
- (6) Testing frequency range below 1GHz the measuring instrument use VBW=120 kHz with Quasi-peak detection.
- (7) Testing frequency range above 1GHz the measuring instrument use RBW=1 MHz and VBW=3 MHz with Peak Detector for Peak Values, and use RBW=1 MHz and VBW=10 Hz with Peak Detector for Average Values.
- (8) For the actual test configuration, please see the test setup photo.

### 7.4 Deviation From Test Standard

No deviation

### 7.5 EUT Operating Condition

The Equipment Under Test was set to Continual Transmitting in maximum power.

### 7.6 Test Data

Please refer to the Attachment C.

## 8. Bandwidth Test

### 8.1 Test Standard and Limit

#### 8.1.1 Test Standard

FCC Part 15.247 (a)(2)

#### 8.1.2 Test Limit

FCC Part 15 Subpart C(15.247)		
Test Item	Limit	Frequency Range(MHz)
Bandwidth	$\geq 500$ KHz (6dB bandwidth)	2400~2483.5

### 8.2 Test Setup

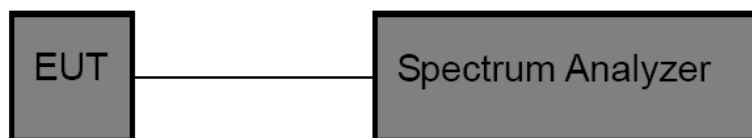

### 8.3 Test Procedure

- (1) The EUT was directly connected to the spectrum analyzer and antenna output port as show in the block diagram above.
- (2) The bandwidth is measured at an amplitude level reduced 6dB from the reference level. The reference level is the level of the highest amplitude signal observed from the transmitter at the fundamental frequency. Once the reference level is established, the equipment is conditioned with typical modulating signal to produce the worst –case (i.e the widest) bandwidth.
- (3) Measure the channel separation the spectrum analyzer was set to Resolution Bandwidth:100 kHz, and Video Bandwidth:300 kHz, Detector: Peak, Sweep Time set auto.

### 8.4 Deviation From Test Standard

No deviation

### 8.5 EUT Operating Condition

The EUT was set to continuously transmitting in each mode and low, Middle and high channel for the test.

### 8.6 Test Data

Please refer to the Attachment D.

## 9. Peak Output Power Test

### 9.1 Test Standard and Limit

#### 9.1.1 Test Standard

FCC Part 15.247 (b)

#### 9.1.2 Test Limit

FCC Part 15 Subpart C(15.247)		
Test Item	Limit	Frequency Range(MHz)
Peak Output Power	1 Watt or 30 dBm	2400~2483.5

### 9.2 Test Setup

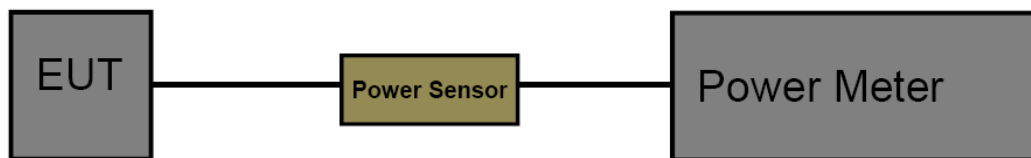

### 9.3 Test Procedure

The measurement is according to section 9.1.2 of KDB 558074 D01 v05r02.

The EUT was connected to RF power meter via a broadband power sensor as show the block above. The power sensor video bandwidth is greater than or equal to the DTS bandwidth of the equipment.

### 9.4 Deviation From Test Standard

No deviation

### 9.5 EUT Operating Condition

The EUT was set to continuously transmitting in the max power during the test.

### 9.6 Test Data

Please refer to the Attachment E.

## 10. Power Spectral Density Test

### 10.1 Test Standard and Limit

#### 10.1.1 Test Standard

FCC Part 15.247 (e)

#### 10.1.2 Test Limit

FCC Part 15 Subpart C(15.247)		
Test Item	Limit	Frequency Range(MHz)
Power Spectral Density	8dBm(in any 3 kHz)	2400~2483.5

### 10.2 Test Setup

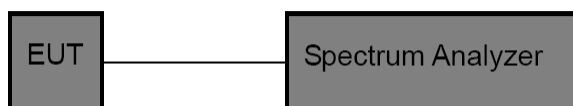

### 10.3 Test Procedure

The EUT was directly connected to the Spectrum Analyzer and antenna output port as show in the block diagram above. The measurement according to section 10.2 of KDB 558074 D01 D01 v05r02.

- (1) The EUT was directly connected to the spectrum analyzer and antenna output port as show in the block diagram above.
- (2) Set analyser centre frequency to DTS channel centre frequency.
- (3) Set the span to 1.5 times the DTS bandwidth.
- (4) Set the RBW to: 3 kHz
- (5) Set the VBW to: 10 kHz
- (6) Detector: peak
- (7) Sweep time: auto
- (8) Allow trace to fully stabilize. Then use the peak marker function to determine the maximum amplitude level.

### 10.4 Deviation From Test Standard

No deviation

### 10.5 EUT Operating Condition

The EUT was set to continuously transmitting in each mode and low, Middle and high channel for the test.

### 10.6 Test Data

Please refer to the Attachment F.

## 11. Antenna Requirement

### 11.1 Standard Requirement

#### 11.1.1 Standard

FCC Part 15.203

#### 11.1.2 Requirement

An intentional radiator shall be designed to ensure that no antenna other than that furnished by the responsible party shall be used with the device. The use of a permanently attached antenna or of an antenna that uses a unique coupling to the intentional radiator shall be considered sufficient to comply with the provisions of this Section. The manufacturer may design the unit so that a broken antenna can be replaced by the user, but the use of a standard antenna jack or electrical connector is prohibited.

### 11.2 Deviation From Test Standard

No deviation

### 11.3 Antenna Connected Construction

The gains of the antenna used for transmitting is 5.0 dBi, and the antenna de-signed with permanent attachment and no consideration of replacement. Please see the EUT photo for details.

#### Result

The EUT antenna is a copper tube Antenna. It complies with the standard requirement.

Antenna Type
<input type="checkbox"/> Permanent attached antenna
<input checked="" type="checkbox"/> Unique connector antenna
<input type="checkbox"/> Professional installation antenna



## Attachment A-- Conducted Emission Test Data

Remark: All channels have been tested and Shows only the worst channels.

<b>Temperature:</b>	23.5°C	<b>Relative Humidity:</b>	45%
<b>Test Voltage:</b>	AC 120V/60Hz		
<b>Terminal:</b>	Line		
<b>Test Mode:</b>	Mode 1		
<b>Remark:</b>	Only worst case is reported		

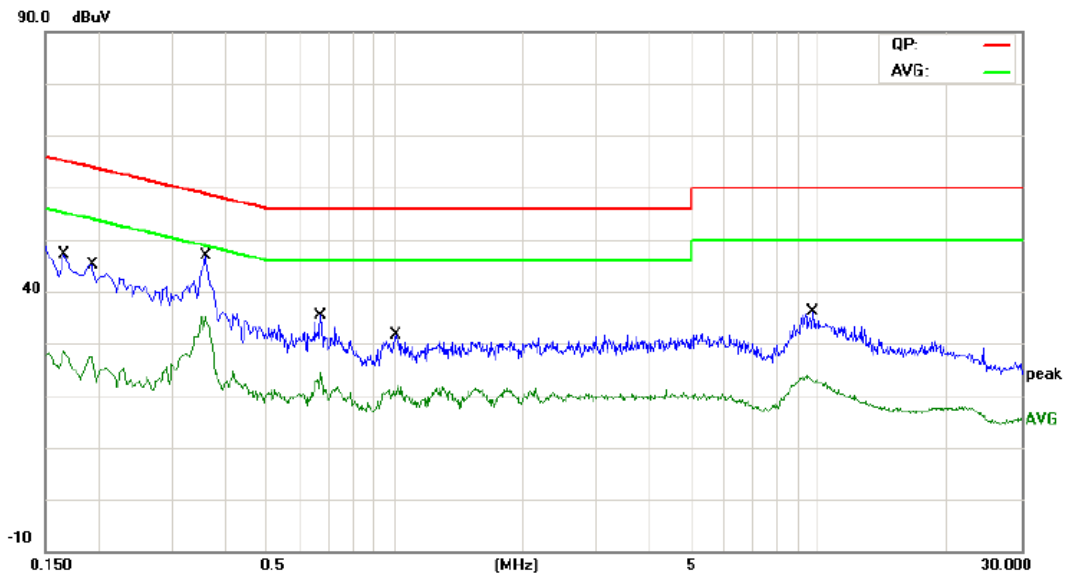

No.	Mk.	Freq.	Reading Level	Correct Factor	Measurement	Limit	Over	Detector
		MHz	dBuV	dB	dBuV	dBuV	dB	
1		0.1660	34.18	9.78	43.96	65.15	-21.19	QP
2		0.1660	17.40	9.78	27.18	55.15	-27.97	AVG
3		0.1940	32.01	9.78	41.79	63.86	-22.07	QP
4		0.1940	15.66	9.78	25.44	53.86	-28.42	AVG
5		0.3580	30.22	9.83	40.05	58.77	-18.72	QP
6	*	0.3580	23.84	9.83	33.67	48.77	-15.10	AVG
7		0.6700	17.97	9.85	27.82	56.00	-28.18	QP
8		0.6700	12.74	9.85	22.59	46.00	-23.41	AVG
9		1.0100	16.55	9.66	26.21	56.00	-29.79	QP
10		1.0100	10.98	9.66	20.64	46.00	-25.36	AVG
11		9.6580	18.26	9.82	28.08	60.00	-31.92	QP
12		9.6580	12.55	9.82	22.37	50.00	-27.63	AVG

Remark:

1. Corr. Factor (dB) = LISN Factor (dB) + Cable Loss (dB)

2. Margin (dB) = QuasiPeak/Average (dBuV) - Limit (dBuV)

Temperature:	23.5°C	Relative Humidity:	45%
Test Voltage:	AC 120V/60Hz		
Terminal:	Neutral		
Test Mode:	Mode 1		
Remark:	Only worst case is reported		

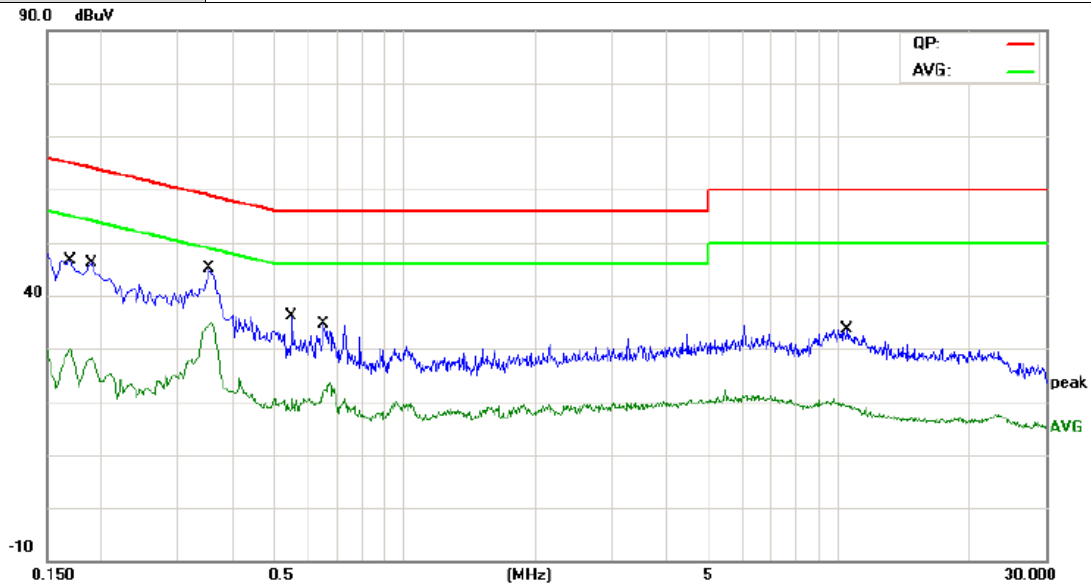

No.	Mk.	Freq. MHz	Reading Level dBuV	Correct Factor dB	Measure- ment dBuV	Limit dBuV	Over dB	Detector
1		0.1700	34.03	9.62	43.65	64.96	-21.31	QP
2		0.1700	17.04	9.62	26.66	54.96	-28.30	AVG
3		0.1900	32.25	9.58	41.83	64.03	-22.20	QP
4		0.1900	16.14	9.58	25.72	54.03	-28.31	AVG
5		0.3540	30.13	9.73	39.86	58.87	-19.01	QP
6	*	0.3540	23.34	9.73	33.07	48.87	-15.80	AVG
7		0.5500	15.73	9.78	25.51	56.00	-30.49	QP
8		0.5500	8.42	9.78	18.20	46.00	-27.80	AVG
9		0.6540	18.39	9.77	28.16	56.00	-27.84	QP
10		0.6540	11.76	9.77	21.53	46.00	-24.47	AVG
11		10.4900	15.90	9.86	25.76	60.00	-34.24	QP
12		10.4900	8.45	9.86	18.31	50.00	-31.69	AVG

Remark:

1. Corr. Factor (dB) = LISN Factor (dB) + Cable Loss (dB)
2. Margin (dB) = QuasiPeak/Average (dBuV) - Limit (dBuV)

## Attachment B-- Radiated Emission Test Data

### 9KHz~150KHz

From 9KHz to 30MHz: Conclusion: PASS

Note: The amplitude of spurious emissions which are attenuated by more than 20dB below the permissible value has no need to be reported.

### 30MHz~1GHz

Temperature:	23.5°C	Relative Humidity:	40%
Test Voltage:	AC 120V/60HZ		
Ant. Pol.	Horizontal		
Test Mode:	TX B Mode 2412MHz		
Remark:	Only worst case is reported.		

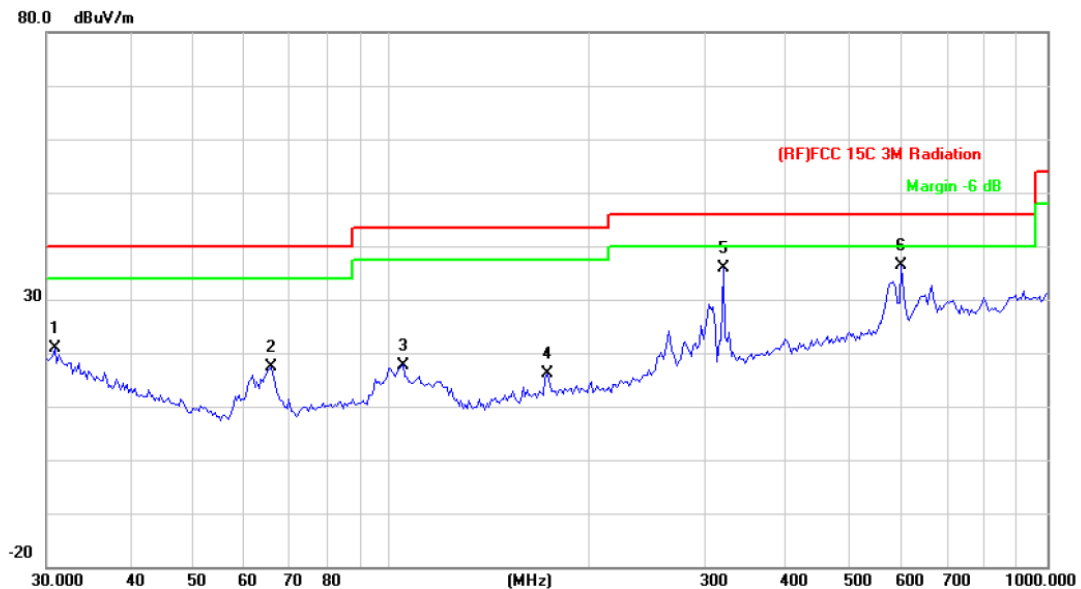

No.	Mk.	Freq.	Reading Level	Correct Factor	Measurement	Limit	Over	Detector
		MHz	dBuV	dB/m	dBuV/m	dBuV/m	dB	
1		30.8535	34.45	-13.64	20.81	40.00	-19.19	QP
2		65.8031	41.26	-23.94	17.32	40.00	-22.68	QP
3		104.5361	40.04	-22.29	17.75	43.50	-25.75	QP
4		173.2051	36.42	-20.37	16.05	43.50	-27.45	QP
5		321.0608	51.11	-15.32	35.79	46.00	-10.21	QP
6	*	599.3212	44.51	-8.18	36.33	46.00	-9.67	QP

\*:Maximum data    x:Over limit    !:over margin

**Remark:**

1. Corr. = Antenna Factor (dB/m) + Cable Loss (dB)
2. QuasiPeak (dBμV/m)= Corr. (dB/m)+ Read Level (dBμV)
3. Margin (dB) = QuasiPeak (dBμV/m)-Limit QPK(dBμV/m)

Temperature:	23.5°C	Relative Humidity:	40%
Test Voltage:	AC 120V/60HZ		
Ant. Pol.	Vertical		
Test Mode:	TX B Mode 2412MHz		
Remark:	Only worst case is reported.		

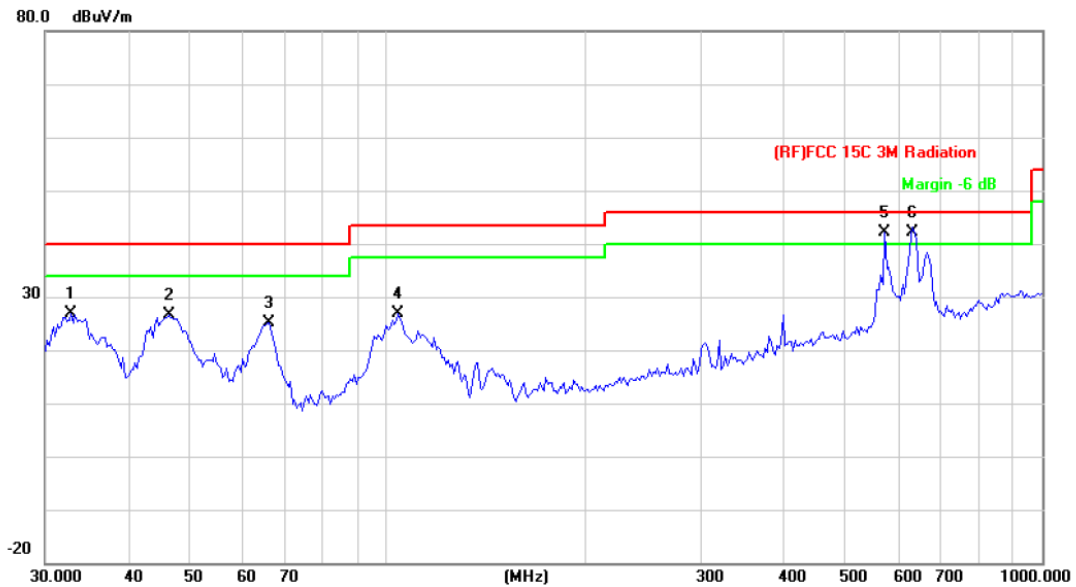

No.	Mk.	Freq. MHz	Reading Level dBuV	Correct Factor dB/m	Measure- ment dBuV/m	Limit dBuV/m	Over dB	Detector
1		32.8637	42.02	-15.17	26.85	40.00	-13.15	QP
2		46.3402	48.85	-22.12	26.73	40.00	-13.27	QP
3		65.8031	49.15	-23.94	25.21	40.00	-14.79	QP
4		103.8055	49.11	-22.26	26.85	43.50	-16.65	QP
5	!	574.6258	50.53	-8.50	42.03	46.00	-3.97	QP
6	*	633.9073	50.14	-7.94	42.20	46.00	-3.80	QP

\*:Maximum data    x:Over limit    !:over margin

**Remark:**

1. Corr. = Antenna Factor (dB/m) + Cable Loss (dB)
2. QuasiPeak (dBμV/m)= Corr. (dB/m)+ Read Level (dBμV)
3. Margin (dB) = QuasiPeak (dBμV/m)-Limit QPK(dBμV/m)

**Above 1GHz**

<b>Temperature:</b>	23.4°C	<b>Relative Humidity:</b>	35%
<b>Test Voltage:</b>	AC 120V/60 Hz		
<b>Ant. Pol.</b>	Horizontal		
<b>Test Mode:</b>	TX B Mode 2412MHz ANT. A+ANT. B		
<b>Remark:</b>	No report for the emission which more than 15dB below the prescribed limit.		

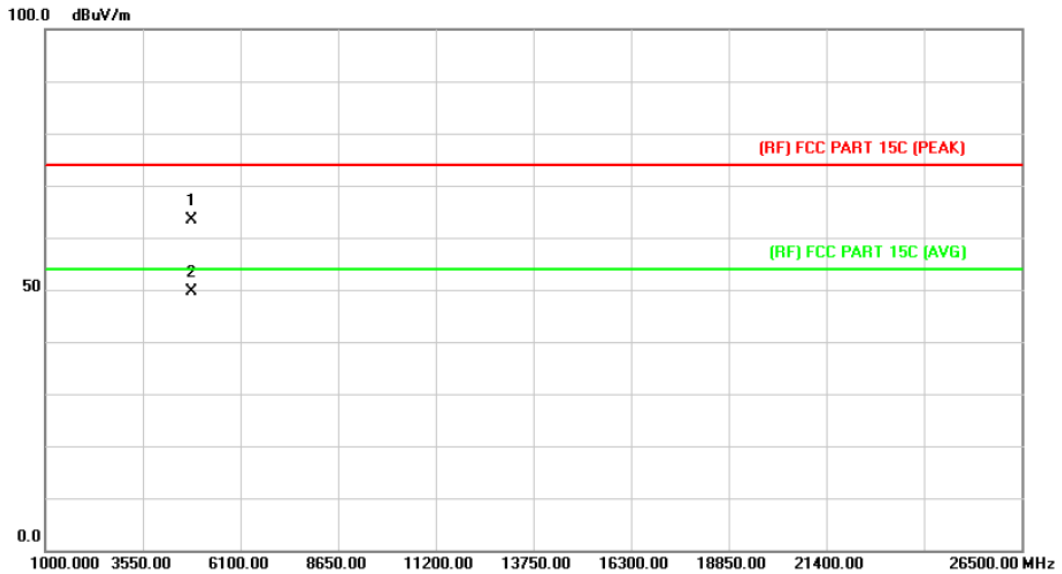

No.	Mk.	Freq.	Reading Level	Correct Factor	Measurement	Limit	Over	Detector
		MHz	dBuV	dB/m	dBuV/m	dBuV/m	dB	
1		4823.790	47.82	15.65	63.47	74.00	-10.53	peak
2	*	4823.790	33.86	15.65	49.51	54.00	-4.49	AVG

**Remark:**

1. Corr. = Antenna Factor (dB/m) + Cable Loss (dB)
2. Peak/AVG (dBμV/m)= Corr. (dB/m)+ Read Level (dBμV)
3. Margin (dB) = Peak/AVG (dBμV/m)-Limit PK/AVG(dBμV/m)

<b>Temperature:</b>	23.4°C	<b>Relative Humidity:</b>	35%
<b>Test Voltage:</b>	AC 120V/60 Hz		
<b>Ant. Pol.</b>	Vertical		
<b>Test Mode:</b>	TX B Mode 2412MHz ANT. A+ANT. B		
<b>Remark:</b>	No report for the emission which more than 15dB below the prescribed limit.		

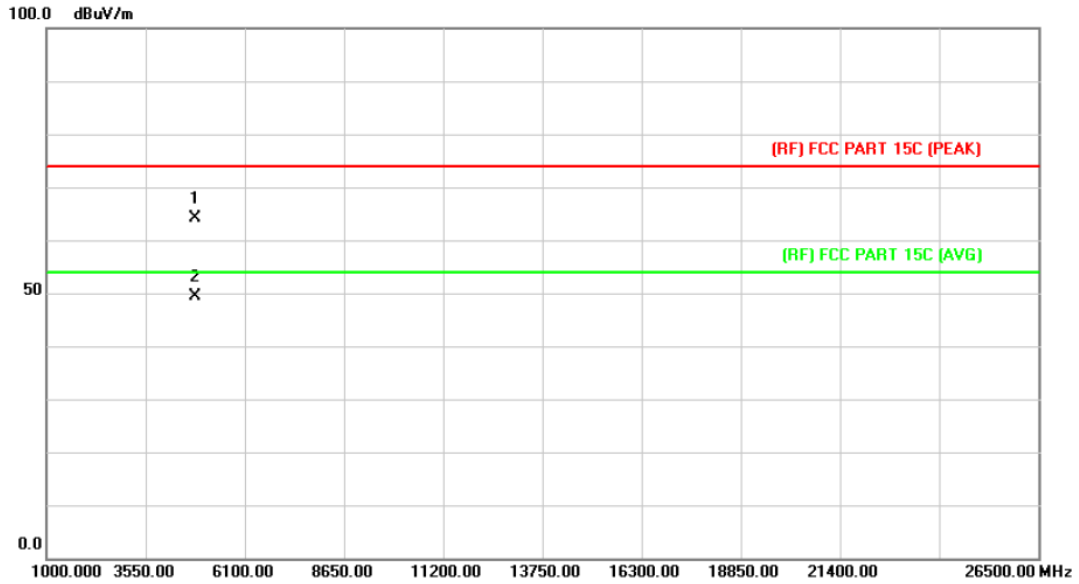

No.	Mk.	Freq.	Reading Level	Correct Factor	Measurement	Limit	Over	Detector
		MHz	dBuV	dB/m	dBuV/m	dBuV/m	dB	
1		4824.090	48.57	15.65	64.22	74.00	-9.78	peak
2	*	4825.218	33.82	15.66	49.48	54.00	-4.52	AVG

**Remark:**

1. Corr. = Antenna Factor (dB/m) + Cable Loss (dB)
2. Peak/AVG (dBuV/m) = Corr. (dB/m) + Read Level (dBuV)
3. Margin (dB) = Peak/AVG (dBuV/m) - Limit PK/AVG (dBuV/m)

<b>Temperature:</b>	23.4°C	<b>Relative Humidity:</b>	35%
<b>Test Voltage:</b>	AC 120V/60 Hz		
<b>Ant. Pol.</b>	Horizontal		
<b>Test Mode:</b>	TX B Mode 2437MHz ANT. A+ANT. B		
<b>Remark:</b>	No report for the emission which more than 15dB below the prescribed limit.		

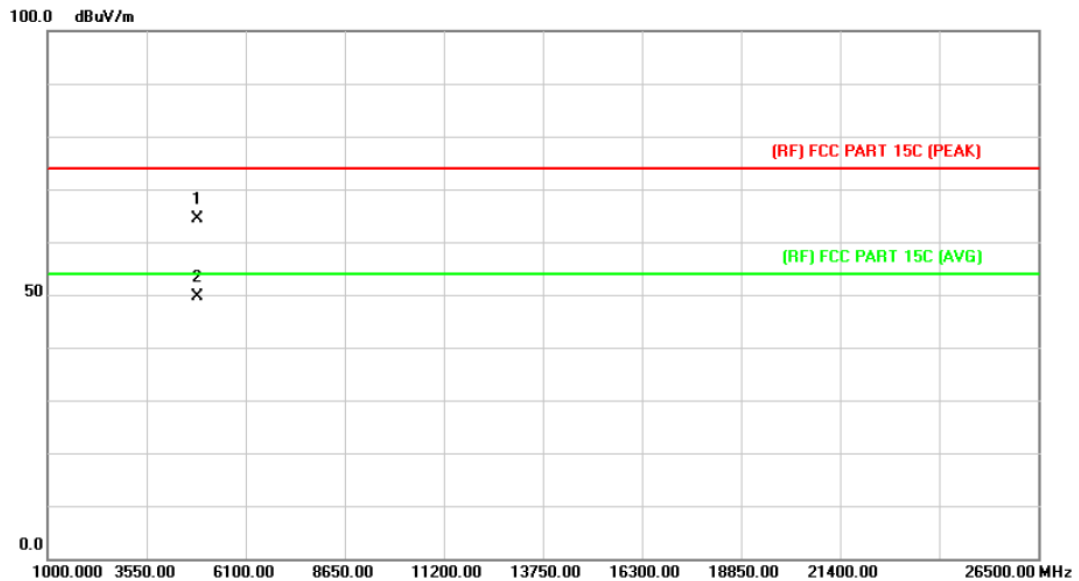

No.	Mk.	Freq.	Reading Level	Correct Factor	Measurement	Limit	Over	Detector
		MHz	dBuV	dB/m	dBuV/m	dBuV/m	dB	
1		4874.630	48.38	15.88	64.26	74.00	-9.74	peak
2	*	4874.630	33.70	15.88	49.58	54.00	-4.42	AVG

**Remark:**

1. Corr. = Antenna Factor (dB/m) + Cable Loss (dB)
2. Peak/AVG (dBμV/m) = Corr. (dB/m) + Read Level (dBμV)
3. Margin (dB) = Peak/AVG (dBμV/m) - Limit PK/AVG (dBμV/m)

<b>Temperature:</b>	23.4°C	<b>Relative Humidity:</b>	35%
<b>Test Voltage:</b>	AC 120V/60 Hz		
<b>Ant. Pol.</b>	Vertical		
<b>Test Mode:</b>	TX B Mode 2437MHz ANT. A+ANT. B		
<b>Remark:</b>	No report for the emission which more than 15dB below the prescribed limit.		

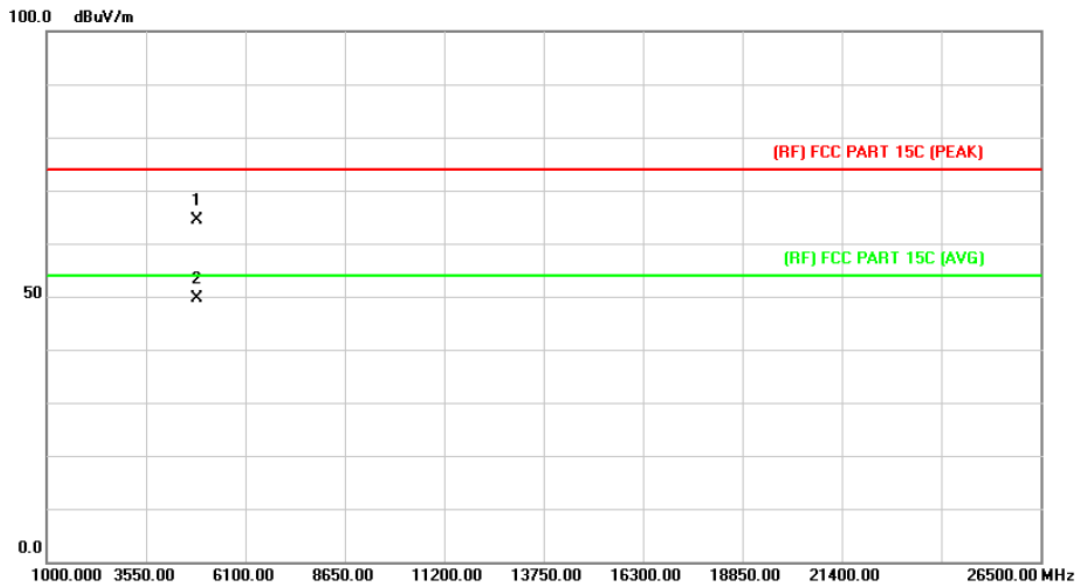

No.	Mk.	Freq.	Reading Level	Correct Factor	Measurement	Limit	Over	Detector
		MHz	dBuV	dB/m	dBuV/m	dBuV/m	dB	
1		4874.546	48.41	15.88	64.29	74.00	-9.71	peak
2	*	4874.546	33.71	15.88	49.59	54.00	-4.41	AVG

**Remark:**

1. Corr. = Antenna Factor (dB/m) + Cable Loss (dB)
2. Peak/AVG (dBuV/m) = Corr. (dB/m) + Read Level (dBuV)
3. Margin (dB) = Peak/AVG (dBuV/m) - Limit PK/AVG (dBuV/m)



<b>Temperature:</b>	23.4°C	<b>Relative Humidity:</b>	35%
<b>Test Voltage:</b>	AC 120V/60 Hz		
<b>Ant. Pol.</b>	Horizontal		
<b>Test Mode:</b>	TX B Mode 2462MHz ANT. A+ANT. B		
<b>Remark:</b>	No report for the emission which more than 15dB below the prescribed limit.		

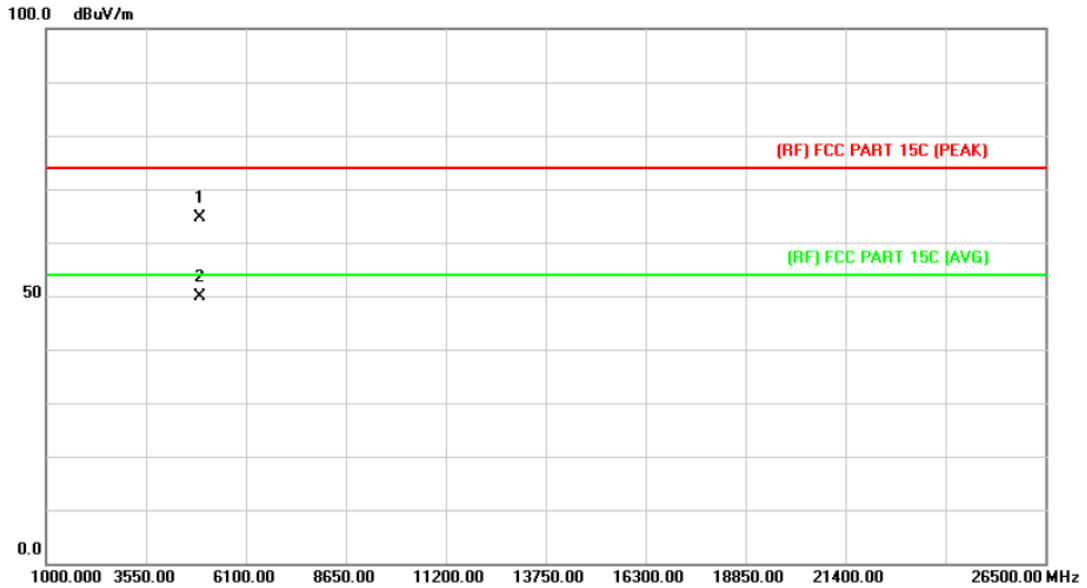

No.	Mk.	Freq.	Reading Level	Correct Factor	Measurement	Limit	Over	Detector
		MHz	dBuV	dB/m	dBuV/m	dBuV/m	dB	
1		4924.882	48.51	16.11	64.62	74.00	-9.38	peak
2	*	4924.882	33.84	16.11	49.95	54.00	-4.05	AVG

**Remark:**

1. Corr. = Antenna Factor (dB/m) + Cable Loss (dB)
2. Peak/AVG (dBuV/m) = Corr. (dB/m) + Read Level (dBuV)
3. Margin (dB) = Peak/AVG (dBuV/m) - Limit PK/AVG (dBuV/m)

<b>Temperature:</b>	23.4°C	<b>Relative Humidity:</b>	35%
<b>Test Voltage:</b>	AC 120V/60 Hz		
<b>Ant. Pol.</b>	Vertical		
<b>Test Mode:</b>	TX B Mode 2462MHz ANT. A+ANT. B		
<b>Remark:</b>	No report for the emission which more than 15dB below the prescribed limit.		

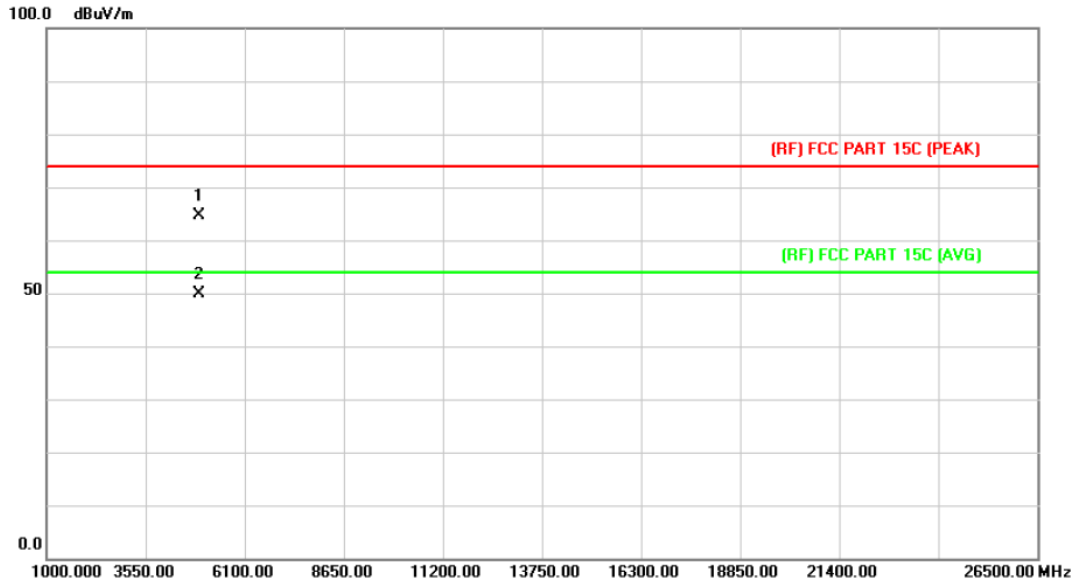

No.	Mk.	Freq. MHz	Reading Level dBuV	Correct Factor dB/m	Measure- ment dBuV/m	Limit dBuV/m	Over dB	Detector
1		4923.142	48.64	16.10	64.74	74.00	-9.26	peak
2	*	4923.142	33.87	16.10	49.97	54.00	-4.03	AVG

**Remark:**

1. Corr. = Antenna Factor (dB/m) + Cable Loss (dB)
2. Peak/AVG (dBuV/m) = Corr. (dB/m) + Read Level (dBuV)
3. Margin (dB) = Peak/AVG (dBuV/m) - Limit PK/AVG (dBuV/m)

<b>Temperature:</b>	23.4°C	<b>Relative Humidity:</b>	35%
<b>Test Voltage:</b>	AC 120V/60 Hz		
<b>Ant. Pol.</b>	Horizontal		
<b>Test Mode:</b>	TX G Mode 2412MHz ANT. A+ANT. B		
<b>Remark:</b>	No report for the emission which more than 15dB below the prescribed limit.		

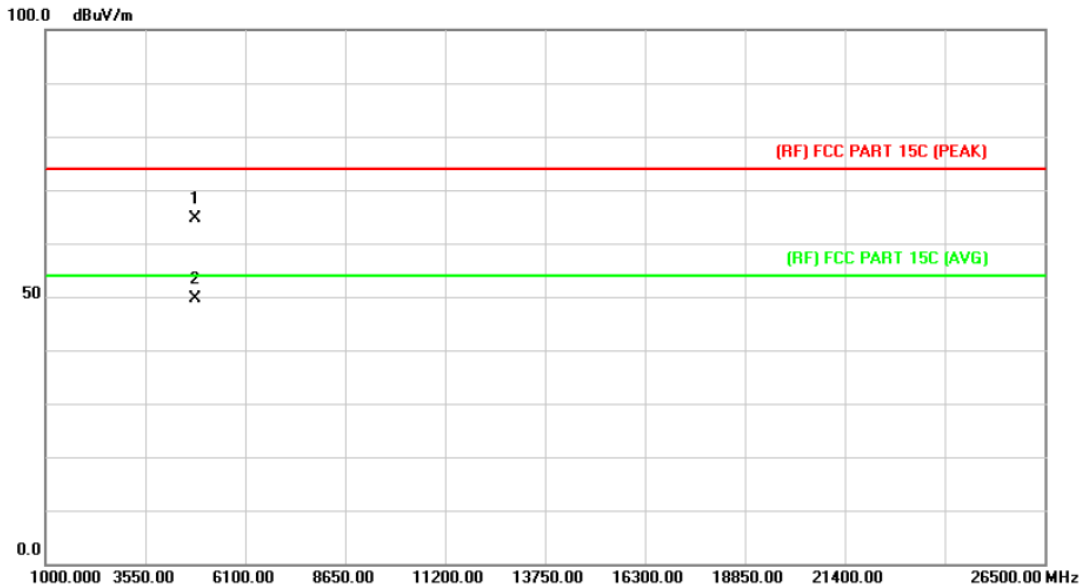

No.	Mk.	Freq.	Reading Level	Correct Factor	Measurement	Limit	Over	Detector
		MHz	dBuV	dB/m	dBuV/m	dBuV/m	dB	
1		4823.142	48.90	15.65	64.55	74.00	-9.45	peak
2	*	4823.142	34.10	15.65	49.75	54.00	-4.25	AVG

**Remark:**

1. Corr. = Antenna Factor (dB/m) + Cable Loss (dB)
2. Peak/AVG (dBμV/m) = Corr. (dB/m) + Read Level (dBμV)
3. Margin (dB) = Peak/AVG (dBμV/m) - Limit PK/AVG (dBμV/m)

<b>Temperature:</b>	23.4°C	<b>Relative Humidity:</b>	35%
<b>Test Voltage:</b>	AC 120V/60 Hz		
<b>Ant. Pol.</b>	Vertical		
<b>Test Mode:</b>	TX G Mode 2412MHz ANT. A+ANT. B		
<b>Remark:</b>	No report for the emission which more than 15dB below the prescribed limit.		

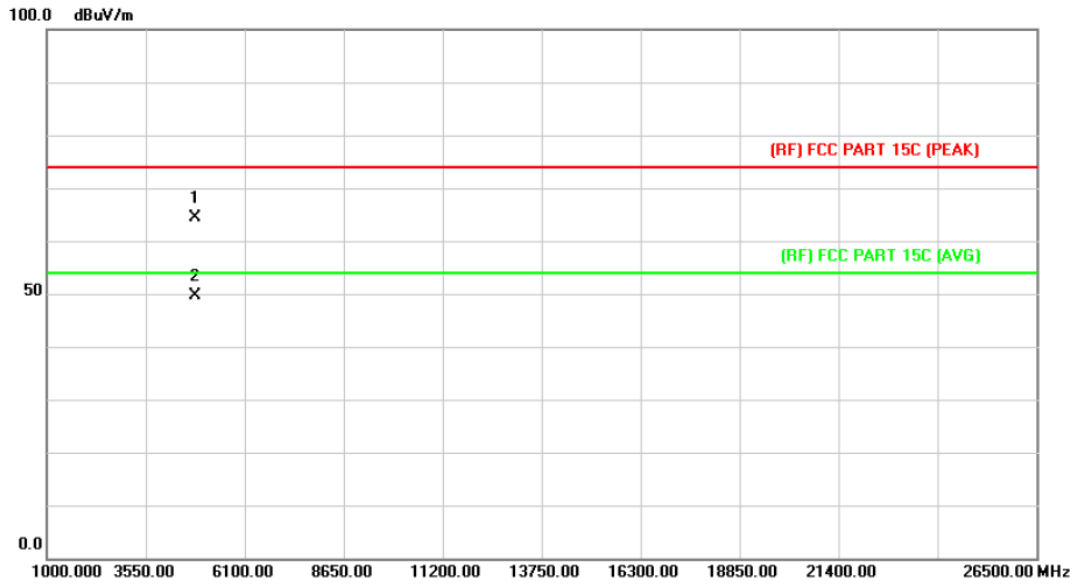

No.	Mk.	Freq. MHz	Reading Level dBuV	Correct Factor dB/m	Measure- ment dBuV/m	Limit dBuV/m	Over dB	Detector
1		4823.676	48.83	15.65	64.48	74.00	-9.52	peak
2	*	4823.676	34.04	15.65	49.69	54.00	-4.31	AVG

**Remark:**

1. Corr. = Antenna Factor (dB/m) + Cable Loss (dB)
2. Peak/AVG (dBuV/m) = Corr. (dB/m) + Read Level (dBuV)
3. Margin (dB) = Peak/AVG (dBuV/m) - Limit PK/AVG (dBuV/m)

<b>Temperature:</b>	23.4°C	<b>Relative Humidity:</b>	35%
<b>Test Voltage:</b>	AC 120V/60 Hz		
<b>Ant. Pol.</b>	Horizontal		
<b>Test Mode:</b>	TX G Mode 2437MHz ANT. A. +ANT. B.		
<b>Remark:</b>	No report for the emission which more than 15dB below the prescribed limit.		

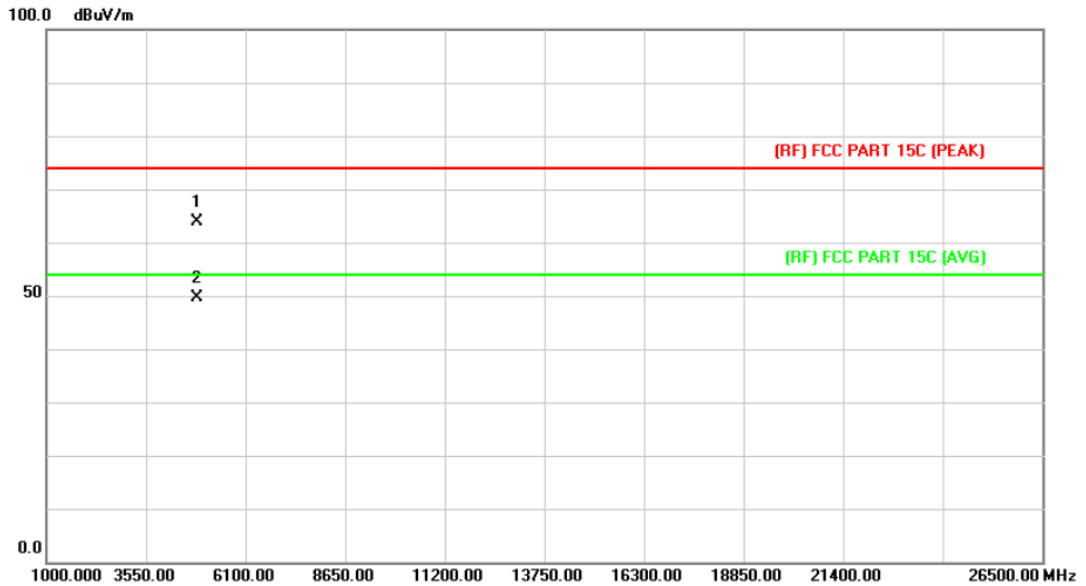

No.	Mk.	Freq.	Reading Level	Correct Factor	Measurement	Limit	Over	Detector
		MHz	dBuV	dB/m	dBuV/m	dBuV/m	dB	
1		4873.184	48.13	15.87	64.00	74.00	-10.00	peak
2	*	4873.184	33.74	15.87	49.61	54.00	-4.39	AVG

**Remark:**

1. Corr. = Antenna Factor (dB/m) + Cable Loss (dB)
2. Peak/AVG (dBμV/m) = Corr. (dB/m) + Read Level (dBμV)
3. Margin (dB) = Peak/AVG (dBμV/m) - Limit PK/AVG (dBμV/m)

<b>Temperature:</b>	23.4°C	<b>Relative Humidity:</b>	35%
<b>Test Voltage:</b>	AC 120V/60 Hz		
<b>Ant. Pol.</b>	Vertical		
<b>Test Mode:</b>	TX G Mode 2437MHz ANT. A. +ANT. B.		
<b>Remark:</b>	No report for the emission which more than 15dB below the prescribed limit.		

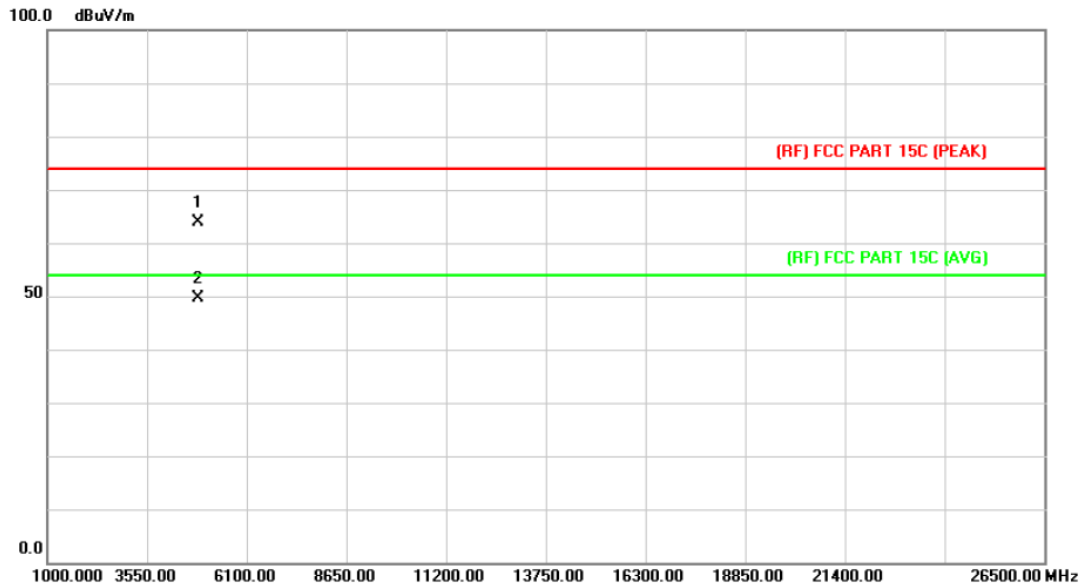

No.	Mk.	Freq.	Reading Level	Correct Factor	Measurement	Limit	Over	Detector
		MHz	dBuV	dB/m	dBuV/m	dBuV/m	dB	
1		4874.936	48.08	15.88	63.96	74.00	-10.04	peak
2	*	4874.936	33.70	15.88	49.58	54.00	-4.42	AVG

**Remark:**

1. Corr. = Antenna Factor (dB/m) + Cable Loss (dB)
2. Peak/AVG (dBμV/m) = Corr. (dB/m) + Read Level (dBμV)
3. Margin (dB) = Peak/AVG (dBμV/m) - Limit PK/AVG (dBμV/m)

<b>Temperature:</b>	23.4°C	<b>Relative Humidity:</b>	35%
<b>Test Voltage:</b>	AC 120V/60 Hz		
<b>Ant. Pol.</b>	Horizontal		
<b>Test Mode:</b>	TX G Mode 2462MHz ANT. A.+ANT. B.		
<b>Remark:</b>	No report for the emission which more than 15dB below the prescribed limit.		

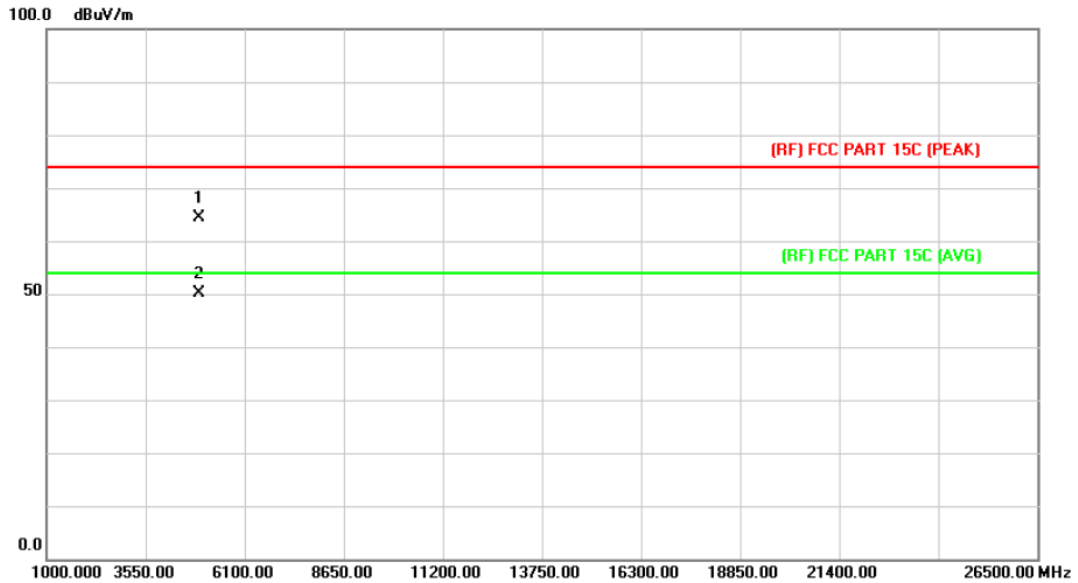

No.	Mk.	Freq. MHz	Reading Level dBuV	Correct Factor dB/m	Measure- ment dBuV/m	Limit dBuV/m	Over dB	Detector
1		4923.796	48.19	16.10	64.29	74.00	-9.71	peak
2	*	4923.796	34.05	16.10	50.15	54.00	-3.85	AVG

**Remark:**

1. Corr. = Antenna Factor (dB/m) + Cable Loss (dB)
2. Peak/AVG (dBuV/m) = Corr. (dB/m) + Read Level (dBuV)
3. Margin (dB) = Peak/AVG (dBuV/m) - Limit PK/AVG (dBuV/m)

<b>Temperature:</b>	23.4°C	<b>Relative Humidity:</b>	35%
<b>Test Voltage:</b>	AC 120V/60 Hz		
<b>Ant. Pol.</b>	Vertical		
<b>Test Mode:</b>	TX G Mode 2462MHz ANT. A. +ANT. B		
<b>Remark:</b>	No report for the emission which more than 15dB below the prescribed limit.		

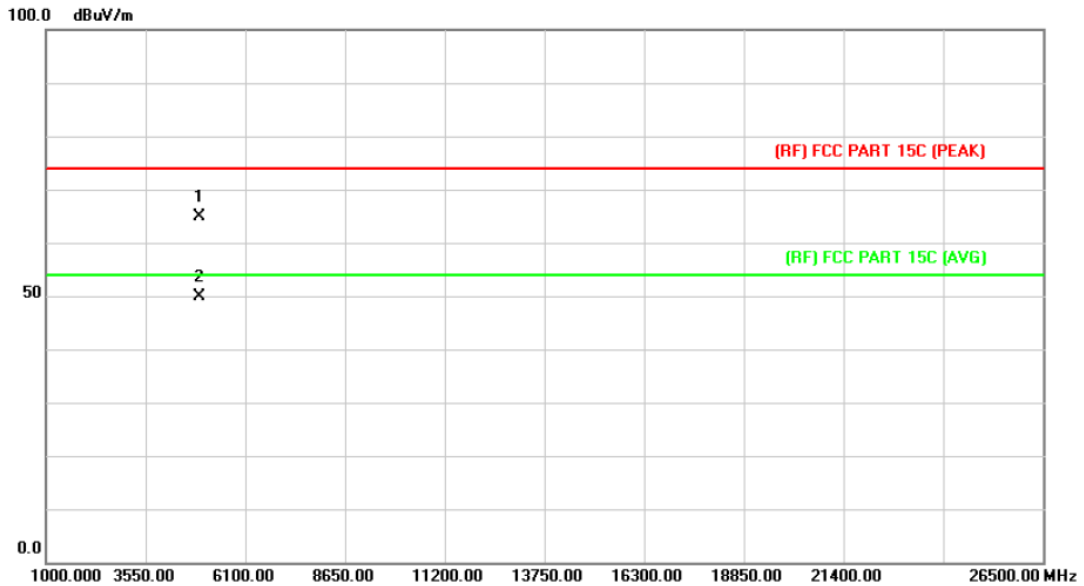

No.	Mk.	Freq.	Reading Level	Correct Factor	Measurement	Limit	Over	Detector
		MHz	dBuV	dB/m	dBuV/m	dBuV/m	dB	
1		4924.288	48.83	16.10	64.93	74.00	-9.07	peak
2	*	4924.288	33.89	16.10	49.99	54.00	-4.01	AVG

**Remark:**

1. Corr. = Antenna Factor (dB/m) + Cable Loss (dB)
2. Peak/AVG (dBμV/m) = Corr. (dB/m) + Read Level (dBμV)
3. Margin (dB) = Peak/AVG (dBμV/m) - Limit PK/AVG (dBμV/m)



<b>Temperature:</b>	23.4°C	<b>Relative Humidity:</b>	35%
<b>Test Voltage:</b>	AC 120V/60 Hz		
<b>Ant. Pol.</b>	Horizontal		
<b>Test Mode:</b>	TX n(HT20) Mode 2412MHz ANT. A+ANT. B		
<b>Remark:</b>	No report for the emission which more than 15dB below the prescribed limit.		

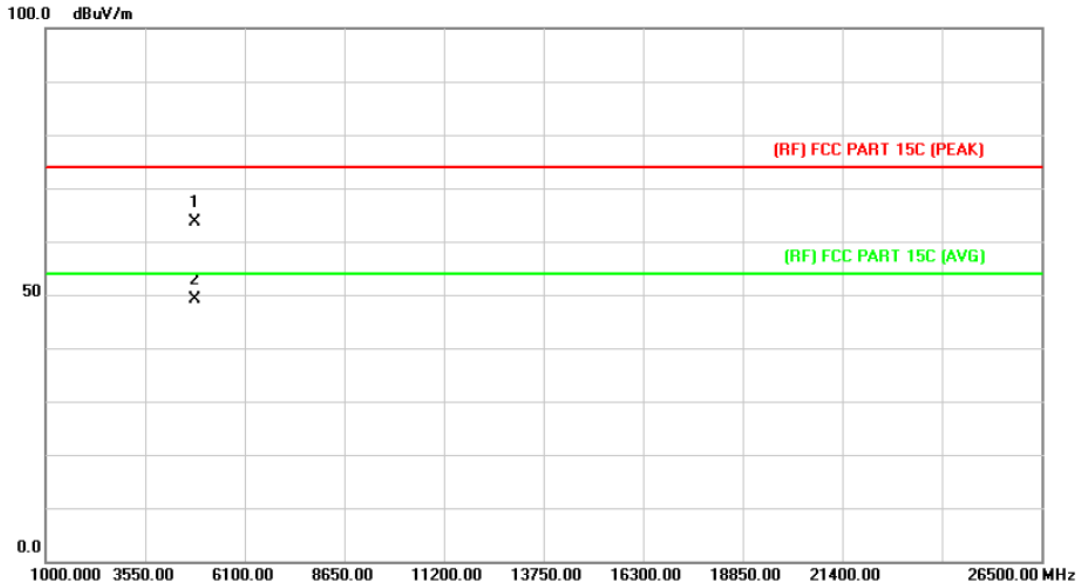

No.	Mk.	Freq.	Reading Level	Correct Factor	Measurement	Limit	Over	Detector
		MHz	dBuV	dB/m	dBuV/m	dBuV/m	dB	
1		4823.880	47.88	15.65	63.53	74.00	-10.47	peak
2	*	4823.880	33.49	15.65	49.14	54.00	-4.86	AVG

**Remark:**

1. Corr. = Antenna Factor (dB/m) + Cable Loss (dB)
2. Peak/AVG (dBμV/m) = Corr. (dB/m) + Read Level (dBμV)
3. Margin (dB) = Peak/AVG (dBμV/m) - Limit PK/AVG (dBμV/m)

<b>Temperature:</b>	23.4°C	<b>Relative Humidity:</b>	35%
<b>Test Voltage:</b>	AC 120V/60 Hz		
<b>Ant. Pol.</b>	Vertical		
<b>Test Mode:</b>	TX n(HT20) Mode 2412MHz ANT. A+ANT. B		
<b>Remark:</b>	No report for the emission which more than 15dB below the prescribed limit.		

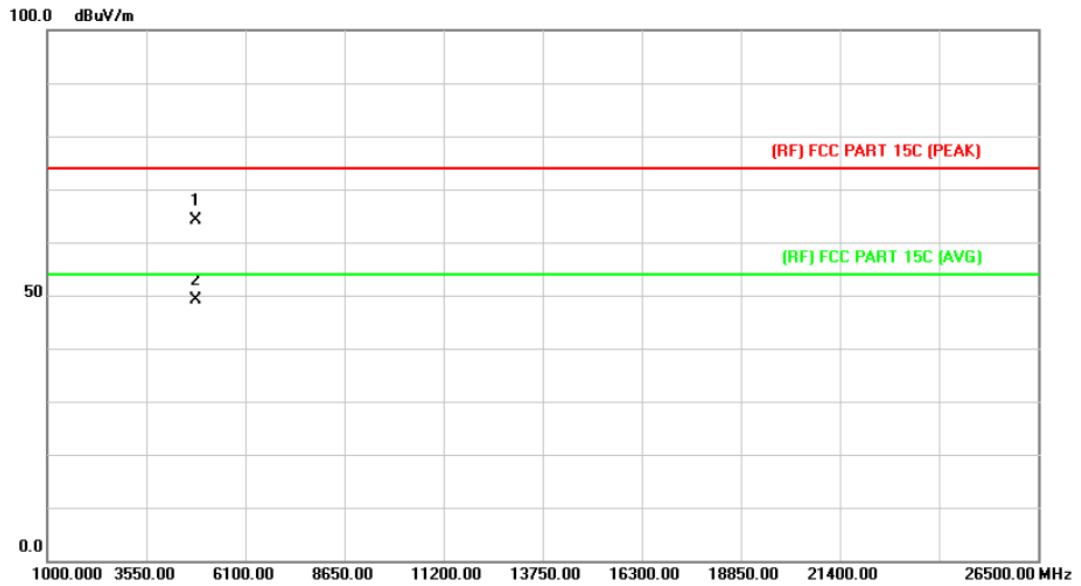

No.	Mk.	Freq. MHz	Reading Level dBuV	Correct Factor dB/m	Measure- ment dBuV/m	Limit dBuV/m	Over dB	Detector
1		4823.670	48.50	15.65	64.15	74.00	-9.85	peak
2	*	4825.356	33.54	15.66	49.20	54.00	-4.80	AVG

**Remark:**

1. Corr. = Antenna Factor (dB/m) + Cable Loss (dB)
2. Peak/AVG (dBμV/m)= Corr. (dB/m)+ Read Level (dBμV)
3. Margin (dB) = Peak/AVG (dBμV/m)-Limit PK/AVG(dBμV/m)

<b>Temperature:</b>	23.4°C	<b>Relative Humidity:</b>	35%
<b>Test Voltage:</b>	AC 120V/60 Hz		
<b>Ant. Pol.</b>	Horizontal		
<b>Test Mode:</b>	TX n(HT20) Mode 2437MHz ANT. A+ANT. B		
<b>Remark:</b>	No report for the emission which more than 15dB below the prescribed limit.		

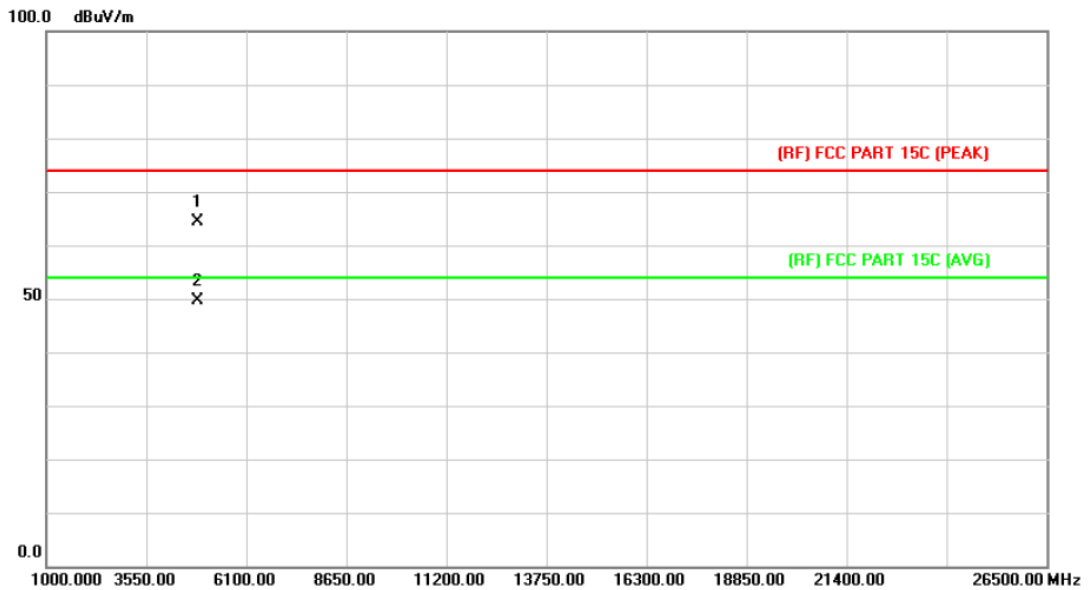

No.	Mk.	Freq. MHz	Reading Level dBuV	Correct Factor dB/m	Measure- ment dBuV/m	Limit dBuV/m	Over dB	Detector
1		4873.202	48.44	15.88	64.32	74.00	-9.68	peak
2	*	4875.260	33.80	15.89	49.69	54.00	-4.31	AVG

**Remark:**

1. Corr. = Antenna Factor (dB/m) + Cable Loss (dB)
2. Peak/AVG (dBμV/m) = Corr. (dB/m) + Read Level (dBμV)
3. Margin (dB) = Peak/AVG (dBμV/m) - Limit PK/AVG (dBμV/m)

<b>Temperature:</b>	23.4°C	<b>Relative Humidity:</b>	35%
<b>Test Voltage:</b>	AC 120V/60 Hz		
<b>Ant. Pol.</b>	Vertical		
<b>Test Mode:</b>	TX n(HT20) Mode 2437MHz ANT. A+ANT. B		
<b>Remark:</b>	No report for the emission which more than 15dB below the prescribed limit.		

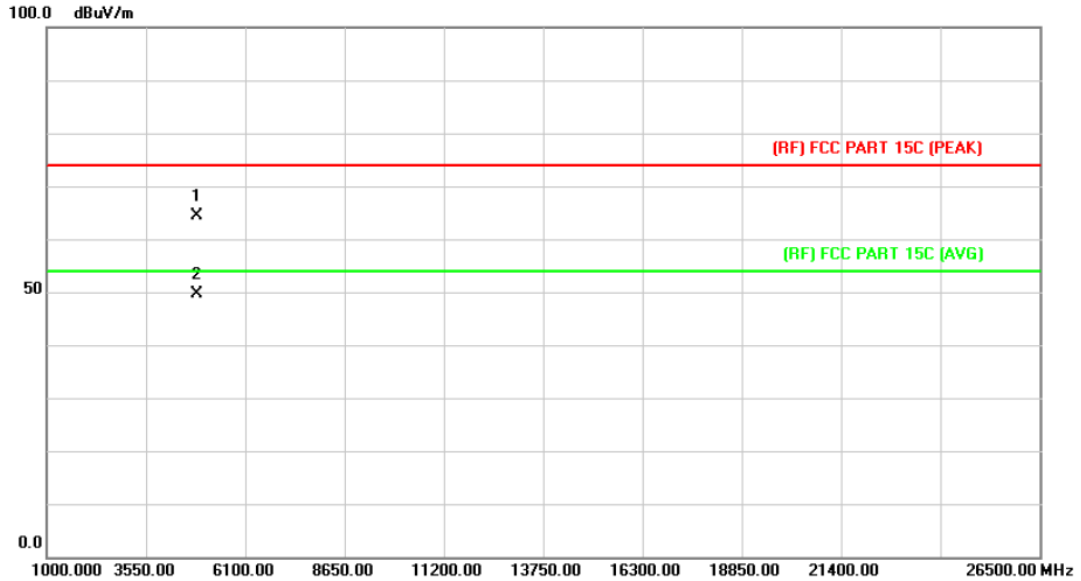

No.	Mk.	Freq.	Reading Level	Correct Factor	Measurement	Limit	Over	Detector
		MHz	dBuV	dB/m	dBuV/m	dBuV/m	dB	
1		4872.506	48.53	15.87	64.40	74.00	-9.60	peak
2	*	4875.080	33.81	15.89	49.70	54.00	-4.30	AVG

**Remark:**

1. Corr. = Antenna Factor (dB/m) + Cable Loss (dB)
2. Peak/AVG (dBuV/m) = Corr. (dB/m) + Read Level (dBuV)
3. Margin (dB) = Peak/AVG (dBuV/m) - Limit PK/AVG (dBuV/m)

<b>Temperature:</b>	23.4°C	<b>Relative Humidity:</b>	35%
<b>Test Voltage:</b>	AC 120V/60 Hz		
<b>Ant. Pol.</b>	Horizontal		
<b>Test Mode:</b>	TX n(HT20) Mode 2462MHz ANT. A+ANT. B		
<b>Remark:</b>	No report for the emission which more than 15dB below the prescribed limit.		

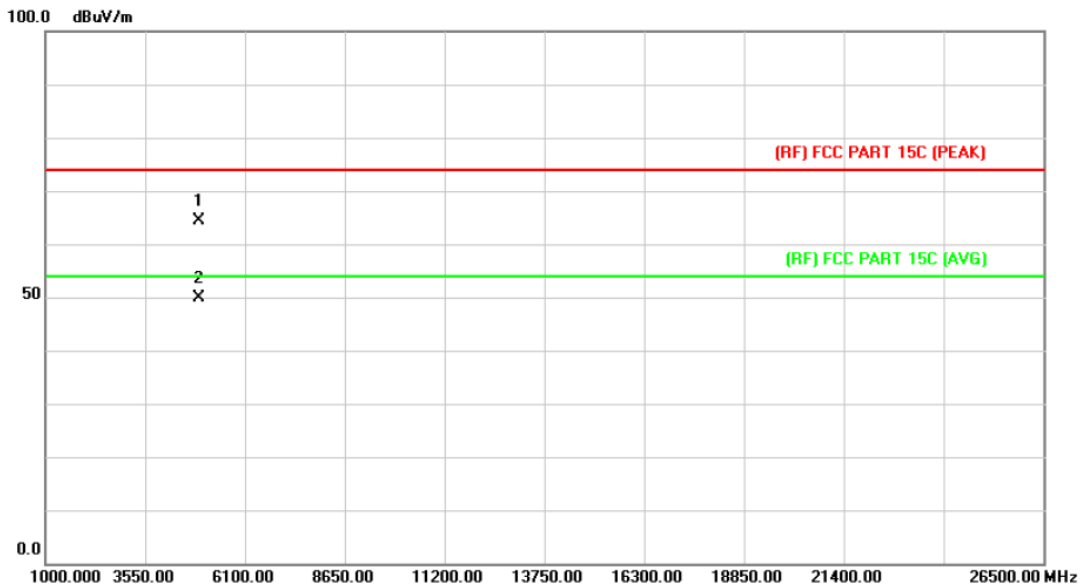

No.	Mk.	Freq. MHz	Reading Level dBuV	Correct Factor dB/m	Measure- ment dBuV/m	Limit dBuV/m	Over dB	Detector
1		4925.014	48.21	16.11	64.32	74.00	-9.68	peak
2	*	4925.014	33.68	16.11	49.79	54.00	-4.21	AVG

**Remark:**

1. Corr. = Antenna Factor (dB/m) + Cable Loss (dB)
2. Peak/AVG (dBμV/m) = Corr. (dB/m) + Read Level (dBμV)
3. Margin (dB) = Peak/AVG (dBμV/m) - Limit PK/AVG (dBμV/m)

<b>Temperature:</b>	23.4°C	<b>Relative Humidity:</b>	35%
<b>Test Voltage:</b>	AC 120V/60 Hz		
<b>Ant. Pol.</b>	Vertical		
<b>Test Mode:</b>	TX n(HT20) Mode 2462MHz ANT. A+ANT. B		
<b>Remark:</b>	No report for the emission which more than 15dB below the prescribed limit.		

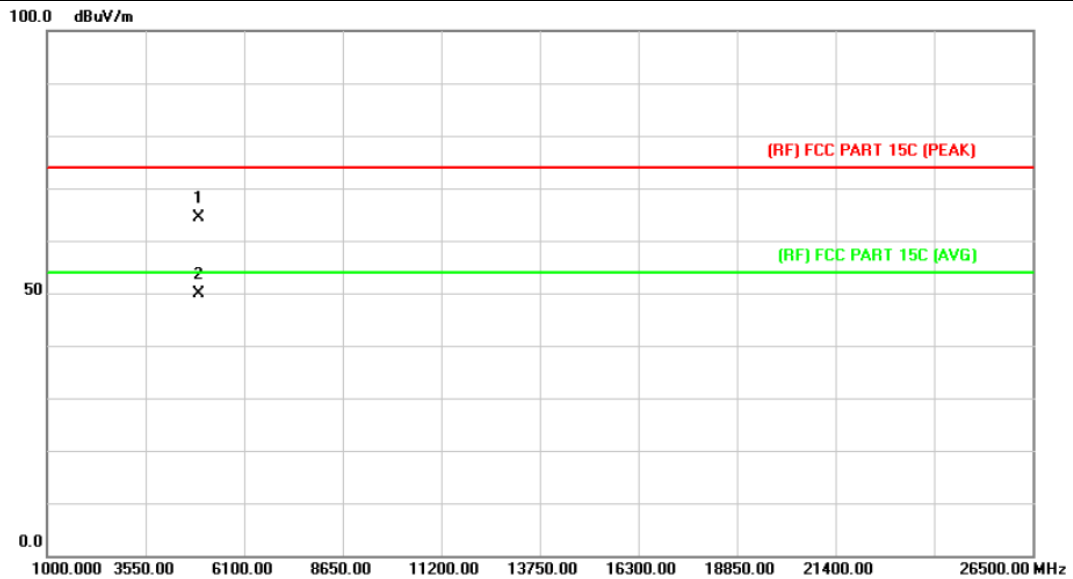

No.	Mk.	Freq.	Reading Level	Correct Factor	Measurement	Limit	Over	Detector
		MHz	dBuV	dB/m	dBuV/m	dBuV/m	dB	
1		4923.634	48.22	16.10	64.32	74.00	-9.68	peak
2	*	4923.634	33.85	16.10	49.95	54.00	-4.05	AVG

**Remark:**

1. Corr. = Antenna Factor (dB/m) + Cable Loss (dB)
2. Peak/AVG (dBμV/m) = Corr. (dB/m) + Read Level (dBμV)
3. Margin (dB) = Peak/AVG (dBμV/m) - Limit PK/AVG (dBμV/m)

<b>Temperature:</b>	23.4°C	<b>Relative Humidity:</b>	35%
<b>Test Voltage:</b>	AC 120V/60 Hz		
<b>Ant. Pol.</b>	Horizontal		
<b>Test Mode:</b>	TX n(HT40) Mode 2422MHz ANT. A+ANT. B		
<b>Remark:</b>	No report for the emission which more than 15dB below the prescribed limit.		

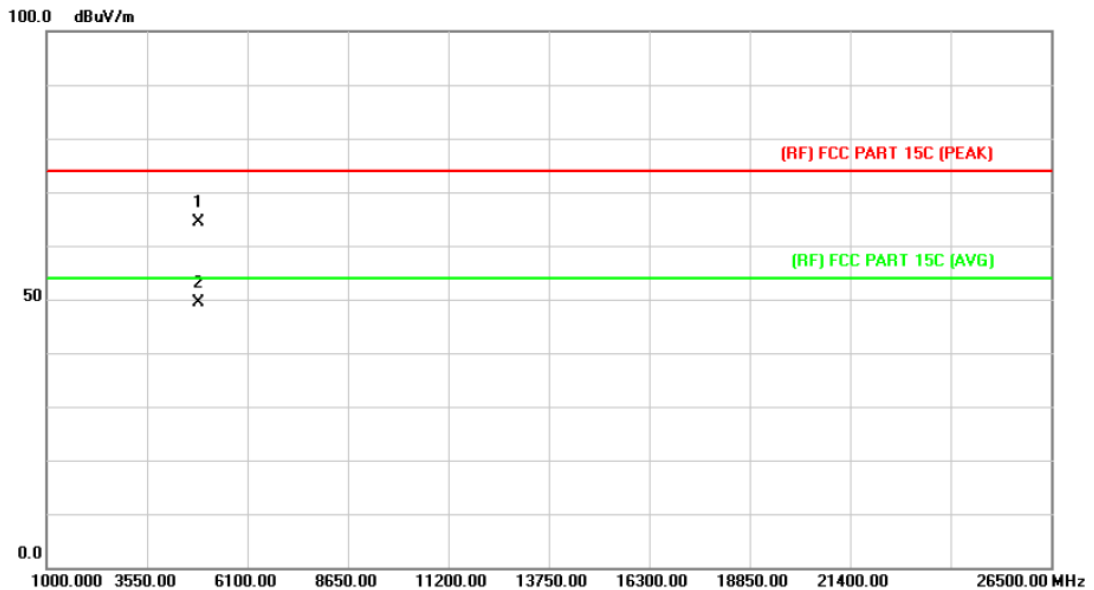

No.	Mk.	Freq.	Reading Level	Correct Factor	Measurement	Limit	Over	Detector
		MHz	dBuV	dB/m	dBuV/m	dBuV/m	dB	
1		4844.834	48.52	15.75	64.27	74.00	-9.73	peak
2	*	4844.834	33.73	15.75	49.48	54.00	-4.52	AVG

**Remark:**

1. Corr. = Antenna Factor (dB/m) + Cable Loss (dB)
2. Peak/AVG (dBμV/m) = Corr. (dB/m) + Read Level (dBμV)
3. Margin (dB) = Peak/AVG (dBμV/m) - Limit PK/AVG (dBμV/m)

<b>Temperature:</b>	23.4°C	<b>Relative Humidity:</b>	35%
<b>Test Voltage:</b>	AC 120V/60 Hz		
<b>Ant. Pol.</b>	Vertical		
<b>Test Mode:</b>	TX n(HT40) Mode 2422MHz ANT. A+ANT. B		
<b>Remark:</b>	No report for the emission which more than 15dB below the prescribed limit.		

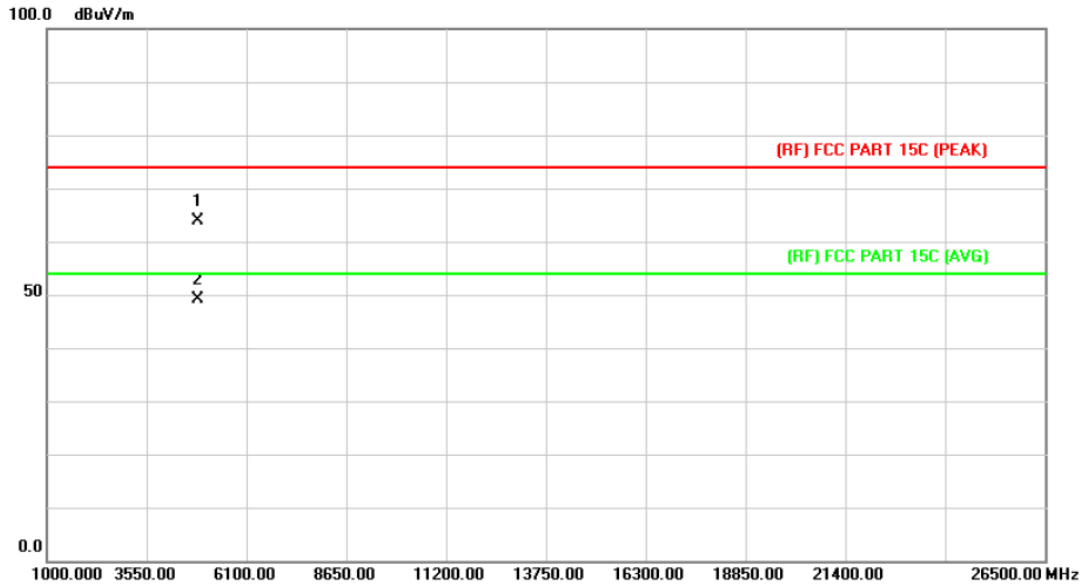

No.	Mk.	Freq.	Reading Level	Correct Factor	Measurement	Limit	Over	Detector
		MHz	dBuV	dB/m	dBuV/m	dBuV/m	dB	
1		4844.924	48.23	15.75	63.98	74.00	-10.02	peak
2	*	4844.924	33.46	15.75	49.21	54.00	-4.79	AVG

**Remark:**

1. Corr. = Antenna Factor (dB/m) + Cable Loss (dB)
2. Peak/AVG (dBμV/m)= Corr. (dB/m)+ Read Level (dBμV)
3. Margin (dB) = Peak/AVG (dBμV/m)-Limit PK/AVG(dBμV/m)



<b>Temperature:</b>	23.4°C	<b>Relative Humidity:</b>	35%
<b>Test Voltage:</b>	AC 120V/60 Hz		
<b>Ant. Pol.</b>	Horizontal		
<b>Test Mode:</b>	TX n(HT40) Mode 2437MHz ANT. A+ANT. B		
<b>Remark:</b>	No report for the emission which more than 15dB below the prescribed limit.		

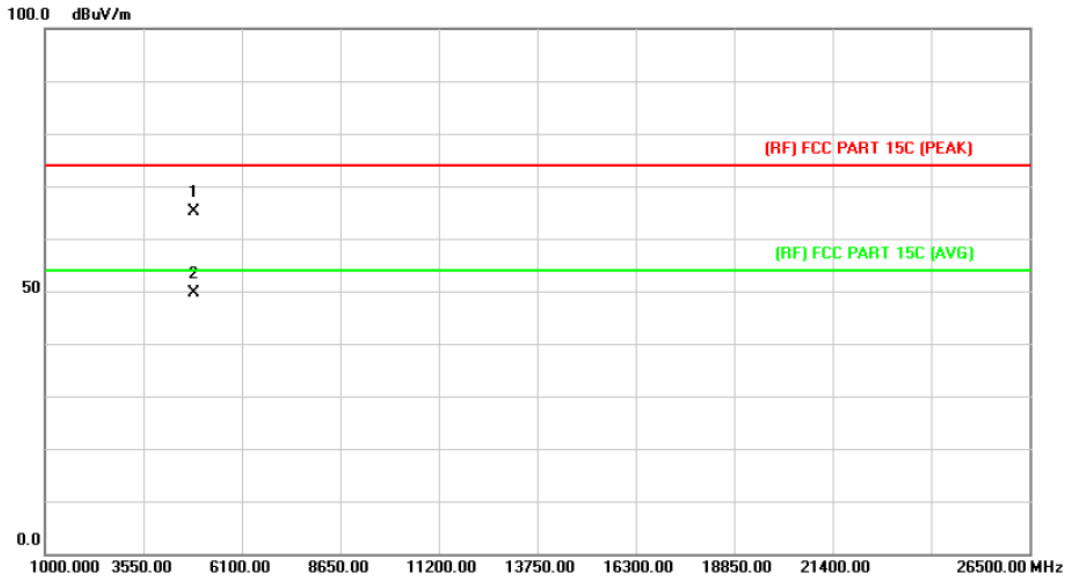

No.	Mk.	Freq.	Reading Level	Correct Factor	Measurement	Limit	Over	Detector
		MHz	dBuV	dB/m	dBuV/m	dBuV/m	dB	
1		4874.984	49.30	15.88	65.18	74.00	-8.82	peak
2	*	4874.984	33.73	15.88	49.61	54.00	-4.39	AVG

**Remark:**

1. Corr. = Antenna Factor (dB/m) + Cable Loss (dB)
2. Peak/AVG (dBuV/m) = Corr. (dB/m) + Read Level (dBuV)
3. Margin (dB) = Peak/AVG (dBuV/m) - Limit PK/AVG (dBuV/m)

<b>Temperature:</b>	23.4°C	<b>Relative Humidity:</b>	35%
<b>Test Voltage:</b>	AC 120V/60 Hz		
<b>Ant. Pol.</b>	Vertical		
<b>Test Mode:</b>	TX n(HT40) Mode 2437MHz ANT. A+ANT. B		
<b>Remark:</b>	No report for the emission which more than 15dB below the prescribed limit.		

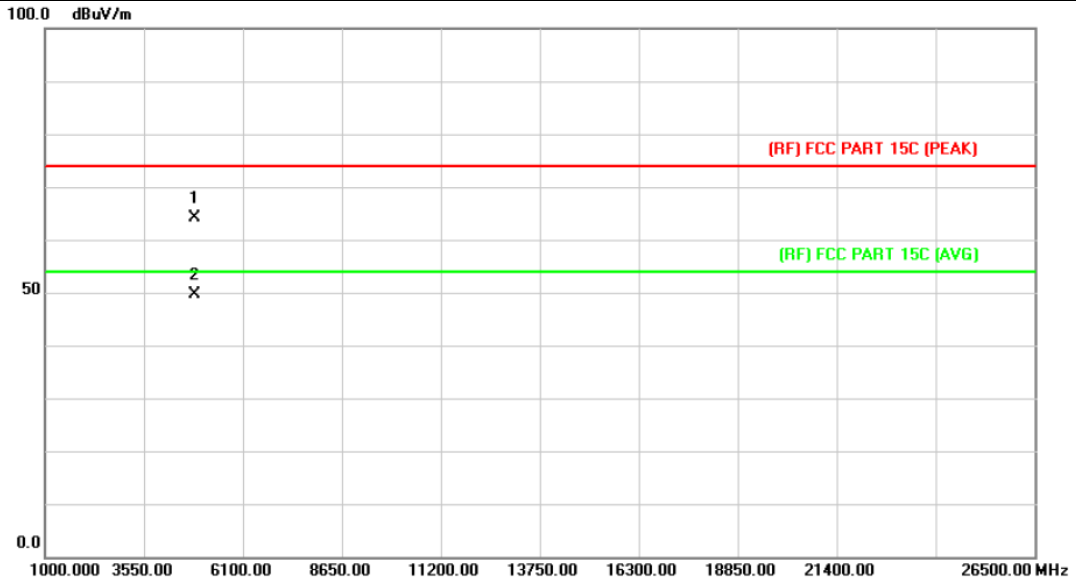

No.	Mk.	Freq. MHz	Reading Level dBuV	Correct Factor dB/m	Measure- ment dBuV/m	Limit dBuV/m	Over dB	Detector
1		4873.772	48.22	15.88	64.10	74.00	-9.90	peak
2	*	4873.772	33.72	15.88	49.60	54.00	-4.40	AVG

**Remark:**

1. Corr. = Antenna Factor (dB/m) + Cable Loss (dB)
2. Peak/AVG (dBμV/m)= Corr. (dB/m)+ Read Level (dBμV)
3. Margin (dB) = Peak/AVG (dBμV/m)-Limit PK/AVG(dBμV/m)

<b>Temperature:</b>	23.4°C	<b>Relative Humidity:</b>	35%
<b>Test Voltage:</b>	AC 120V/60 Hz		
<b>Ant. Pol.</b>	Horizontal		
<b>Test Mode:</b>	TX n(HT40) Mode 2452MHz ANT. A+ANT. B		
<b>Remark:</b>	No report for the emission which more than 15dB below the prescribed limit.		

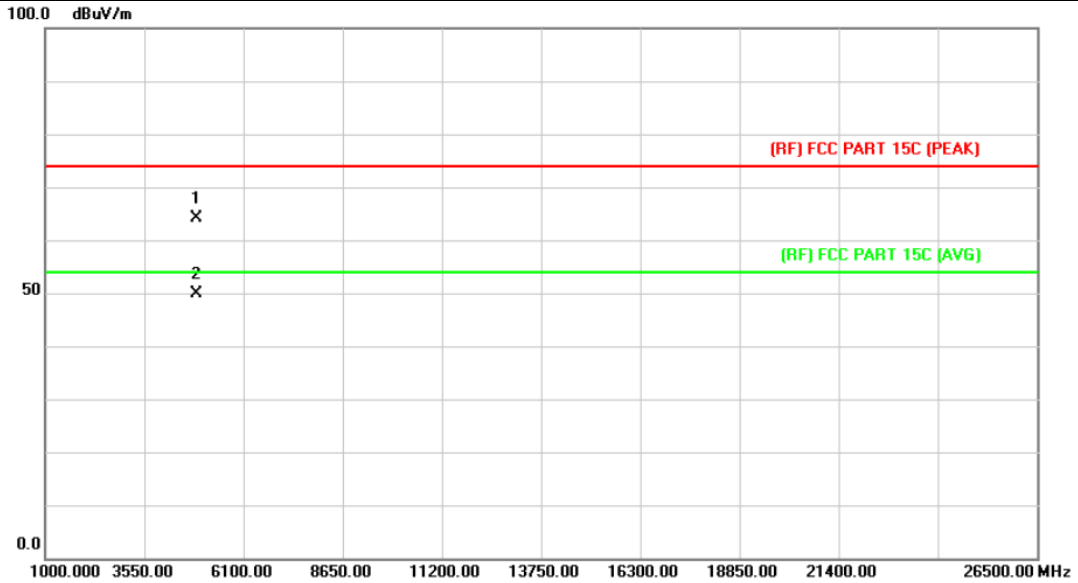

No.	Mk.	Freq.	Reading Level	Correct Factor	Measurement	Limit	Over	Detector
		MHz	dBuV	dB/m	dBuV/m	dBuV/m	dB	
1		4903.268	48.23	16.01	64.24	74.00	-9.76	peak
2	*	4903.268	33.98	16.01	49.99	54.00	-4.01	AVG

**Remark:**

1. Corr. = Antenna Factor (dB/m) + Cable Loss (dB)
2. Peak/AVG (dBμV/m)= Corr. (dB/m)+ Read Level (dBμV)
3. Margin (dB) = Peak/AVG (dBμV/m)-Limit PK/AVG(dBμV/m)

<b>Temperature:</b>	23.4°C	<b>Relative Humidity:</b>	35%
<b>Test Voltage:</b>	AC 120V/60 Hz		
<b>Ant. Pol.</b>	Vertical		
<b>Test Mode:</b>	TX n(HT40) Mode 2452MHz ANT. A+ANT. B		
<b>Remark:</b>	No report for the emission which more than 15dB below the prescribed limit.		

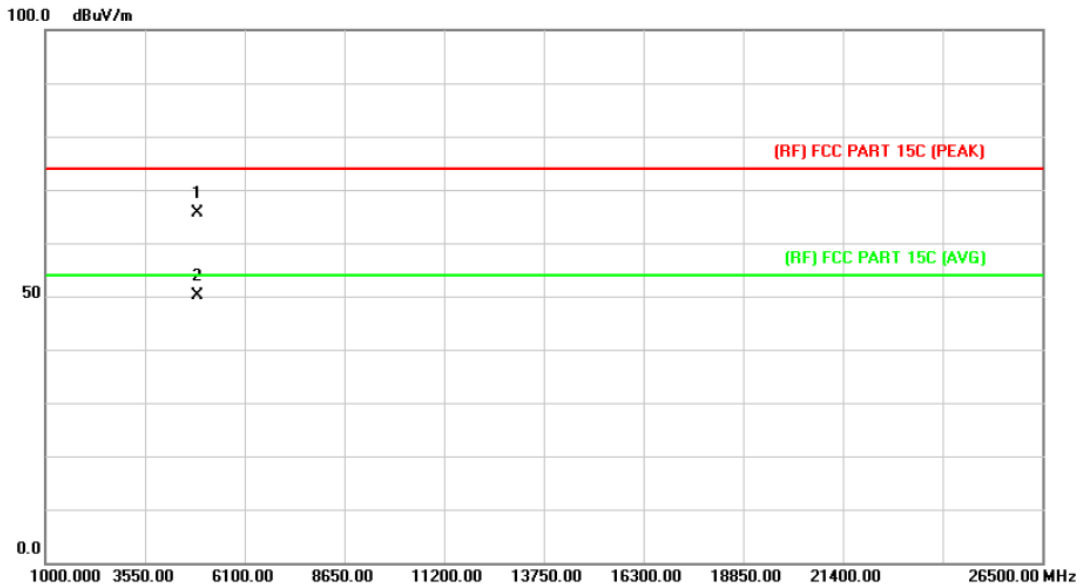

No.	Mk.	Freq.	Reading Level	Correct Factor	Measurement	Limit	Over	Detector
		MHz	dBuV	dB/m	dBuV/m	dBuV/m	dB	
1		4902.812	49.69	16.02	65.71	74.00	-8.29	peak
2	*	4902.812	34.11	16.02	50.13	54.00	-3.87	AVG

**Remark:**

1. Corr. = Antenna Factor (dB/m) + Cable Loss (dB)
2. Peak/AVG (dBμV/m) = Corr. (dB/m) + Read Level (dBμV)
3. Margin (dB) = Peak/AVG (dBμV/m) - Limit PK/AVG (dBμV/m)

# Attachment C-- Restricted Bands Requirement and Band-edge Test Data

## (1) Radiation Test

Temperature:	23.4°C	Relative Humidity:	35%
Test Voltage:	AC 120V/60HZ		
Ant. Pol.	Horizontal		
Test Mode:	TX B Mode 2412MHz ANT. A+ANT. B		
Remark:	Only show the worst case		

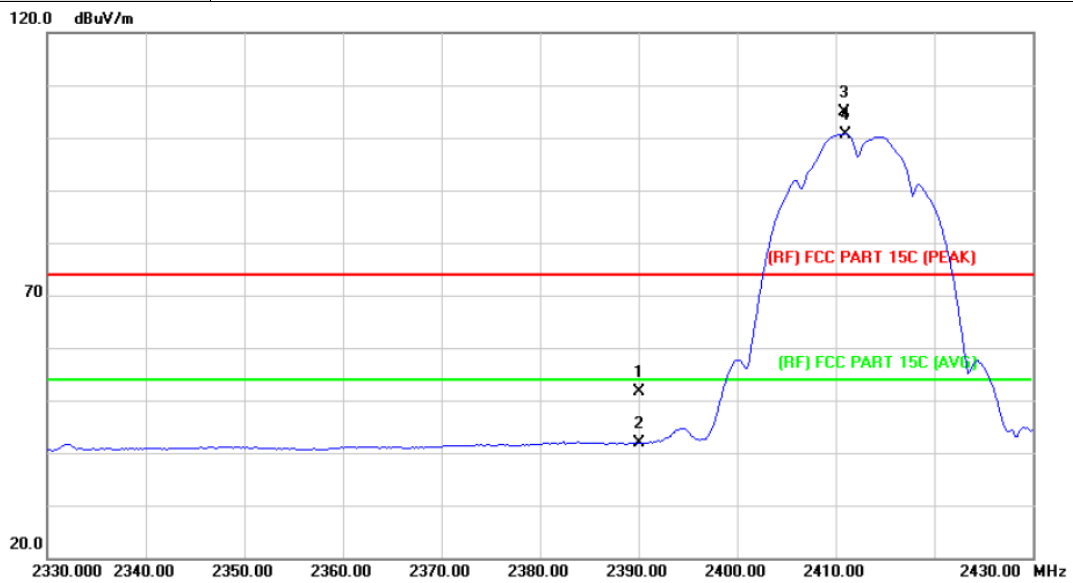

No.	Mk.	Freq. MHz	Reading Level dBuV	Correct Factor dB/m	Measure- ment dBuV/m	Limit dBuV/m	Over dB	Detector
1		2390.000	48.65	2.91	51.56	74.00	-22.44	peak
2		2390.000	38.94	2.91	41.85	54.00	-12.15	AVG
3	X	2410.800	101.87	2.99	104.86	Fundamental Frequency		peak
4	*	2411.000	97.76	2.99	100.75	Fundamental Frequency		AVG

**Remark:**

1. Corr. = Antenna Factor (dB/m) + Cable Loss (dB)
2. Peak/AVG (dBuV/m) = Corr. (dB/m) + Read Level (dBuV)
3. Margin (dB) = Peak/AVG (dBuV/m) - Limit PK/AVG (dBuV/m)

<b>Temperature:</b>	23.4°C	<b>Relative Humidity:</b>	35%
<b>Test Voltage:</b>	AC 120V/60HZ		
<b>Ant. Pol.</b>	Vertical		
<b>Test Mode:</b>	TX B Mode 2412MHz ANT. A+ANT. B		
<b>Remark:</b>	Only show the worst case		

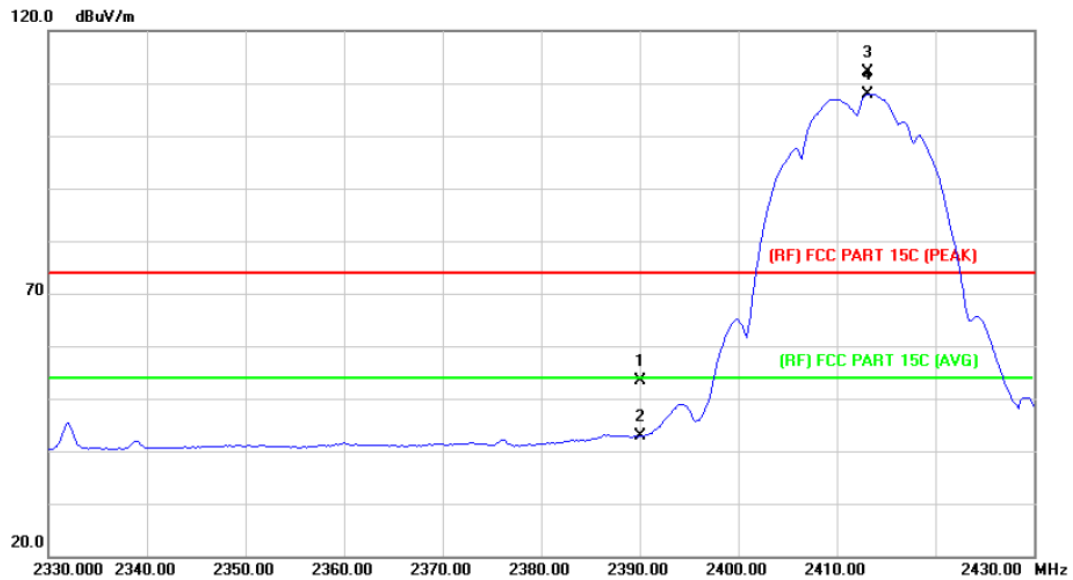

No.	Mk.	Freq. MHz	Reading Level dBuV	Correct Factor dB/m	Measure- ment dBuV/m	Limit dBuV/m	Over dB	Detector
1		2390.000	50.57	2.91	53.48	74.00	-20.52	peak
2		2390.000	40.03	2.91	42.94	54.00	-11.06	AVG
3	X	2413.200	109.14	3.01	112.15	Fundamental Frequency		peak
4	*	2413.200	104.90	3.01	107.91	Fundamental Frequency		AVG

**Remark:**

1. Corr. = Antenna Factor (dB/m) + Cable Loss (dB)
2. Peak/AVG (dBμV/m)= Corr. (dB/m)+ Read Level (dBμV)
3. Margin (dB) = Peak/AVG (dBμV/m)-Limit PK/AVG(dBμV/m)

Temperature:	23.4°C	Relative Humidity:	35%
Test Voltage:	AC 120V/60HZ		
Ant. Pol.	Horizontal		
Test Mode:	TX B Mode 2462MHz ANT. A+ANT. B		
Remark:	Only show the worst case		

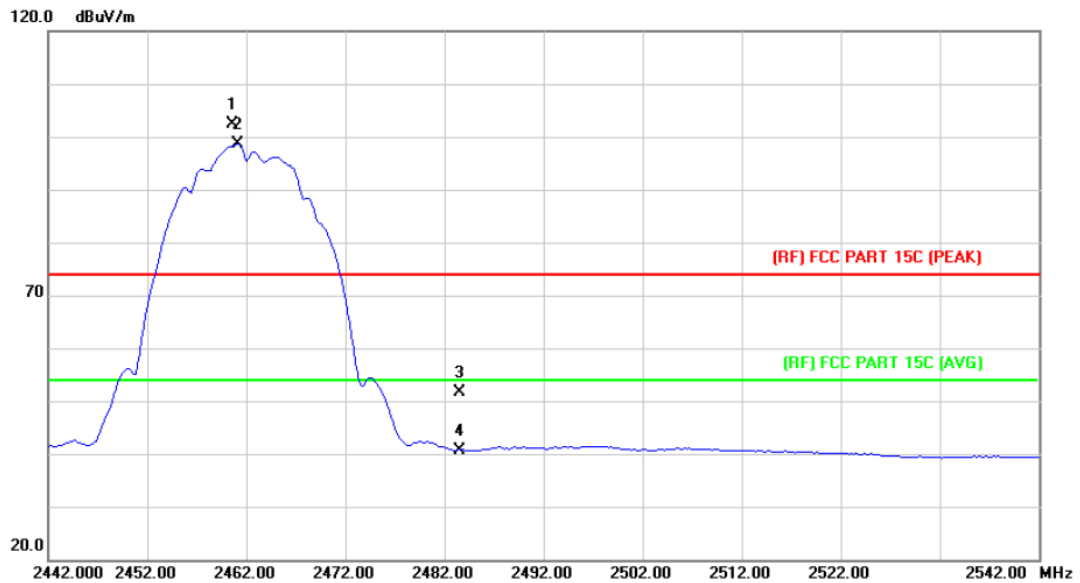

No.	Mk.	Freq. MHz	Reading Level dBuV	Correct Factor dB/m	Measure- ment dBuV/m	Limit dBuV/m	Over dB	Detector
1	X	2460.600	99.23	3.27	102.50	Fundamental Frequency		peak
2	*	2461.200	95.36	3.28	98.64	Fundamental Frequency		AVG
3		2483.500	48.23	3.40	51.63	74.00	-22.37	peak
4		2483.500	37.31	3.40	40.71	54.00	-13.29	AVG

**Remark:**

1. Corr. = Antenna Factor (dB/m) + Cable Loss (dB)
2. Peak/AVG (dBuV/m) = Corr. (dB/m) + Read Level (dBuV)
3. Margin (dB) = Peak/AVG (dBuV/m) - Limit PK/AVG (dBuV/m)

<b>Temperature:</b>	23.4°C	<b>Relative Humidity:</b>	35%
<b>Test Voltage:</b>	AC 120V/60HZ		
<b>Ant. Pol.</b>	Vertical		
<b>Test Mode:</b>	TX B Mode 2462MHz ANT. A+ANT. B		
<b>Remark:</b>	Only show the worst case		

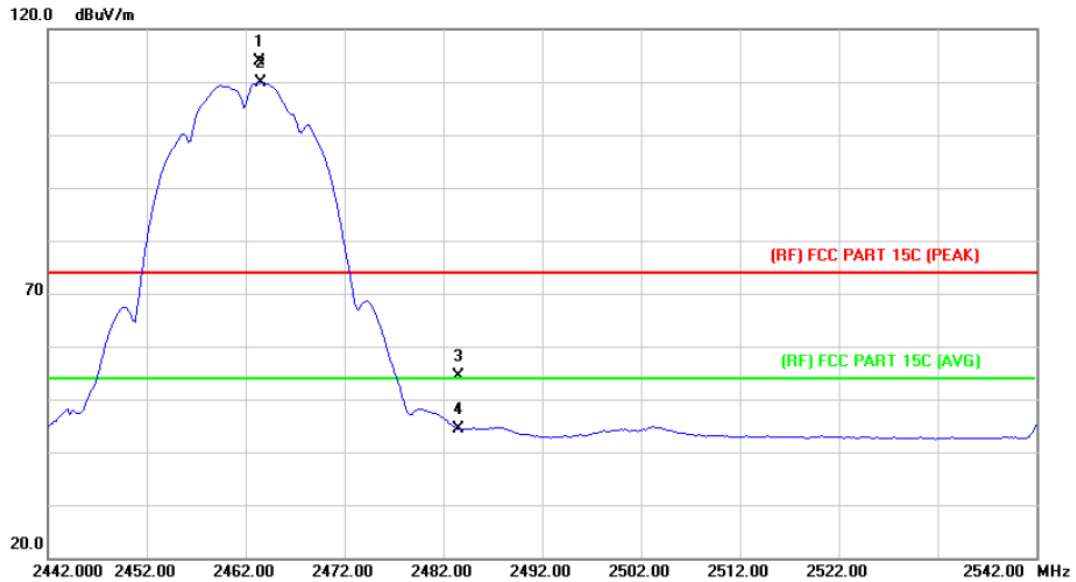

No.	Mk.	Freq. MHz	Reading Level dBuV	Correct Factor dB/m	Measure- ment dBuV/m	Limit dBuV/m	Over dB	Detector
1	X	2463.400	110.64	3.29	113.93	Fundamental Frequency		peak
2	*	2463.600	106.51	3.29	109.80	Fundamental Frequency		AVG
3		2483.500	50.99	3.40	54.39	74.00	-19.61	peak
4		2483.500	41.06	3.40	44.46	54.00	-9.54	AVG

**Remark:**

1. Corr. = Antenna Factor (dB/m) + Cable Loss (dB)
2. Peak/AVG (dBuV/m) = Corr. (dB/m) + Read Level (dBuV)
3. Margin (dB) = Peak/AVG (dBuV/m) - Limit PK/AVG (dBuV/m)



Temperature:	23.4°C	Relative Humidity:	35%
Test Voltage:	AC 120V/60HZ		
Ant. Pol.	Horizontal		
Test Mode:	TX G Mode 2412MHz ANT. A+ANT. B		
Remark:	Only show the worst case.		

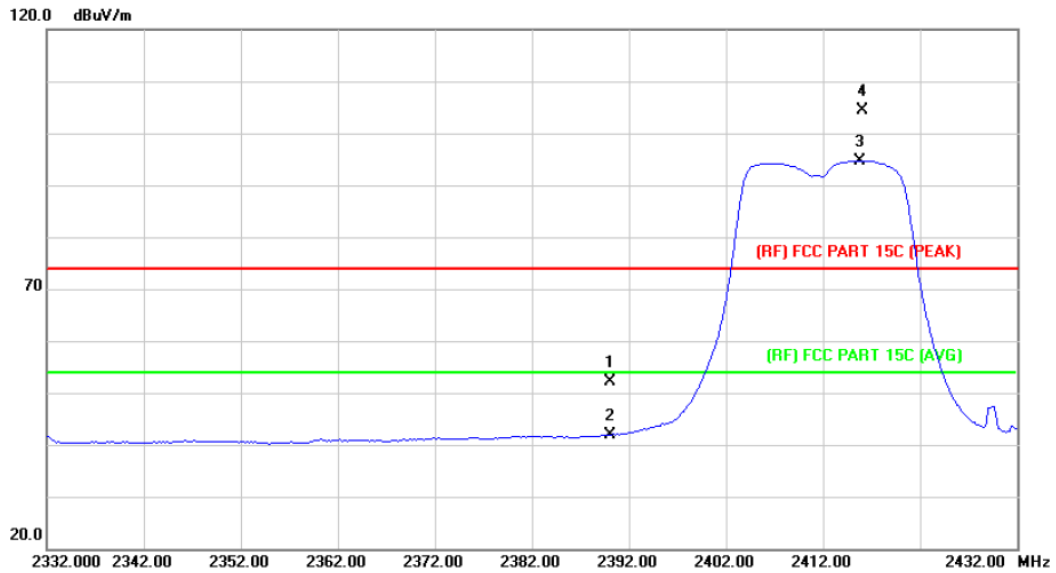

No.	Mk.	Freq. MHz	Reading Level dBuV	Correct Factor dB/m	Measure- ment dBuV/m	Limit dBuV/m	Over dB	Detector
1		2390.000	49.30	2.91	52.21	74.00	-21.79	peak
2		2390.000	38.95	2.91	41.86	54.00	-12.14	AVG
3	*	2415.800	91.70	3.03	94.73	Fundamental Frequency		AVG
4	X	2416.000	101.26	3.03	104.29	Fundamental Frequency		peak

**Remark:**

1. Corr. = Antenna Factor (dB/m) + Cable Loss (dB)
2. Peak/AVG (dBμV/m) = Corr. (dB/m) + Read Level (dBμV)
3. Margin (dB) = Peak/AVG (dBμV/m) - Limit PK/AVG (dBμV/m)

<b>Temperature:</b>	23.4°C	<b>Relative Humidity:</b>	35%
<b>Test Voltage:</b>	AC 120V/60HZ		
<b>Ant. Pol.</b>	Vertical		
<b>Test Mode:</b>	TX G Mode 2412MHz ANT. A+ANT. B		
<b>Remark:</b>	Only show the worst case.		

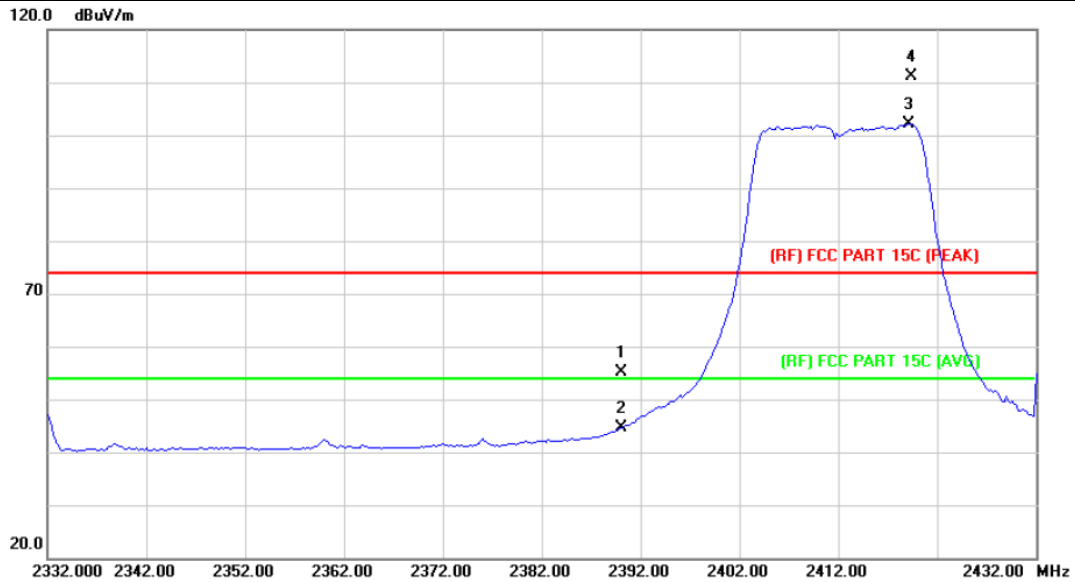

No.	Mk.	Freq.	Reading Level	Correct Factor	Measurement	Limit	Over	Detector
		MHz	dBuV	dB/m	dBuV/m	dBuV/m	dB	
1		2390.000	52.14	2.91	55.05	74.00	-18.95	peak
2		2390.000	41.74	2.91	44.65	54.00	-9.35	AVG
3	*	2419.200	99.02	3.04	102.06	Fundamental Frequency		AVG
4	X	2419.400	108.05	3.04	111.09	Fundamental Frequency		peak

**Remark:**

1. Corr. = Antenna Factor (dB/m) + Cable Loss (dB)
2. Peak/AVG (dBμV/m) = Corr. (dB/m) + Read Level (dBμV)
3. Margin (dB) = Peak/AVG (dBμV/m) - Limit PK/AVG (dBμV/m)

Temperature:	23.4°C	Relative Humidity:	35%
Test Voltage:	AC 120V/60HZ		
Ant. Pol.	Horizontal		
Test Mode:	TX G Mode 2462MHz ANT. A+ANT. B		
Remark:	Only show the worst case.		

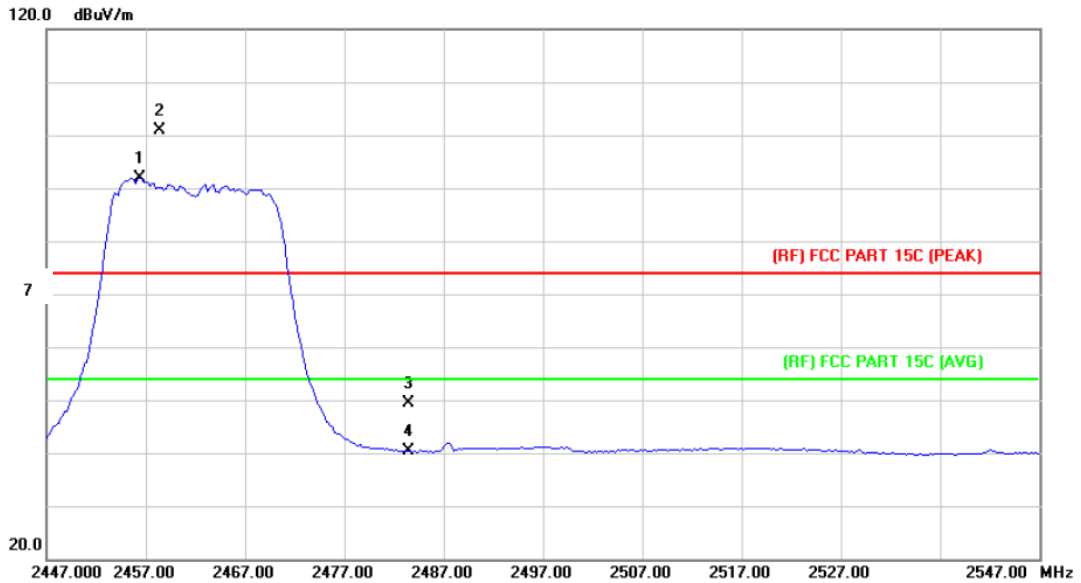

No.	Mk.	Freq. MHz	Reading Level dBuV	Correct Factor dB/m	Measure- ment dBuV/m	Limit dBuV/m	Over dB	Detector
1	*	2456.400	88.64	3.24	91.88	Fundamental Frequency		AVG
2	X	2458.400	97.71	3.25	100.96	Fundamental Frequency		peak
3		2483.500	45.92	3.40	49.32	74.00	-24.68	peak
4		2483.500	37.04	3.40	40.44	54.00	-13.56	AVG

**Remark:**

1. Corr. = Antenna Factor (dB/m) + Cable Loss (dB)
2. Peak/AVG (dBμV/m) = Corr. (dB/m) + Read Level (dBμV)
3. Margin (dB) = Peak/AVG (dBμV/m) - Limit PK/AVG (dBμV/m)

Temperature:	23.4°C	Relative Humidity:	35%
Test Voltage:	AC 120V/60HZ		
Ant. Pol.	Vertical		
Test Mode:	TX G Mode 2462MHz ANT. A+ANT. B		
Remark:	Only show the worst case.		

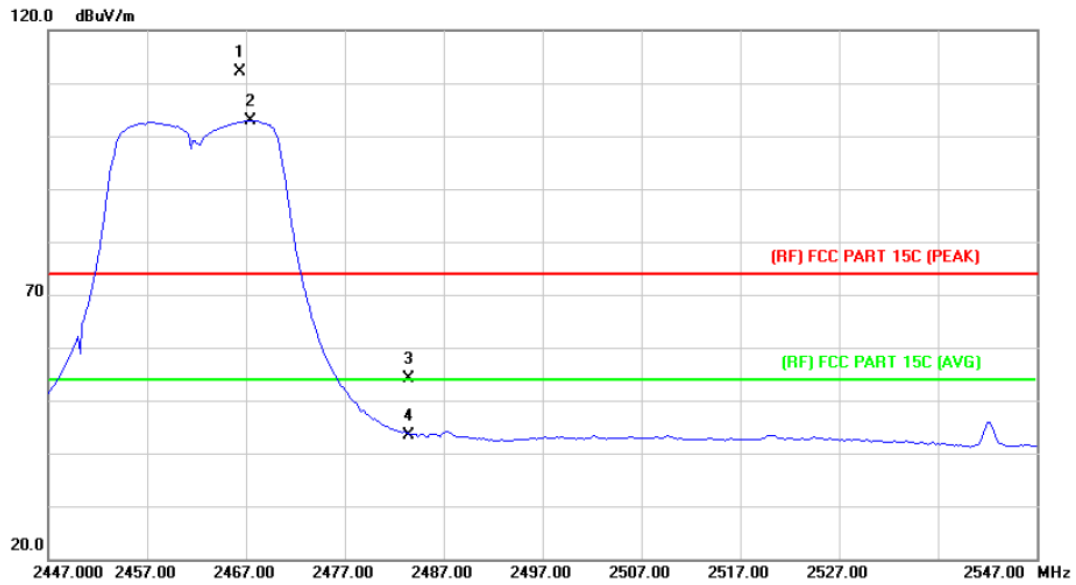

No.	Mk.	Freq. MHz	Reading Level dBuV	Correct Factor dB/m	Measure- ment dBuV/m	Limit dBuV/m	Over dB	Detector
1	X	2466.400	108.81	3.30	112.11	Fundamental Frequency		peak
2	*	2467.400	99.54	3.32	102.86	Fundamental Frequency		AVG
3		2483.500	50.82	3.40	54.22	74.00	-19.78	peak
4		2483.500	40.10	3.40	43.50	54.00	-10.50	AVG

**Remark:**

1. Corr. = Antenna Factor (dB/m) + Cable Loss (dB)
2. Peak/AVG (dBμV/m) = Corr. (dB/m) + Read Level (dBμV)
3. Margin (dB) = Peak/AVG (dBμV/m) - Limit PK/AVG (dBμV/m)

Temperature:	23.4°C	Relative Humidity:	35%
Test Voltage:	AC 120V/60HZ		
Ant. Pol.	Horizontal		
Test Mode:	TX N(HT20) Mode 2412MHz ANT. A.+ANT. B		
Remark:	N/A		

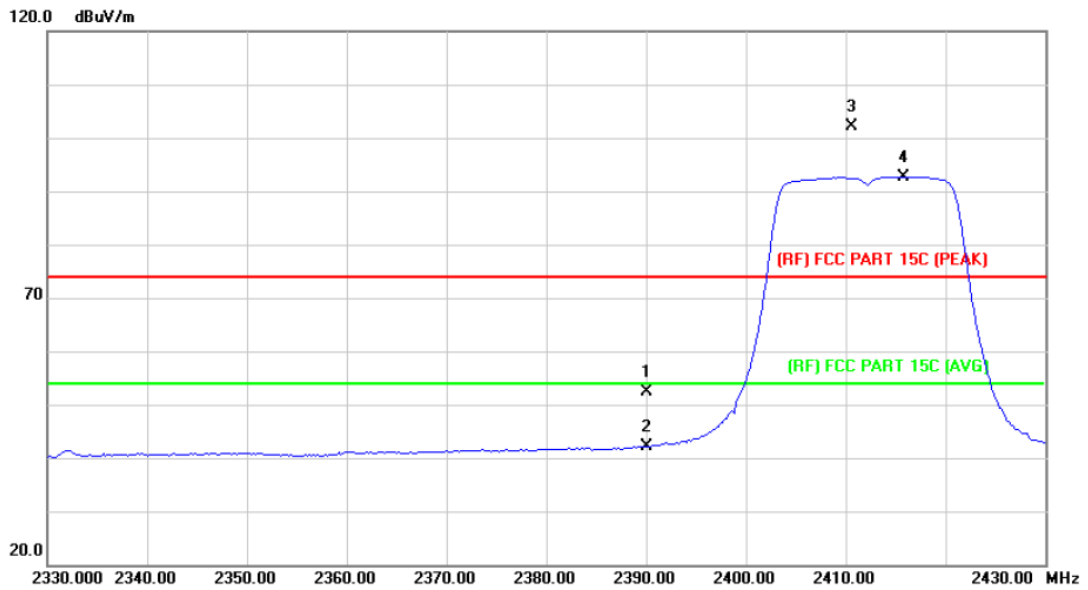

No.	Mk.	Freq. MHz	Reading Level dBuV	Correct Factor dB/m	Measure- ment dBuV/m	Limit dBuV/m	Over dB	Detector
1		2390.000	49.41	2.91	52.32	74.00	-21.68	peak
2		2390.000	39.34	2.91	42.25	54.00	-11.75	AVG
3	X	2410.600	99.02	2.99	102.01			Fundamental Frequency peak
4	*	2415.800	89.72	3.03	92.75			Fundamental Frequency AVG

**Remark:**

1. Corr. = Antenna Factor (dB/m) + Cable Loss (dB)
2. Peak/AVG (dBuV/m) = Corr. (dB/m) + Read Level (dBuV)
3. Margin (dB) = Peak/AVG (dBuV/m) - Limit PK/AVG (dBuV/m)

Temperature:	23.4°C	Relative Humidity:	35%
Test Voltage:	AC 120V/60HZ		
Ant. Pol.	Vertical		
Test Mode:	TX N(HT20) Mode 2412MHz ANT. A.+ANT. B		
Remark:	N/A		

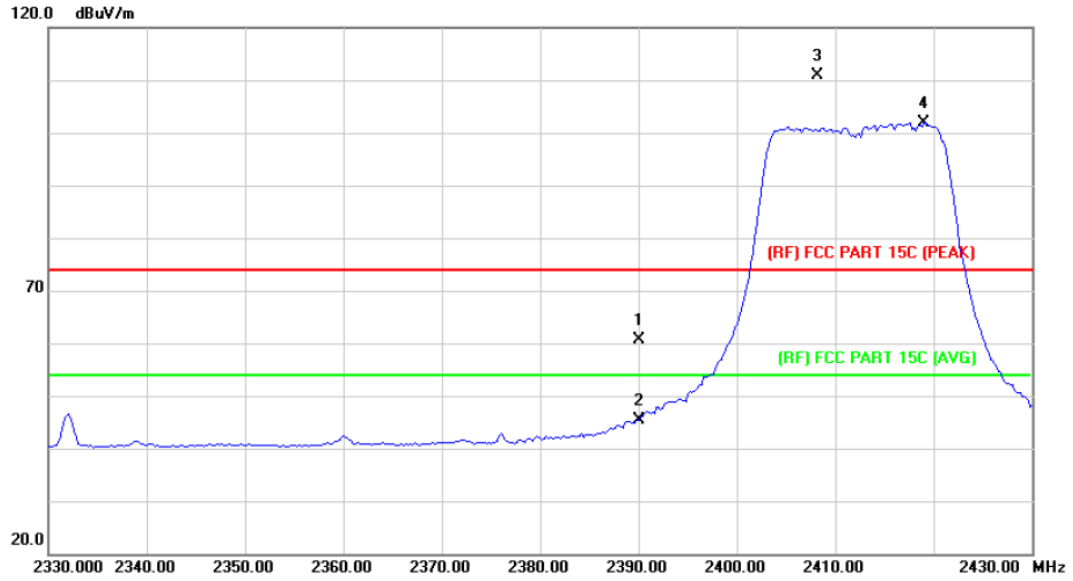

No.	Mk.	Freq.	Reading Level	Correct Factor	Measurement	Limit	Over	Detector
		MHz	dBuV	dB/m	dBuV/m	dBuV/m	dB	
1		2390.000	57.72	2.91	60.63	74.00	-13.37	peak
2		2390.000	42.40	2.91	45.31	54.00	-8.69	AVG
3	X	2408.200	107.87	2.98	110.85	Fundamental Frequency		peak
4	*	2419.000	98.80	3.03	101.83	Fundamental Frequency		AVG

**Remark:**

1. Corr. = Antenna Factor (dB/m) + Cable Loss (dB)
2. Peak/AVG (dBuV/m) = Corr. (dB/m) + Read Level (dBuV)
3. Margin (dB) = Peak/AVG (dBuV/m) - Limit PK/AVG (dBuV/m)

Temperature:	23.4°C	Relative Humidity:	35%
Test Voltage:	AC 120V/60HZ		
Ant. Pol.	Horizontal		
Test Mode:	TX N(HT20) Mode 2462MHz ANT. A.+ANT. B		
Remark:	N/A		

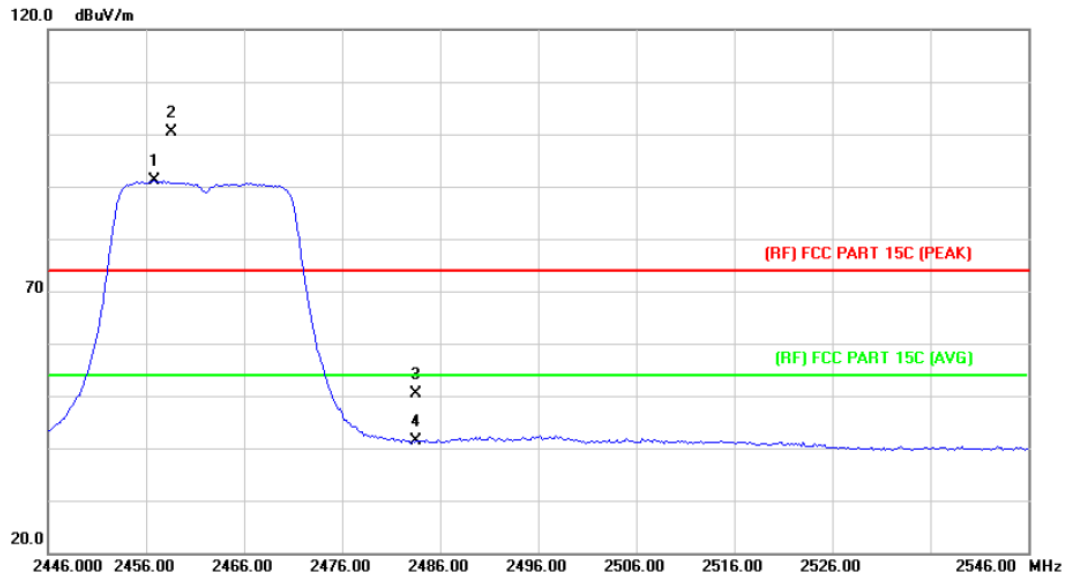

No.	Mk.	Freq. MHz	Reading Level dBuV	Correct Factor dB/m	Measure- ment dBuV/m	Limit dBuV/m	Over dB	Detector
1	*	2456.800	87.92	3.24	91.16	Fundamental Frequency		AVG
2	X	2458.600	97.04	3.25	100.29	Fundamental Frequency		peak
3		2483.500	46.99	3.40	50.39	74.00	-23.61	peak
4		2483.500	38.04	3.40	41.44	54.00	-12.56	AVG

**Remark:**

1. Corr. = Antenna Factor (dB/m) + Cable Loss (dB)
2. Peak/AVG (dBμV/m) = Corr. (dB/m) + Read Level (dBμV)
3. Margin (dB) = Peak/AVG (dBμV/m) - Limit PK/AVG (dBμV/m)

Temperature:	23.4°C	Relative Humidity:	35%
Test Voltage:	AC 120V/60HZ		
Ant. Pol.	Vertical		
Test Mode:	TX N(HT20) Mode 2462MHz ANT. A.+ANT. B		
Remark:	N/A		

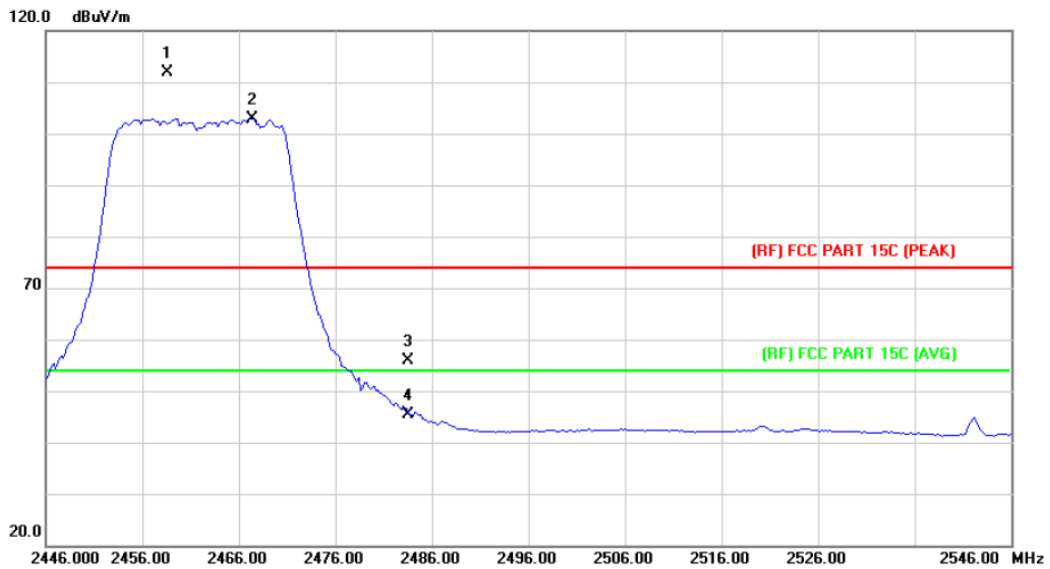

No.	Mk.	Freq. MHz	Reading Level dBuV	Correct Factor dB/m	Measure- ment dBuV/m	Limit dBuV/m	Over dB	Detector
1	X	2458.600	108.74	3.25	111.99	Fundamental Frequency		peak
2	*	2467.400	99.56	3.32	102.88	Fundamental Frequency		AVG
3		2483.500	52.46	3.40	55.86	74.00	-18.14	peak
4		2483.500	42.07	3.40	45.47	54.00	-8.53	AVG

**Remark:**

1. Corr. = Antenna Factor (dB/m) + Cable Loss (dB)
2. Peak/AVG (dBμV/m)= Corr. (dB/m)+ Read Level (dBμV)
3. Margin (dB) = Peak/AVG (dBμV/m)-Limit PK/AVG(dBμV/m)



Temperature:	23.4°C	Relative Humidity:	35%
Test Voltage:	AC 120V/60HZ		
Ant. Pol.	Horizontal		
Test Mode:	TX N(HT40) Mode 2422MHz ANT. A.+ANT. B		
Remark:	N/A		

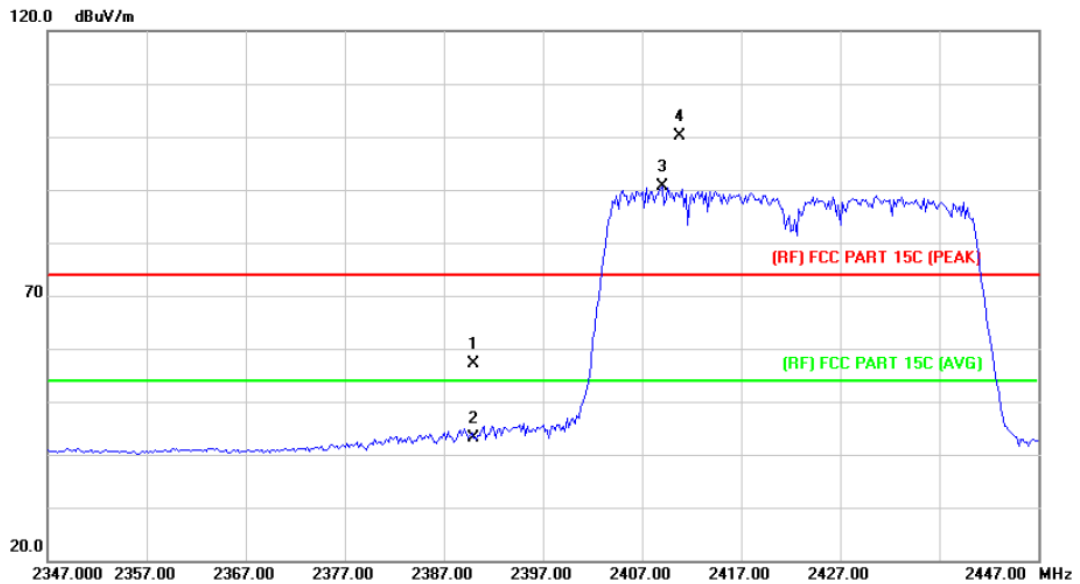

No.	Mk.	Freq. MHz	Reading Level dBuV	Correct Factor dB/m	Measure- ment dBuV/m	Limit dBuV/m	Over dB	Detector
1		2390.000	54.11	2.91	57.02	74.00	-16.98	peak
2		2390.000	40.32	2.91	43.23	54.00	-10.77	AVG
3	*	2409.000	87.58	2.98	90.56	Fundamental Frequency		AVG
4	X	2410.800	97.12	2.99	100.11	Fundamental Frequency		peak

**Remark:**

1. Corr. = Antenna Factor (dB/m) + Cable Loss (dB)
2. Peak/AVG (dBμV/m) = Corr. (dB/m) + Read Level (dBμV)
3. Margin (dB) = Peak/AVG (dBμV/m) - Limit PK/AVG (dBμV/m)

Temperature:	23.4°C	Relative Humidity:	35%
Test Voltage:	AC 120V/60HZ		
Ant. Pol.	Vertical		
Test Mode:	TX N(HT40) Mode 2422MHz ANT. A.+ANT. B		
Remark:	N/A		

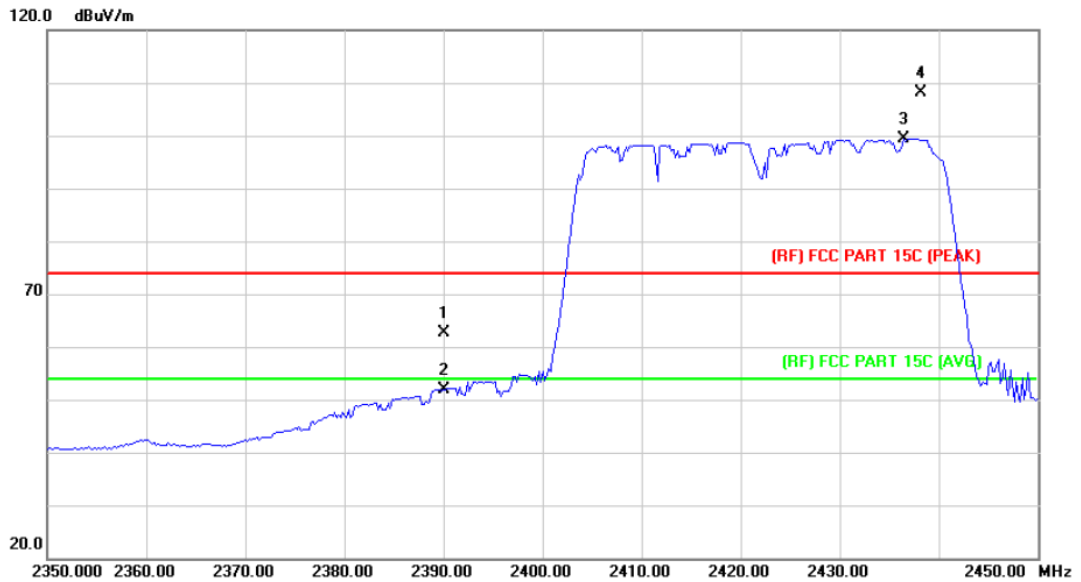

No.	Mk.	Freq. MHz	Reading Level dBuV	Correct Factor dB/m	Measure- ment dBuV/m	Limit dBuV/m	Over dB	Detector
1		2390.000	59.81	2.91	62.72	74.00	-11.28	peak
2		2390.000	49.06	2.91	51.97	54.00	-2.03	AVG
3	*	2436.400	96.32	3.13	99.45	Fundamental Frequency		AVG
4	X	2438.200	104.99	3.15	108.14	Fundamental Frequency		peak

**Remark:**

1. Corr. = Antenna Factor (dB/m) + Cable Loss (dB)
2. Peak/AVG (dBμV/m)= Corr. (dB/m)+ Read Level (dBμV)
3. Margin (dB) = Peak/AVG (dBμV/m)-Limit PK/AVG(dBμV/m)

Temperature:	23.4°C	Relative Humidity:	35%
Test Voltage:	AC 120V/60HZ		
Ant. Pol.	Horizontal		
Test Mode:	TX N(HT40) Mode 2452MHz ANT. A.+ANT. B		
Remark:	N/A		

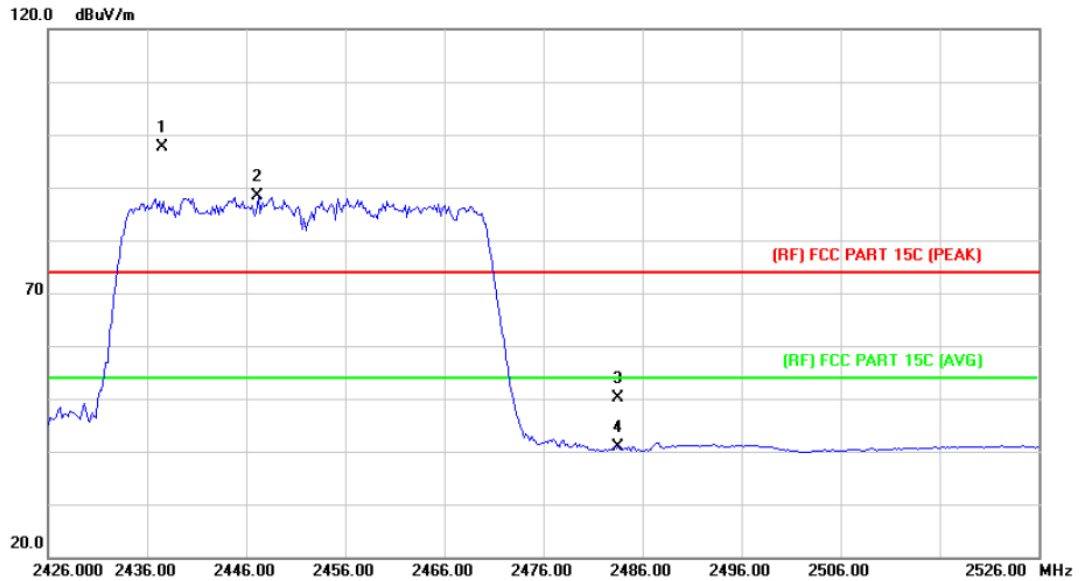

No.	Mk.	Freq. MHz	Reading Level dBuV	Correct Factor dB/m	Measure- ment dBuV/m	Limit dBuV/m	Over dB	Detector
1	X	2437.600	94.55	3.15	97.70	Fundamental Frequency		peak
2	*	2447.200	85.27	3.20	88.47	Fundamental Frequency		AVG
3		2483.500	46.68	3.40	50.08	74.00	-23.92	peak
4		2483.500	37.48	3.40	40.88	54.00	-13.12	AVG

**Remark:**

1. Corr. = Antenna Factor (dB/m) + Cable Loss (dB)
2. Peak/AVG (dBμV/m)= Corr. (dB/m)+ Read Level (dBμV)
3. Margin (dB) = Peak/AVG (dBμV/m)-Limit PK/AVG(dBμV/m)

Temperature:	23.4°C	Relative Humidity:	35%
Test Voltage:	AC 120V/60HZ		
Ant. Pol.	Vertical		
Test Mode:	TX N(HT40) Mode 2452MHz ANT. A.+ANT. B		
Remark:	N/A		

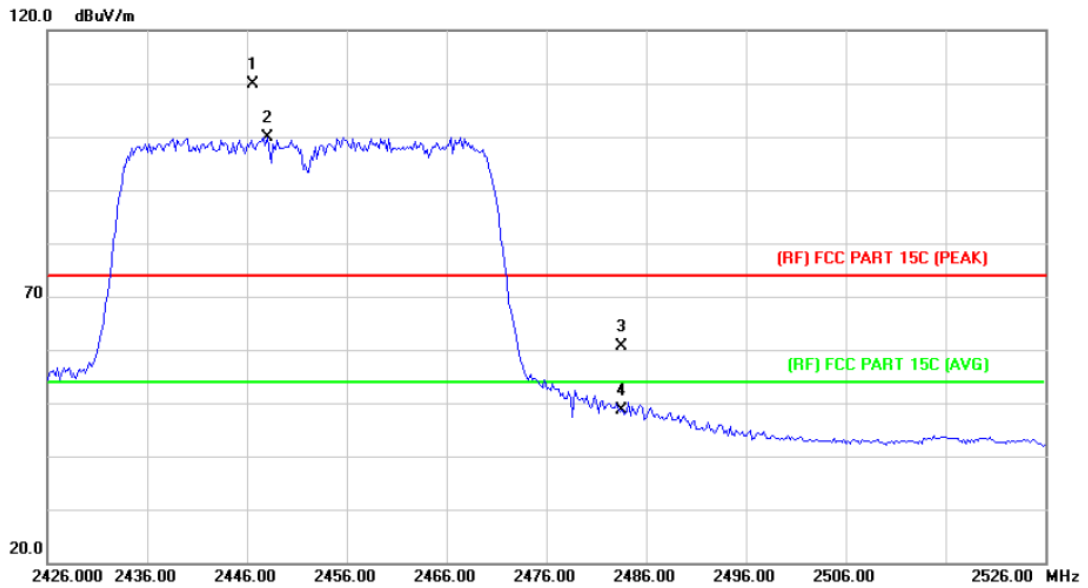

No.	Mk.	Freq. MHz	Reading Level dBuV	Correct Factor dB/m	Measure- ment dBuV/m	Limit dBuV/m	Over dB	Detector
1	X	2446.600	106.73	3.19	109.92	Fundamental Frequency		peak
2	*	2448.000	96.74	3.20	99.94	Fundamental Frequency		AVG
3		2483.500	57.33	3.40	60.73	74.00	-13.27	peak
4		2483.500	45.11	3.40	48.51	54.00	-5.49	AVG

**Remark:**

1. Corr. = Antenna Factor (dB/m) + Cable Loss (dB)
2. Peak/AVG (dBuV/m) = Corr. (dB/m) + Read Level (dBuV)
3. Margin (dB) = Peak/AVG (dBuV/m) - Limit PK/AVG (dBuV/m)

**(2) Conducted Test**

Temperature:	25°C	Relative Humidity:	55%
Test Voltage:	AC 120V/60HZ		
Test Mode:	TX B Mode 2412MHz / TX B Mode 2462MHz ANT. A		
Remark:	The EUT is programmed in continuously transmitting mode		

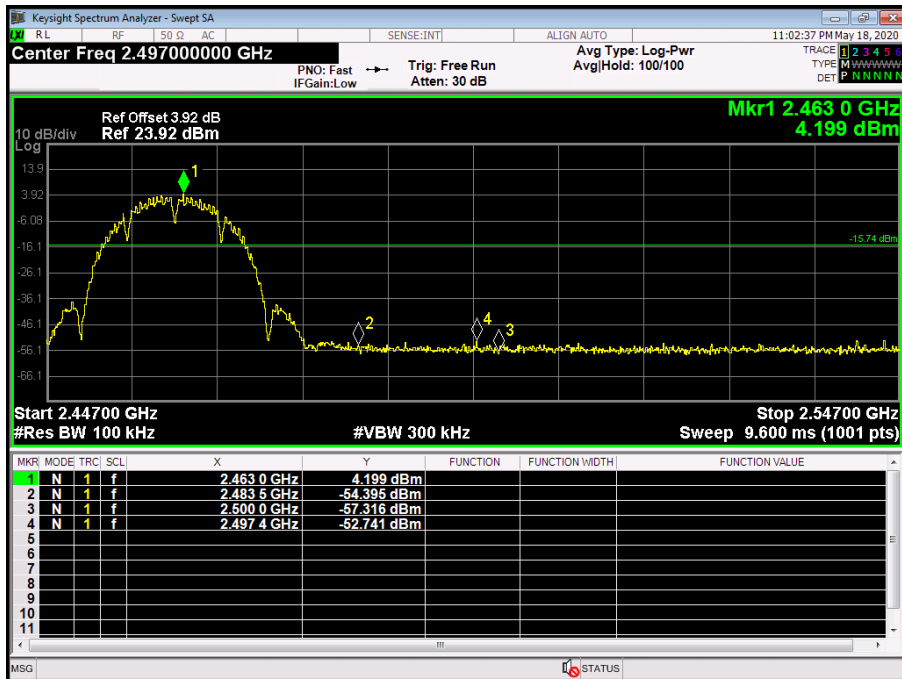
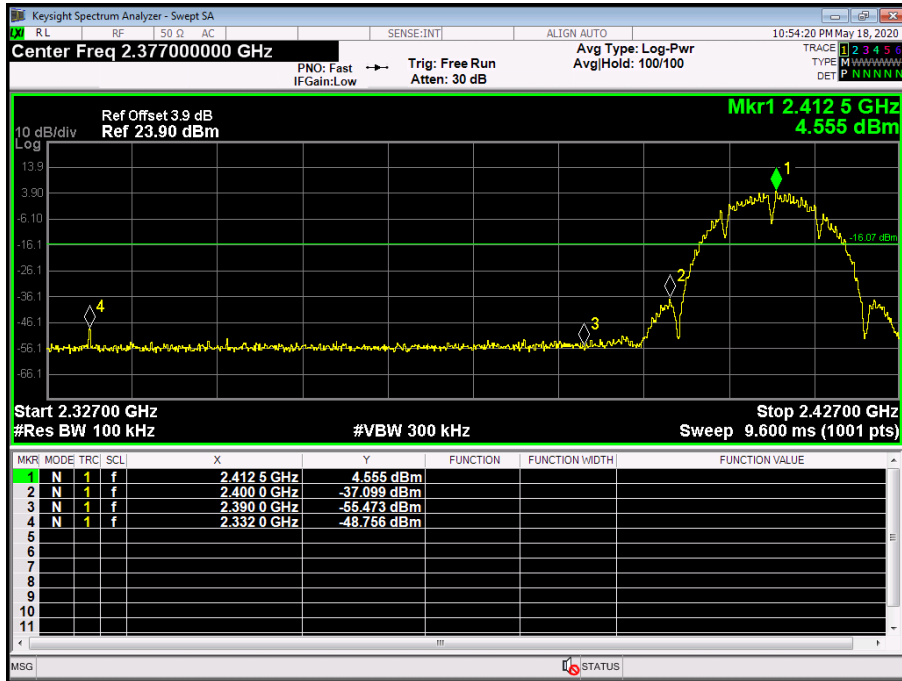

Temperature:	25°C	Relative Humidity:	55%
Test Voltage:	AC 120V/60HZ		
Test Mode:	TX B Mode 2412MHz / TX B Mode 2462MHz ANT. B		
Remark:	The EUT is programmed in continuously transmitting mode		

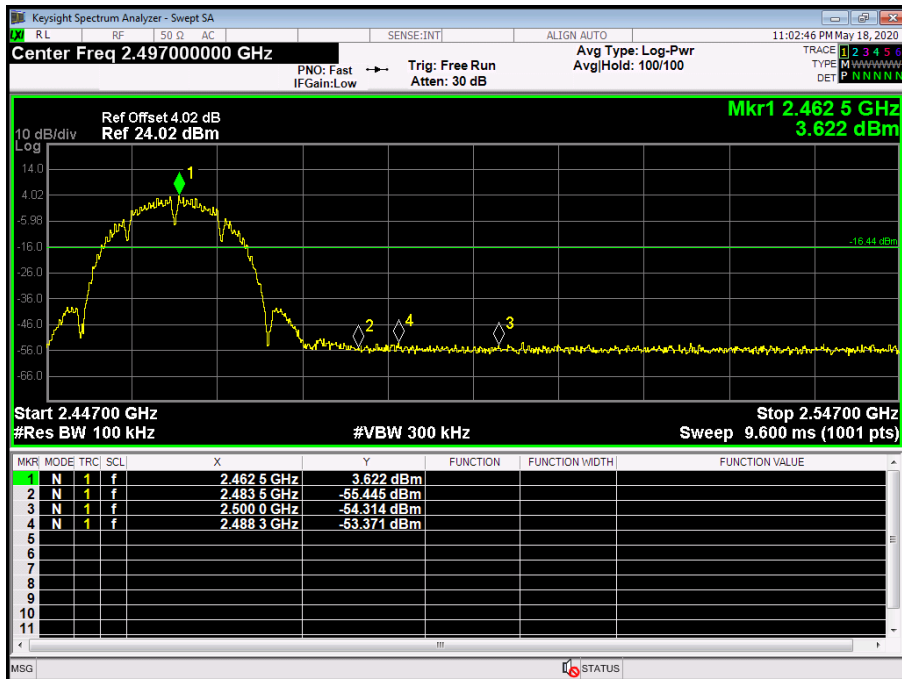
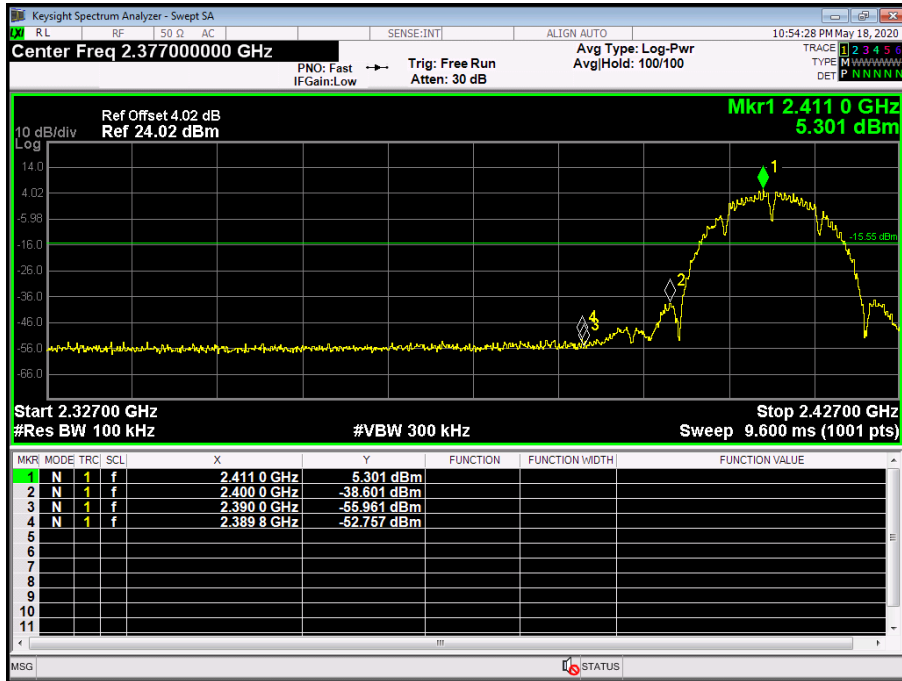

Temperature:	25°C	Relative Humidity:	55%
Test Voltage:	AC 120V/60HZ		
Test Mode:	TX G Mode 2412MHz / TX G Mode 2462MHz ANT. A		
Remark:	The EUT is programmed in continuously transmitting mode		

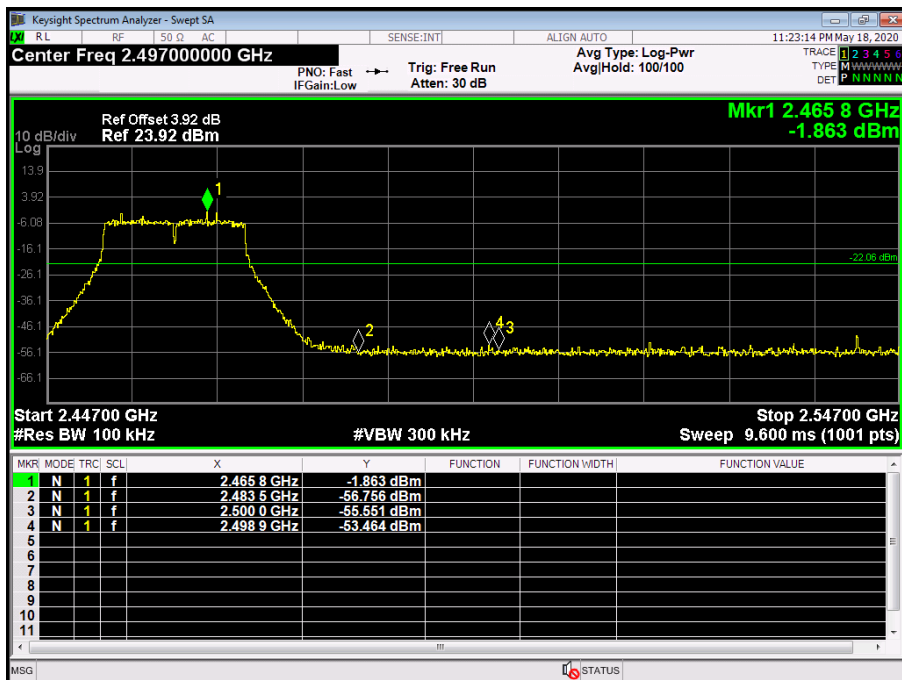
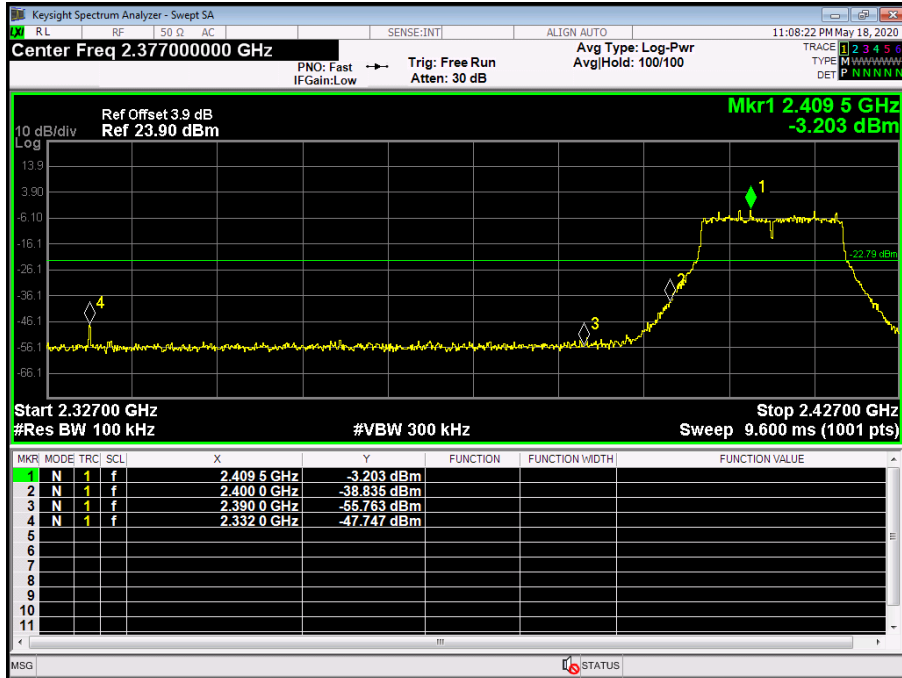

Temperature:	25°C	Relative Humidity:	55%
Test Voltage:	AC 120V/60HZ		
Test Mode:	TX G Mode 2412MHz / TX G Mode 2462MHz ANT. B		
Remark:	The EUT is programmed in continuously transmitting mode		

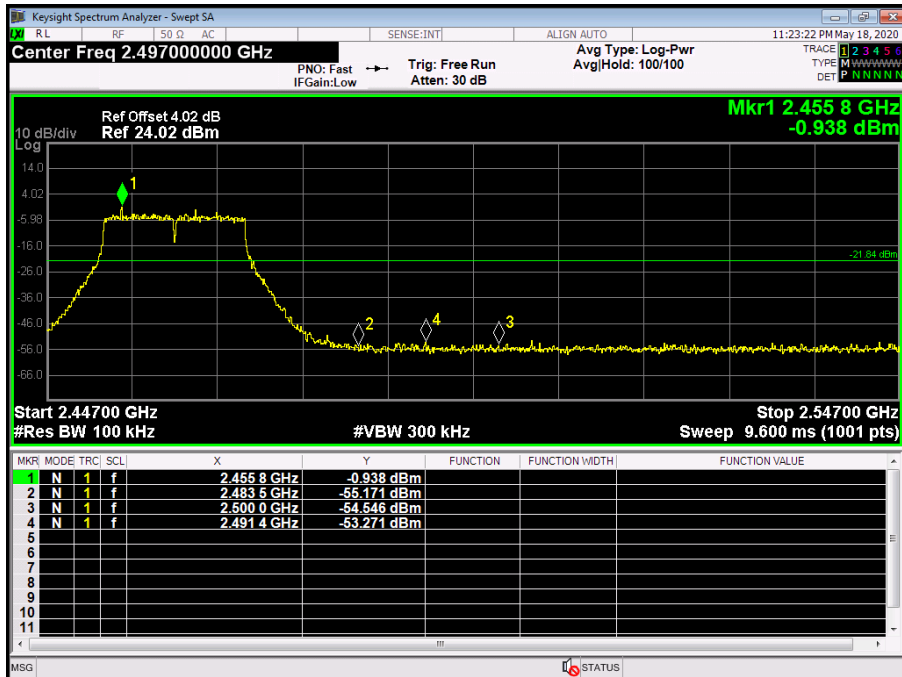
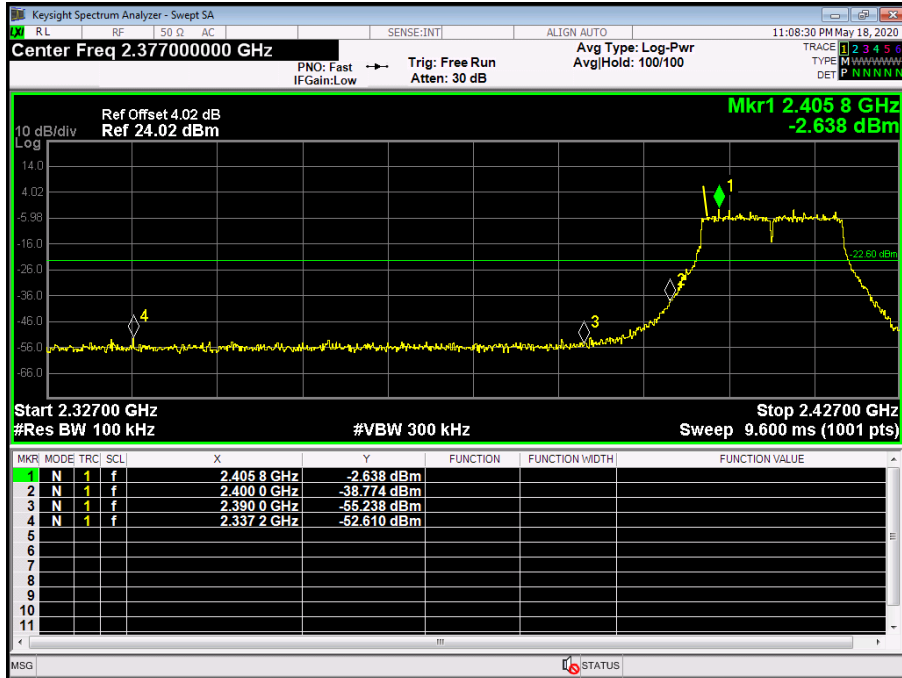



Temperature:	25°C	Relative Humidity:	55%
Test Voltage:	AC 120V/60HZ		
Test Mode:	TX N(HT20) Mode 2412MHz / TX N(HT20) Mode 2462MHz ANT. A		
Remark:	The EUT is programmed in continuously transmitting mode		

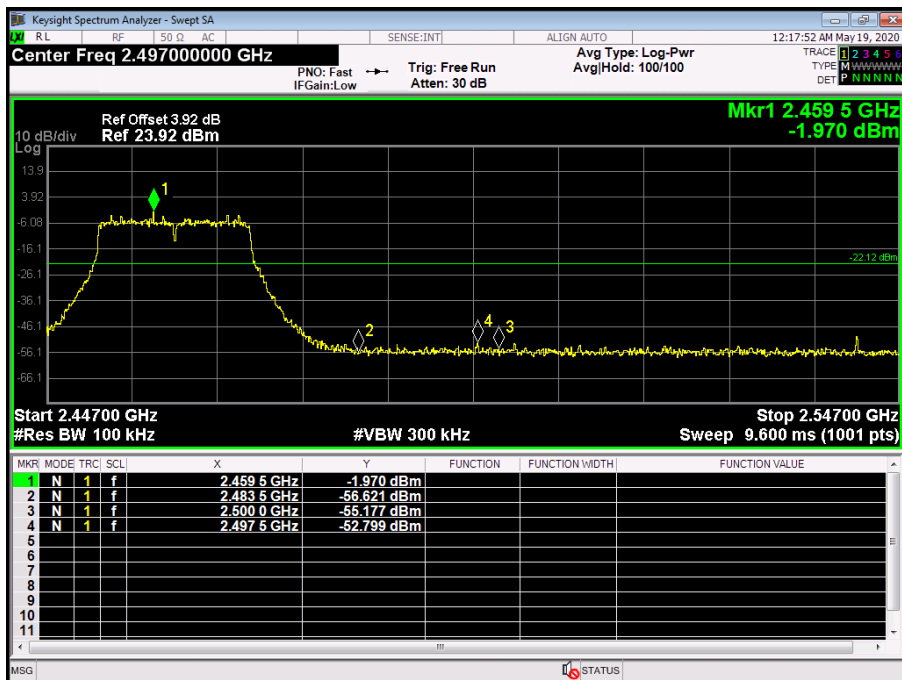
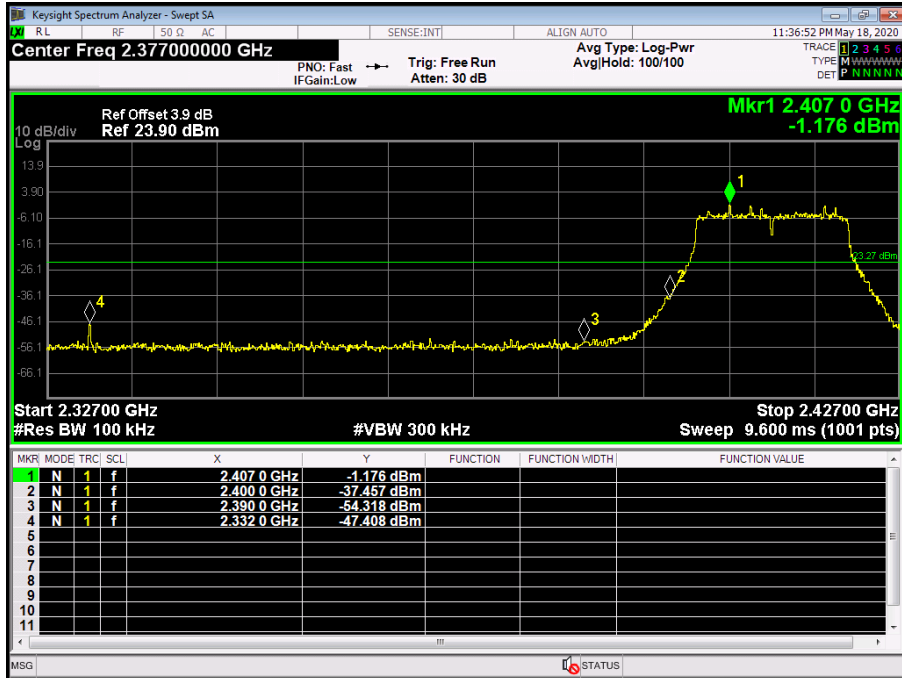

Temperature:	25°C	Relative Humidity:	55%
Test Voltage:	AC 120V/60HZ		
Test Mode:	TX N(HT20) Mode 2412MHz / TX N(HT20) Mode 2462MHz ANT. B		
Remark:	The EUT is programmed in continuously transmitting mode		

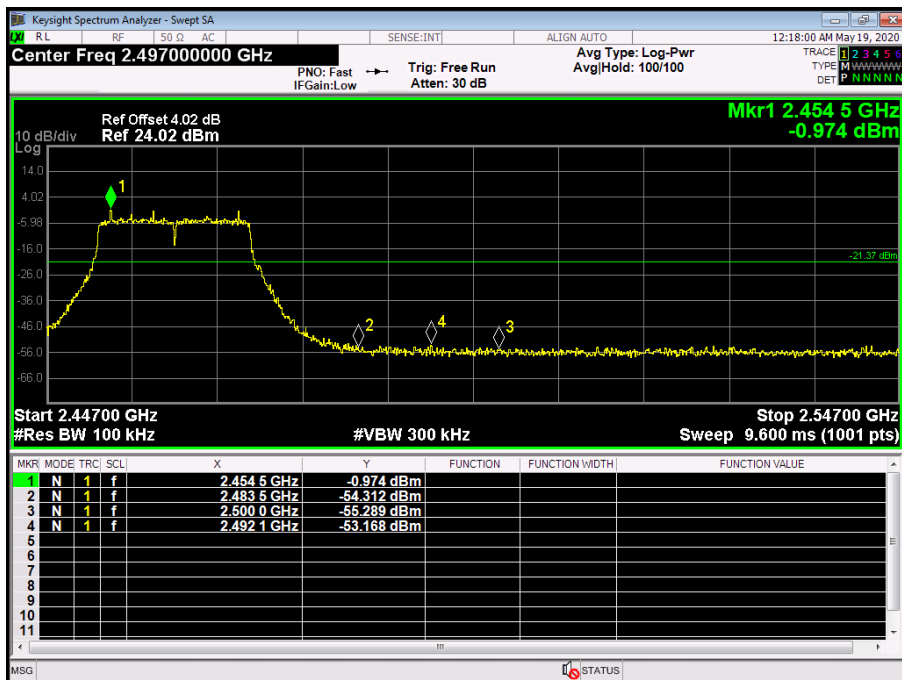
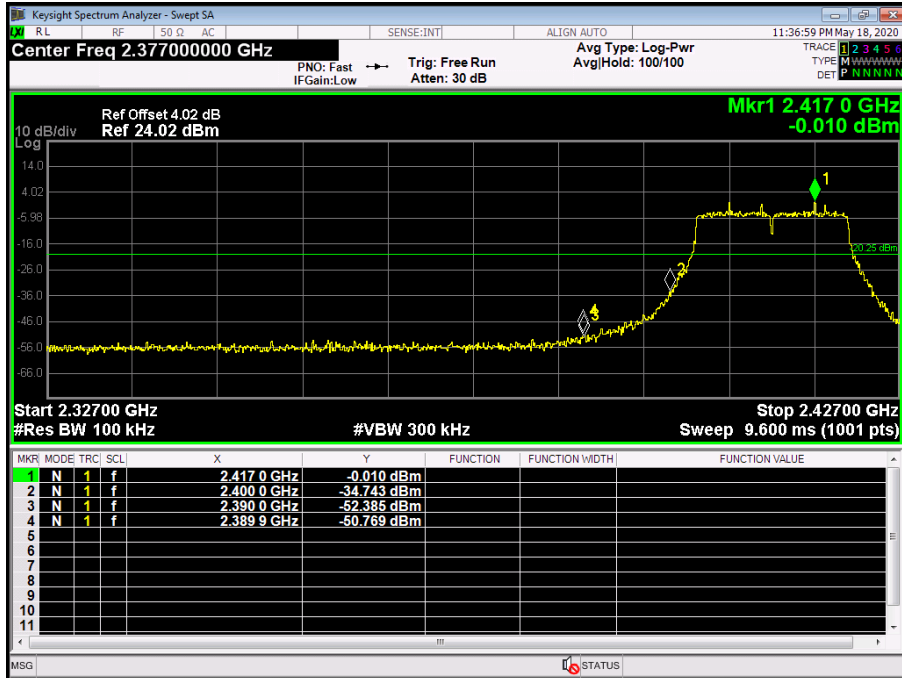

Temperature:	25°C	Relative Humidity:	55%
Test Voltage:	AC 120V/60HZ		
Test Mode:	TX N(HT40) Mode 2422MHz / TX N(HT40) Mode 2452MHz ANT. A		
Remark:	The EUT is programmed in continuously transmitting mode		

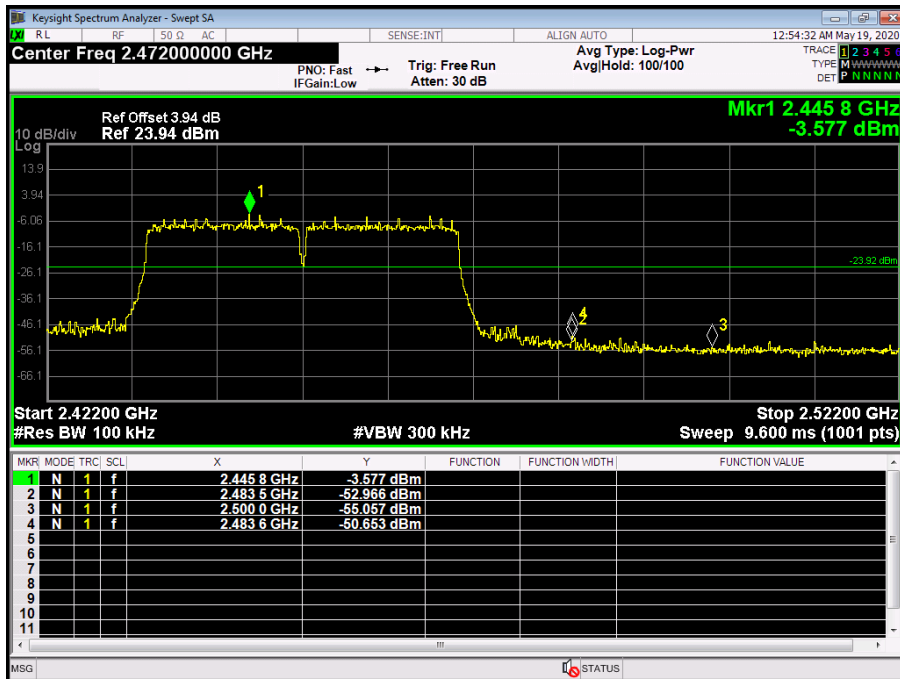
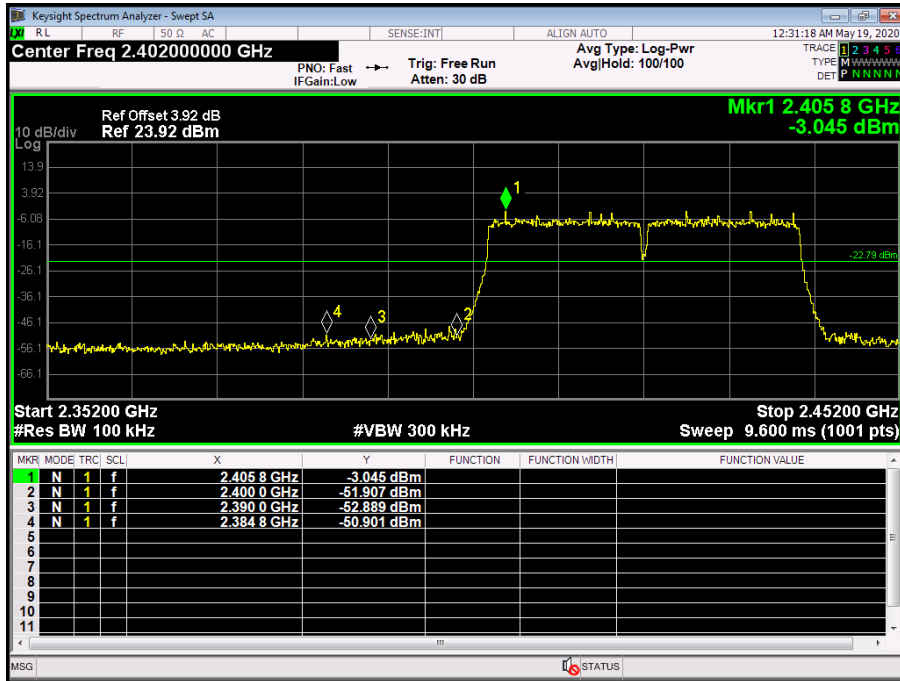

Temperature:	25°C	Relative Humidity:	55%
Test Voltage:	AC 120V/60HZ		
Test Mode:	TX N(HT40) Mode 2422MHz / TX N(HT40) Mode 2452MHz ANT. B		
Remark:	The EUT is programmed in continuously transmitting mode		

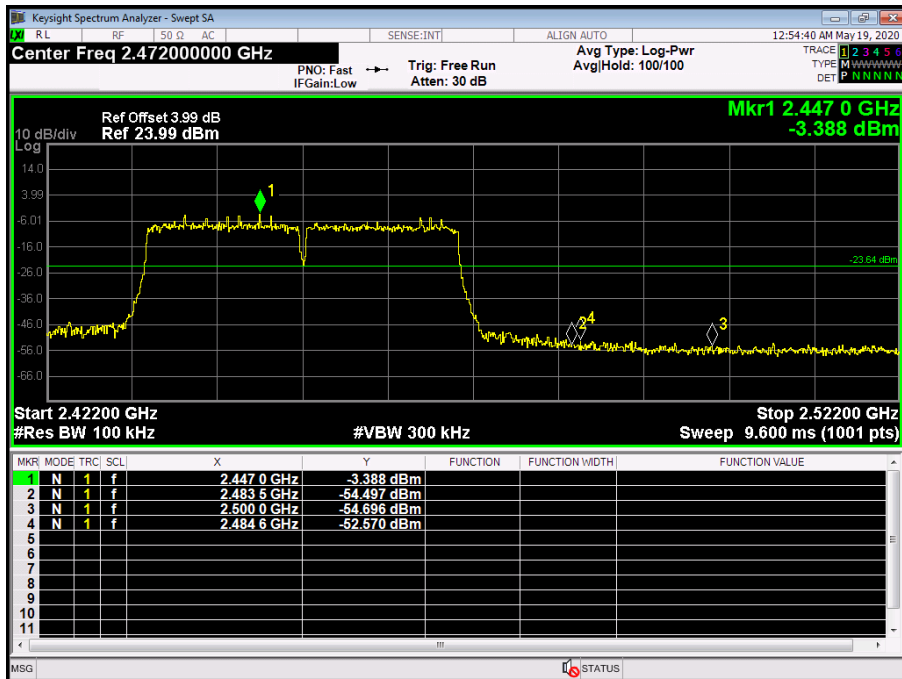
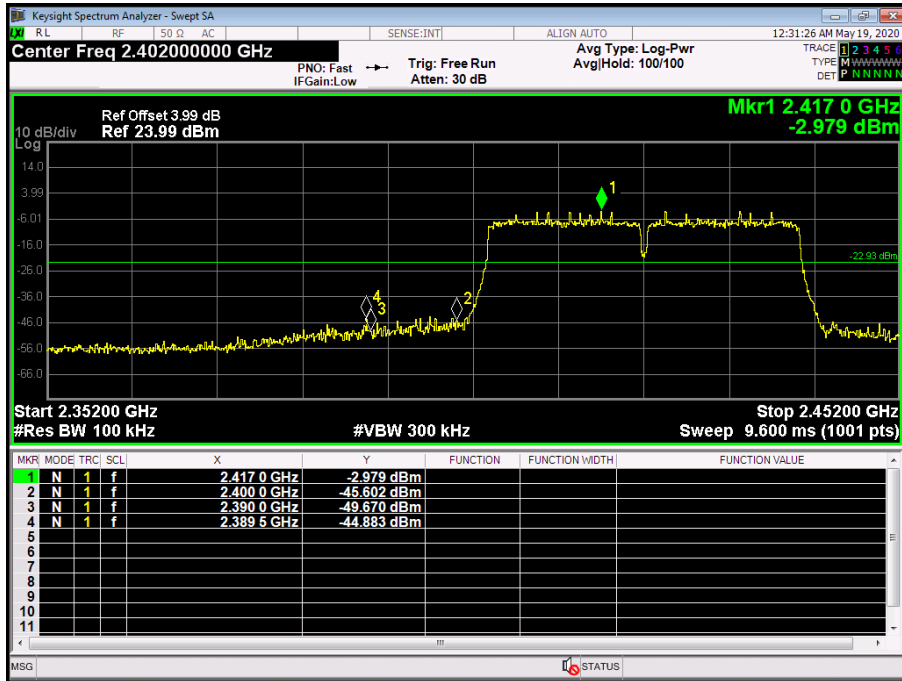

## Attachment D-- Bandwidth Test Data

Temperature:	25°C	Relative Humidity:	55%
Test Voltage:	AC 120V/60HZ		
Test Mode:	TX 802.11B Mode ANT. A		
Channel frequency (MHz)	6dB Bandwidth (MHz)	99% Bandwidth (MHz)	Limit (MHz)
2412	9.033	14.928	>=0.5
2437	8.384	14.887	
2462	9.046	14.861	
<b>802.11B Mode</b>			
<b>2412 MHz</b>			

**802.11B Mode**  
**2437 MHz**

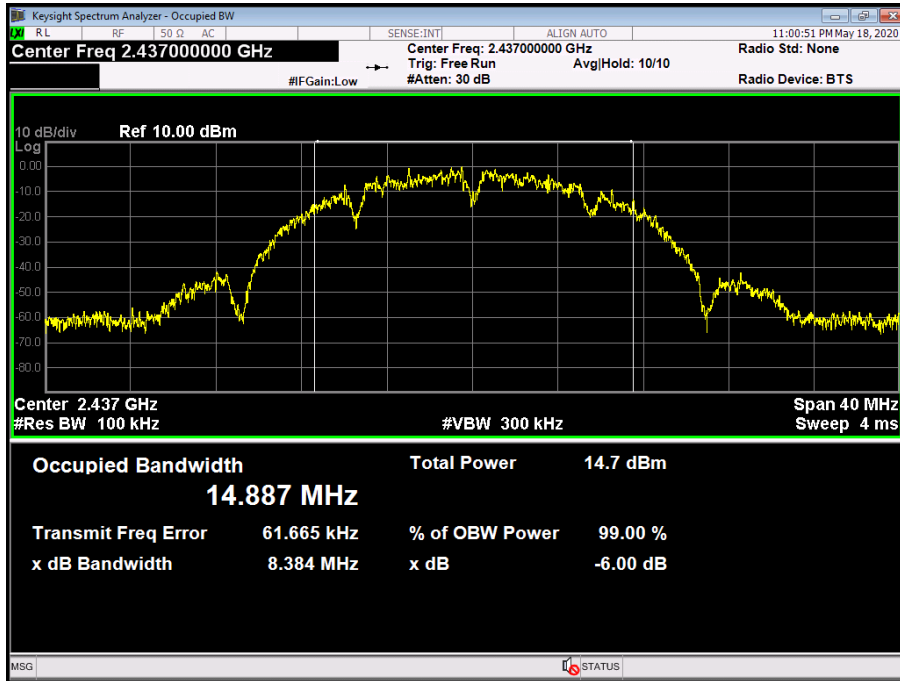

**802.11B Mode**  
**2462 MHz**

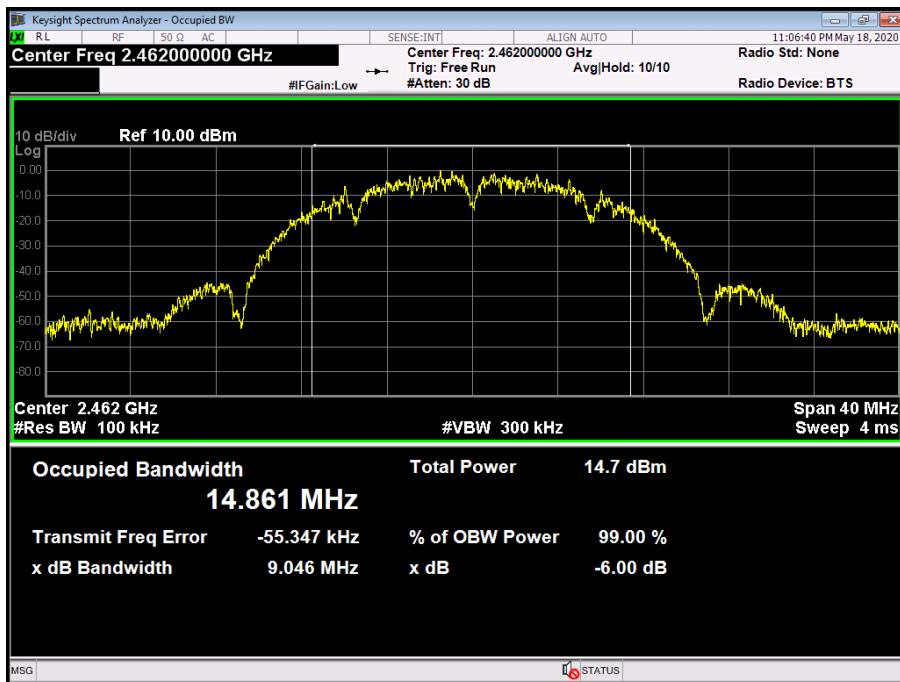

<b>Temperature:</b>	25°C	<b>Relative Humidity:</b>	55%
<b>Test Voltage:</b>	AC 120V/60HZ		
<b>Test Mode:</b>	TX 802.11B Mode ANT. B		
<b>Channel frequency (MHz)</b>	<b>6dB Bandwidth (MHz)</b>	<b>99% Bandwidth (MHz)</b>	<b>Limit (MHz)</b>
2412	7.514	14.794	>=0.5
2437	9.962	14.841	
2462	9.904	14.788	

**802.11B Mode**

**2412 MHz**

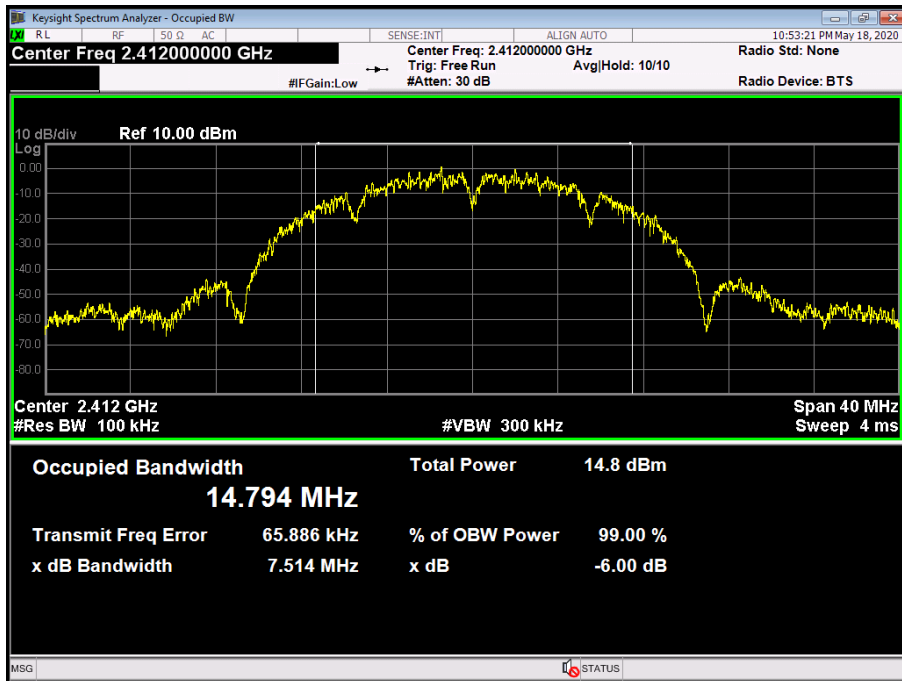

**802.11B Mode**  
**2437 MHz**

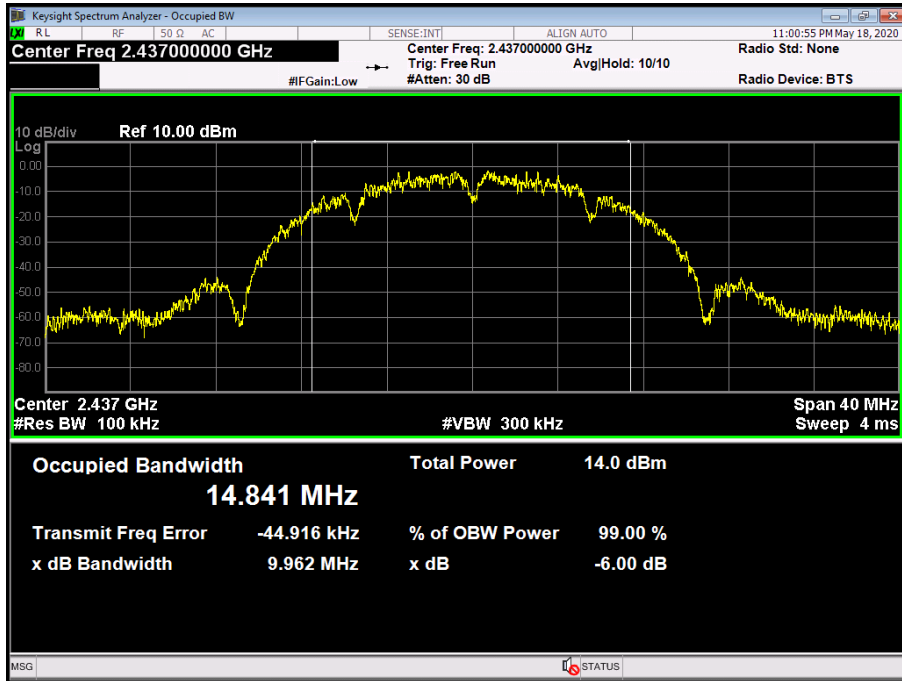

**802.11B Mode**  
**2462 MHz**

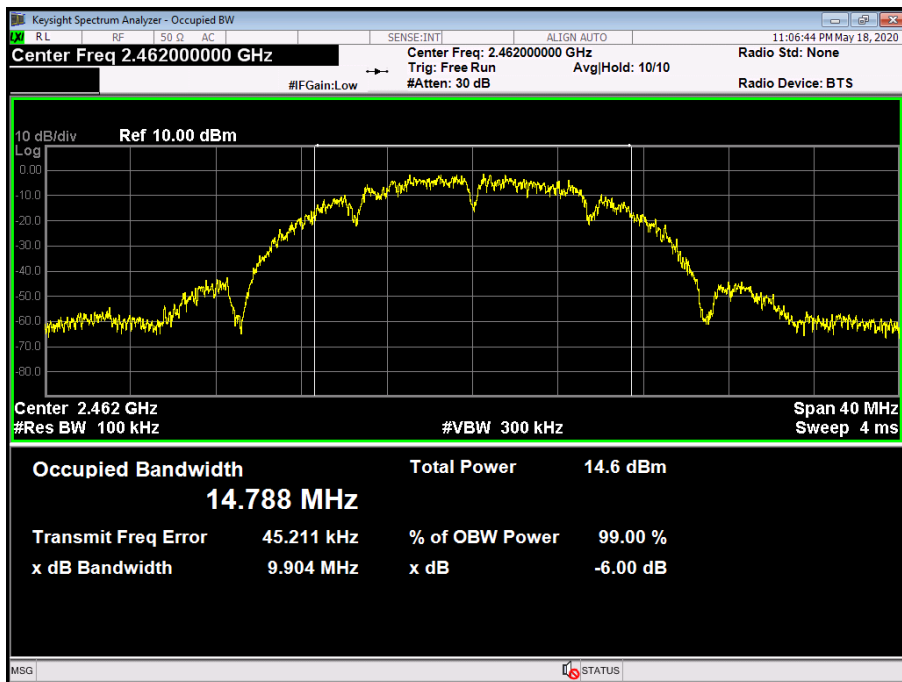



Temperature:	25°C	Relative Humidity:	55%
Test Voltage:	AC 120V/60HZ		
Test Mode:	TX 802.11G Mode ANT. A		
Channel frequency (MHz)	6dB Bandwidth (MHz)	99% Bandwidth (MHz)	Limit (MHz)
2412	16.39	16.446	>=0.5
2437	16.48	16.481	
2462	16.49	16.419	

**802.11G Mode**

**2412 MHz**

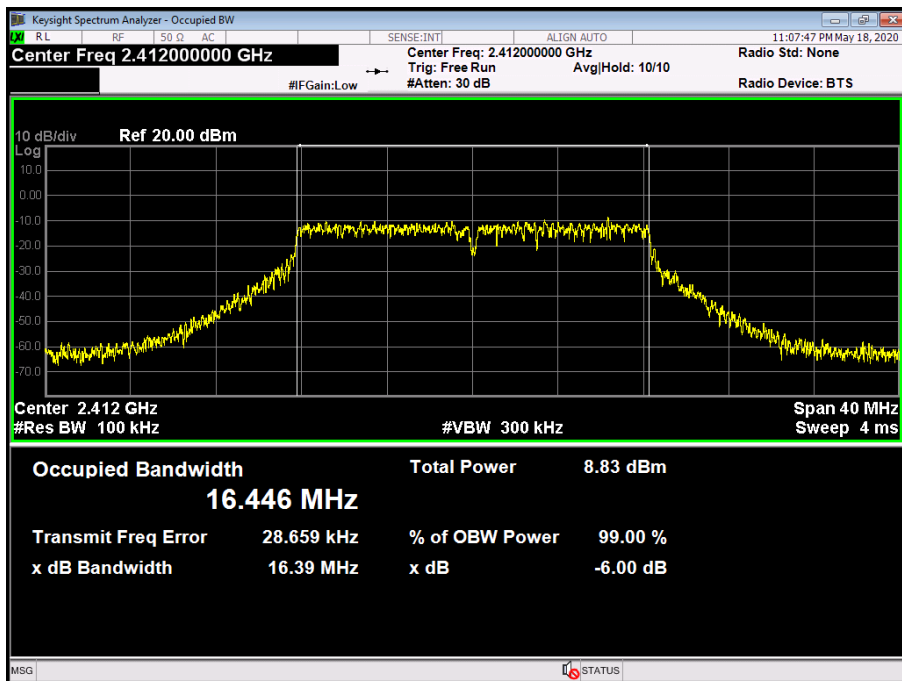

**802.11G Mode**  
**2437 MHz**

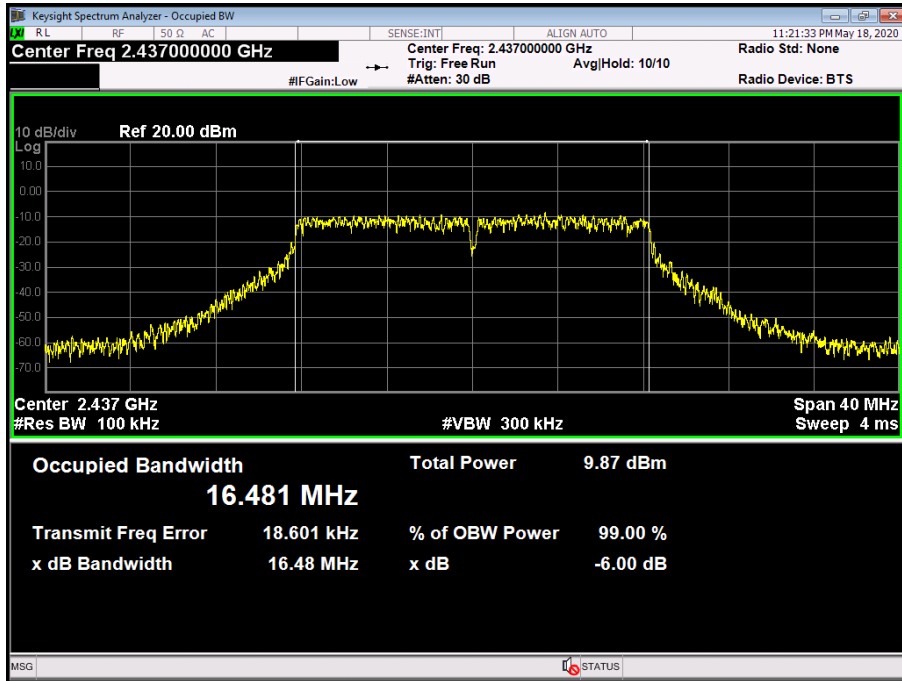

**802.11G Mode**  
**2462 MHz**

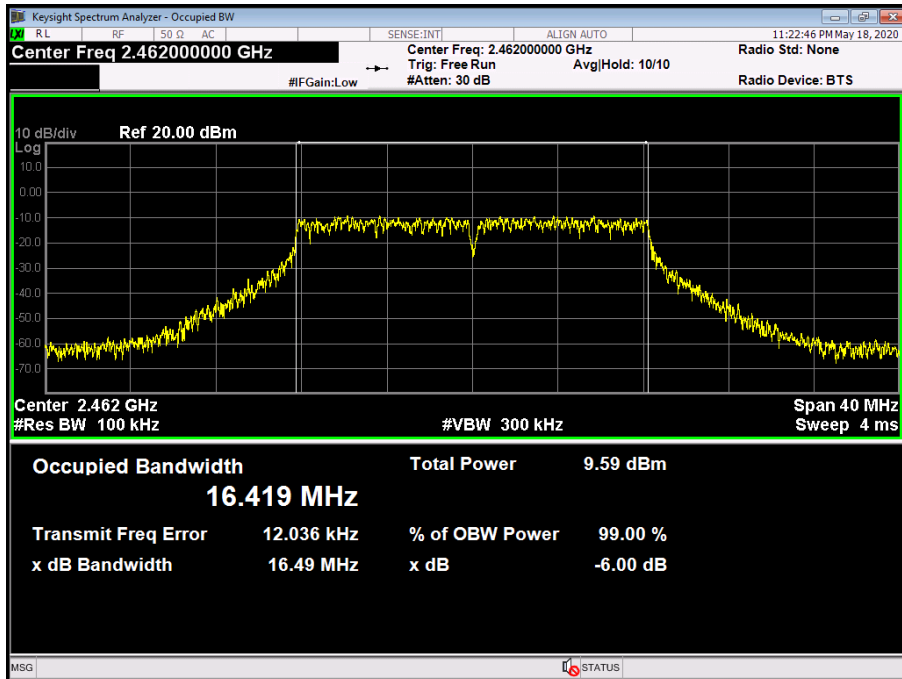

<b>Temperature:</b>	25°C	<b>Relative Humidity:</b>	55%
<b>Test Voltage:</b>	AC 120V/60HZ		
<b>Test Mode:</b>	TX 802.11G Mode ANT. B		
Channel frequency (MHz)	6dB Bandwidth (MHz)	99% Bandwidth (MHz)	Limit (MHz)
2412	16.52	16.432	>=0.5
2437	16.09	16.427	
2462	16.49	16.455	

**802.11G Mode**

**2412 MHz**

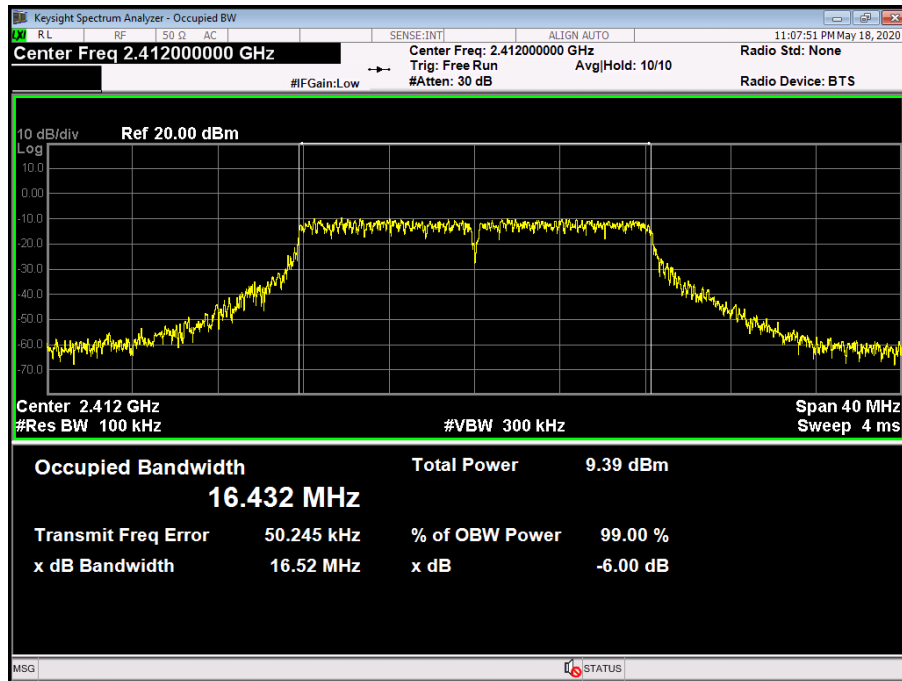

**802.11G Mode**  
**2437 MHz**

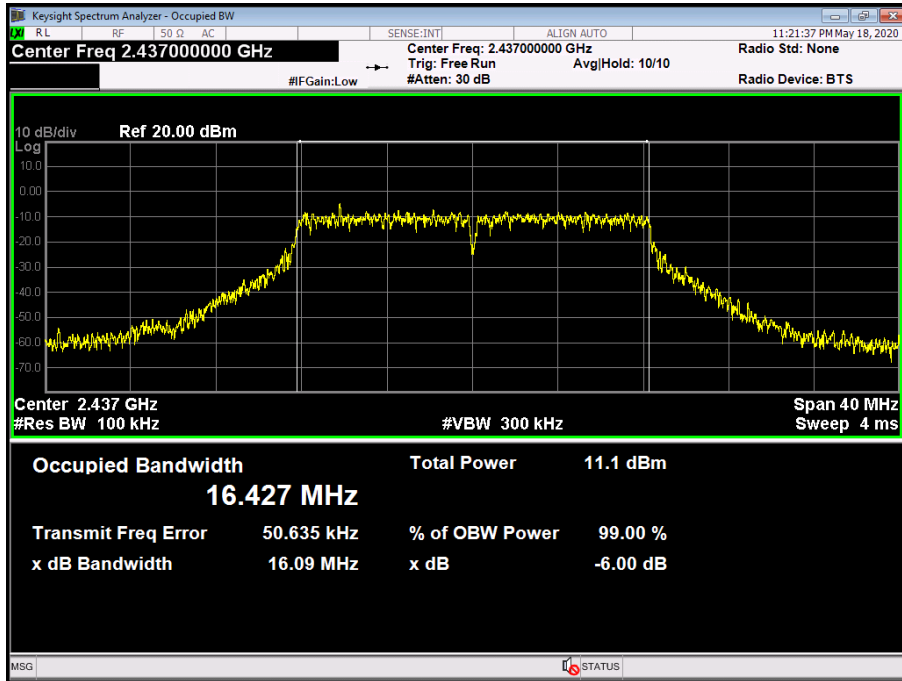

**802.11G Mode**  
**2462 MHz**

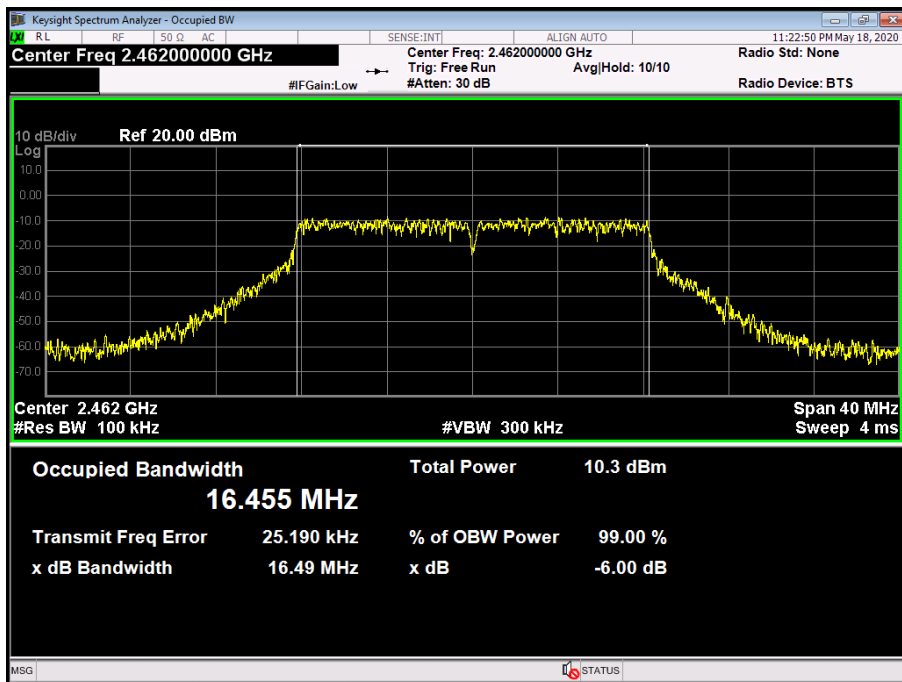

Temperature:	25°C	Relative Humidity:	55%
Test Voltage:	AC 120V/60HZ		
Test Mode:	TX 802.11N(HT20) Mode ANT. A		
Channel frequency (MHz)	6dB Bandwidth (MHz)	99% Bandwidth (MHz)	Limit (MHz)
2412	17.60	17.664	>=0.5
2437	16.81	17.662	
2462	17.78	17.665	

**802.11N(HT20) Mode**

**2412 MHz**

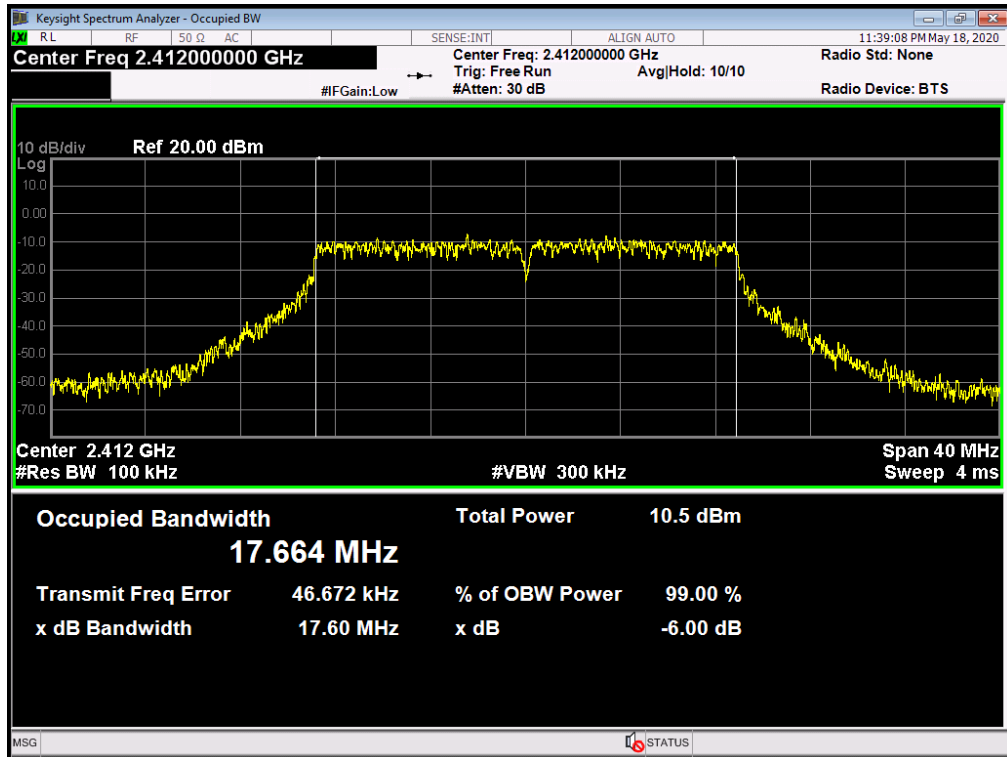

**802.11N(HT20) Mode**

**2437 MHz**

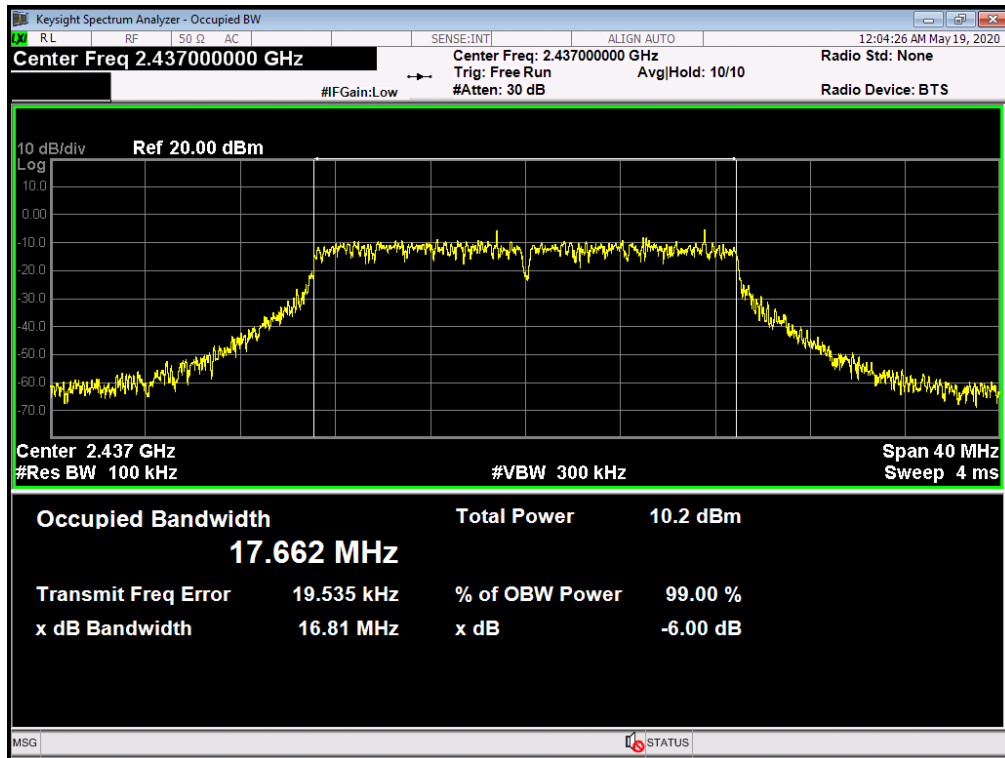

**802.11N(HT20) Mode**

**2462 MHz**

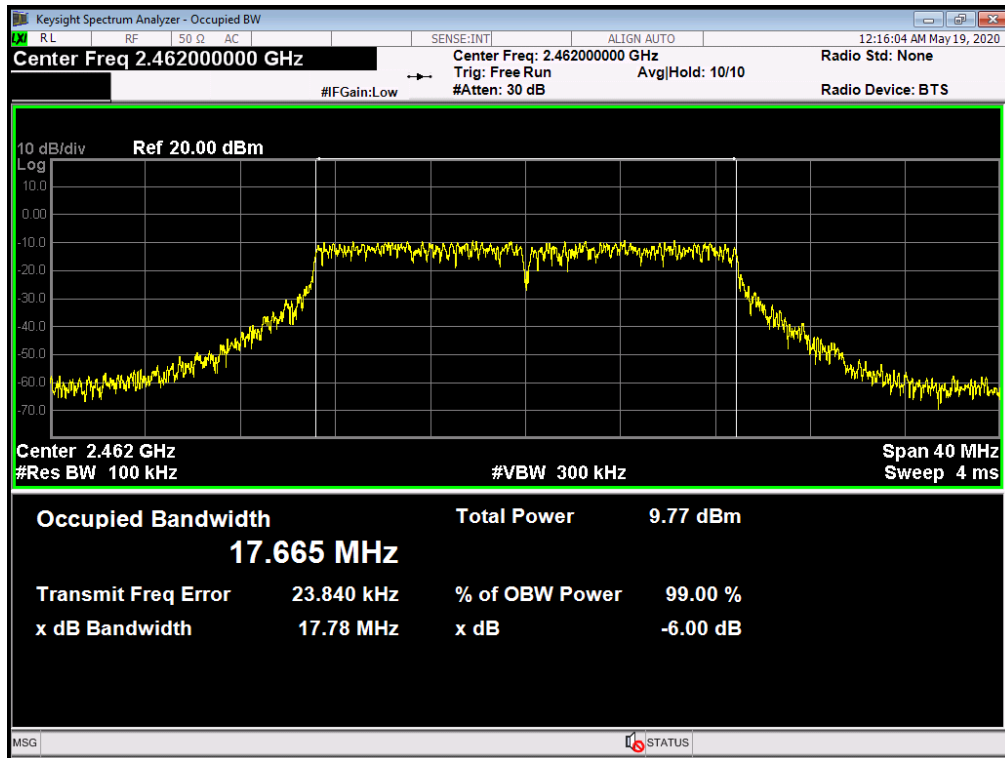

Temperature:	25°C	Relative Humidity:	55%
Test Voltage:	AC 120V/60HZ		
Test Mode:	TX 802.11N(HT20) Mode ANT. B		
Channel frequency (MHz)	6dB Bandwidth (MHz)	99% Bandwidth (MHz)	Limit (MHz)
2412	17.59	17.642	>=0.5
2437	17.63	17.667	
2462	17.60	17.655	

**802.11N(HT20) Mode**

**2412 MHz**

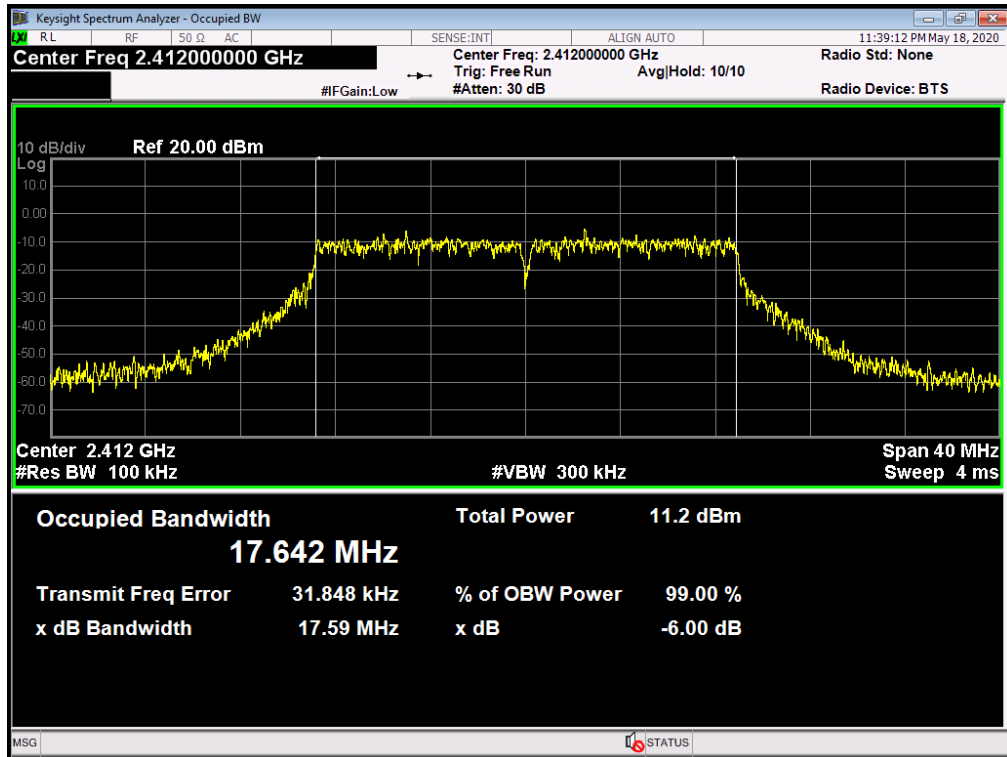

**802.11N(HT20) Mode**

**2437 MHz**

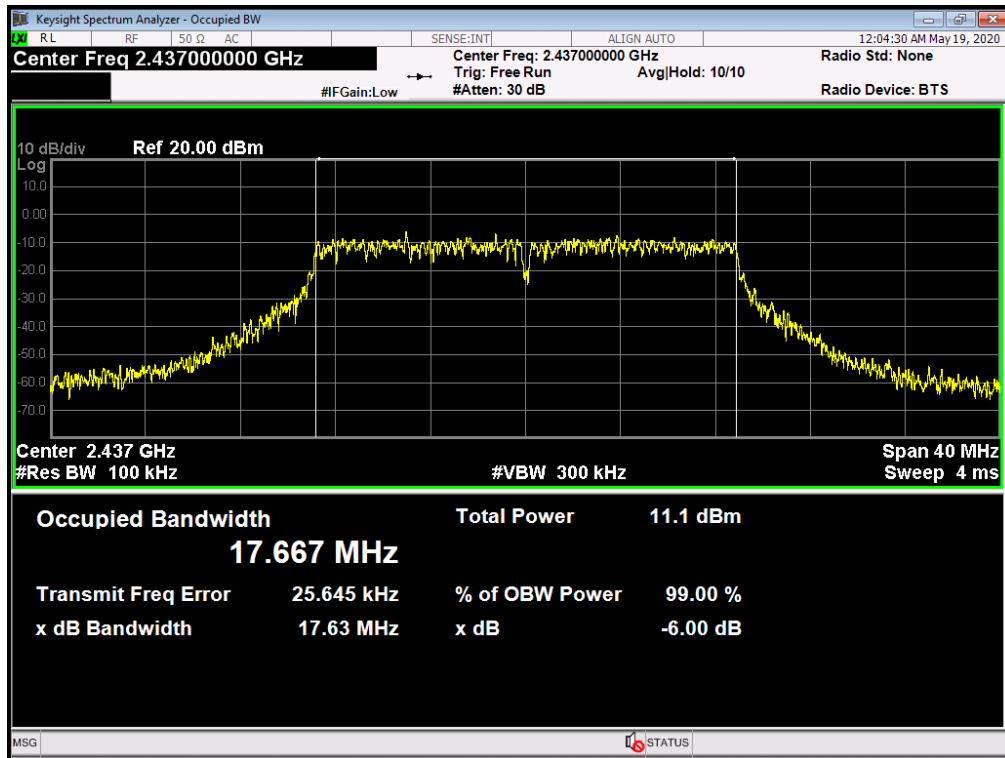

**802.11N(HT20) Mode**

**2462 MHz**

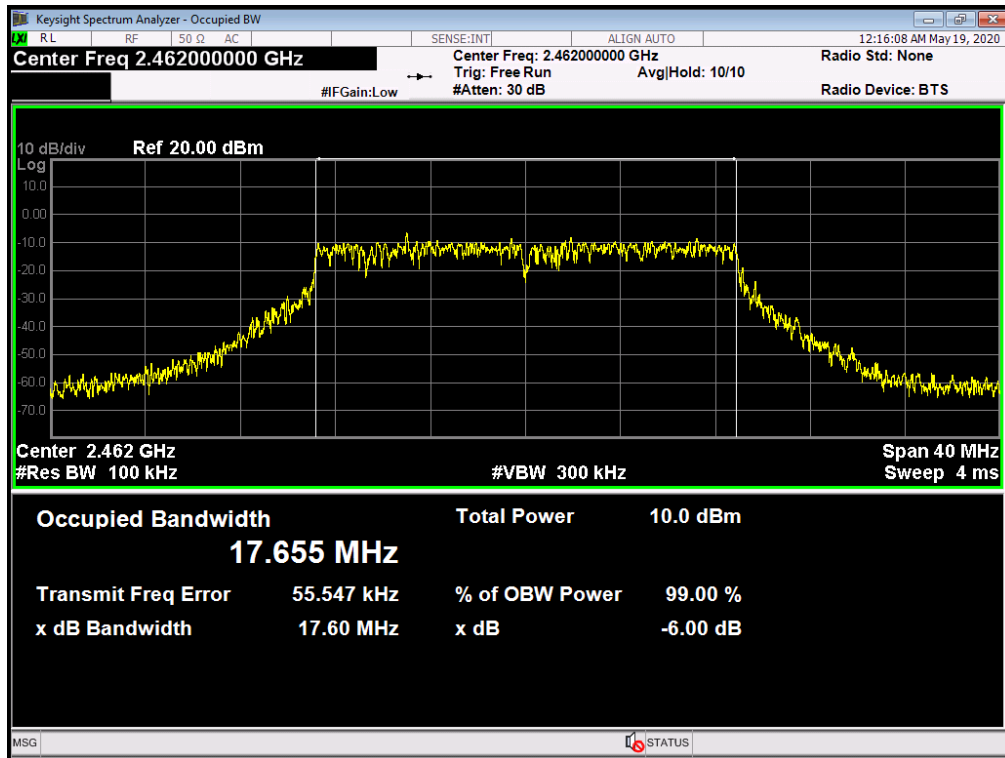



Temperature:	25°C	Relative Humidity:	55%
Test Voltage:	AC 120V/60HZ		
Test Mode:	TX 802.11N(HT40) Mode ANT. A		
Channel frequency (MHz)	6dB Bandwidth (MHz)	99% Bandwidth (MHz)	Limit (MHz)
2422	34.75	36.152	>=0.5
2437	36.01	36.122	
2452	35.31	36.209	

**802.11N(HT40) Mode**

**2422 MHz**

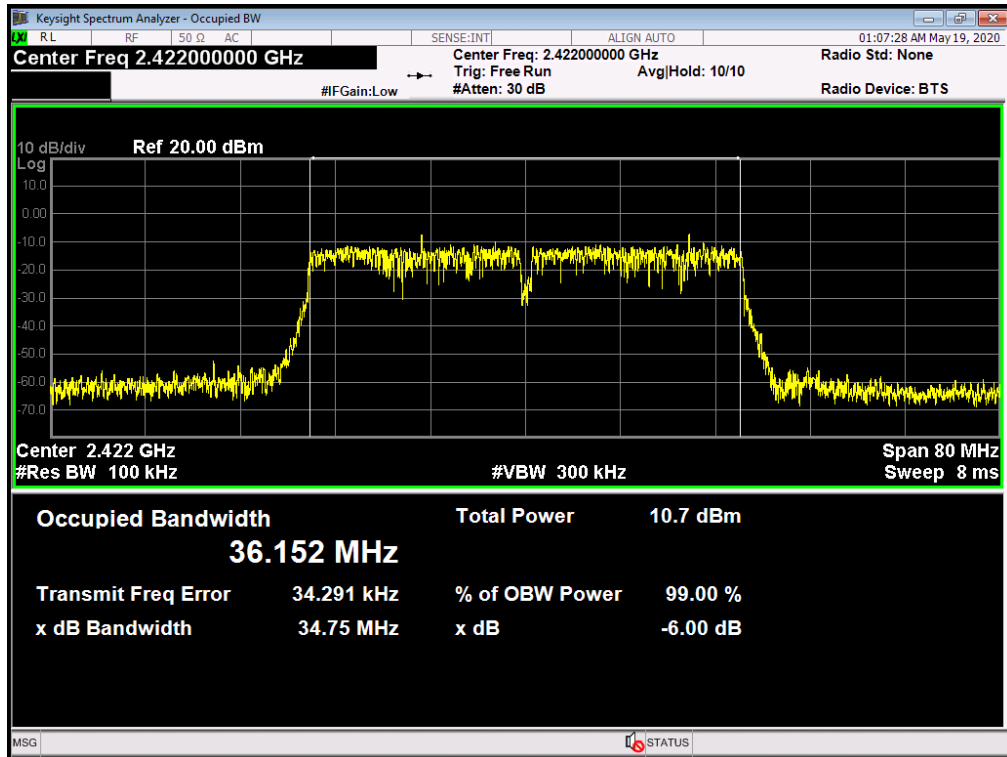

**802.11N(HT40) Mode**

**2437 MHz**

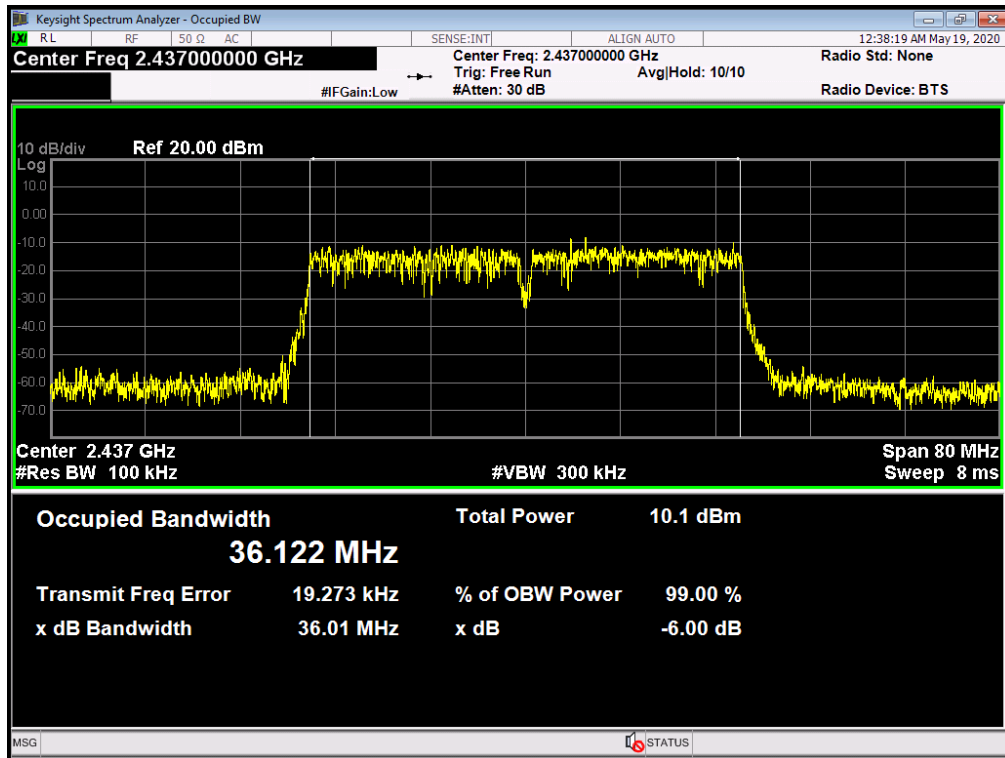

**802.11N(HT40) Mode**

**2452 MHz**

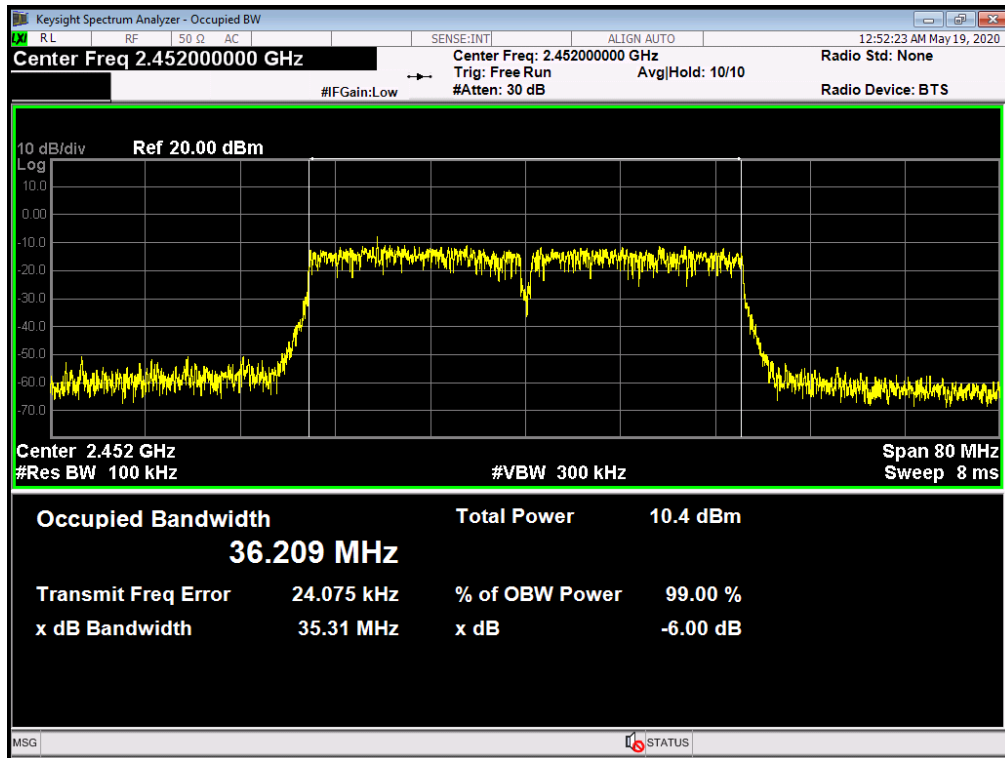

Temperature:	25°C	Relative Humidity:	55%
Test Voltage:	AC 120V/60HZ		
Test Mode:	TX 802.11N(HT40) Mode ANT. B		
Channel frequency (MHz)	6dB Bandwidth (MHz)	99% Bandwidth (MHz)	Limit (MHz)
2422	36.38	36.116	>=0.5
2437	35.99	36.027	
2452	35.30	36.119	

**802.11N(HT40) Mode**

**2422 MHz**

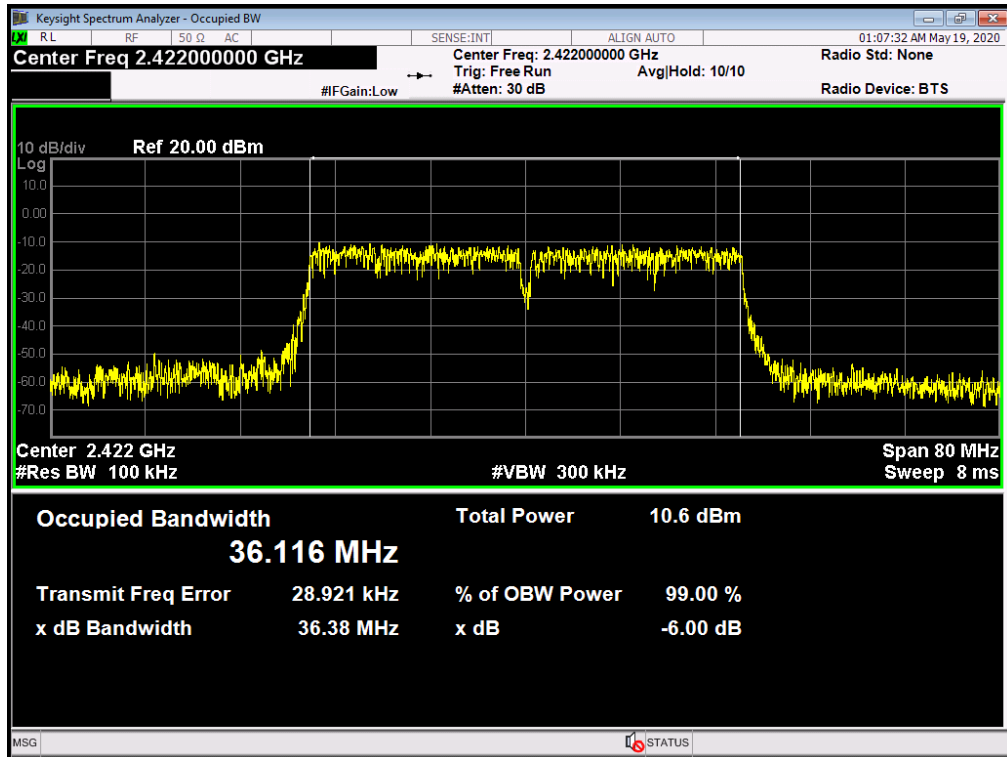

**802.11N(HT40) Mode**

**2437 MHz**

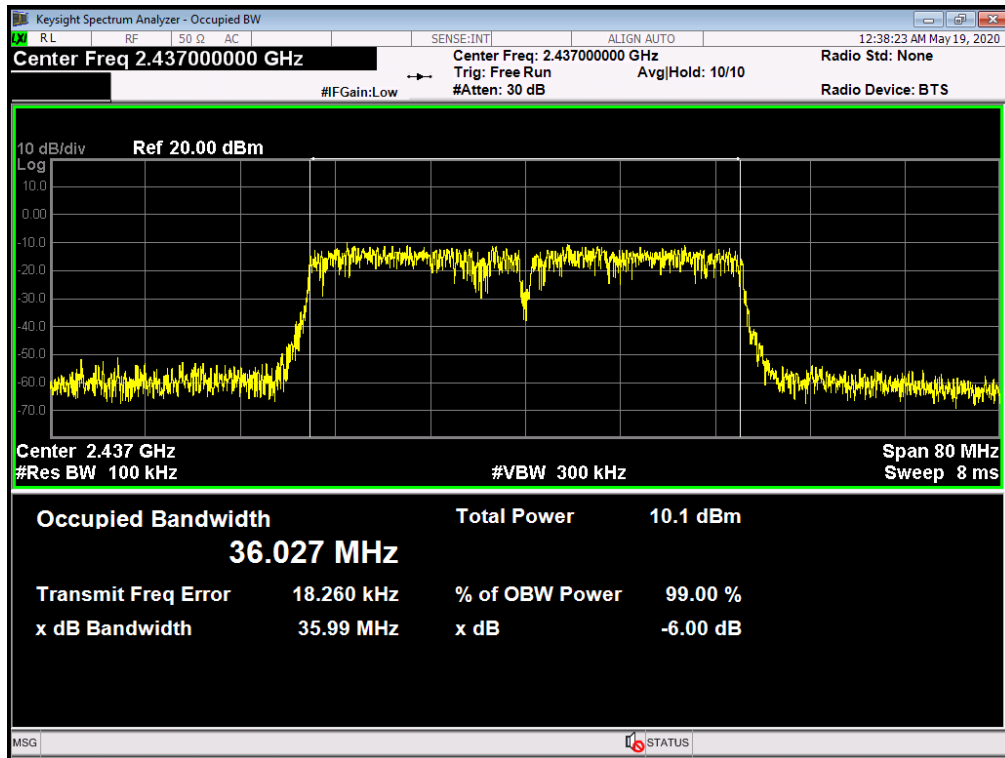

**802.11N(HT40) Mode**

**2452 MHz**

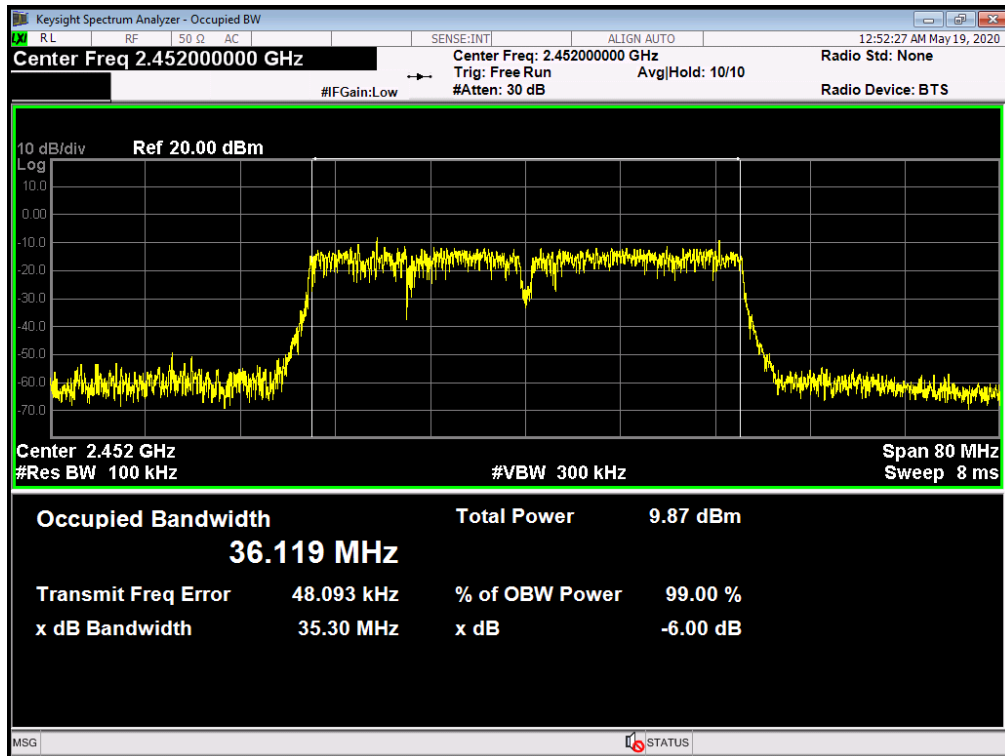

## Attachment E-- Peak Output Power Test Data

Conducted Power					
802.11b Power					
Channel	Frequency	Conducted Power (dBm)			Max. Limit (dBm)
		ANT. A.	ANT. B	Total	
1	2412 MHz	14.827	15.665	18.276	27.99
6	2437 MHz	15.152	14.696	17.940	
11	2462 MHz	15.248	15.474	18.373	
802.11g Power					
Channel	Frequency	Conducted Power (dBm)			Max. Limit (dBm)
		ANT. A.	ANT. B	Total	
1	2412 MHz	14.904	15.531	18.239	27.99
6	2437 MHz	14.940	15.756	18.377	
11	2462 MHz	14.428	15.153	18.156	
802.11n(HT20) Power					
Channel	Frequency	Conducted Power (dBm)			Max. Limit (dBm)
		ANT. A.	ANT. B	Total	
1	2412 MHz	14.915	15.570	18.265	27.99
6	2437 MHz	14.562	15.360	17.990	
11	2462 MHz	15.065	14.624	17.860	
802.11n(HT40) Power					
Channel	Frequency	Conducted Power (dBm)			Max. Limit (dBm)
		ANT. A.	ANT. B	Total	
3	2422 MHz	15.304	15.204	18.265	27.99
6	2437 MHz	15.157	15.112	18.145	
9	2452 MHz	14.836	14.635	17.747	
<p>Note: The ANT. A. and ANT. B will transmitting simultaneously for the 802.11b/g/n(HT20)/n(HT40) Mode, the T Directional Gain = Ant. Gain + 10*LOG(N<sub>ANT</sub>) = 8.01 dBi &gt; 6 dBi. So P<sub>out</sub> = P<sub>limit</sub> - (G<sub>TX</sub> - 6) = 30 - 2.01 = 27.99 dBm</p>					

Duty Cycle		
Mode	Channel frequency (MHz)	Test Result
802.11b	2412	>98%
	2437	
	2462	
802.11g	2412	
	2437	
	2462	
802.11n (HT20)	2412	
	2437	
	2462	
802.11n (HT40)	2422	
	2437	
	2452	
Please see below plots		

802.11 B Mode 2437 MHz

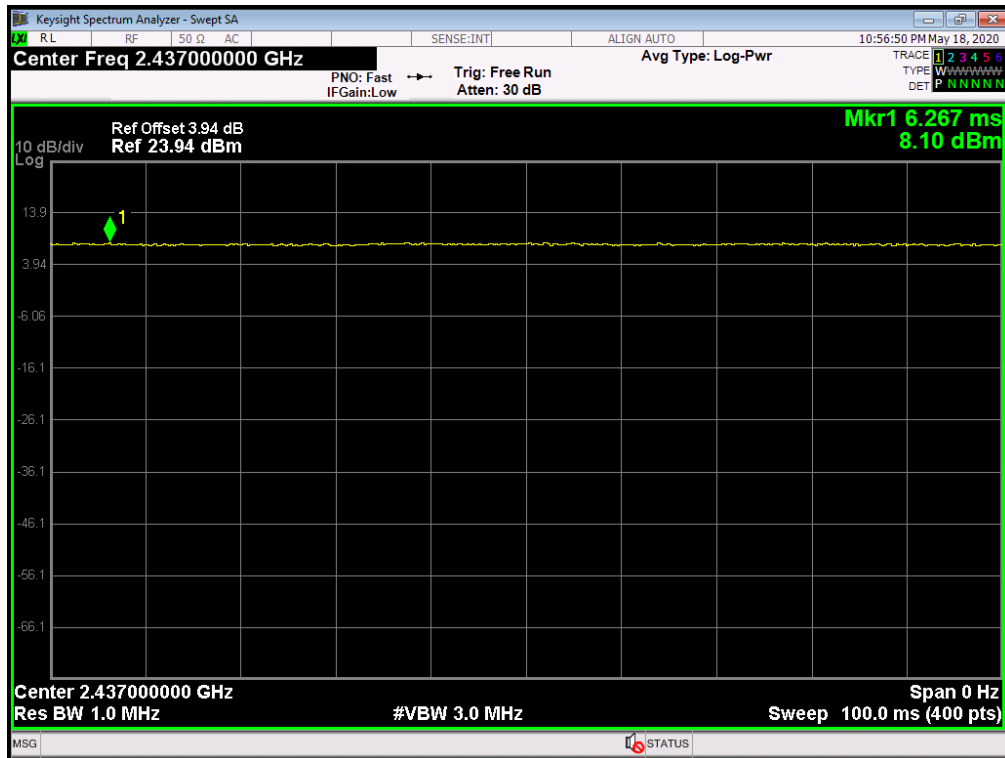

802.11 G Mode 2437 MHz

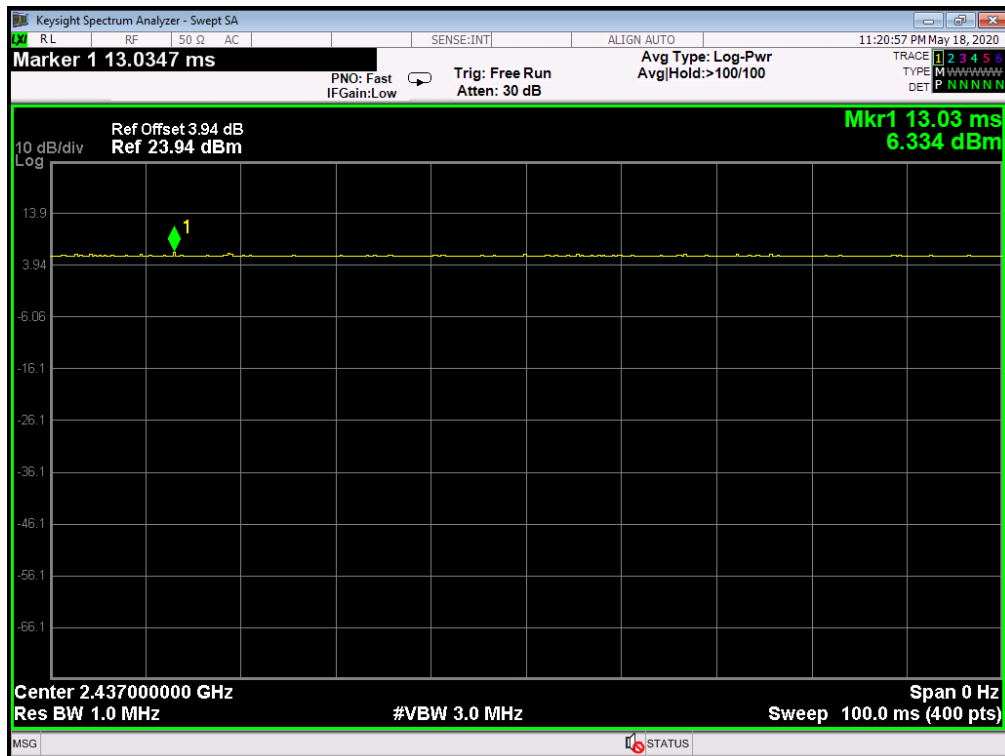

802.11 N(HT20) Mode 2437 MHz

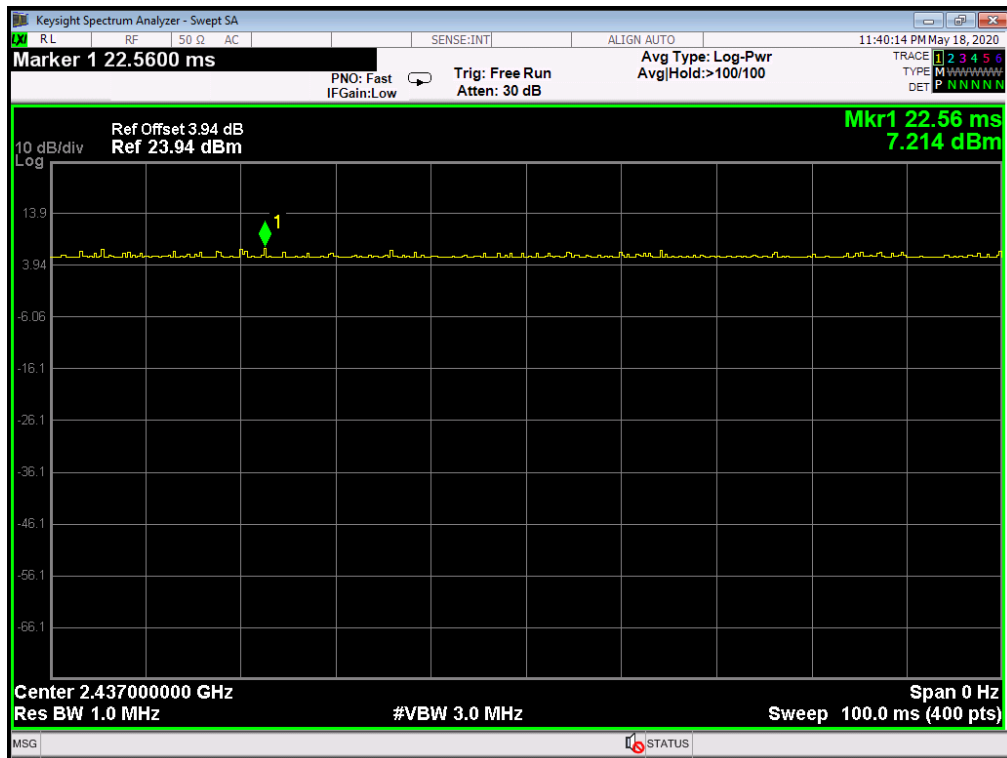

802.11 N(HT40) Mode 2437 MHz

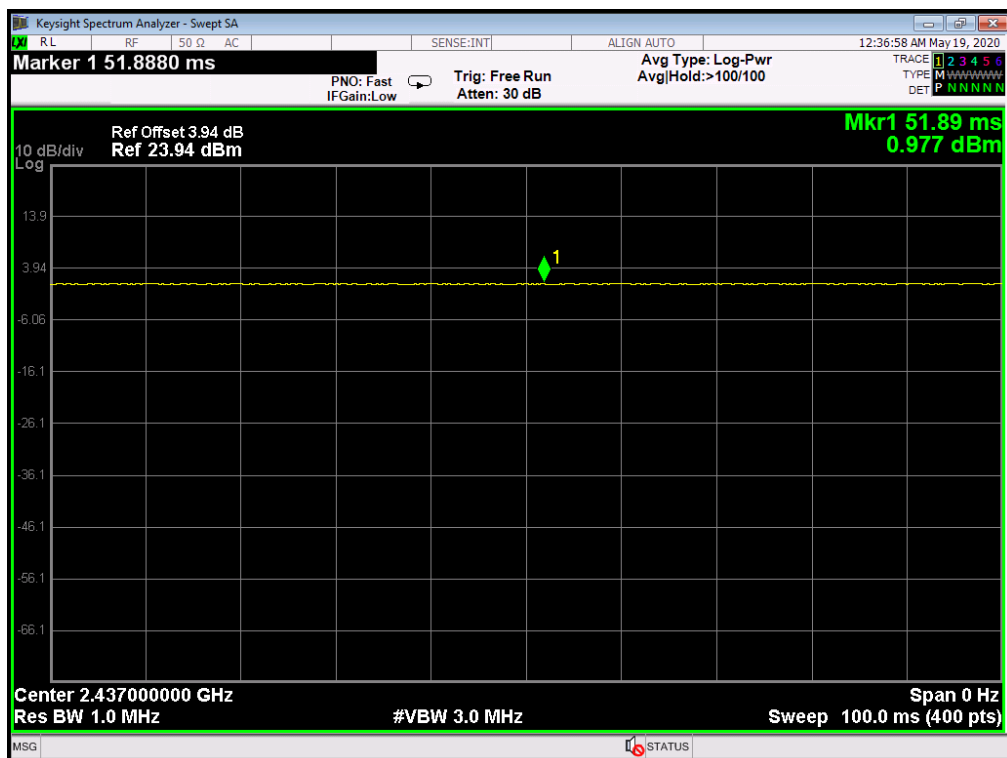



## Attachment F-- Power Spectral Density Test Data

802.11b Mode					
Channel	Frequency	Conducted PSD (dBm/3KHz)			Max. Limit (dBm/3KHz)
		Ant. A	Ant. B	Total	
1	2412 MHz	-11.437	-10.748	-8.069	5.99
6	2437 MHz	-12.162	-12.242	-9.192	
11	2462 MHz	-11.149	-12.892	-8.923	
802.11g Mode					
Channel	Frequency	Conducted PSD (dBm/3KHz)			Max. Limit (dBm/3KHz)
		Ant. A	Ant. B	Total	
1	2412 MHz	-19.436	-18.994	-16.199	5.99
6	2437 MHz	-19.120	-18.663	15.875	
11	2462 MHz	-20.083	-19.572	-16.810	
802.11n(HT20) Mode					
Channel	Frequency	Conducted PSD (dBm/3KHz)			Max. Limit (dBm/3KHz)
		Ant. A	Ant. B	Total	
1	2412 MHz	-19.747	-19.469	16.595	5.99
6	2437 MHz	-20.775	-19.487	-17.073	
11	2462 MHz	-20.530	-19.456	-16.950	
802.11n(HT40) Mode					
Channel	Frequency	Conducted PSD (dBm/3KHz)			Max. Limit (dBm/3KHz)
		Ant. A	Ant. B	Total	
3	2422 MHz	-22.100	-22.316	-19.196	5.99
6	2437 MHz	-22.841	-22.880	-19.850	
9	2452 MHz	-23.664	-22.412	-19.983	
<b>Note:</b> The ANT. A. and ANT. B will transmitting simultaneously for the 802.11b/g/n(HT20)/n(HT40) Mode, the T Directional Gain = Ant. Gain + 10*LOG(N <sub>ANT</sub> ) = 8.01 dBi > 6 dBi. So P <sub>out</sub> = P <sub>limit</sub> - (G <sub>TX</sub> - 6) = 8 - 2.01 = 5.99 dBm					
Test plots please refer to below pages:					

**802.11 b 2412 MHz (ANT. A)**

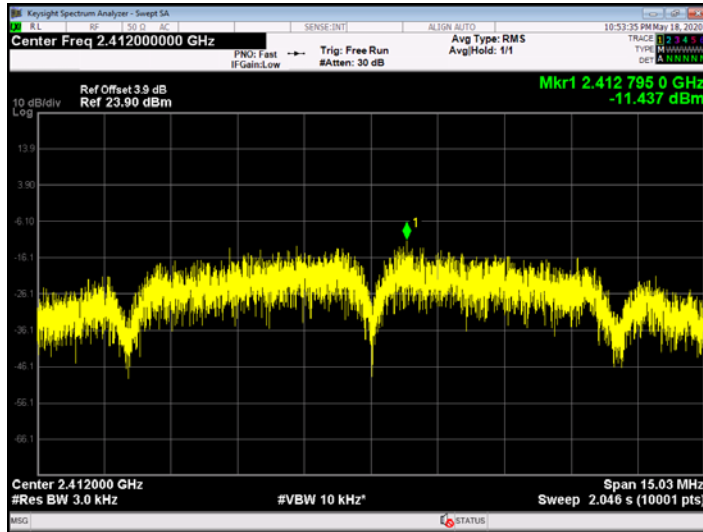

**802.11 b 2437 MHz(ANT. A)**

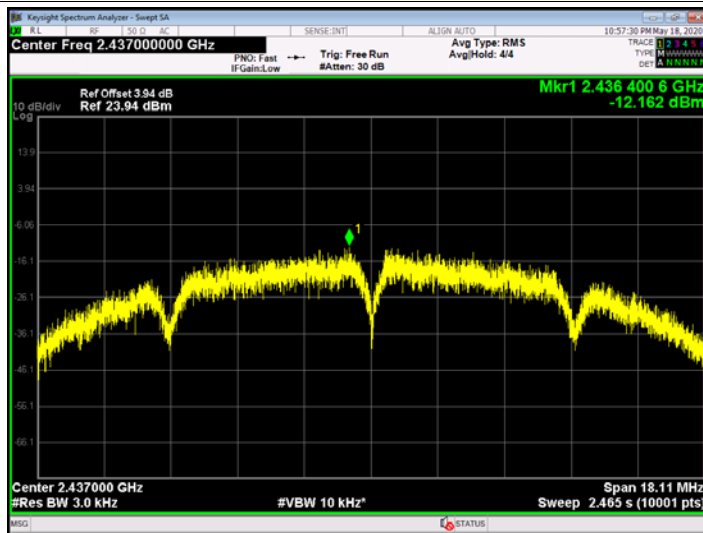

**802.11 b 2462MHz(ANT. A)**

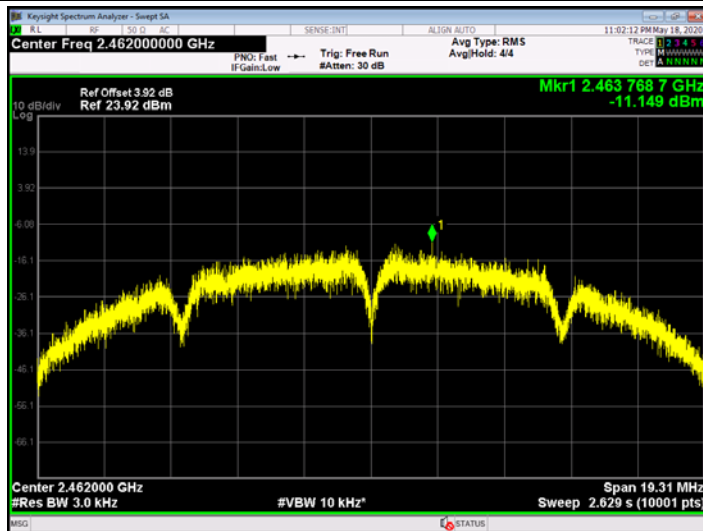

**802.11 b 2412 MHz (ANT. B)**

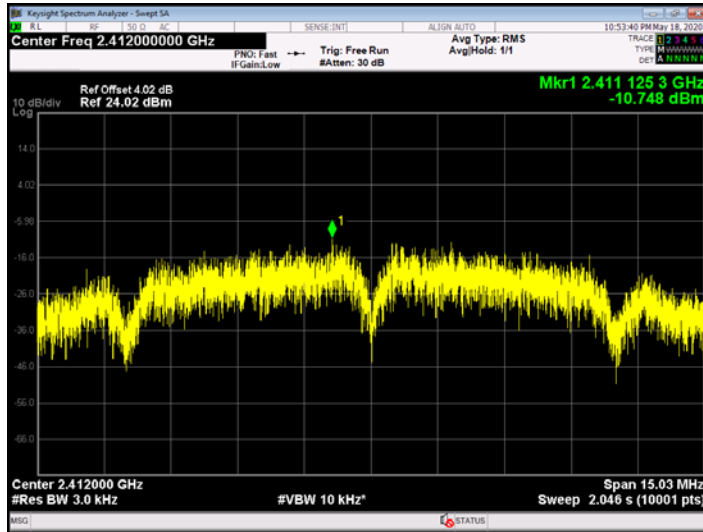

**802.11 b 2437 MHz(ANT. B)**

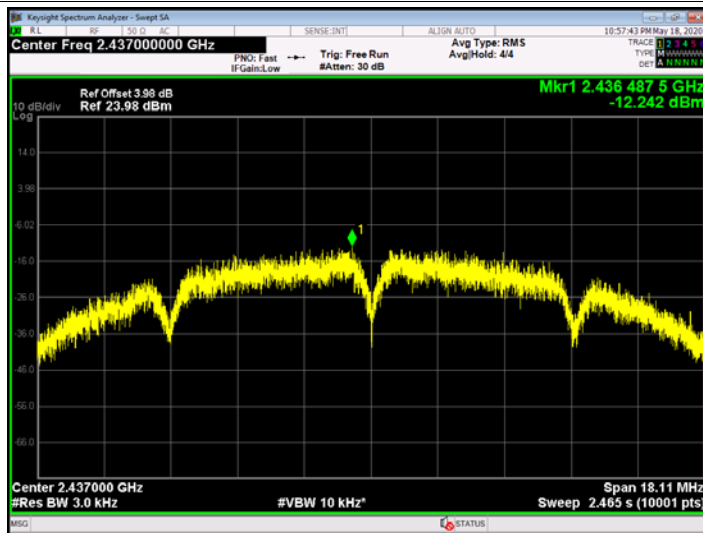

**802.11 b 2462MHz(ANT. B)**

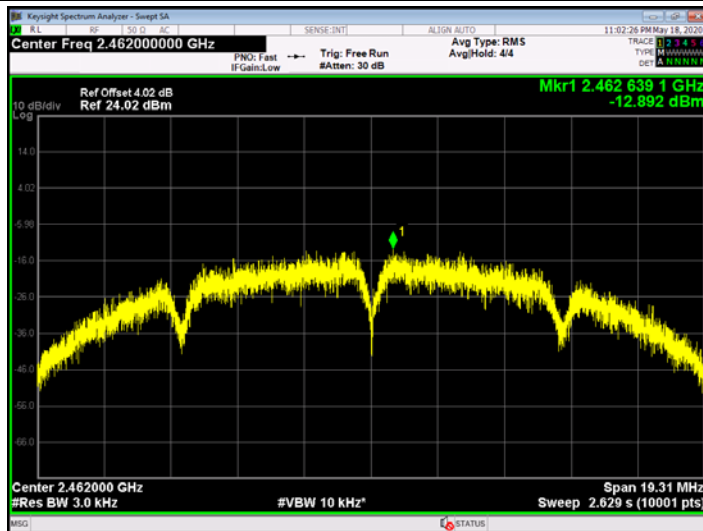

802.11 g 2412 MHz (ANT. A)

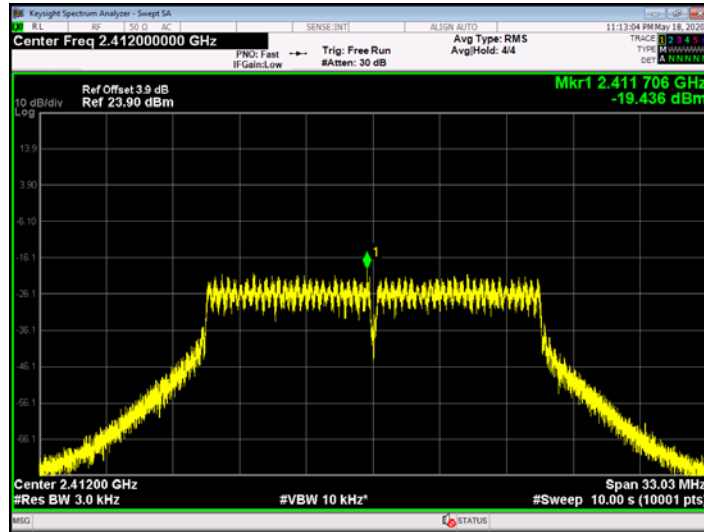

802.11 g 2437 MHz (ANT. A)

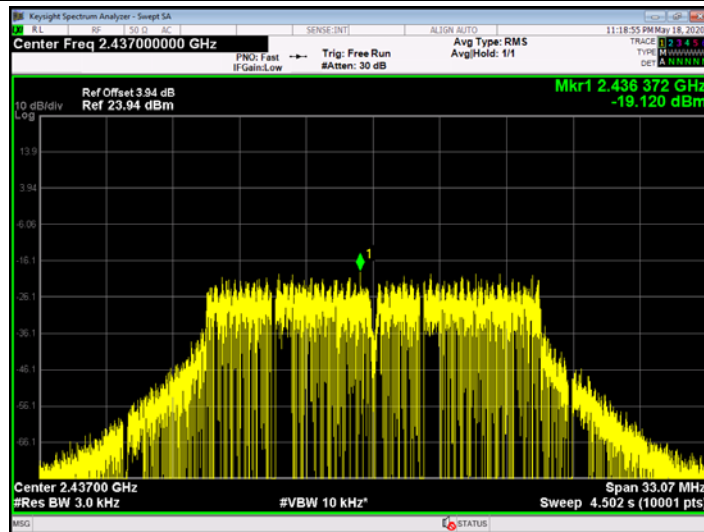

802.11 g 2462MHz (ANT. A)

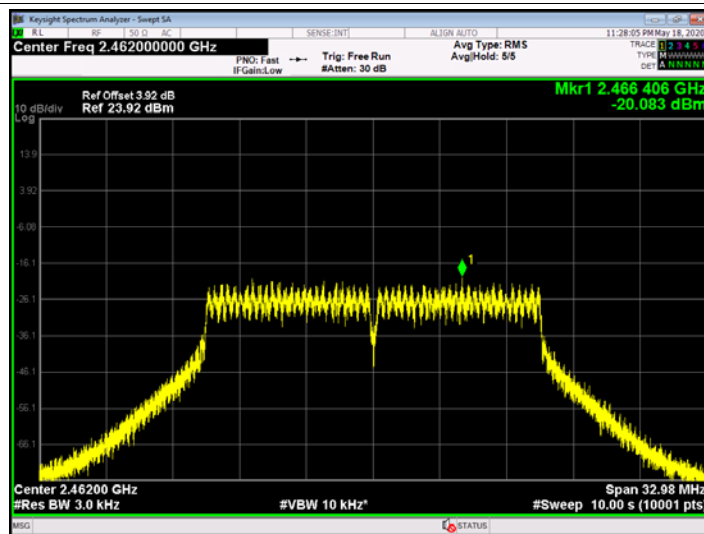

**802.11 g 2412 MHz (ANT. B)**

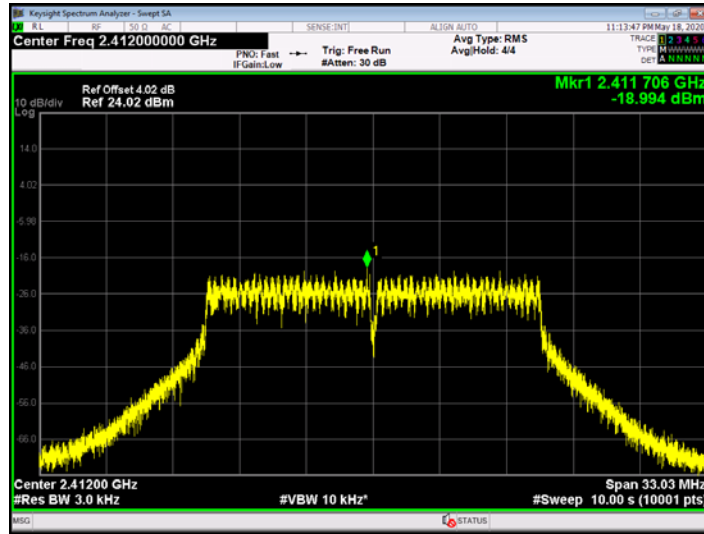

**802.11 g 2437 MHz (ANT. B)**

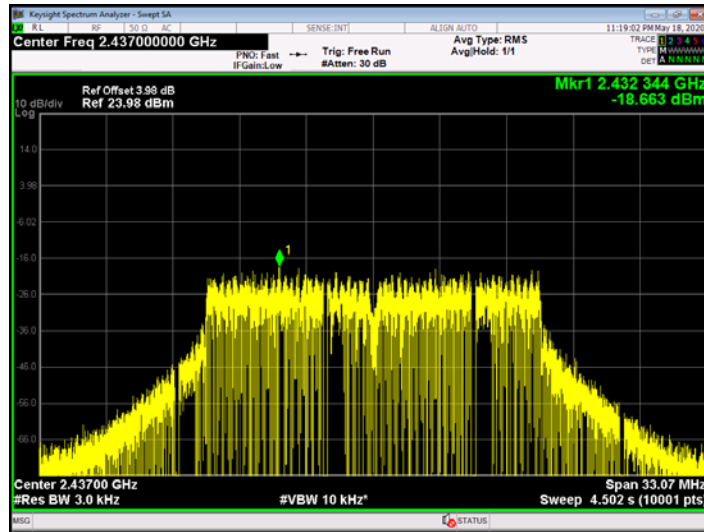

**802.11 g 2462 MHz (ANT. B)**

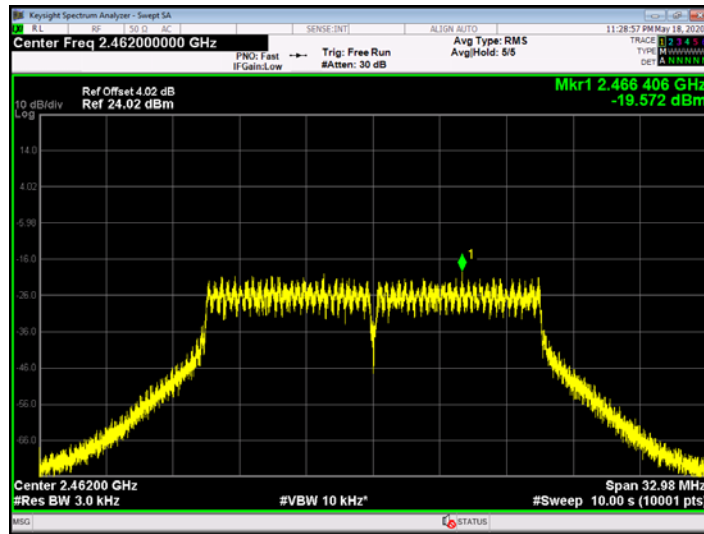

802.11 n(HT20) 2412 MHz (ANT. A)

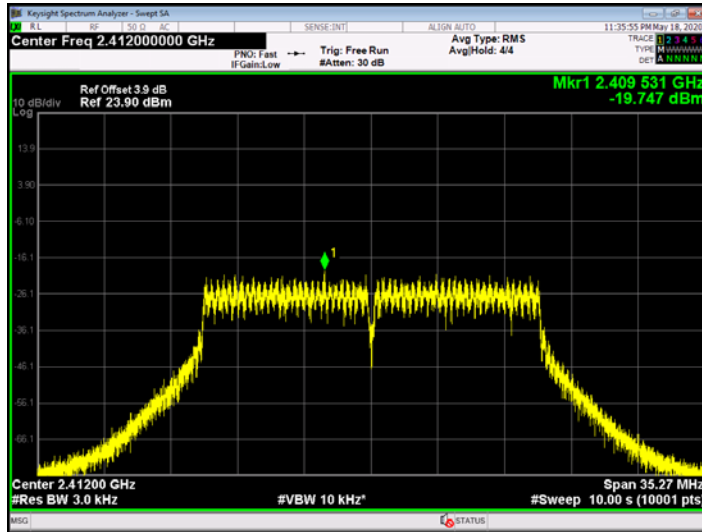

802.11 n(HT20) 2437 MHz (ANT. A)

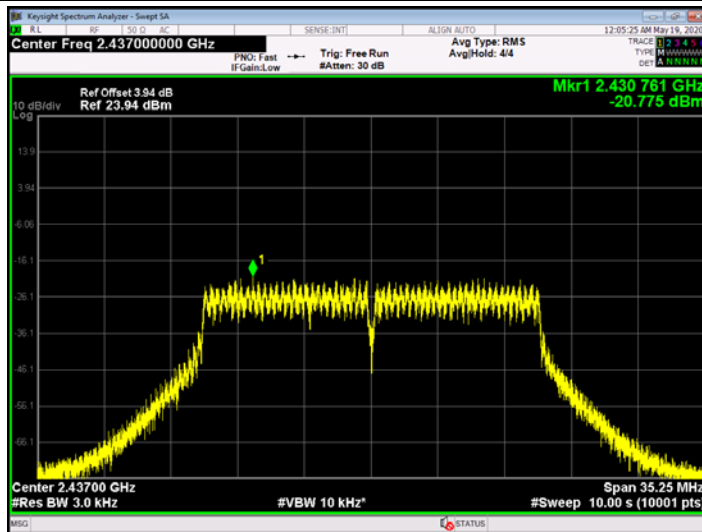

802.11 n(HT20) 2462MHz (ANT. A)

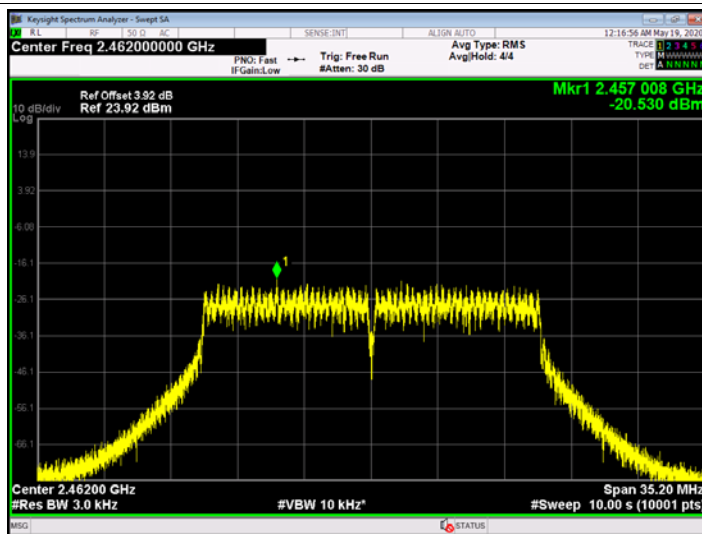

802.11 n(HT20) 2412 MHz (ANT. B)

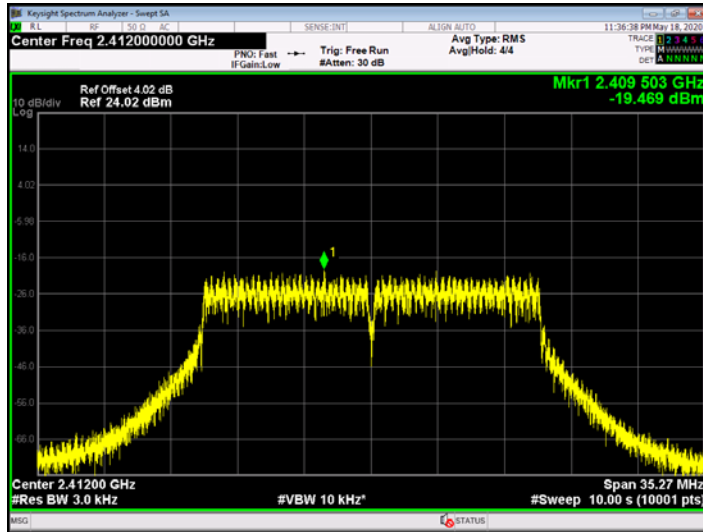

802.11 n(HT20) 2437 MHz (ANT. B)

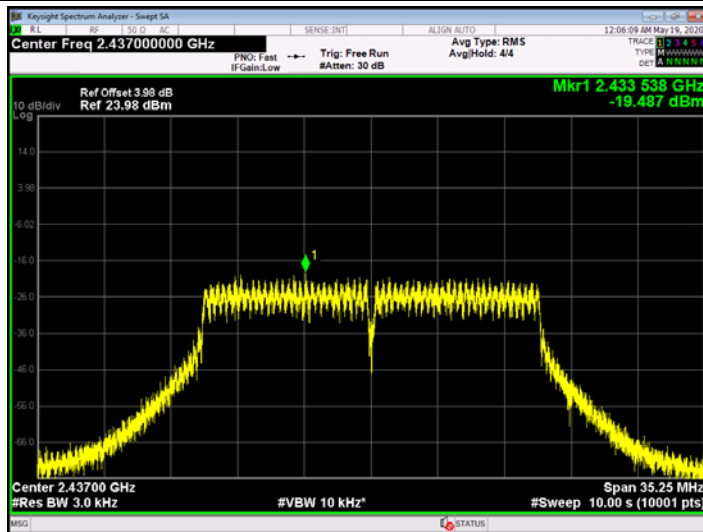

802.11 n(HT20) 2462MHz (ANT. B)

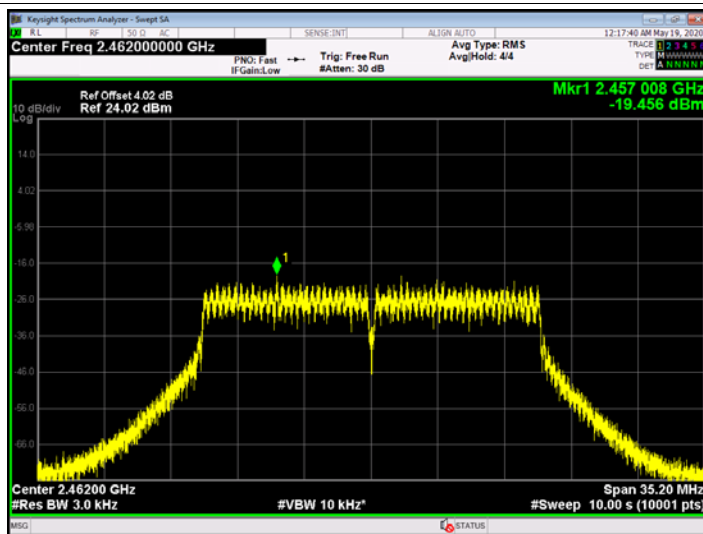

**802.11 n(HT40) 2422 MHz (ANT. A)**

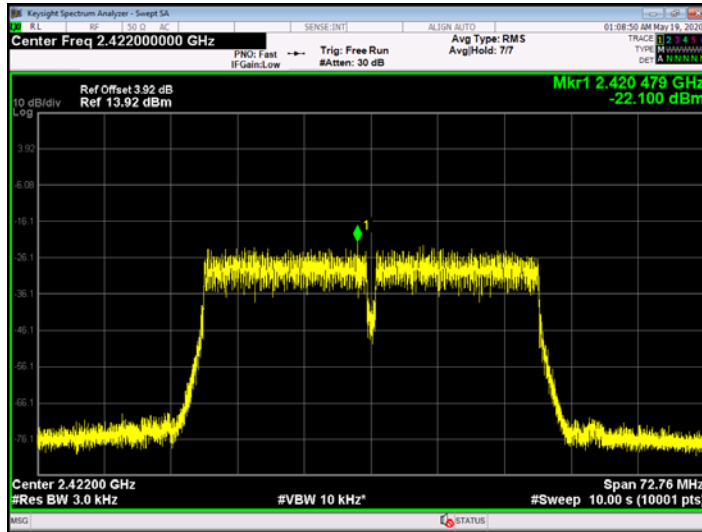

**802.11 n(HT40) 2437 MHz (ANT. A)**

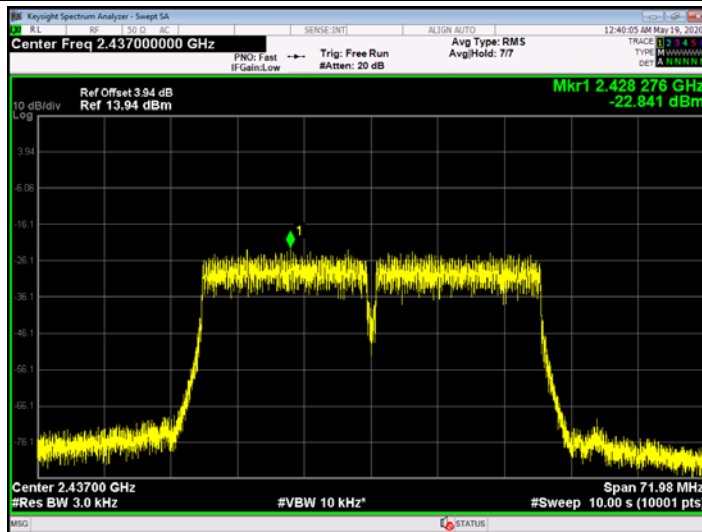

**802.11 n(HT40) 2452MHz (ANT. A)**

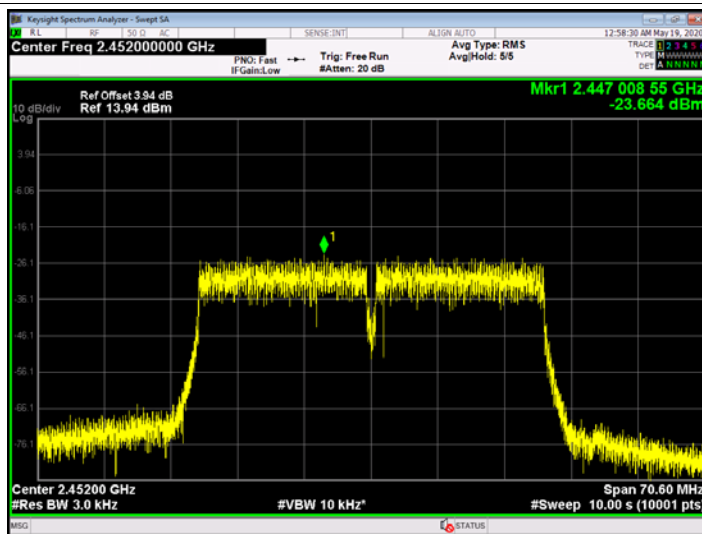



**802.11 n(HT40) 2422 MHz (ANT. B)**

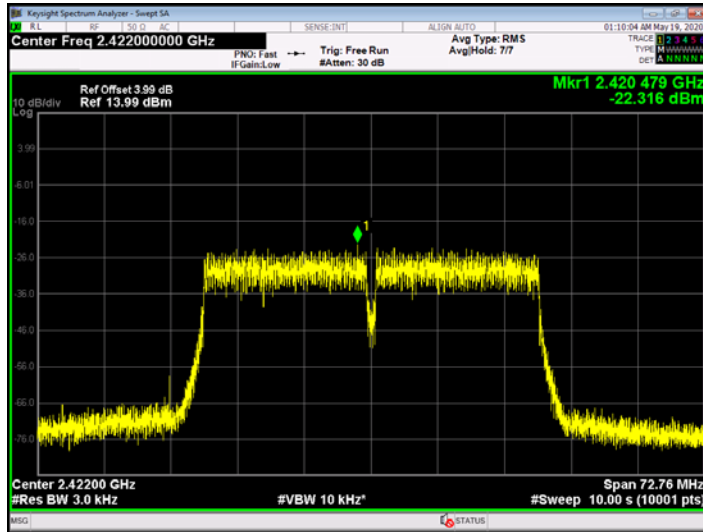

**802.11 n(HT40) 2437 MHz (ANT. B)**

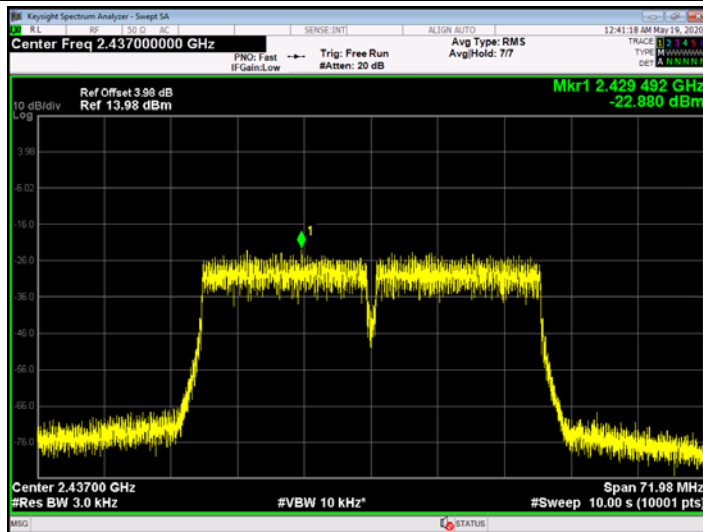

**802.11 n(HT40) 2452MHz (ANT. B)**

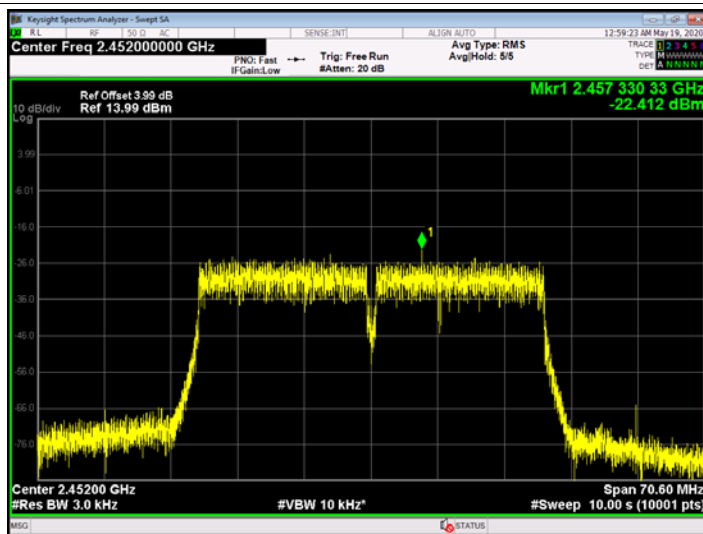

-----END OF REPORT-----