

TEST REPORT

Product Name : Mercku 5G CPE X6

Model Number : X1NA0

FCC ID : 2APR4-X6

Prepared for : Mercku Inc.
Address : 3600 Steeles Avenue East, Suite C108B, Markham,
Ontario, L3R 9Z7, Canada

Prepared by : EMTEK (SHENZHEN) CO., LTD.
Address : Bldg 69, Majialong Industry Zone, Nanshan District,
Shenzhen, Guangdong, China

Tel: (0755) 26954280
Fax: (0755) 26954282

Report Number : ENS2303290179W00102R
Date(s) of Tests : April 27, 2023 to May 24, 2023
Date of issue : May 26, 2023

TABLE OF CONTENTS

1 TEST RESULT CERTIFICATION.....	4
2 EUT TECHNICAL DESCRIPTION.....	5
3 SUMMARY OF TEST RESULT.....	7
4 TEST METHODOLOGY.....	8
4.1 GENERAL DESCRIPTION OF APPLIED STANDARDS.....	8
4.2 MEASUREMENT EQUIPMENT USED.....	8
4.3 DESCRIPTION OF TEST MODES.....	9
5 FACILITIES AND ACCREDITATIONS.....	13
5.1 FACILITIES.....	13
5.2 LABORATORY ACCREDITATIONS AND LISTINGS.....	13
6 TEST SYSTEM UNCERTAINTY.....	14
7 SETUP OF EQUIPMENT UNDER TEST.....	15
7.1 RADIO FREQUENCY TEST SETUP.....	15
7.2 RADIO FREQUENCY TEST SETUP.....	15
7.3 CONDUCTED EMISSION TEST SETUP.....	17
7.4 BLOCK DIAGRAM CONFIGURATION OF TEST SYSTEM.....	18
7.5 SUPPORT EQUIPMENT.....	18
8 TEST REQUIREMENTS.....	19
8.1 BANDWIDTH MEASUREMENT.....	19
8.2 MAXIMUM CONDUCTED OUTPUT POWER.....	164
8.3 MAXIMUM PEAK POWER DENSITY.....	274
8.4 UNDESIRABLE RADIATED SPURIOUS EMISSION.....	342
8.5 POWER LINE CONDUCTED EMISSIONS.....	379
8.6 ANTENNA APPLICATION.....	382

1 TEST RESULT CERTIFICATION

Applicant : Mercku Inc.
 Address : 3600 Steeles Avenue East, Suite C108B, Markham, Ontario, L3R 9Z7, Canada
 Manufacturer : Mercku Inc.
 Address : 3600 Steeles Avenue East, Suite C108B, Markham, Ontario, L3R 9Z7, Canada
 EUT : Mercku 5G CPE X6
 Model Name : X1NA0
 Trademark :  MERCKU

Measurement Procedure Used:

APPLICABLE STANDARDS	
STANDARD	TEST RESULT
FCC 47 CFR Part 2, Subpart J FCC 47 CFR Part 15, Subpart E	PASS

The above equipment was tested by EMTEK (SHENZHEN) CO., LTD. The test data, data evaluation, test procedures, and equipment configurations shown in this report were made in accordance with the procedures given in ANSI C63.10 (2013) and the energy emitted by the sample EUT tested as described in this report is in compliance with the above table standards requirement.

The test results of this report relate only to the tested sample identified in this report.

Date of Test : April 27, 2023 to May 24, 2023

Prepared by : 
 Una Yu/Editor

Reviewer : 
 Joe Xia/Supervisor

Approved & Authorized Signer : 
 Lisa Wang/Manager

2 EUT TECHNICAL DESCRIPTION

Characteristics	Description
Product	Mercku 5G CPE X6
Model Number	X1NA0
Wifi Type	UNII-1: 5150MHz-5250MHz Band UNII-2A: 5250MHz-5350MHz Band UNII-2C: 5470MHz-5725MHz Band UNII-3: 5725MHz-5850MHz Band
WLAN Supported	IEEE 802.11a IEEE 802.11n(20MHz channel bandwidth) IEEE 802.11n(40MHz channel bandwidth) IEEE 802.11ac(20MHz channel bandwidth) IEEE 802.11ac(40MHz channel bandwidth) IEEE 802.11ac(80MHz channel bandwidth) IEEE 802.11ac(160MHz channel bandwidth) IEEE 802.11ax(20MHz channel bandwidth) IEEE 802.11ax(40MHz channel bandwidth) IEEE 802.11ax(80MHz channel bandwidth) IEEE 802.11ax(160MHz channel bandwidth)
Modulation	OFDM with BPSK/QPSK/16QAM/64QAM for 802.11a/n OFDM with BPSK/QPSK/16QAM/64QAM/256QAM for 802.11ac/ax
Frequency Range	5150MHz-5250MHz Band
	5180-5240MHz for 802.11a 5180-5240MHz for 802.11n(HT20) 5190-5230MHz for 802.11n(HT40) 5180-5240MHz for 802.11ac(HT20) 5190-5230MHz for 802.11ac(HT40) 5210MHz for 802.11ac(HT80) 5180-5240MHz for 802.11ax(HT20) 5190-5230MHz for 802.11ax(HT40) 5210MHz for 802.11ax(HT80)
	5250MHz-5350MHz Band
	5260-5320MHz for 802.11a 5260-5320MHz for 802.11n(HT20) 5270-5310MHz for 802.11n(HT40) 5260-5320MHz for 802.11ac(HT20) 5270-5310MHz for 802.11ac(HT40) 5290MHz for 802.11ac(HT80) 5250MHz for 802.11ac(HT160) 5260-5320MHz for 802.11ax(HT20) 5270-5310MHz for 802.11ax(HT40) 5290MHz for 802.11ax(HT80) 5250MHz for 802.11ax(HT160)
	5470MHz-5725MHz Band

	<p>5500-5700MHz for 802.11a 5500-5700MHz for 802.11n(HT20) 5510-5670MHz for 802.11n(HT40) 5500-5700MHz for 802.11ac(HT20) 5510-5670MHz for 802.11ac(HT40) 5530-5610MHz for 802.11ac(HT80) 5570MHz for 802.11ac(HT160) 5500-5700MHz for 802.11ax(HT20) 5510-5670MHz for 802.11ax(HT40) 5530-5610MHz for 802.11ax(HT80) 5570MHz for 802.11ax(HT160)</p>
	5725MHz-5850MHz Band
	<p>5745-5825MHz for 802.11a 5745-5825MHz for 802.11n(HT20) 5755-5795MHz for 802.11n(HT40) 5745-5825MHz for 802.11ac(HT20) 5755-5795MHz for 802.11ac(HT40) 5775MHz for 802.11ac(HT80) 5745-5825MHz for 802.11ax(HT20) 5755-5795MHz for 802.11ax(HT40) 5775MHz for 802.11ax(HT80)</p>
TPC Function	Applicable
Smart system	MIMO
Beamforming	Not Applicable
Antenna Type	Integrated Antenna
Antenna Gain	Ant1: 5.31dBi, Ant2: 5.31dBi
Power Supply	<p>AC 120V/60Hz by adapter Adapter : Model: P120W2000U Input: 100-240V~50/60Hz, 0.6A Output: 12V, 2A, 24W</p>
Temperature Range	0°C ~ 40°C

Note: for more details, please refer to the user's manual of the EUT.

3 SUMMARY OF TEST RESULT

FCC Part Clause	Test Parameter	Verdict	Remark
15.407 (a) 15.407 (e)	99% , 6dB and 26dB Bandwidth	PASS	
15.407 (a)	Maximum Conducted Output Power	PASS	
15.407 (a)	Peak Power Spectral Density	PASS	
15.407 (b)	Radiated Spurious Emission	PASS	
15.407 (b)(6) 15.207	Power Line Conducted Emission	PASS	
15.407(a) 15.203	Antenna Application	PASS	

NOTE1: N/A (Not Applicable).

NOTE2: According to FCC OET KDB 789033 D2 General UNII Test Procedures New Rules v02r01, In addition, the radiated test is also performed to ensure the emissions emanating from the device cabinet also comply with the applicable limits.

RELATED SUBMITTAL(S) / GRANT(S):

This submittal(s) (test report) is intended for **FCC ID: 2APR4-X6** filing to comply with the above table standards requirement.

4 TEST METHODOLOGY

4.1 GENERAL DESCRIPTION OF APPLIED STANDARDS

According to its specifications, the EUT must comply with the requirements of the following standards:

FCC 47 CFR Part 2, Subpart J

FCC 47 CFR Part 15, Subpart E

FCC KDB 789033 D2 General UNII Test Procedures New Rules v02r01

4.2 MEASUREMENT EQUIPMENT USED

For Conducted Emission Test

Equipment	Manufacturer	Model No.	Serial No.	Last Cal.	Cal. Interval
EMI Test Receiver	Rohde & Schwarz	ESCI	101384	2022/5/14 2023/5/13	1Year
AMN	Rohde & Schwarz	ENV216	101161	2022/5/14 2023/5/13	1Year
AMN	Kyoritsu	KNW-407	8-1492-9	2022/5/12 2023/5/11	1Year

For Spurious Emissions Test

Equipment	Manufacturer	Model No.	Serial No.	Last Cal.	Cal. Interval
Pre-Amplifier	Bonn	BLMA 011001N	2213967A	2022/10/31	1Year
EMI Test Receiver	Rohde & Schwarz	ESR7	102551	2022/10/31	1Year
Bilog Antenna	Schwarzbeck	VULB9163	9163142	2022/7/24	2Year
Horn antenna	Schwarzbeck	BBHA9120D	9120D-1198	2021/6/15	2Year
Pre-Amplifier	Bonn	BLMA 0118-5G	2213967B-01	2022/10/31	1Year
Spectrum Analyzer	Rohde & Schwarz	FSV3044	101290	2022/10/31	1Year
Horn antenna	Schwarzbeck	BBHA9170	9170-399	2022/5/13 2023/5/12	2Year
Pre-Amplifier	Lunar EM	LNA18G26-40	J1012131010 001	2022/5/11 2023/5/10	1Year
Pre-Amplifier	Lunar EM	LNA26G40-40	J1013131028 001	2022/5/11 2023/5/10	1Year
Loop Antenna	Schwarzbeck	FMZB1519	1519-012	2022/5/13 2023/5/12	2Year

For Other Test

Equipment	Manufacturer	Model No.	Serial No.	Last Cal.	Cal. Interval
Wideband Radio Communication Tester	R&S	CMW500	171168	2022/11/2	1Year
Frequency Extender	R&S	CMW-Z800A	100430	2022/11/2	1Year
Spectrum Analyzer	R&S	FSV3044	MY60242456	2022/11/2	1Year
Analog Signal Generator	R&S	SMB100A	MY61252625	2022/11/2	1Year
Vector Signal Generator	R&S	SMM100A	MY61252674	2022/11/2	1Year
RF Control Unit	Tonscend	JS0806-2	22C8060567	2022/11/2	1Year
Temperature&Humidity Chamber	ESPEC	EL-02KA	12107166	2022/5/11 2023/5/10	1 Year

4.3 DESCRIPTION OF TEST MODES

The EUT has been tested under its typical operating condition.

The EUT configuration for testing is installed on RF field strength measurement to meet the Commissions requirement and operating in a manner which intends to maximize its emission characteristics in a continuous normal application.

The Transmitter was operated in the normal operating mode. The TX frequency was fixed which was for the purpose of the measurements.

Test of channel included the lowest and middle and highest frequency to perform the test, then record on this report.

Pre-defined engineering program for regulatory testing used to control the EUT for staying in continuous transmitting and receiving mode is programmed.

Wifi 5G with 5150-5250MHz

Frequency and Channels list for 802.11a/n(20)/802.11ac(20)/802.11ax(20):

Channel	Frequency (MHz)	Channel	Frequency (MHz)	Channel	Frequency (MHz)
36	5180	44	5220		
40	5200	48	5240		

Frequency and Channels list for 802.11n (40)/802.11ac(40)/802.11ax(40):

Channel	Frequency (MHz)	Channel	Frequency (MHz)	Channel	Frequency (MHz)
38	5190				
46	5230				

Frequency and Channel list for 802.11ac(80)/802.11ax(80):

Channel	Frequency (MHz)	Channel	Frequency (MHz)	Channel	Frequency (MHz)
42	5210				

Test Frequency and Channels for 802.11a/n(20)/802.11ac(20)/802.11ax(20):

Lowest Frequency		Middle Frequency		Highest Frequency	
Channel	Frequency (MHz)	Channel	Frequency (MHz)	Channel	Frequency (MHz)
36	5180	40	5200	48	5240

Test Frequency and channels for 802.11n (40)/802.11ac(40)/802.11ax(40):

Lowest Frequency		Middle Frequency		Highest Frequency	
Channel	Frequency (MHz)	Channel	Frequency (MHz)	Channel	Frequency (MHz)
38	5190	N/A	N/A	46	5230

Test Frequency and channels for 802.11ac(80)/802.11ax(80):

Lowest Frequency		Middle Frequency		Highest Frequency	
Channel	Frequency (MHz)	Channel	Frequency (MHz)	Channel	Frequency (MHz)
42	5210	N/A	N/A	N/A	N/A

Wifi 5G with 5250-5350MHz

Frequency and Channels list for 802.11a/n(20)/802.11ac(20)/802.11ax(20):

Channel	Frequency (MHz)	Channel	Frequency (MHz)	Channel	Frequency (MHz)
52	5260	60	5300		
56	5280	64	5320		

Frequency and Channels list for 802.11n (40)/802.11ac(40)/802.11ax(40):

Channel	Frequency (MHz)	Channel	Frequency (MHz)	Channel	Frequency (MHz)
54	5270				
62	5310				

Frequency and Channels list for 802.11ac(80)/802.11ax(80):

Channel	Frequency (MHz)	Channel	Frequency (MHz)	Channel	Frequency (MHz)
58	5290				

Frequency and Channels list for 802.11ax(160):

Channel	Frequency (MHz)	Channel	Frequency (MHz)	Channel	Frequency (MHz)
50	5250				

Test Frequency and Channels for 802.11a/n(20)/802.11ac(20)/802.11ax(20):

Lowest Frequency		Middle Frequency		Highest Frequency	
Channel	Frequency (MHz)	Channel	Frequency (MHz)	Channel	Frequency (MHz)
52	5260	56	5280	64	5320

Test Frequency and channels for 802.11n (40)/802.11ac(40)/802.11ax(40):

Lowest Frequency		Middle Frequency		Highest Frequency	
Channel	Frequency (MHz)	Channel	Frequency (MHz)	Channel	Frequency (MHz)
54	5270	N/A	N/A	62	5310

Test Frequency and channels for 802.11ac(80)/802.11ax(80):

Lowest Frequency		Middle Frequency		Highest Frequency	
Channel	Frequency (MHz)	Channel	Frequency (MHz)	Channel	Frequency (MHz)
58	5290				

Test Frequency and channels for 802.11ac(160)/802.11ax(160):

Channel	Frequency (MHz)	Channel	Frequency (MHz)	Channel	Frequency (MHz)
50	5250				

Wifi 5G with 5470-5725MHz

Frequency and Channels list for 802.11a/n(20)/802.11ac(20)/802.11ax(20):

Channel	Frequency (MHz)	Channel	Frequency (MHz)	Channel	Frequency (MHz)
100	5500	116	5580	132	5660
104	5520	120	5600	136	5680
108	5540	124	5620	140	5700
112	5560	128	5640		

Frequency and Channels list for 802.11n (40)/802.11ac(40)/802.11ax(40):

Channel	Frequency (MHz)	Channel	Frequency (MHz)	Channel	Frequency (MHz)
102	5510	118	5590	134	5670
110	5550	126	5630		

Frequency and Channels list for 802.11ac(80)/802.11ax(80):

Channel	Frequency (MHz)	Channel	Frequency (MHz)	Channel	Frequency (MHz)
106	5530	122	5610		

Frequency and channels for 802.11ac(160)/802.11ax(160):

Channel	Frequency (MHz)	Channel	Frequency (MHz)	Channel	Frequency (MHz)
114	5570				

Test Frequency and Channels for 802.11a/n(20)/802.11ac(20)/802.11ax(20):

Lowest Frequency		Middle Frequency		Highest Frequency	
Channel	Frequency (MHz)	Channel	Frequency (MHz)	Channel	Frequency (MHz)
100	5500	116	5580	140	5700

Test Frequency and channels for 802.11n (40)/802.11ac(40)/802.11ax(40):

Lowest Frequency		Middle Frequency		Highest Frequency	
Channel	Frequency (MHz)	Channel	Frequency (MHz)	Channel	Frequency (MHz)
102	5510			134	5670

Test Frequency and channels for 802.11ac(80)/802.11ax(80):

Lowest Frequency		Middle Frequency		Highest Frequency	
Channel	Frequency (MHz)	Channel	Frequency (MHz)	Channel	Frequency (MHz)
106	5530	122	5610		

Test Frequency and channels for 802.11ac(160)/802.11ax(160):

Channel	Frequency (MHz)	Channel	Frequency (MHz)	Channel	Frequency (MHz)
114	5570				

Wifi 5G with 5725MHz-5850MHz

Frequency and Channels list for 802.11a/n(20)/802.11ac(20)/802.11ax(20):

Channel	Frequency (MHz)	Channel	Frequency (MHz)	Channel	Frequency (MHz)
149	5745	157	5785	165	5825
153	5765	161	5805		

Frequency and Channels list for 802.11n (40)/802.11ac(40)/802.11ax(40):

Channel	Frequency (MHz)	Channel	Frequency (MHz)	Channel	Frequency (MHz)
151	5755				
159	5795				

Frequency and Channels list for 802.11ac(80)/802.11ax(80):

Channel	Frequency (MHz)	Channel	Frequency (MHz)	Channel	Frequency (MHz)
155	5775				

Test Frequency and Channels for 802.11a/n(20)/802.11ac(20)/802.11ax(20):

Lowest Frequency		Middle Frequency		Highest Frequency	
Channel	Frequency (MHz)	Channel	Frequency (MHz)	Channel	Frequency (MHz)
149	5745	157	5785	165	5825

Test Frequency and channels for 802.11n (40)/802.11ac(40)/802.11ax(40):

Lowest Frequency		Middle Frequency		Highest Frequency	
Channel	Frequency (MHz)	Channel	Frequency (MHz)	Channel	Frequency (MHz)
151	5755			159	5795

Test Frequency and channels for 802.11ac(80)/802.11ax(80):

Lowest Frequency		Middle Frequency		Highest Frequency	
Channel	Frequency (MHz)	Channel	Frequency (MHz)	Channel	Frequency (MHz)
155	5775				

Multi-antenna correlation:

<input checked="" type="checkbox"/>	Transmit Signals are Correlated
	Directional gain = $10 \log[(10^{G^1/20} + 10^{G^2/20} + \dots + 10^{G^N/20})^2 / N_{ANT}]$ dBi
<input type="checkbox"/>	All Transmit Signals are Completely Uncorrelated
	Directional gain = $10 \log[(10^{G^1/10} + 10^{G^2/10} + \dots + 10^{G^N/10}) / N_{ANT}]$ dBi

Ant 1: 5.31dBi, Ant 2: 5.31dBi

 Directional gain = $10 \log [(10^{5.31/20} + 10^{5.31/20})^2 / 2]$ dBi=8.32dBi

5 FACILITIES AND ACCREDITATIONS

5.1 FACILITIES

All measurement facilities used to collect the measurement data are located at:

Bldg 69, Majialong Industry Zone District, Nanshan District, Shenzhen, China

The sites are constructed in conformance with the requirements of ANSI C63.7, ANSI C63.10 and CISPR Publication 22.

5.2 LABORATORY ACCREDITATIONS AND LISTINGS

Site Description

EMC Lab.

: **Accredited by CNAS**

The Certificate Registration Number is L2291

The Laboratory has been assessed and proved to be in compliance with CNAS-CL01 (identical to ISO/IEC 17025:2017)

Accredited by FCC

Designation Number: CN1204

Test Firm Registration Number: 882943

Accredited by A2LA

The Certificate Number is 4321.01

Accredited by Industry Canada

The Conformity Assessment Body Identifier is CN0008

Name of Firm

: EMTEK (SHENZHEN) CO., LTD.

Site Location

: Building 69, Majialong Industry Zone, Nanshan District, Shenzhen, Guangdong, China

6 TEST SYSTEM UNCERTAINTY

The following measurement uncertainty levels have been estimated for tests performed on the apparatus:

Parameter	Uncertainty
Radio Frequency	$\pm 1 \times 10^{-5}$
Maximum Peak Output Power Test	$\pm 1.0\text{dB}$
Conducted Emissions Test	$\pm 2.0\text{dB}$
Radiated Emission Test	$\pm 2.0\text{dB}$
Power Density	$\pm 2.0\text{dB}$
Occupied Bandwidth Test	$\pm 1.0\text{dB}$
Band Edge Test	$\pm 3\text{dB}$
All emission, radiated	$\pm 3\text{dB}$
Antenna Port Emission	$\pm 3\text{dB}$
Temperature	$\pm 0.5^\circ\text{C}$
Humidity	$\pm 3\%$

Measurement Uncertainty for a level of Confidence of 95%.

7 SETUP OF EQUIPMENT UNDER TEST

7.1 RADIO FREQUENCY TEST SETUP

The WLAN component's antenna ports(s) of the EUT are connected to the measurement instrument per an appropriate attenuator. The EUT is controlled by PC/software to emit the specified signals for the purpose of measurements.

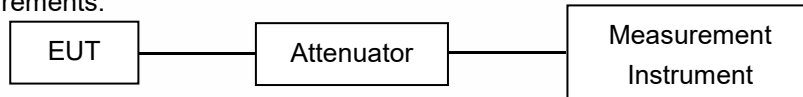

7.2 RADIO FREQUENCY TEST SETUP

The test site semi-anechoic chamber has met the requirement of NSA tolerance 4 dB according to the standards: ANSI C63.10. The test distance is 3m. The setup is according to the requirements in Section 13.1.4.1 of ANSI C63.10-2013 and CAN/CSA-CEI/IEC CISPR 22.

Below 30MHz:

The EUT is placed on a turntable 0.8 meters above the ground in the chamber, 3 meter away from the antenna (loop antenna). The Antenna should be positioned with its plane vertical at the specified distance from the EUT and rotated about its vertical axis for maximum response at each azimuth about the EUT. The center of the loop shall be 1 m above the ground. For certain applications, the loop antenna plane may also need to be positioned horizontally at the specified distance from the EUT.

Above 30MHz:

The EUT is placed on a turntable 0.8 meters above the ground in the chamber, 3 meter away from the antenna. The maximal emission value is acquired by adjusting the antenna height, polarisation and turntable azimuth. Normally, the height range of antenna is 1 m to 4 m, the azimuth range of turntable is 0° to 360°, and the receive antenna has two polarizations Vertical (V) and Horizontal (H).

Above 1GHz:

(Note: the FCC's permission to use 1.5m as an alternative per TCBC Conf call of Dec. 2, 2014.)

The EUT is placed on a turntable 1.5 meters above the ground in the chamber, 3 meter away from the antenna. The maximal emission value is acquired by adjusting the antenna height, polarisation and turntable azimuth. Normally, the height range of antenna is 1 m to 4 m, the azimuth range of turntable is 0° to 360°, and the receive antenna has two polarizations Vertical (V) and Horizontal (H).

(a) Radiated Emission Test Set-Up, Frequency Below 30MHz

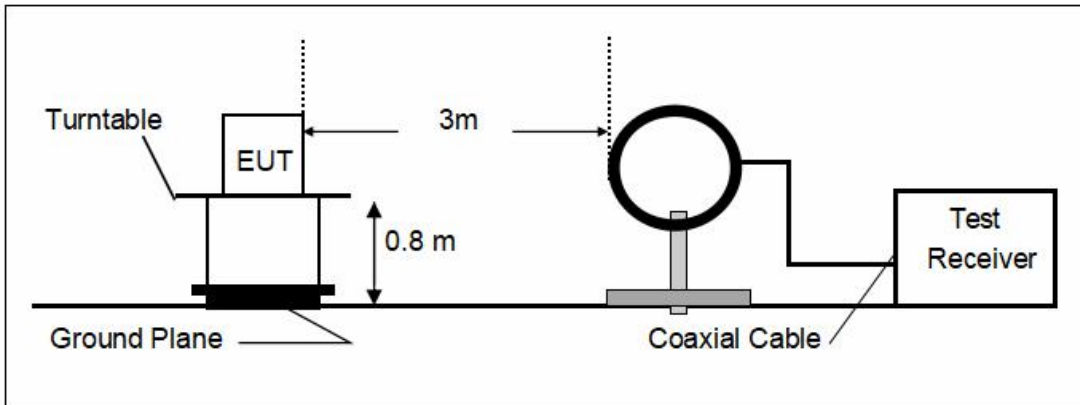

(b) Radiated Emission Test Set-Up, Frequency Below 1000MHz

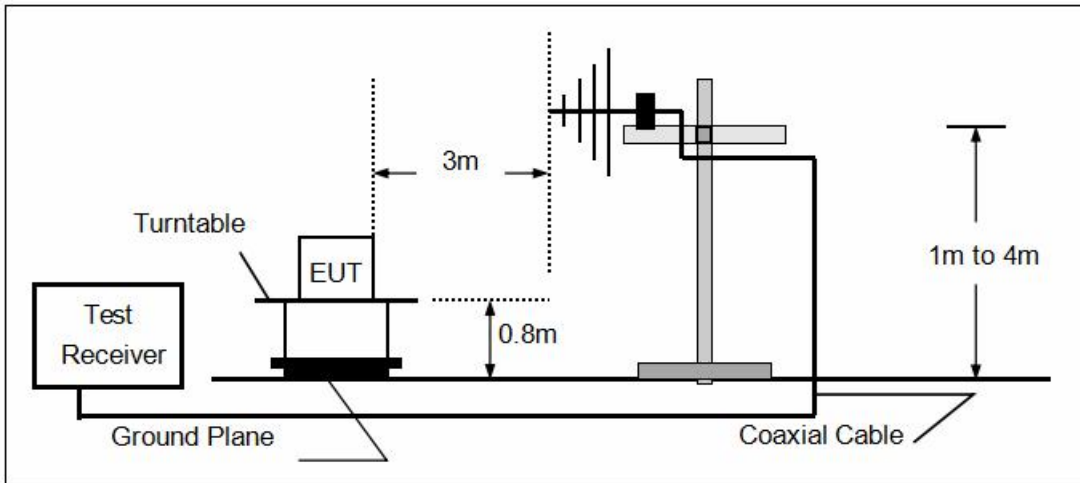

(c) Radiated Emission Test Set-Up, Frequency above 1000MHz

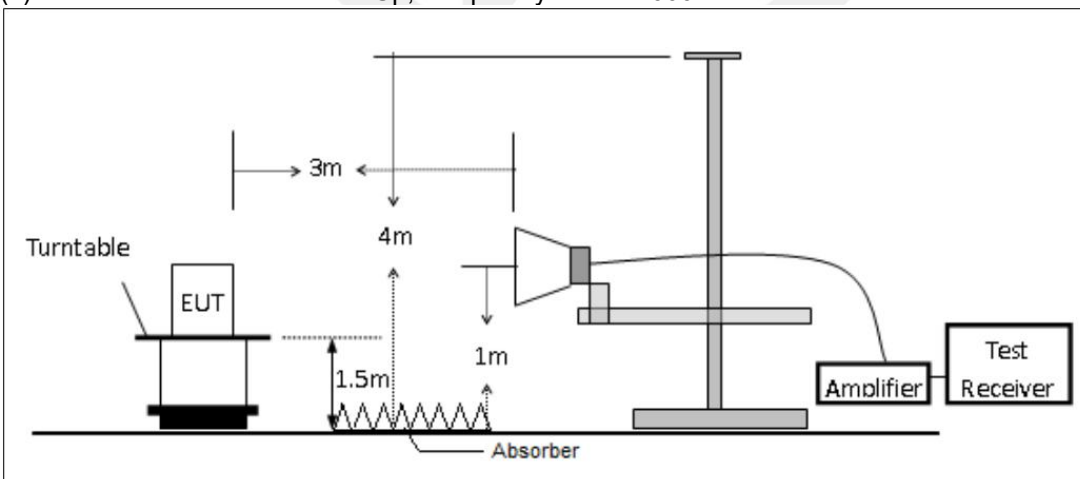

7.3 CONDUCTED EMISSION TEST SETUP

The mains cable of the EUT (maybe per AC/DC Adapter) must be connected to LISN. The LISN shall be placed 0.8 m from the boundary of EUT and bonded to a ground reference plane for LISN mounted on top of the ground reference plane. This distance is between the closest points of the LISN and the EUT. All other units of the EUT and associated equipment shall be at least 0.8m from the LISN.

Ground connections, where required for safety purposes, shall be connected to the reference ground point of the LISN and, where not otherwise provided or specified by the manufacturer, shall be of same length as the mains cable and run parallel to the mains connection at a separation distance of not more than 0.1 m.

According to the requirements in Section 13.1.4.1 of ANSI C63.10-2013 Conducted emissions from the EUT measured in the frequency range between 0.15 MHz and 30 MHz using CISPR Quasi-Peak and average detector mode.

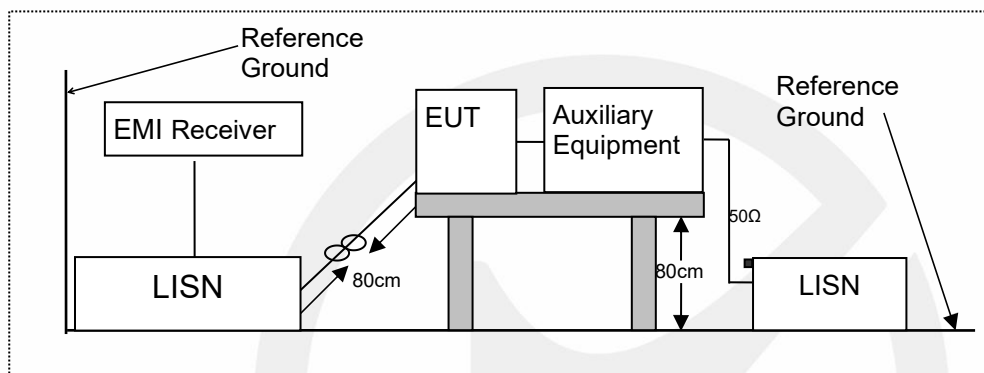

7.4 BLOCK DIAGRAM CONFIGURATION OF TEST SYSTEM

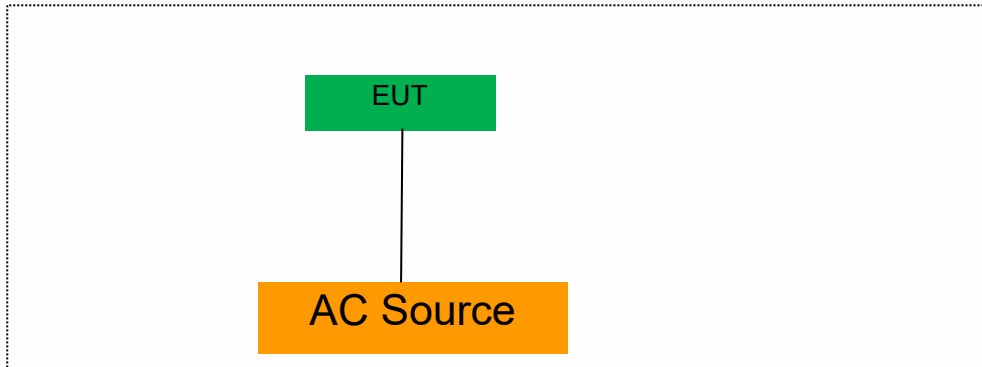

7.5 SUPPORT EQUIPMENT

N/A

Notes:

1. All the equipment/cables were placed in the worst-case configuration to maximize the emission during the test.
2. Grounding was established in accordance with the manufacturer's requirements and conditions for the intended use.

8 TEST REQUIREMENTS

8.1 BANDWIDTH MEASUREMENT

8.1.1 Applicable Standard

According to FCC Part 15.407(a)(1) for UNII Band I
According to FCC Part 15.407(a)(2) for UNII Band II-A and UNII Band II-C
According to FCC Part 15.407(a)(3) for UNII Band III
According to FCC Part 15.407(e) for UNII Band III
According to 789033 D02 Section II(C)
According to 789033 D02 Section II(D)

8.1.2 Conformance Limit

(1) For the band 5.15-5.25 GHz.

(iv) For mobile and portable client devices in the 5.15-5.25 GHz band, the maximum conducted output power over the frequency band of operation shall not exceed 250 mW provided the maximum antenna gain does not exceed 6 dBi. In addition, the maximum power spectral density shall not exceed 11 dBm in any 1 megahertz band. If transmitting antennas of directional gain greater than 6 dBi are used, both the maximum conducted output power and the maximum power spectral density shall be reduced by the amount in dB that the directional gain of the antenna exceeds 6 dBi.

(2) For the 5.25-5.35 GHz and 5.47-5.725 GHz bands, the maximum conducted output power over the frequency bands of operation shall not exceed the lesser of 250 mW or $11 \text{ dBm} + 10 \log B$, where B is the 26 dB emission bandwidth in megahertz. In addition, the maximum power spectral density shall not exceed 11 dBm in any 1 megahertz band. If transmitting antennas of directional gain greater than 6 dBi are used, both the maximum conducted output power and the maximum power spectral density shall be reduced by the amount in dB that the directional gain of the antenna exceeds 6 dBi.

(3) For the band 5.725-5.85 GHz, the maximum conducted output power over the frequency band of operation shall not exceed 1 W. In addition, the maximum power spectral density shall not exceed 30 dBm in any 500-kHz band. If transmitting antennas of directional gain greater than 6 dBi are used, both the maximum conducted output power and the maximum power spectral density shall be reduced by the amount in dB that the directional gain of the antenna exceeds 6 dBi. However, fixed point-to-point U-NII devices operating in this band may employ transmitting antennas with directional gain greater than 6 dBi without any corresponding reduction in transmitter conducted power. Fixed, point-to-point operations exclude the use of point-to-multipoint systems, omnidirectional applications, and multiple collocated transmitters transmitting the same information. The operator of the U-NII device, or if the equipment is professionally installed, the installer, is responsible for ensuring that systems employing high gain directional antennas are used exclusively for fixed, point-to-point operations.

(e) Within the 5.725-5.85 GHz band, the minimum 6 dB bandwidth of U-NII devices shall be at least 500 kHz.

8.1.3 Test Configuration

Test according to clause 6.1 radio frequency test setup.

8.1.4 Test Procedure

According to 789033 D02 v02r01 section C&D, the following is the measurement procedure.

1. Emission Bandwidth (EBW)

- a) Set RBW = approximately 1% of the emission bandwidth.
- b) Set the VBW > RBW.
- c) Detector = Peak.
- d) Trace mode = max hold.
- e) Measure the maximum width of the emission that is 26 dB down from the maximum of the emission.

Compare this with the RBW setting of the analyzer. Readjust RBW and repeat measurement as needed until the RBW/EBW ratio is approximately 1%.

2. Minimum Emission Bandwidth for the band 5.725-5.85 GHz

Section 15.407(e) specifies the minimum 6 dB emission bandwidth of at least 500 KHz for the band 5.715-5.85 GHz. The following procedure shall be used for measuring this bandwidth:

- a) Set RBW = 100 kHz.
- b) Set the video bandwidth (VBW) $\geq 3 \times$ RBW.
- c) Detector = Peak.
- d) Trace mode = max hold.
- e) Sweep = auto couple.
- f) Allow the trace to stabilize.
- g) Measure the maximum width of the emission that is constrained by the frequencies associated with the two outermost amplitude points (upper and lower frequencies) that are attenuated by 6 dB relative to the maximum level measured in the fundamental emission.

Note: The automatic bandwidth measurement capability of a spectrum analyzer or EMI receiver may be employed if it implements the functionality described above.

D. 99 Percent Occupied Bandwidth

The 99-percent occupied bandwidth is the frequency bandwidth such that, below its lower and above its upper frequency limits, the mean powers are each equal to 0.5 % of the total mean power of the given emission. Measurement of the 99-percent occupied bandwidth is required only as a condition for using the optional band-edge measurement techniques described in section II.G.3.d). Measurements of 99-percent occupied bandwidth may also optionally be used in lieu of the EBW to 789033 D02 v01r02 General UNII Test Procedures New Rules v01 define the minimum frequency range over which the spectrum is integrated when measuring maximum conducted output power as described in section II.E. However, the EBW must be measured to determine bandwidth dependent limits on maximum conducted output power in accordance with 15.407(a).

The following procedure shall be used for measuring (99 %) power bandwidth:

1. Set center frequency to the nominal EUT channel center frequency.
2. Set span = 1.5 times to 5.0 times the OBW.
3. Set RBW = 1 % to 5 % of the OBW.
4. Set VBW $\geq 3 \times$ RBW.
5. Video averaging is not permitted. Where practical, a sample detection and single sweep mode shall be used. Otherwise, peak detection and max hold mode (until the trace stabilizes) shall be used.
6. Use the 99 % power bandwidth function of the instrument (if available).
7. If the instrument does not have a 99 % power bandwidth function, the trace data points are recovered and directly summed in power units. The recovered amplitude data points, beginning at the lowest frequency, are placed in a running sum until 0.5 % of the total is reached; that frequency is recorded as the lower frequency. The process is repeated until 99.5 % of the total is reached; that frequency is recorded as the upper frequency. The 99% occupied bandwidth is the difference between these two frequencies.

8.1.5 Test Results

Emission Bandwidth (26dB)

TestMode	Antenna	Frequency[MHz]	26db EBW [MHz]	FL[MHz]	FH[MHz]	Limit[MHz]	Verdict
11A	Ant1	5180	21.28	5169.36	5190.64	---	---
	Ant2	5180	21.28	5169.40	5190.68	---	---
	Ant1	5200	21.24	5189.44	5210.68	---	---
	Ant2	5200	21.28	5189.44	5210.72	---	---
	Ant1	5240	21.24	5229.44	5250.68	---	---
	Ant2	5240	21.32	5229.36	5250.68	---	---
	Ant1	5260	21.28	5249.40	5270.68	---	---
	Ant2	5260	21.24	5249.40	5270.64	---	---
	Ant1	5280	21.40	5269.44	5290.84	---	---
	Ant2	5280	21.24	5269.44	5290.68	---	---
	Ant1	5320	21.20	5309.48	5330.68	---	---
	Ant2	5320	21.32	5309.36	5330.68	---	---
	Ant1	5500	21.28	5489.32	5510.60	---	---
	Ant2	5500	21.28	5489.36	5510.64	---	---
	Ant1	5580	21.28	5569.40	5590.68	---	---
	Ant2	5580	21.24	5569.44	5590.68	---	---
	Ant1	5700	21.12	5689.52	5710.64	---	---
	Ant2	5700	21.80	5689.12	5710.92	---	---
	Ant1	5745	21.36	5734.36	5755.72	---	---
	Ant2	5745	21.28	5734.40	5755.68	---	---
	Ant1	5785	21.40	5774.32	5795.72	---	---
	Ant2	5785	21.32	5774.36	5795.68	---	---
	Ant1	5825	21.48	5814.28	5835.76	---	---
	Ant2	5825	21.32	5814.40	5835.72	---	---
11N20MIMO	Ant1	5180	21.76	5169.12	5190.88	---	---
	Ant2	5180	21.48	5169.28	5190.76	---	---
	Ant1	5200	21.68	5189.16	5210.84	---	---
	Ant2	5200	21.48	5189.20	5210.68	---	---
	Ant1	5240	21.80	5229.12	5250.92	---	---
	Ant2	5240	21.56	5229.20	5250.76	---	---
	Ant1	5260	21.64	5249.20	5270.84	---	---
	Ant2	5260	21.52	5249.16	5270.68	---	---
	Ant1	5280	21.56	5269.24	5290.80	---	---
	Ant2	5280	21.48	5269.24	5290.72	---	---
	Ant1	5320	21.64	5309.24	5330.88	---	---
	Ant2	5320	21.52	5309.20	5330.72	---	---
	Ant1	5500	21.76	5489.12	5510.88	---	---
	Ant2	5500	21.52	5489.24	5510.76	---	---
	Ant1	5580	21.64	5569.20	5590.84	---	---
	Ant2	5580	21.92	5569.20	5591.12	---	---
	Ant1	5700	21.72	5689.16	5710.88	---	---
	Ant2	5700	21.80	5689.20	5711.00	---	---
	Ant1	5745	21.72	5734.12	5755.84	---	---
	Ant2	5745	21.84	5734.12	5755.96	---	---
	Ant1	5785	21.72	5774.12	5795.84	---	---
	Ant2	5785	21.56	5774.24	5795.80	---	---
	Ant1	5825	21.88	5814.20	5836.08	---	---
	Ant2	5825	21.72	5814.20	5835.92	---	---

11N40MIMO	Ant1	5190	40.80	5169.60	5210.40	---	---
	Ant2	5190	40.08	5169.92	5210.00	---	---
	Ant1	5230	40.80	5209.44	5250.24	---	---
	Ant2	5230	40.16	5210.00	5250.16	---	---
	Ant1	5270	40.56	5249.68	5290.24	---	---
	Ant2	5270	40.08	5250.00	5290.08	---	---
	Ant1	5310	40.88	5289.52	5330.40	---	---
	Ant2	5310	40.24	5289.92	5330.16	---	---
	Ant1	5510	40.64	5489.60	5530.24	---	---
	Ant2	5510	40.08	5490.00	5530.08	---	---
	Ant1	5550	40.64	5529.68	5570.32	---	---
	Ant2	5550	40.16	5529.92	5570.08	---	---
	Ant1	5670	43.04	5649.68	5692.72	---	---
	Ant2	5670	40.32	5649.92	5690.24	---	---
	Ant1	5755	40.80	5734.52	5775.32	---	---
	Ant2	5755	40.16	5734.92	5775.08	---	---
	Ant1	5795	40.88	5774.52	5815.40	---	---
	Ant2	5795	40.00	5775.00	5815.00	---	---
11AC20MIMO	Ant1	5180	21.68	5169.12	5190.80	---	---
	Ant2	5180	21.40	5169.28	5190.68	---	---
	Ant1	5200	21.72	5189.04	5210.76	---	---
	Ant2	5200	21.52	5189.20	5210.72	---	---
	Ant1	5240	21.60	5229.20	5250.80	---	---
	Ant2	5240	21.44	5229.28	5250.72	---	---
	Ant1	5260	21.56	5249.20	5270.76	---	---
	Ant2	5260	21.48	5249.20	5270.68	---	---
	Ant1	5280	21.68	5269.12	5290.80	---	---
	Ant2	5280	21.48	5269.24	5290.72	---	---
	Ant1	5320	21.76	5309.04	5330.80	---	---
	Ant2	5320	21.48	5309.24	5330.72	---	---
	Ant1	5500	21.60	5489.20	5510.80	---	---
	Ant2	5500	21.40	5489.24	5510.64	---	---
	Ant1	5580	21.60	5569.20	5590.80	---	---
	Ant2	5580	21.64	5569.08	5590.72	---	---
	Ant1	5700	21.56	5689.20	5710.76	---	---
	Ant2	5700	21.84	5689.20	5711.04	---	---
	Ant1	5745	21.60	5734.20	5755.80	---	---
	Ant2	5745	21.64	5734.08	5755.72	---	---
	Ant1	5785	21.60	5774.16	5795.76	---	---
	Ant2	5785	21.56	5774.20	5795.76	---	---
	Ant1	5825	21.52	5814.24	5835.76	---	---
	Ant2	5825	21.76	5814.04	5835.80	---	---
11AC40MIMO	Ant1	5190	40.48	5169.76	5210.24	---	---
	Ant2	5190	39.92	5170.08	5210.00	---	---
	Ant1	5230	40.64	5209.60	5250.24	---	---
	Ant2	5230	40.00	5210.08	5250.08	---	---
	Ant1	5270	40.64	5249.68	5290.32	---	---
	Ant2	5270	40.16	5249.92	5290.08	---	---
	Ant1	5310	40.72	5289.60	5330.32	---	---
	Ant2	5310	40.00	5290.00	5330.00	---	---
Ant1	5510	40.56	5489.68	5530.24	---	---	
Ant2	5510	40.00	5490.00	5530.00	---	---	

	Ant1	5550	40.56	5529.68	5570.24	---	---
	Ant2	5550	39.84	5530.08	5569.92	---	---
	Ant1	5670	40.64	5649.68	5690.32	---	---
	Ant2	5670	39.92	5650.00	5689.92	---	---
	Ant1	5755	40.48	5734.76	5775.24	---	---
	Ant2	5755	40.00	5735.00	5775.00	---	---
	Ant1	5795	40.80	5774.52	5815.32	---	---
	Ant2	5795	40.24	5774.84	5815.08	---	---
11AC80MIMO	Ant1	5210	82.56	5168.56	5251.12	---	---
	Ant2	5210	82.56	5168.88	5251.44	---	---
	Ant1	5290	82.56	5248.72	5331.28	---	---
	Ant2	5290	82.56	5249.04	5331.60	---	---
	Ant1	5530	83.04	5488.40	5571.44	---	---
	Ant2	5530	82.40	5488.88	5571.28	---	---
	Ant1	5610	83.04	5568.56	5651.60	---	---
	Ant2	5610	82.56	5568.56	5651.12	---	---
	Ant1	5775	83.36	5733.40	5816.76	---	---
	Ant2	5775	82.88	5733.72	5816.60	---	---
11AC160MIMO	Ant1	5250	166.08	5167.44	5333.52	---	---
	Ant2	5250	166.08	5167.12	5333.20	---	---
	Ant1	5250_UNII-1	82.56	5167.44	5250	---	---
	Ant2	5250_UNII-1	82.88	5167.12	5250	---	---
	Ant1	5250_UNII-2A	83.52	5250	5333.52	---	---
	Ant2	5250_UNII-2A	83.2	5250	5333.20	---	---
	Ant1	5570	166.08	5487.44	5653.52	---	---
	Ant2	5570	167.68	5487.44	5655.12	---	---
11AX20MIMO	Ant1	5180	21.56	5169.20	5190.76	---	---
	Ant2	5180	21.48	5169.32	5190.80	---	---
	Ant1	5200	21.52	5189.20	5210.72	---	---
	Ant2	5200	21.48	5189.32	5210.80	---	---
	Ant1	5240	21.56	5229.20	5250.76	---	---
	Ant2	5240	21.44	5229.36	5250.80	---	---
	Ant1	5260	21.68	5249.08	5270.76	---	---
	Ant2	5260	21.56	5249.28	5270.84	---	---
	Ant1	5280	21.60	5269.16	5290.76	---	---
	Ant2	5280	21.52	5269.32	5290.84	---	---
	Ant1	5320	21.52	5309.24	5330.76	---	---
	Ant2	5320	21.56	5309.28	5330.84	---	---
	Ant1	5500	21.76	5489.08	5510.84	---	---
	Ant2	5500	21.52	5489.32	5510.84	---	---
	Ant1	5580	21.76	5569.08	5590.84	---	---
	Ant2	5580	21.56	5569.28	5590.84	---	---
	Ant1	5700	21.52	5689.16	5710.68	---	---
	Ant2	5700	22.28	5689.28	5711.56	---	---
	Ant1	5745	21.68	5734.12	5755.80	---	---
	Ant2	5745	21.56	5734.28	5755.84	---	---
	Ant1	5785	21.72	5774.12	5795.84	---	---
	Ant2	5785	21.56	5774.28	5795.84	---	---
	Ant1	5825	23.00	5814.16	5837.16	---	---
	Ant2	5825	22.12	5814.28	5836.40	---	---

11AX40MIMO	Ant1	5190	40.48	5169.76	5210.24	---	---
	Ant2	5190	40.32	5169.92	5210.24	---	---
	Ant1	5230	40.56	5209.68	5250.24	---	---
	Ant2	5230	40.32	5209.92	5250.24	---	---
	Ant1	5270	40.56	5249.76	5290.32	---	---
	Ant2	5270	40.24	5249.92	5290.16	---	---
	Ant1	5310	40.56	5289.68	5330.24	---	---
	Ant2	5310	40.16	5290.00	5330.16	---	---
	Ant1	5510	40.48	5489.76	5530.24	---	---
	Ant2	5510	40.24	5489.92	5530.16	---	---
	Ant1	5550	40.40	5529.84	5570.24	---	---
	Ant2	5550	40.16	5530.00	5570.16	---	---
	Ant1	5670	40.32	5649.84	5690.16	---	---
	Ant2	5670	40.16	5649.92	5690.08	---	---
	Ant1	5755	40.48	5734.68	5775.16	---	---
	Ant2	5755	40.32	5734.92	5775.24	---	---
	Ant1	5795	40.40	5774.68	5815.08	---	---
	Ant2	5795	40.24	5775.00	5815.24	---	---
11AX80MIMO	Ant1	5210	82.08	5169.04	5251.12	---	---
	Ant2	5210	81.92	5169.04	5250.96	---	---
	Ant1	5290	82.24	5249.04	5331.28	---	---
	Ant2	5290	82.08	5248.88	5330.96	---	---
	Ant1	5530	82.40	5489.04	5571.44	---	---
	Ant2	5530	81.92	5489.04	5570.96	---	---
	Ant1	5610	82.24	5569.04	5651.28	---	---
	Ant2	5610	81.92	5568.88	5650.80	---	---
	Ant1	5775	82.08	5734.04	5816.12	---	---
	Ant2	5775	81.92	5733.88	5815.80	---	---
11AX160MIMO	Ant1	5250	164.80	5167.76	5332.56	---	---
	Ant2	5250	163.84	5168.40	5332.24	---	---
	Ant1	5250_UNII-1	82.24	5167.76	5250	---	---
	Ant2	5250_UNII-1	81.6	5168.40	5250	---	---
	Ant1	5250_UNII-2A	82.56	5250	5332.56	---	---
	Ant2	5250_UNII-2A	82.24	5250	5332.24	---	---
	Ant1	5570	165.12	5487.44	5652.56	---	---
	Ant2	5570	163.84	5488.40	5652.24	---	---

11A_Ant1_5180

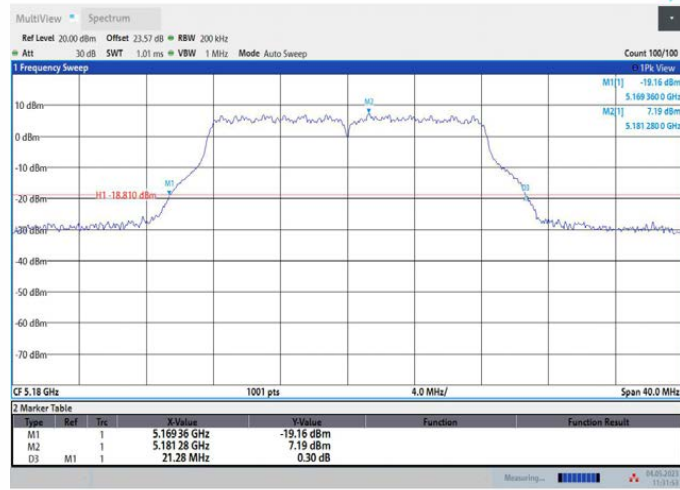

11:31:53 04.05.2023

11A_Ant2_5180



00:48:49 05.05.2023

11A_Ant1_5200

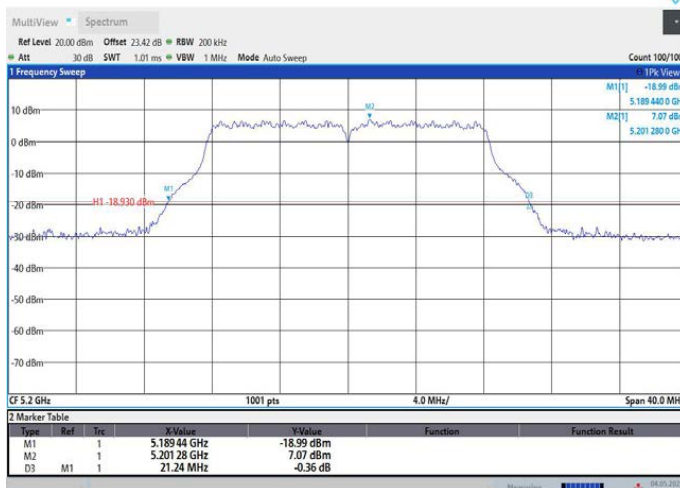

11:44:21 04.05.2023

11A_Ant2_5200

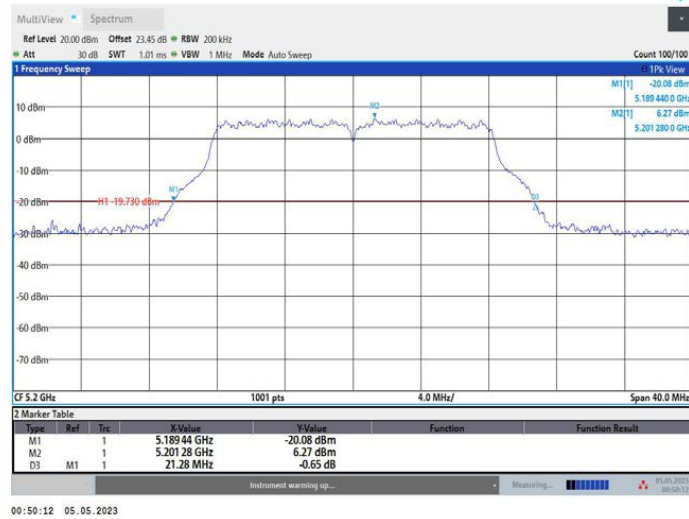

11A_Ant1_5240

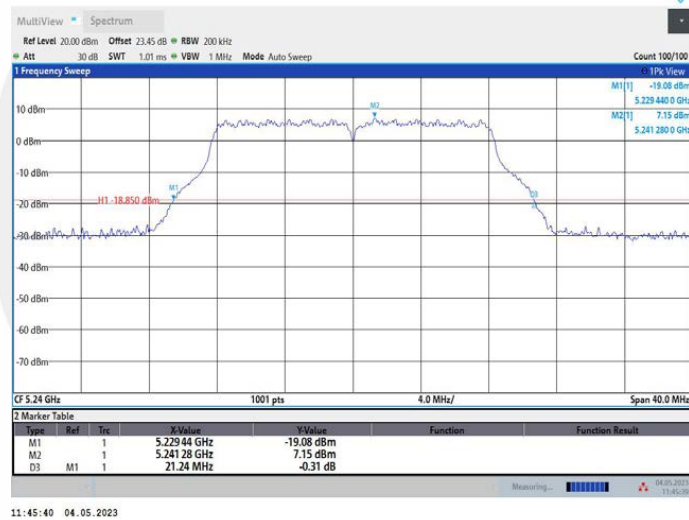

11A_Ant2_5240

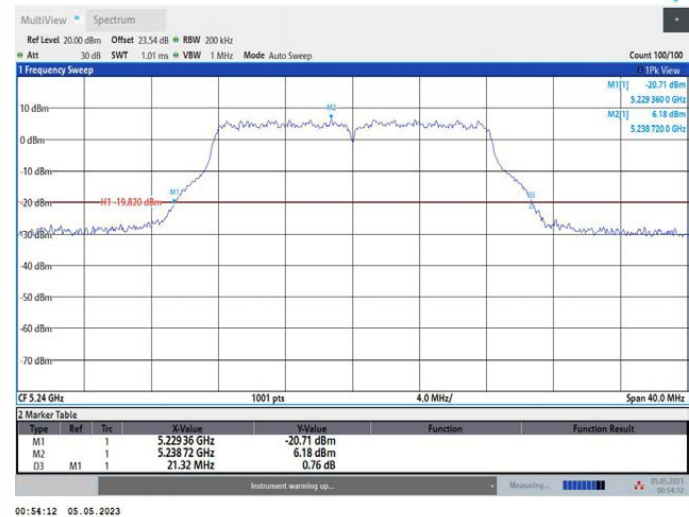

11A_Ant1_5260

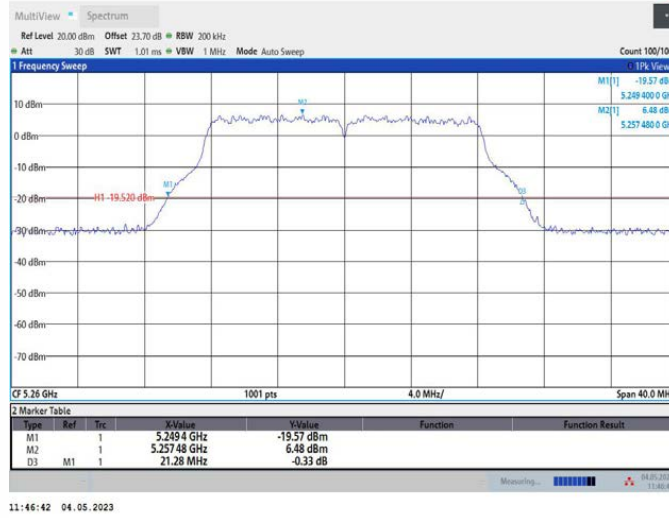

11A_Ant2_5260

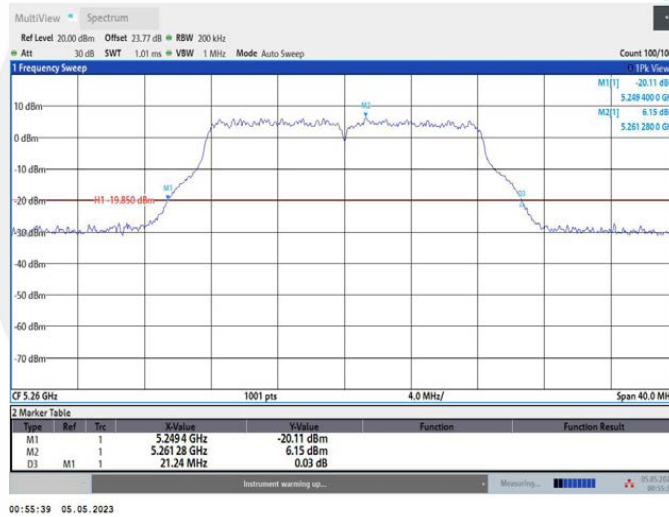

11A_Ant1_5280

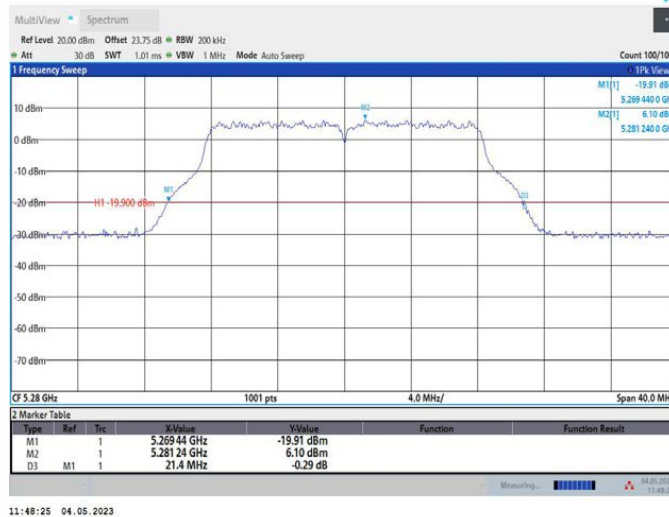

11A_Ant2_5280

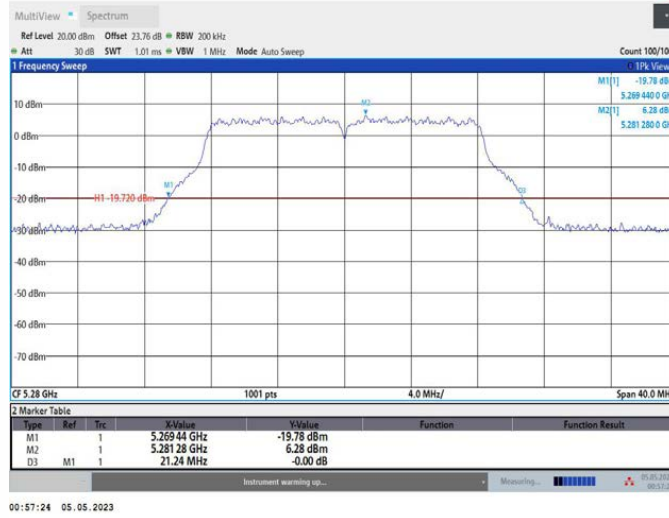

11A_Ant1_5320

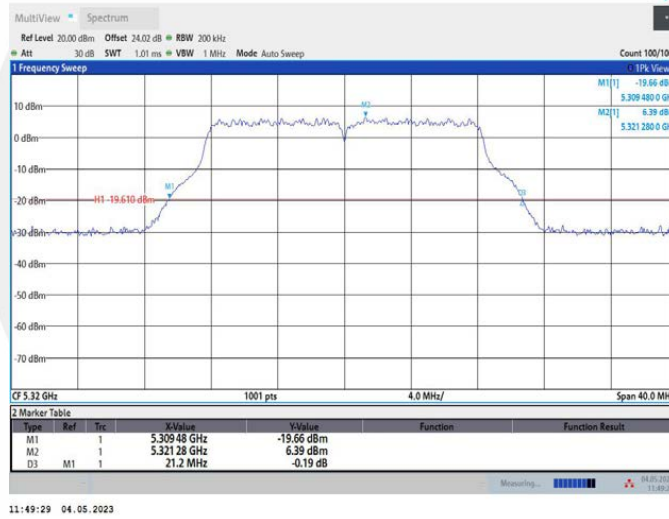

11A_Ant2_5320

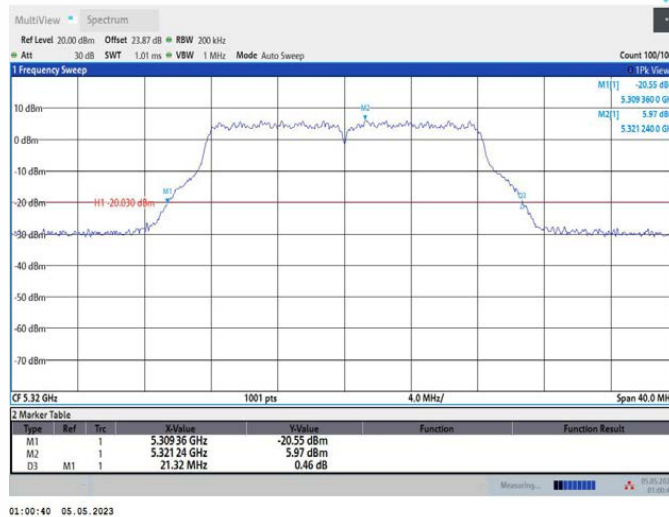

11A_Ant1_5500

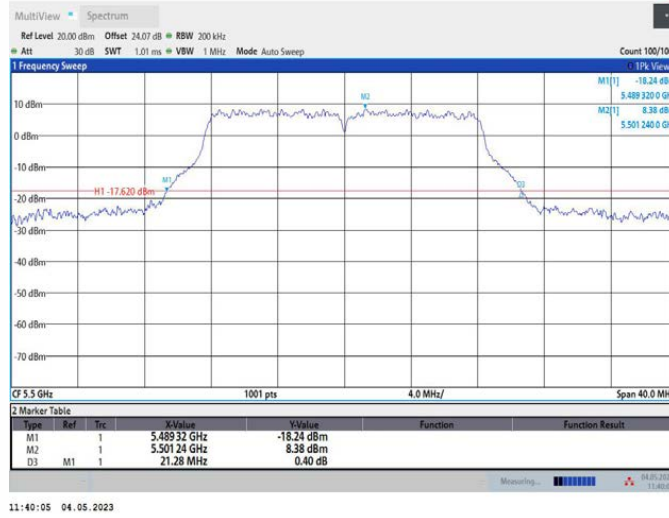

11A_Ant2_5500



11A_Ant1_5580

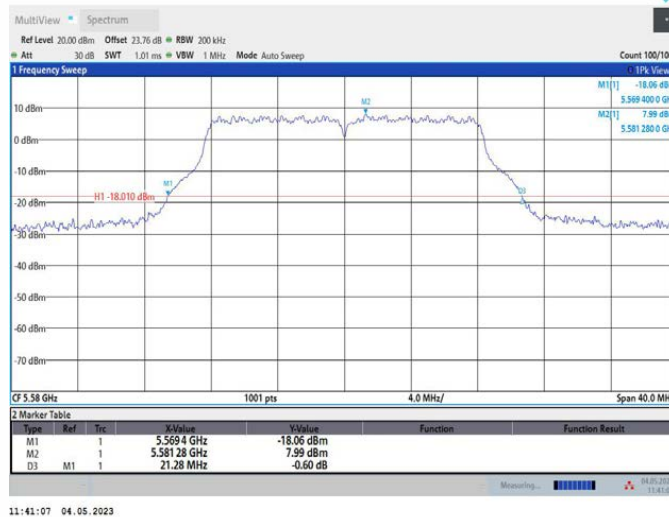

11A_Ant2_5580

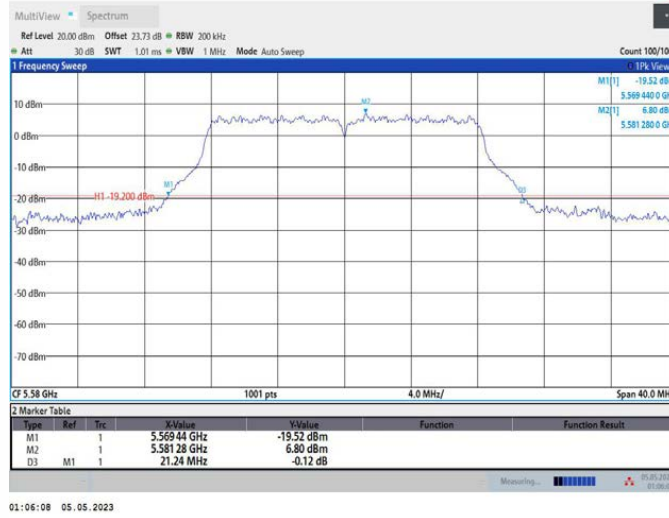

11A_Ant1_5700



11A_Ant2_5700

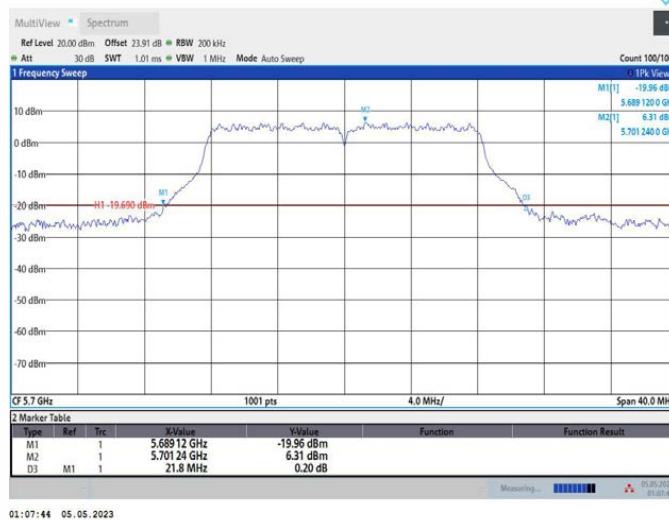

11A_Ant1_5745

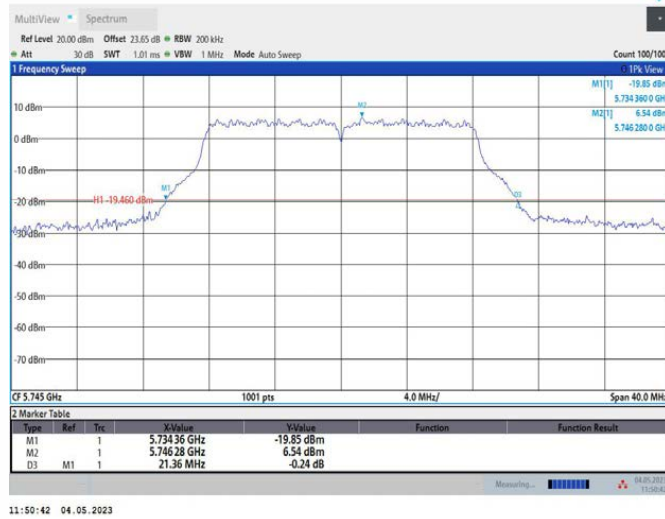

11:50:42 04.05.2023

11A_Ant2_5745

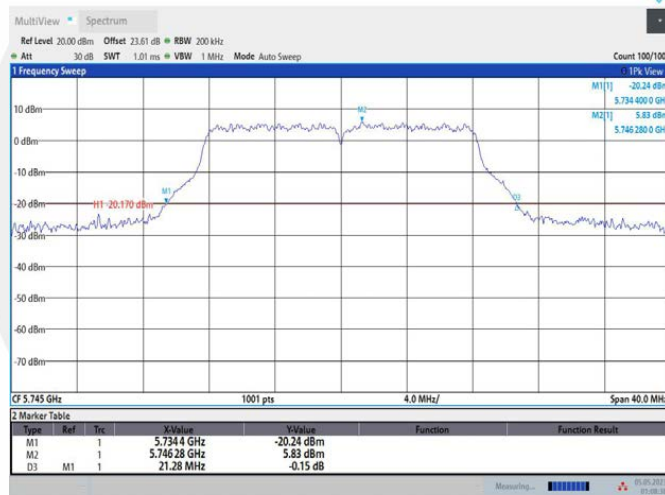

01:08:39 05.05.2023

11A_Ant1_5785

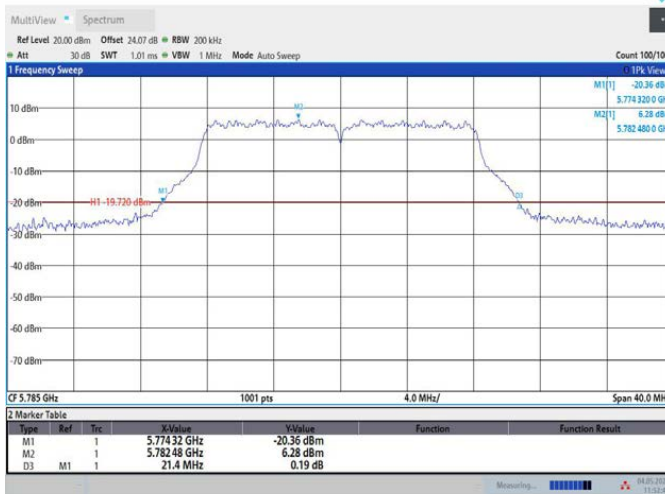

11:52:46 04.05.2023

11A_Ant2_5785

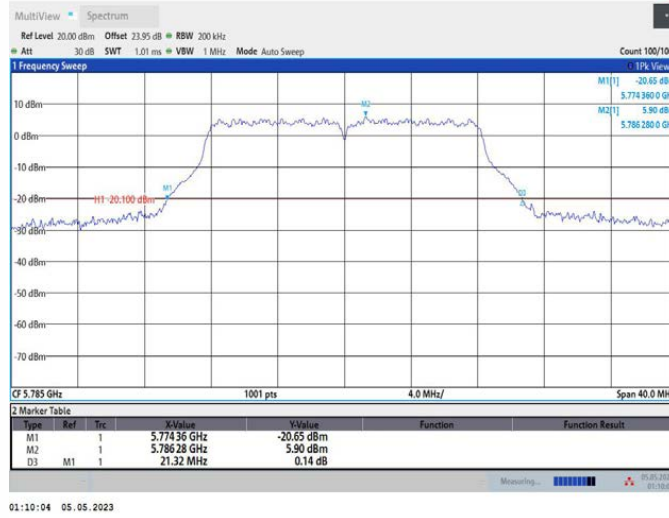

11A_Ant1_5825

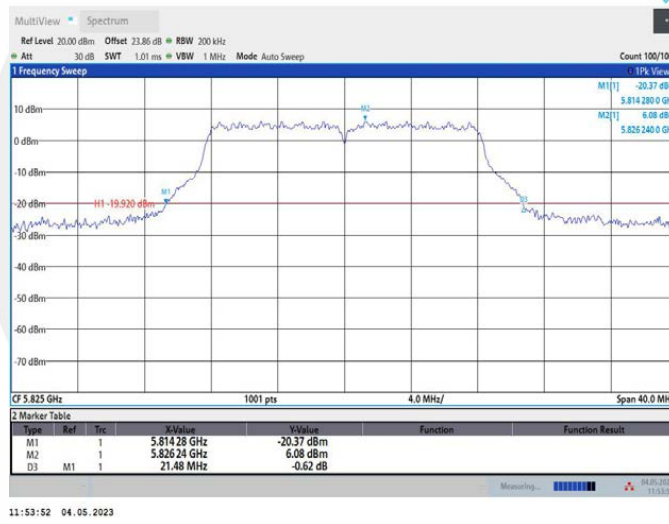

11A_Ant2_5825

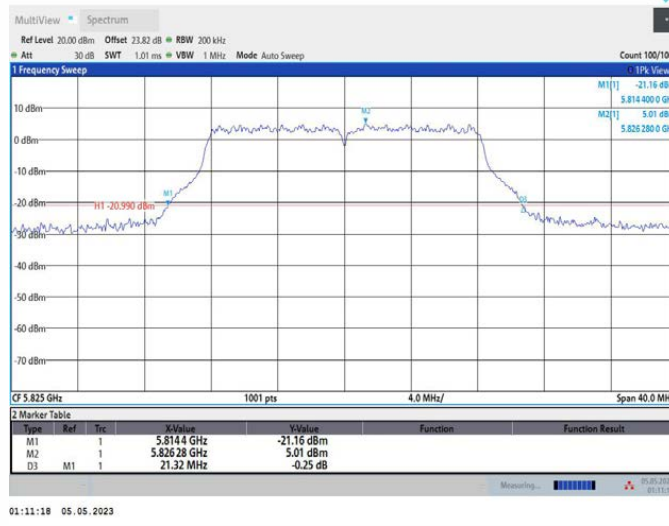

11N20MIMO_Ant1_5180

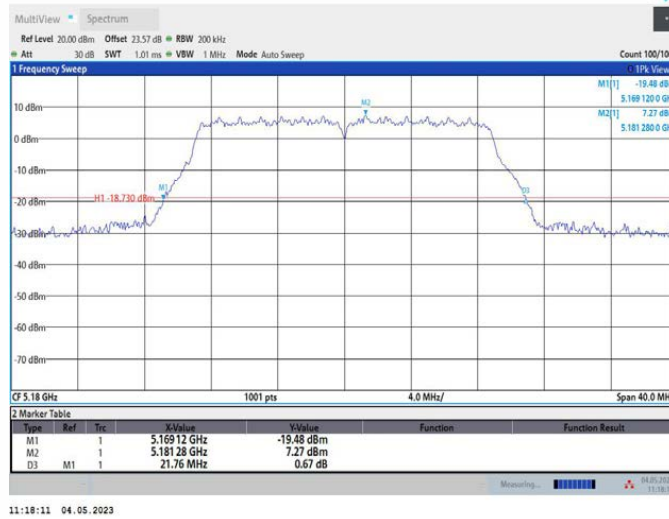

11N20MIMO_Ant2_5180

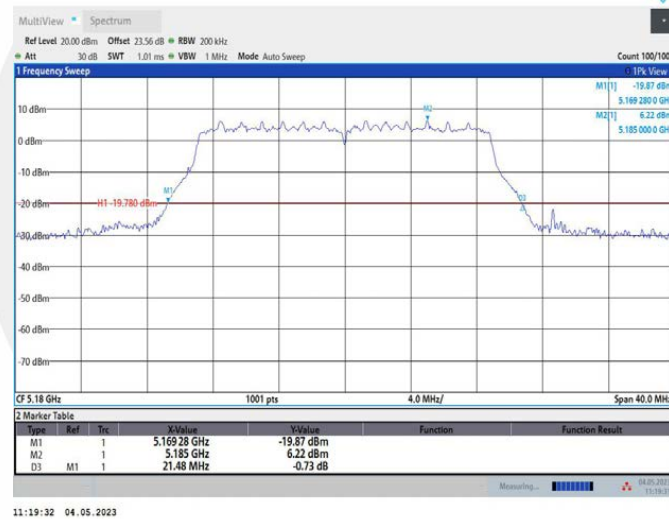

11N20MIMO_Ant1_5200



11N20MIMO_Ant2_5200

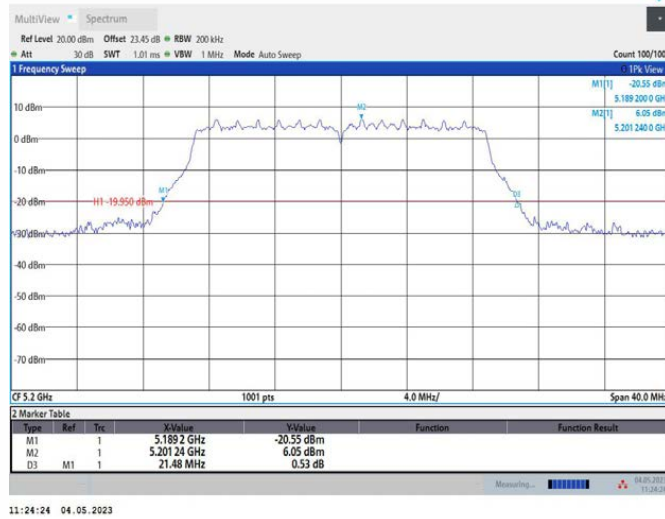

11N20MIMO_Ant1_5240

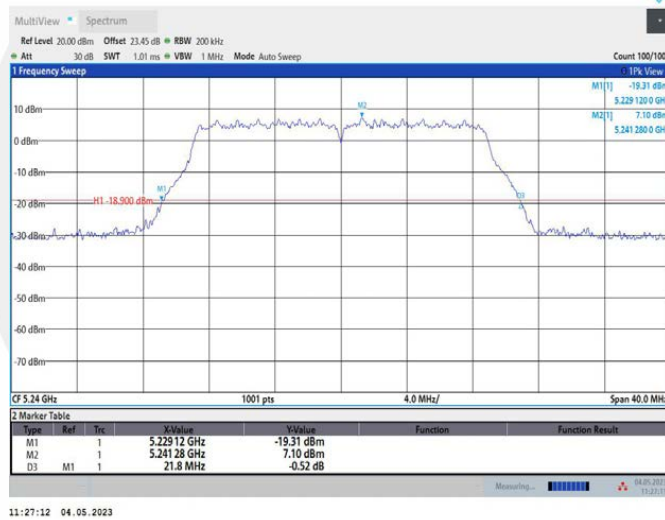

11N20MIMO_Ant2_5240

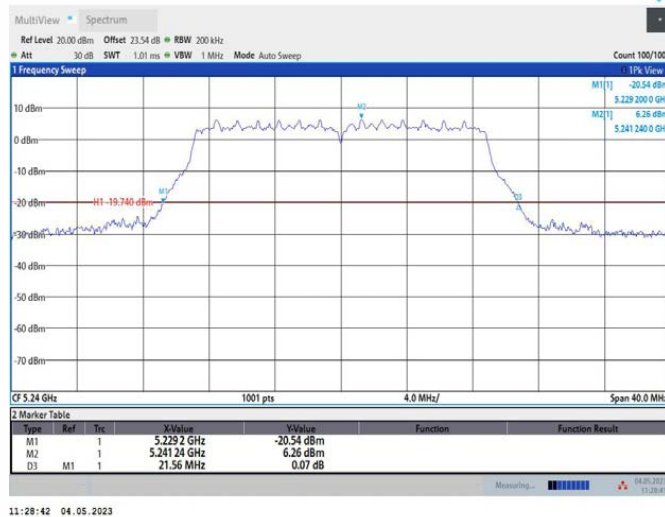

11N20MIMO_Ant1_5260

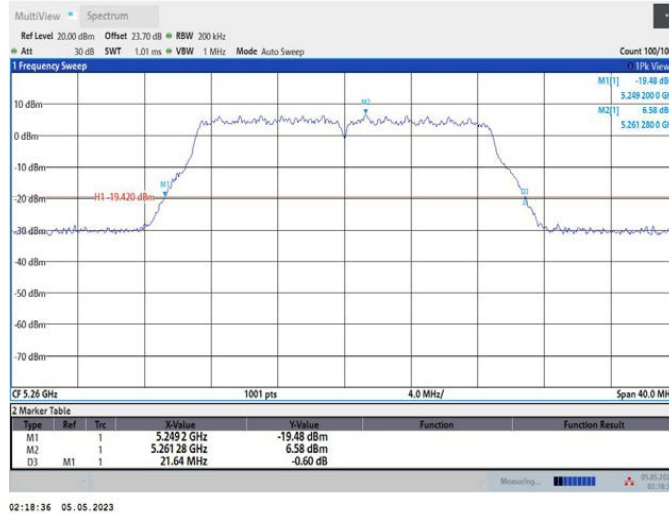

11N20MIMO_Ant2_5260

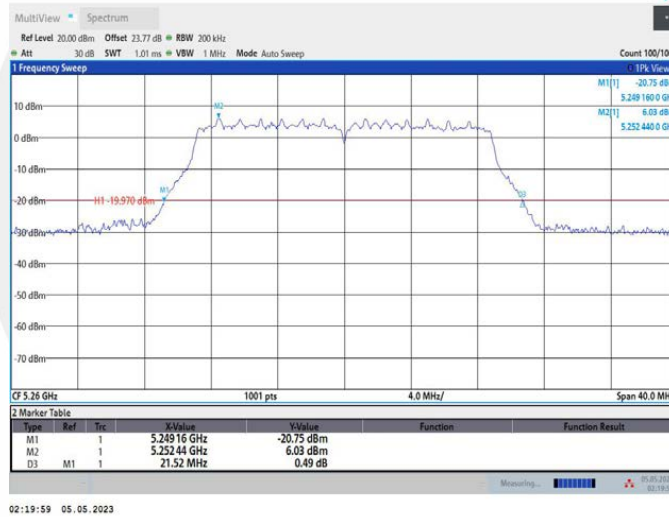

11N20MIMO_Ant1_5280

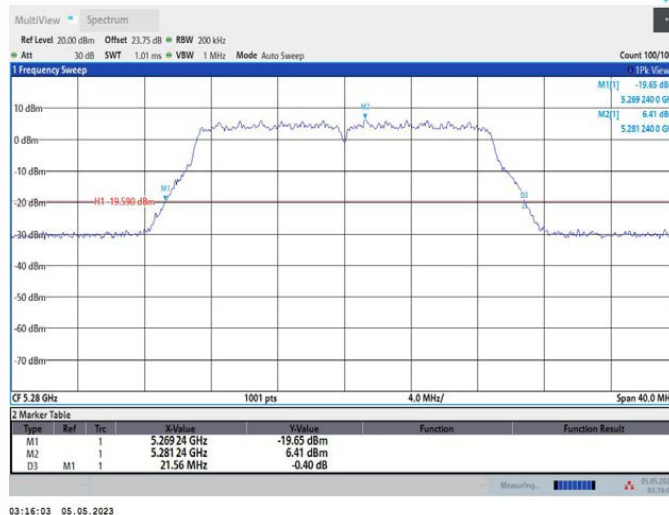

11N20MIMO_Ant2_5280

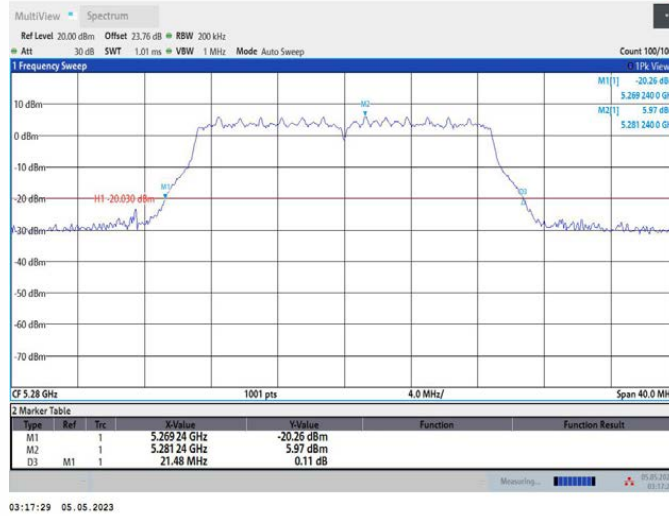

11N20MIMO_Ant1_5320

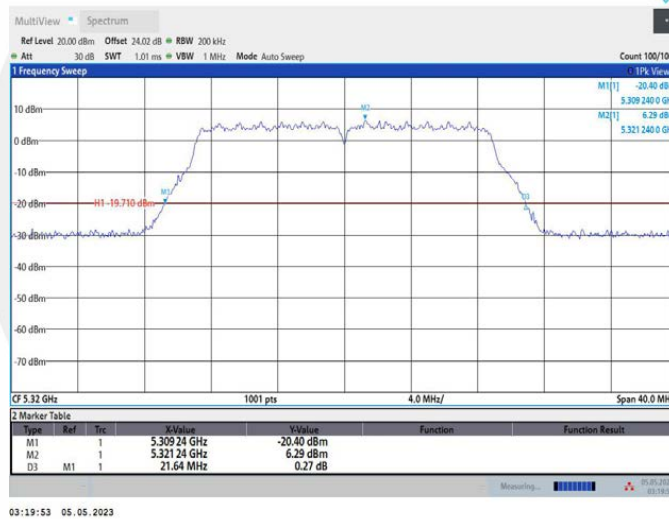

11N20MIMO_Ant2_5320

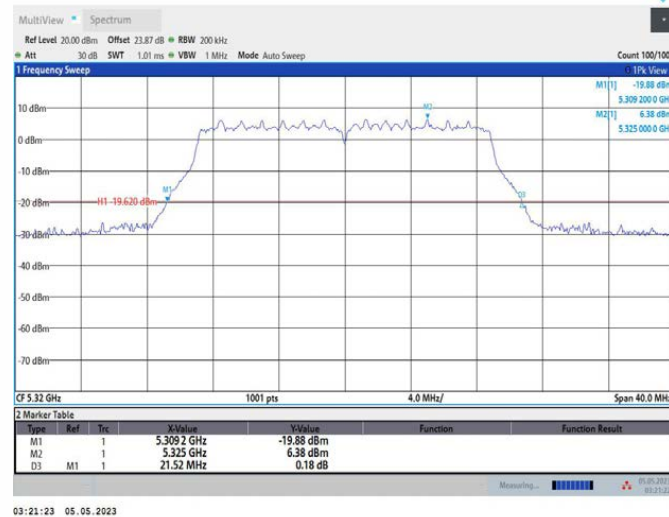

11N20MIMO_Ant1_5500

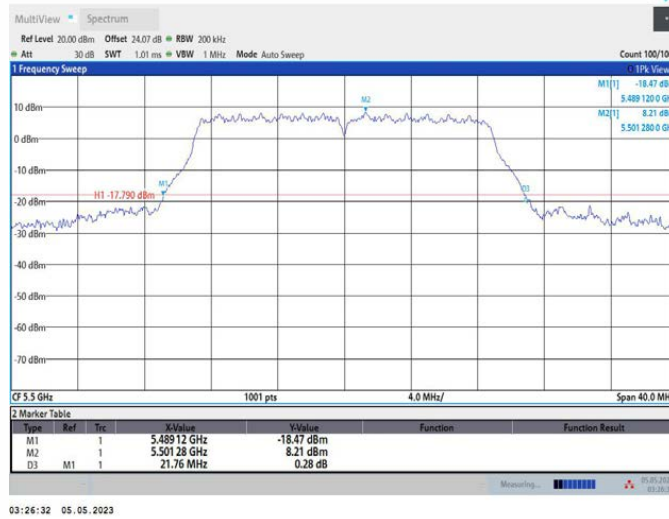

11N20MIMO_Ant2_5500



11N20MIMO_Ant1_5580

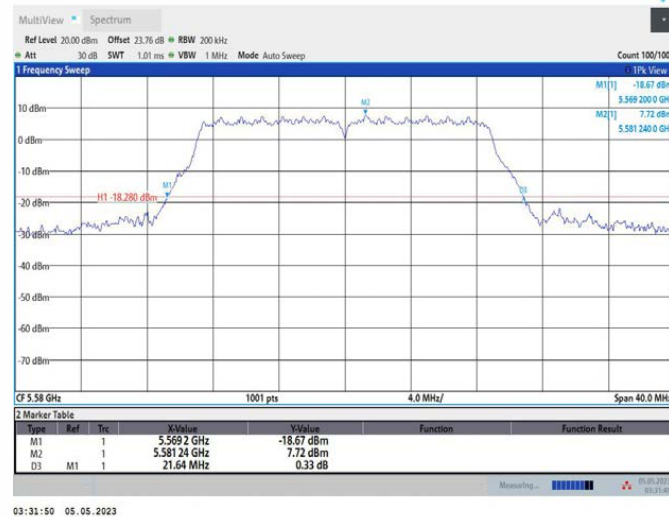

11N20MIMO_Ant2_5580

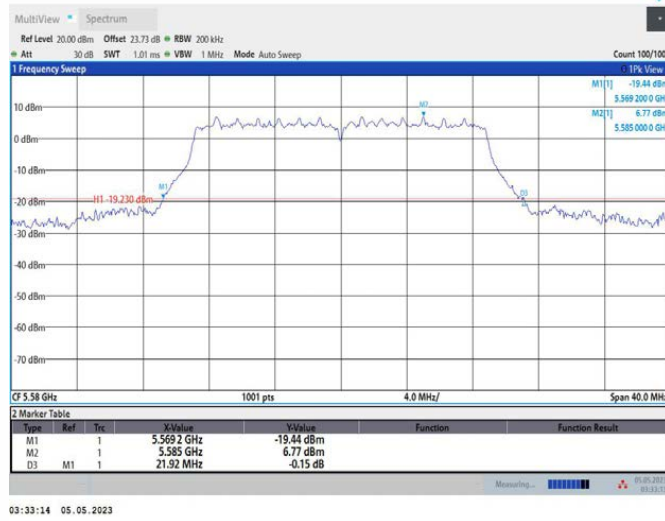

11N20MIMO_Ant1_5700

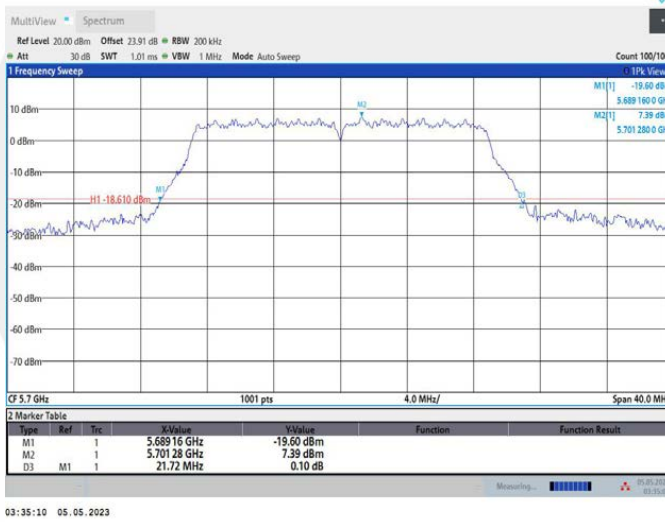

11N20MIMO_Ant2_5700

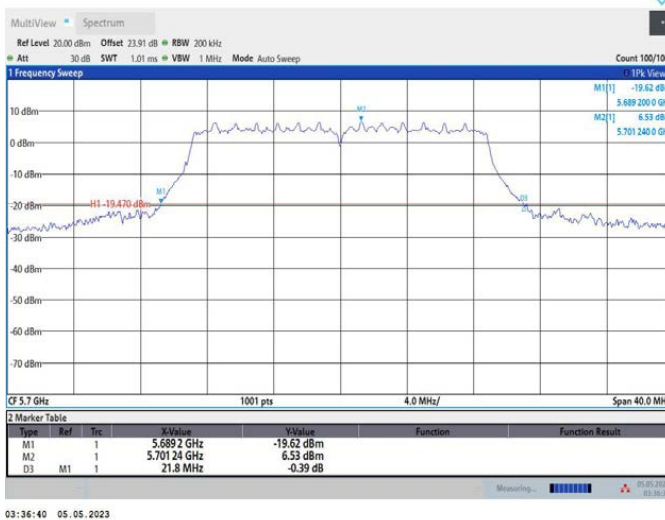

11N20MIMO_Ant1_5745

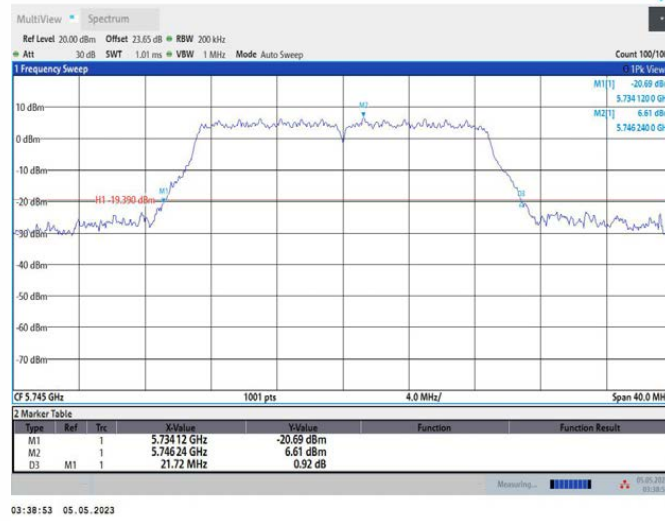

11N20MIMO_Ant2_5745

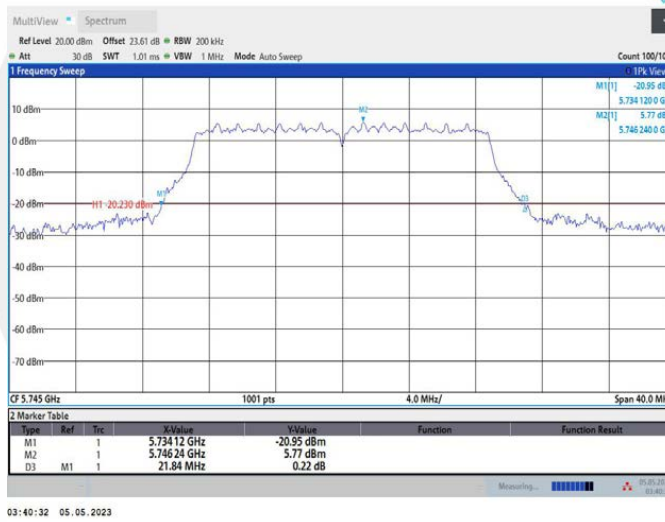

11N20MIMO_Ant1_5785

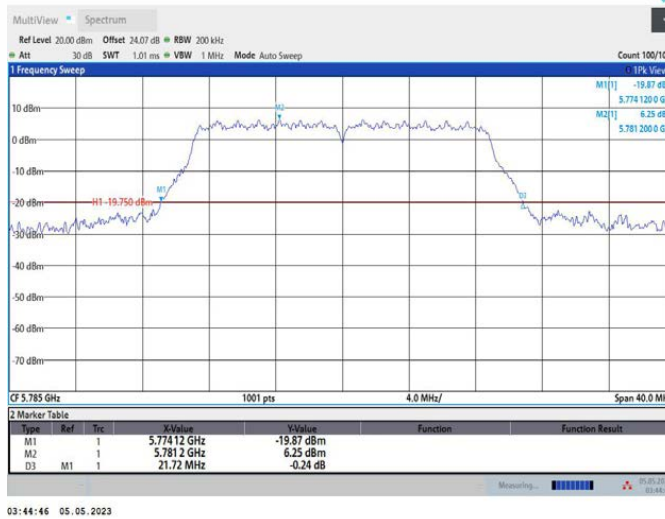

11N20MIMO_Ant2_5785

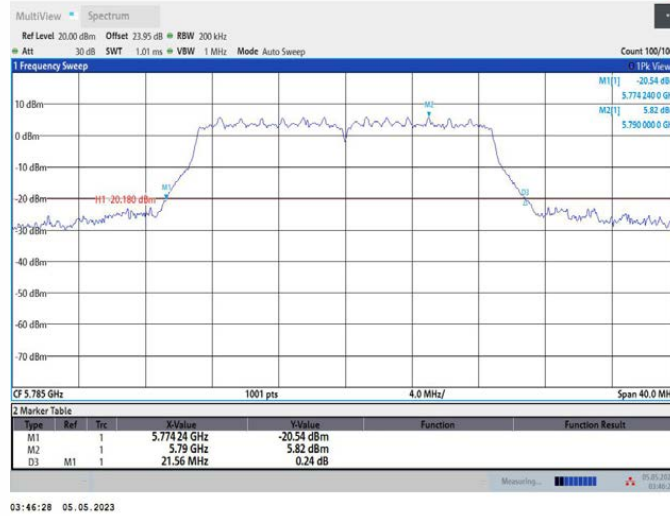

11N20MIMO_Ant1_5825

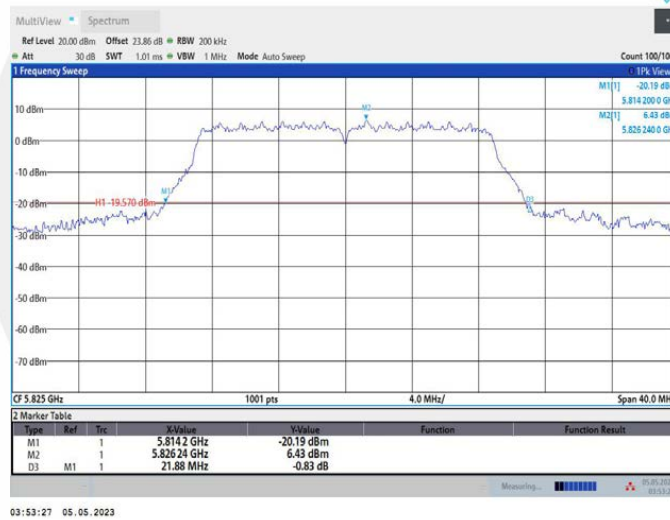

11N20MIMO_Ant2_5825

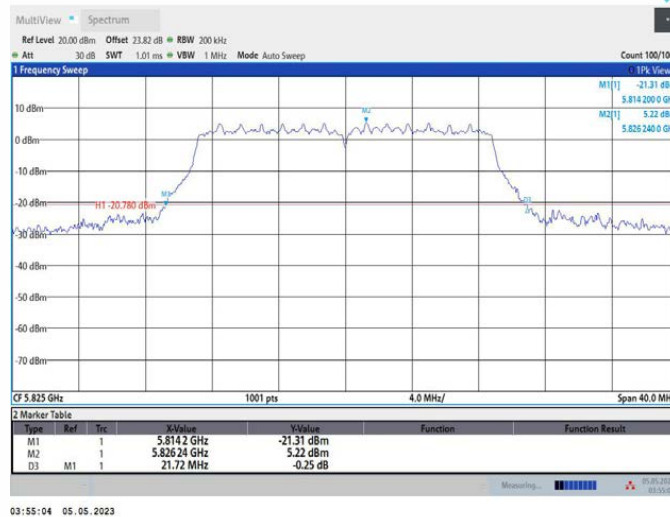

11N40MIMO_Ant1_5190

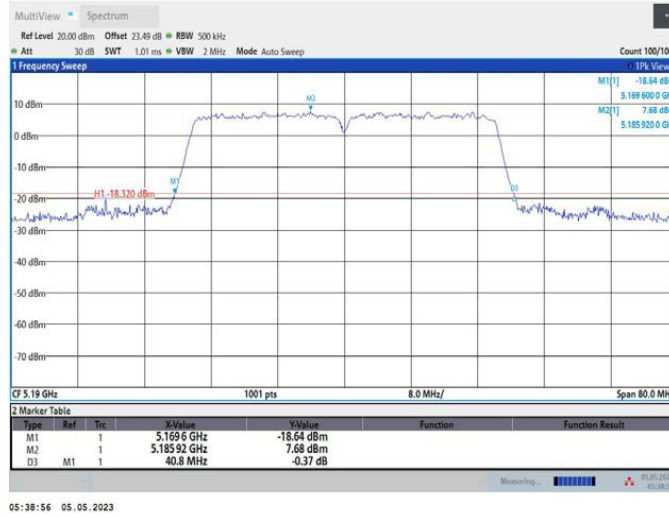

11N40MIMO_Ant2_5190

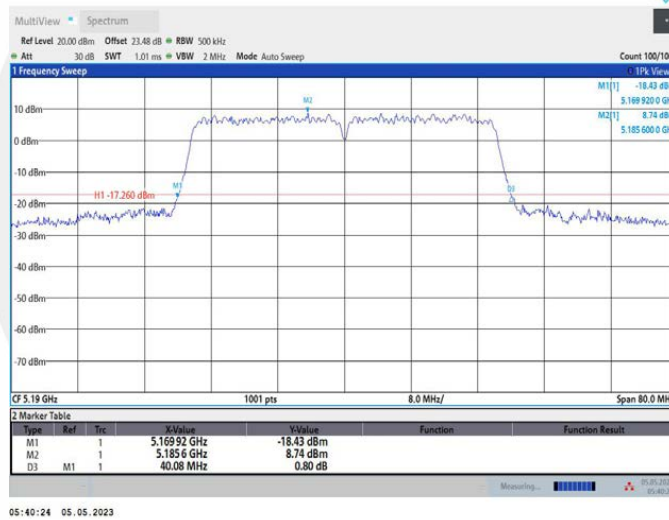

11N40MIMO_Ant1_5230

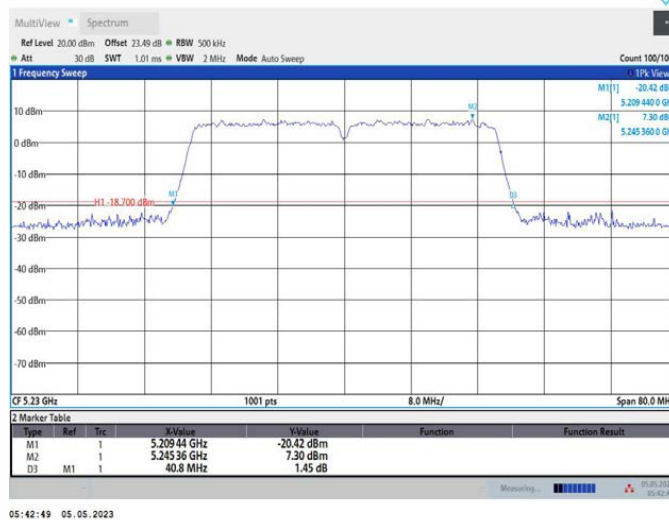

11N40MIMO_Ant2_5230

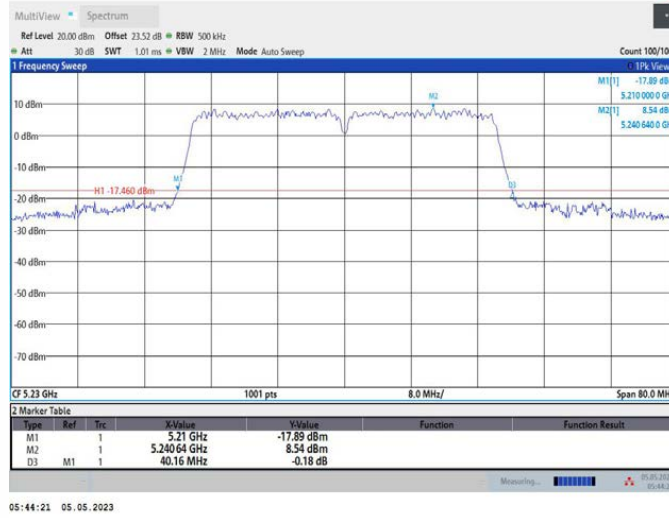

05:44:21 05.05.2023

11N40MIMO_Ant1_5270

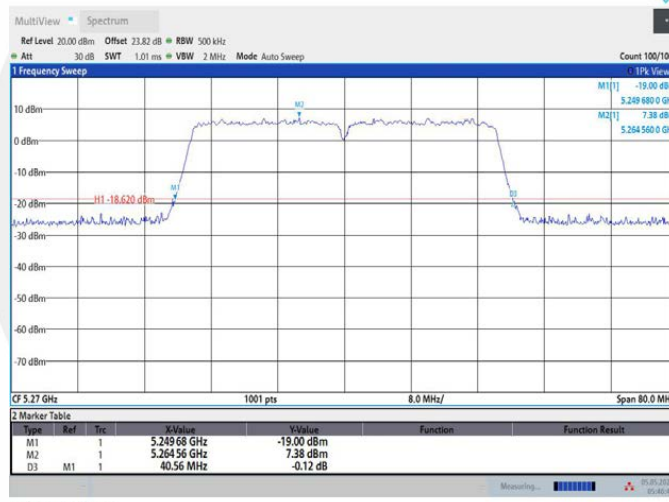

05:46:46 05.05.2023

11N40MIMO_Ant2_5270

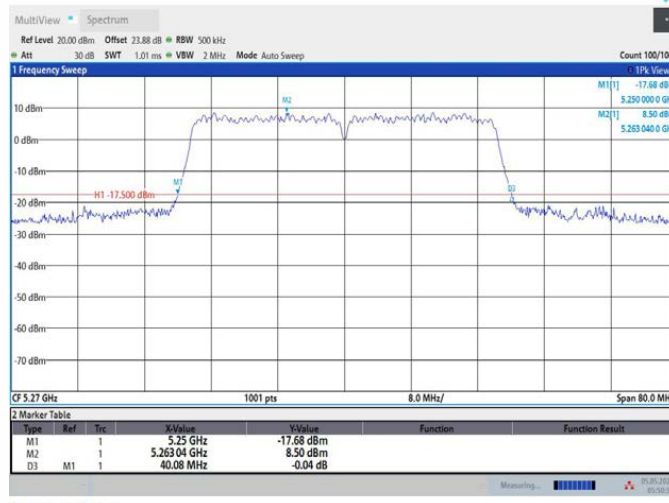

05:50:55 05.05.2023

11N40MIMO_Ant1_5310

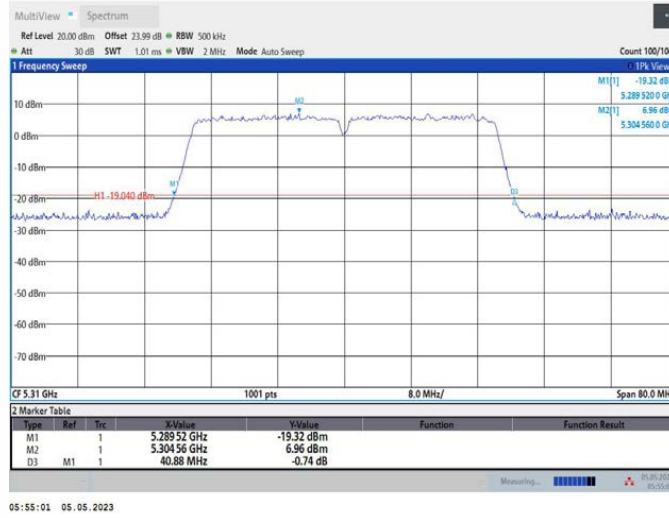

05:55:01 05.05.2023

11N40MIMO_Ant2_5310

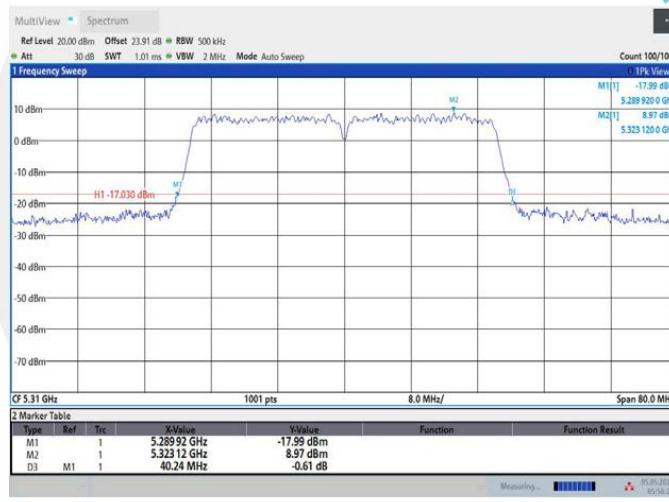

05:56:30 05.05.2023

11N40MIMO_Ant1_5510

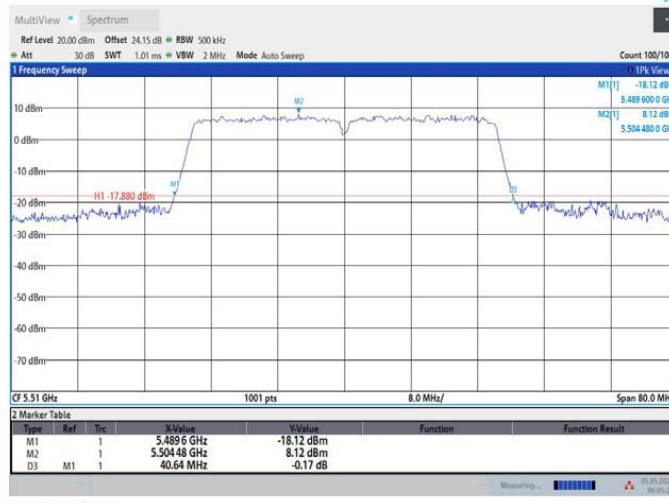

06:05:22 05.05.2023

11N40MIMO_Ant2_5510



11N40MIMO_Ant1_5550

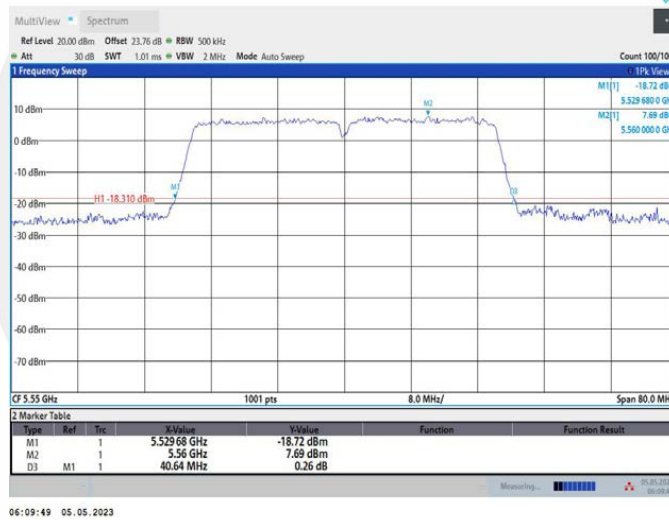

11N40MIMO_Ant2_5550

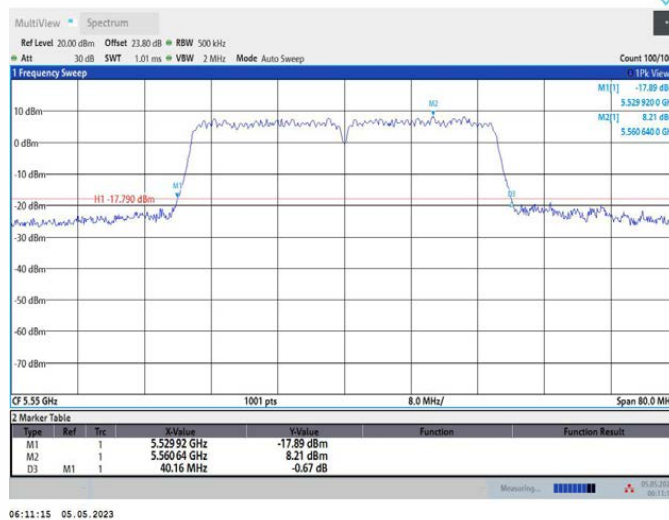

11N40MIMO_Ant1_5670

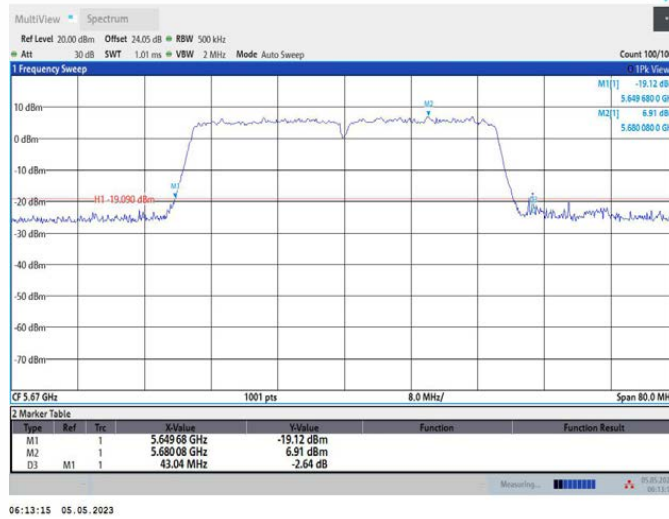

11N40MIMO_Ant2_5670

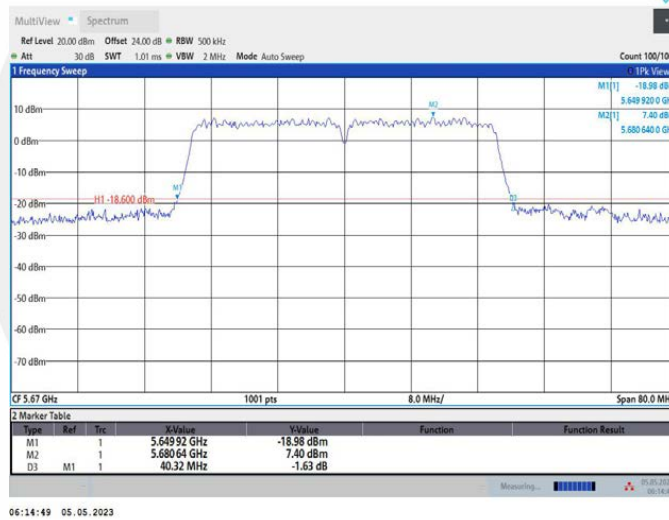

11N40MIMO_Ant1_5755

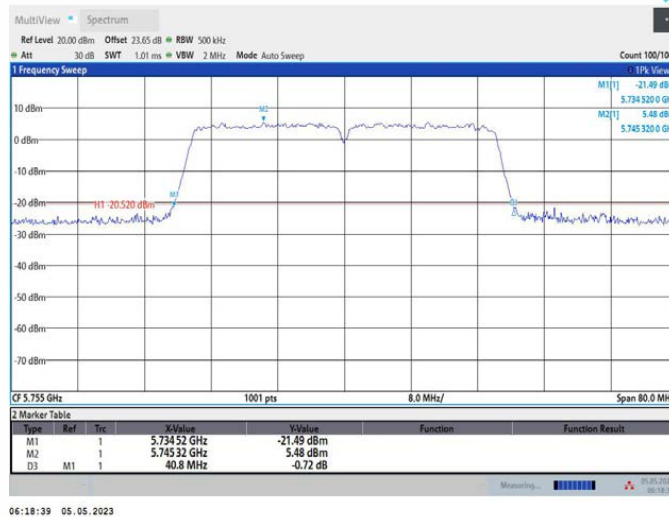

11N40MIMO_Ant2_5755



11N40MIMO_Ant1_5795

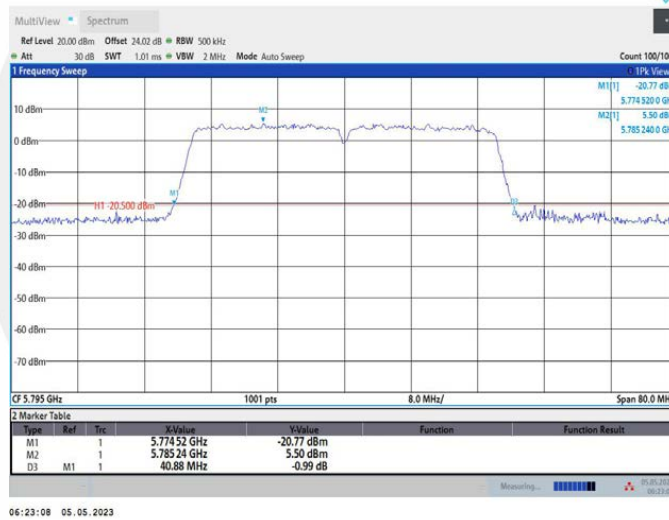

11N40MIMO_Ant2_5795

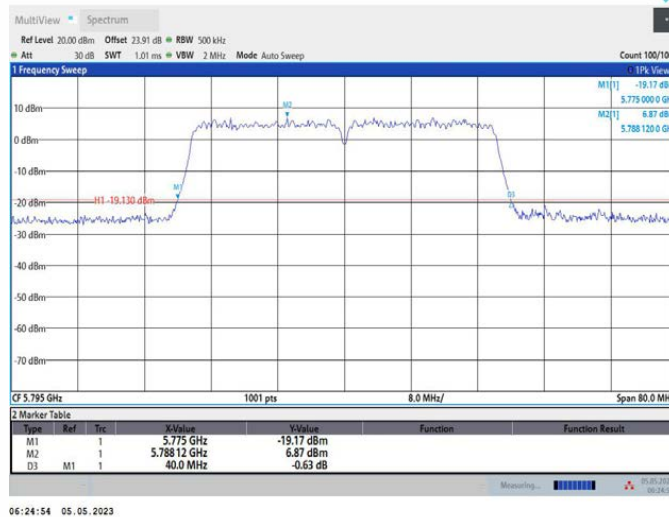

11AC20MIMO_Ant1_5180



06:29:36 05.05.2023

11AC20MIMO_Ant2_5180

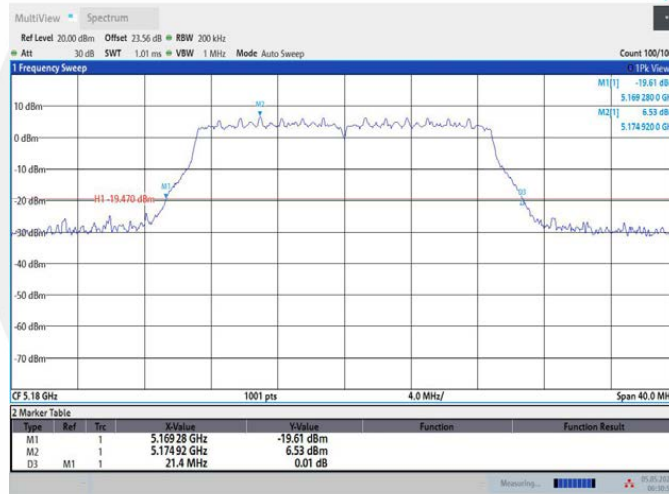

06:30:58 05.05.2023

11AC20MIMO_Ant1_5200



06:33:00 05.05.2023

11AC20MIMO_Ant2_5200

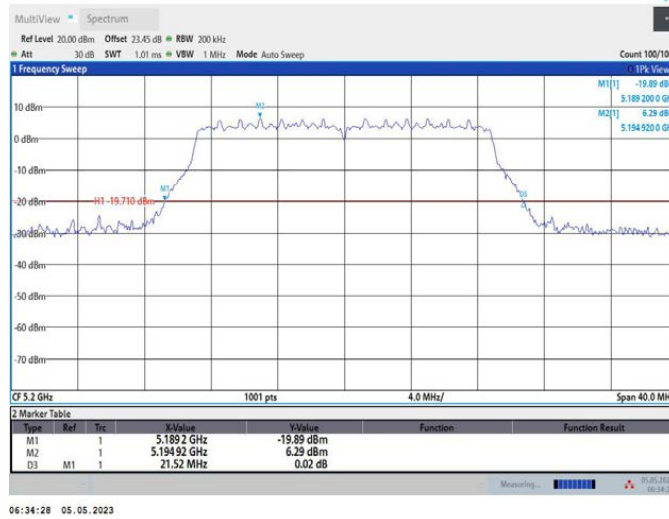

11AC20MIMO_Ant1_5240

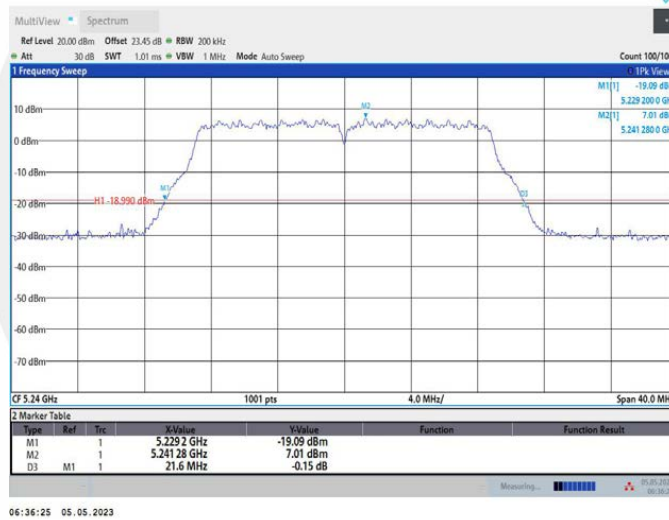

11AC20MIMO_Ant2_5240

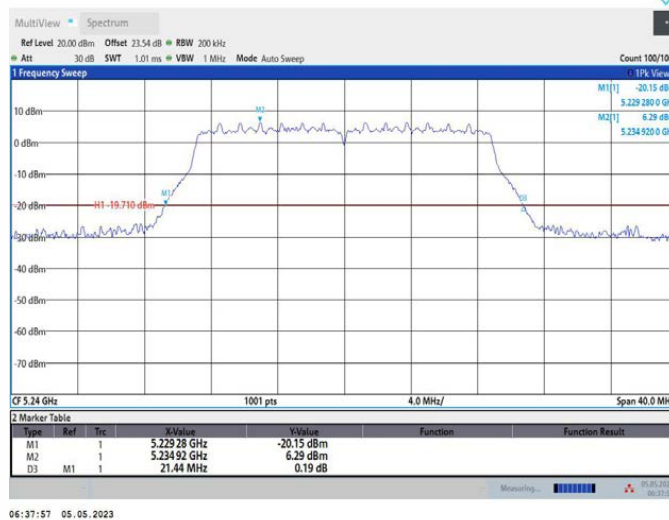

11AC20MIMO_Ant1_5260

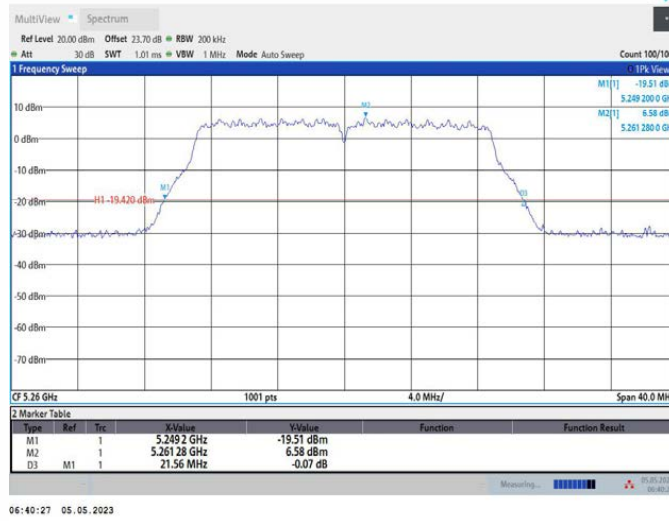

11AC20MIMO_Ant2_5260

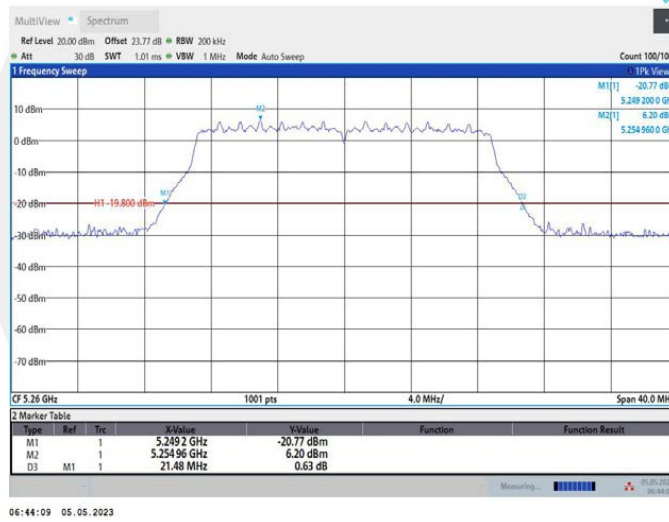

11AC20MIMO_Ant1_5280

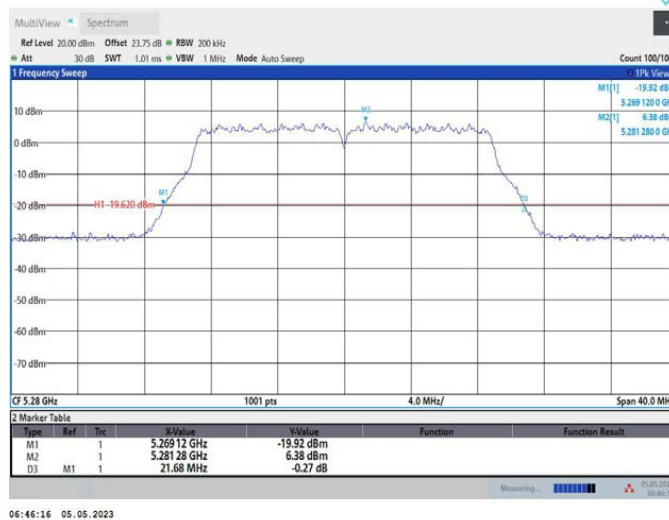

11AC20MIMO_Ant2_5280

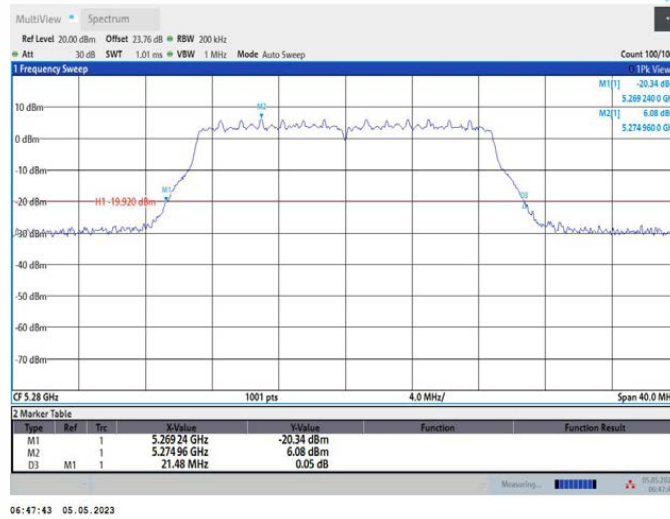

11AC20MIMO_Ant1_5320



11AC20MIMO_Ant2_5320

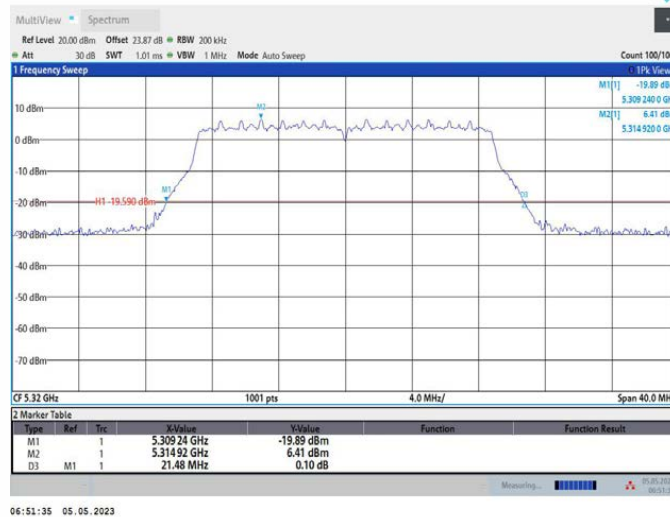

11AC20MIMO_Ant1_5500



07:16:42 05.05.2023

11AC20MIMO_Ant2_5500



07:18:10 05.05.2023

11AC20MIMO_Ant1_5580

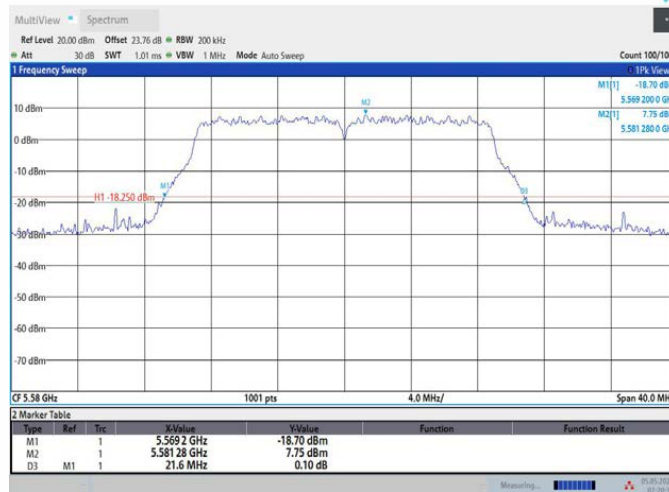

07:20:34 05.05.2023

11AC20MIMO_Ant2_5580

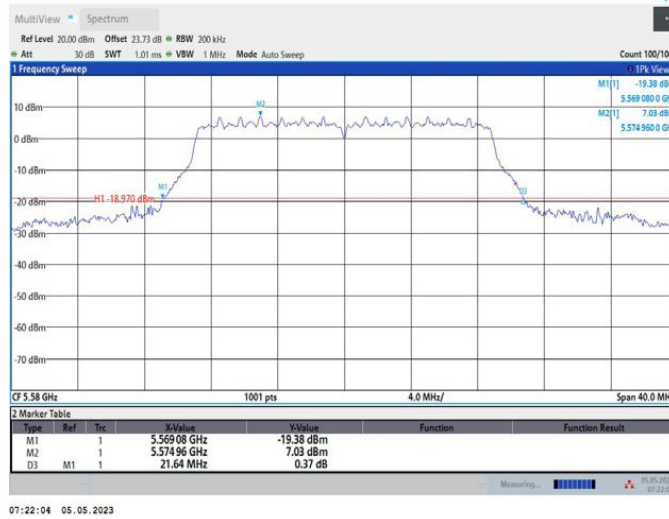

11AC20MIMO_Ant1_5700

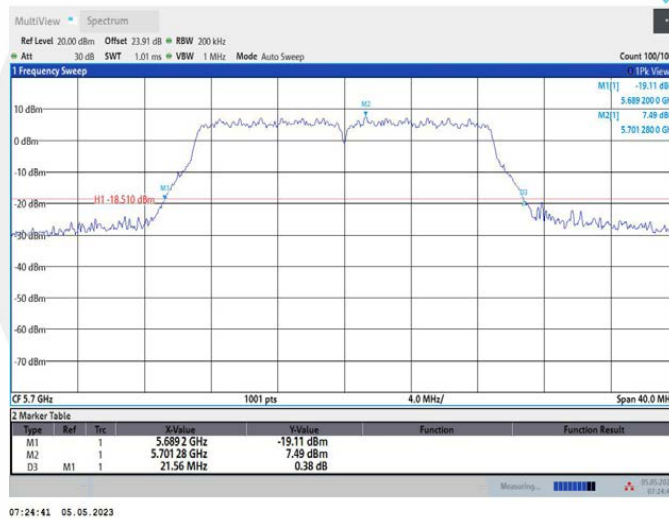

11AC20MIMO_Ant2_5700



11AC20MIMO_Ant1_5745



11AC20MIMO_Ant2_5745



11AC20MIMO_Ant1_5785



11AC20MIMO_Ant2_5785



11AC20MIMO_Ant1_5825

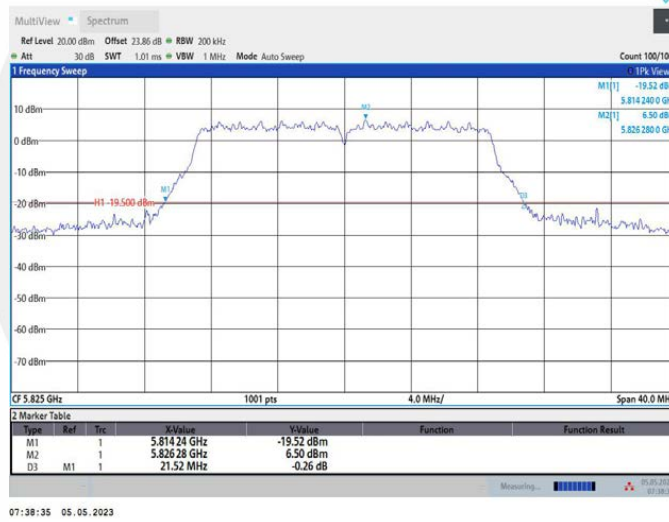

11AC20MIMO_Ant2_5825

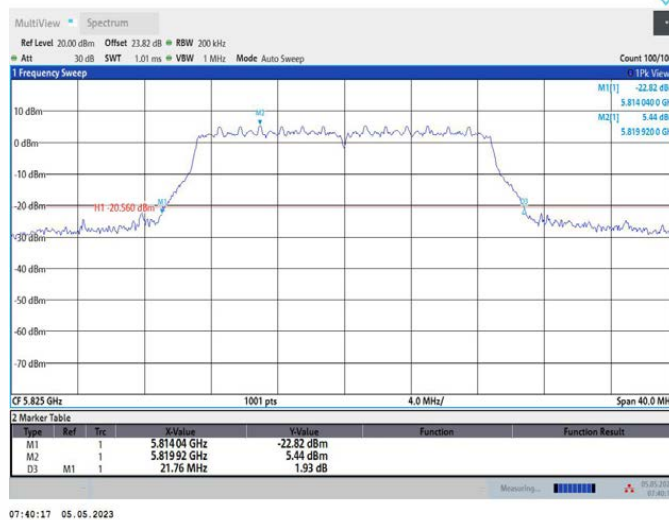

11AC40MIMO_Ant1_5190

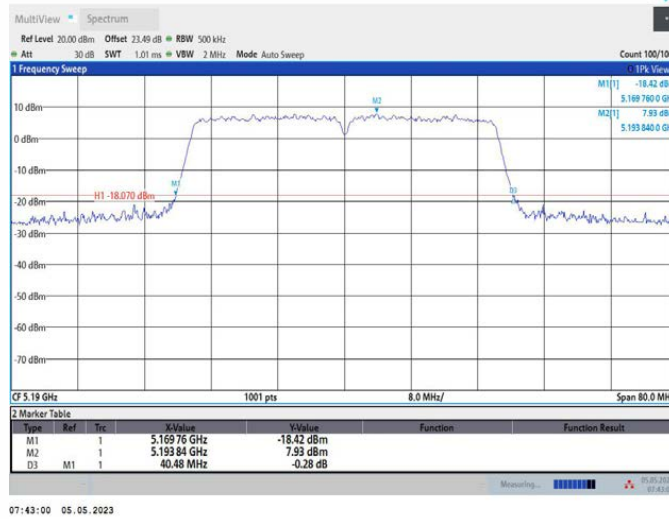

07:43:00 05.05.2023

11AC40MIMO_Ant2_5190

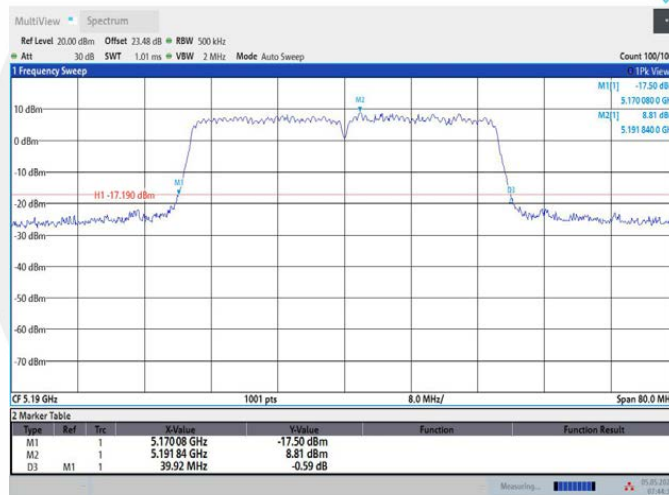

07:44:35 05.05.2023

11AC40MIMO_Ant1_5230

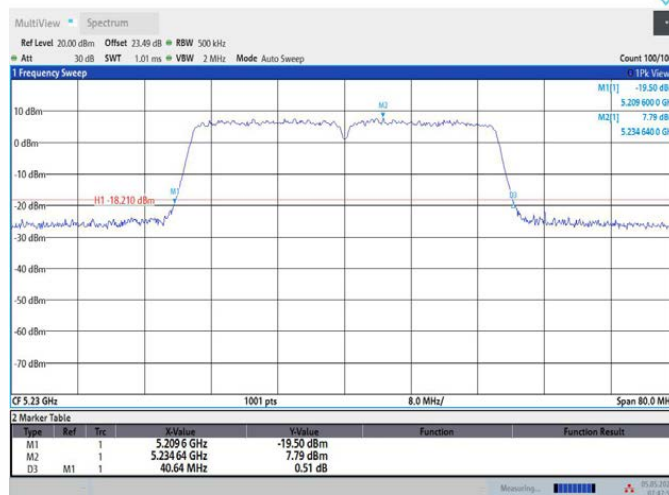

07:47:54 05.05.2023

11AC40MIMO_Ant2_5230



07:49:28 05.05.2023

11AC40MIMO_Ant1_5270

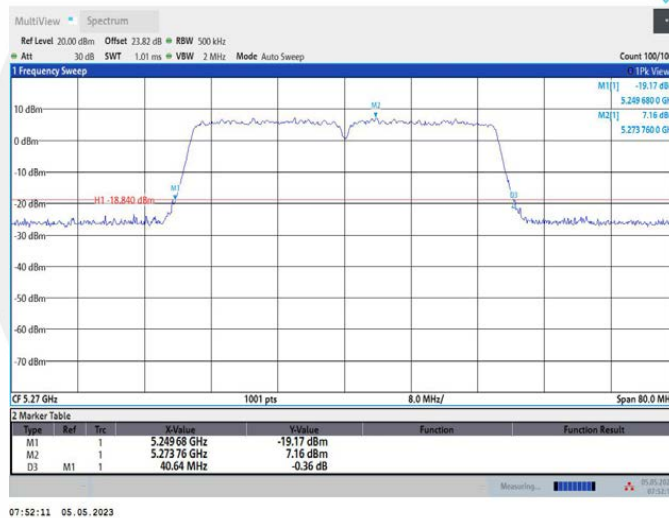

07:52:11 05.05.2023

11AC40MIMO_Ant2_5270

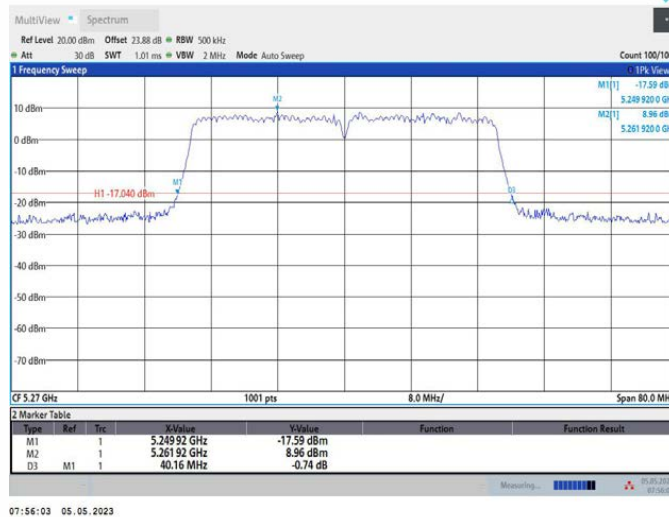

07:56:03 05.05.2023

11AC40MIMO_Ant1_5310

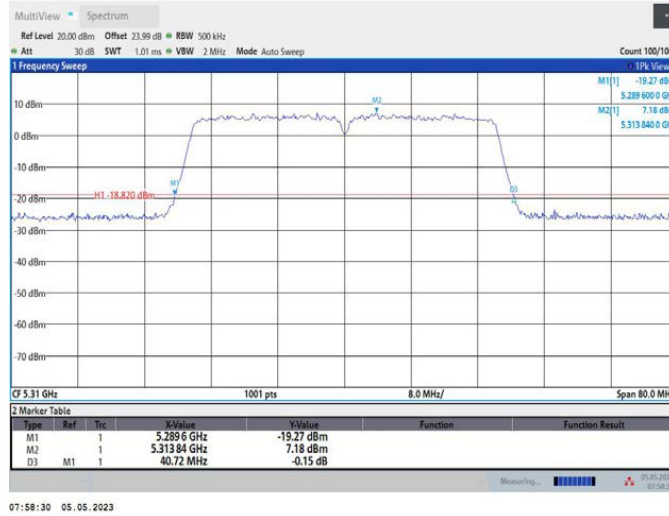

11AC40MIMO_Ant2_5310

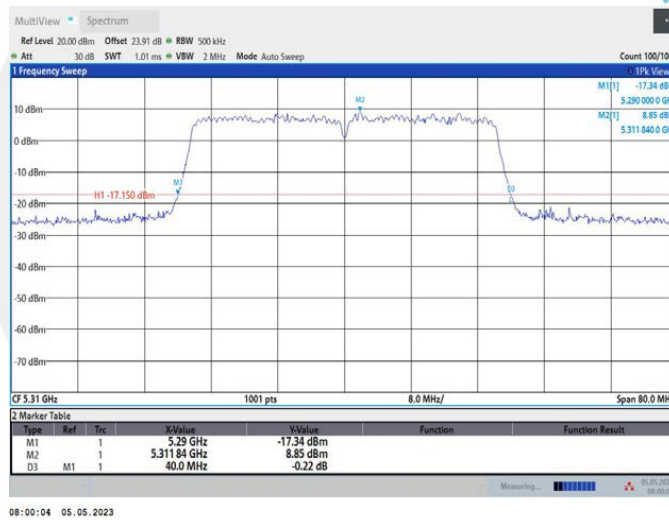

11AC40MIMO_Ant1_5510

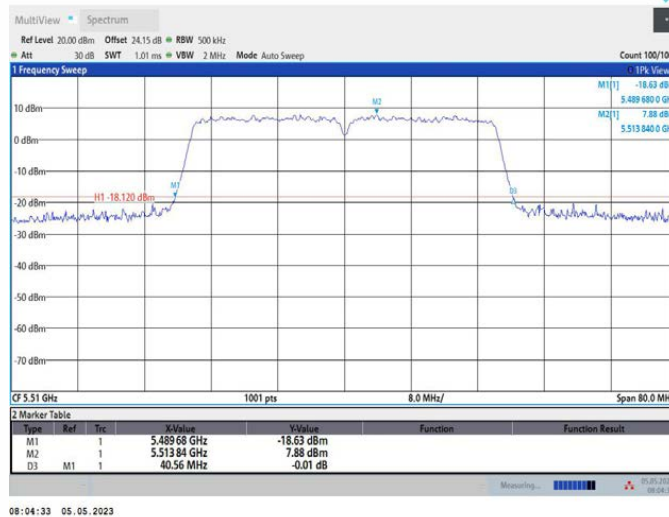

11AC40MIMO_Ant2_5510

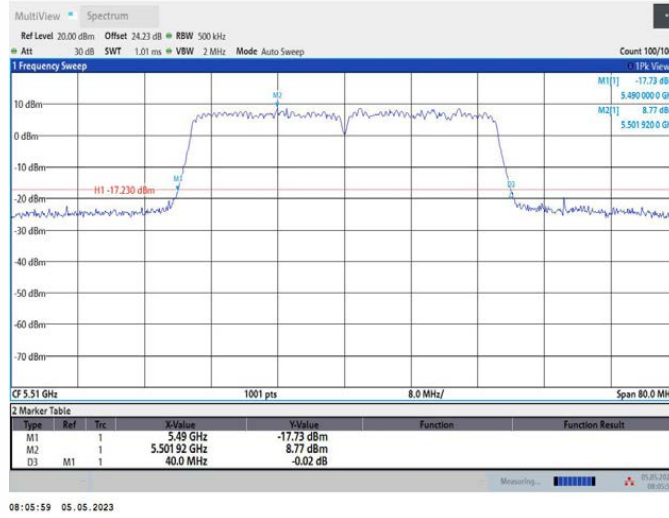

11AC40MIMO_Ant1_5550

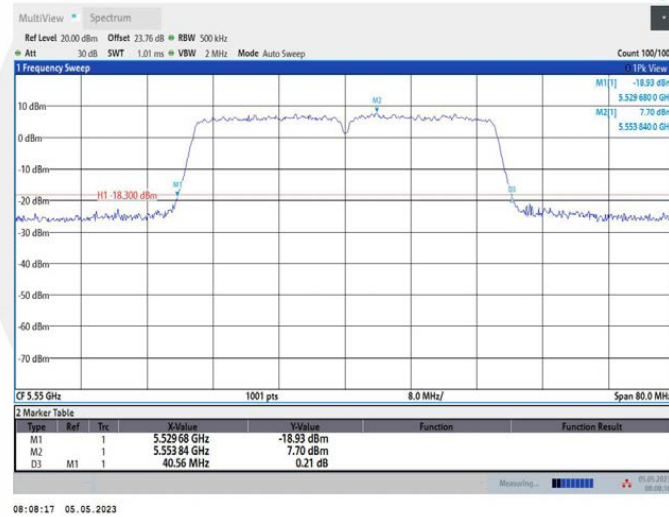

11AC40MIMO_Ant2_5550



11AC40MIMO_Ant1_5670

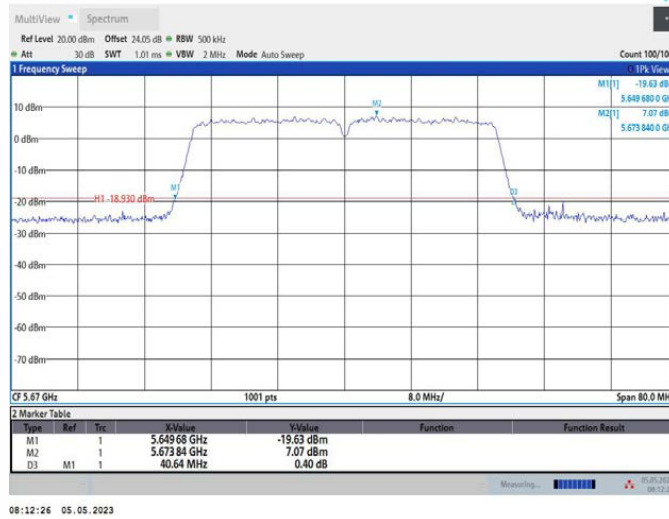

08:12:26 05.05.2023

11AC40MIMO_Ant2_5670

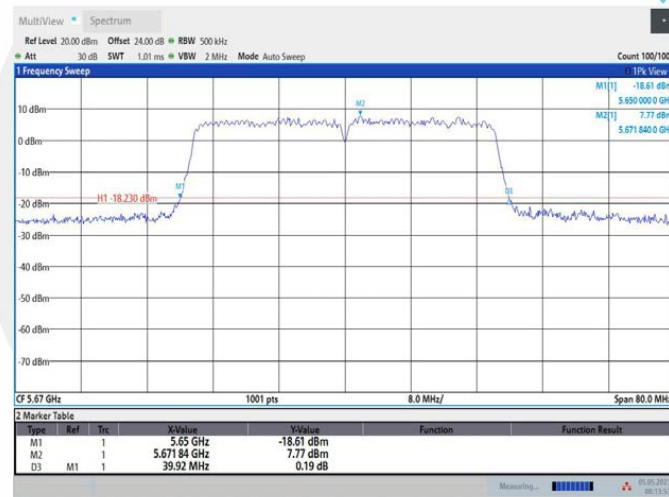

08:13:57 05.05.2023

11AC40MIMO_Ant1_5755

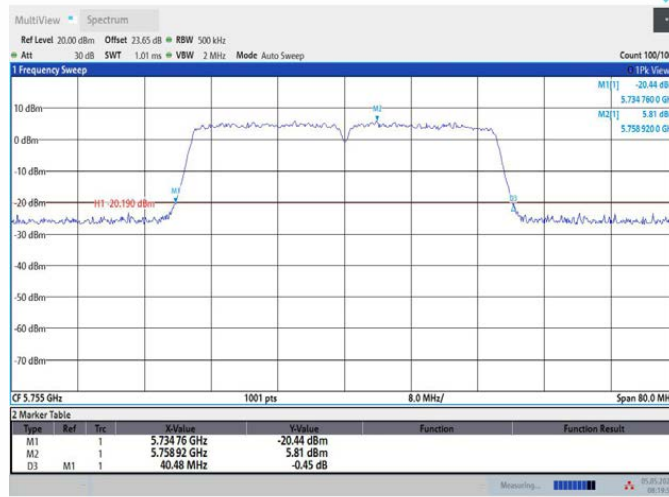

08:19:59 05.05.2023

11AC40MIMO_Ant2_5755

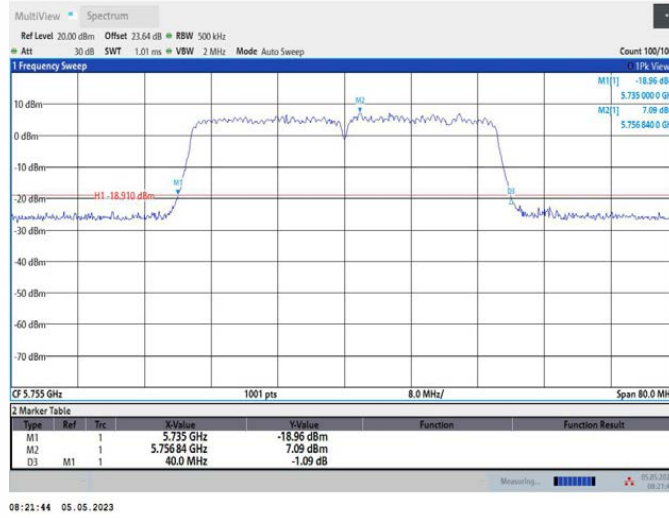

11AC40MIMO_Ant1_5795

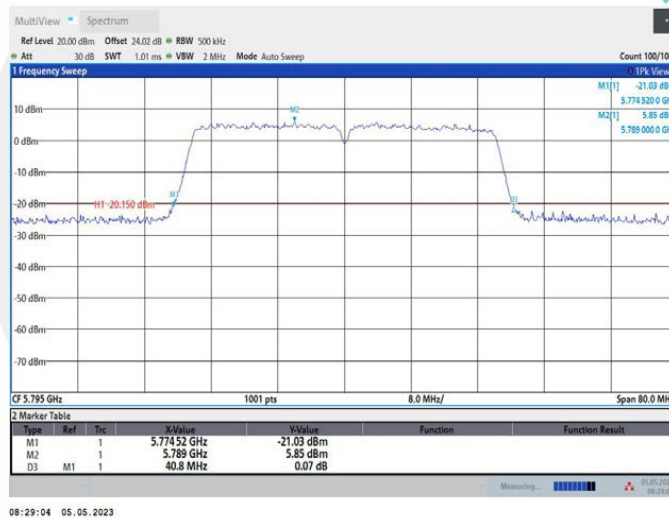

11AC40MIMO_Ant2_5795

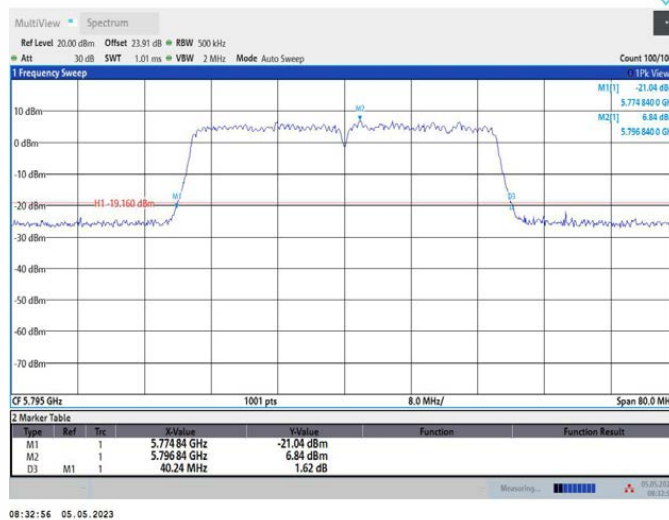

11AC80MIMO_Ant1_5210

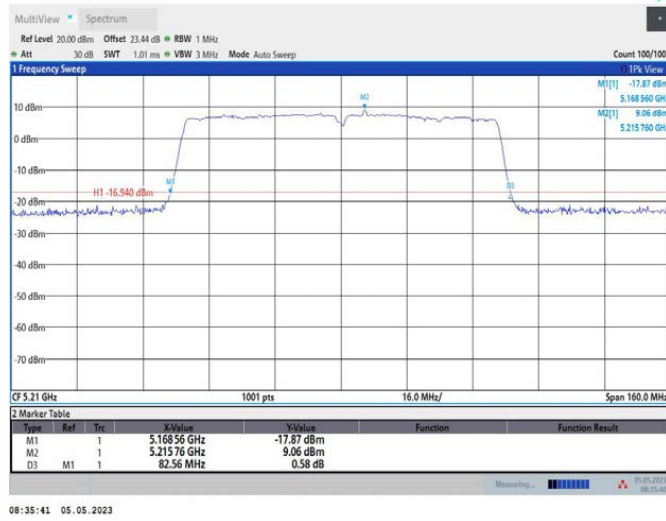

08:35:41 05.05.2023

11AC80MIMO_Ant2_5210

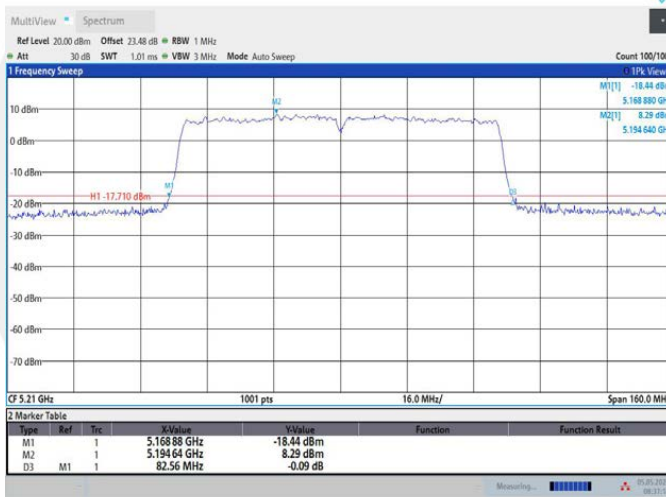

08:37:15 05.05.2023

11AC80MIMO_Ant1_5290

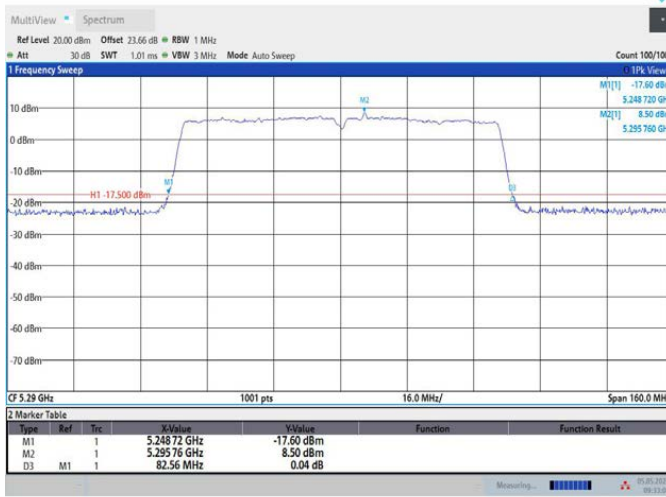

09:33:07 05.05.2023

11AC80MIMO_Ant2_5290



11AC80MIMO_Ant1_5530

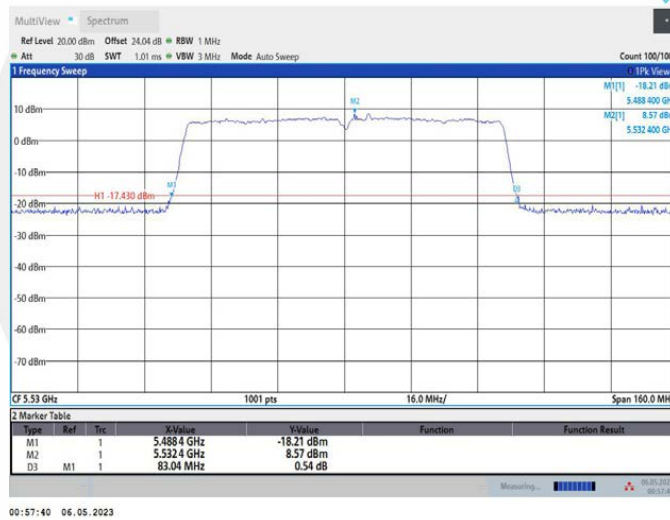

11AC80MIMO_Ant2_5530

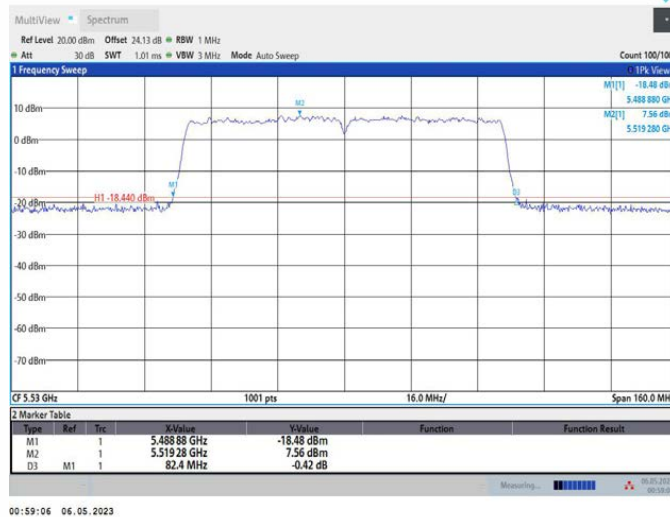

11AC80MIMO_Ant1_5610

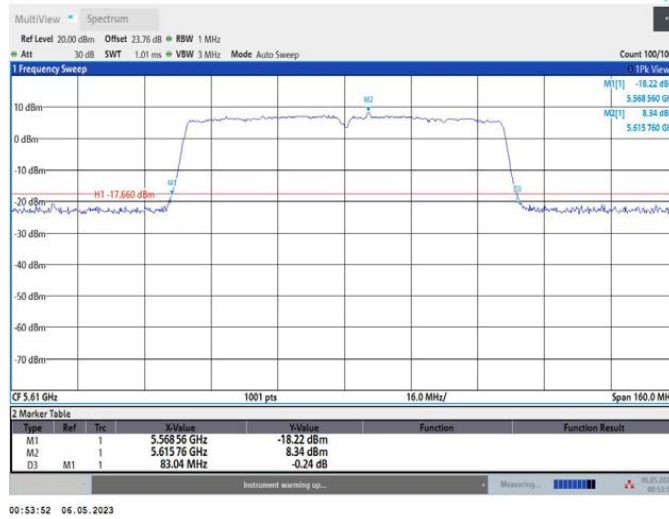

11AC80MIMO_Ant2_5610

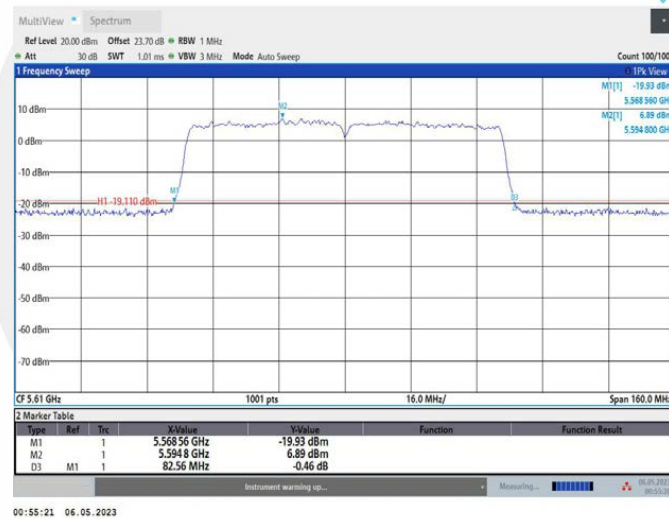

11AC80MIMO_Ant1_5775

