



FCC AND ISED CERTIFICATION TEST REPORT

Applicant	:	Mercku Inc.
Address of Applicant	:	3600 Steeles Avenue East, Suite C108B, Markham, Ontario, L3R 9Z7, Canada
Manufacturer	:	Mercku Technology (China), Inc.
Address of Manufacturer	:	Block B1, Southern Software Park No.1 Software Road, Tangjia Zhuhai, Guangdong, China
Equipment under Test	:	Mercku M6s Nano Mesh Wi-Fi Router
Model No.	:	MBAA0
FCC ID	:	2APR4-M6SN
IC	:	23877-M6SN
Test Standard(s)	:	FCC Rules and Regulations Part 15 Subpart E, RSS-247 Issue 3 August 2023, ANSI C63.10:2013, 789033 D02 General U-NII Test Procedures New Rules v02r01, 662911 D01 Multiple Transmitter Output v02r01, RSS-Gen Issue 5 April 2018
Report No.	:	DDT-RE23111605-2E06
Issue Date	:	2024/03/05
Issue By	:	Guangdong Dongdian Testing Service Co., Ltd. Unit 2, Building 1, No. 17, Zongbu 2nd Road, Songshan Lake Park, Dongguan, Guangdong, China, 523808

REPORT

Table of Contents

1.	Summary of Test Results	7
2.	General Test Information	8
2.1.	Description of EUT	8
2.2.	Accessories of EUT	10
2.3.	Block diagram of EUT configuration for test	10
2.4.	Decision of final test mode	10
2.5.	Deviations of test standard	13
2.6.	Test environment conditions	13
2.7.	Test laboratory	13
2.8.	Measurement uncertainty	14
3.	Equipment Used During Conductive Test	15
4.	26dB Bandwidth	16
4.1.	Block diagram of test setup	16
4.2.	Limits	16
4.3.	Test procedure	16
4.4.	Test result	17
4.5.	Test graphs	21
5.	6dB Bandwidth	87
5.1.	Block diagram of test setup	87
5.2.	Limits	87
5.3.	Test procedure	87
5.4.	Test result B4	88
5.5.	Test graphs B4	89
6.	99% Bandwidth	103
6.1.	Block diagram of test setup	103
6.2.	Limits	103
6.3.	Test procedure	103
6.4.	Test result	104
6.5.	Test graphs	108
7.	Duty Cycle	174
7.1.	Block diagram of test setup	174
7.2.	Limit	174
7.3.	Test procedure	174
7.4.	Test result	175
7.5.	Test graphs	179
8.	Maximum Output Power	245

8.1.	Block diagram of test setup	245
8.2.	Limits	245
8.3.	Test procedure	245
8.4.	Test result channel power	245
9.	Power Spectral Density	253
9.1.	Block diagram of test setup	253
9.2.	Limits	253
9.3.	Test procedure	253
9.4.	Test result	255
9.5.	Test graphs	261
10.	Frequency Stability Measurement	334
10.1.	Limit of Frequency Stability	334
10.2.	Measuring Instruments	334
10.3.	Test procedures	334
10.4.	Test setup	334
10.5.	Test result	335
11.	Radiated Emission	372
11.1.	Test equipment	372
11.2.	Block diagram of test setup	373
11.3.	Limits	373
11.4.	Assistant equipment used for test	375
11.5.	Test procedure	375
11.6.	Test result	377
11.7.	Test data	378
12.	Band Edge Compliance	400
12.1.	Test equipment	400
12.2.	Block diagram of test setup	401
12.3.	Limits	401
12.4.	Assistant equipment used for test	401
12.5.	Test procedure	401
12.6.	Test result	402
12.7.	Test data	403
13.	Power Line Conducted Emissions	557
13.1.	Test equipment	557
13.2.	Block diagram of test setup	557
13.3.	Limits	557
13.4.	Assistant equipment used for test	557
13.5.	Test procedure	557

13.6.	Test result	558
13.7.	Test data	559
14.	Test Setup Photograph	561
15.	Photos of the EUT	563

Test Report Declare

Applicant	:	Mercku Inc.
Address of Applicant	:	3600 Steeles Avenue East, Suite C108B, Markham, Ontario, L3R 9Z7, Canada
Equipment under Test	:	Mercku M6s Nano Mesh Wi-Fi Router
Model No.	:	MBAA0
Manufacturer	:	Mercku Technology (China), Inc.
Address of Manufacturer	:	Block B1,Southern Software Park No.1 Software Road, Tangjia Zhuhai, Guangdong, China

Test Standard Used:

FCC Rules and Regulations Part 15 Subpart E,
 RSS-247 Issue 3 August 2023,
 ANSI C63.10:2013,
 789033 D02 General U-NII Test Procedures New Rules v02r01,
 662911 D01 Multiple Transmitter Output v02r01,
 RSS-Gen Issue 5 April 2018

We Declare:

The equipment described above is tested by Guangdong Dongdian Testing Service Co., Ltd. and in the configuration tested the equipment complied with the standards specified above. The test results are contained in this test report and Guangdong Dongdian Testing Service Co., Ltd. is assumed of full responsibility for the accuracy and completeness of these tests.

Report No.:	DDT-RE23111605-2E06		
Date of Receipt:	2023/11/20	Date of Test:	2023/11/20~2024/03/05

Prepared By:

Tiger Mo

Tiger Mo/Engineer

Approved By:



Damon Hu/EMC Manager

Note: This report applies to above tested sample only. This report shall not be reproduced in parts without written approval of Guangdong Dongdian Testing Service Co., Ltd.

Revision History

Rev.	Revisions	Issue Date	Revised By
---	Initial issue	2024/03/05	

1. Summary of Test Results

No.	Test Parameter	Clause No.	Condition	Result
1	6/26db Bandwidth and 99% Bandwidth	FCC 15.407 (e), RSS-247 Clause 6.2	/	Pass
2	Output Power	FCC 15.407 (a); RSS-247 Clause 6.2	/	Pass
3	Power Spectral Density	FCC 15.407 (a); RSS-247 Clause 6.2	/	Pass
4	Frequency Stability Measurement	FCC 15.407 (g); RSS-247 Clause 6.2; RSS-GEN Clause 8.9	/	Pass
5	Dynamic Frequency Selection	FCC 15.407 (h); RSS-247 Clause 6.8	/	Pass
6	Radiated Emission	FCC 15.407 (b); FCC 15.209; FCC 15.205; RSS-247 Clause 6.2; RSS-GEN Clause 8.9	/	Pass
7	Band Edge Compliance	FCC 15.407 (b); FCC 15.209; FCC 15.205; RSS-247 Clause 6.2; RSS-GEN Clause 8.9	/	Pass
8	Power Line Conducted Emissions	FCC Part 15: 15.207(a), RSS-Gen Issue 5 clause 8.8	/	Pass
9	Antenna Requirement	FCC Part 15: 15.203, RSS-Gen Issue 5 clause 6.8	/	Pass

Note: N/A is an abbreviation for Not Applicable, and means this item is not applicable for this device or no need to test according to standard.

2. General Test Information

2.1. Description of EUT

EUT Name	: Mercku M6s Nano Mesh Wi-Fi Router
Model Number	: MBAA0
EUT Function Description	: Please reference user manual of this device
Power Supply	: AC 100~240V, 50-60Hz, 0.55A

Note: This EUT support 2.4 GHz WLAN, 5 GHz WLAN, this report only for 5 GHz WLAN.

Radio Technology	: IEEE 802.11a/n/ac/ax
Operation frequency	: IEEE 802.11a: 5180MHz-5240MHz, 5260MHz-5320MHz, 5500MHz-5720MHz, 5745MHz-5825MHz IEEE 802.11n HT20: 5180MHz-5240MHz, 5260MHz-5320MHz, 5500MHz-5720MHz, 5745MHz-5825MHz IEEE 802.11n HT40: 5190MHz-5230MHz, 5270MHz-5310MHz, 5510MHz-5710MHz, 5755MHz-5795MHz IEEE 802.11ac VHT20: 5180MHz-5240MHz, 5260MHz-5320MHz, 5500MHz-5720MHz, 5745MHz-5825MHz IEEE 802.11ac VHT40: 5190MHz-5230MHz, 5270MHz-5310MHz, 5510MHz-5710MHz, 5755MHz-5795MHz IEEE 802.11ac VHT80: 5210MHz, 5290MHz, 5530MHz, 5610MHz, 5690MHz, 5775MHz IEEE 802.11ac VHT160: 5250MHz, 5570MHz IEEE 802.11ax HE20: 5180MHz-5240MHz, 5260MHz-5320MHz, 5500MHz-5720MHz, 5745MHz-5825MHz IEEE 802.11ax HE40: 5190MHz-5230MHz, 5270MHz-5310MHz, 5510MHz-5710MHz, 5755MHz-5795MHz IEEE 802.11ax HE80: 5210MHz, 5290MHz, 5530MHz, 5610MHz, 5690MHz, 5775MHz IEEE 802.11ax VHT160: 5250MHz, 5570MHz
Modulation	: IEEE 802.11a: OFDM (64QAM, 16QAM, QPSK, BPSK) IEEE 802.11n HT20, HT40: OFDM (64QAM, 16QAM, QPSK, BPSK) IEEE 802.11ac: OFDM (256QAM, 64QAM, 16QAM, QPSK, BPSK) IEEE 802.11ax: OFDM (1024QAM, 256QAM, 64QAM, 16QAM, QPSK, BPSK)

Antenna information:

Antenna Type	PCB						
	/	Ant1 Gain	Ant2 Gain	Directional Gain	Ant1 Gain	Ant2 Gain	Directional Gain
Max Antenna Gain (dBi)		5150MHz-5350MHz			5470MHz-5850MHz		
	IEEE 802.11a	6.43	6.43	6.43	6.6	6.6	6.6
	IEEE 802.11n HT20	6.43	6.43	6.43	6.6	6.6	6.6
	IEEE 802.11n HT40	6.43	6.43	6.43	6.6	6.6	6.6
	IEEE 802.11ac VHT20	6.43	6.43	6.43	6.6	6.6	6.6

IEEE 802.11ac VHT40	6.43	6.43	6.43	6.6	6.6	6.6
IEEE 802.11ac VHT80	6.43	6.43	6.43	6.6	6.6	6.6
IEEE 802.11ac HE160	6.43	6.43	6.43	6.6	6.6	6.6
IEEE 802.11ax HE20	6.43	6.43	6.43	6.6	6.6	6.6
IEEE 802.11ax HE40	6.43	6.43	6.43	6.6	6.6	6.6
IEEE 802.11ax HE80	6.43	6.43	6.43	6.6	6.6	6.6
IEEE 802.11ax HE160	6.43	6.43	6.43	6.6	6.6	6.6

Channel information

IEEE 802.11a IEEE 802.11n (HT20) IEEE 802.11ac (VHT20) IEEE 802.11ax (HE20)	IEEE 802.11n (HT40) IEEE 802.11ac (VHT40) IEEE 802.11ax (HE40)	IEEE 802.11ac (VHT80) IEEE 802.11ax (HE80)	IEEE 802.11ac (VHT160) IEEE 802.11ax (HE160)				
UNII-1							
CH	Frequency (MHz)	CH	Frequency (MHz)	CH	Frequency (MHz)	CH	Frequency (MHz)
36	5180	38	5190	42	5210	50	5250
40	5200	46	5230	/	/	/	/
44	5220	/	/	/	/	/	/
48	5240	/	/	/	/	/	/
UNII-2A							
52	5260	54	5270	58	5290	50	5250
56	5280	62	5310	/	/	/	/
60	5300	/	/	/	/	/	/
64	5320	/	/	/	/	/	/
UNII-2C							
100	5500	102	5510	106	5530	114	5570
104	5520	110	5550	122	5610	/	/
108	5540	118	5590	138	5690	/	/
112	5560	126	5630	/	/	/	/
116	5580	134	5670	/	/	/	/
120	5600	142	5710	/	/	/	/
124	5620	/	/	/	/	/	/
128	5640	/	/	/	/	/	/

132	5660	/	/	/	/	/	/
136	5680	/	/	/	/	/	/
140	5700	/	/	/	/	/	/
144	5720	/	/	/	/	/	/
UNII-3							
149	5745	151	5755	155	5775	/	/
153	5765	159	5795	/	/	/	/
157	5785	/	/	/	/	/	/
161	5805	/	/	/	/	/	/
165	5825	/	/	/	/	/	/
Note: Band 5600-5650MHz will be disabled when shipped to Canada							

Note : “☑” means to be chosen or applicable; “☐” means don’t to be chosen or not applicable; This note applies to entire report.

Note: The above EUT information is declared by manufacturer and for more detailed features description please refer to the manufacturer's specifications or User's Manual. The above Antenna information is declared by manufacturer and for more detailed features description please refer to the manufacturer's specifications, the laboratory shall not be held responsible.

2.2. Accessories of EUT

Accessories	Manufacturer	Model number	Description
/	/	/	/

2.3. Block diagram of EUT configuration for test

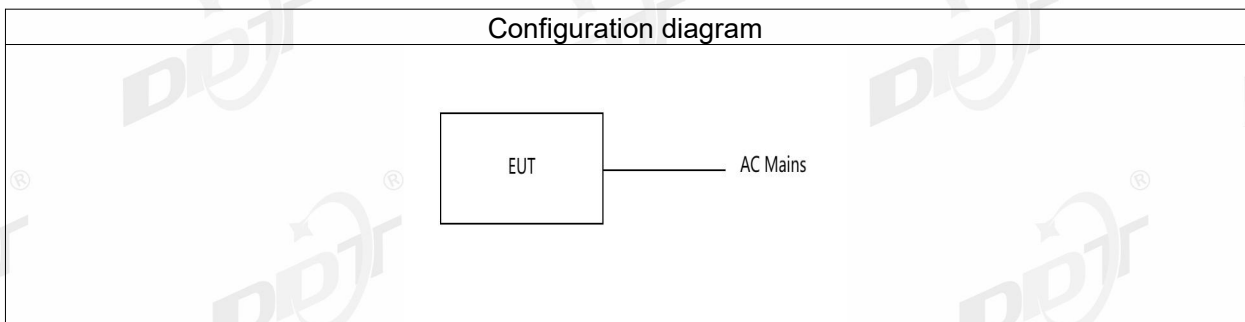

2.4. Decision of final test mode

According pre-test, the worst test modes were reported as below:

Test software: QATool_Dbg.exe

The test software was used to control EUT work in Continuous Tx mode, and select test channel, wireless mode as below table.

The pathloss of external cable: 2 dB (According to the manufacturer's claims)

Tested mode, channel, and data rate information

Mode	Setting Tx Power		Data rate (Mbps) (see Note)	Channel	Frequency (MHz)
	ANT1	ANT2			
IEEE 802.11a	10	10	6	Low: CH36	5180
	10	10	6	Middle: CH40	5200
	10	10	6	High: CH48	5240
	17	17	6	Low: CH52	5260
	17	17	6	Middle: CH56	5280
	17	17	6	High: CH64	5320
	17	17	6	Low: CH100	5500
	17	17	6	Middle: CH116	5580
	17	17	6	High: CH140	5700
	17	17	6	Straddle:CH144	5720
	18	18	6	Low: CH149	5745
	18	18	6	Middle: CH157	5785
	18	18	6	High: CH165	5825
IEEE 802.11n HT20	9	9	MCS 8	Low: CH36	5180
	9	9	MCS 8	Middle: CH40	5200
	9	9	MCS 8	High: CH48	5240
	15	15	MCS 8	Low: CH52	5260
	15	15	MCS 8	Middle: CH56	5280
	15	15	MCS 8	High: CH64	5320
	15	15	MCS 8	Low: CH100	5500
	15	15	MCS 8	Middle: CH116	5580
	15	15	MCS 8	High: CH140	5700
	15	15	MCS 8	Straddle:CH144	5720
	17	17	MCS 8	Low: CH149	5745
	17	17	MCS 8	Middle: CH157	5785
	17	17	MCS 8	High: CH165	5825
IEEE 802.11n HT40	10	10	MCS 8	Low: CH38	5190
	10	10	MCS 8	Middle: CH46	5230
	17	17	MCS 8	High: CH54	5270
	17	17	MCS 8	Low: CH62	5310
	17	17	MCS 8	Middle: CH102	5510
	17	17	MCS 8	High: CH110	5550
	17	17	MCS 8	Low: CH134	5670
	17	17	MCS 8	Low: CH142	5710
	19	19	MCS 8	Middle: CH151	5755
	19	19	MCS 8	High: CH159	5795
IEEE 802.11ac	9	9	MCS 8	Low: CH36	5180
	9	9	MCS 8	Middle: CH40	5200

VHT20	9	9	MCS 8	High: CH48	5240
	16	16	MCS 8	Low: CH52	5260
	16	16	MCS 8	Middle: CH56	5280
	16	16	MCS 8	High: CH64	5320
	16	16	MCS 8	Low: CH100	5500
	16	16	MCS 8	Middle: CH116	5580
	16	16	MCS 8	High: CH140	5700
	16	16	MCS 8	Straddle:CH144	5720
	18	18	MCS 8	Low: CH149	5745
	18	18	MCS 8	Middle: CH157	5785
IEEE 802.11 ac VHT40	10	10	MCS 8	Low: CH38	5190
	10	10	MCS 8	Middle: CH46	5230
	17	17	MCS 8	High: CH54	5270
	17	17	MCS 8	Low: CH62	5310
	17	17	MCS 8	Middle: CH102	5510
	17	17	MCS 8	High: CH110	5550
	17	17	MCS 8	Low: CH134	5670
	17	17	MCS 8	Straddle: CH142	5710
	18	18	MCS 8	Middle: CH151	5755
	18	18	MCS 8	High: CH159	5795
IEEE 802.11ac VHT80	10	10	MCS 0	CH42	5210
	14	14	MCS 0	CH58	5290
	14	14	MCS 0	CH106	5530
	14	14	MCS 0	CH122	5610
	14	14	MCS 0	CH138	5690
	18	18	MCS 0	CH155	5775
IEEE 802.11ac VHT160	10	10	MCS 0	CH50	5250
	10	10	MCS 0	CH114	5570
IEEE 802.11ax HE20	9	9	MCS 0	Low: CH36	5180
	9	9	MCS 0	Middle: CH40	5200
	9	9	MCS 0	High: CH48	5240
	16	16	MCS 0	Low: CH52	5260
	16	16	MCS 0	Middle: CH56	5280
	16	16	MCS 0	High: CH64	5320
	16	16	MCS 0	Low: CH100	5500
	16	16	MCS 0	Middle: CH116	5580
	16	16	MCS 0	High: CH140	5700
	16	16	MCS 0	Straddle:CH144	5720
	18	18	MCS 0	Low: CH149	5745

	18	18	MCS 0	Middle: CH157	5785
	18	18	MCS 0	High: CH165	5825
IEEE 802.11ax HE40	10	10	MCS 0	Low: CH38	5190
	10	10	MCS 0	Middle: CH46	5230
	10	10	MCS 0	High: CH54	5270
	17	17	MCS 0	Low: CH62	5310
	17	17	MCS 0	Middle: CH102	5510
	17	17	MCS 0	High: CH110	5550
	17	17	MCS 0	Low: CH134	5670
	17	17	MCS 0	Straddle: CH142	5710
	18	18	MCS 0	Middle: CH151	5755
	18	18	MCS 0	High: CH159	5795
	IEEE 802.11ax HE80	10	10	MCS 0	CH42
14		14	MCS 0	CH58	5290
14		14	MCS 0	CH106	5530
14		14	MCS 0	CH122	5610
14		14	MCS 0	CH138	5690
18		18	MCS 0	CH155	5775
IEEE 802.11ax HE160	10	10	MCS 0	CH50	5250
	10	10	MCS 0	CH114	5570

Note: According exploratory test, EUT will have maximum output power in those data rate, so those data rate were used for all test.

2.5. Deviations of test standard

No deviation.

2.6. Test environment conditions

During the measurement the environmental conditions were within the listed ranges:

Temperature range:	+15 °C to +35 °C
Humidity range:	20% to 75%
Pressure range:	86 kPa to 106 kPa

Note: The specific temperature and humidity information of each test item refers to the temperature and humidity record in the corresponding test data.

2.7. Test laboratory

Guangdong Dongdian Testing Service Co., Ltd.

Add.: Unit 2, Building 1, No. 17, Zongbu 2nd Road, Songshan Lake Park, Dongguan, Guangdong, China, 523808.

Tel.: +86-0769-38826678, <http://www.dgddt.com>, Email: ddt@dgddt.com.

CNAS Accreditation No. L6451; A2LA Accreditation Number: 3870.01

FCC Designation Number: CN1182, Test Firm Registration Number: 540522

Innovation, Science and Economic Development Canada Site Registration Number: 10288A

Conformity Assessment Body identifier: CN0048

VCCI facility registration number: C-20087, T-20088, R-20123, R-20155, G-20118

2.8. Measurement uncertainty

Test Item	Uncertainty
Bandwidth	1.1%
Peak Output Power (Conducted) (Spectrum analyzer)	0.86 dB (10 MHz ≤ f < 3.6 GHz);
	1.38 dB (3.6 GHz ≤ f < 8 GHz)
Peak Output Power (Conducted) (Power Sensor)	0.74 dB
Power Spectral Density	0.74 dB (10 MHz ≤ f < 3.6 GHz);
	1.38 dB (3.6 GHz ≤ f < 8 GHz)
Frequencies Stability [®]	6.7 x 10 ⁻⁸ (Antenna couple method)
	5.5 x 10 ⁻⁸ (Conducted method)
Conducted spurious emissions	0.86 dB (10 MHz ≤ f < 3.6 GHz);
	1.40 dB (3.6 GHz ≤ f < 8 GHz)
	1.66 dB (8 GHz ≤ f < 26.5 GHz)
Uncertainty for radio frequency (RBW < 20 kHz)	3×10 ⁻⁸
Temperature	0.4 °C
Humidity	2 %
Uncertainty for Radiation Emission test (9 kHz – 30 MHz)	3.44 dB
Uncertainty for Radiation Emission test (30 MHz - 1 GHz)	4.70 dB (Antenna Polarize: V)
	4.84 dB (Antenna Polarize: H)
Uncertainty for Radiation Emission test (1 GHz - 40 GHz)	4.10 dB (1 - 6 GHz)
	4.40 dB (6 GHz - 18 GHz)
	3.54 dB (18 GHz - 26 GHz)
	4.30 dB (26 GHz - 40 GHz)
Uncertainty for Power line conduction emission test	3.34dB (150KHz-30MHz)
	3.72dB (9KHz-150KHz)

Note: This uncertainty represents an expanded uncertainty expressed at approximately the 95% confidence level using a coverage factor of k=2.

3. Equipment Used During Conductive Test

Equipment	Manufacturer	Model No.	Serial Number	Due Date
<input checked="" type="checkbox"/> RF Connected Test (RF Measurement System 1#)				
SIGNAL ANALYZER	R&S	FSQ26	101272	2024/04/26
Wideband Radio Communication Tester	R&S	CMW500	120259	2024/07/14
MXG Vector Signal Generator	KEYSIGHT	N5182B	MY59100192	2024/04/26
MXG Vector Signal Generator	Agilent	N5182A	MY19060405	2024/04/26
RF Control Unit	Tonsend	JS0806-2	158060010	2024/04/26
TEMP&HUMI Programmable Chamber	ZHIXIANG	ZXGDJS-150L	ZX170110-A	2024/05/14
Test Software	Tonscend	JS1120-3	Ver.3.2.22	N/A

4. 26dB Bandwidth

4.1. Block diagram of test setup

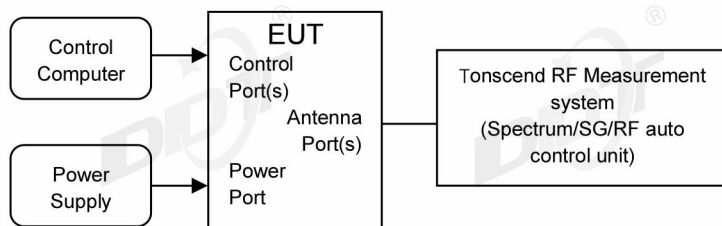

4.2. Limits

FCC Part15, Subpart E/ RSS-247		
Test Item	Limit	Frequency Range (MHz)
26 dB Bandwidth	---	5150 - 5250
	---	5250 - 5350
	---	For FCC: 5470 - 5725 For IC: 5470 - 5600 5650 - 5725

4.3. Test procedure

Connect EUT's antenna output to spectrum analyzer by RF cable.

Center Frequency	The center frequency of the channel under test
Detector	Peak
RBW	approximately 1% of the emission bandwidth.
VBW	> RBW
Trace	Max hold
Sweep	Auto couple

Allow the trace to stabilize, measure the maximum width of the emission that is constrained by the frequencies associated with the two outermost amplitude points (upper and lower frequencies) that are attenuated by 26 dB relative to the maximum level measured in the fundamental emission.

4.4. Test result

Test Engineer:	Zora Zhang	Test Site:	RF Measurement System 1#
Ambient Condition:	23.6℃,64%RH	Test Date:	2024.01.29-2024.02.21
Test Power Supply:	AC230V/50Hz	EUT:	Mercku M6s Nano Mesh Wi-Fi Router
Sample Number:	S23111605-01	Model No.:	MBAA0

Test Mode	Antenna	Frequency[MHz]	26db EBW [MHz]	FL[MHz]	FH[MHz]	Limit[MHz]	Verdict
11A	Ant1	5180	28.32	5166.24	5194.56	---	---
	Ant2	5180	28.92	5166.68	5195.60	---	---
	Ant1	5200	30.04	5185.20	5215.24	---	---
	Ant2	5200	29.84	5184.56	5214.40	---	---
	Ant1	5240	20.24	5229.88	5250.12	---	---
	Ant2	5240	20.28	5229.80	5250.08	---	---
	Ant1	5260	21.36	5249.40	5270.76	---	---
	Ant2	5260	21.36	5249.24	5270.60	---	---
	Ant1	5280	21.40	5269.40	5290.80	---	---
	Ant2	5280	21.20	5269.52	5290.72	---	---
	Ant1	5320	28.88	5304.68	5333.56	---	---
	Ant2	5320	29.28	5303.92	5333.20	---	---
	Ant1	5500	28.08	5486.44	5514.52	---	---
	Ant2	5500	27.36	5486.60	5513.96	---	---
	Ant1	5580	21.60	5568.96	5590.56	---	---
	Ant2	5580	21.72	5569.00	5590.72	---	---
	Ant1	5700	26.92	5684.76	5711.68	---	---
	Ant2	5700	28.20	5683.96	5712.16	---	---
	Ant1	5720	21.12	5709.40	5730.52	---	---
	Ant2	5720	21.36	5709.32	5730.68	---	---
	Ant1	5720_UNII-2C	15.6	5709.40	5725	---	---
	Ant2	5720_UNII-2C	15.68	5709.32	5725	---	---
	Ant1	5720_UNII-3	5.52	5725	5730.52	---	---
	Ant2	5720_UNII-3	5.68	5725	5730.68	---	---
	Ant1	5745	26.56	5733.88	5760.44	---	---
	Ant2	5745	28.28	5733.80	5762.08	---	---
	Ant1	5785	27.56	5771.60	5799.16	---	---
	Ant2	5785	25.52	5772.32	5797.84	---	---
	Ant1	5825	28.16	5809.72	5837.88	---	---
	Ant2	5825	27.96	5809.32	5837.28	---	---
11N20MIMO	Ant1	5180	32.20	5165.60	5197.80	---	---
	Ant2	5180	30.96	5165.60	5196.56	---	---
	Ant1	5200	34.16	5182.40	5216.56	---	---
	Ant2	5200	32.96	5183.96	5216.92	---	---
	Ant1	5240	20.68	5229.68	5250.36	---	---
	Ant2	5240	20.52	5229.72	5250.24	---	---
	Ant1	5260	22.32	5248.76	5271.08	---	---
	Ant2	5260	21.60	5249.20	5270.80	---	---
	Ant1	5280	22.00	5269.12	5291.12	---	---
	Ant2	5280	21.88	5269.20	5291.08	---	---
	Ant1	5320	31.68	5302.12	5333.80	---	---
	Ant2	5320	30.72	5303.72	5334.44	---	---
	Ant1	5500	32.00	5485.72	5517.72	---	---
	Ant2	5500	31.44	5486.20	5517.64	---	---
	Ant1	5580	22.20	5568.88	5591.08	---	---
	Ant2	5580	21.76	5569.12	5590.88	---	---
	Ant1	5700	28.76	5683.60	5712.36	---	---
	Ant2	5700	28.80	5683.72	5712.52	---	---
	Ant1	5720	22.08	5708.92	5731.00	---	---
	Ant2	5720	21.64	5709.20	5730.84	---	---
	Ant1	5720_UNII-2C	16.08	5708.92	5725	---	---
	Ant2	5720_UNII-2C	15.8	5709.20	5725	---	---
	Ant1	5720_UNII-3	6	5725	5731.00	---	---
	Ant2	5720_UNII-3	5.84	5725	5730.84	---	---
	Ant1	5745	27.08	5733.32	5760.40	---	---

	Ant2	5745	27.32	5733.92	5761.24	---	---	
	Ant1	5785	22.04	5774.08	5796.12	---	---	
	Ant2	5785	21.72	5774.08	5795.80	---	---	
	Ant1	5825	27.40	5809.88	5837.28	---	---	
	Ant2	5825	28.72	5808.76	5837.48	---	---	
11N40MIMO	Ant1	5190	59.28	5165.12	5224.40	---	---	
	Ant2	5190	54.16	5165.76	5219.92	---	---	
	Ant1	5230	41.52	5209.20	5250.72	---	---	
	Ant2	5230	40.64	5209.68	5250.32	---	---	
	Ant1	5270	41.36	5249.36	5290.72	---	---	
	Ant2	5270	40.64	5249.68	5290.32	---	---	
	Ant1	5310	52.48	5280.72	5333.20	---	---	
	Ant2	5310	48.72	5283.92	5332.64	---	---	
	Ant1	5510	55.76	5485.12	5540.88	---	---	
	Ant2	5510	51.12	5487.04	5538.16	---	---	
	Ant1	5550	41.28	5529.44	5570.72	---	---	
	Ant2	5550	40.72	5529.60	5570.32	---	---	
	Ant1	5670	65.68	5636.16	5701.84	---	---	
	Ant2	5670	55.76	5641.84	5697.60	---	---	
	Ant1	5710	41.04	5689.44	5730.48	---	---	
	Ant2	5710	40.56	5689.76	5730.32	---	---	
	Ant1	5710_UNII-2C	35.56	5689.44	5725	---	---	
	Ant2	5710_UNII-2C	35.24	5689.76	5725	---	---	
	Ant1	5710_UNII-3	5.48	5725	5730.48	---	---	
	Ant2	5710_UNII-3	5.32	5725	5730.32	---	---	
	Ant1	5755	53.04	5734.12	5787.16	---	---	
	Ant2	5755	50.08	5734.52	5784.60	---	---	
	Ant1	5795	41.12	5774.36	5815.48	---	---	
	Ant2	5795	40.88	5774.60	5815.48	---	---	
	11AC20MIMO	Ant1	5180	22.12	5168.92	5191.04	---	---
Ant2		5180	22.40	5168.84	5191.24	---	---	
Ant1		5200	22.12	5188.80	5210.92	---	---	
Ant2		5200	22.48	5188.88	5211.36	---	---	
Ant1		5240	20.72	5229.68	5250.40	---	---	
Ant2		5240	20.68	5229.60	5250.28	---	---	
Ant1		5260	21.60	5249.12	5270.72	---	---	
Ant2		5260	22.28	5248.88	5271.16	---	---	
Ant1		5280	21.84	5268.88	5290.72	---	---	
Ant2		5280	22.00	5269.16	5291.16	---	---	
Ant1		5320	21.96	5308.96	5330.92	---	---	
Ant2		5320	22.24	5308.92	5331.16	---	---	
Ant1		5500	22.24	5488.76	5511.00	---	---	
Ant2		5500	22.32	5488.88	5511.20	---	---	
Ant1		5580	22.00	5568.88	5590.88	---	---	
Ant2		5580	21.80	5569.24	5591.04	---	---	
Ant1		5700	22.12	5688.96	5711.08	---	---	
Ant2		5700	21.96	5689.04	5711.00	---	---	
Ant1		5720	22.16	5708.92	5731.08	---	---	
Ant2		5720	21.84	5709.08	5730.92	---	---	
Ant1		5720_UNII-2C	16.08	5708.92	5725	---	---	
Ant2		5720_UNII-2C	15.92	5709.08	5725	---	---	
Ant1		5720_UNII-3	6.08	5725	5731.08	---	---	
Ant2		5720_UNII-3	5.92	5725	5730.92	---	---	
Ant1		5745	21.96	5734.16	5756.12	---	---	
Ant2		5745	21.88	5734.08	5755.96	---	---	
Ant1		5785	21.72	5774.16	5795.88	---	---	
Ant2		5785	22.52	5773.64	5796.16	---	---	
Ant1		5825	21.92	5813.96	5835.88	---	---	
Ant2		5825	21.96	5814.20	5836.16	---	---	
11AC40MIMO		Ant1	5190	62.72	5161.04	5223.76	---	---
		Ant2	5190	55.52	5165.76	5221.28	---	---
	Ant1	5230	41.60	5209.20	5250.80	---	---	
	Ant2	5230	40.64	5209.60	5250.24	---	---	
	Ant1	5270	41.20	5249.44	5290.64	---	---	

	Ant2	5270	40.56	5249.68	5290.24	---	---
	Ant1	5310	62.24	5274.24	5336.48	---	---
	Ant2	5310	55.76	5278.56	5334.32	---	---
	Ant1	5510	61.04	5482.96	5544.00	---	---
	Ant2	5510	55.12	5485.84	5540.96	---	---
	Ant1	5550	41.44	5529.36	5570.80	---	---
	Ant2	5550	40.48	5529.76	5570.24	---	---
	Ant1	5670	65.12	5636.32	5701.44	---	---
	Ant2	5670	62.72	5638.40	5701.12	---	---
	Ant1	5710	41.28	5689.28	5730.56	---	---
	Ant2	5710	41.04	5689.44	5730.48	---	---
	Ant1	5710_UNII-2C	35.72	5689.28	5725	---	---
	Ant2	5710_UNII-2C	35.56	5689.44	5725	---	---
	Ant1	5710_UNII-3	5.56	5725	5730.56	---	---
	Ant2	5710_UNII-3	5.48	5725	5730.48	---	---
	Ant1	5755	52.24	5734.12	5786.36	---	---
	Ant2	5755	51.92	5734.36	5786.28	---	---
	Ant1	5795	41.04	5774.52	5815.56	---	---
	Ant2	5795	40.64	5774.68	5815.32	---	---
	11AC80MIMO	Ant1	5210	113.12	5161.84	5274.96	---
Ant2		5210	115.84	5162.96	5278.80	---	---
Ant1		5290	117.12	5221.68	5338.80	---	---
Ant2		5290	110.56	5226.96	5337.52	---	---
Ant1		5530	116.32	5483.76	5600.08	---	---
Ant2		5530	112.16	5481.68	5593.84	---	---
Ant1		5610	80.32	5569.84	5650.16	---	---
Ant2		5610	80.32	5569.84	5650.16	---	---
Ant1		5690	80.32	5649.84	5730.16	---	---
Ant2		5690	80.00	5650.00	5730.00	---	---
Ant1		5690_UNII-2C	75.16	5649.84	5725	---	---
Ant2		5690_UNII-2C	75	5650.00	5725	---	---
Ant1		5690_UNII-3	5.16	5725	5730.16	---	---
Ant2		5690_UNII-3	5	5725	5730.00	---	---
Ant1	5775	80.16	5735.00	5815.16	---	---	
Ant2	5775	80.32	5735.00	5815.32	---	---	
11AC160MIMO	Ant1	5250	170.88	5164.56	5335.44	---	---
	Ant2	5250	168.32	5167.12	5335.44	---	---
	Ant1	5250_UNII-1	85.44	5164.56	5250	---	---
	Ant2	5250_UNII-1	82.88	5167.12	5250	---	---
	Ant1	5250_UNII-2A	85.44	5250	5335.44	---	---
	Ant2	5250_UNII-2A	85.44	5250	5335.44	---	---
	Ant1	5570	168.32	5488.72	5657.04	---	---
	Ant2	5570	169.60	5486.48	5656.08	---	---
11AX20MIMO	Ant1	5180	29.80	5167.72	5197.52	---	---
	Ant2	5180	26.36	5167.36	5193.72	---	---
	Ant1	5200	31.84	5183.16	5215.00	---	---
	Ant2	5200	32.60	5183.24	5215.84	---	---
	Ant1	5240	19.96	5230.04	5250.00	---	---
	Ant2	5240	20.00	5229.96	5249.96	---	---
	Ant1	5260	22.44	5248.88	5271.32	---	---
	Ant2	5260	22.12	5248.96	5271.08	---	---
	Ant1	5280	22.04	5268.88	5290.92	---	---
	Ant2	5280	21.92	5268.92	5290.84	---	---
	Ant1	5320	28.80	5304.36	5333.16	---	---
	Ant2	5320	25.76	5307.32	5333.08	---	---
	Ant1	5500	27.76	5486.92	5514.68	---	---
	Ant2	5500	28.40	5486.28	5514.68	---	---
	Ant1	5580	22.32	5568.72	5591.04	---	---
	Ant2	5580	22.60	5568.64	5591.24	---	---
	Ant1	5700	28.08	5683.12	5711.20	---	---
	Ant2	5700	28.44	5683.36	5711.80	---	---
	Ant1	5720	22.20	5708.92	5731.12	---	---
	Ant2	5720	22.32	5708.84	5731.16	---	---
Ant1	5720_UNII-2C	16.08	5708.92	5725	---	---	

	Ant2	5720 UNII-2C	16.16	5708.84	5725	---	---	
	Ant1	5720 UNII-3	6.12	5725	5731.12	---	---	
	Ant2	5720 UNII-3	6.16	5725	5731.16	---	---	
	Ant1	5745	25.76	5733.52	5759.28	---	---	
	Ant2	5745	25.92	5733.64	5759.56	---	---	
	Ant1	5785	22.48	5773.76	5796.24	---	---	
	Ant2	5785	22.24	5773.92	5796.16	---	---	
	Ant1	5825	28.20	5809.20	5837.40	---	---	
	Ant2	5825	27.08	5809.68	5836.76	---	---	
11AX40MIMO	Ant1	5190	51.76	5166.64	5218.40	---	---	
	Ant2	5190	45.92	5168.96	5214.88	---	---	
	Ant1	5230	39.92	5210.00	5249.92	---	---	
	Ant2	5230	39.84	5210.08	5249.92	---	---	
	Ant1	5270	39.76	5250.16	5289.92	---	---	
	Ant2	5270	39.76	5250.16	5289.92	---	---	
	Ant1	5310	54.16	5279.04	5333.20	---	---	
	Ant2	5310	51.52	5282.80	5334.32	---	---	
	Ant1	5510	45.12	5487.92	5533.04	---	---	
	Ant2	5510	49.36	5487.04	5536.40	---	---	
	Ant1	5550	39.68	5530.16	5569.84	---	---	
	Ant2	5550	39.92	5530.08	5570.00	---	---	
	Ant1	5670	56.56	5640.88	5697.44	---	---	
	Ant2	5670	56.88	5643.04	5699.92	---	---	
	Ant1	5710	39.84	5690.08	5729.92	---	---	
	Ant2	5710	39.92	5690.08	5730.00	---	---	
	Ant1	5710 UNII-2C	34.92	5690.08	5725	---	---	
	Ant2	5710 UNII-2C	34.92	5690.08	5725	---	---	
	Ant1	5710 UNII-3	4.92	5725	5729.92	---	---	
	Ant2	5710 UNII-3	5	5725	5730.00	---	---	
	Ant1	5755	45.76	5735.08	5780.84	---	---	
	Ant2	5755	51.52	5734.52	5786.04	---	---	
	Ant1	5795	41.04	5774.36	5815.40	---	---	
	Ant2	5795	40.64	5774.68	5815.32	---	---	
11AX80MIMO	Ant1	5210	107.84	5163.28	5271.12	---	---	
	Ant2	5210	106.56	5163.44	5270.00	---	---	
	Ant1	5290	110.72	5225.84	5336.56	---	---	
	Ant2	5290	108.32	5227.28	5335.60	---	---	
	Ant1	5530	113.12	5483.76	5596.88	---	---	
	Ant2	5530	117.76	5484.24	5602.00	---	---	
	Ant1	5610	80.32	5569.84	5650.16	---	---	
	Ant2	5610	80.00	5570.00	5650.00	---	---	
	Ant1	5690	80.64	5649.68	5730.32	---	---	
	Ant2	5690	80.80	5649.68	5730.48	---	---	
	Ant1	5690 UNII-2C	75.32	5649.68	5725	---	---	
	Ant2	5690 UNII-2C	75.32	5649.68	5725	---	---	
	Ant1	5690 UNII-3	5.32	5725	5730.32	---	---	
	Ant2	5690 UNII-3	5.48	5725	5730.48	---	---	
	Ant1	5775	80.16	5734.84	5815.00	---	---	
	Ant2	5775	80.16	5734.84	5815.00	---	---	
	11AX160MIMO	Ant1	5250	166.08	5166.16	5332.24	---	---
		Ant2	5250	164.48	5167.44	5331.92	---	---
		Ant1	5250 UNII-1	83.84	5166.16	5250	---	---
		Ant2	5250 UNII-1	82.56	5167.44	5250	---	---
Ant1		5250 UNII-2A	82.24	5250	5332.24	---	---	
Ant2		5250 UNII-2A	81.92	5250	5331.92	---	---	
Ant1		5570	163.84	5488.72	5652.56	---	---	
Ant2		5570	167.68	5485.52	5653.20	---	---	

4.5. Test graphs

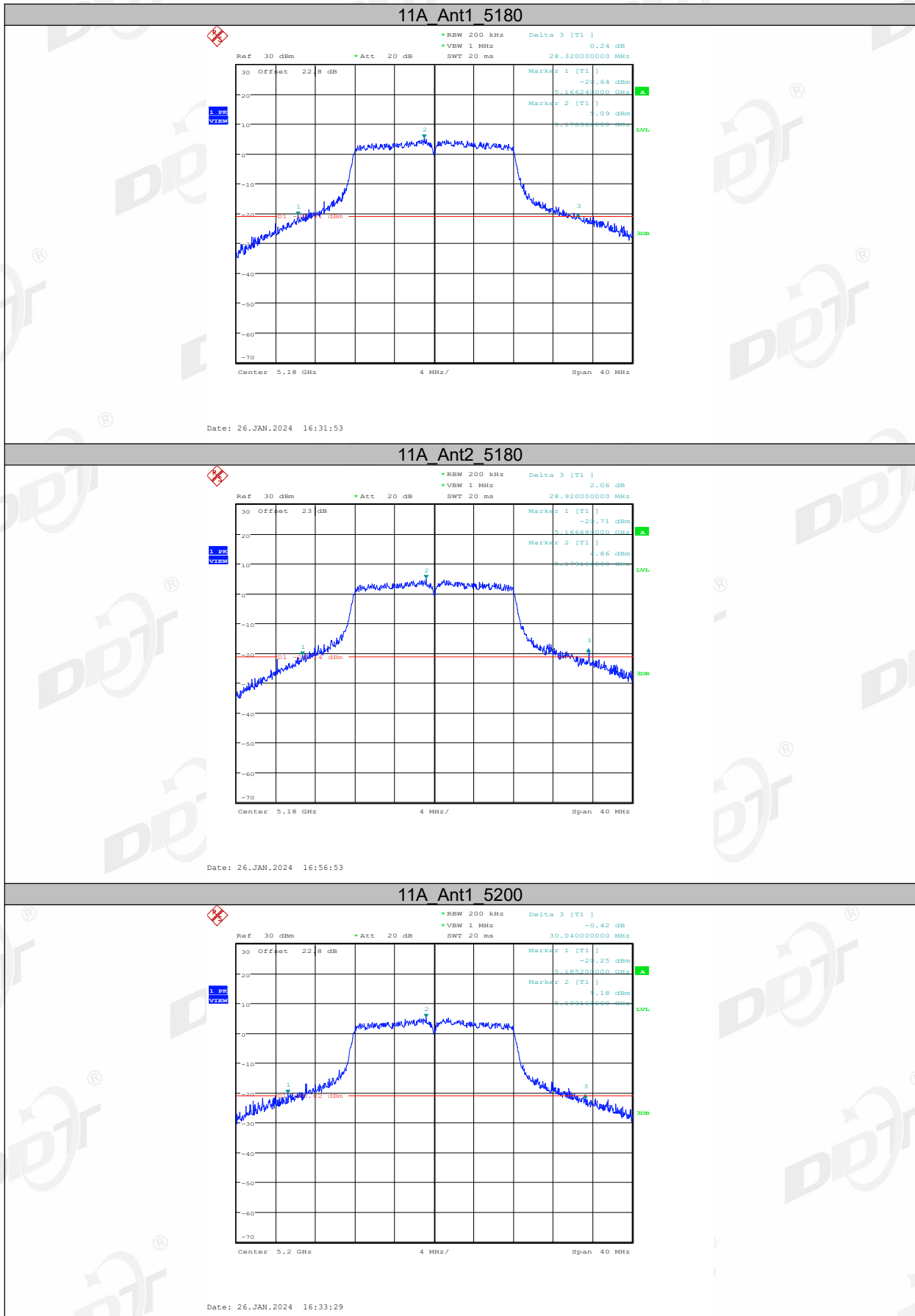

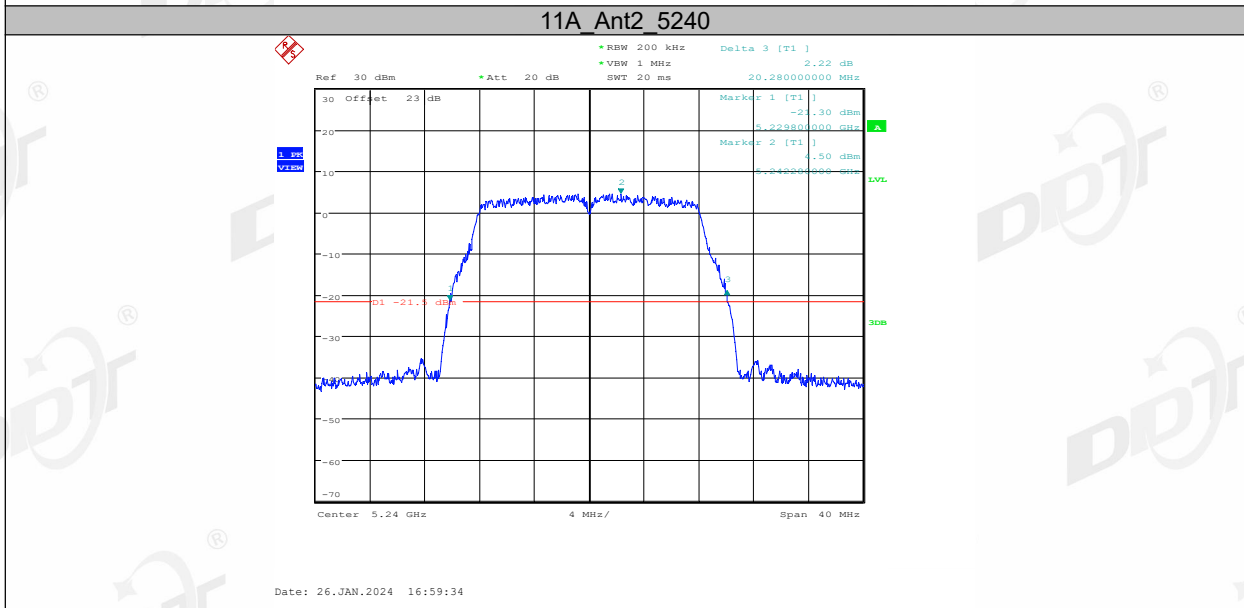
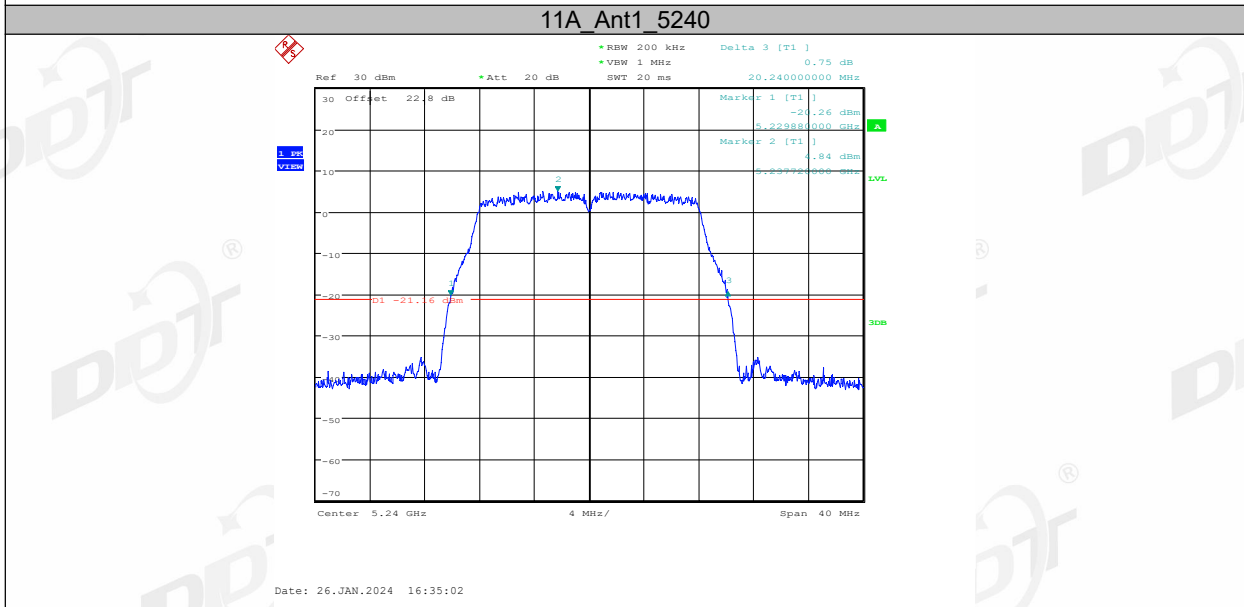
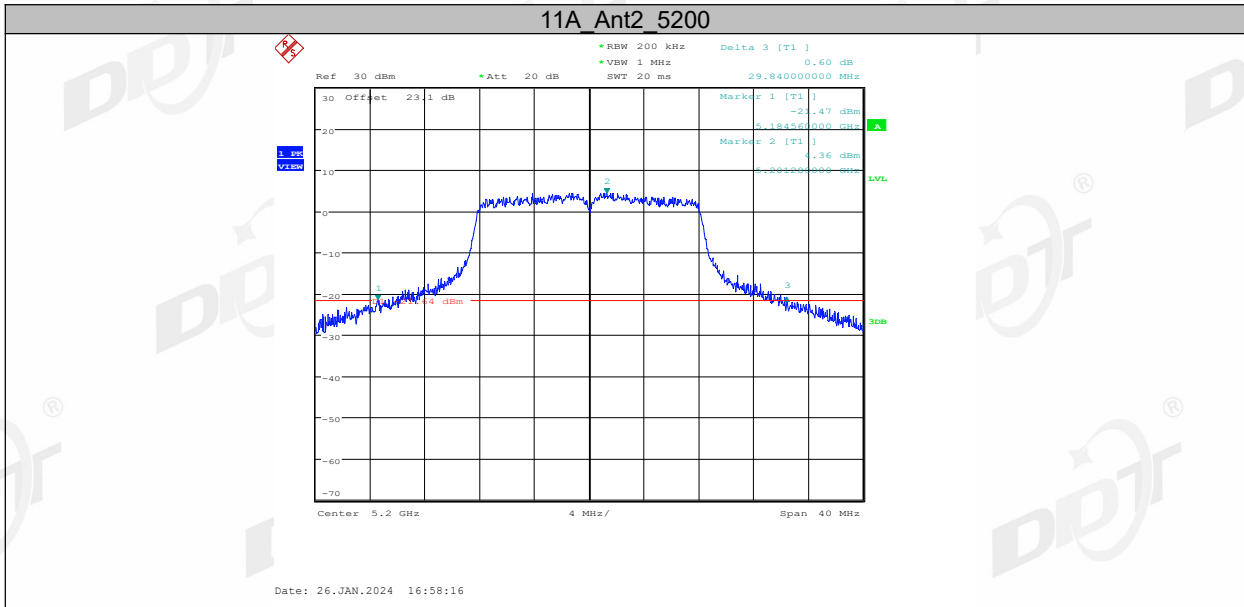

11A_Ant1_5260

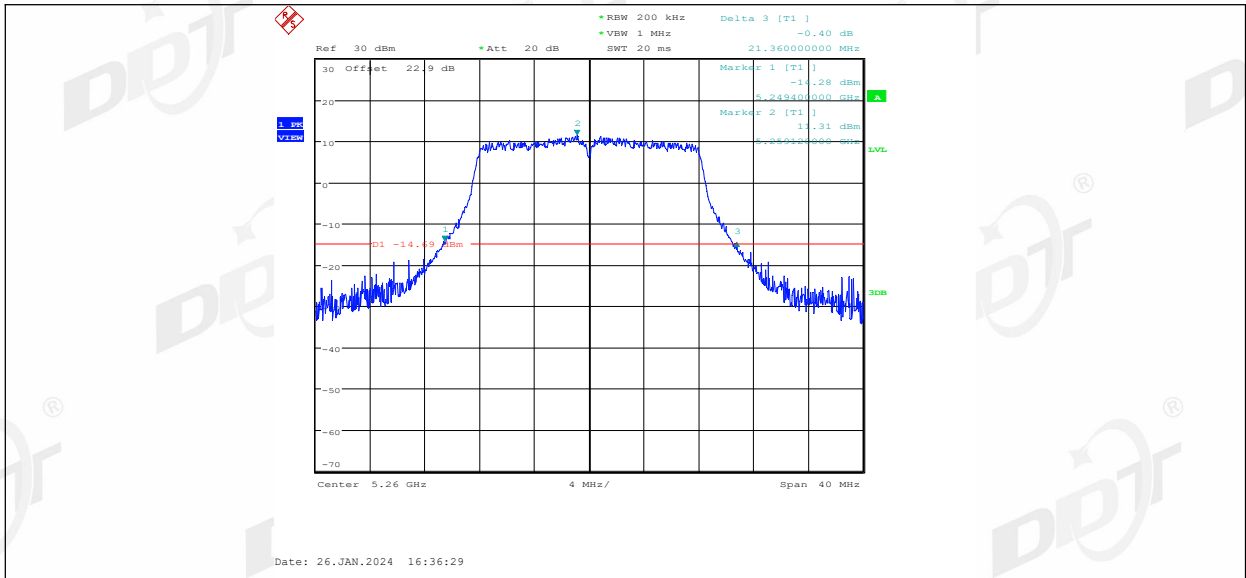

11A_Ant2_5260

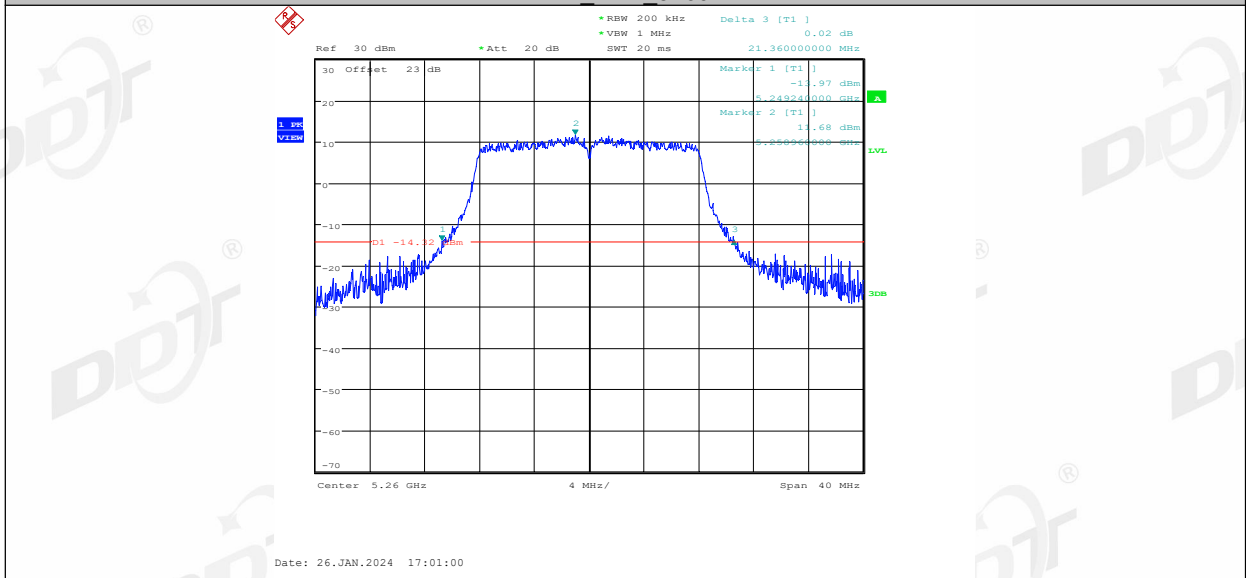

11A_Ant1_5280

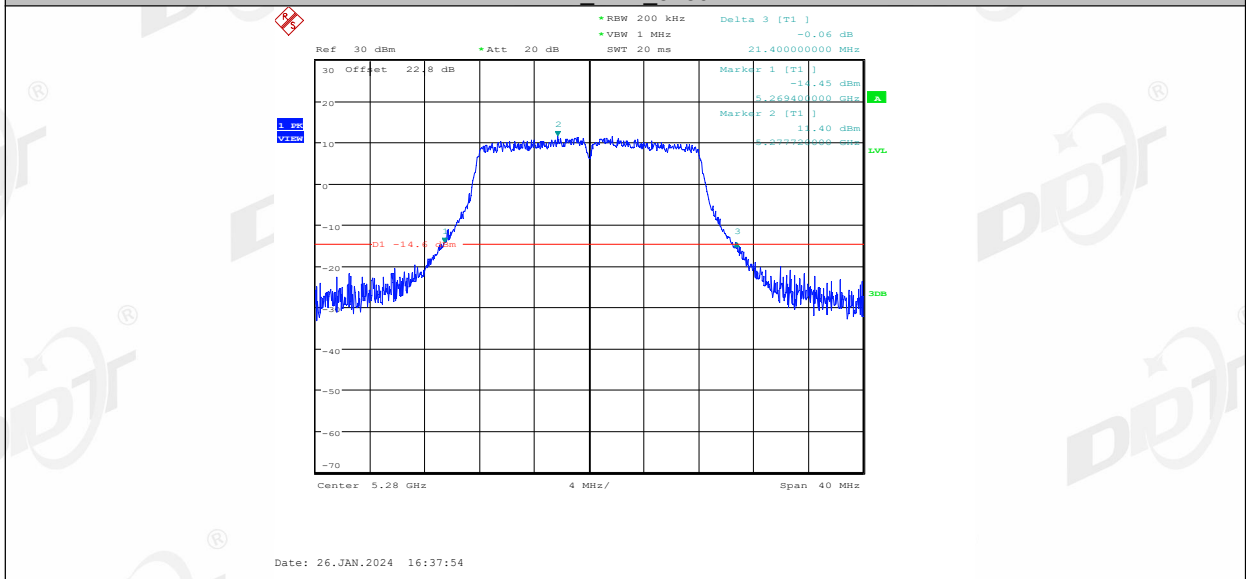

11A_Ant2_5280

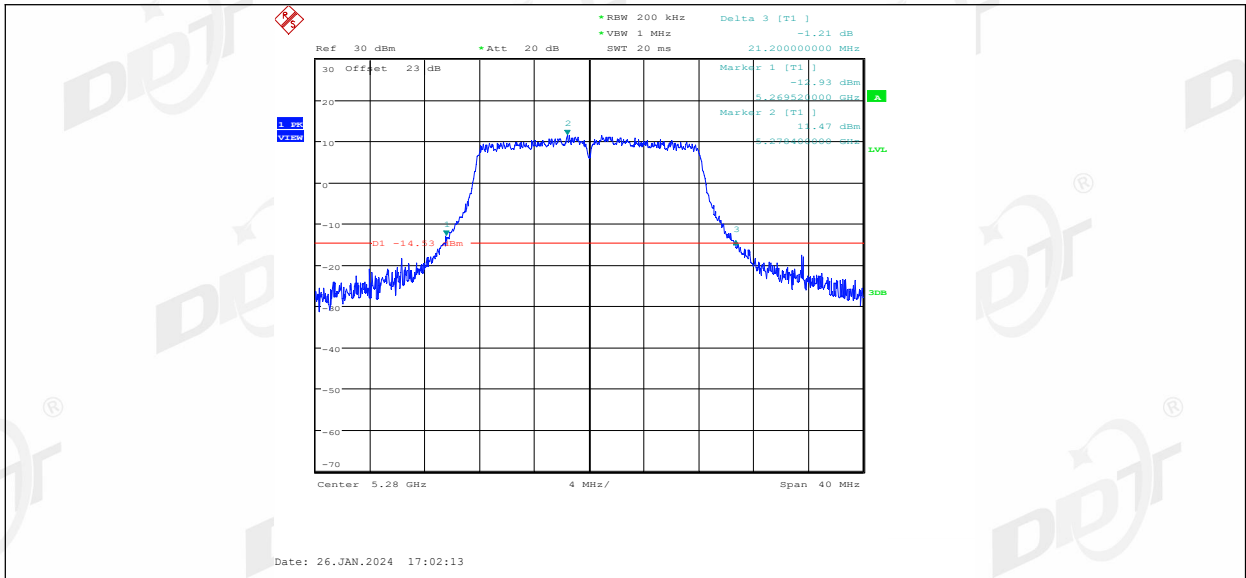

11A_Ant1_5320

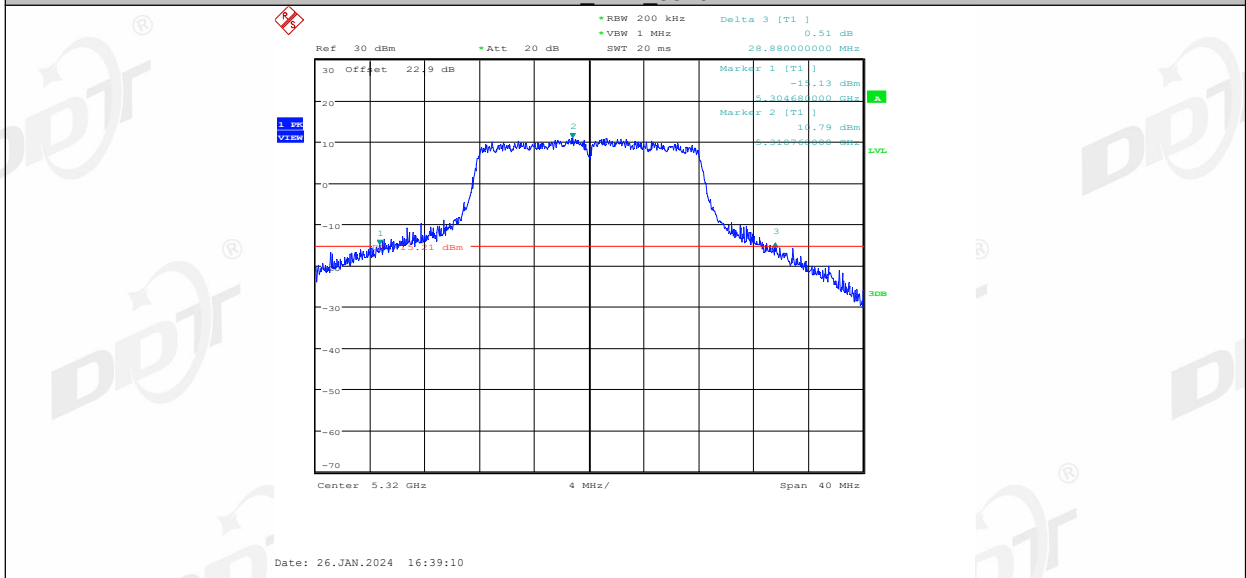

11A_Ant2_5320

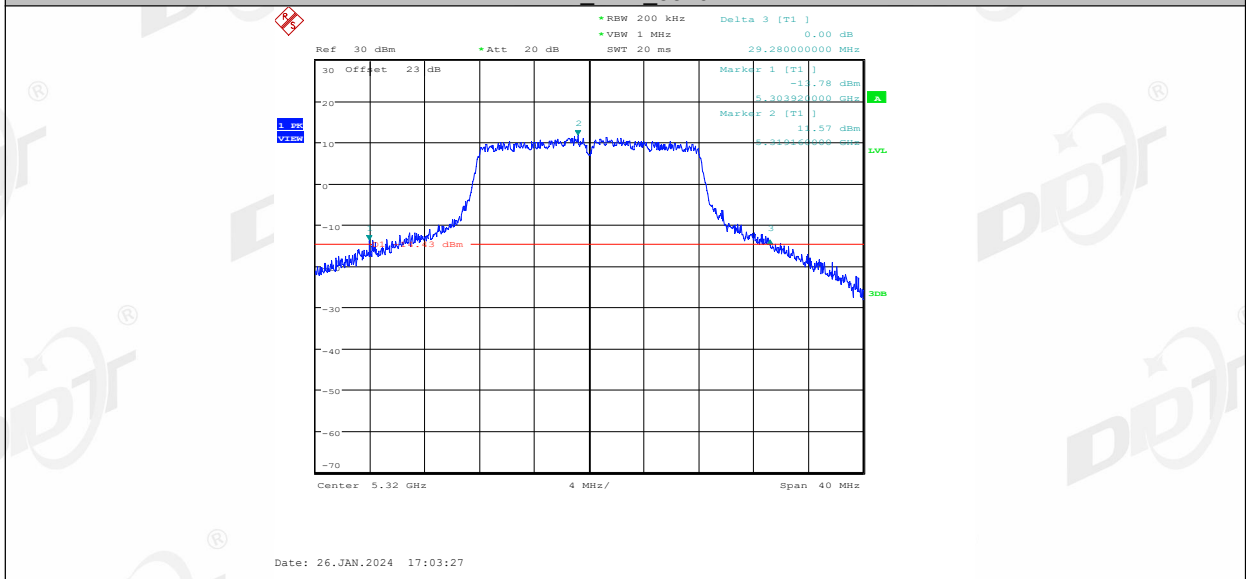

11A_Ant1_5500

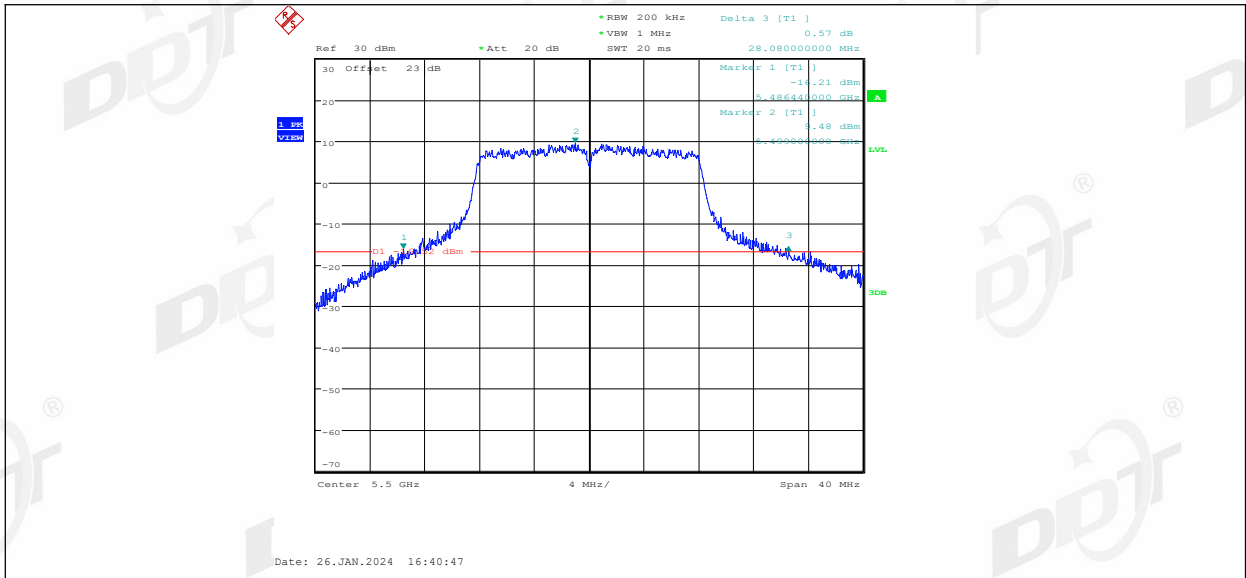

11A_Ant2_5500

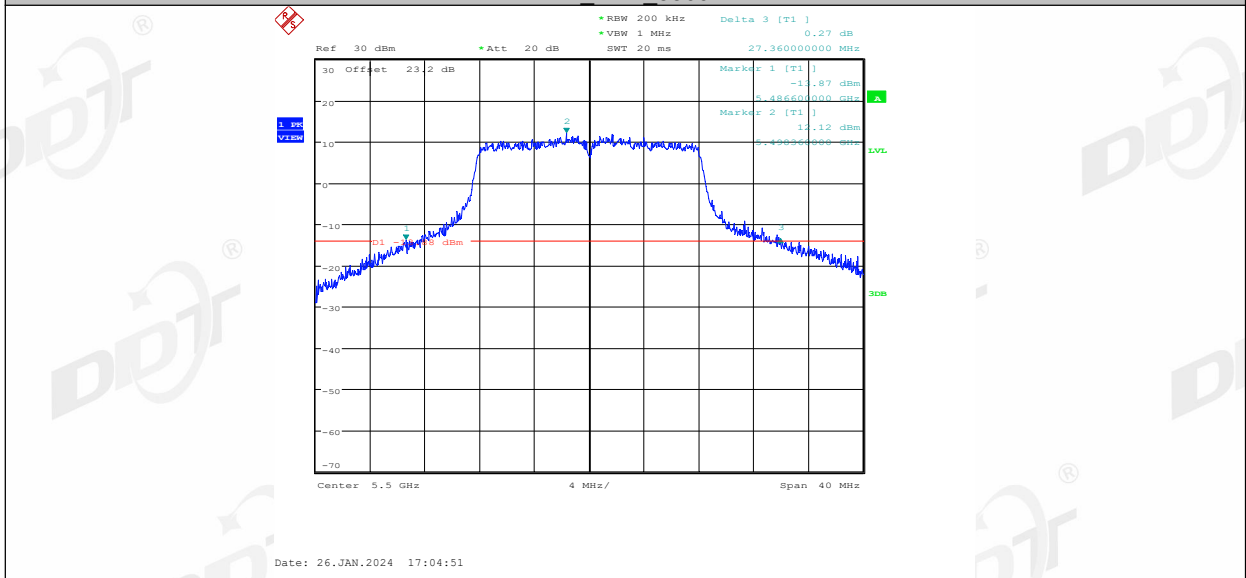

11A_Ant1_5580

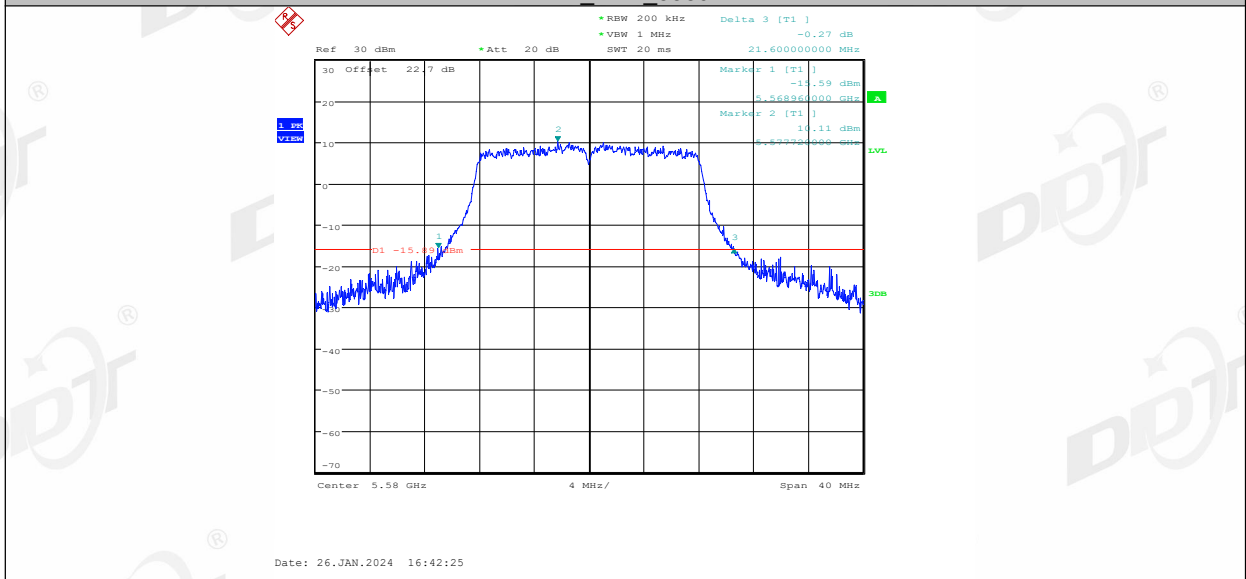

11A_Ant2_5580

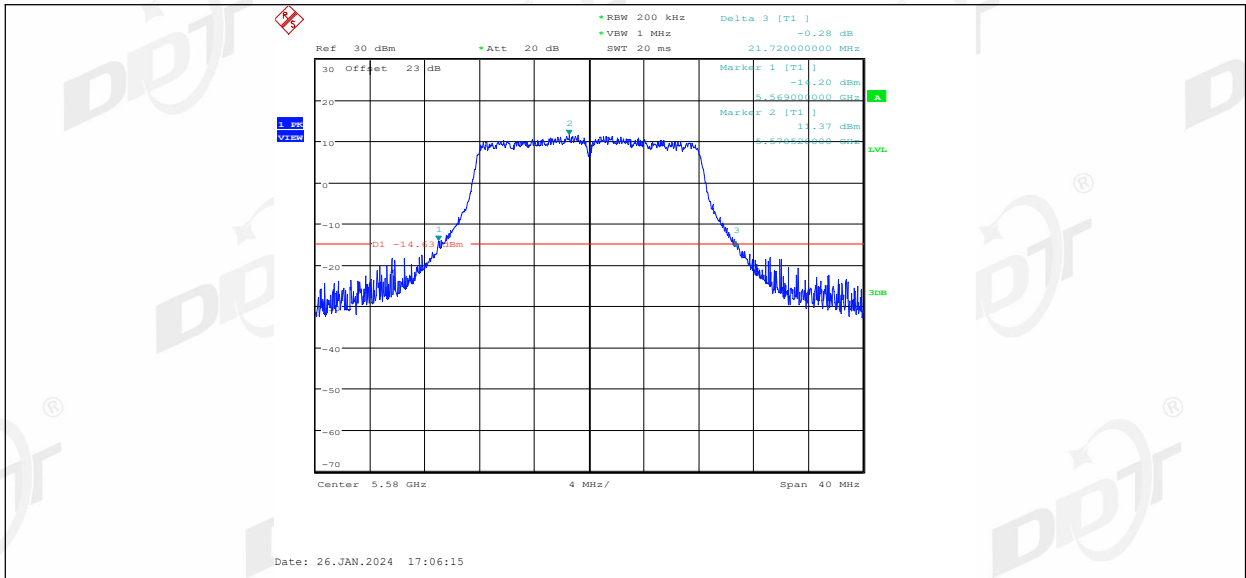

11A_Ant1_5700

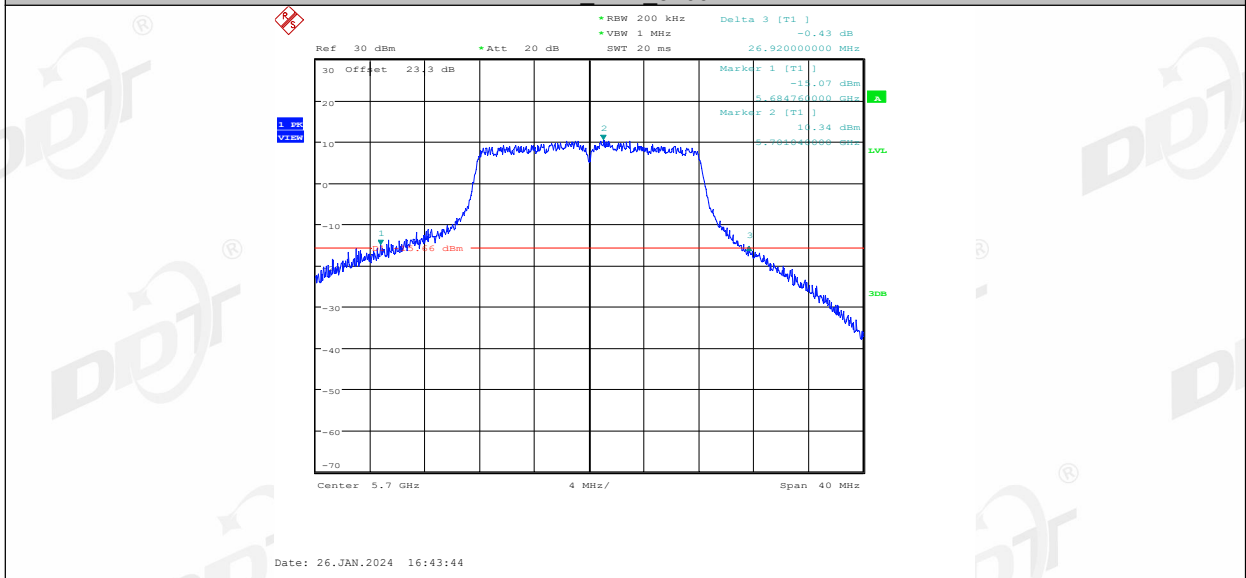

11A_Ant2_5700

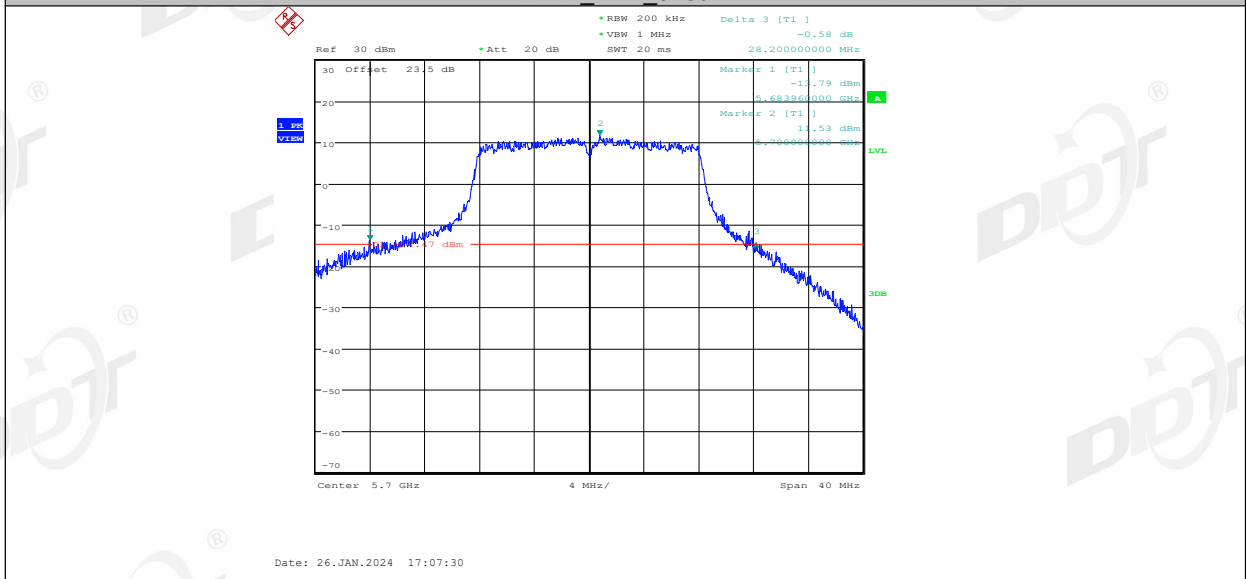

11A_Ant1_5720

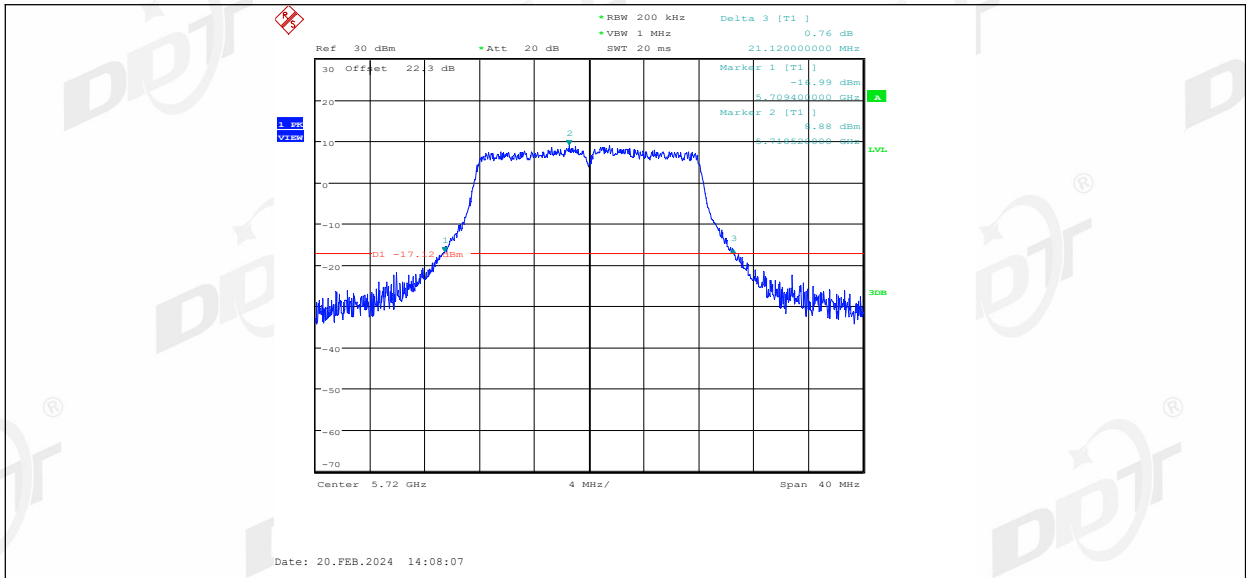

11A_Ant2_5720

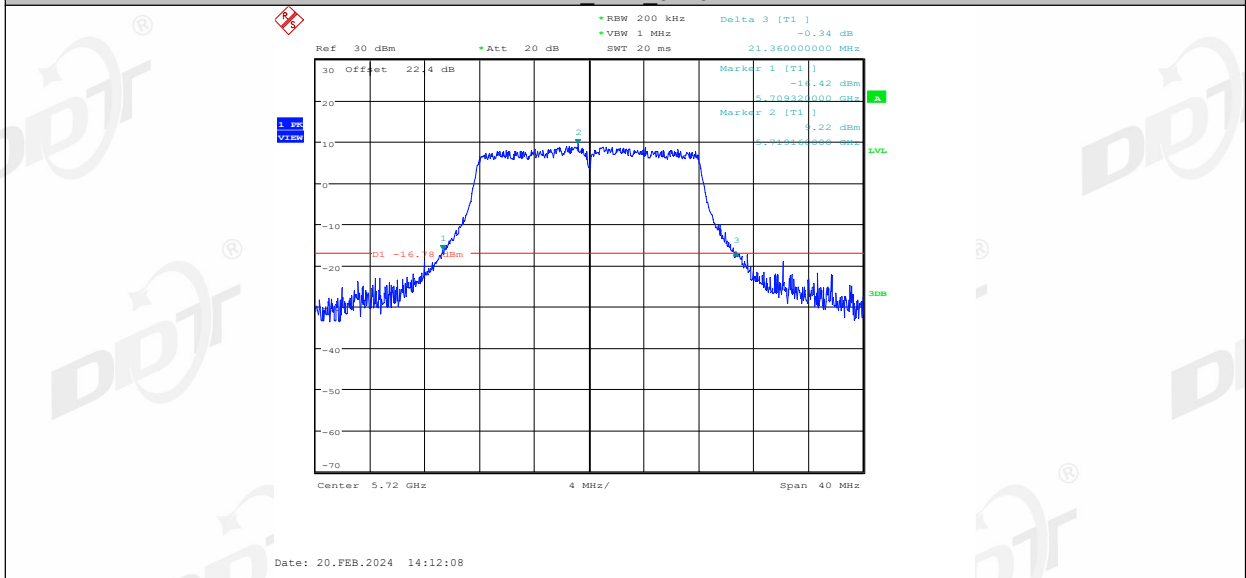

11A_Ant1_5745

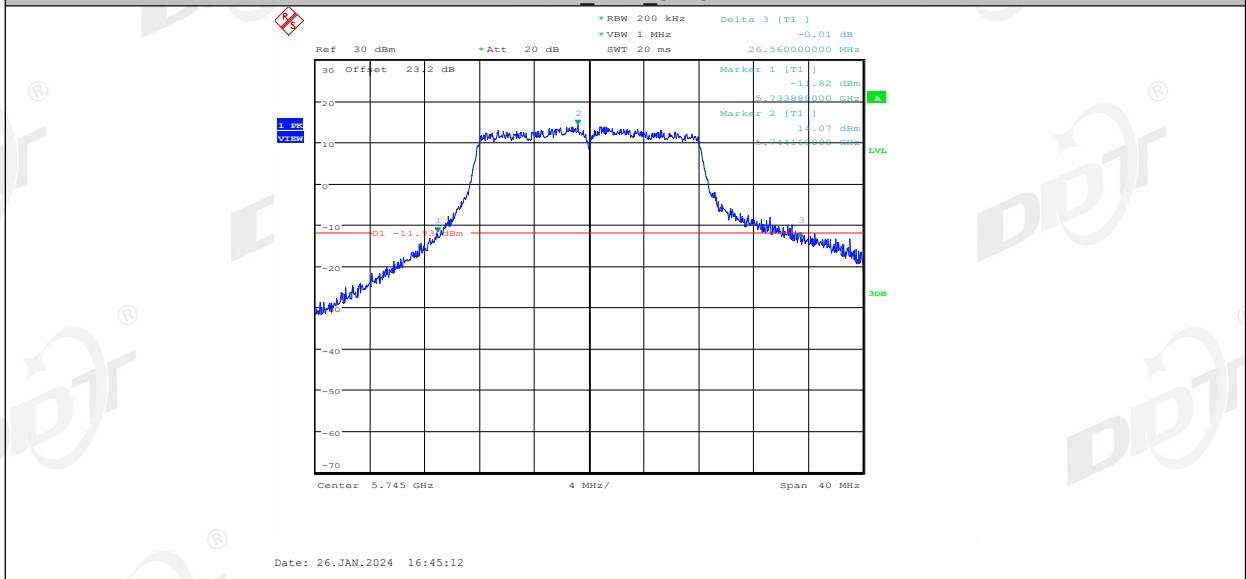

11A_Ant2_5745

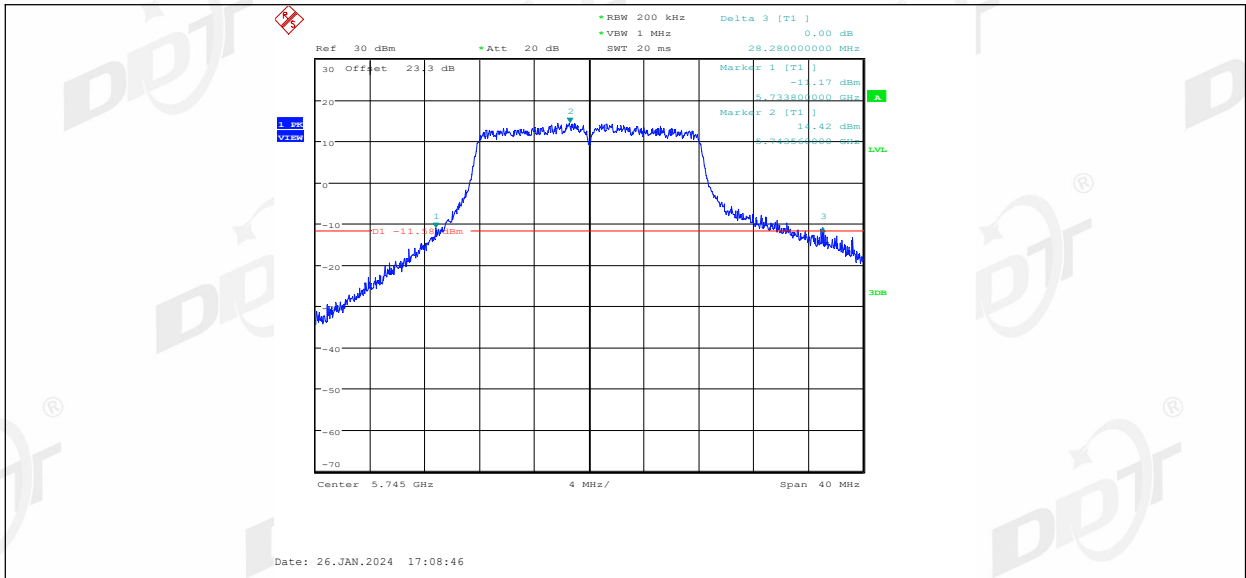

11A_Ant1_5785

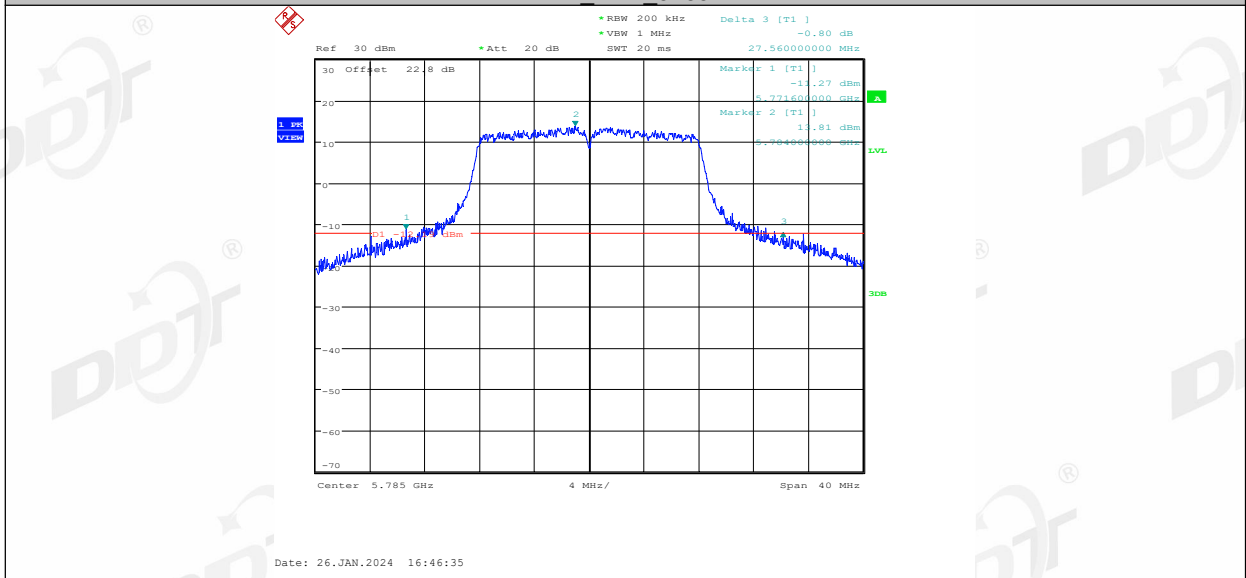

11A_Ant2_5785

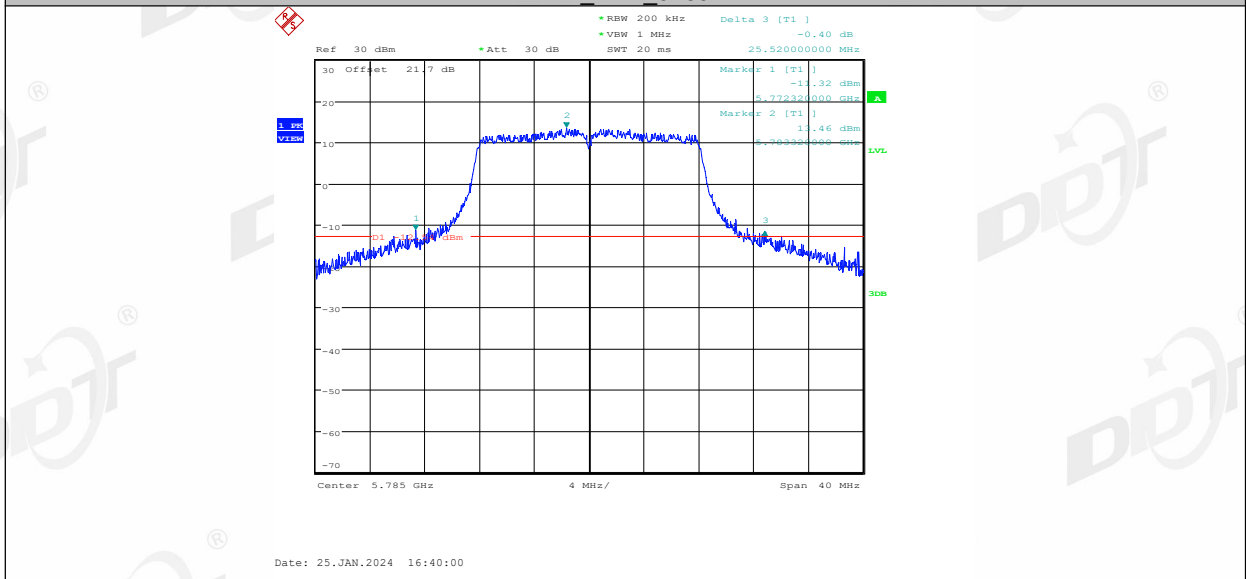

11A_Ant1_5825

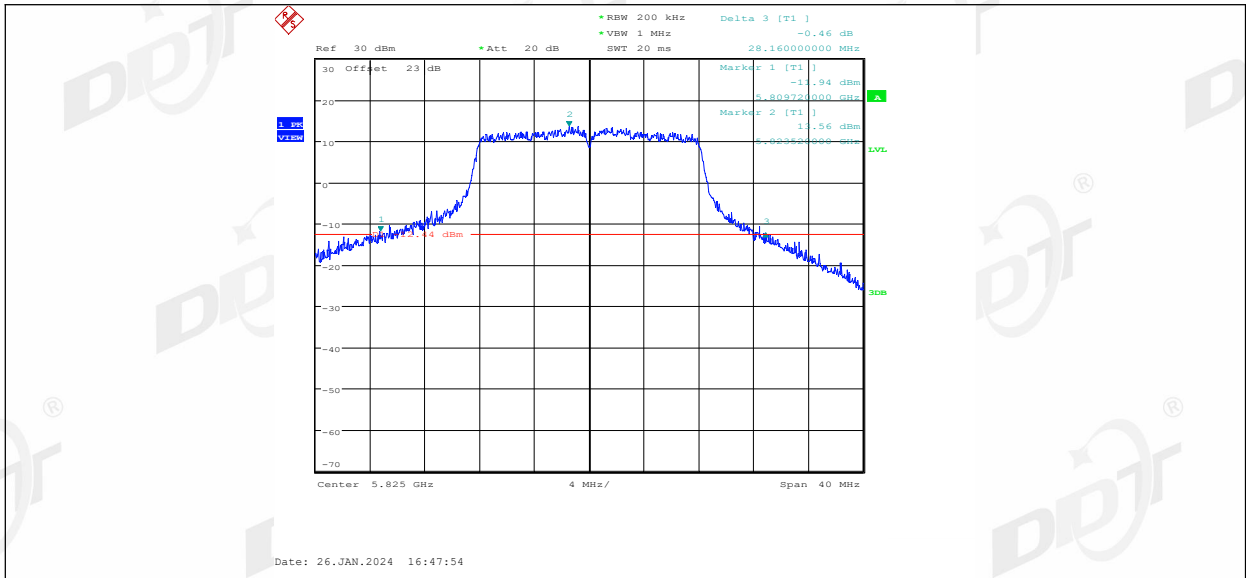

11A_Ant2_5825

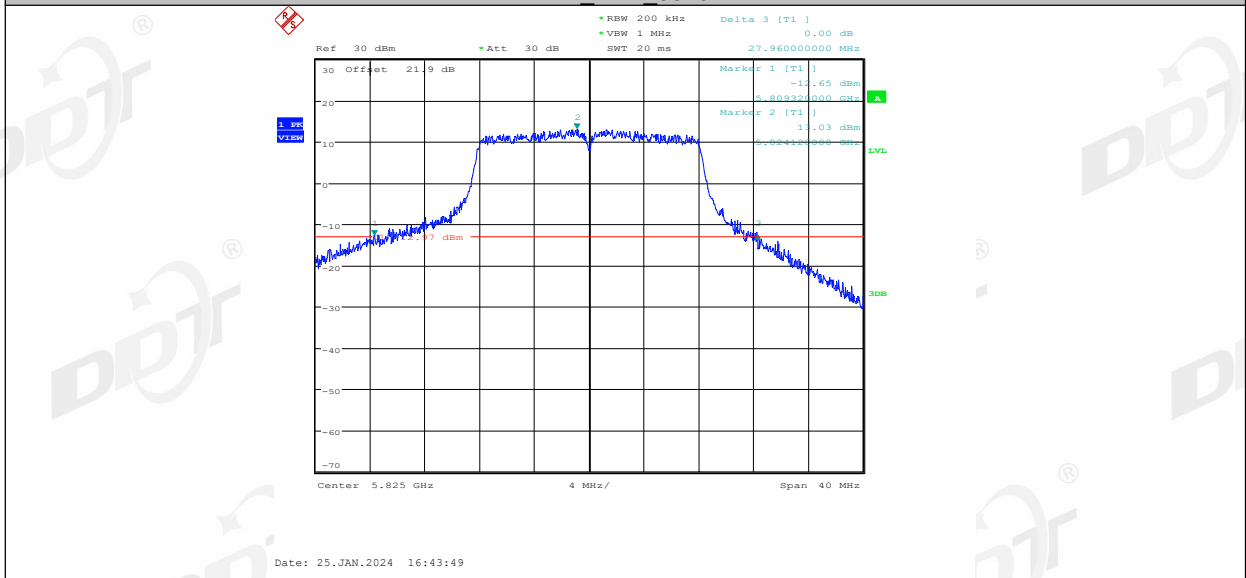

11N20MIMO_Ant1_5180

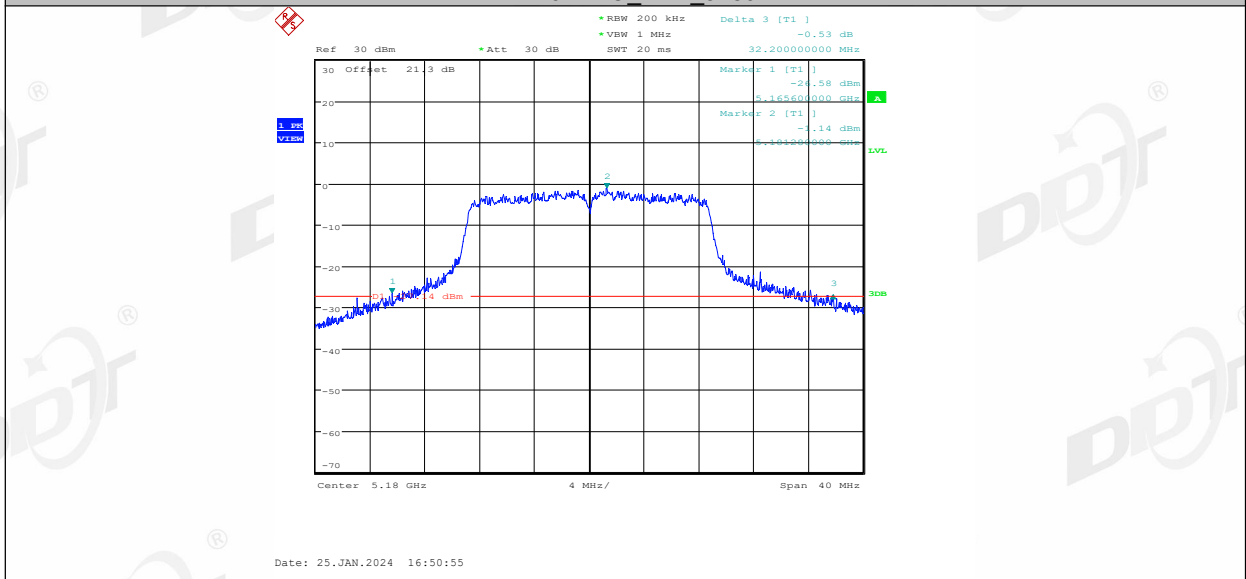

11N20MIMO_Ant2_5180

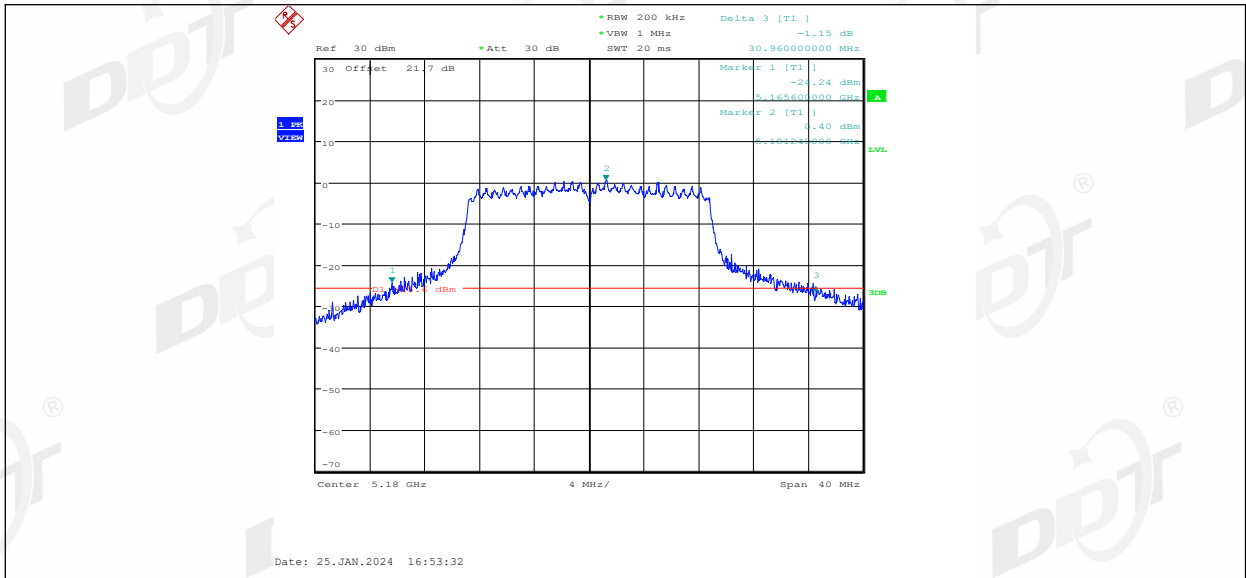

11N20MIMO_Ant1_5200

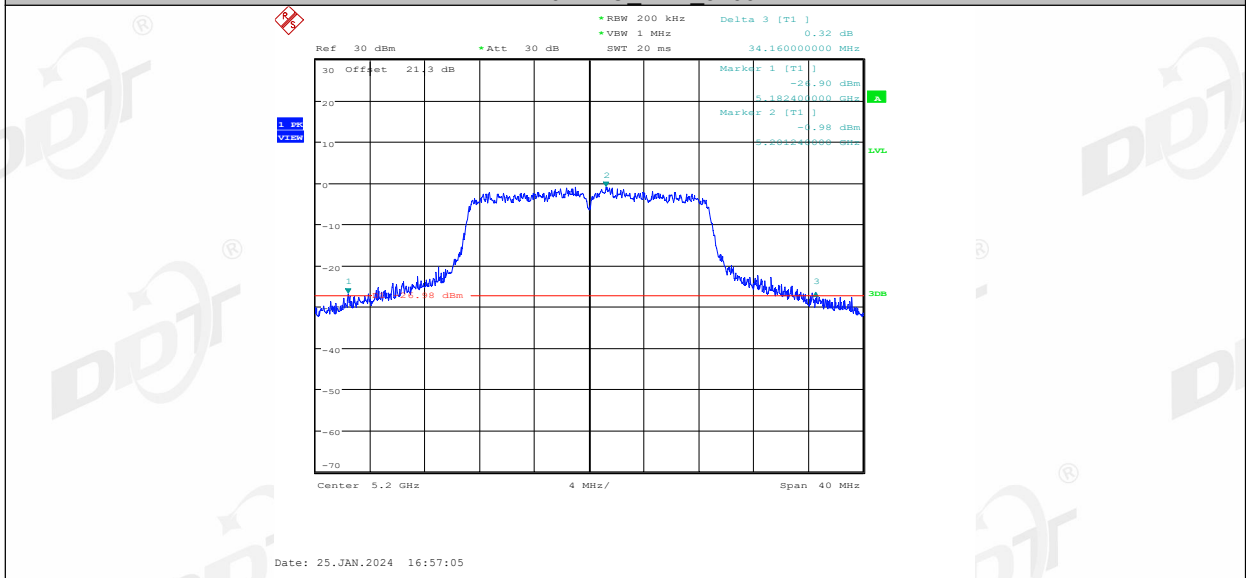

11N20MIMO_Ant2_5200

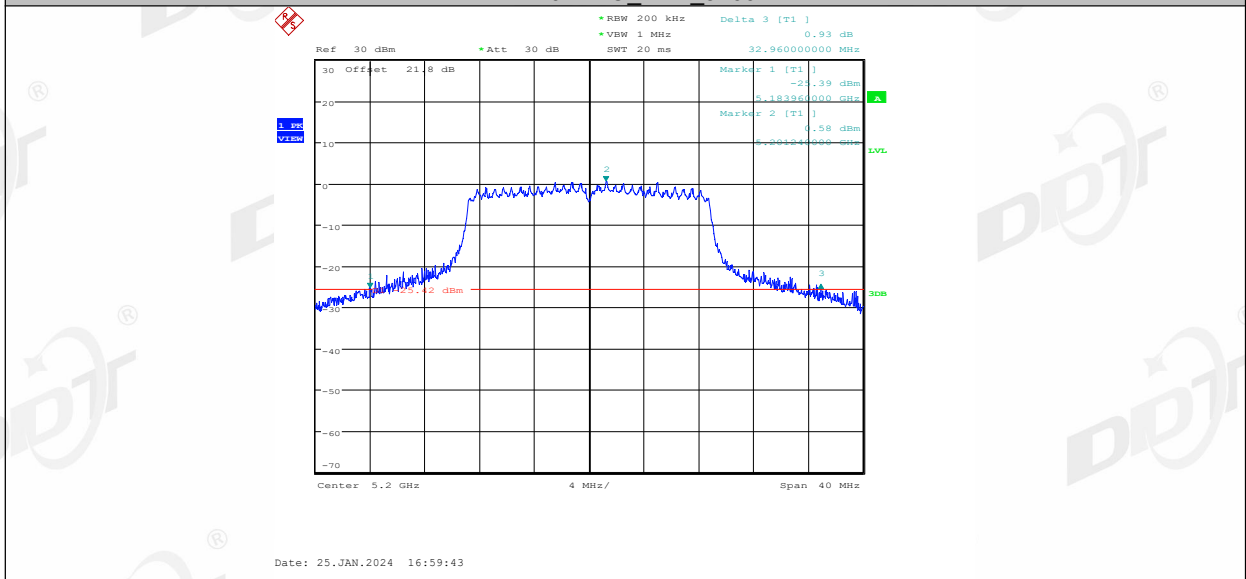

11N20MIMO_Ant1_5240

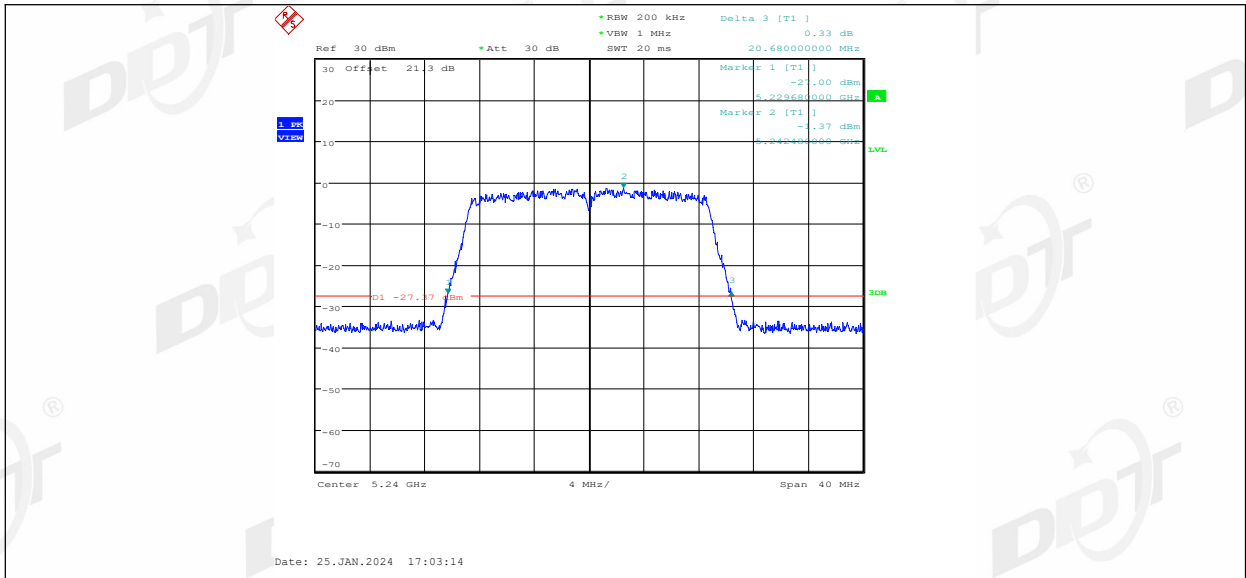

11N20MIMO_Ant2_5240

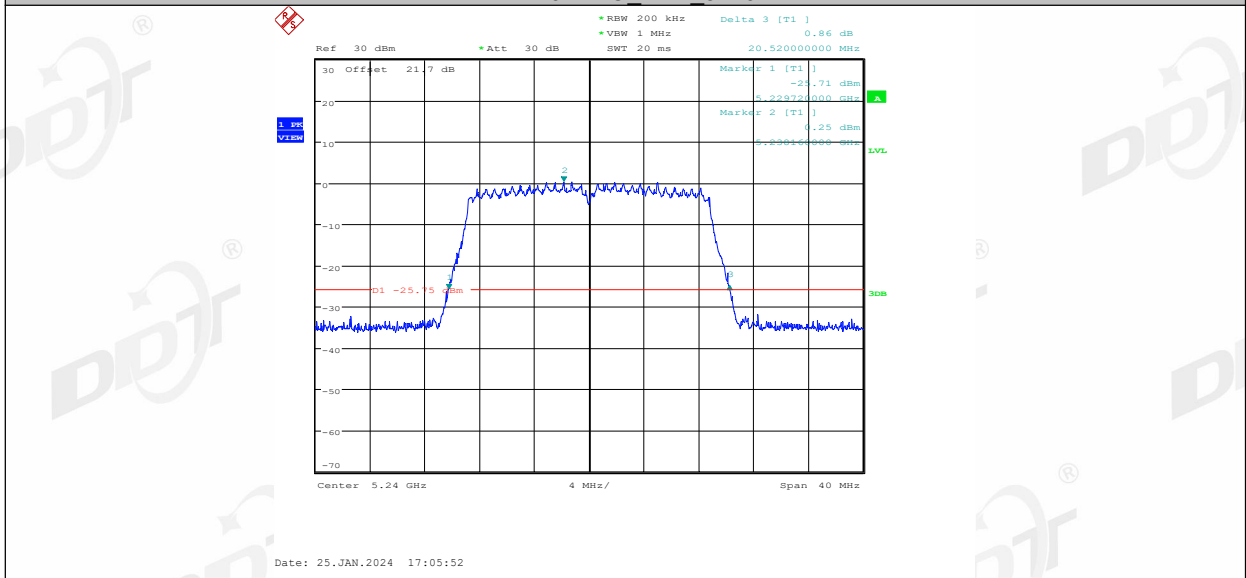

11N20MIMO_Ant1_5260

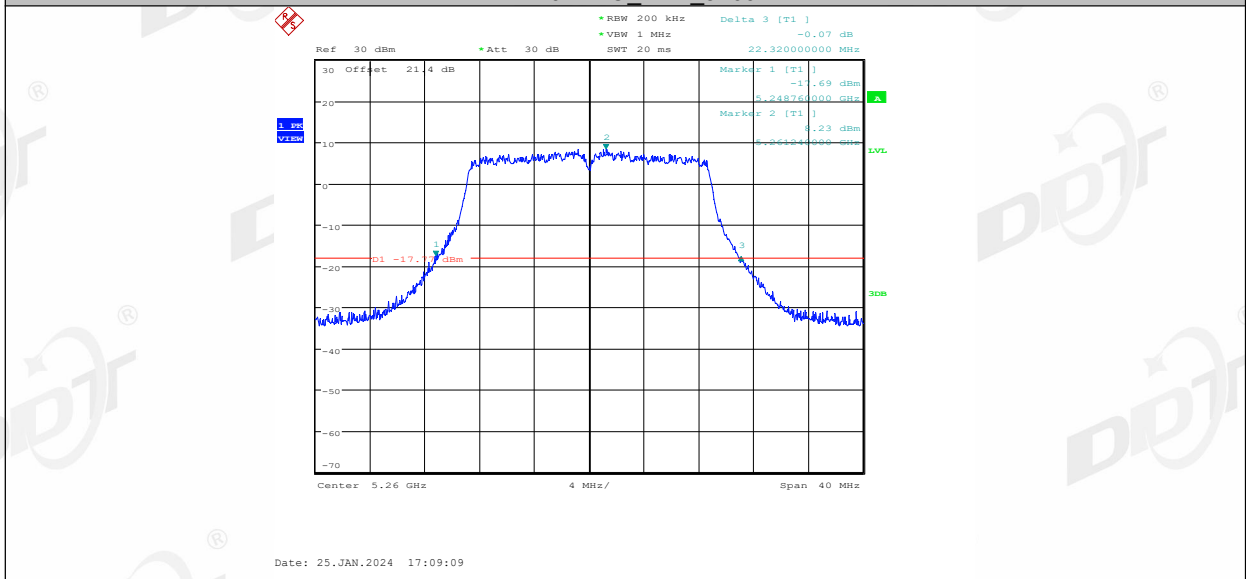

11N20MIMO_Ant2_5260

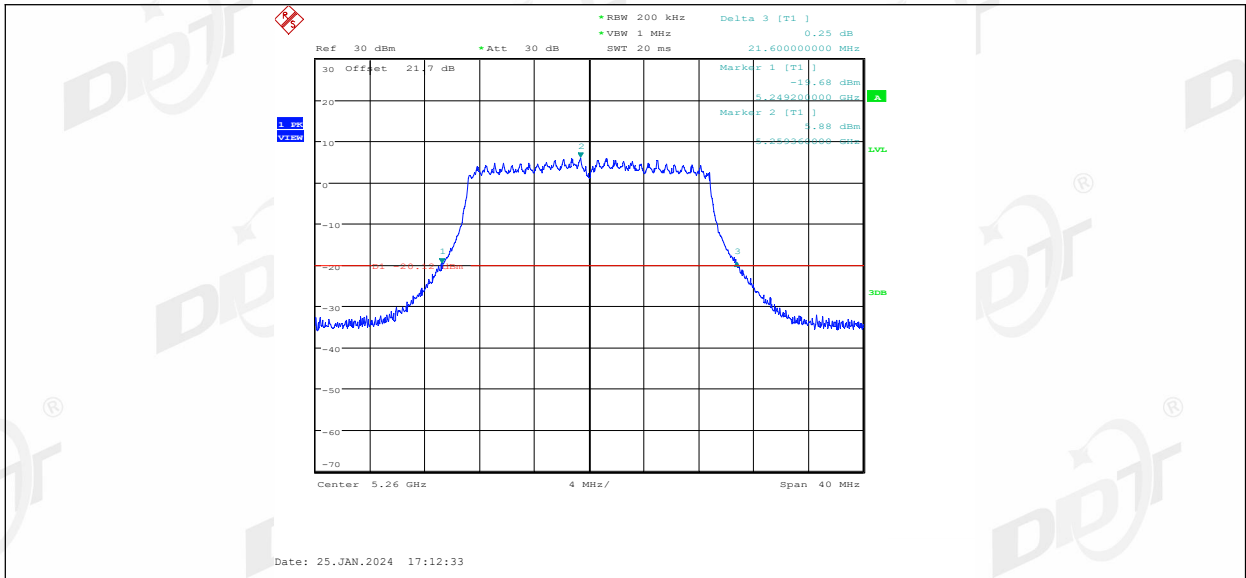

11N20MIMO_Ant1_5280

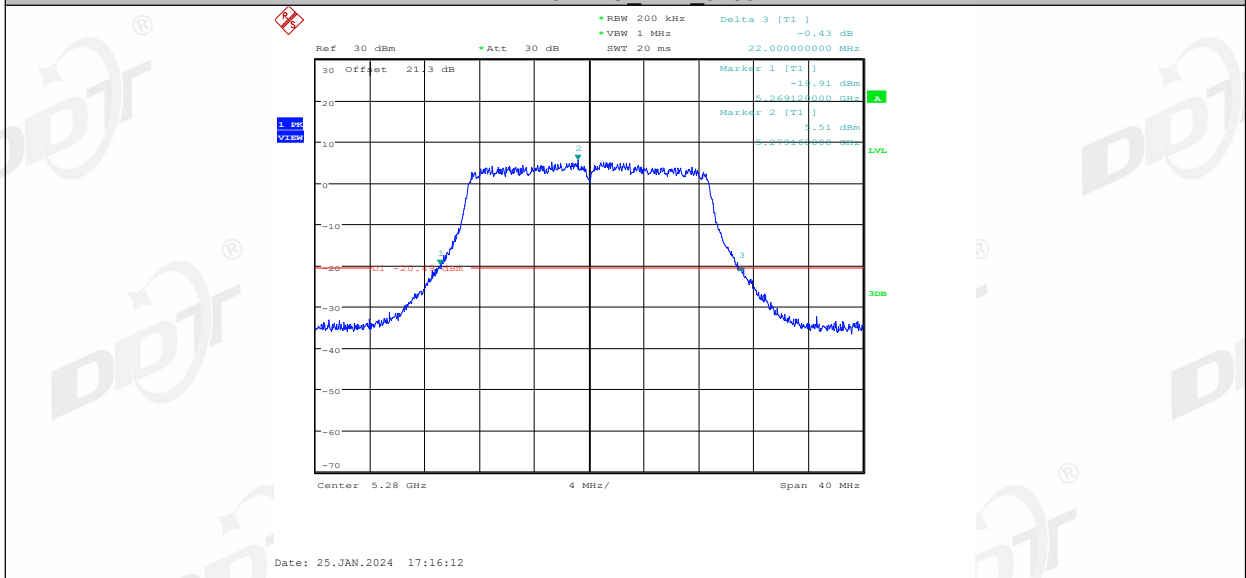

11N20MIMO_Ant2_5280

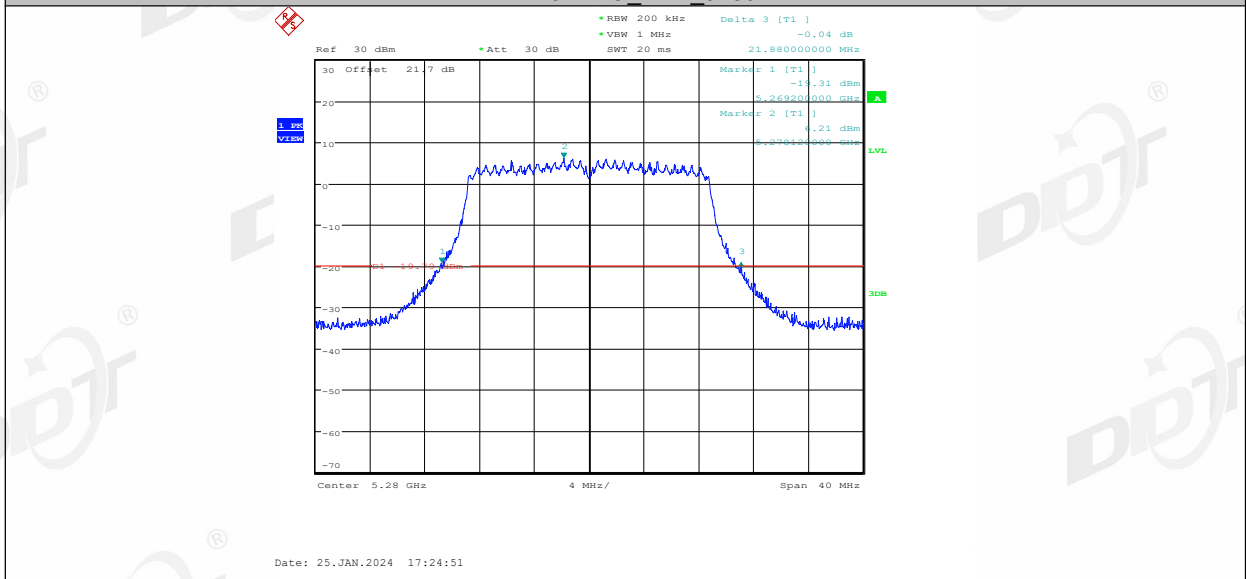

11N20MIMO_Ant1_5320

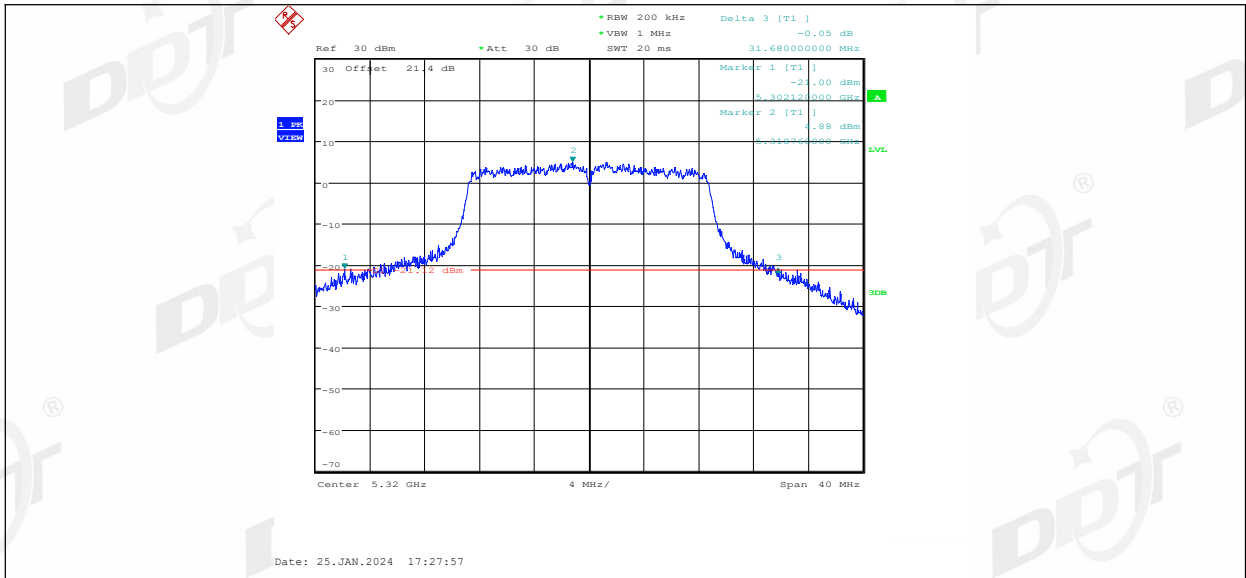

11N20MIMO_Ant2_5320

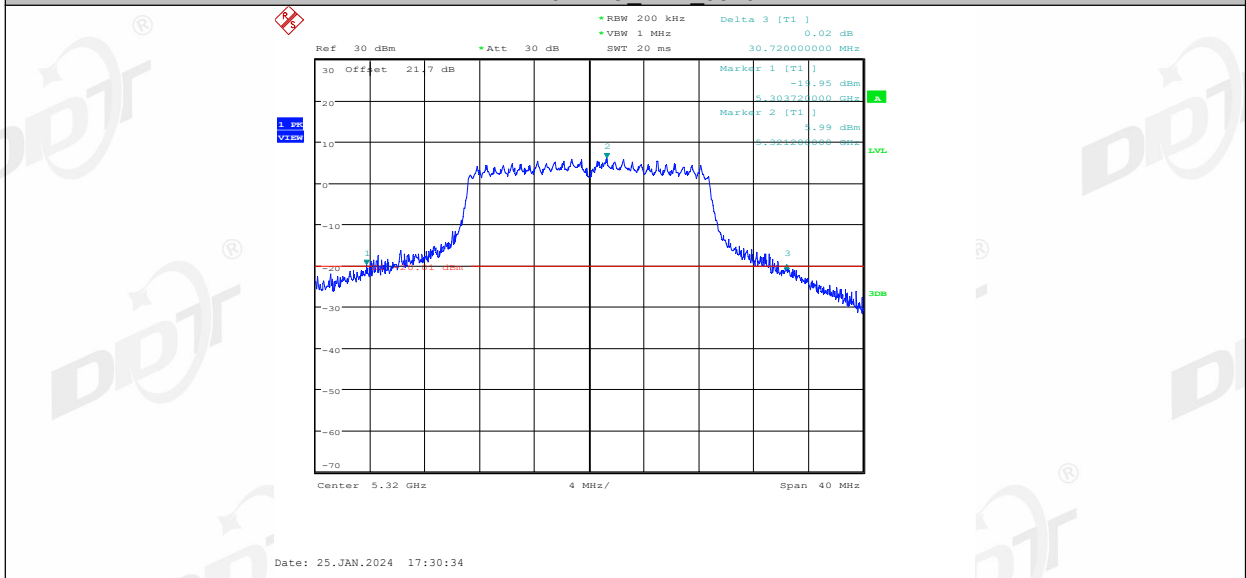

11N20MIMO_Ant1_5500

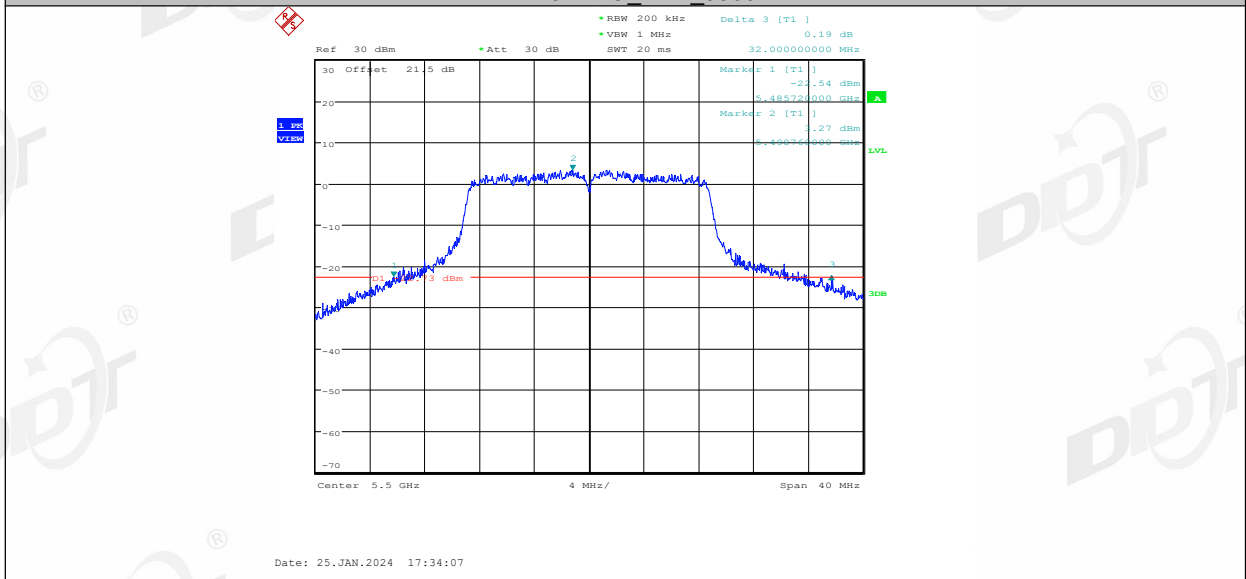

11N20MIMO_Ant2_5500

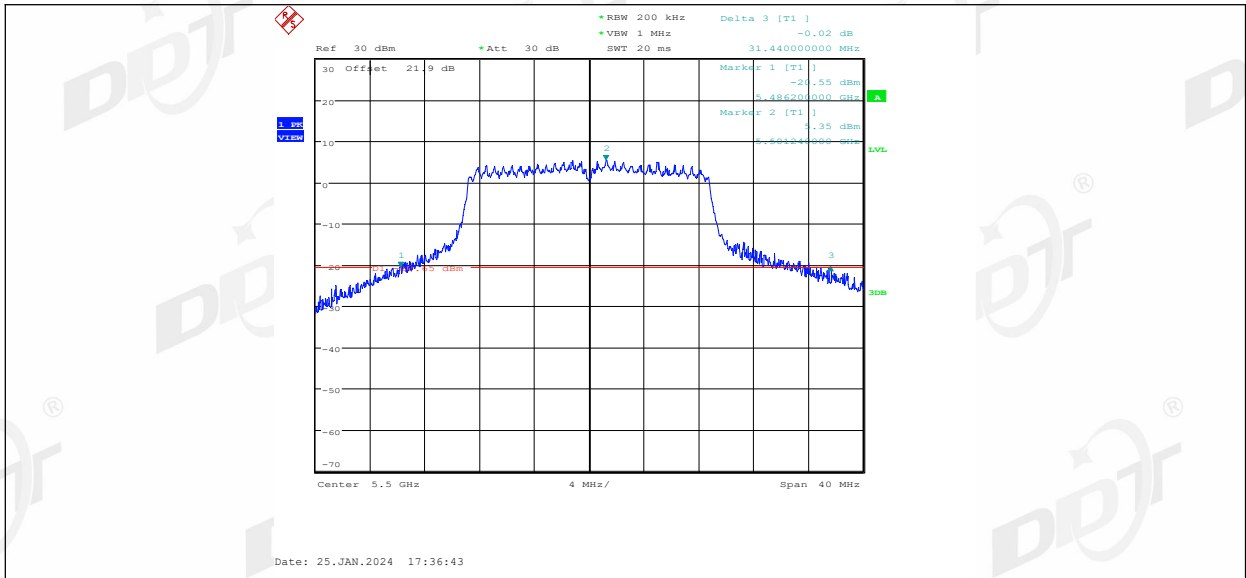

11N20MIMO_Ant1_5580

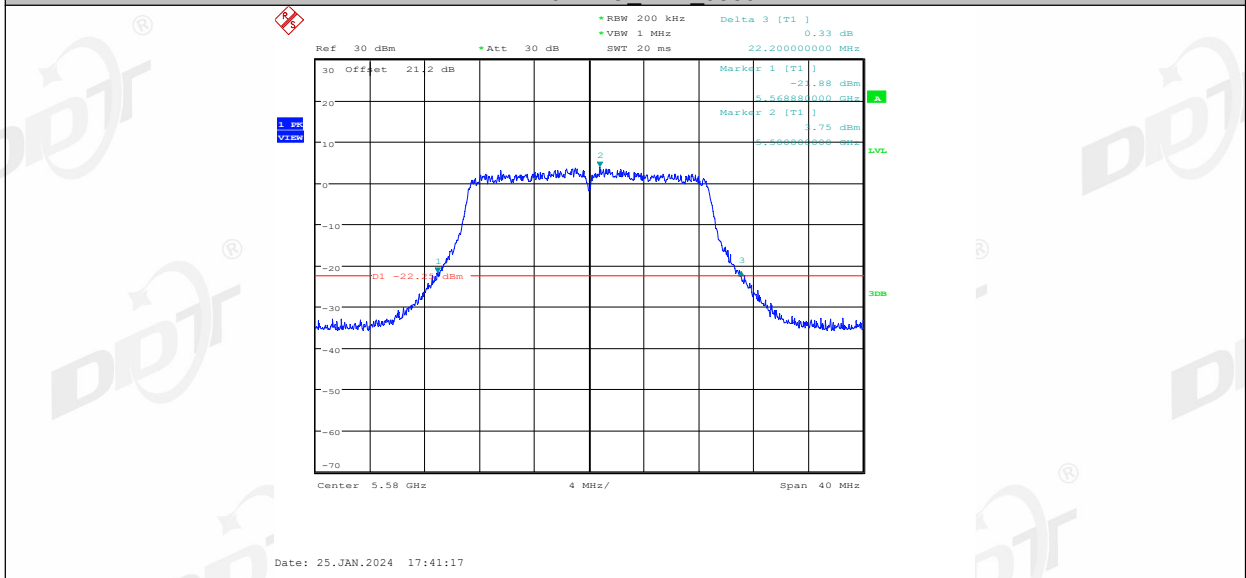

11N20MIMO_Ant2_5580

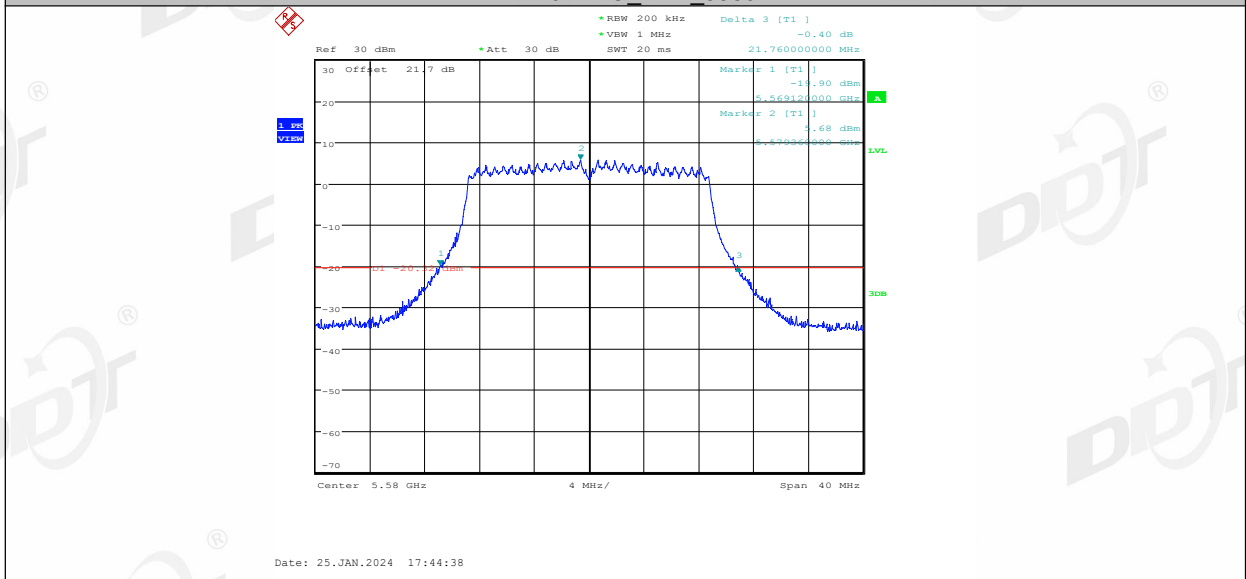

11N20MIMO_Ant1_5700

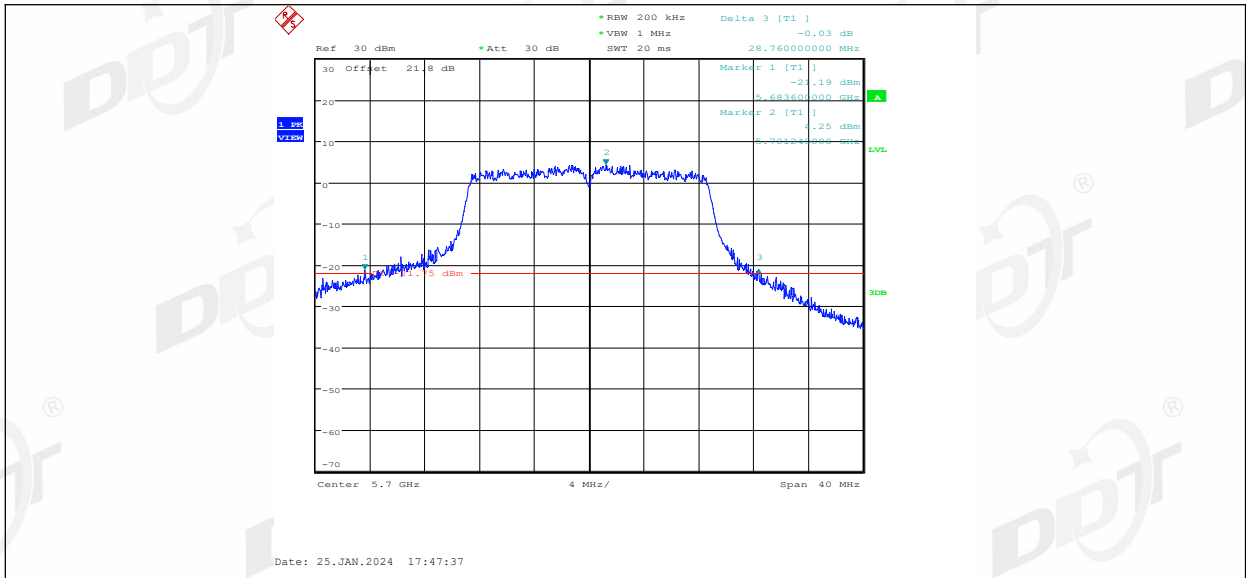

11N20MIMO_Ant2_5700

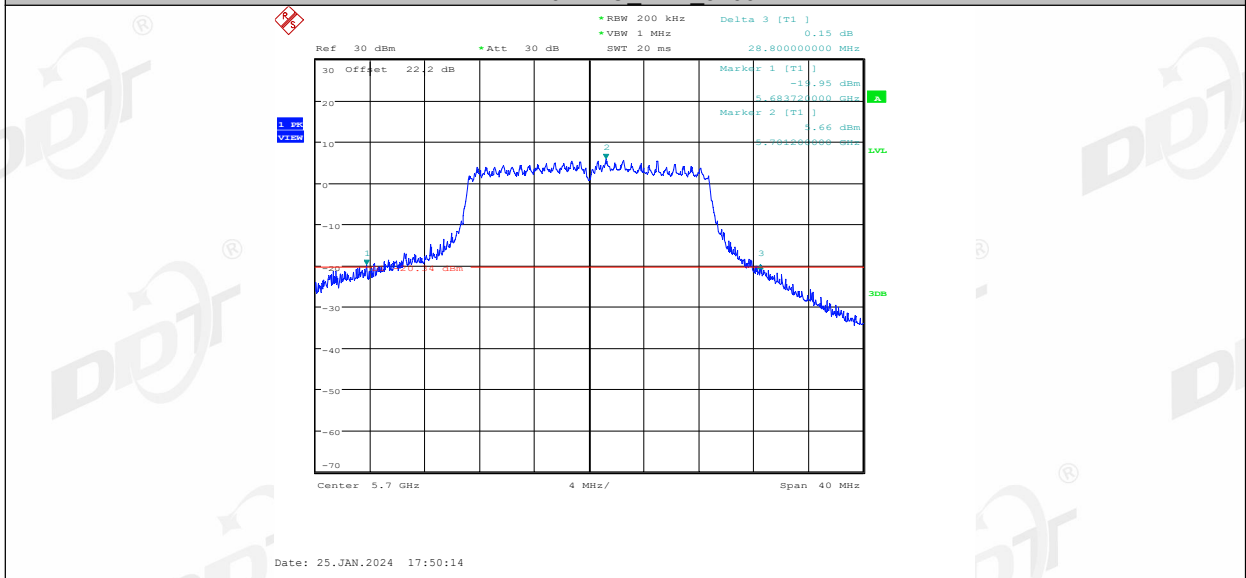

11N20MIMO_Ant1_5720

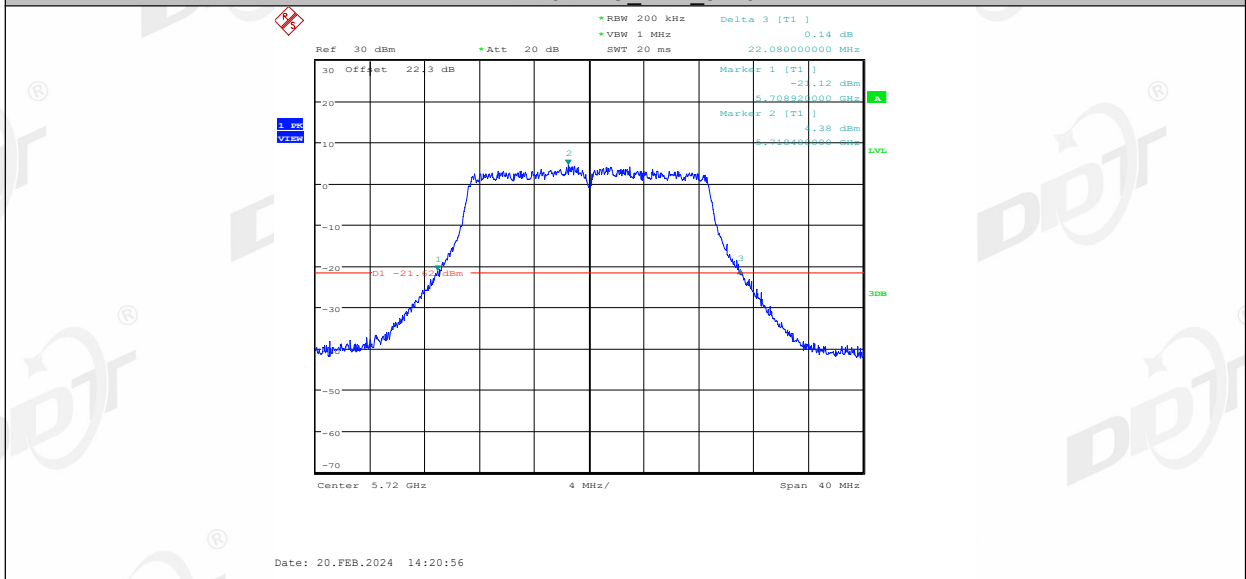

11N20MIMO_Ant2_5720

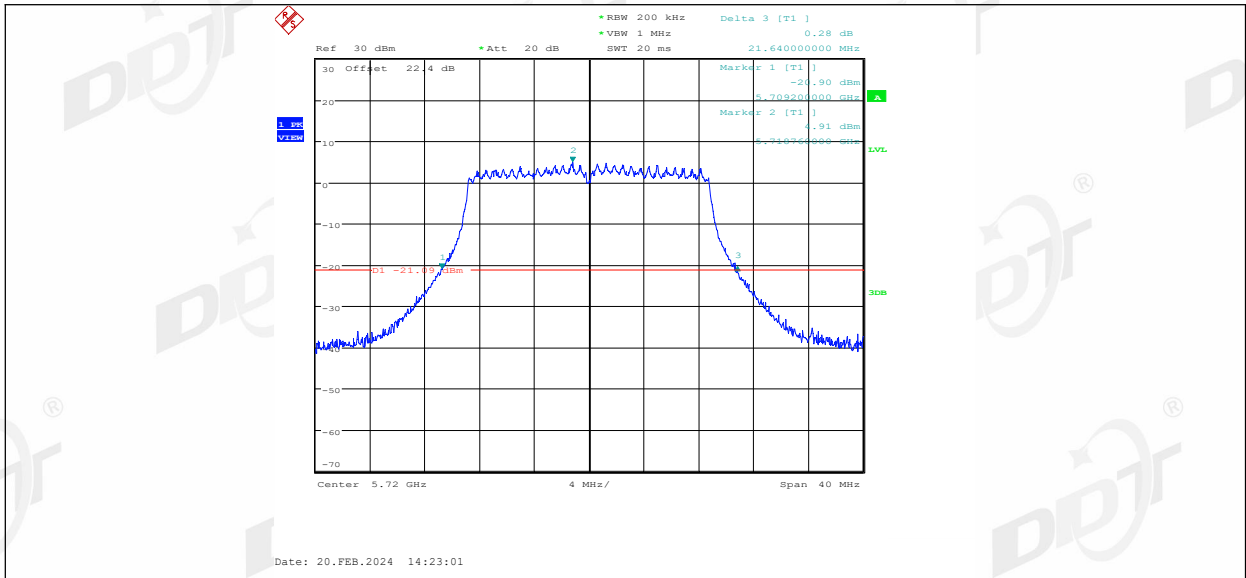

11N20MIMO_Ant1_5745

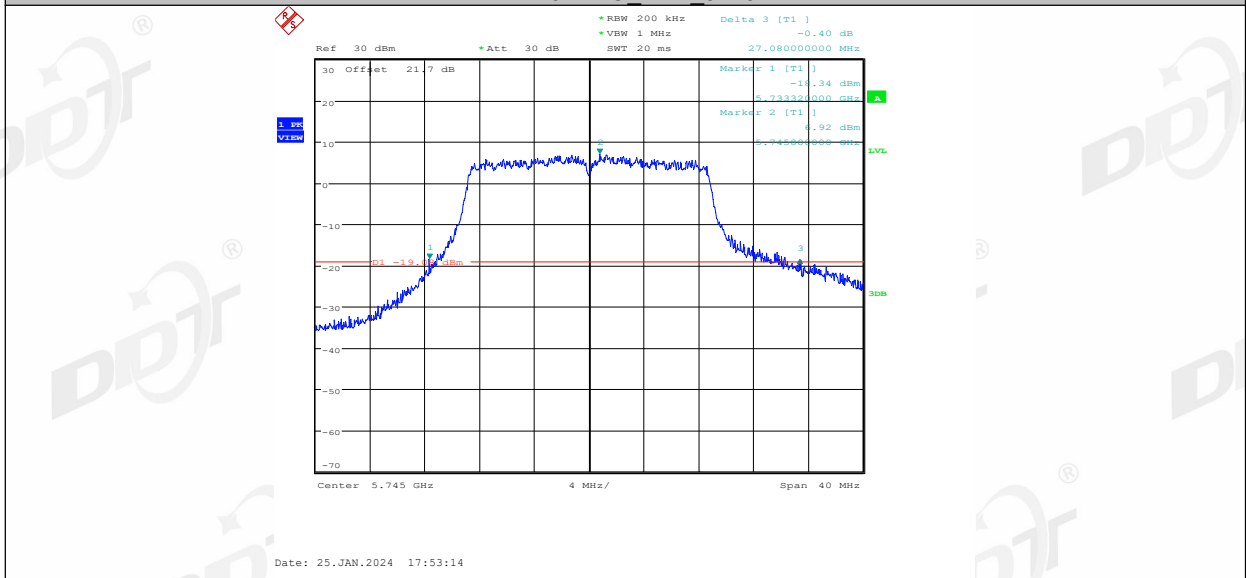

11N20MIMO_Ant2_5745

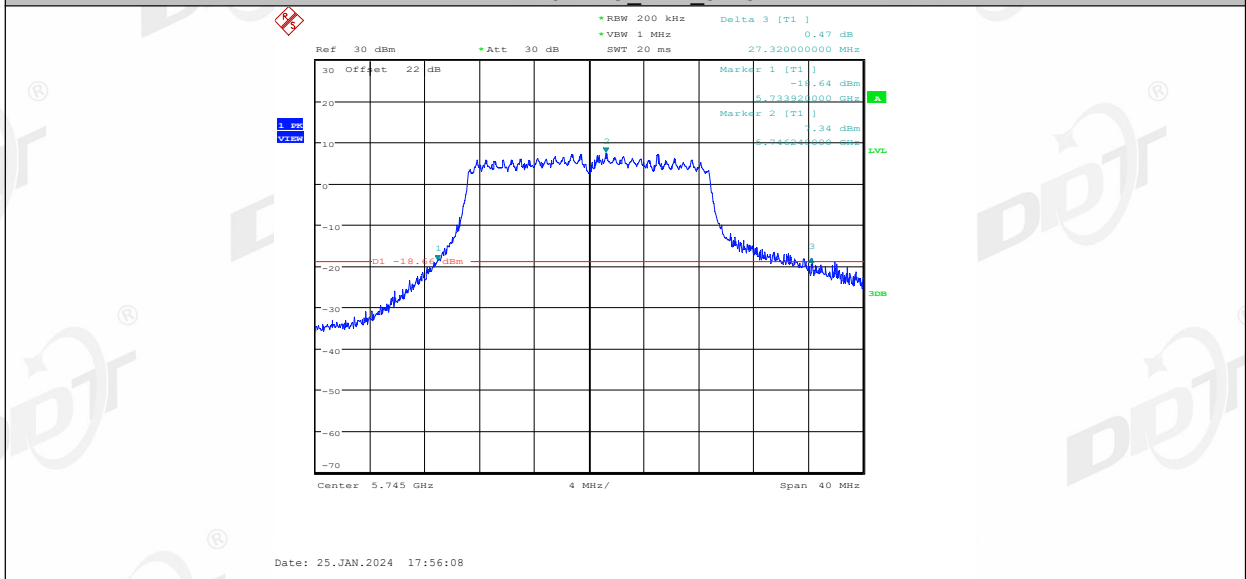

11N20MIMO_Ant1_5785

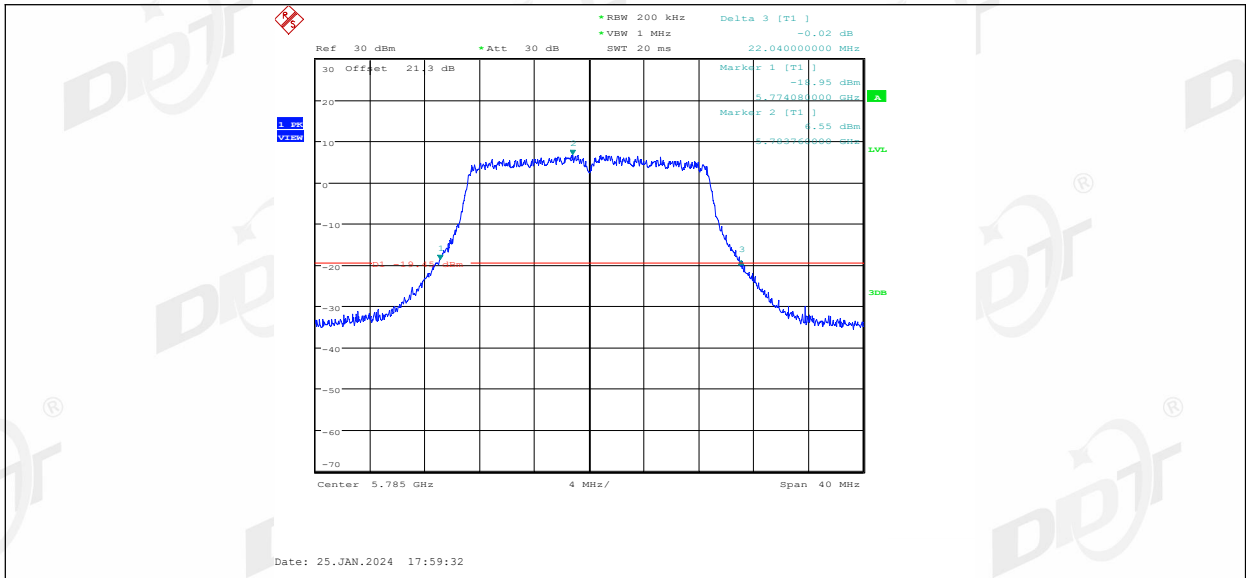

11N20MIMO_Ant2_5785

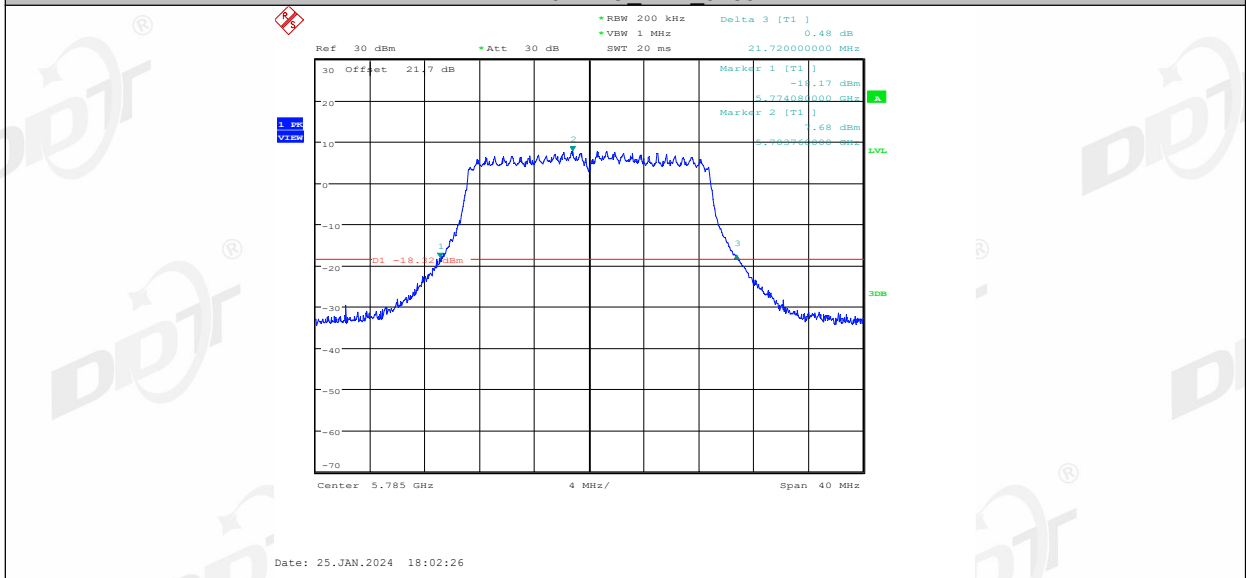

11N20MIMO_Ant1_5825

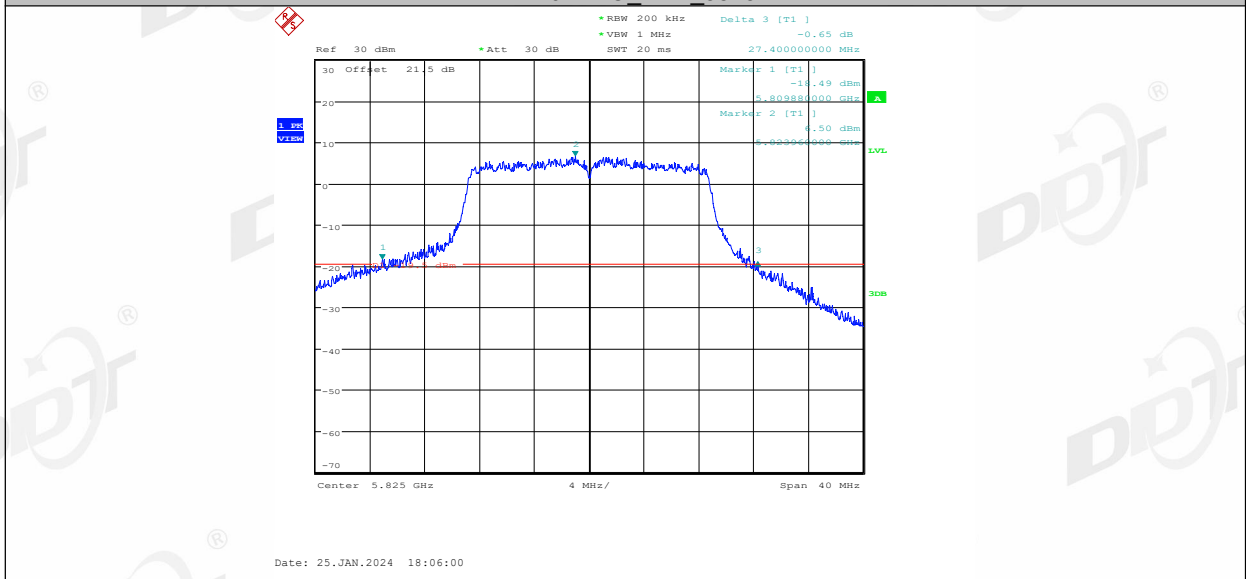

11N20MIMO_Ant2_5825

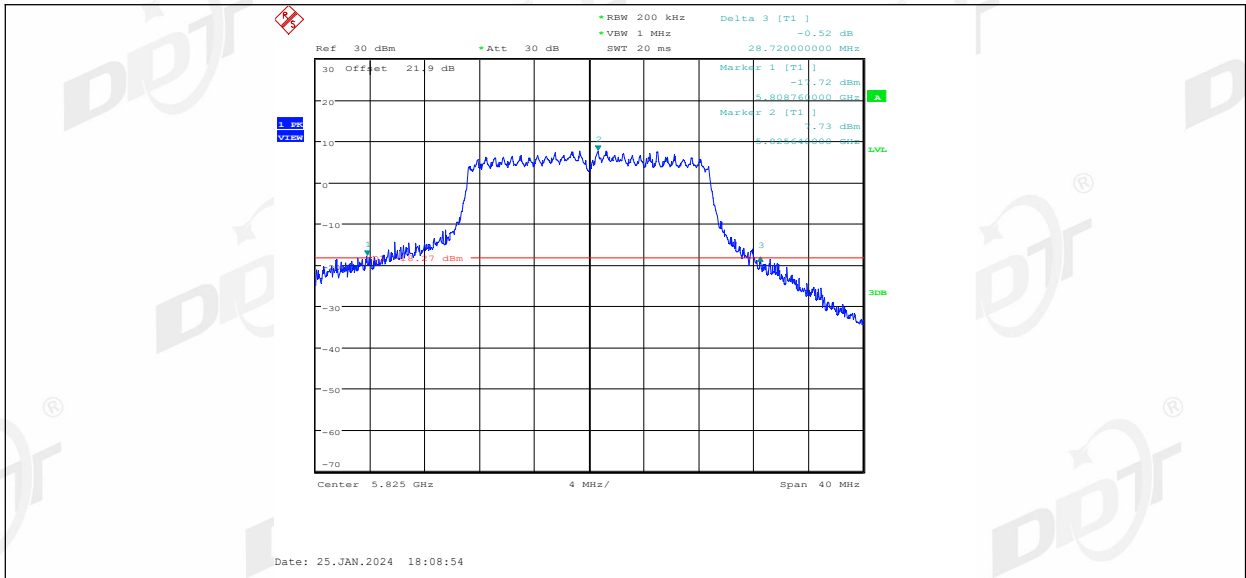

11N40MIMO_Ant1_5190

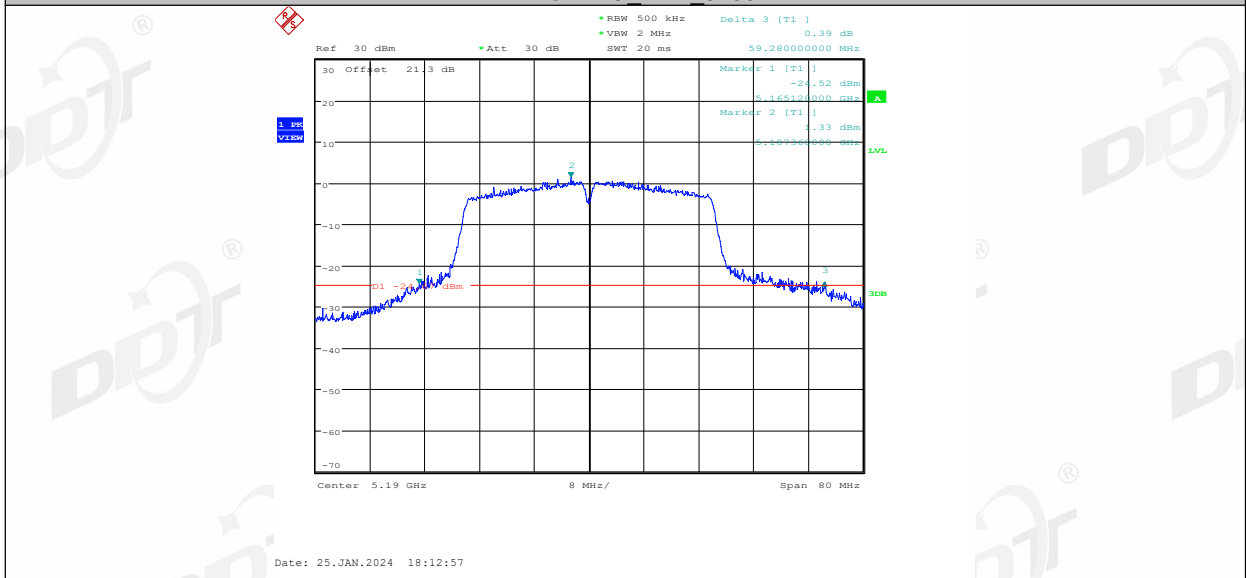

11N40MIMO_Ant2_5190

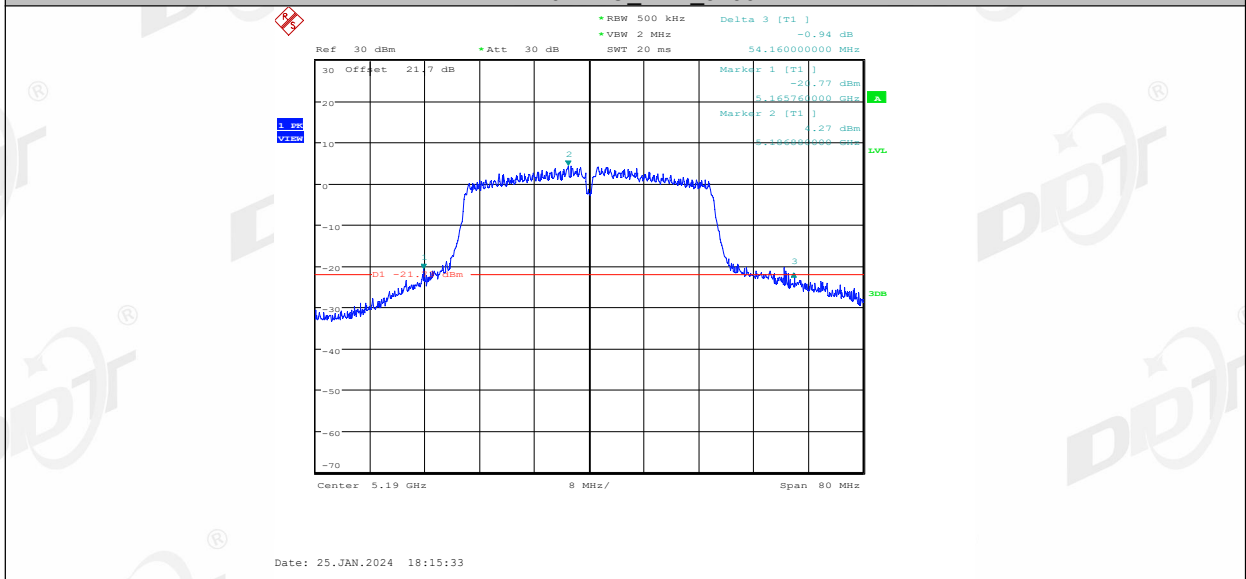

11N40MIMO_Ant1_5230

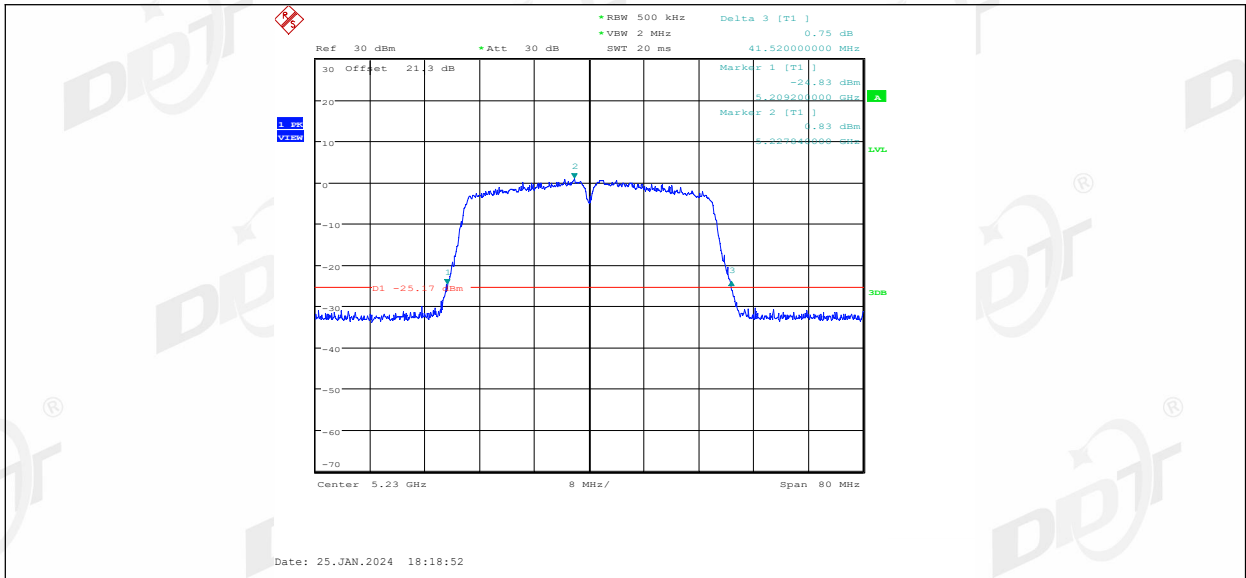

11N40MIMO_Ant2_5230

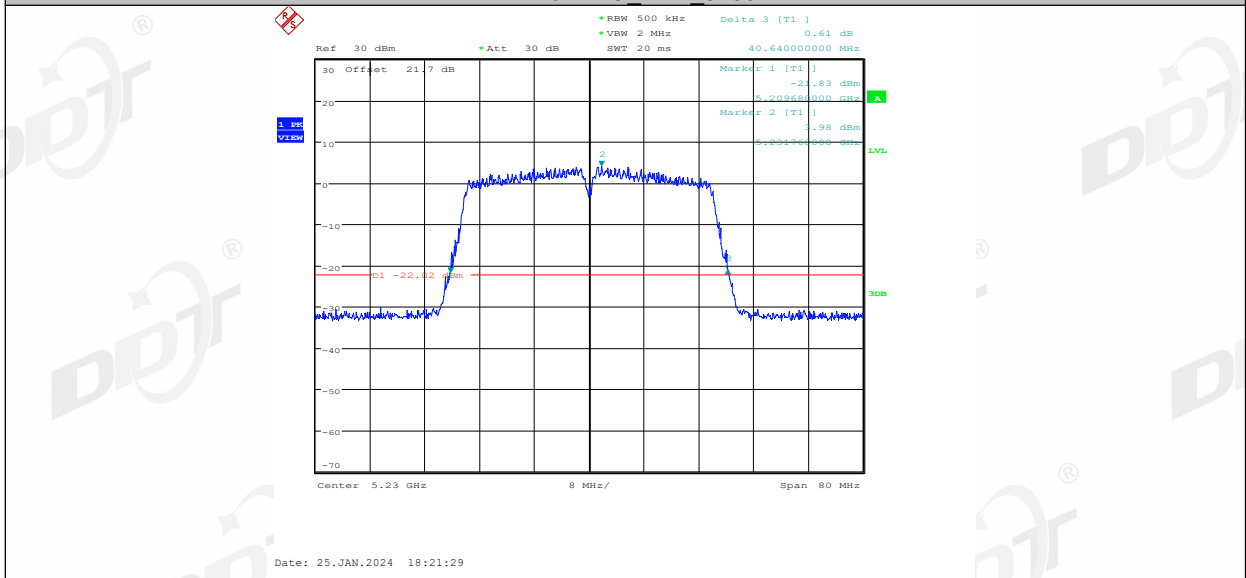

11N40MIMO_Ant1_5270

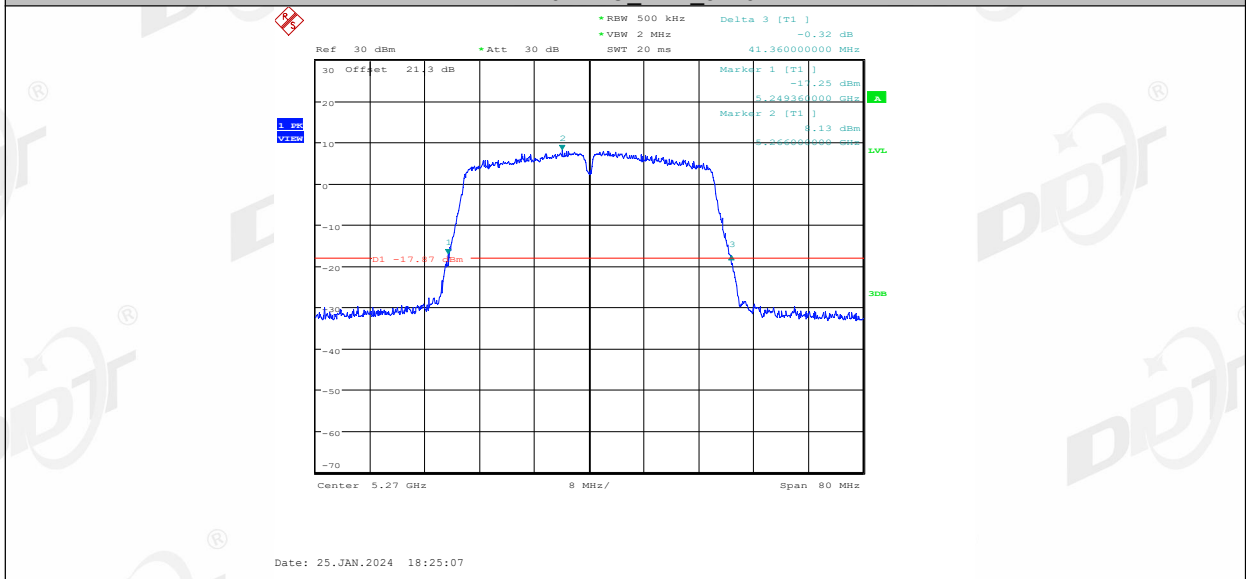

11N40MIMO_Ant2_5270

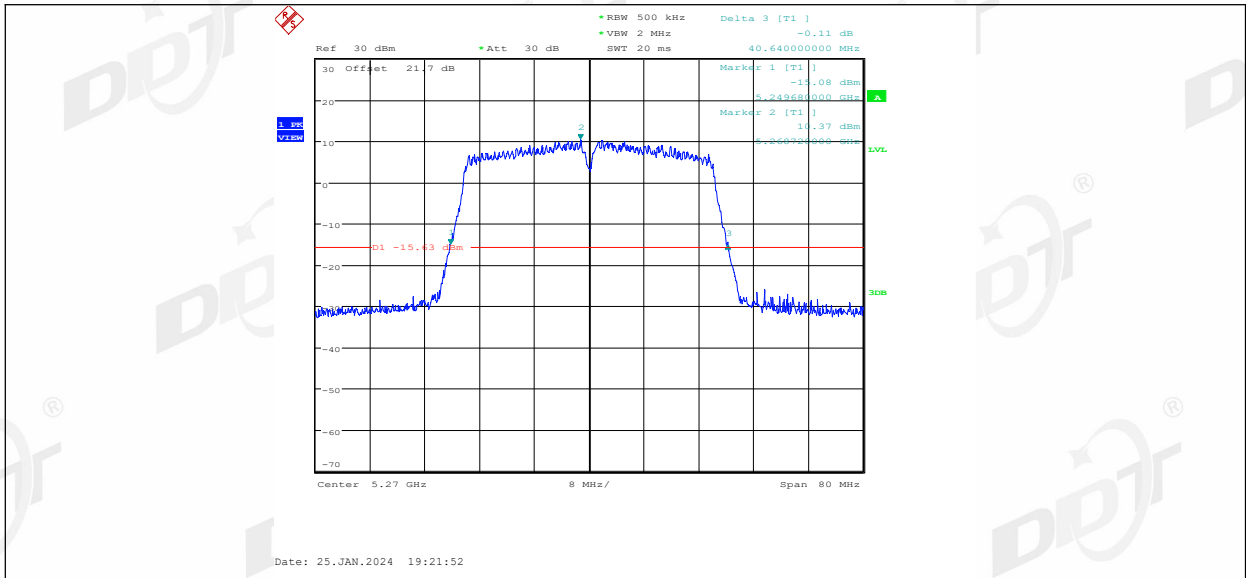

11N40MIMO_Ant1_5310

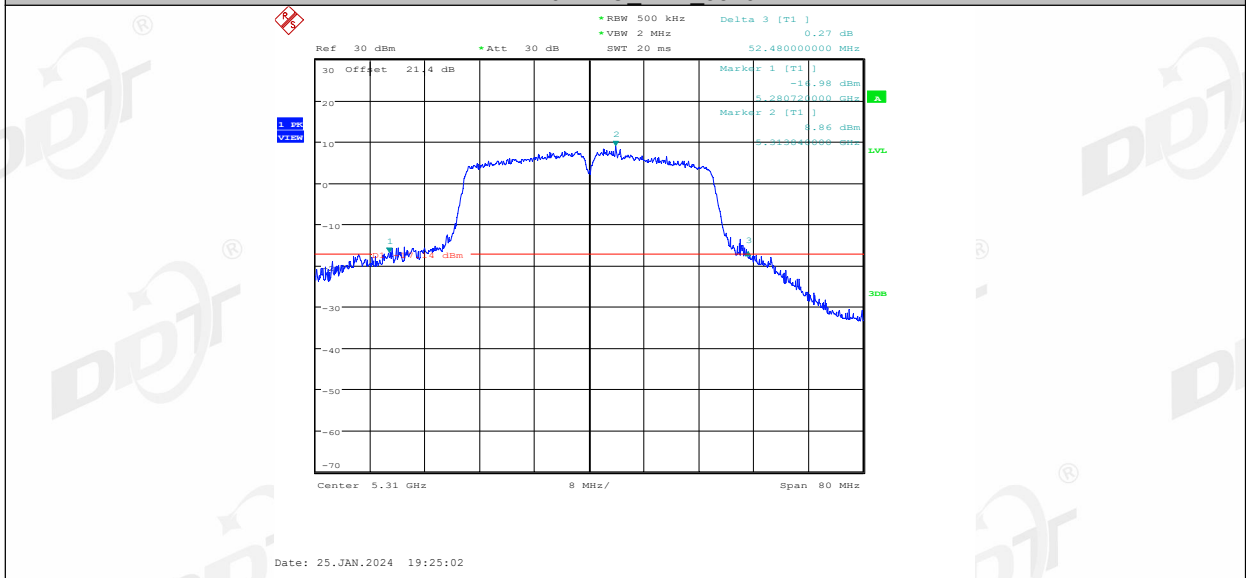

11N40MIMO_Ant2_5310

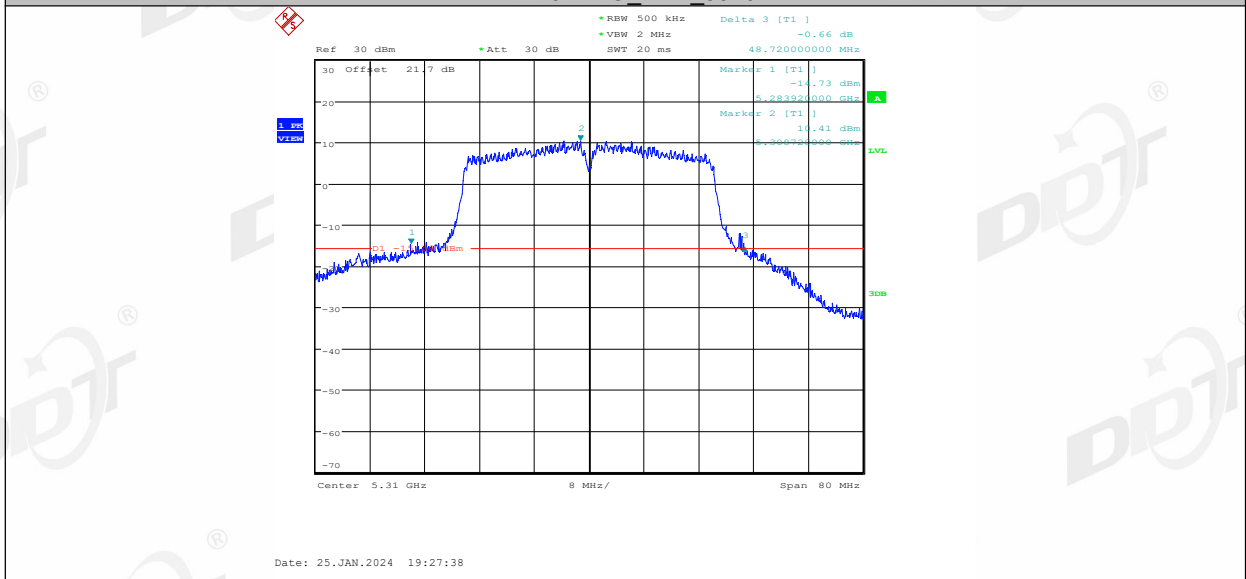

11N40MIMO_Ant1_5510

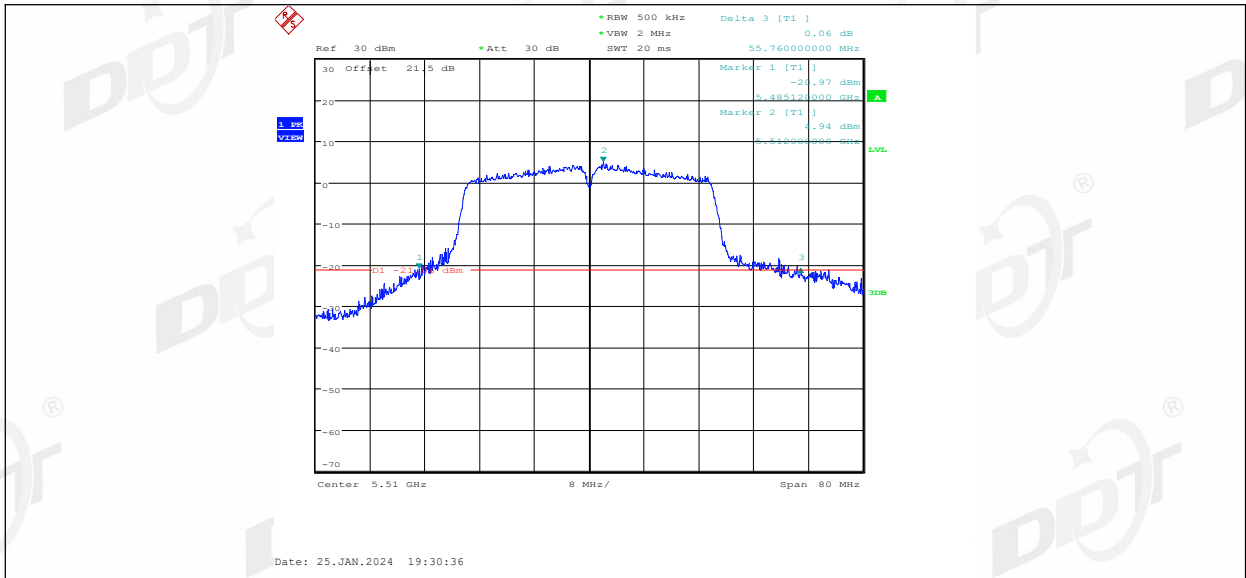

11N40MIMO_Ant2_5510

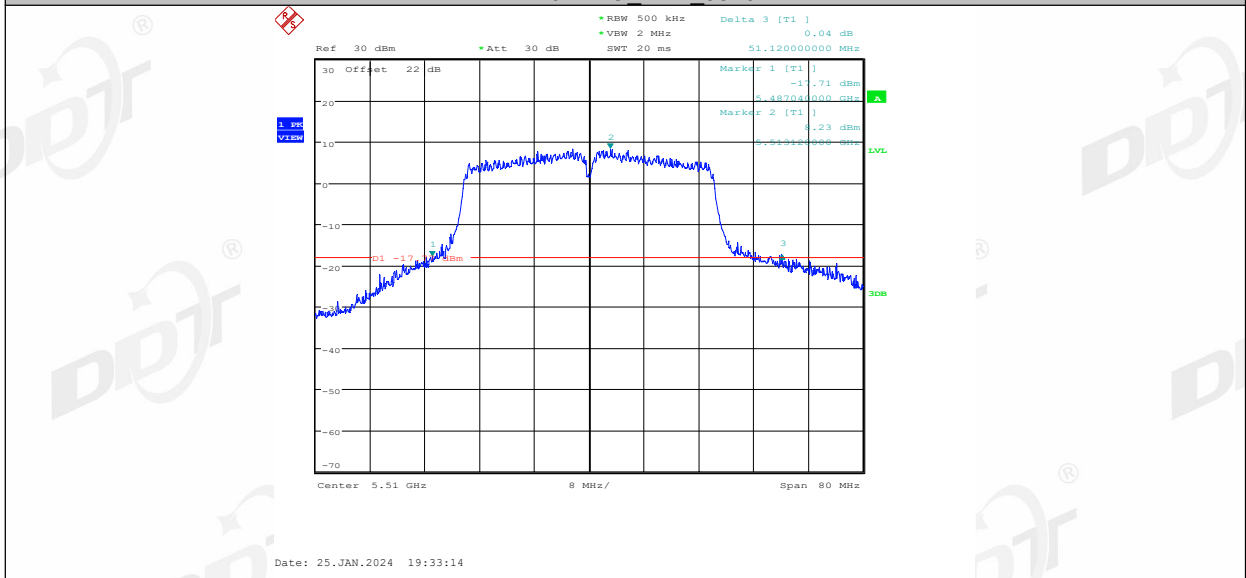

11N40MIMO_Ant1_5550

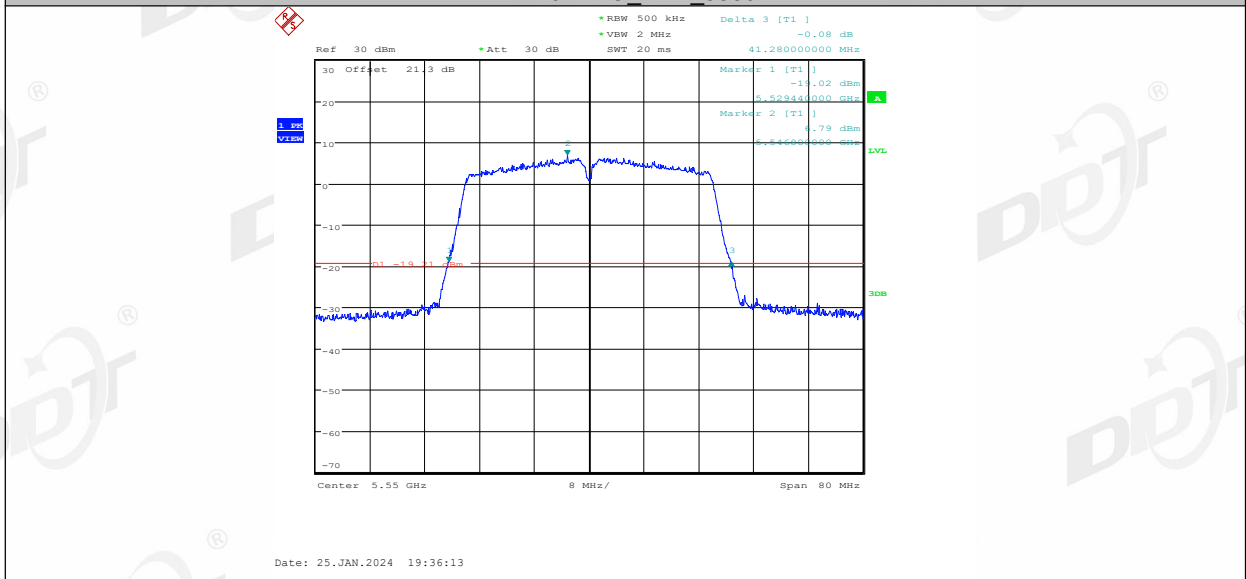

11N40MIMO_Ant2_5550

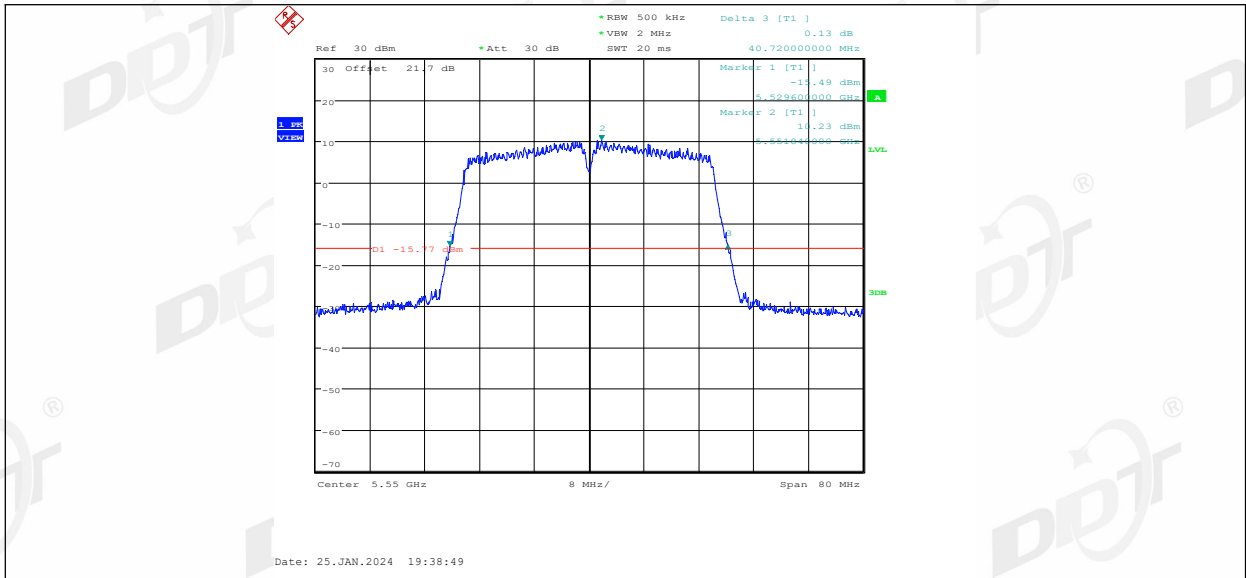

11N40MIMO_Ant1_5670

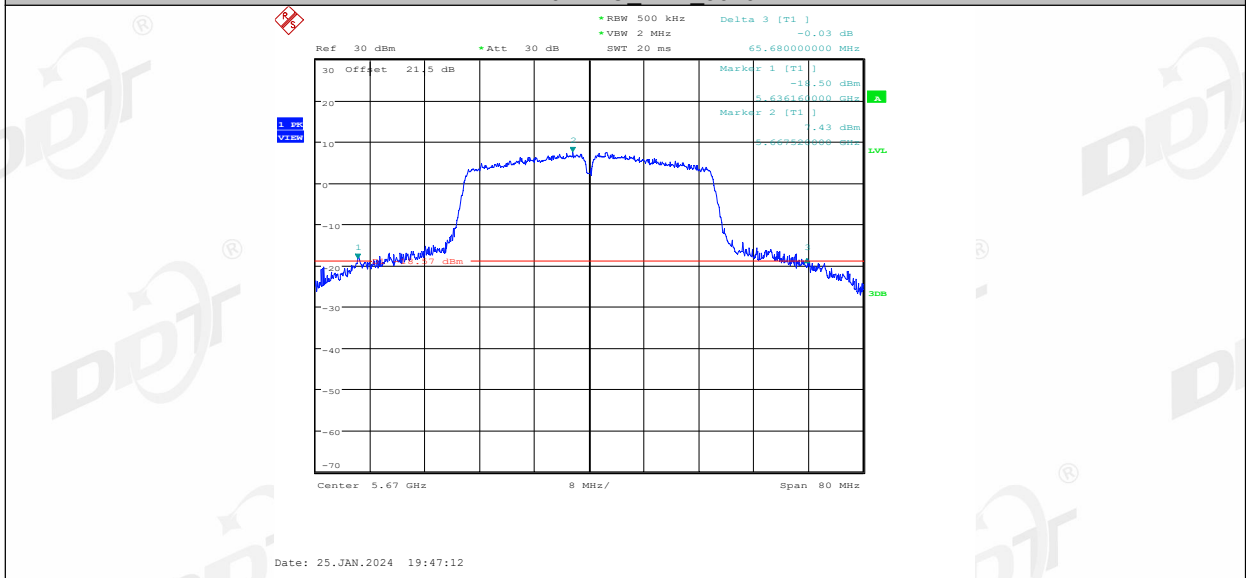

11N40MIMO_Ant2_5670

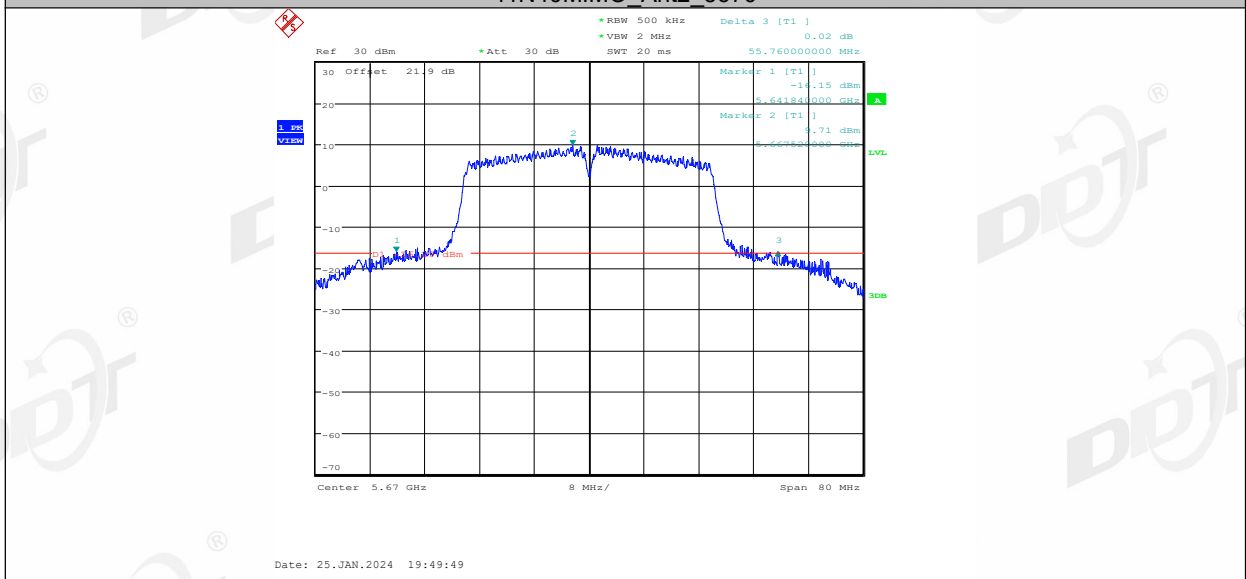

11N40MIMO_Ant1_5710

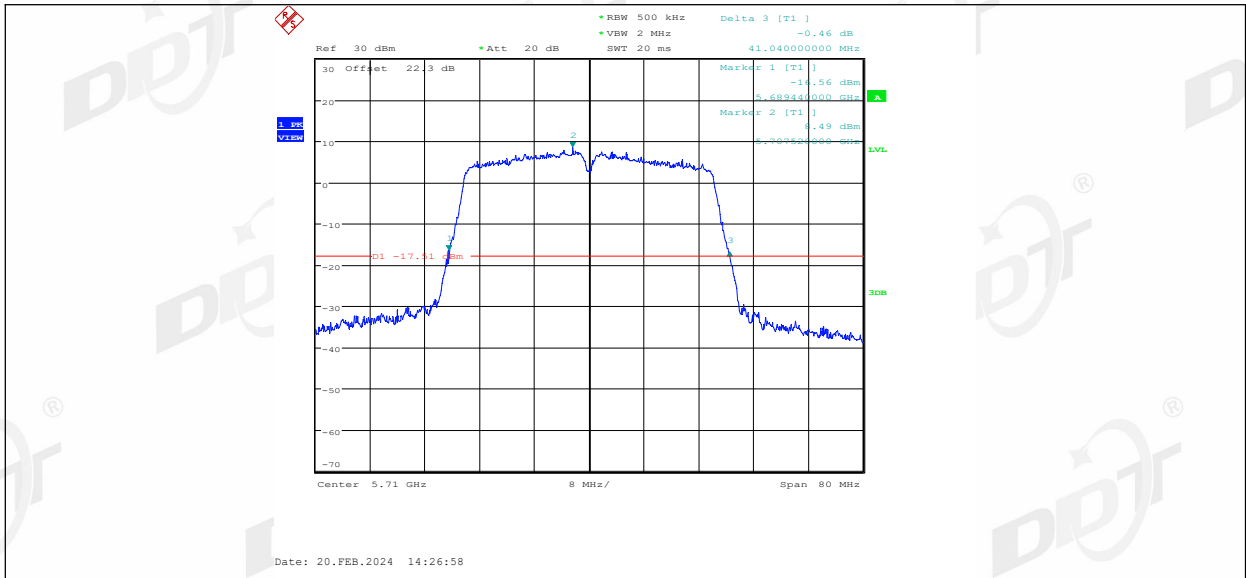

11N40MIMO_Ant2_5710

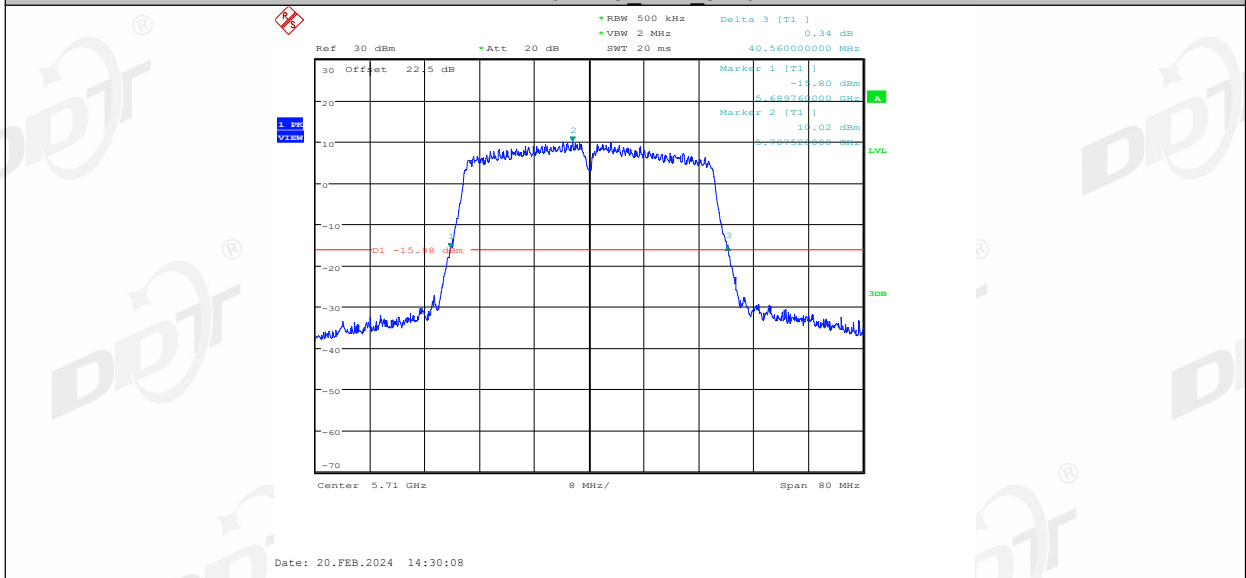

11N40MIMO_Ant1_5755

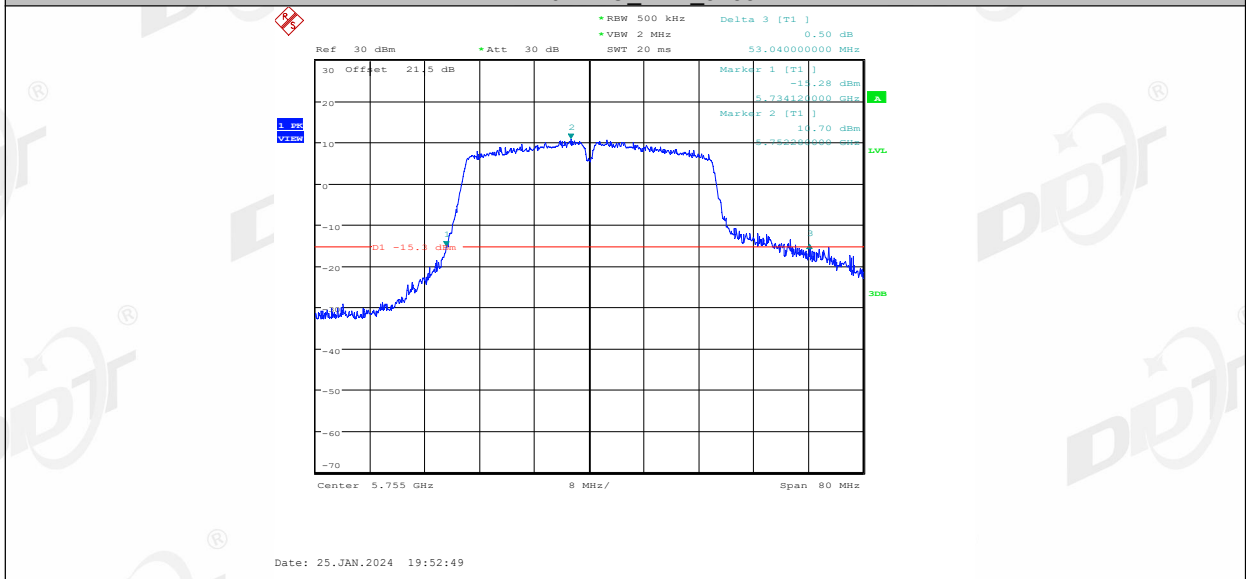

11N40MIMO_Ant2_5755

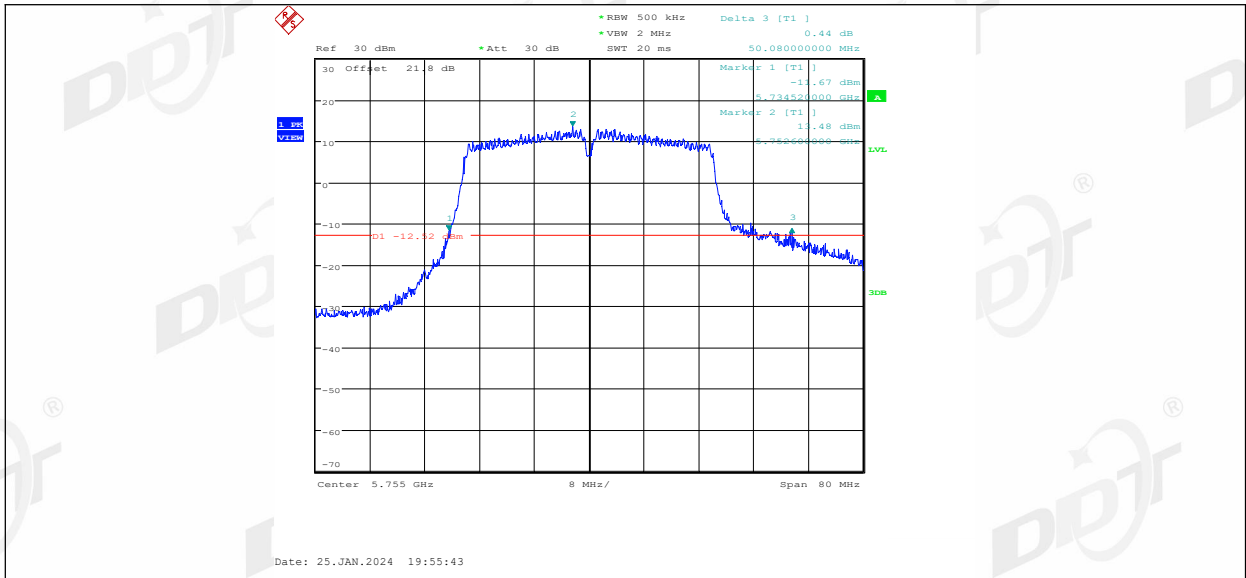

11N40MIMO_Ant1_5795

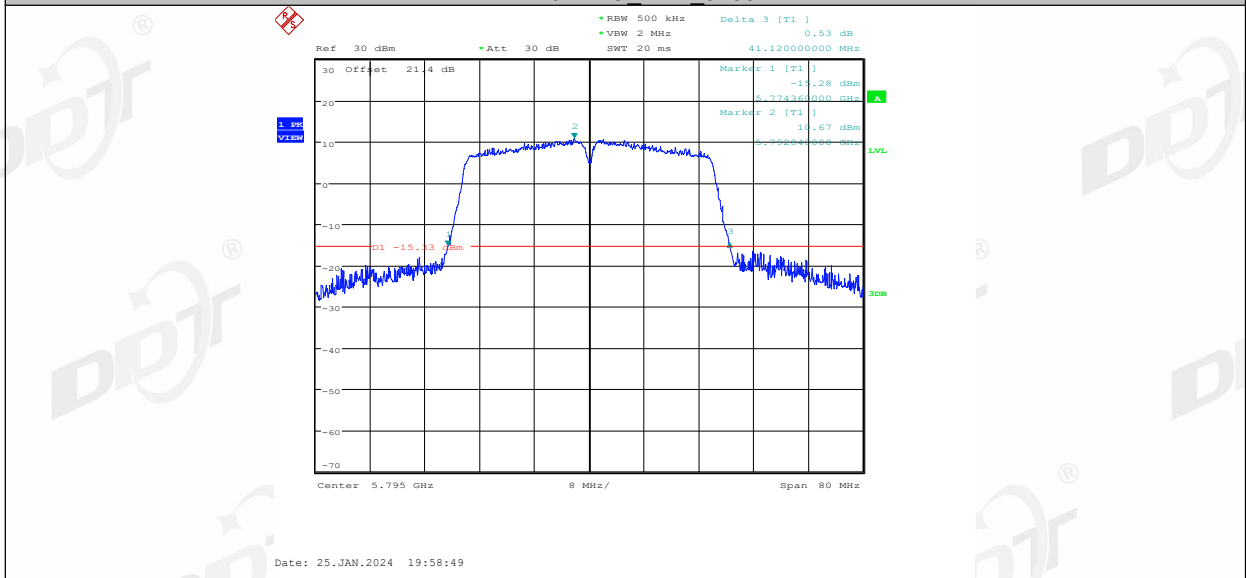

11N40MIMO_Ant2_5795

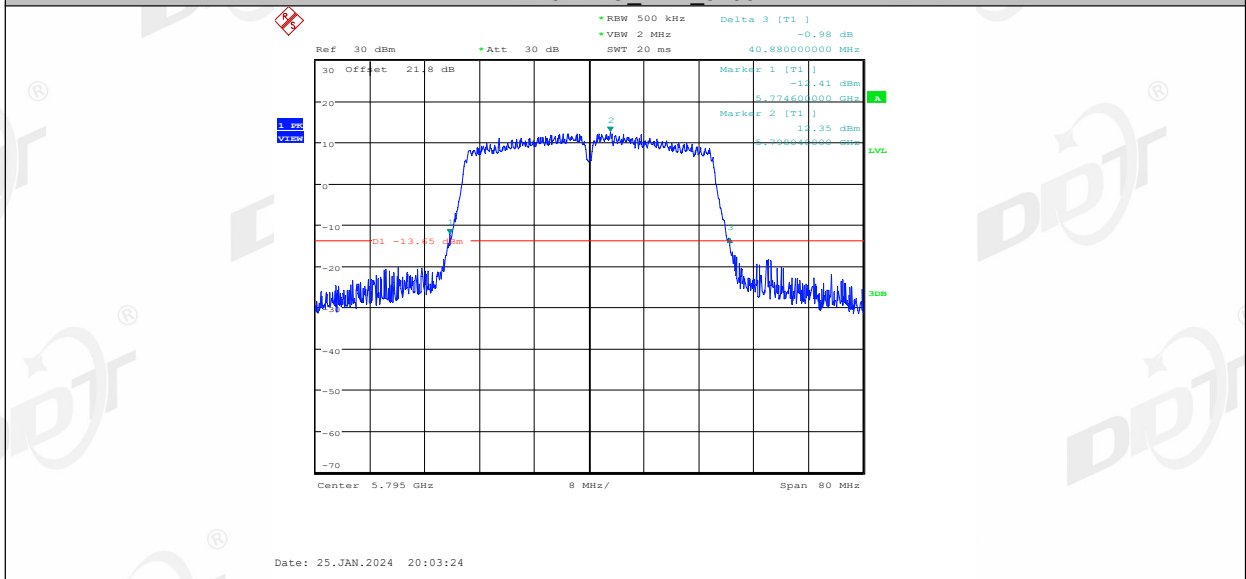

11AC20MIMO_Ant1_5180

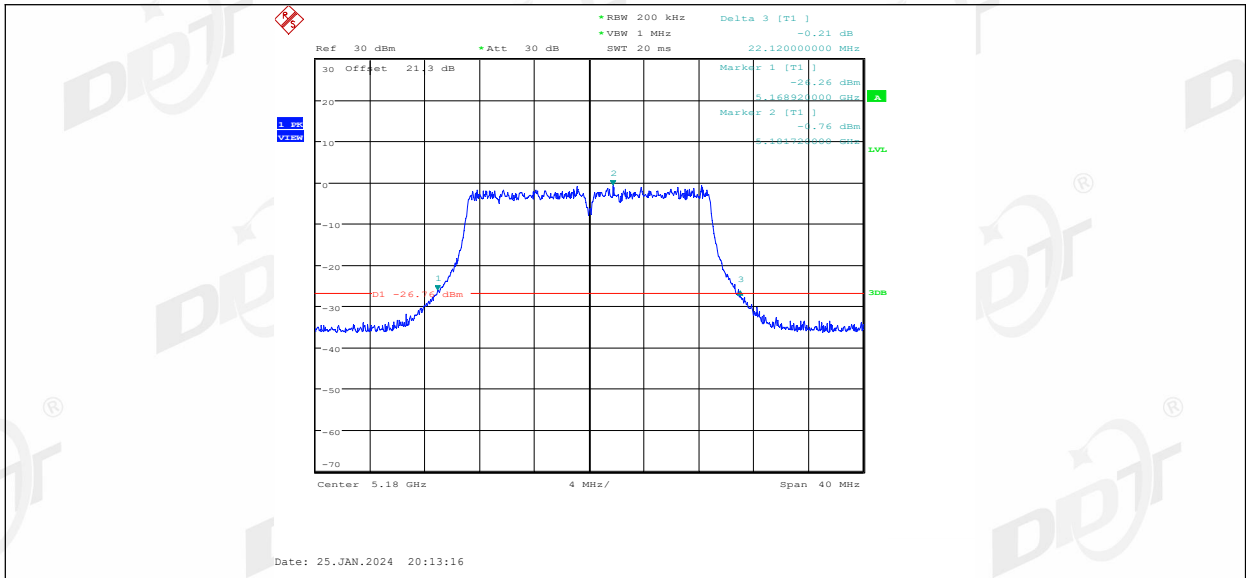

11AC20MIMO Ant2 5180

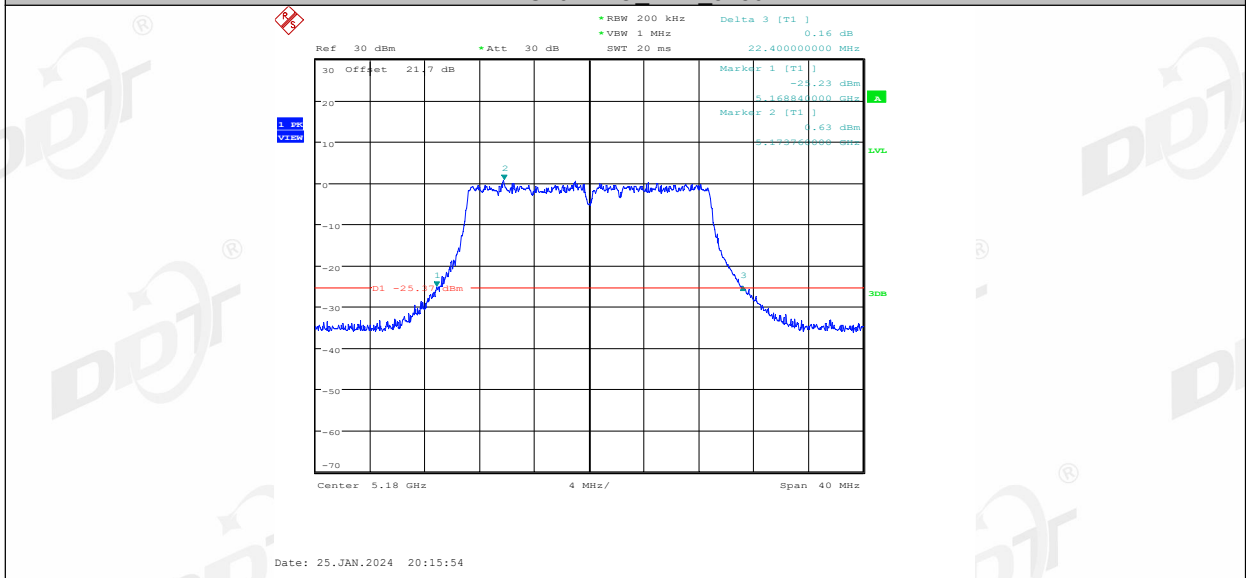

11AC20MIMO Ant1 5200

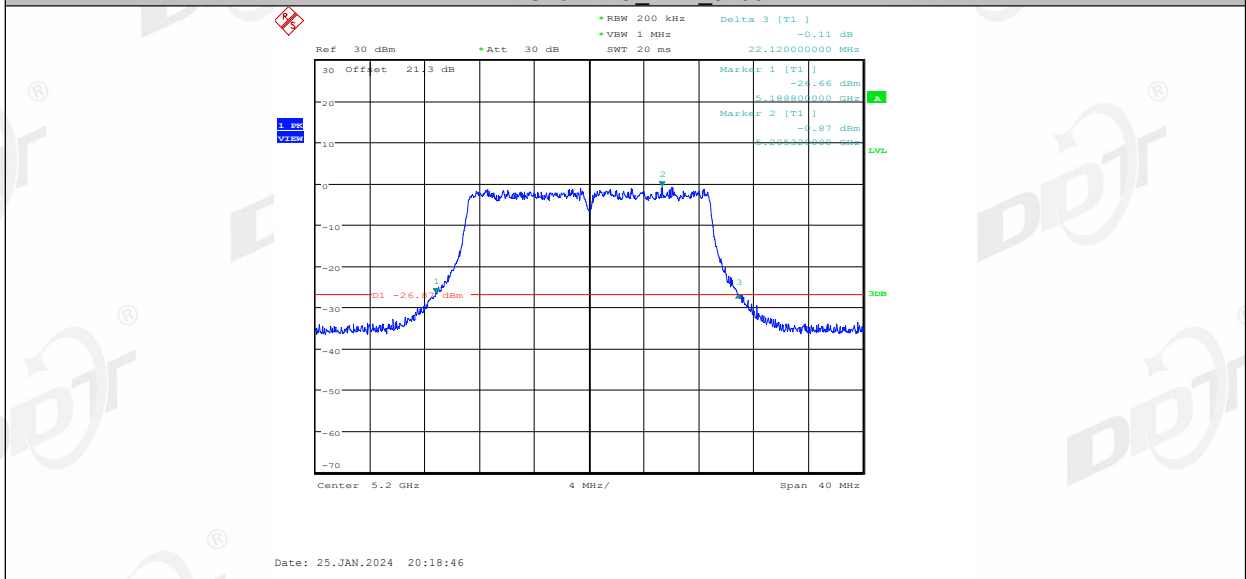

11AC20MIMO Ant2 5200

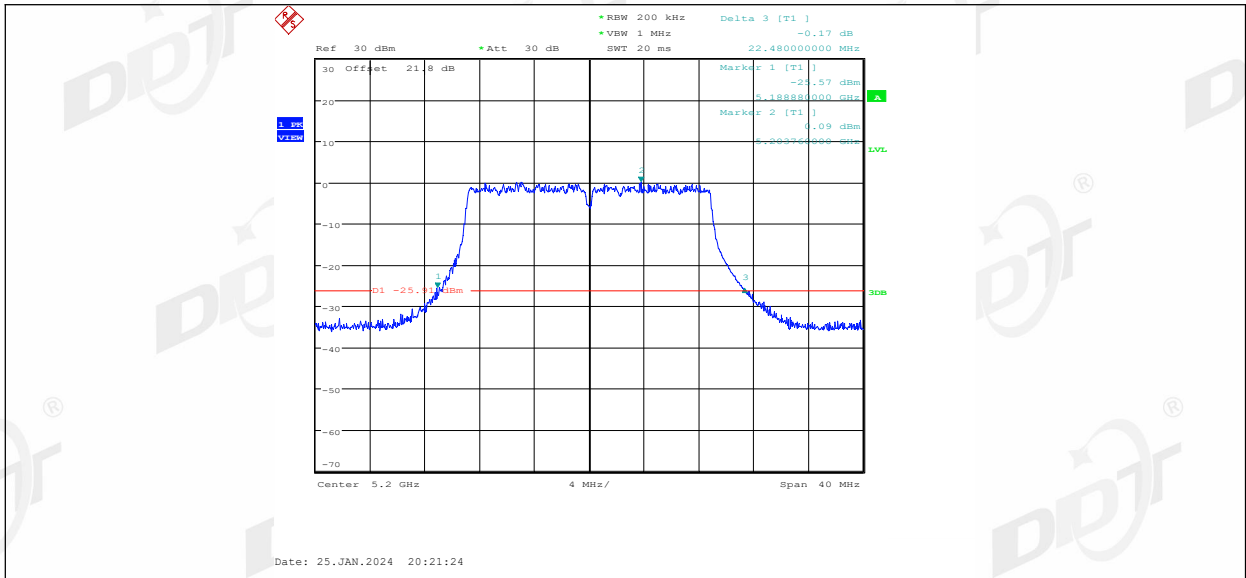

11AC20MIMO Ant1 5240

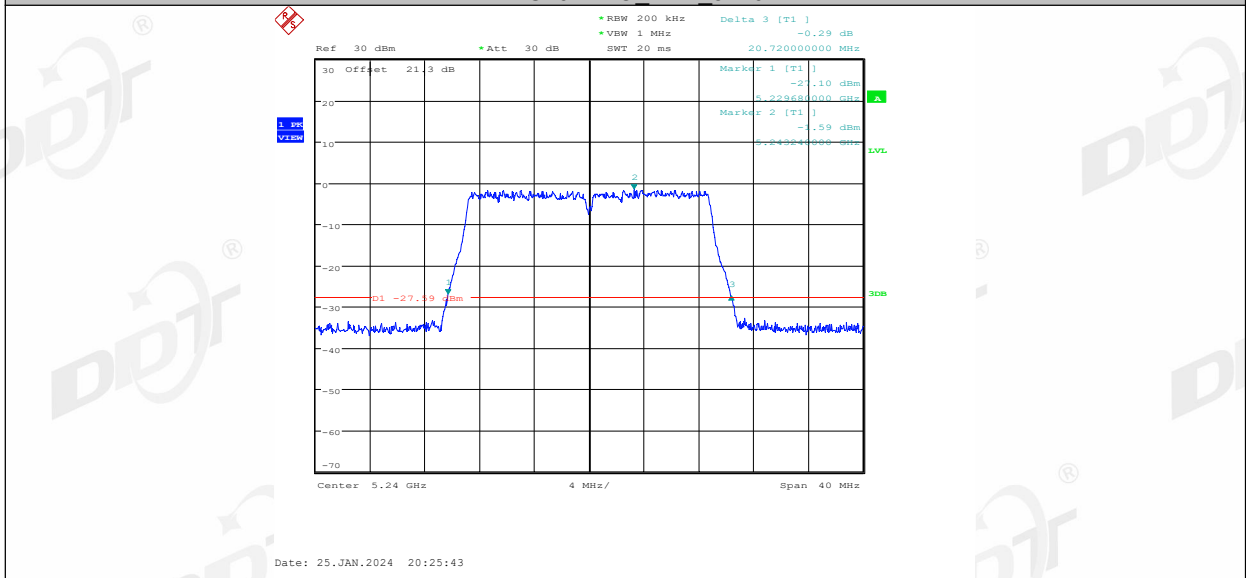

11AC20MIMO Ant2 5240

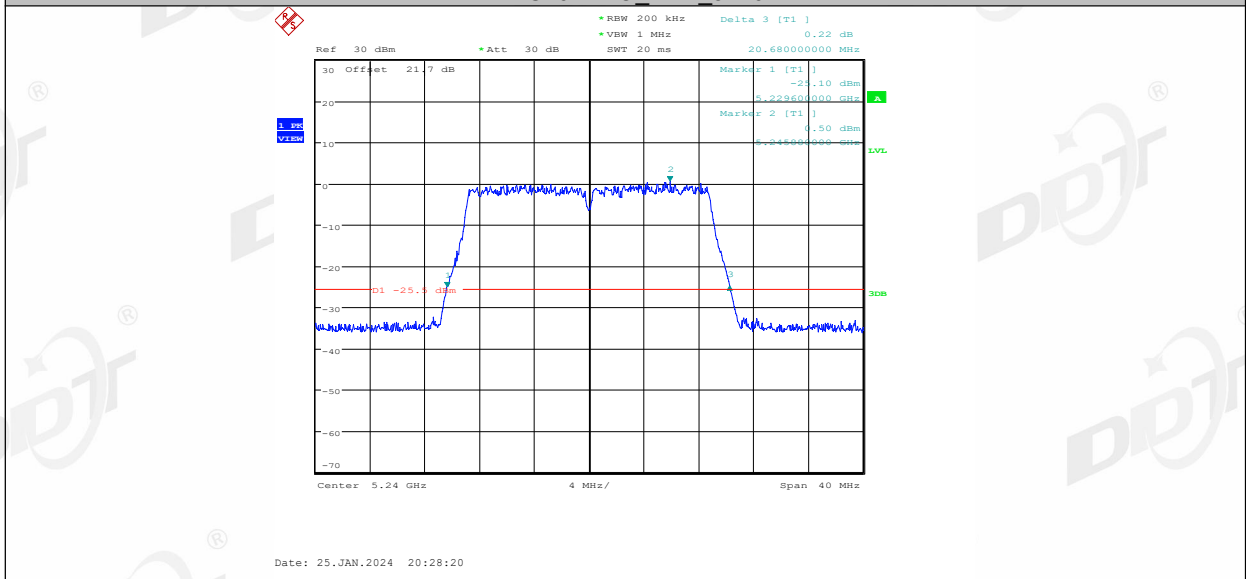

11AC20MIMO Ant1 5260

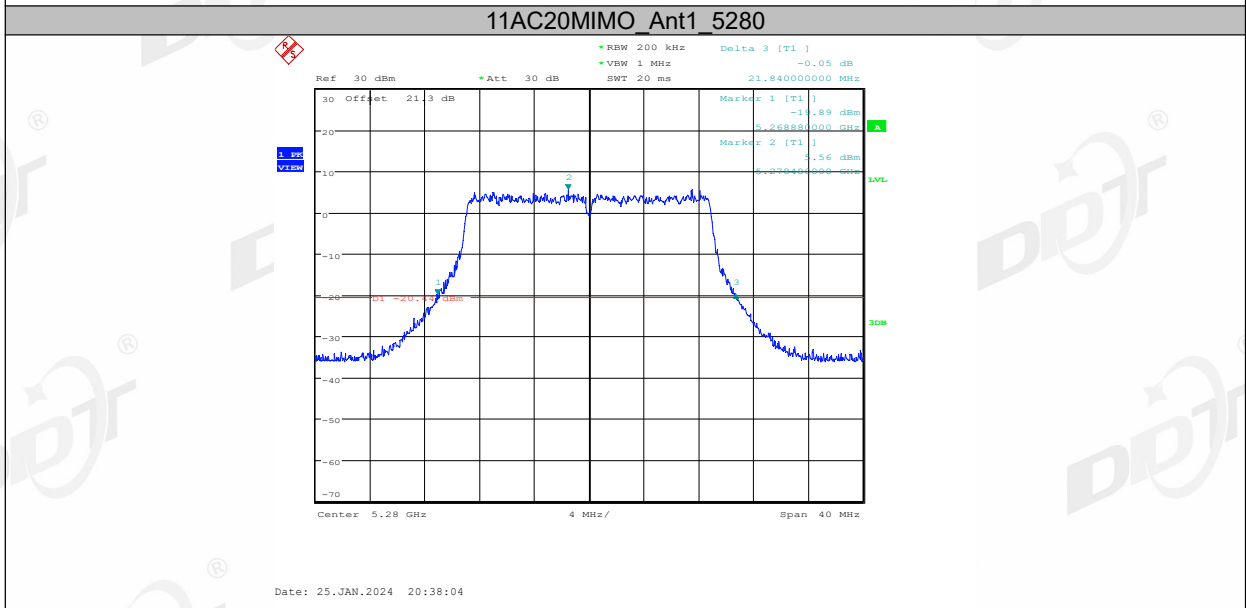
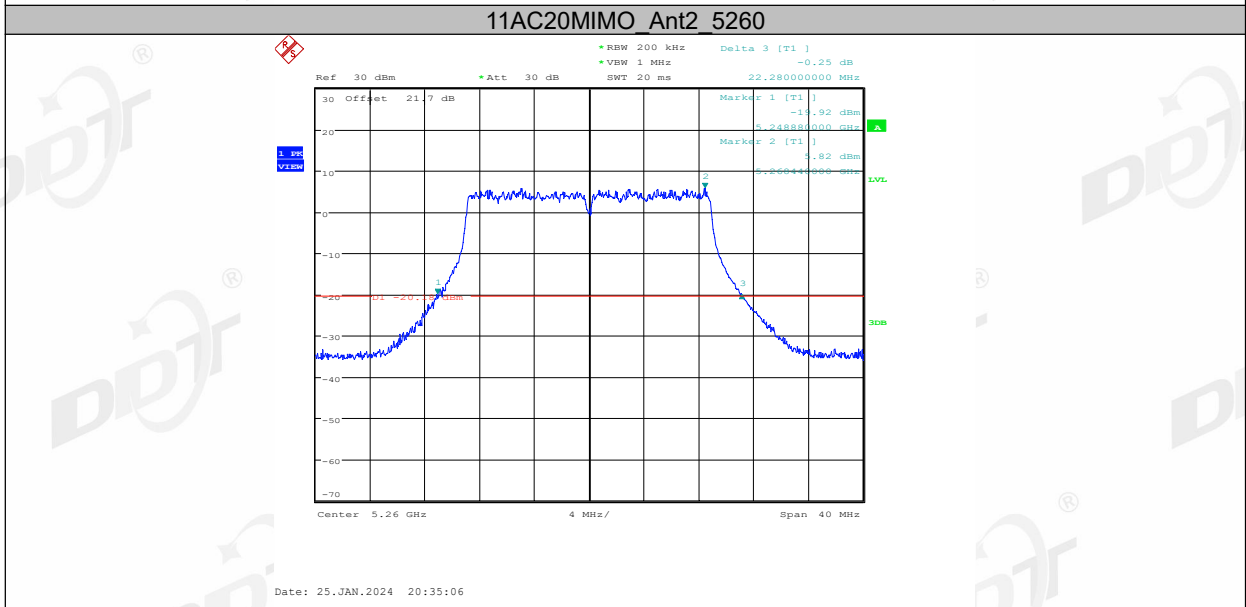
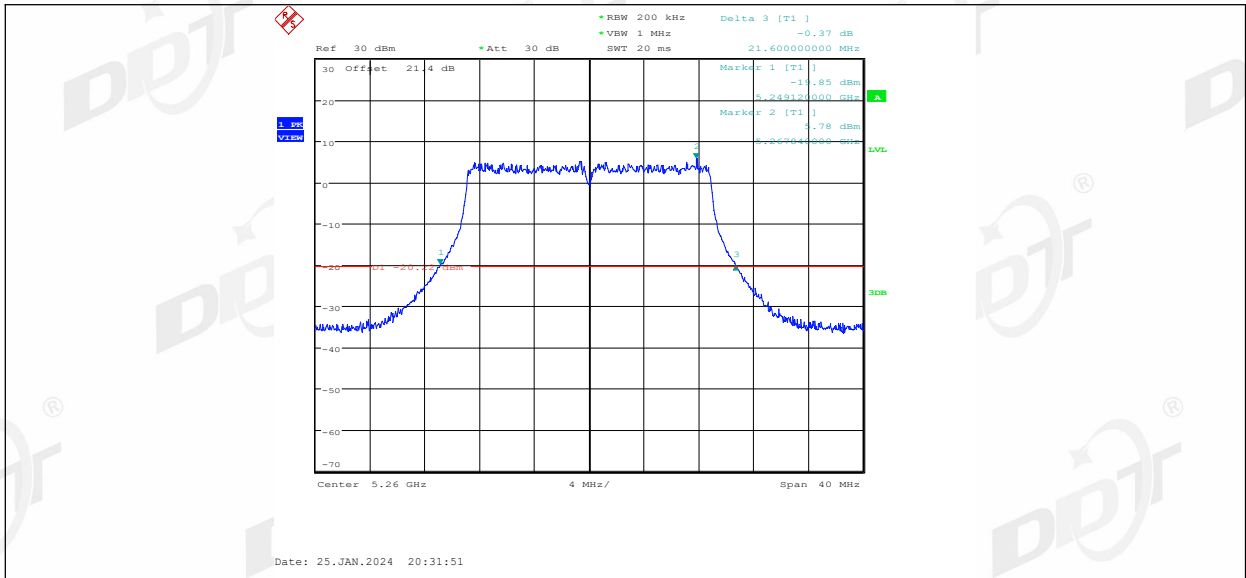

11AC20MIMO Ant2 5280

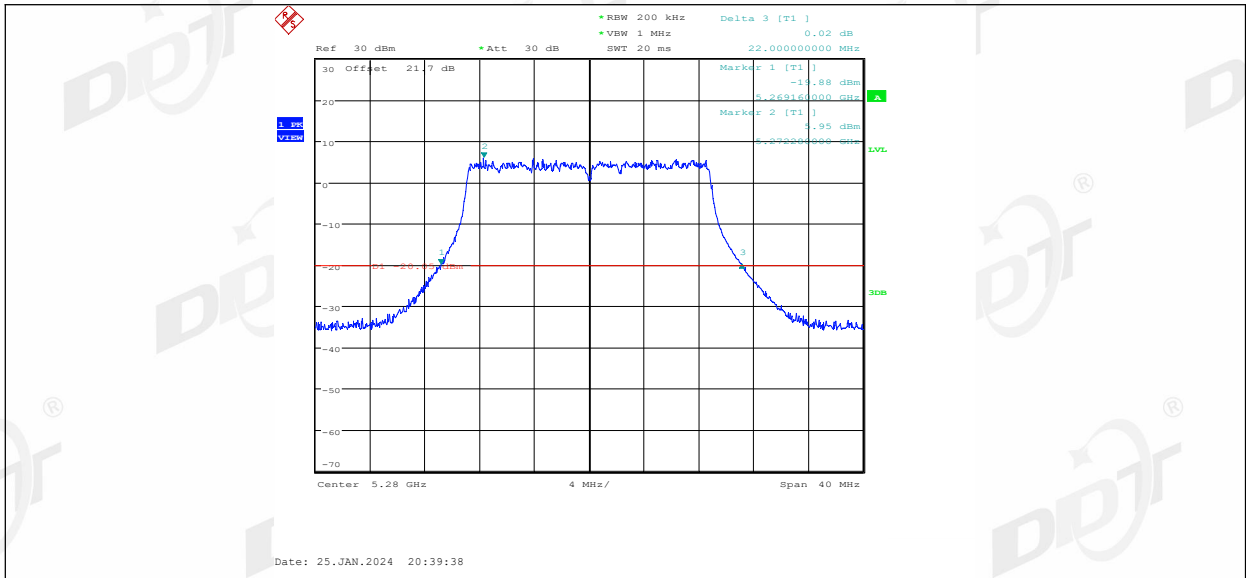

11AC20MIMO Ant1 5320

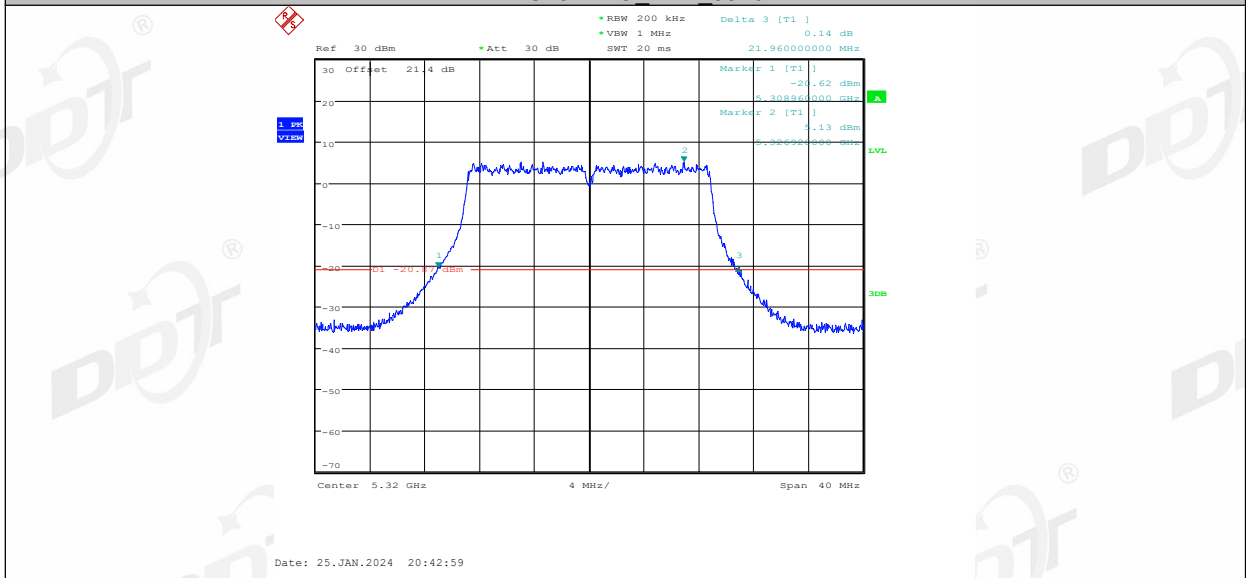

11AC20MIMO Ant2 5320

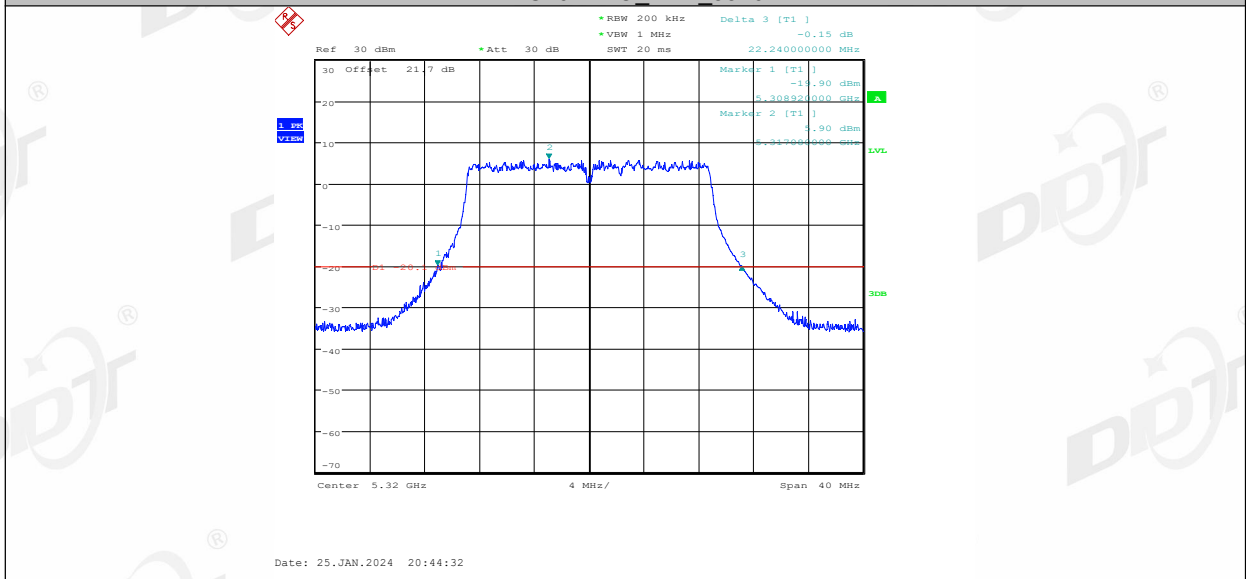

11AC20MIMO Ant1 5500

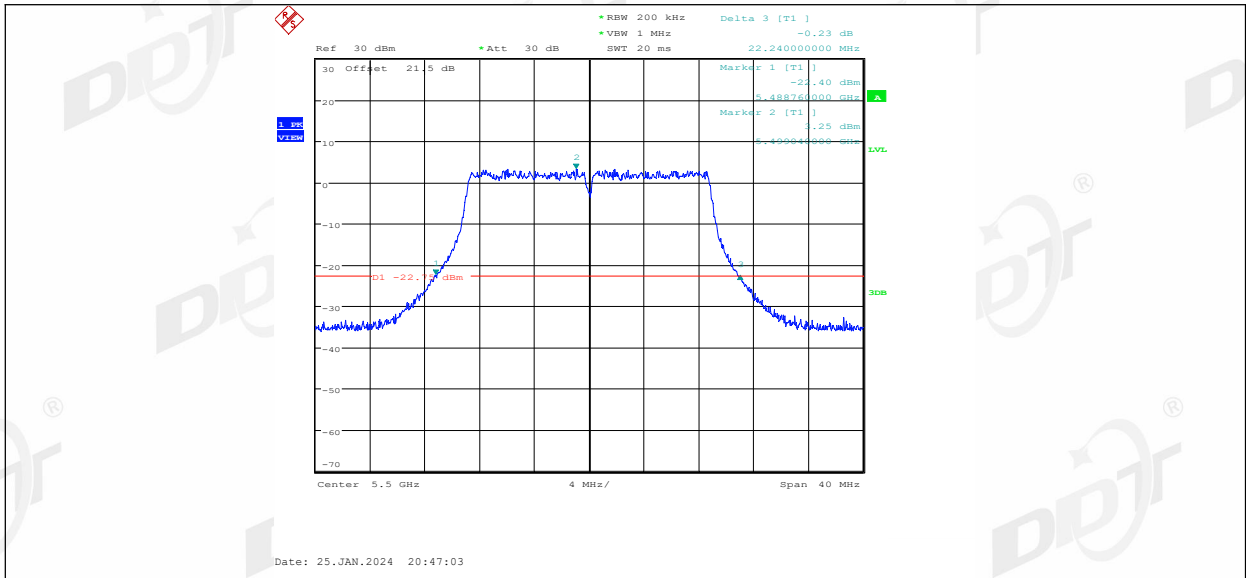

11AC20MIMO Ant2 5500

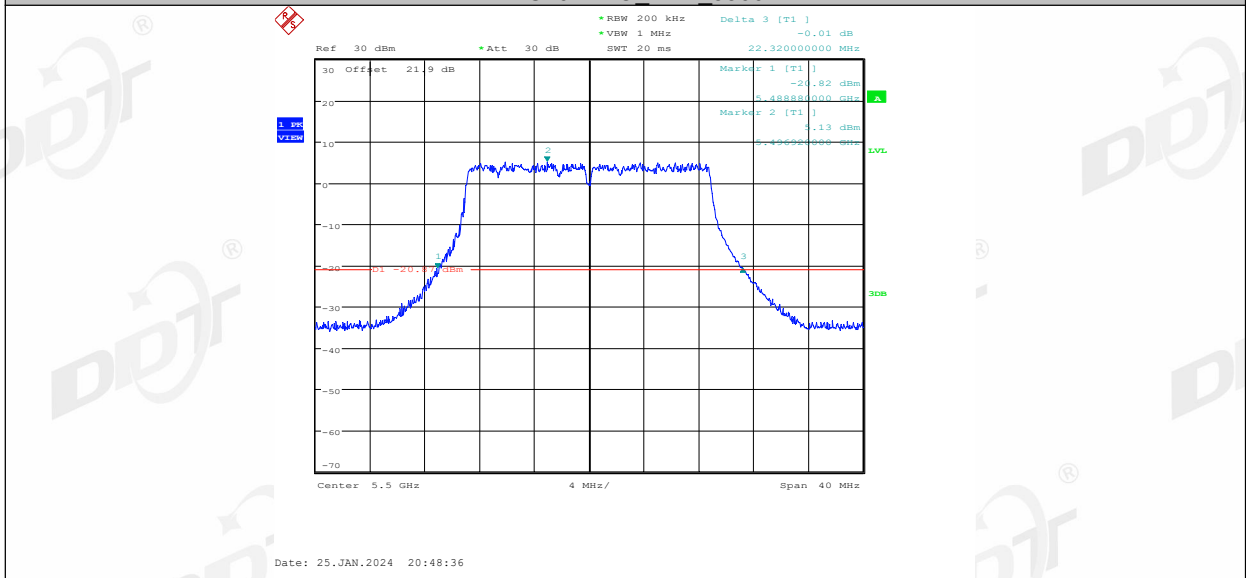

11AC20MIMO Ant1 5580

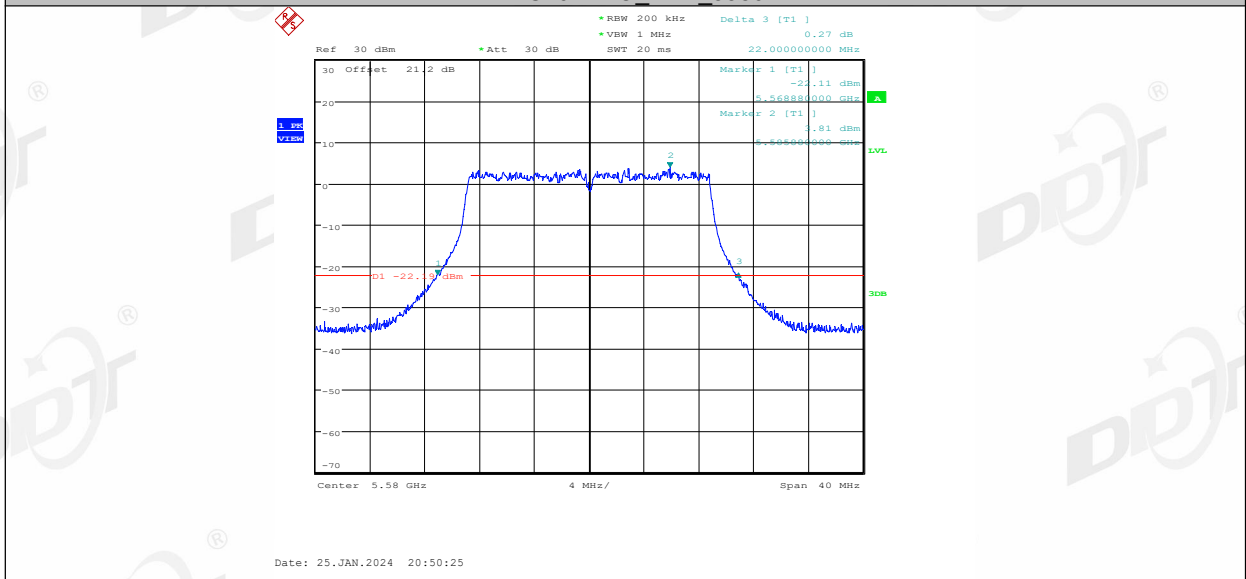

11AC20MIMO Ant2 5580

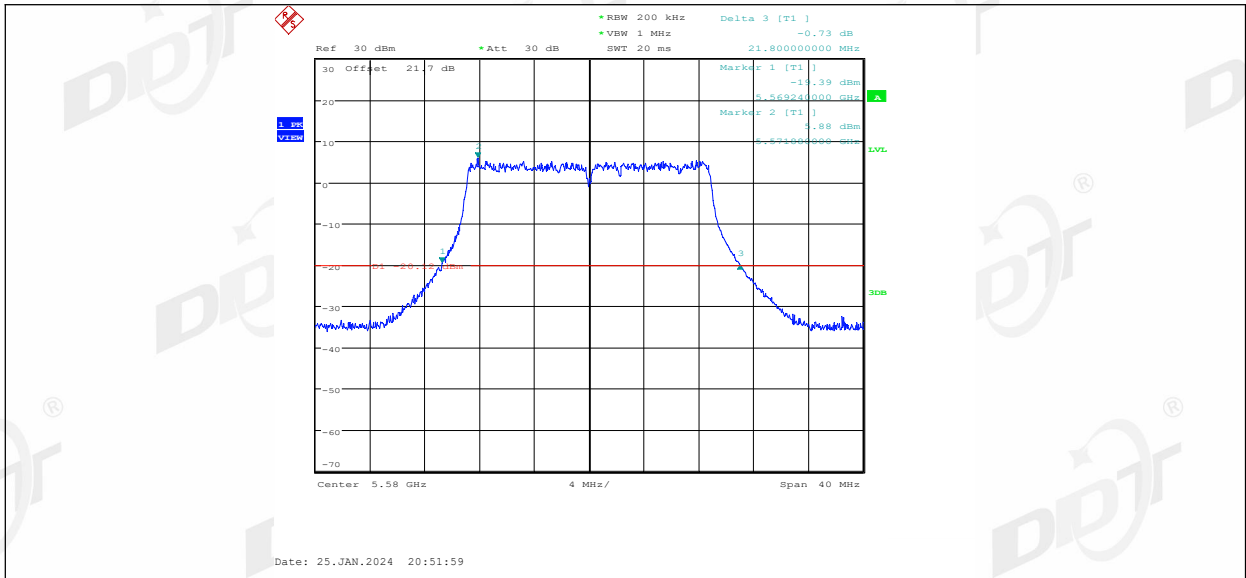

11AC20MIMO Ant1 5700

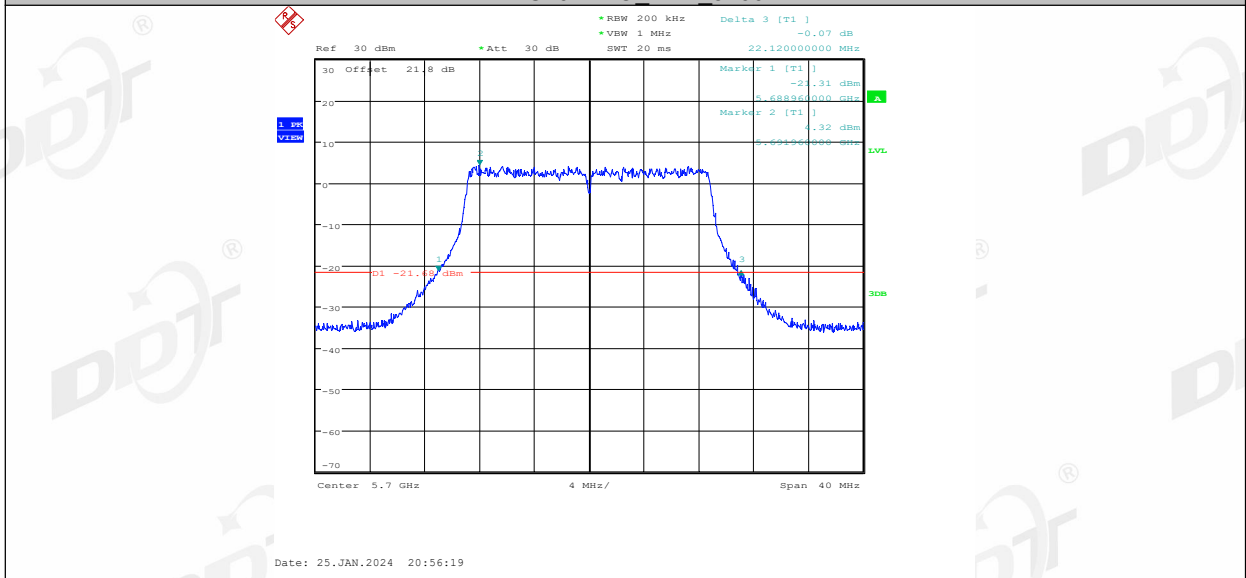

11AC20MIMO Ant2 5700

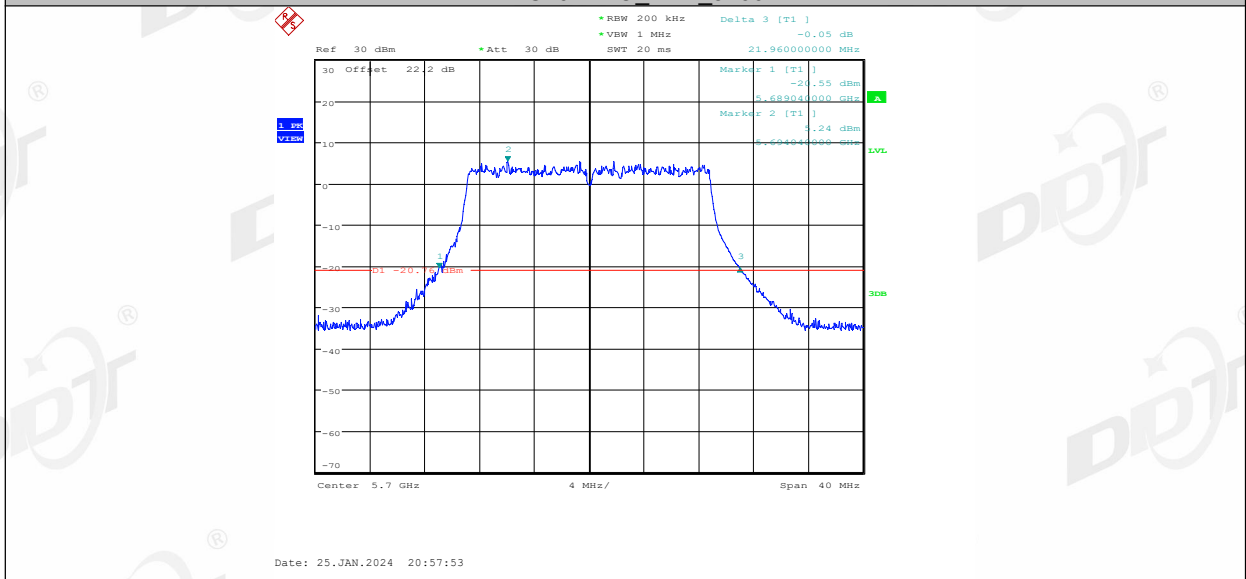

11AC20MIMO Ant1 5720

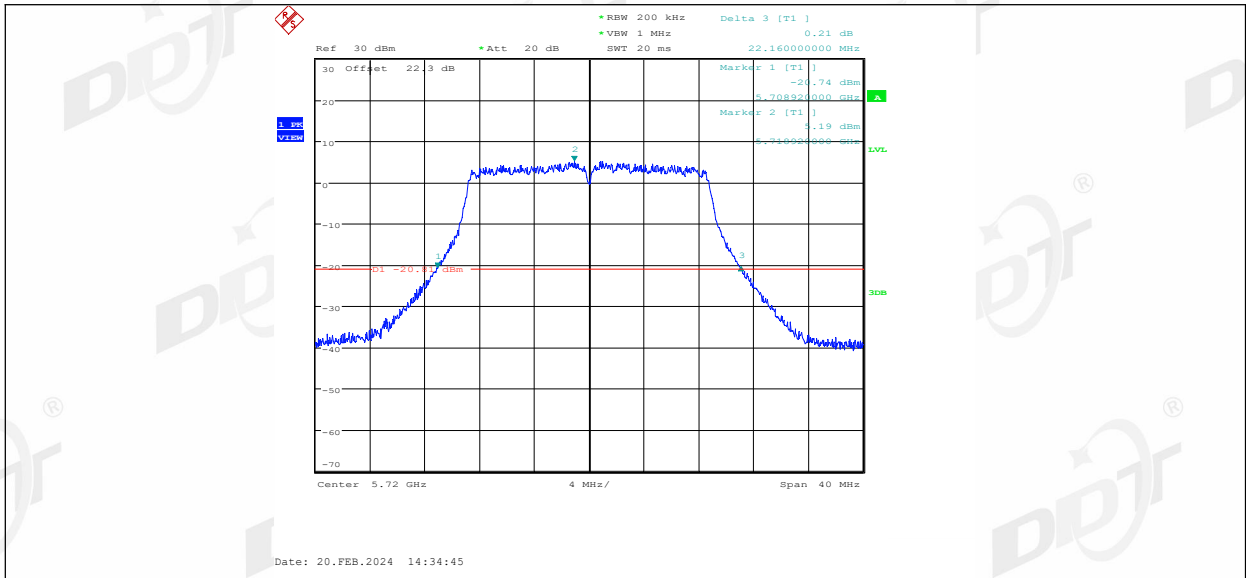

11AC20MIMO Ant2 5720

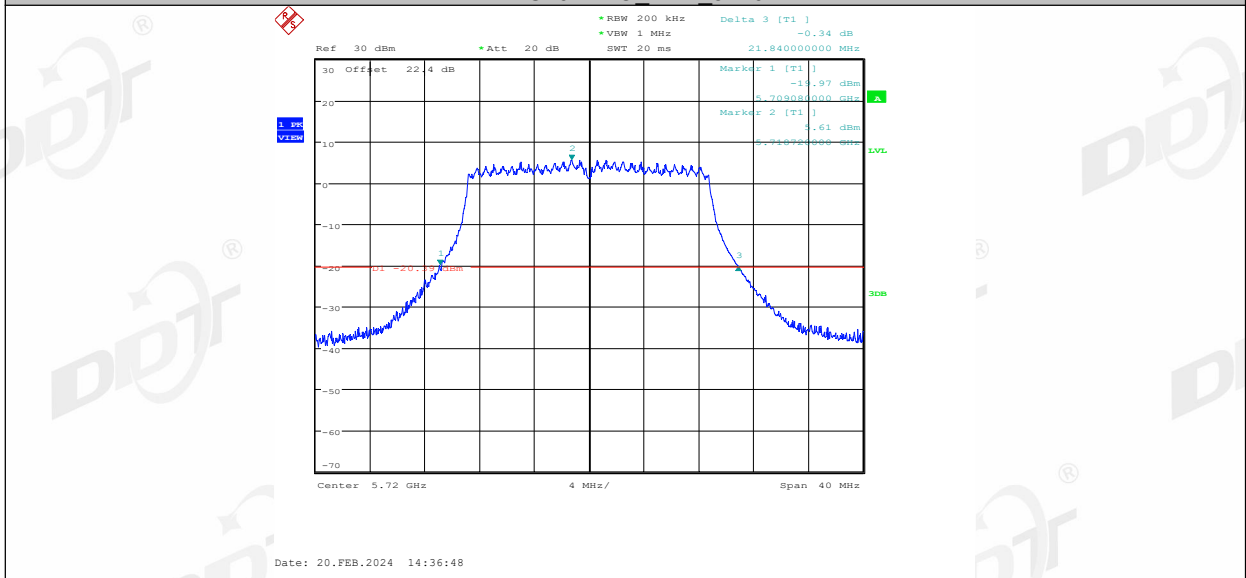

11AC20MIMO Ant1 5745

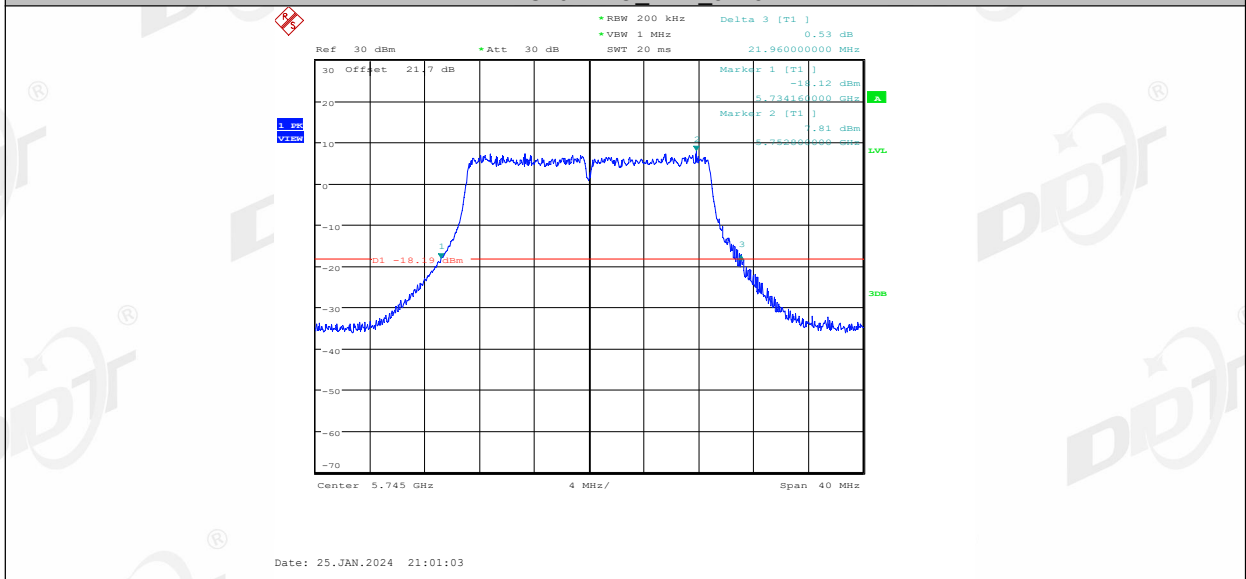

11AC20MIMO Ant2 5745

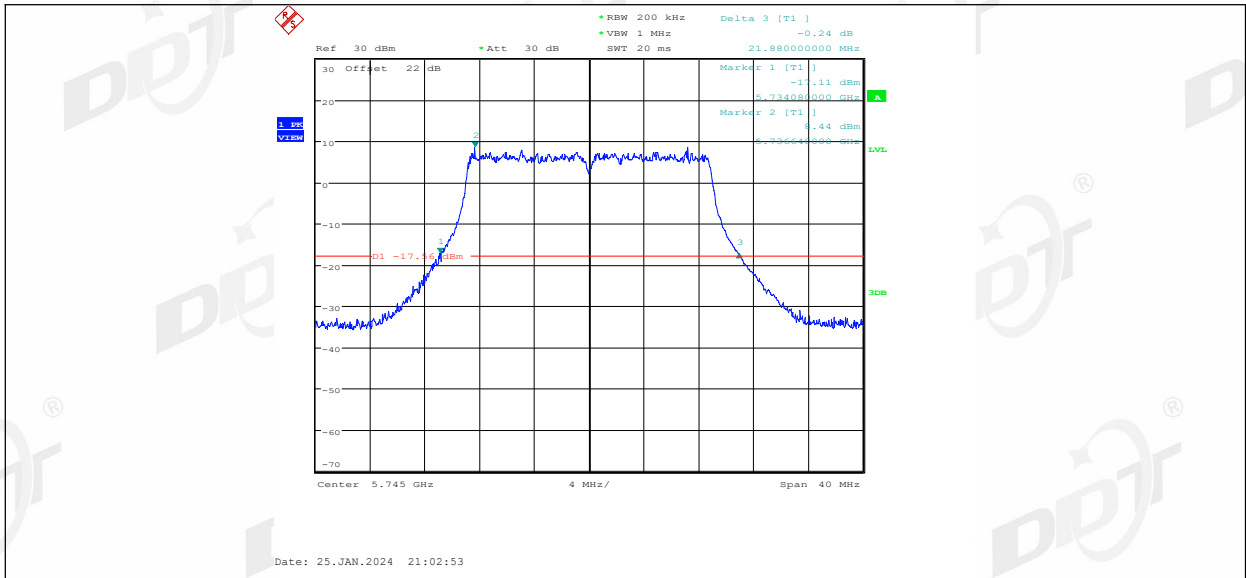

11AC20MIMO Ant1 5785

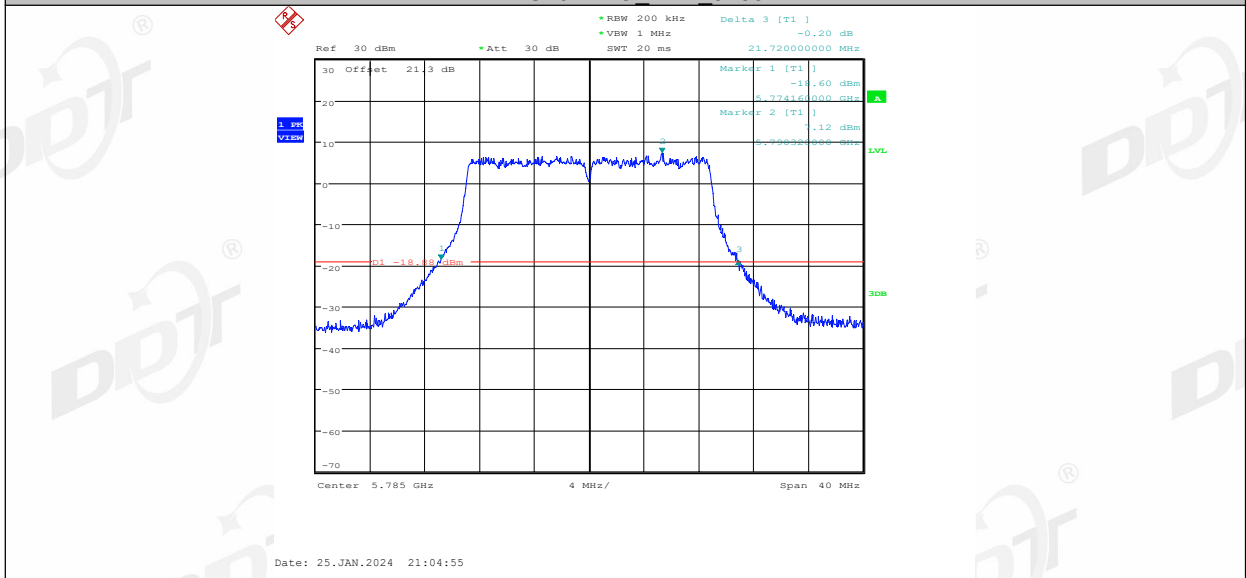

11AC20MIMO Ant2 5785

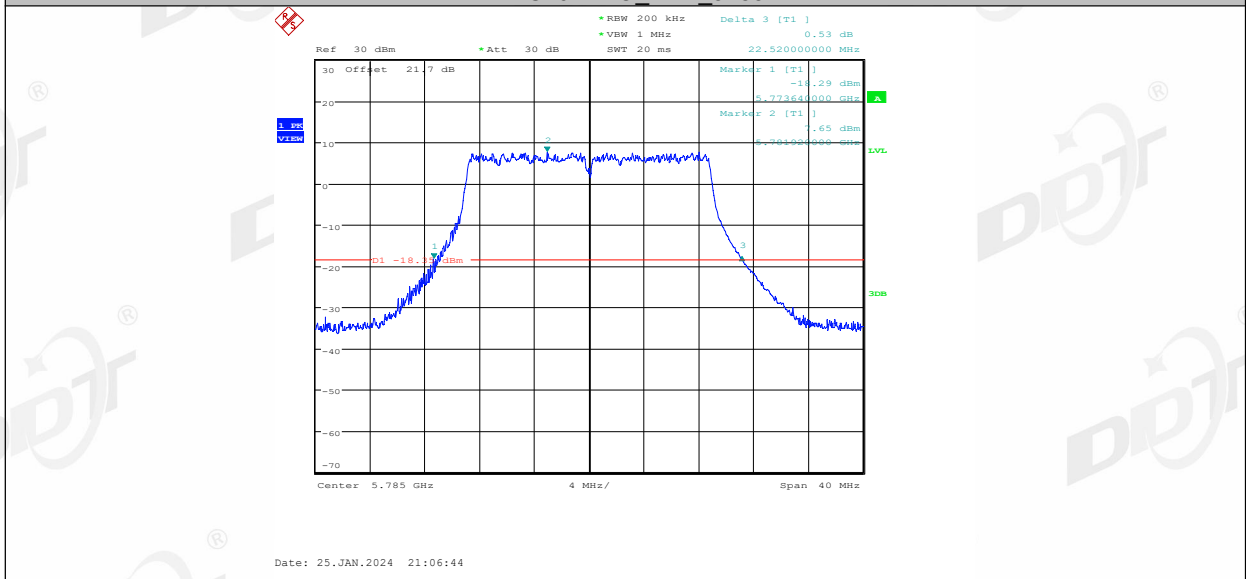

11AC20MIMO Ant1 5825

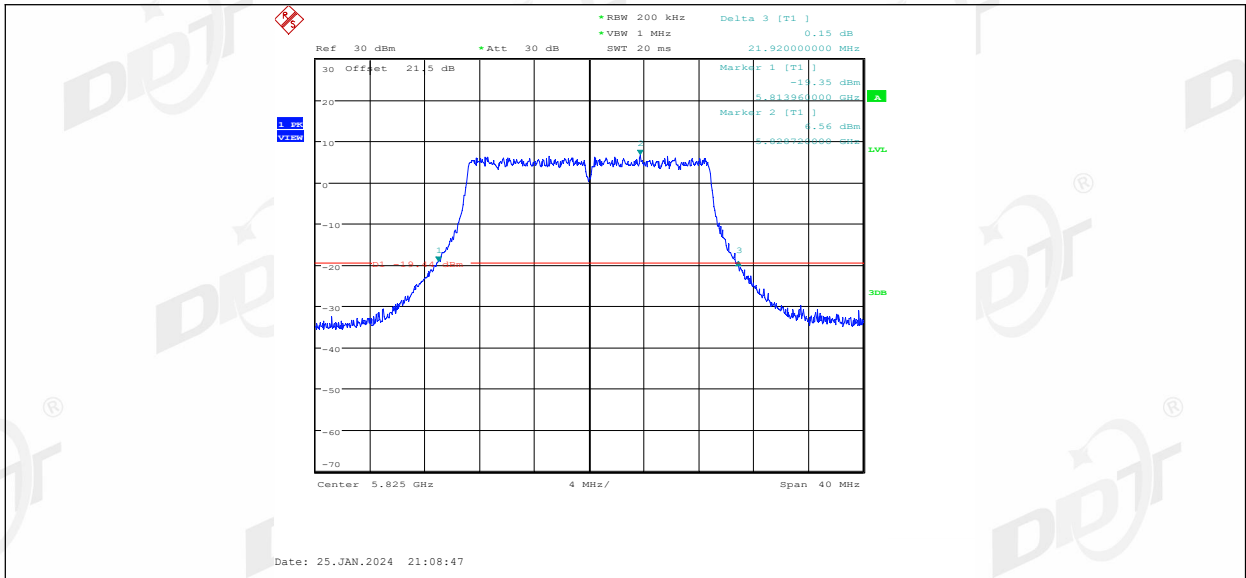

11AC20MIMO Ant2 5825

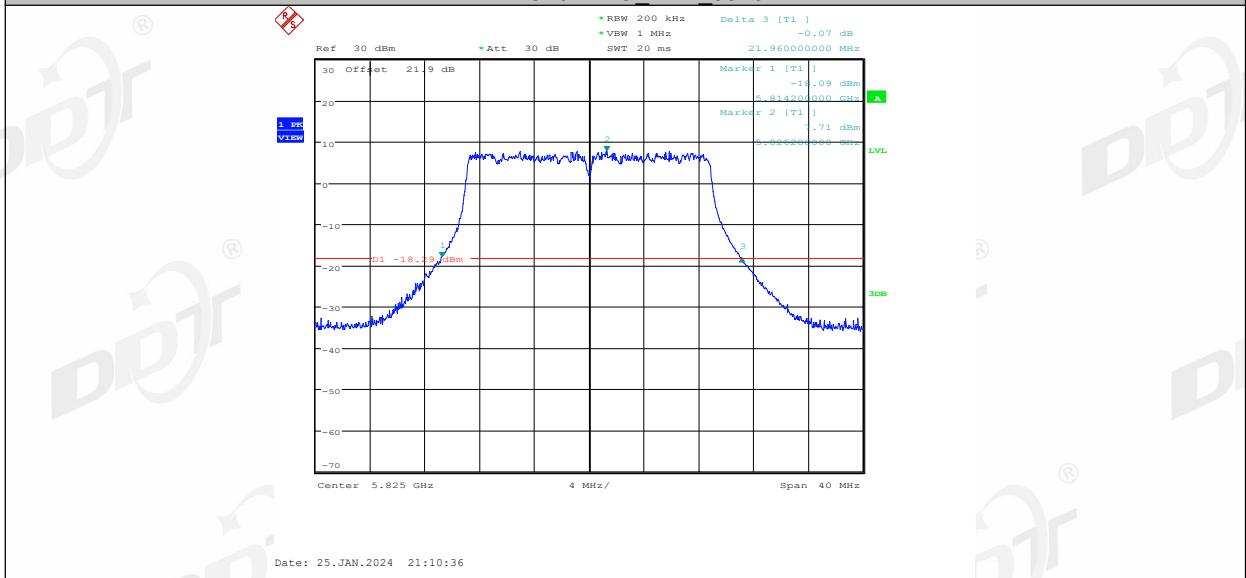

11AC40MIMO Ant1 5190



11AC40MIMO Ant2 5190

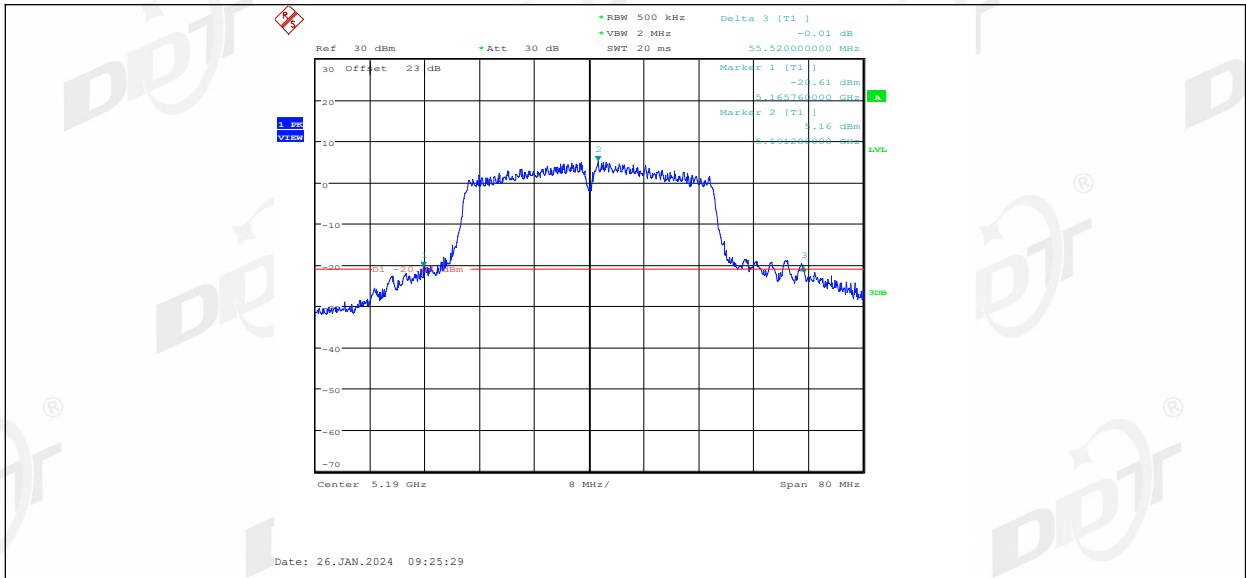

11AC40MIMO Ant1 5230

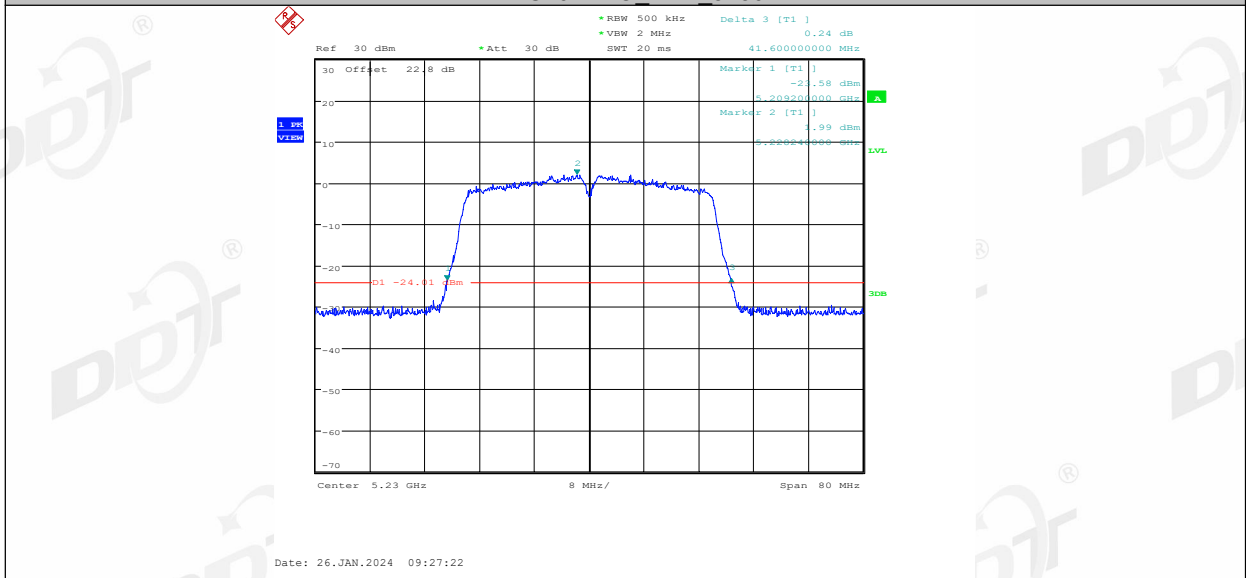

11AC40MIMO Ant2 5230

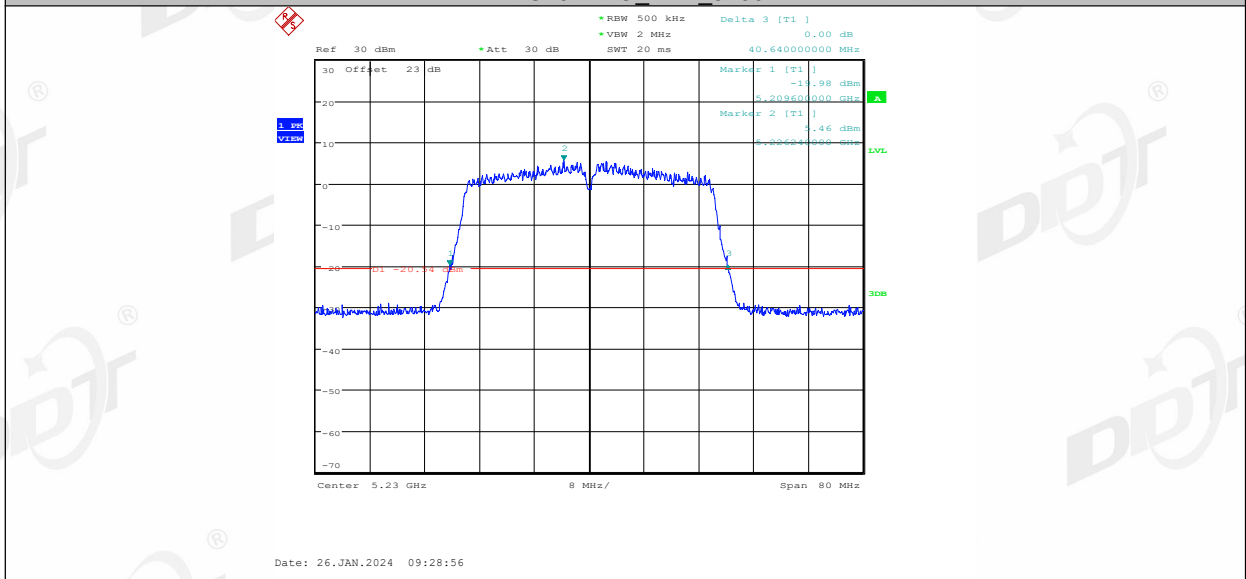

11AC40MIMO Ant1 5270

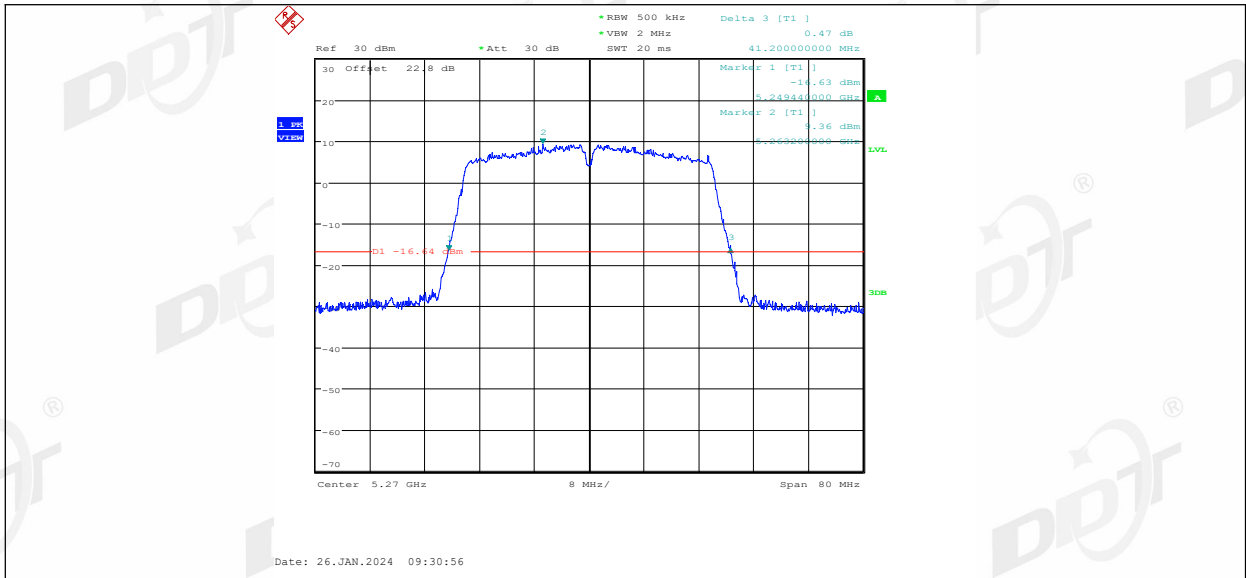

11AC40MIMO Ant2 5270

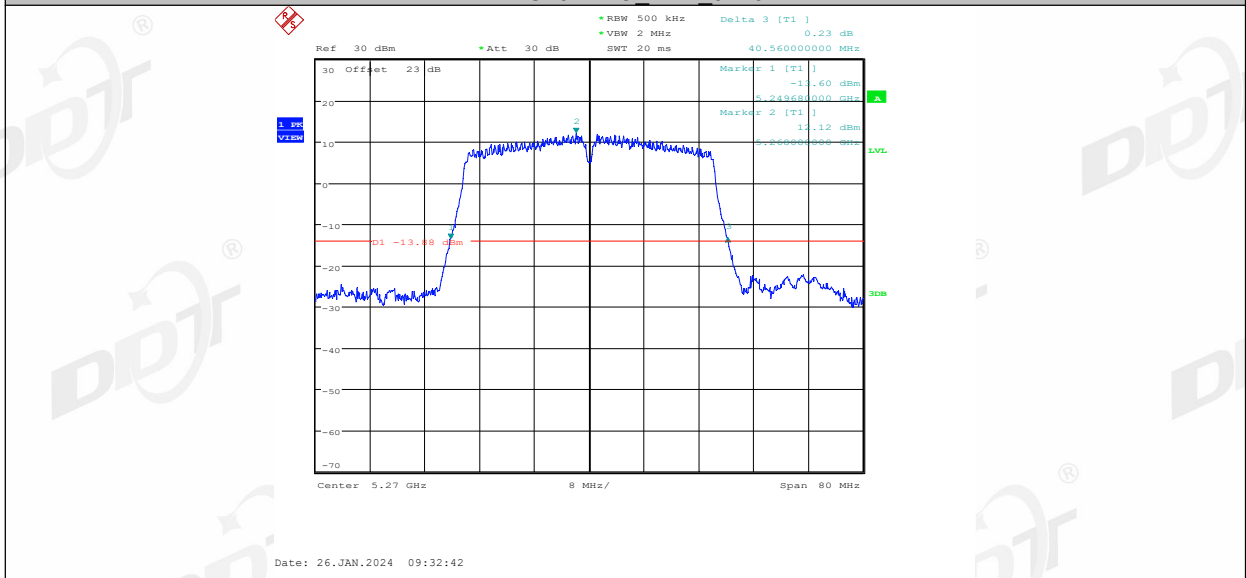

11AC40MIMO Ant1 5310

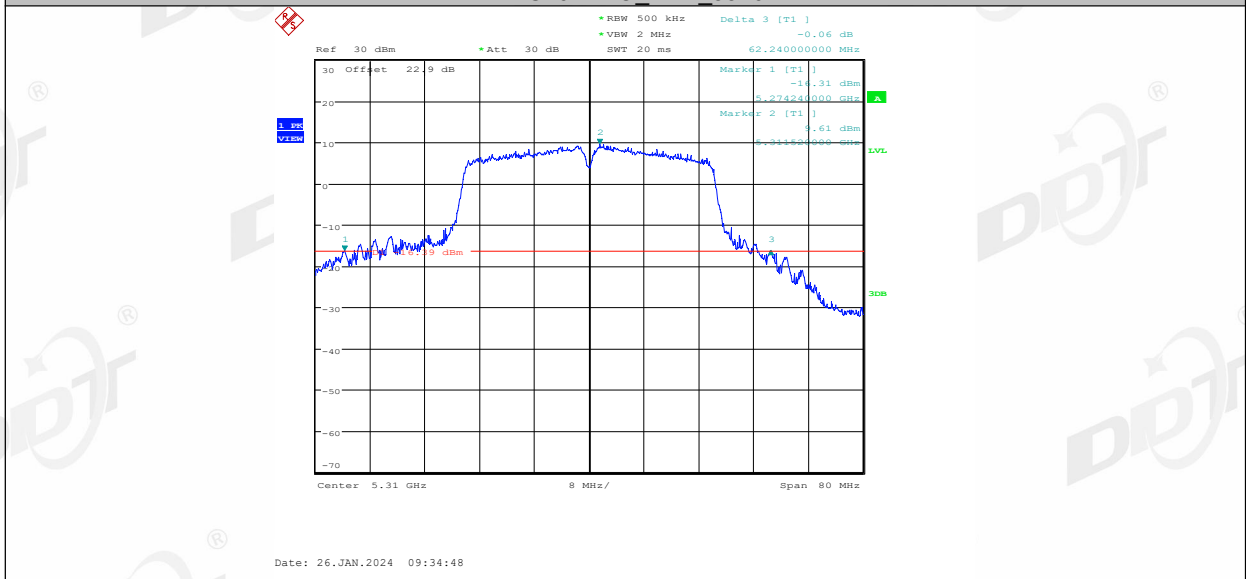

11AC40MIMO Ant2 5310

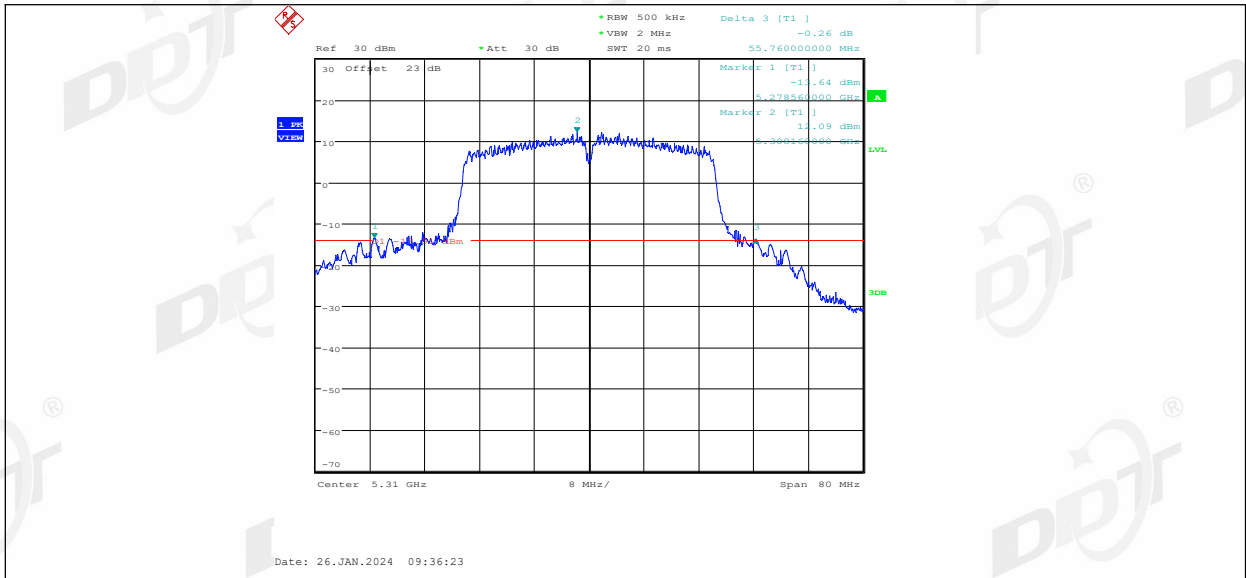

11AC40MIMO Ant1 5510

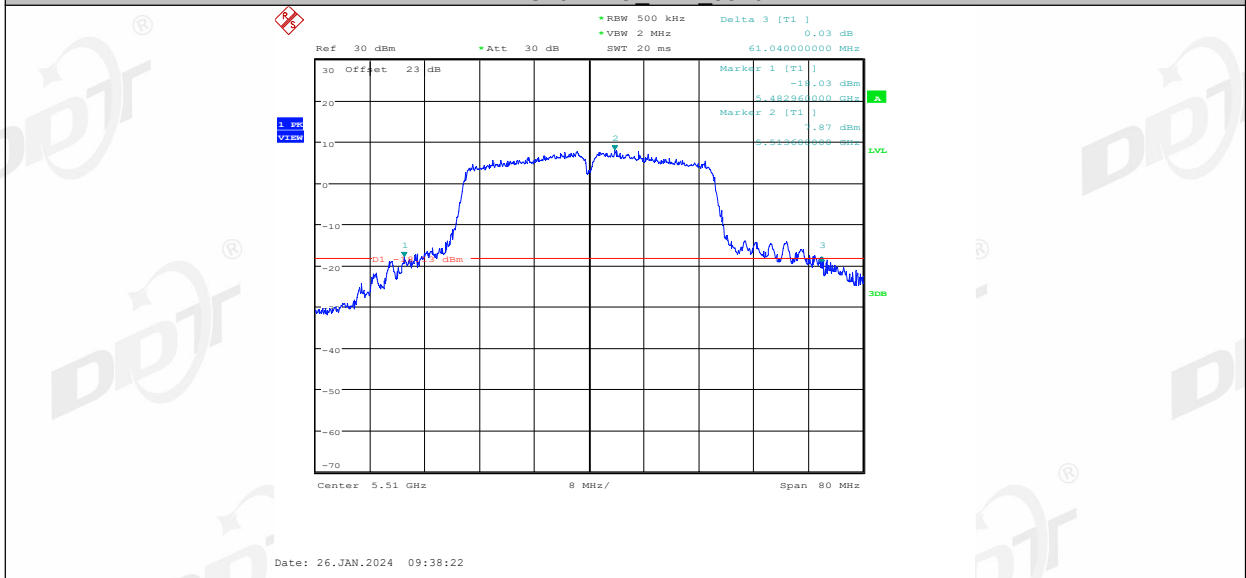

11AC40MIMO Ant2 5510

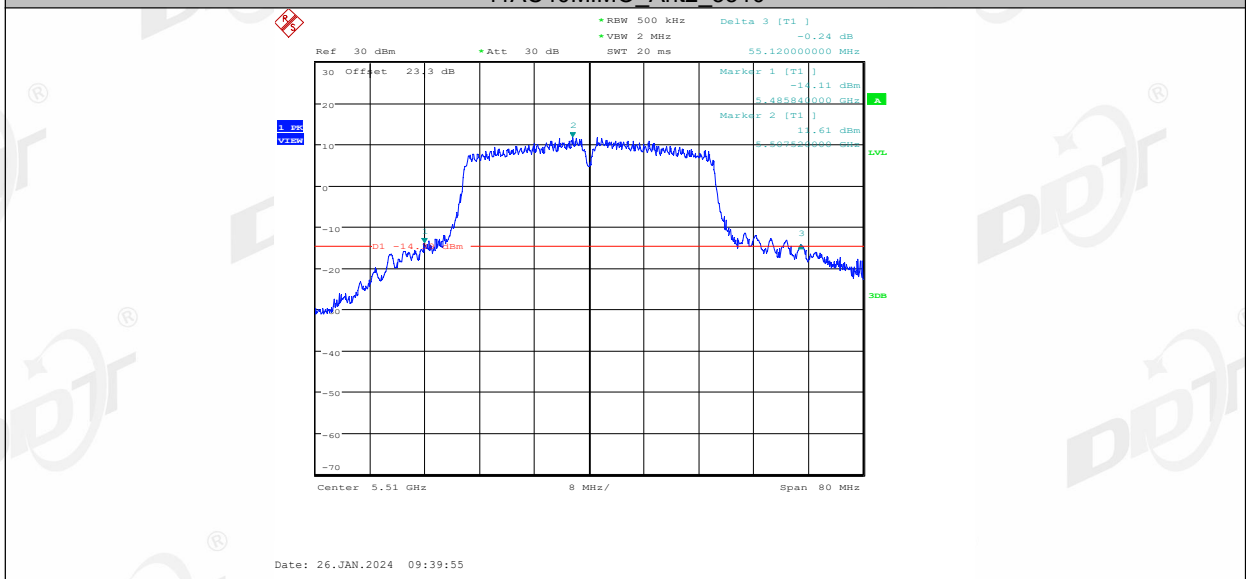

11AC40MIMO Ant1 5550

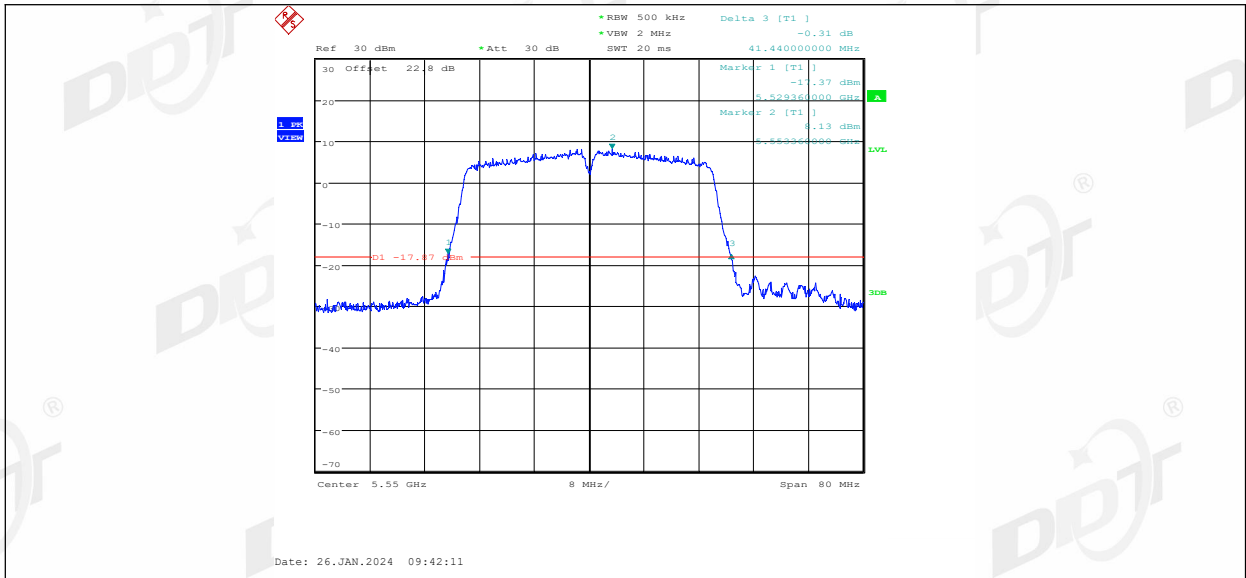

11AC40MIMO Ant2 5550

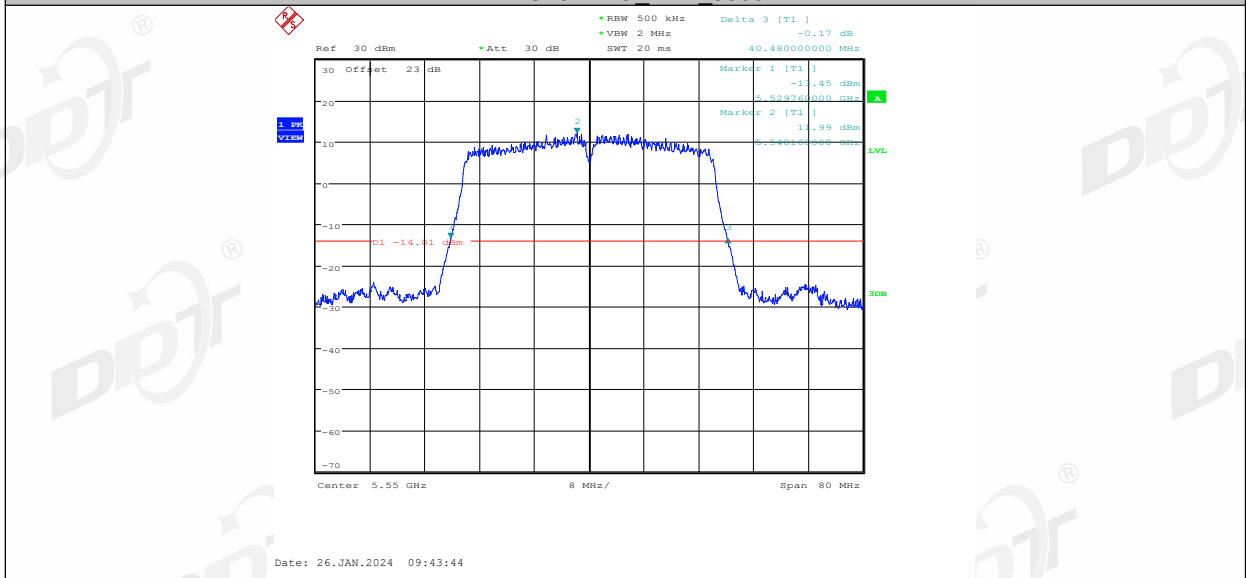

11AC40MIMO Ant1 5670

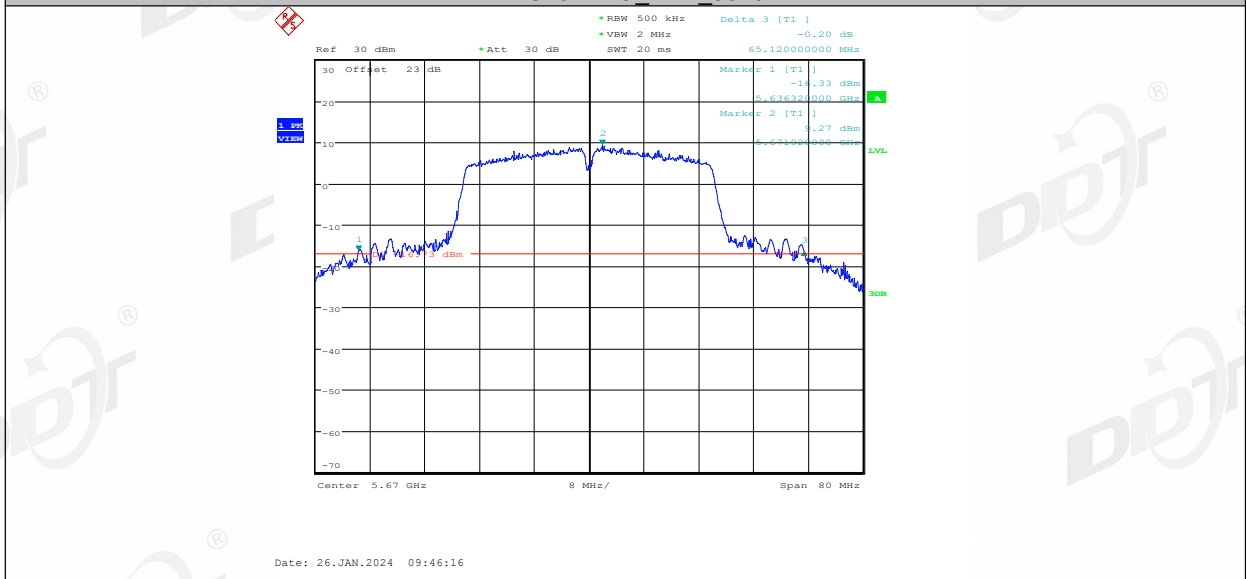

11AC40MIMO Ant2 5670

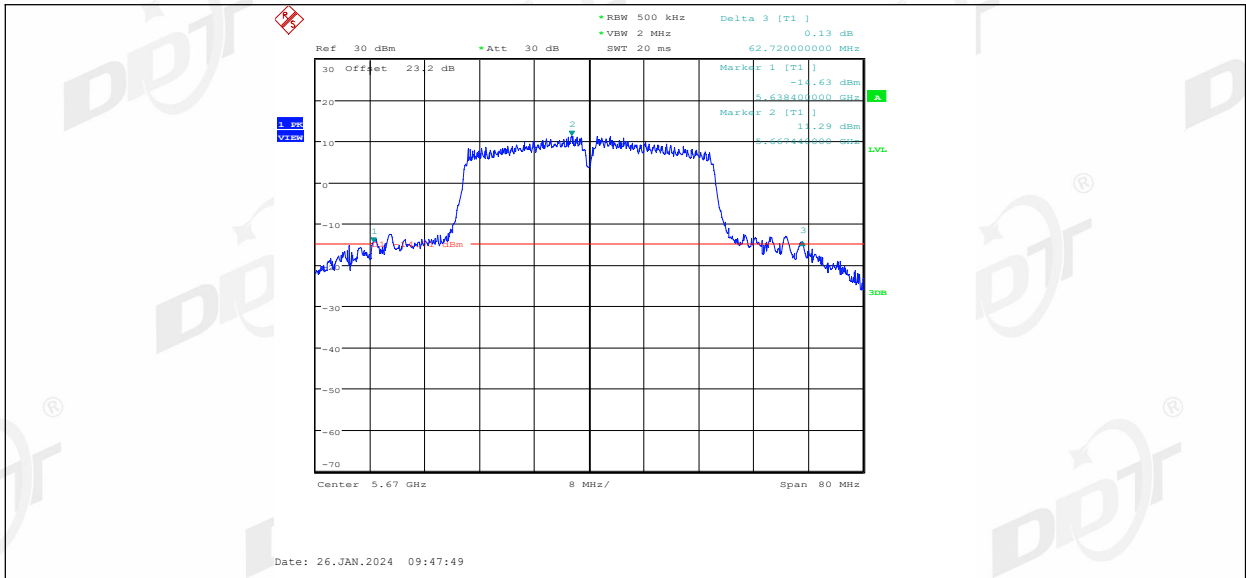

11AC40MIMO Ant1 5710

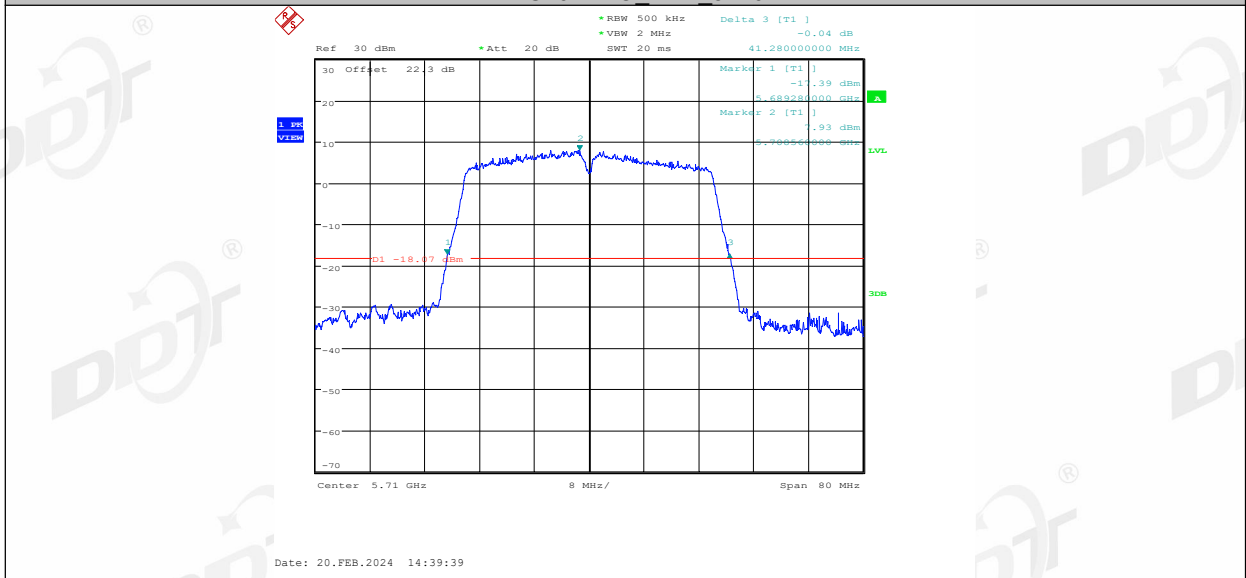

11AC40MIMO Ant2 5710

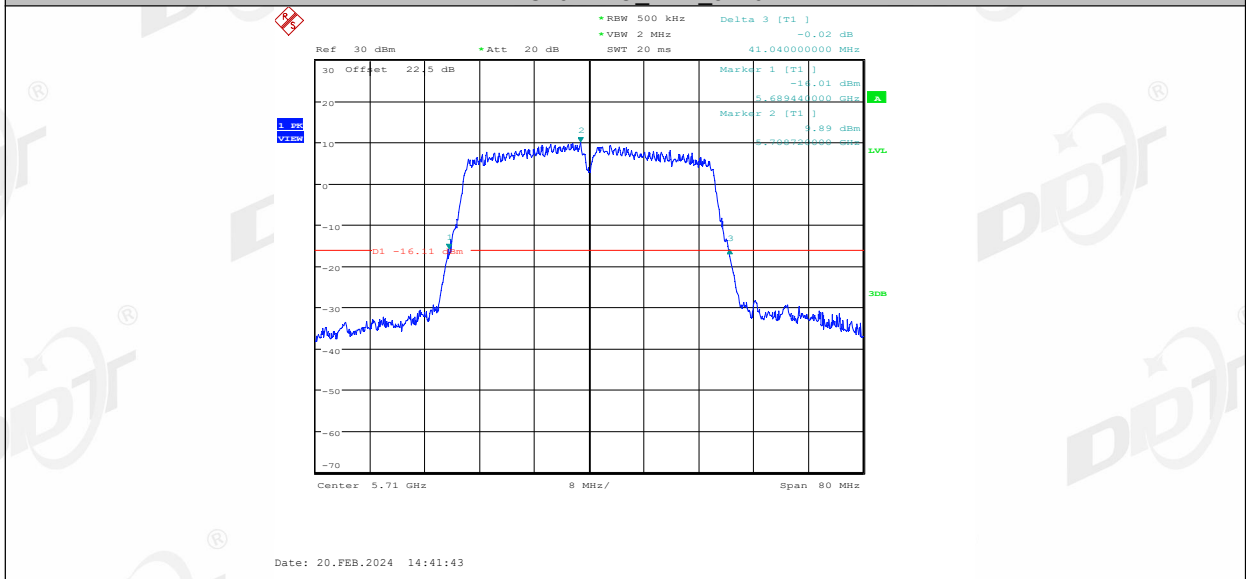

11AC40MIMO Ant1 5755

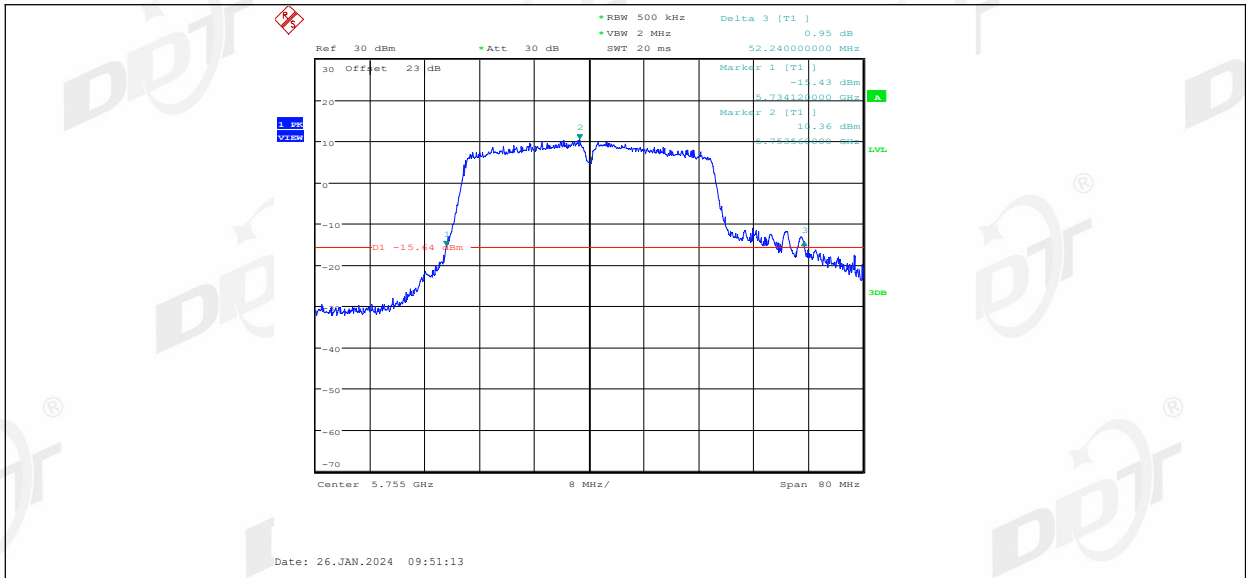

11AC40MIMO Ant2 5755

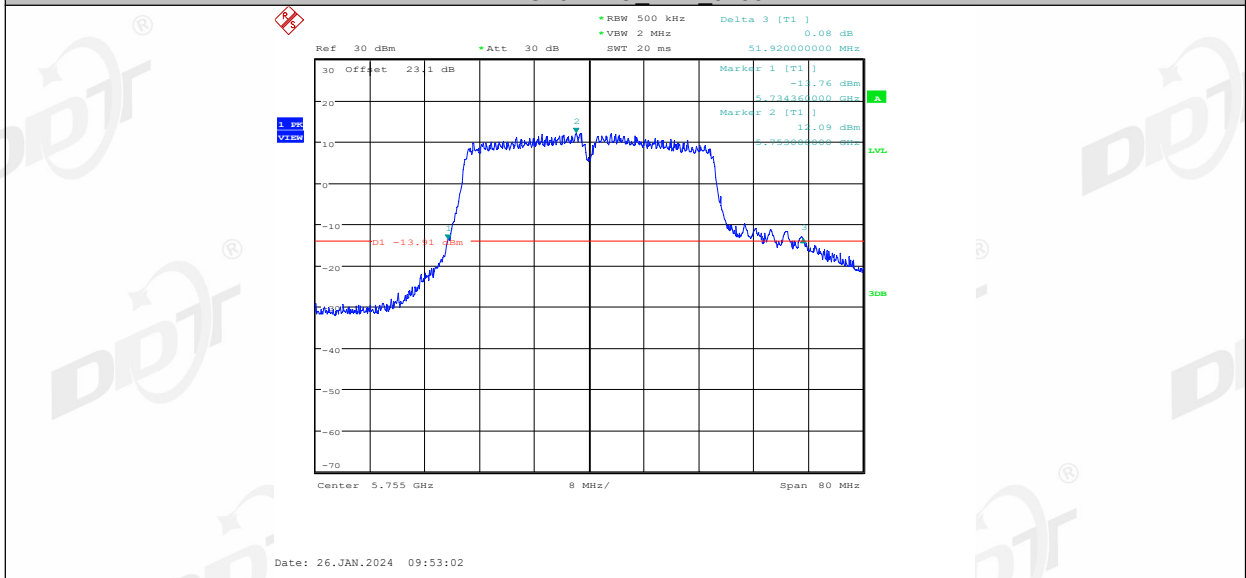

11AC40MIMO Ant1 5795

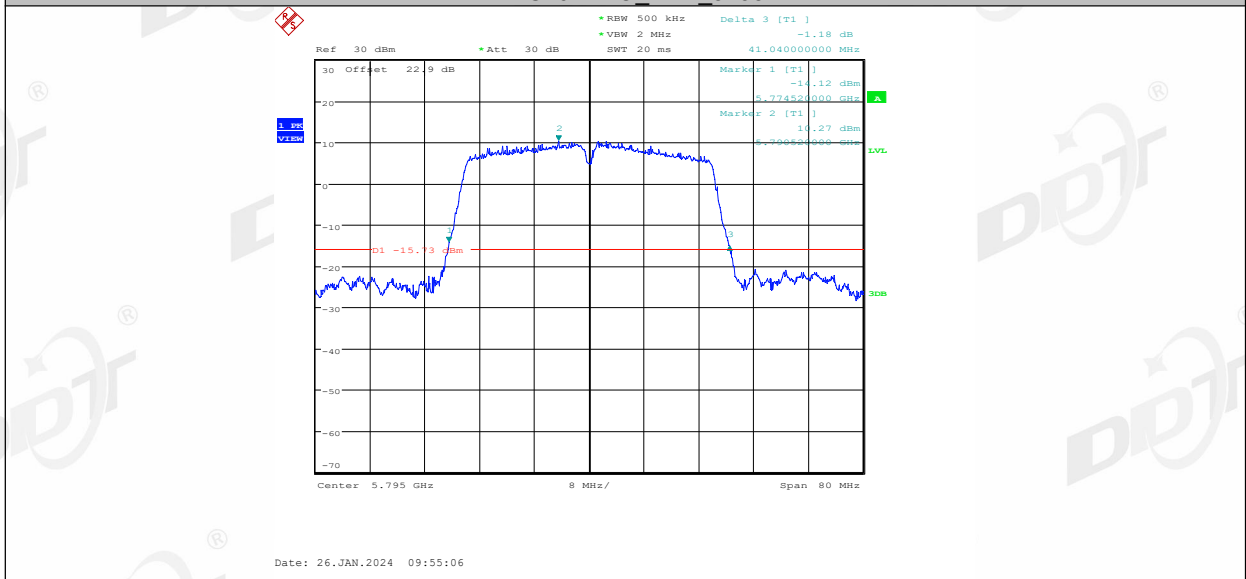

11AC40MIMO Ant2 5795

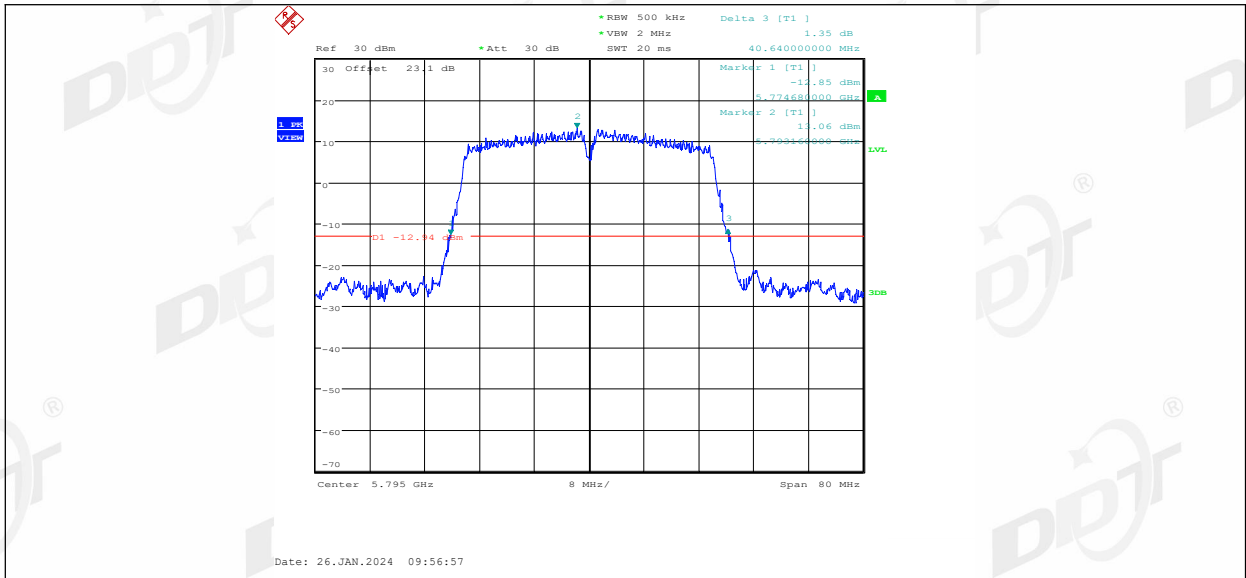

11AC80MIMO Ant1 5210

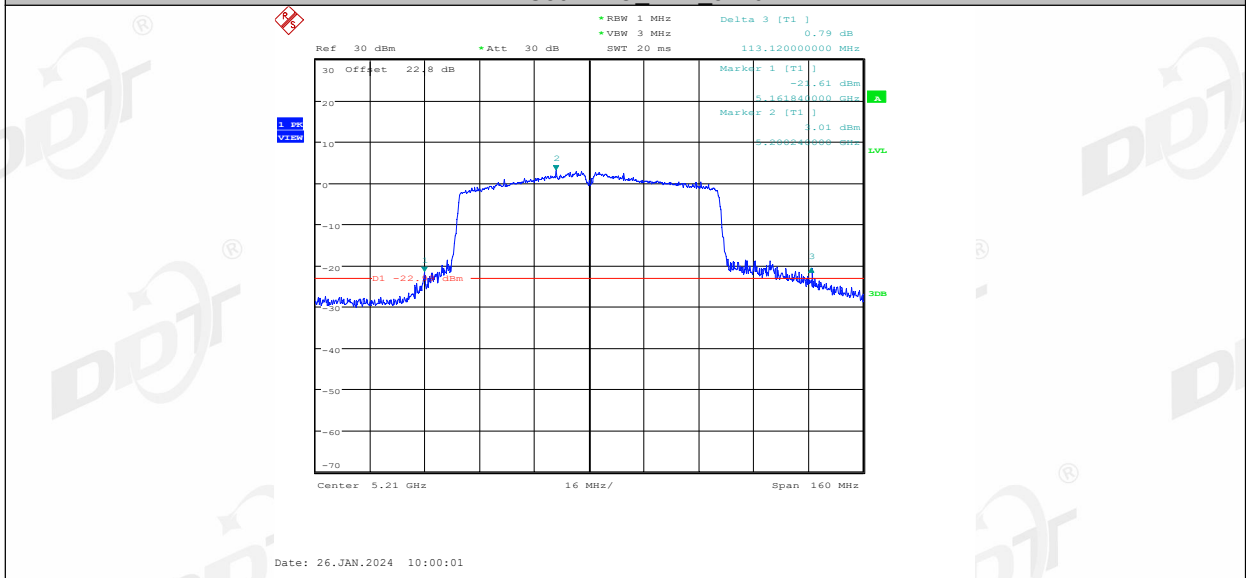

11AC80MIMO Ant2 5210

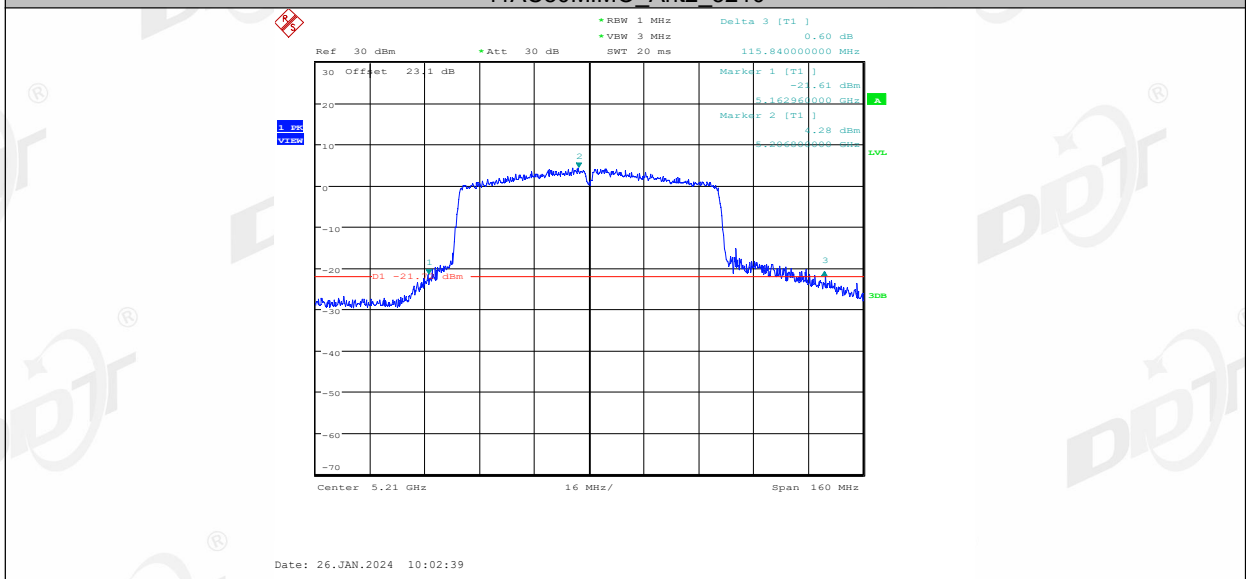

11AC80MIMO Ant1 5290

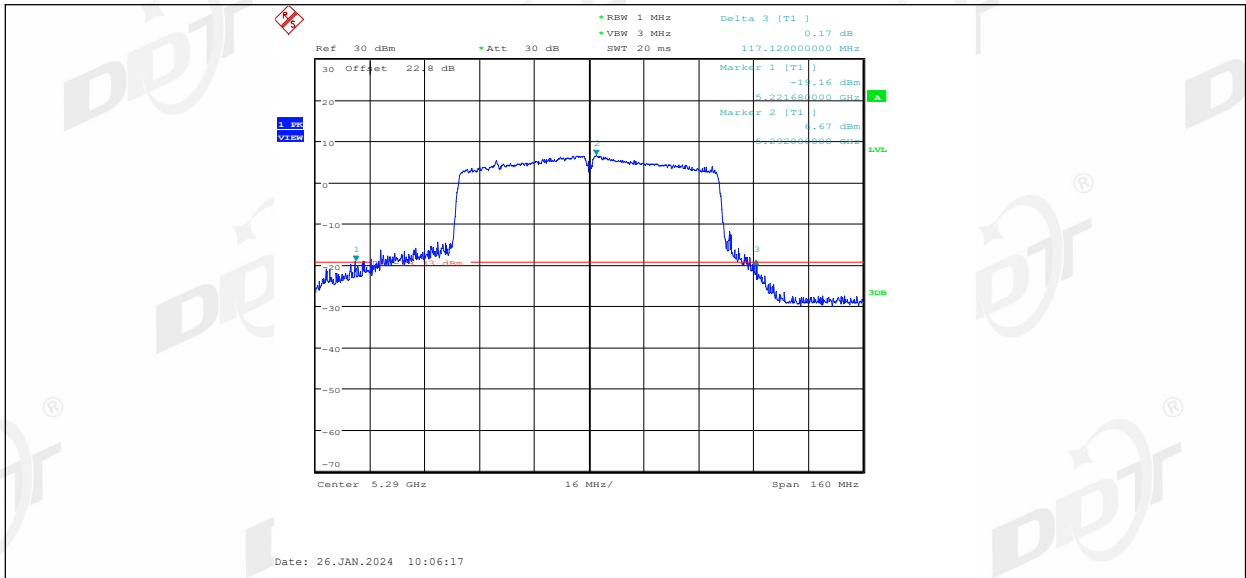

11AC80MIMO Ant2 5290

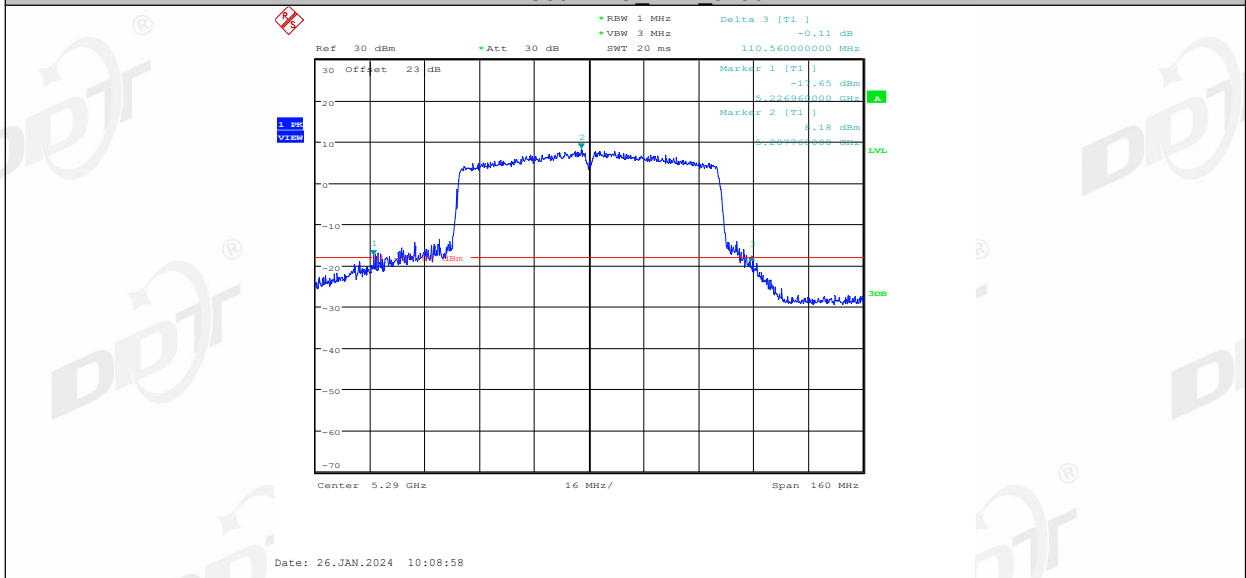

11AC80MIMO Ant1 5530

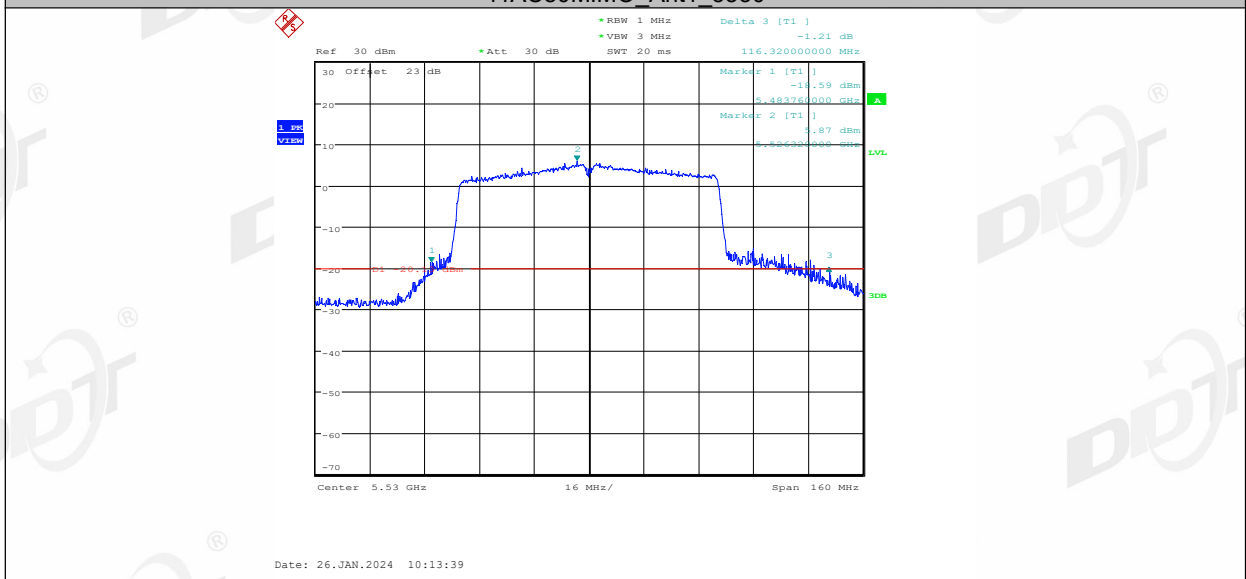

11AC80MIMO Ant2 5530

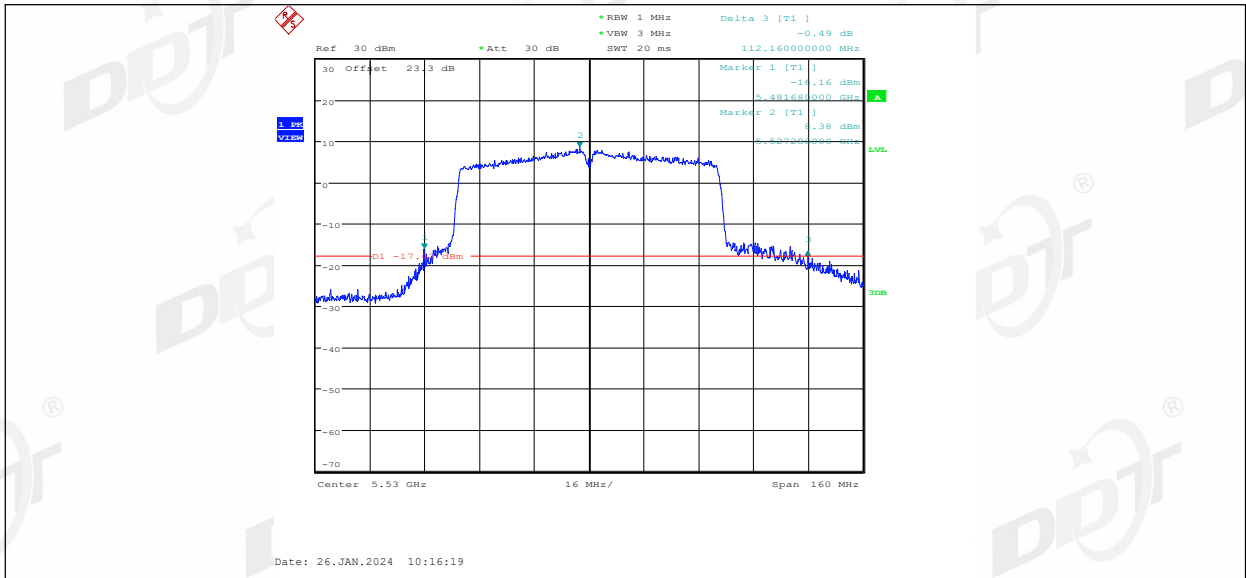

11AC80MIMO Ant1 5610

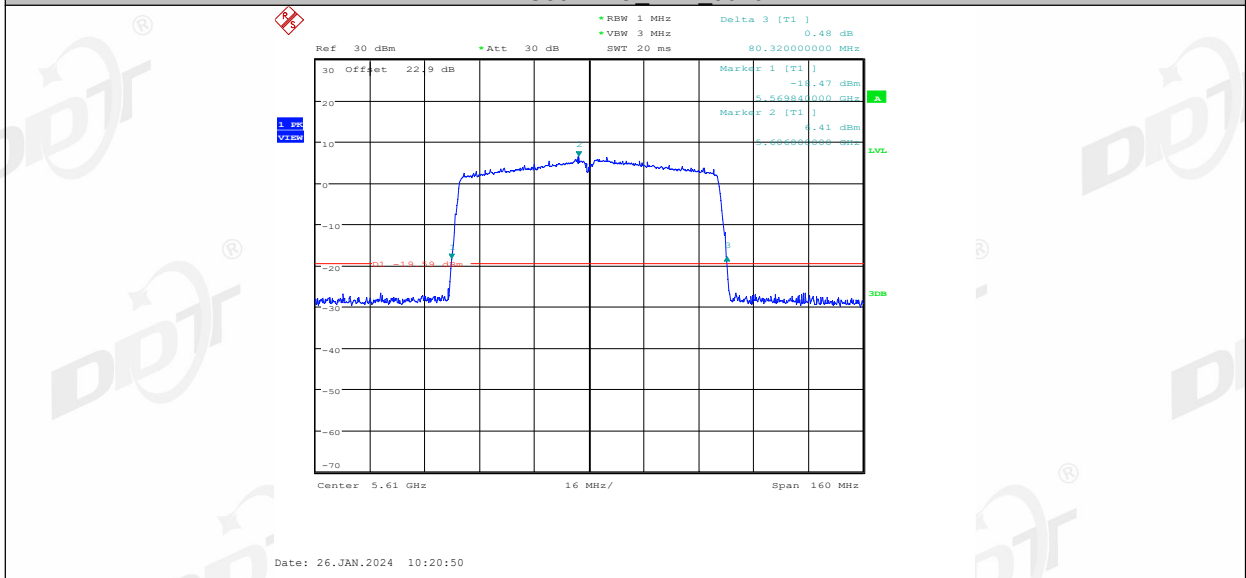

11AC80MIMO Ant2 5610

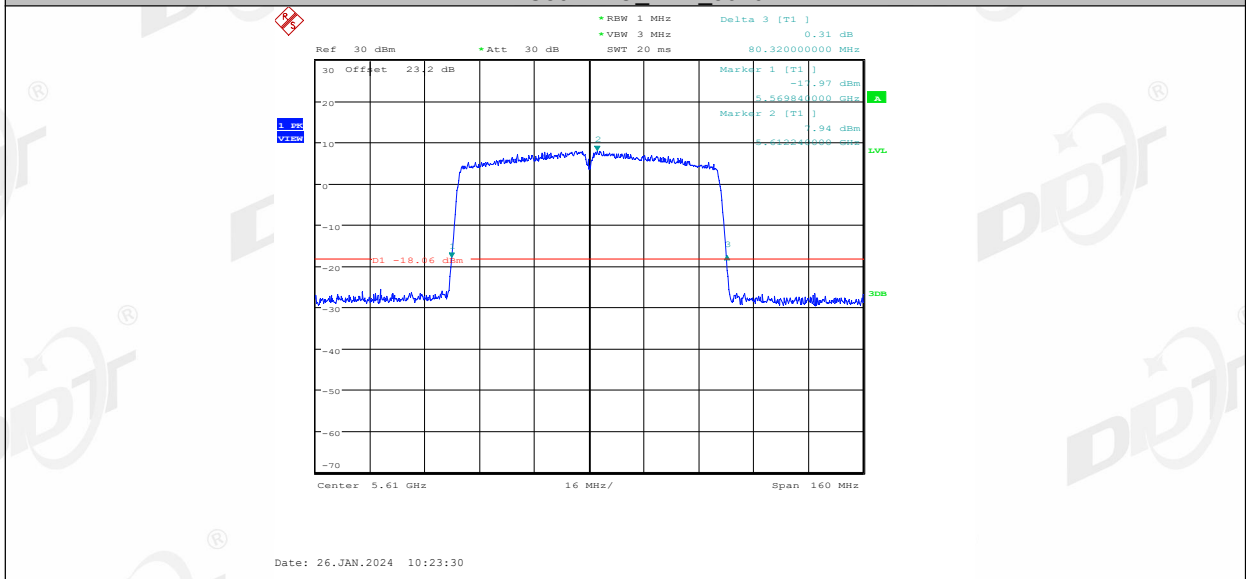

11AC80MIMO Ant1 5690

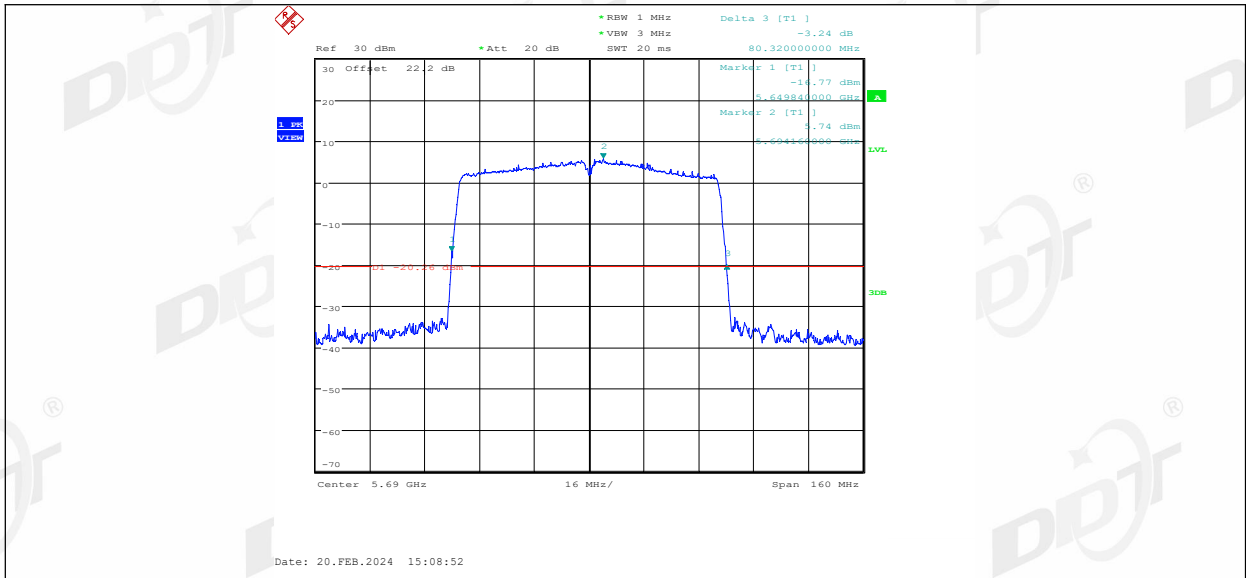

11AC80MIMO Ant2 5690

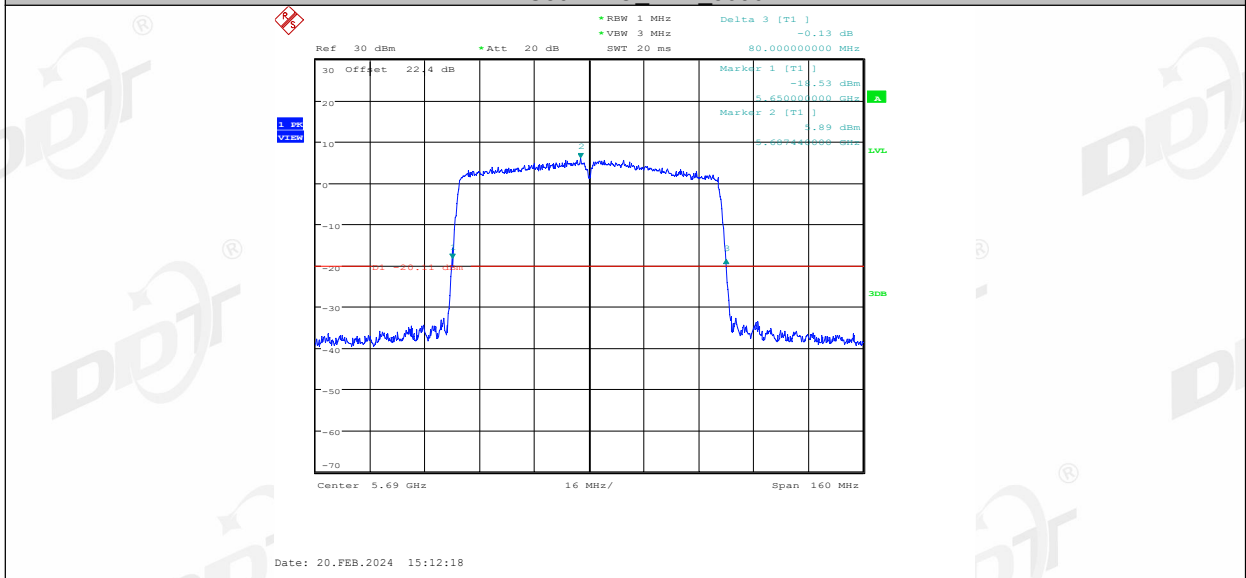

11AC80MIMO Ant1 5775

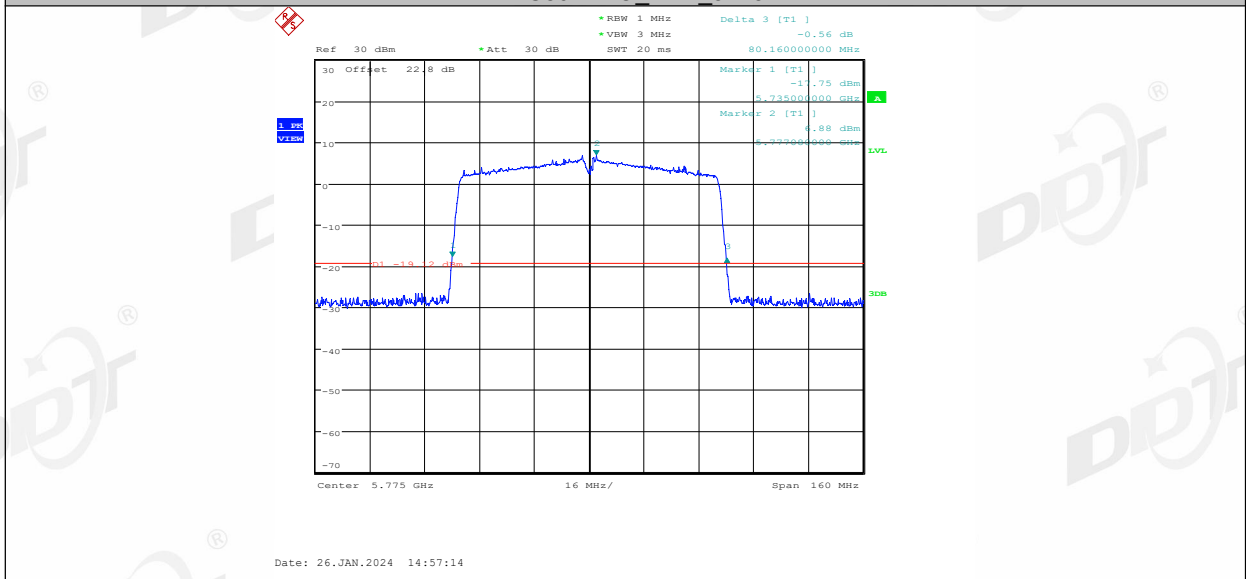

11AC80MIMO Ant2 5775

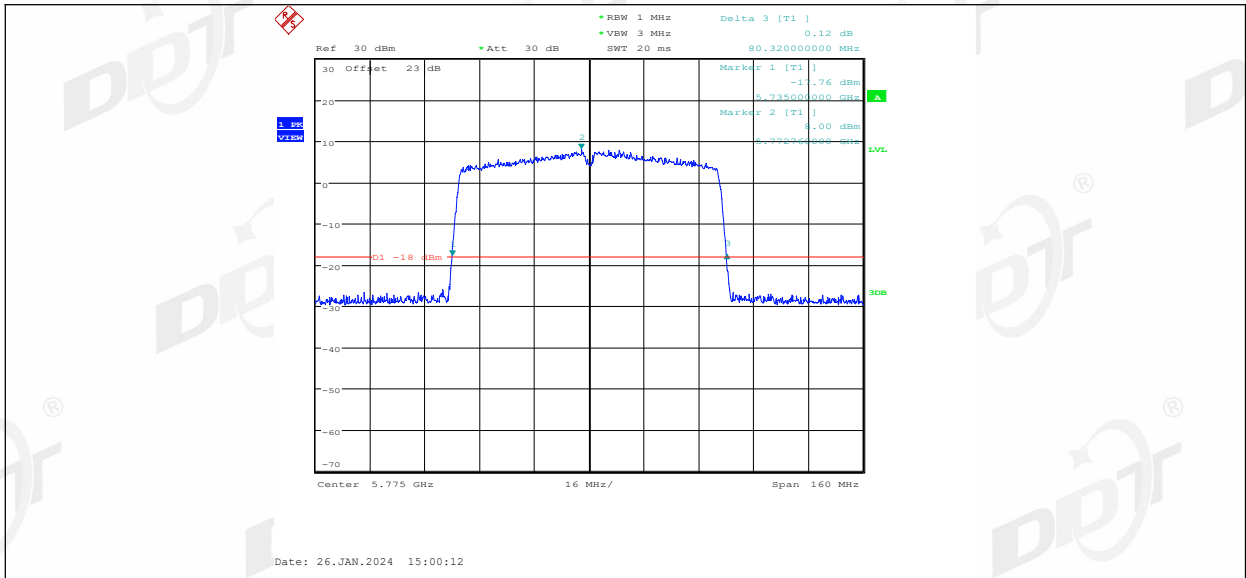

11AC160MIMO Ant1_5250

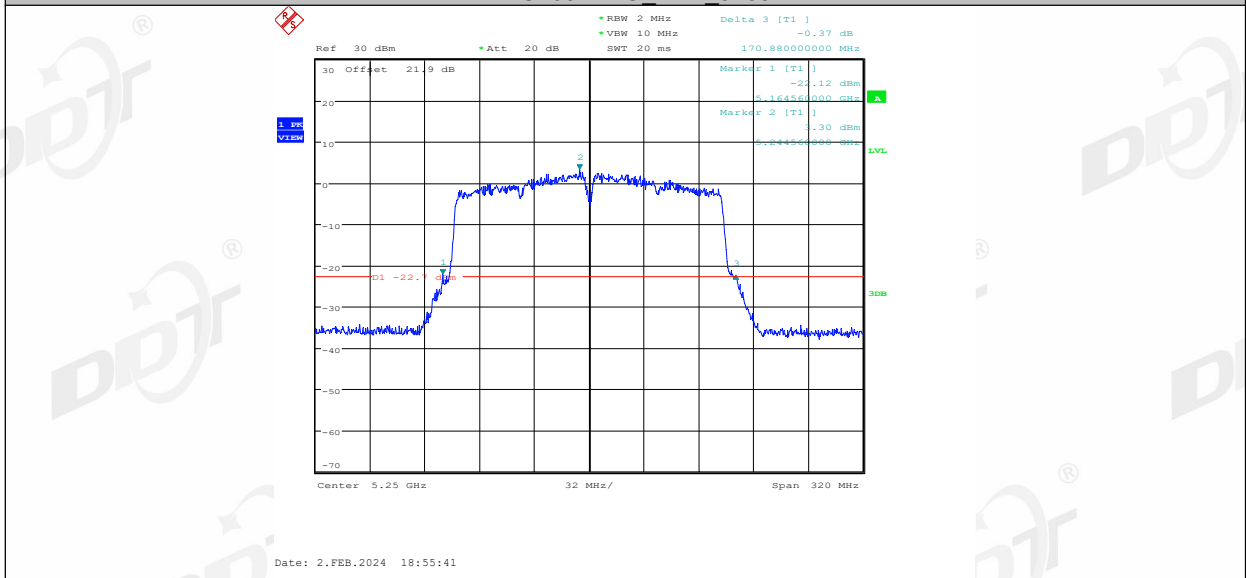

11AC160MIMO Ant2_5250

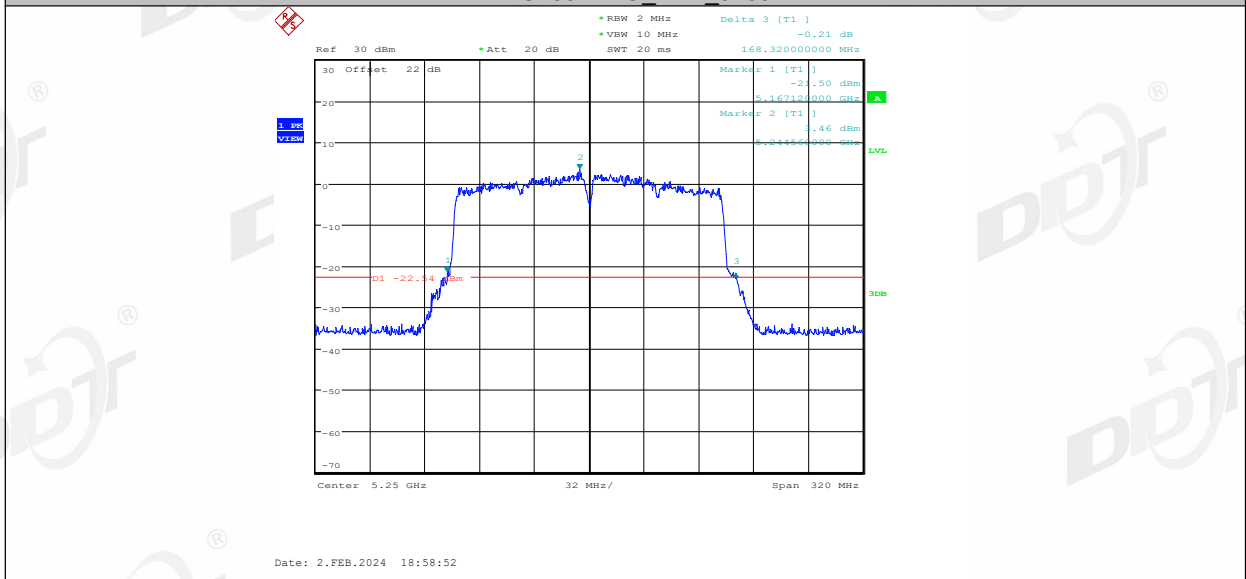

11AC160MIMO Ant1_5570

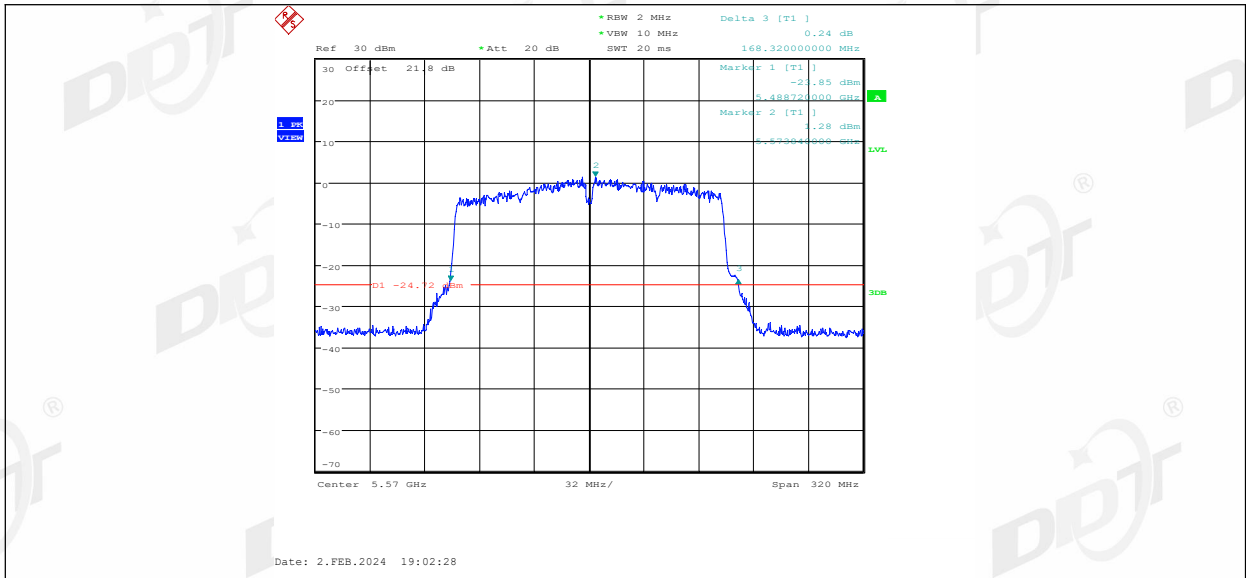

11AC160MIMO Ant2 5570

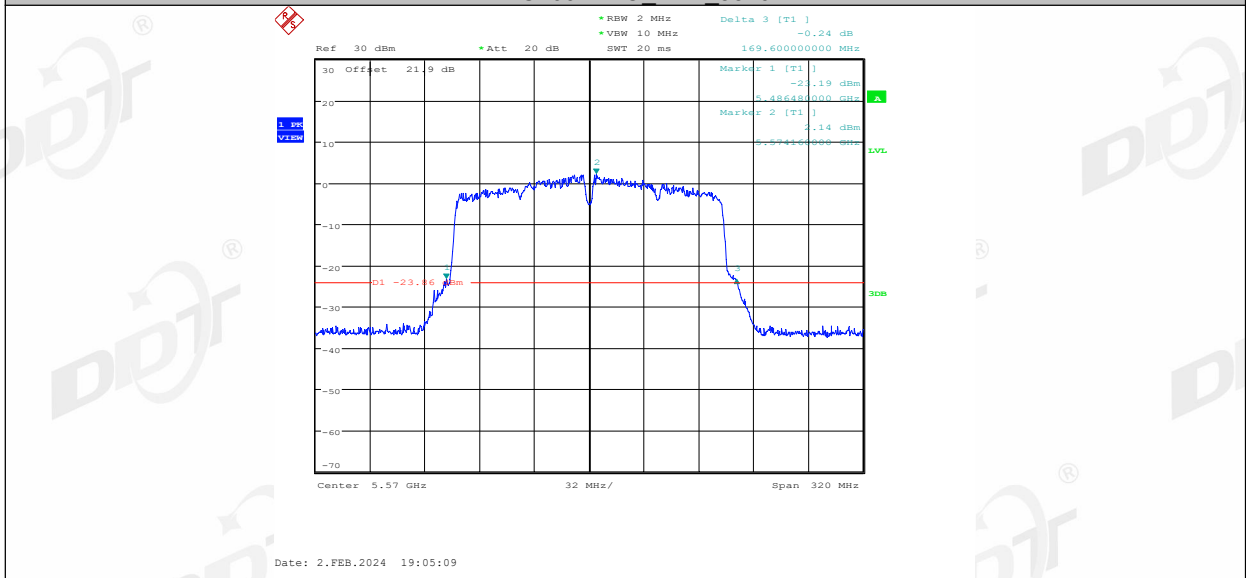

11AX20MIMO Ant1 5180

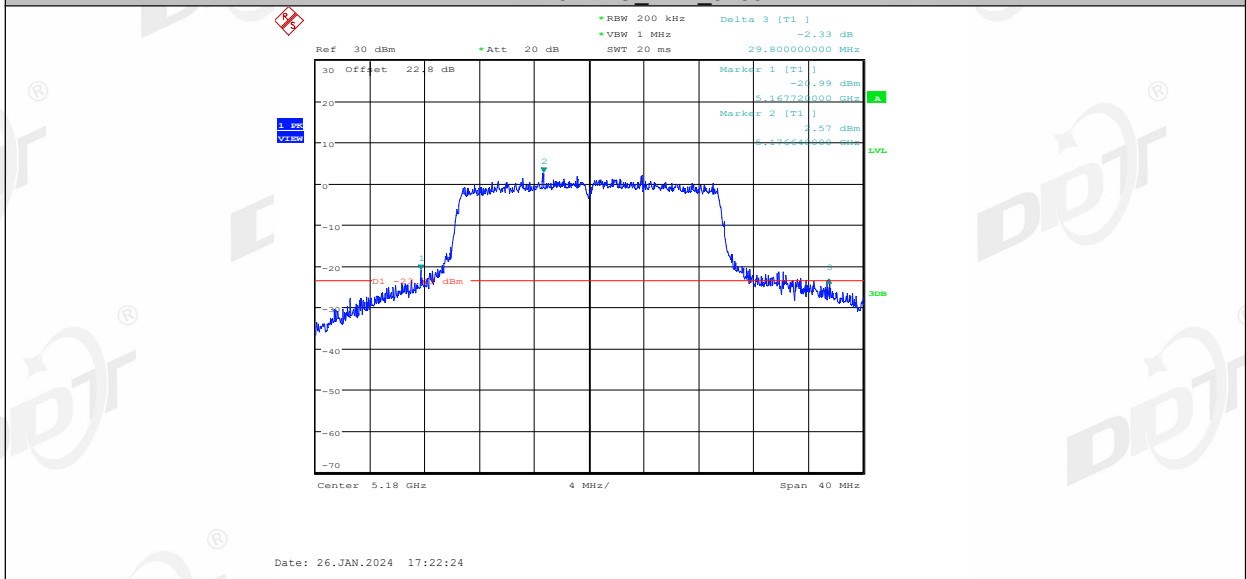

11AX20MIMO Ant2 5180

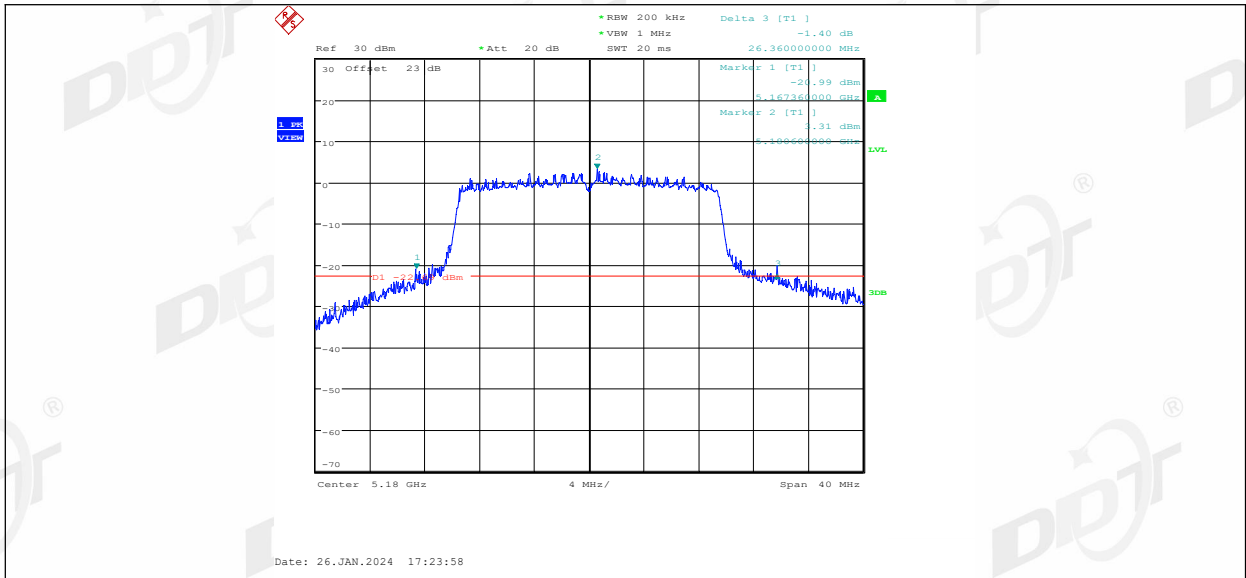

11AX20MIMO Ant1 5200

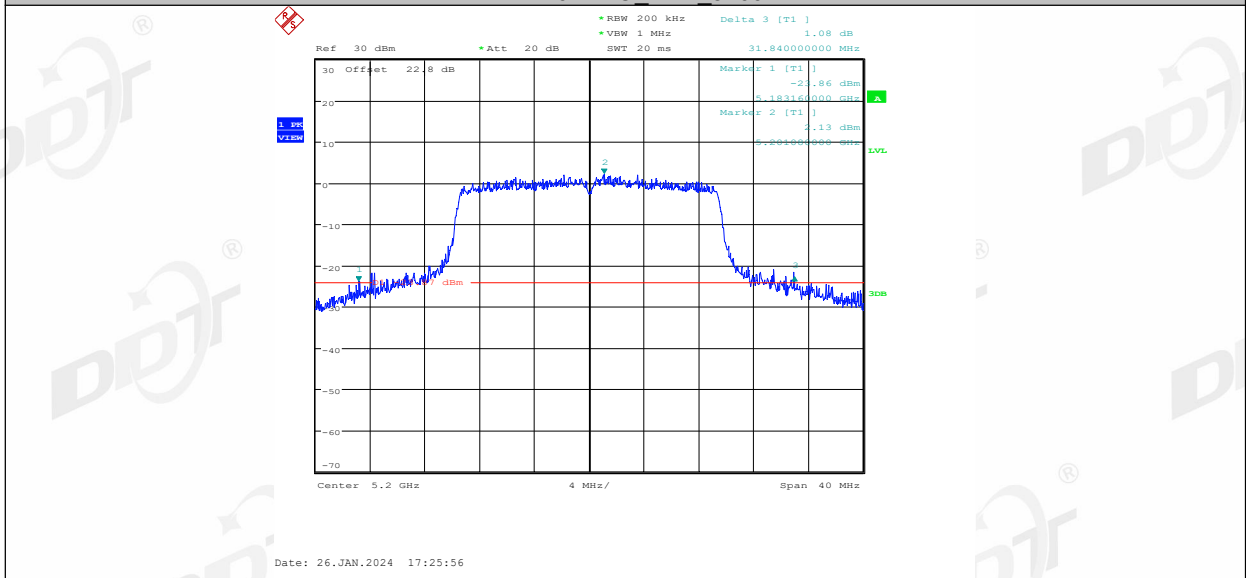

11AX20MIMO Ant2 5200

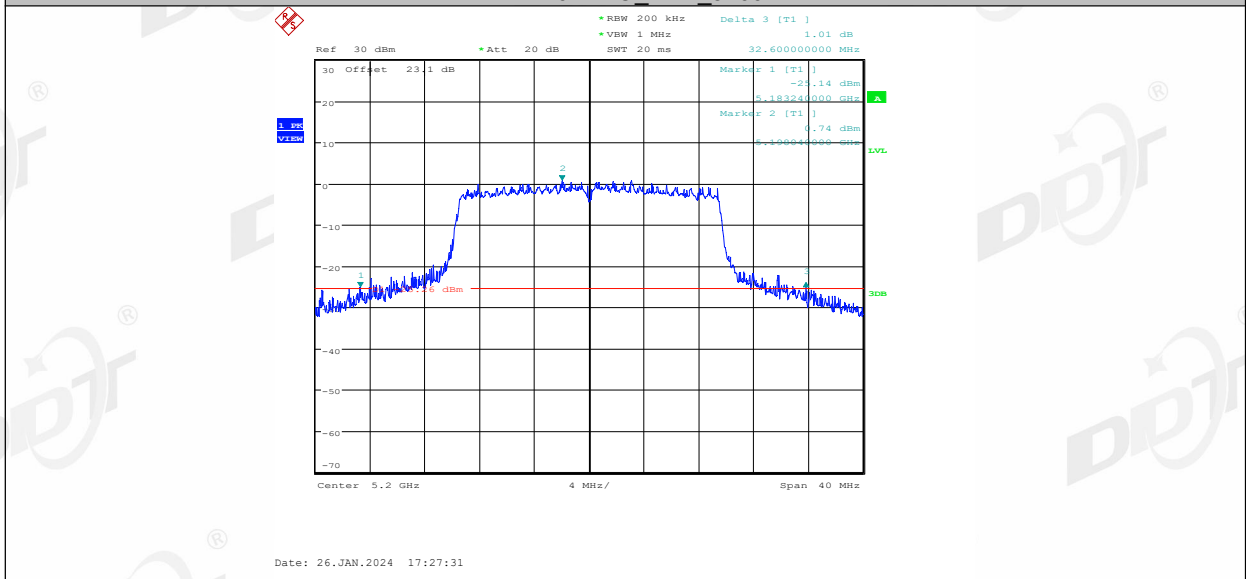

11AX20MIMO Ant1 5240

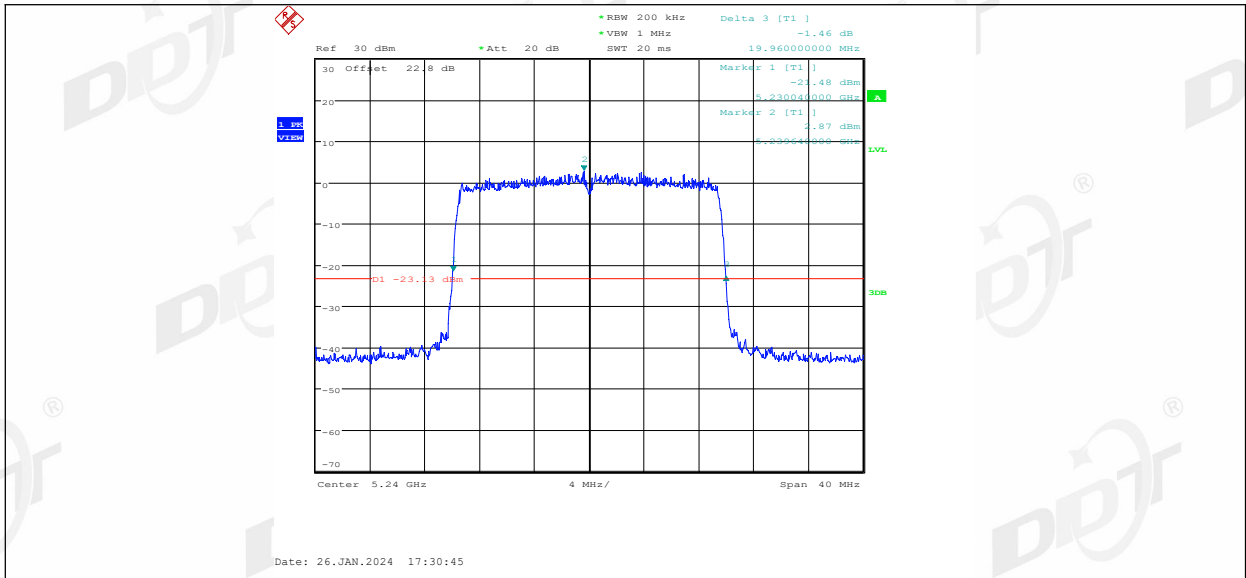

11AX20MIMO Ant2 5240

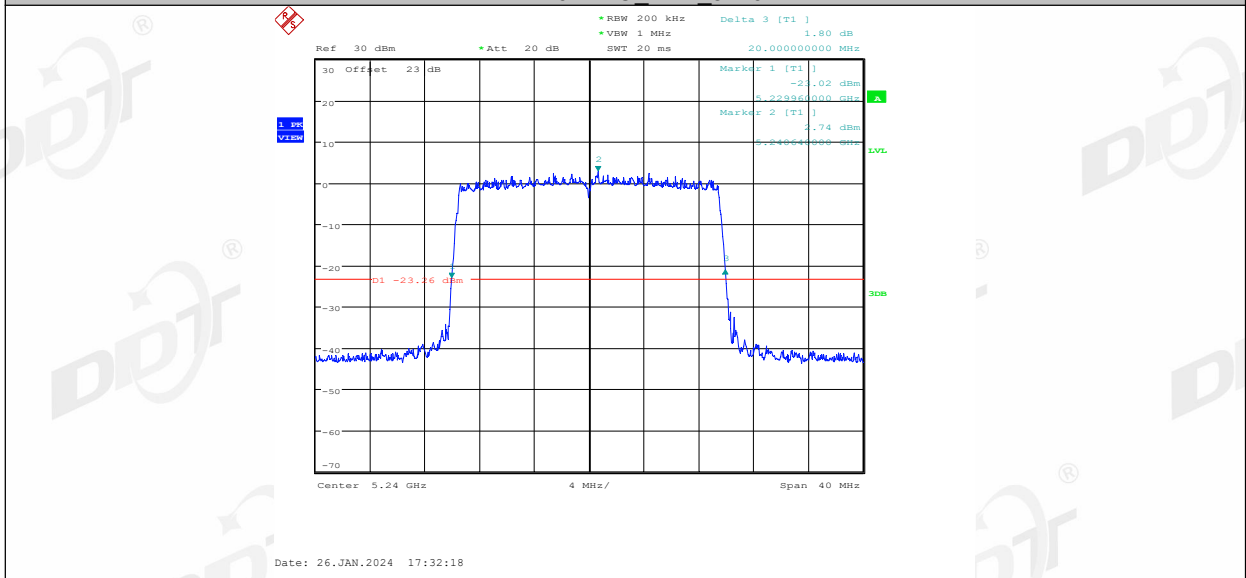

11AX20MIMO Ant1 5260

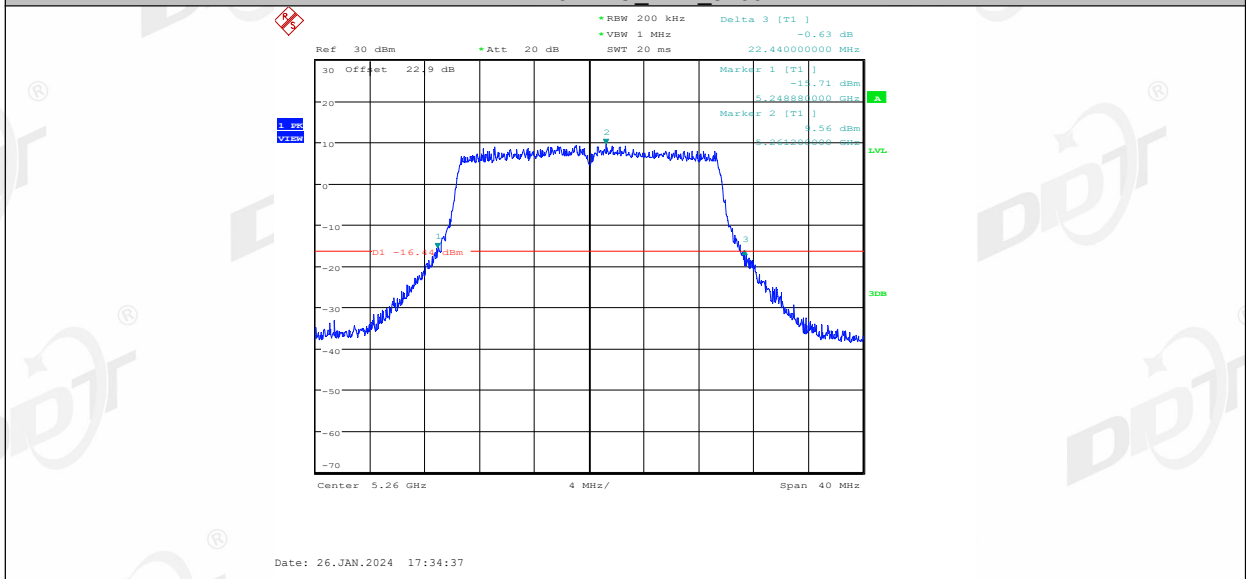

11AX20MIMO Ant2 5260

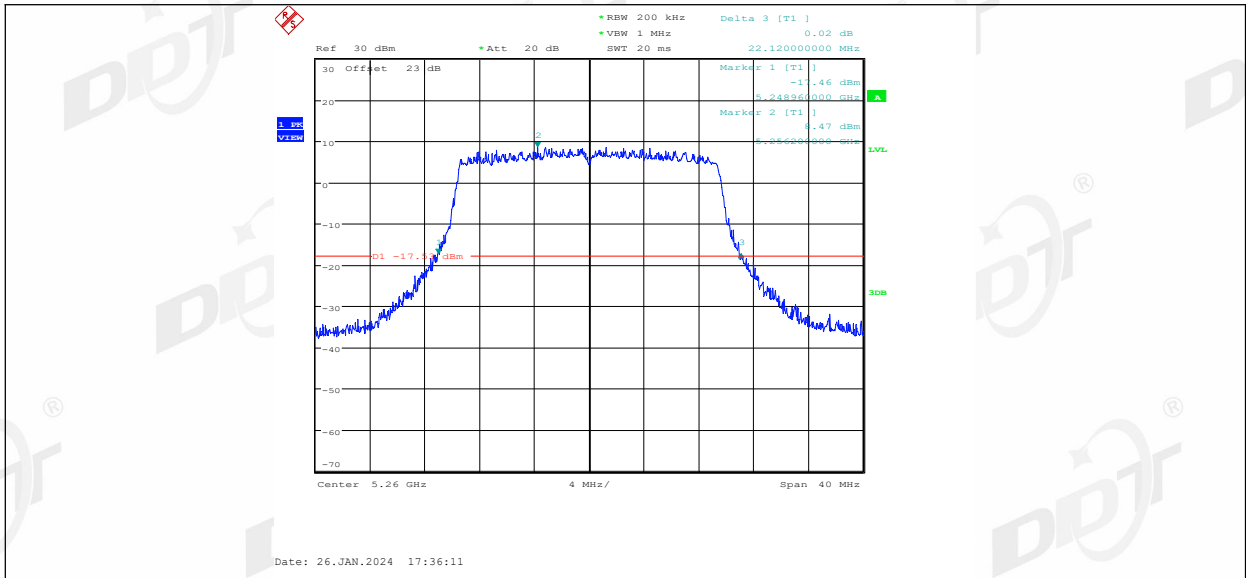

11AX20MIMO Ant1 5280

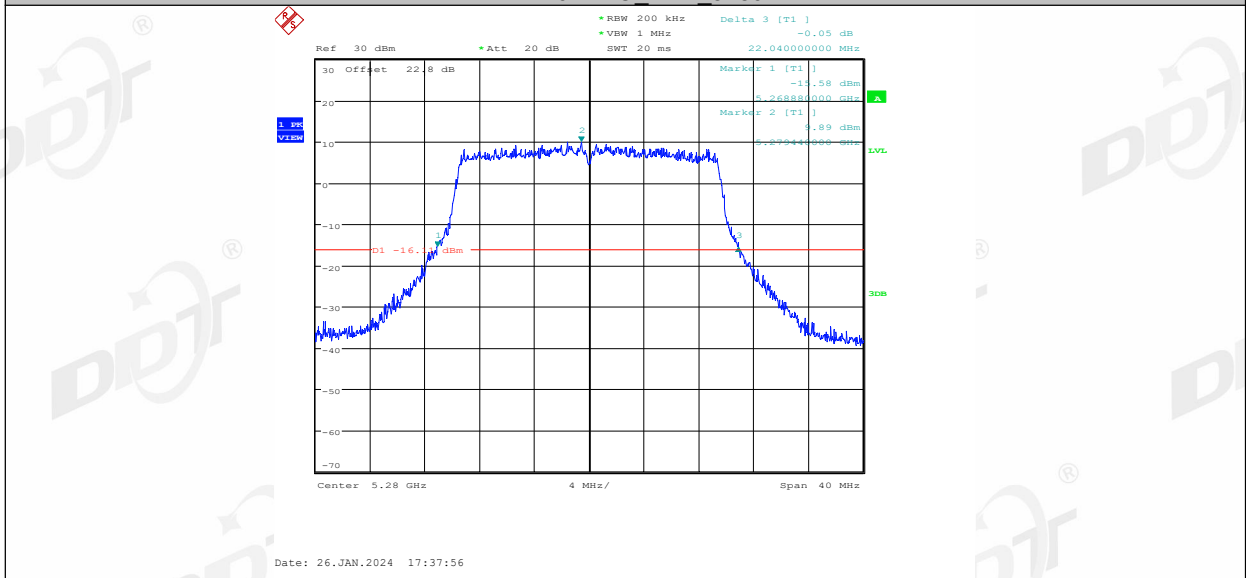

11AX20MIMO Ant2 5280

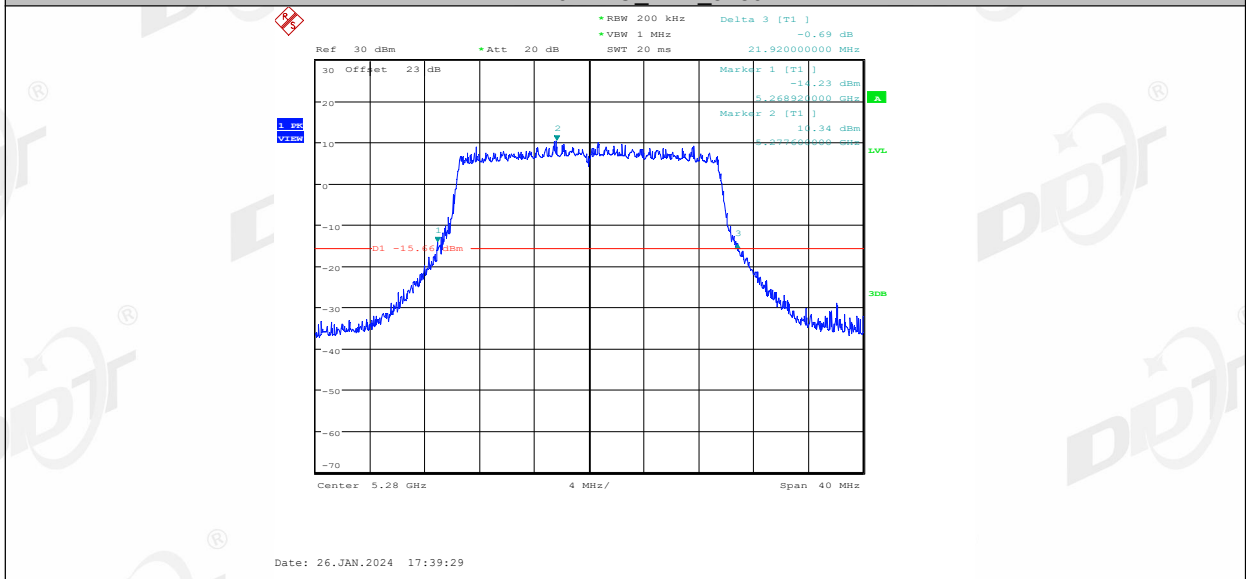

11AX20MIMO Ant1 5320

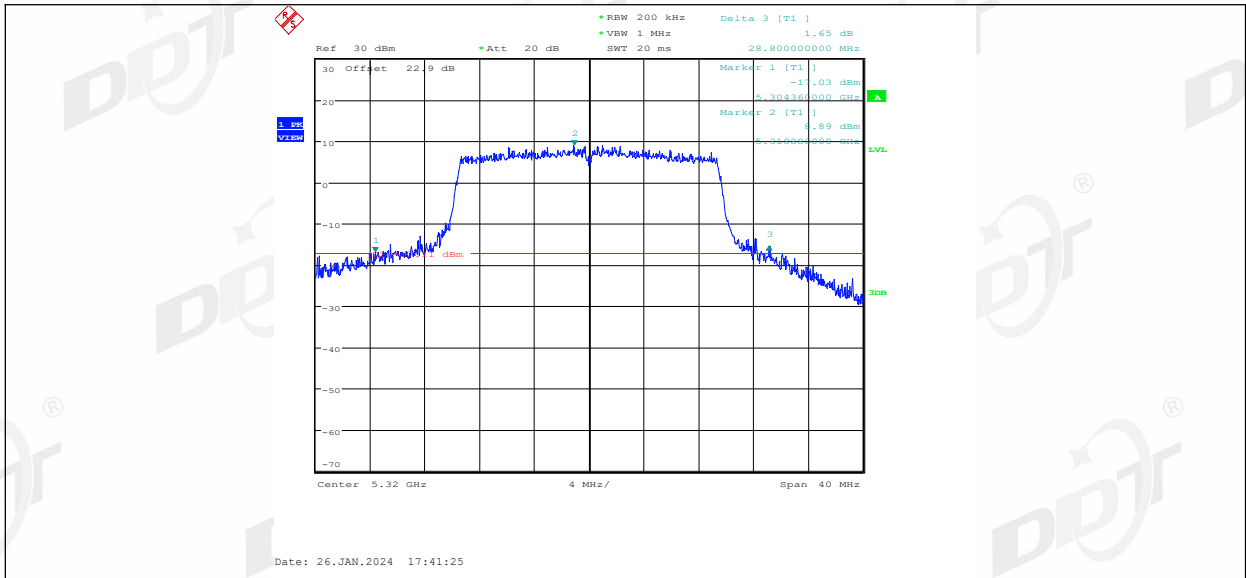

11AX20MIMO Ant2 5320

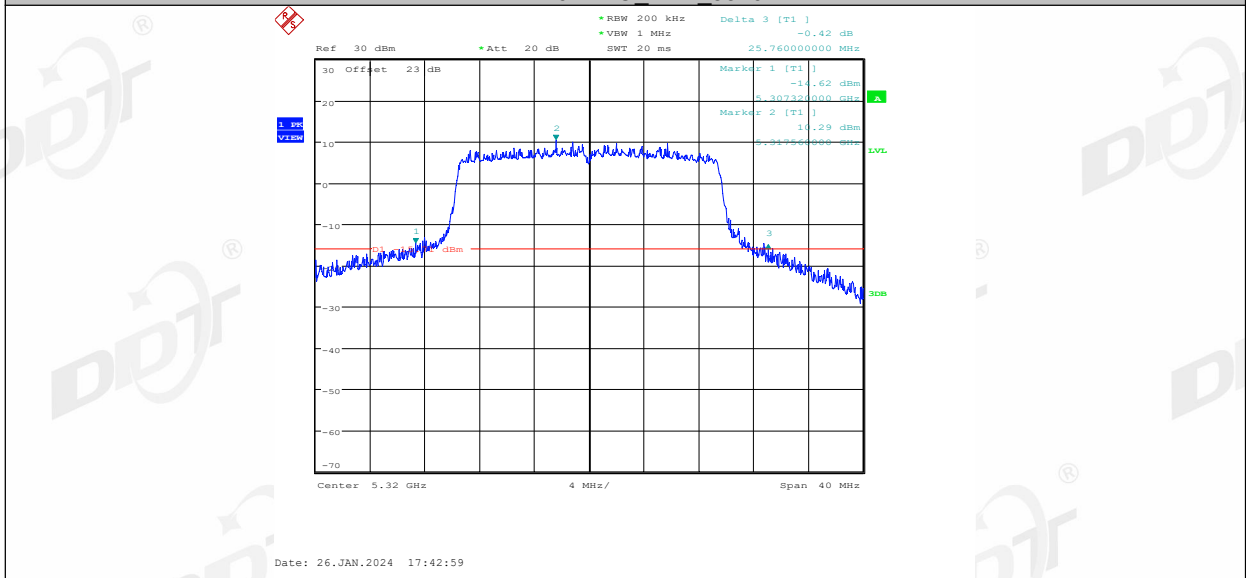

11AX20MIMO Ant1 5500

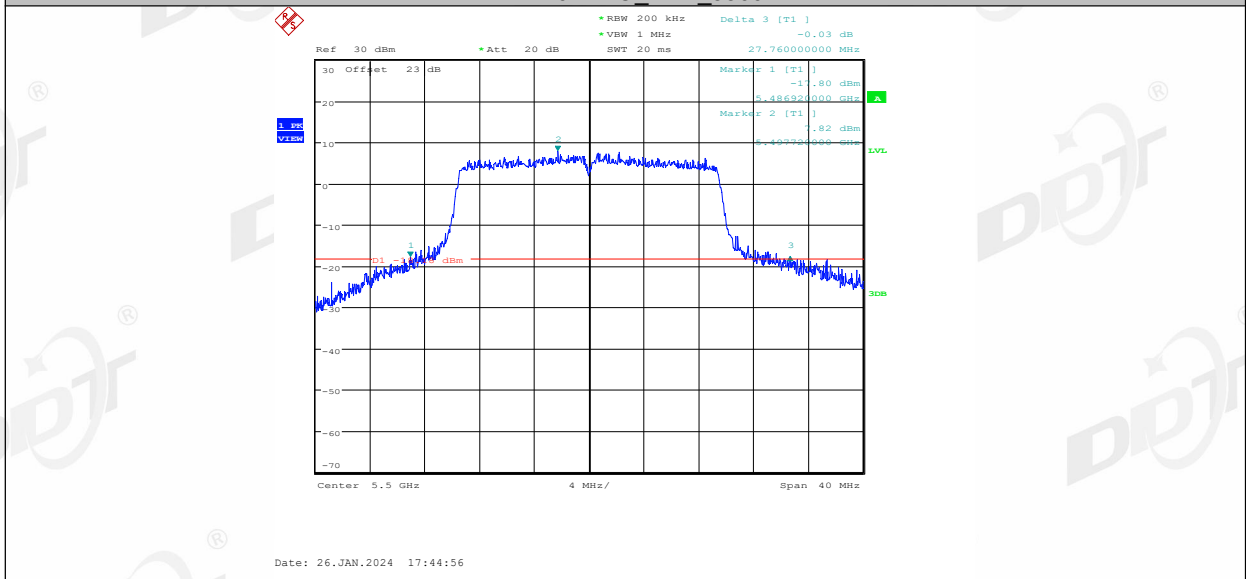

11AX20MIMO Ant2 5500

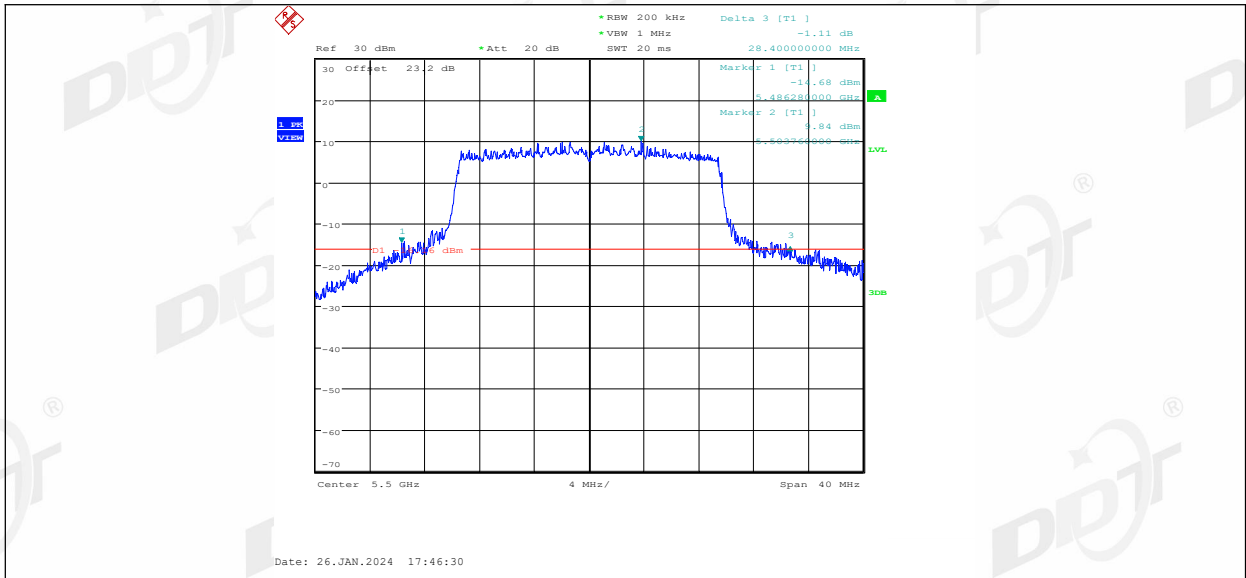

11AX20MIMO Ant1 5580

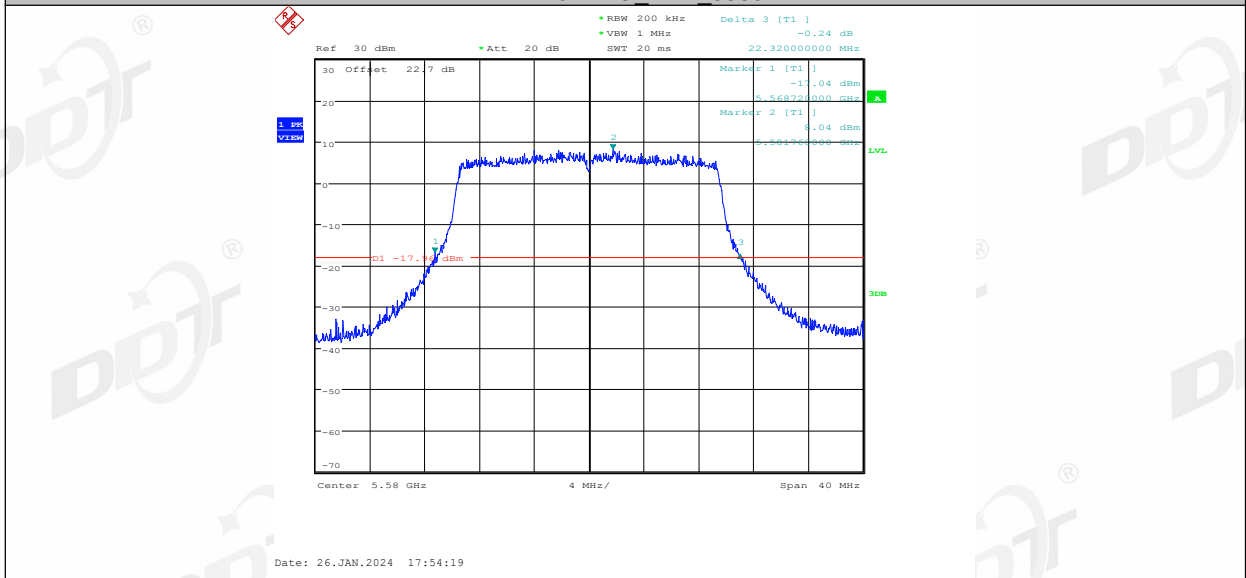

11AX20MIMO Ant2 5580

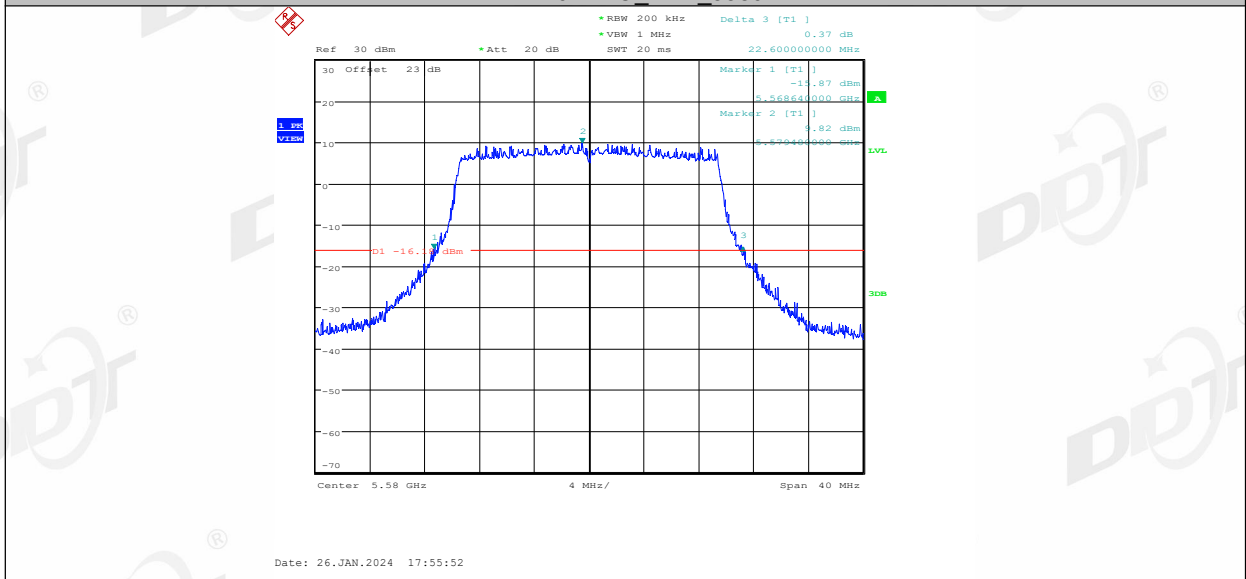

11AX20MIMO Ant1 5700

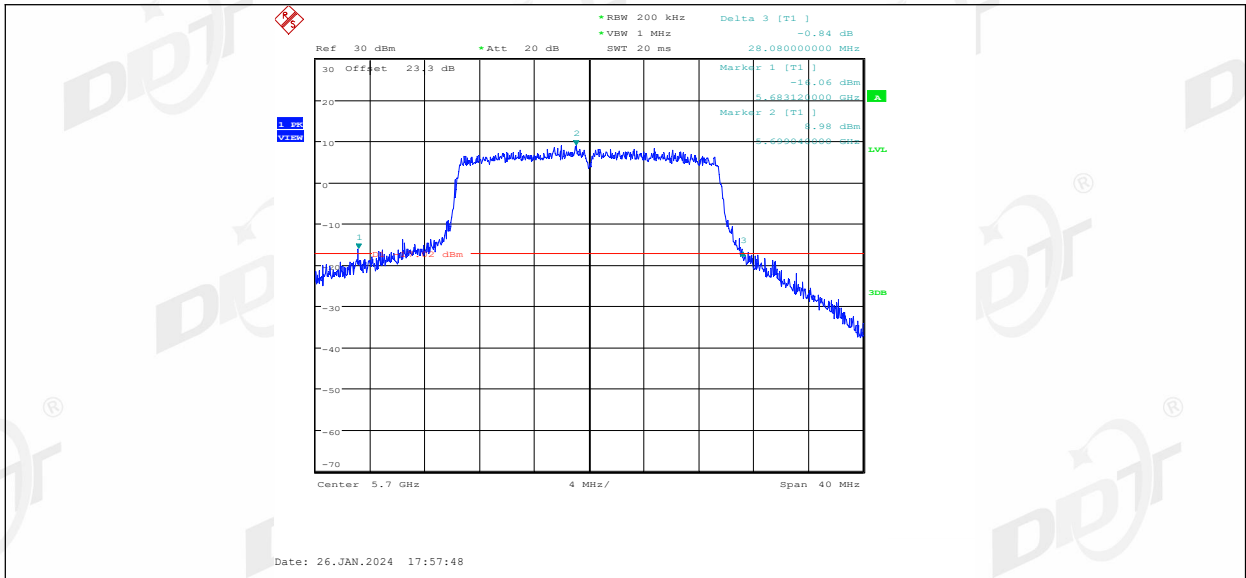

11AX20MIMO Ant2 5700

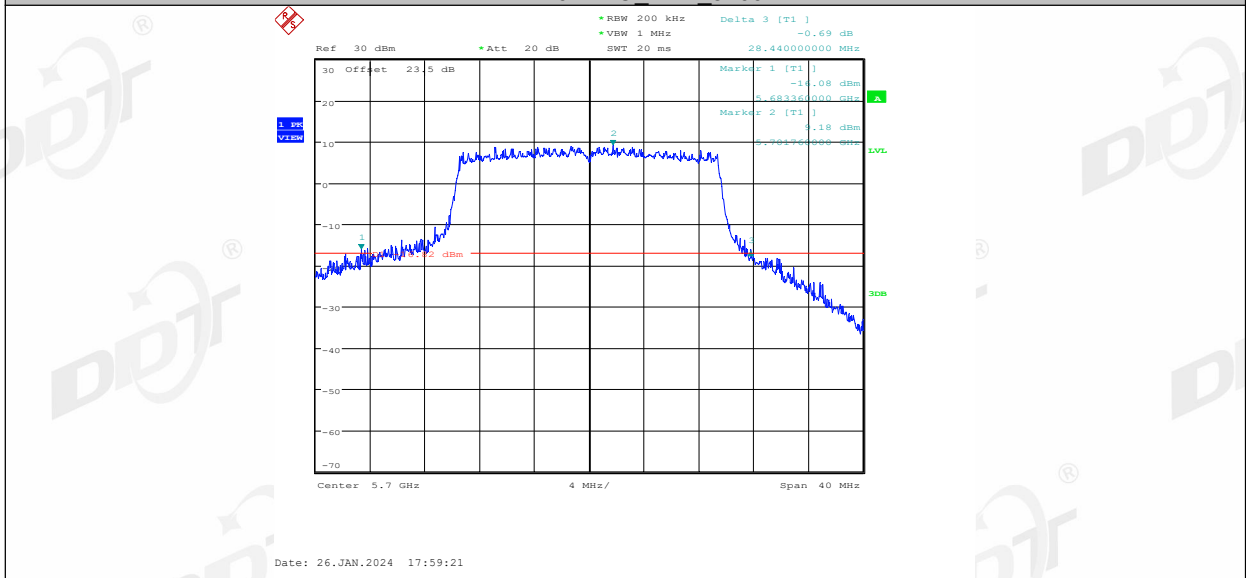

11AX20MIMO Ant1 5720

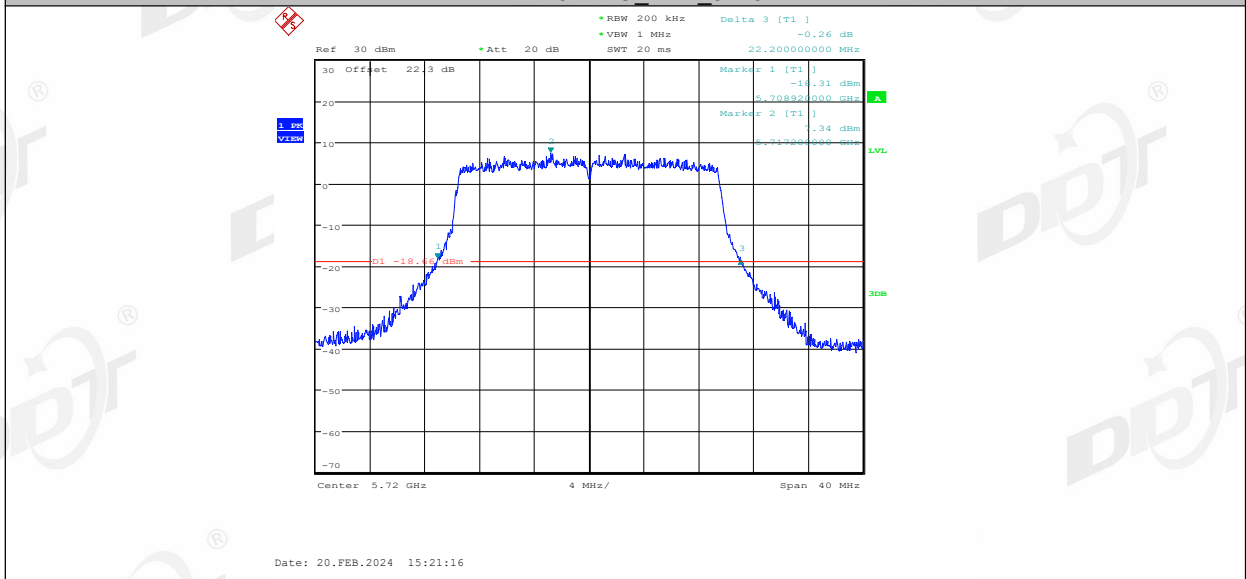

11AX20MIMO Ant2 5720

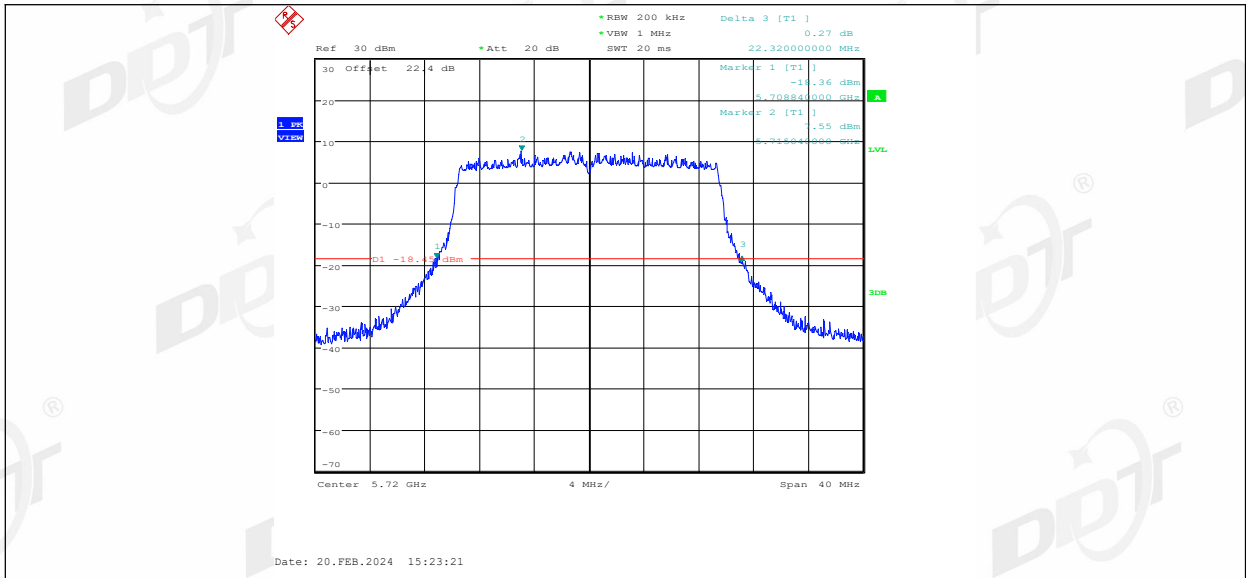

11AX20MIMO Ant1 5745

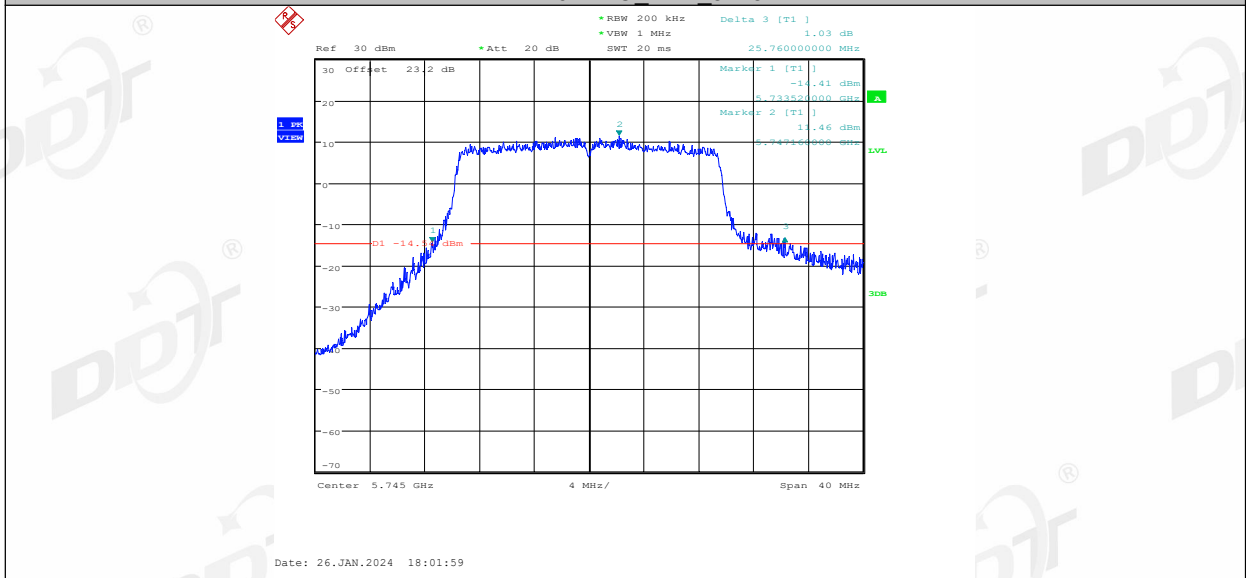

11AX20MIMO Ant2 5745

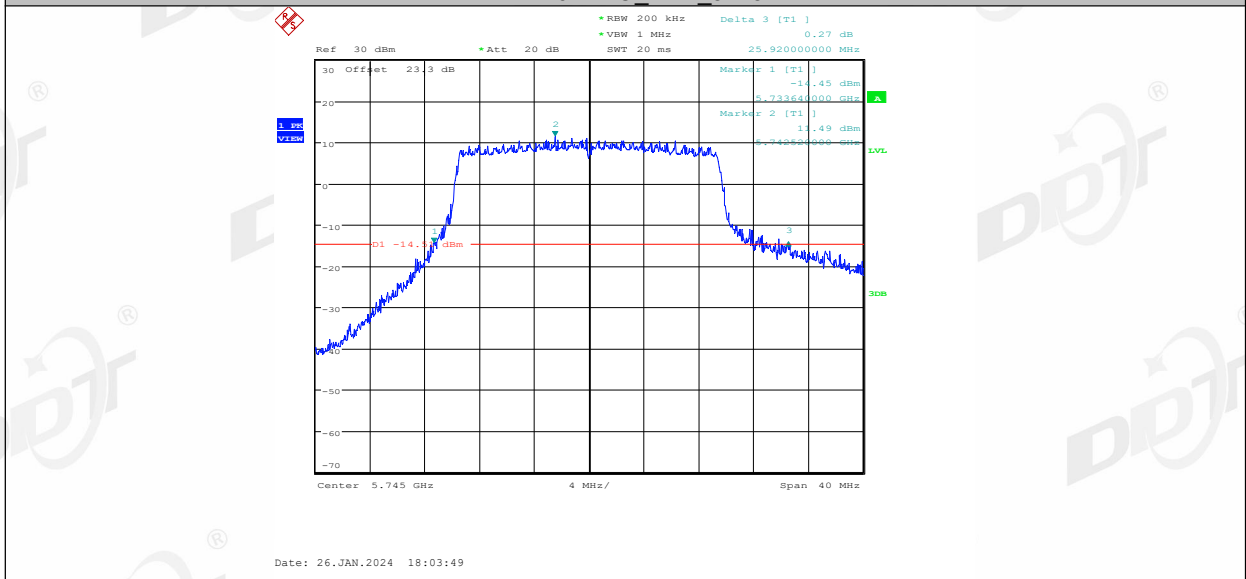

11AX20MIMO Ant1 5785

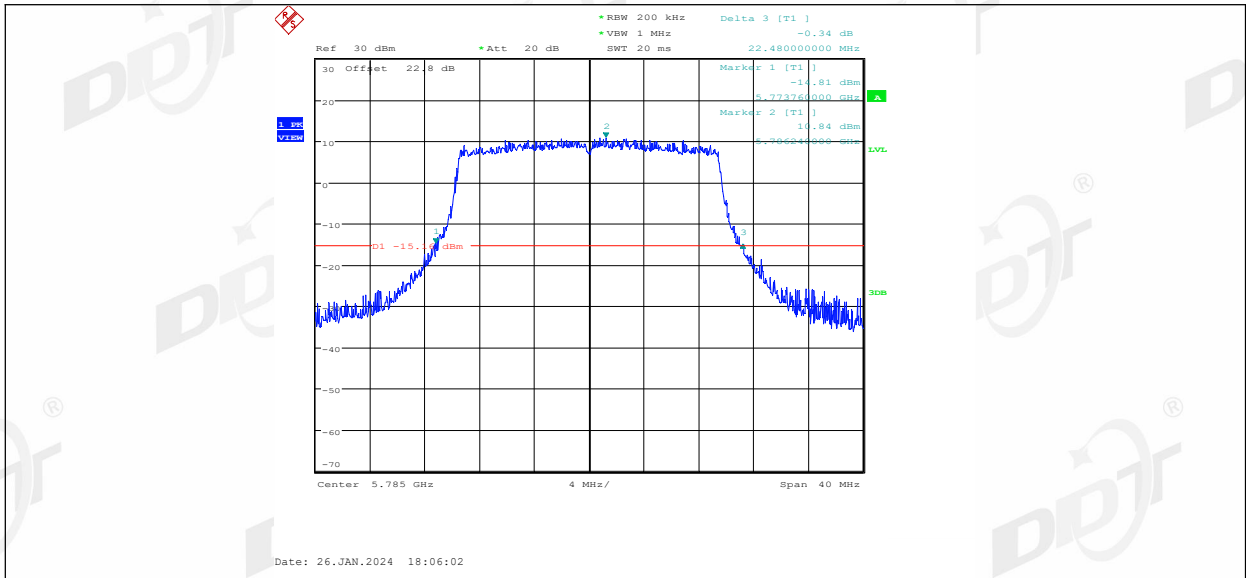

11AX20MIMO Ant2 5785

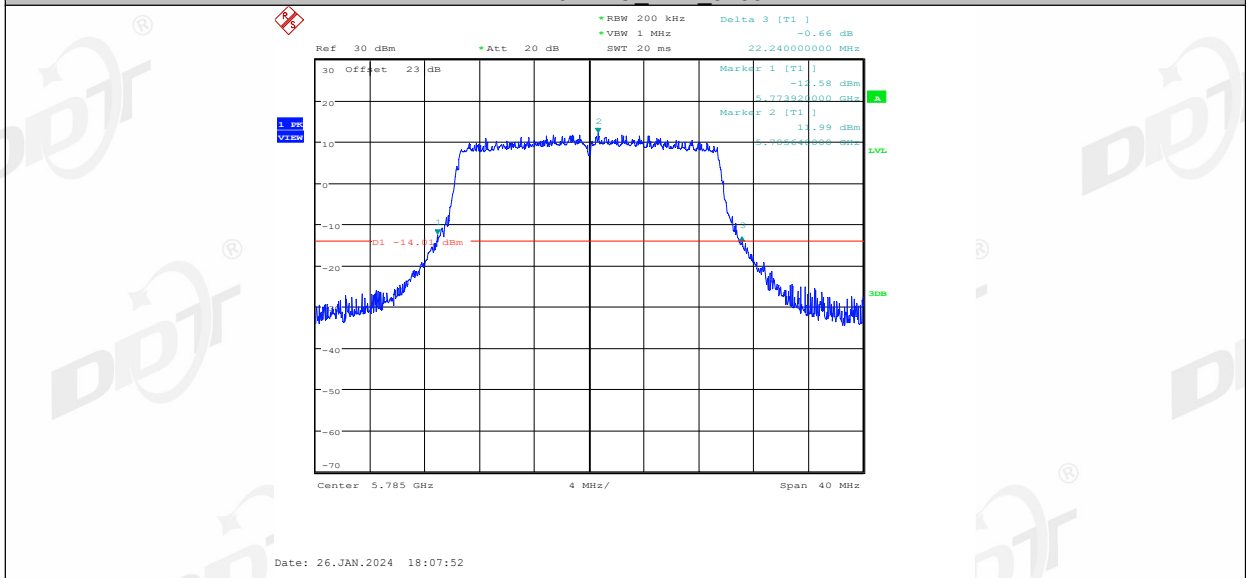

11AX20MIMO Ant1 5825

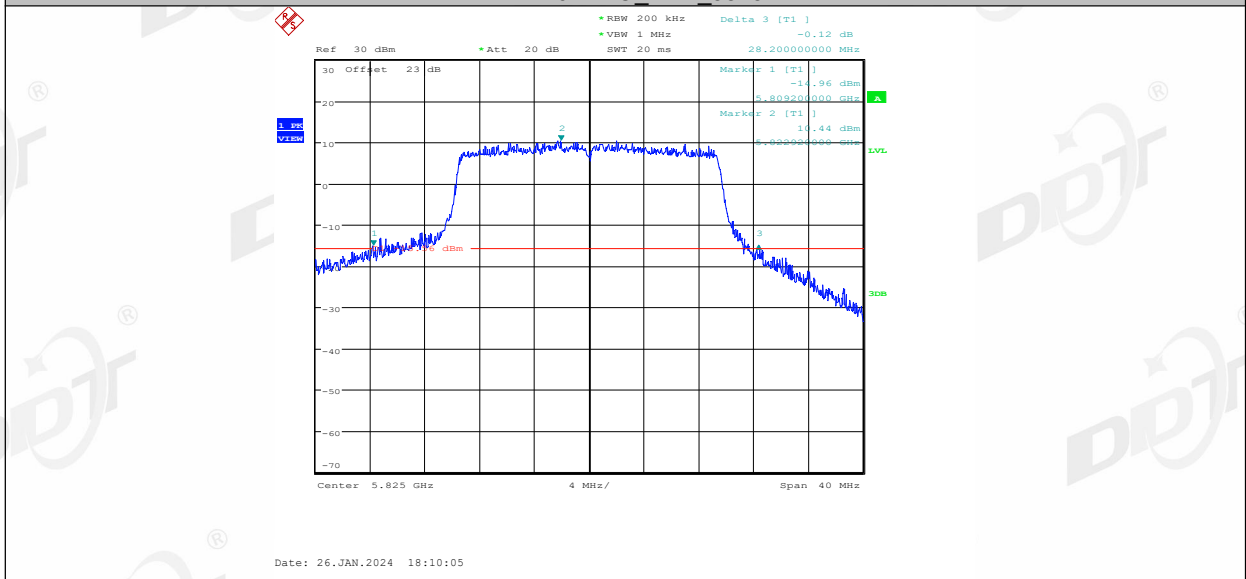

11AX20MIMO Ant2 5825

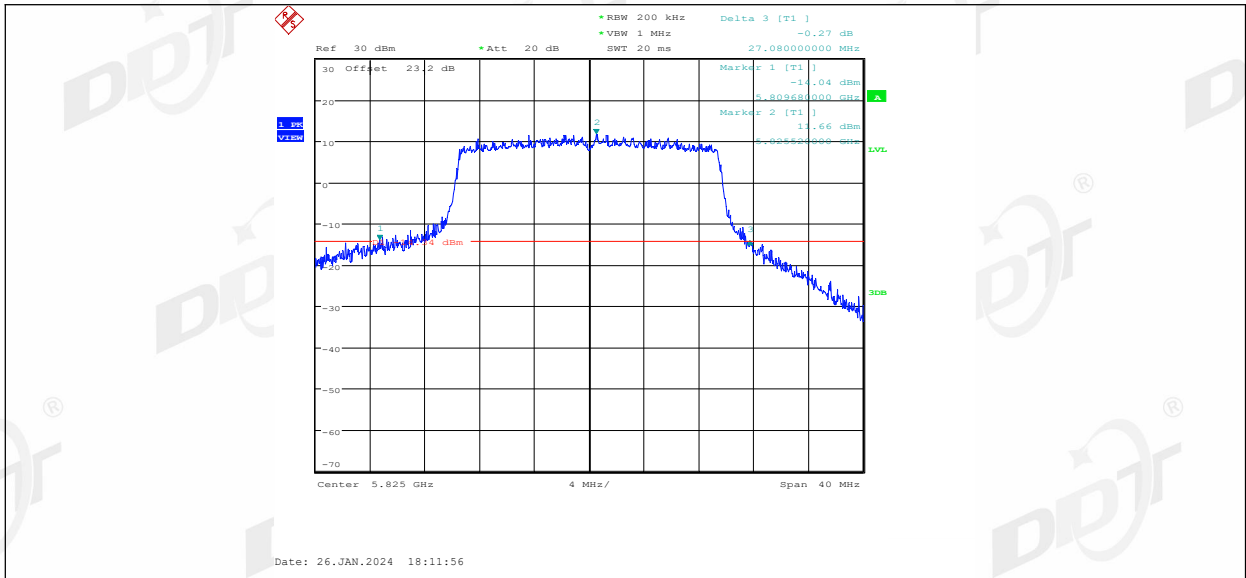

11AX40MIMO Ant1 5190

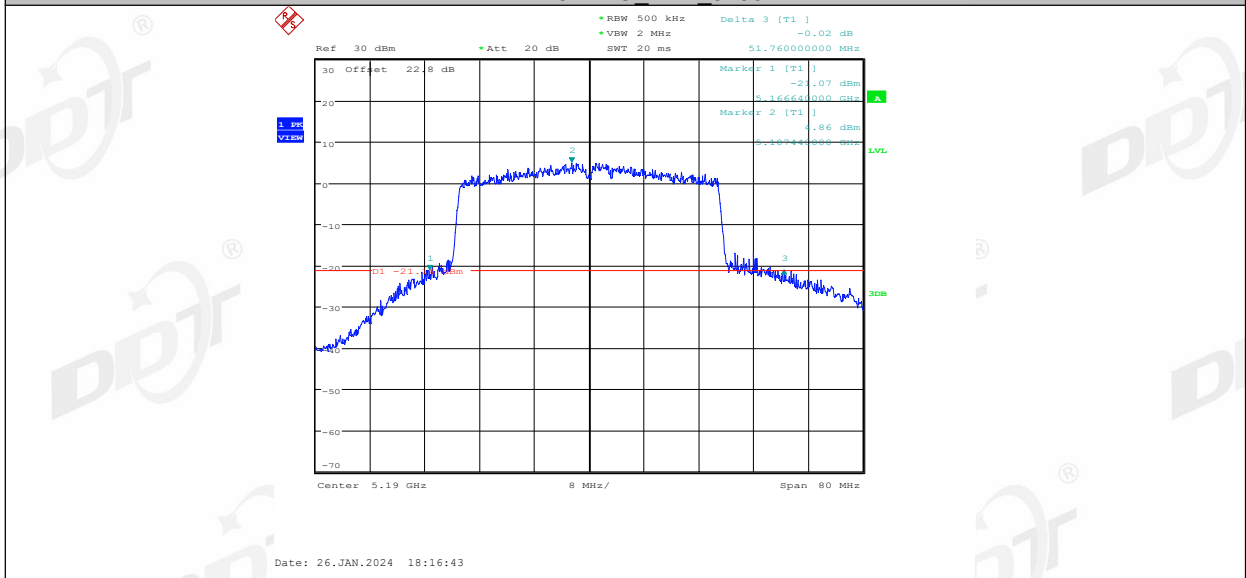

11AX40MIMO Ant2 5190

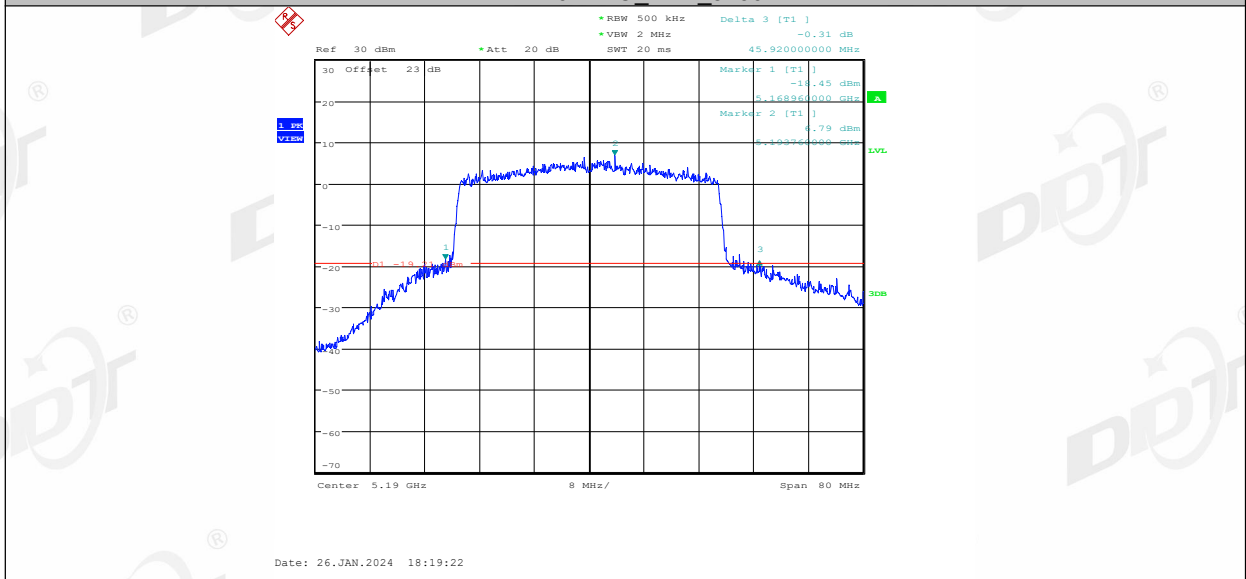

11AX40MIMO Ant1 5230

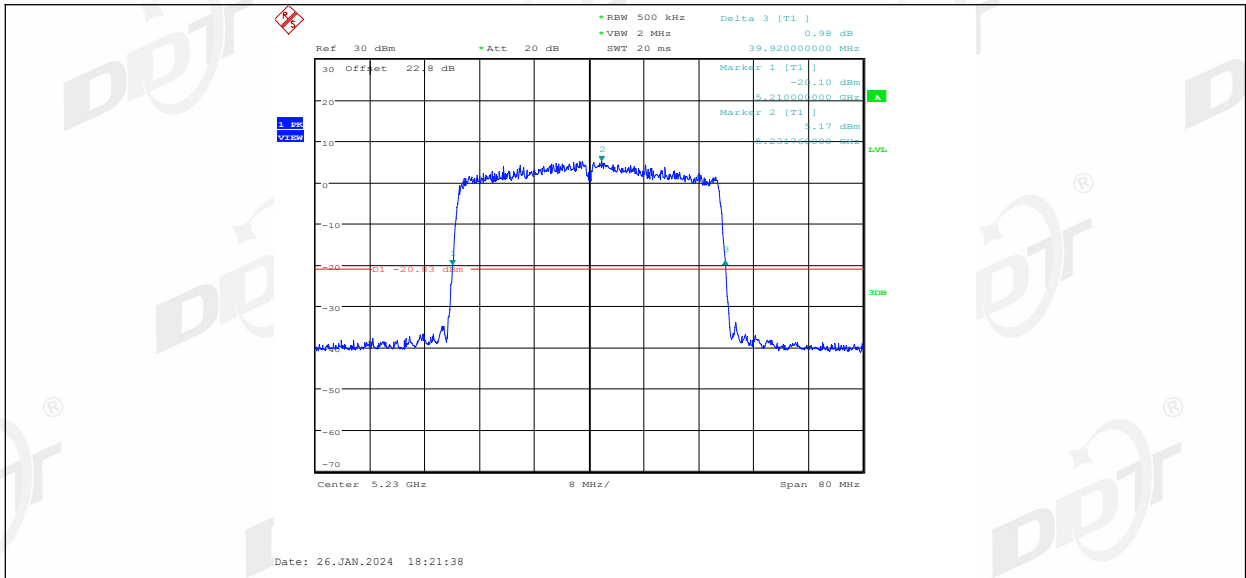

11AX40MIMO Ant2 5230

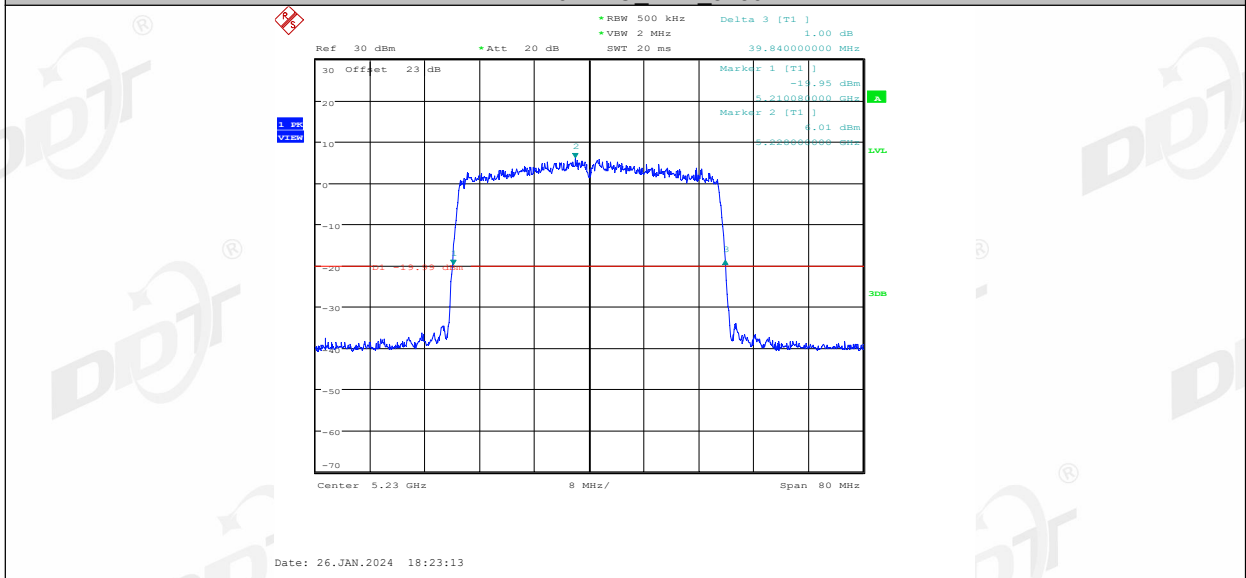

11AX40MIMO Ant1 5270

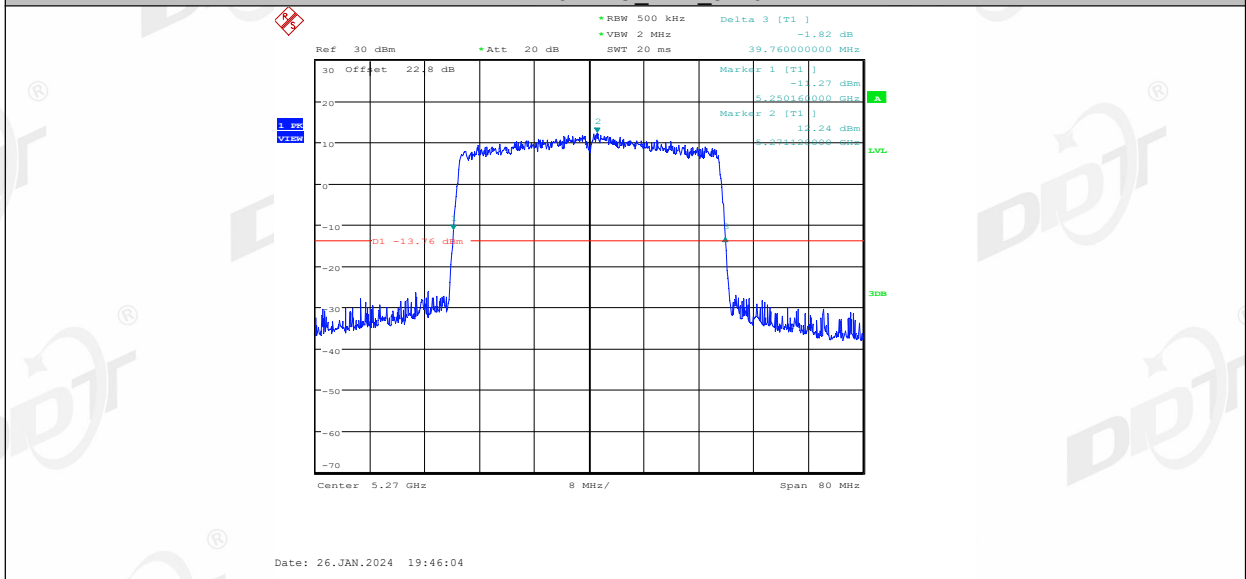

11AX40MIMO Ant2 5270

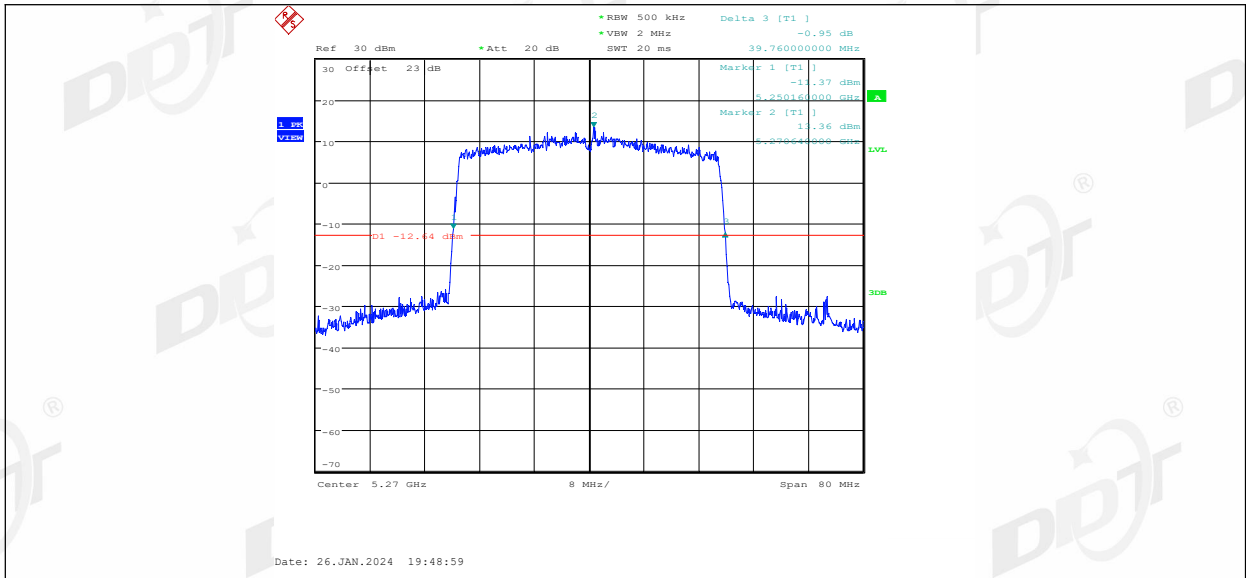

11AX40MIMO Ant1 5310

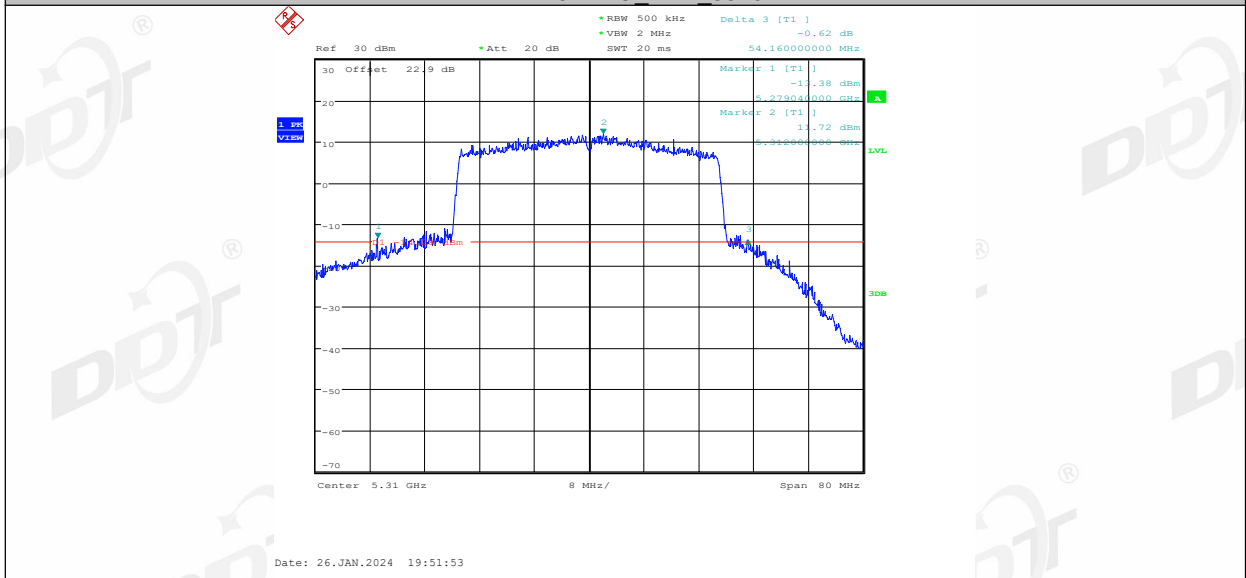

11AX40MIMO Ant2 5310

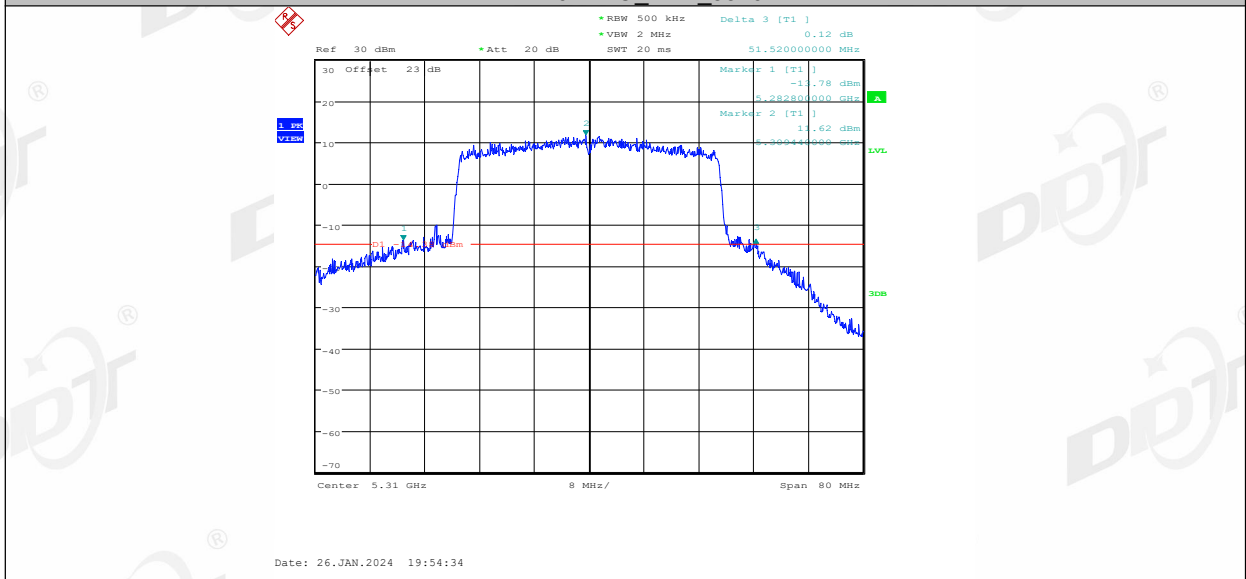

11AX40MIMO Ant1 5510

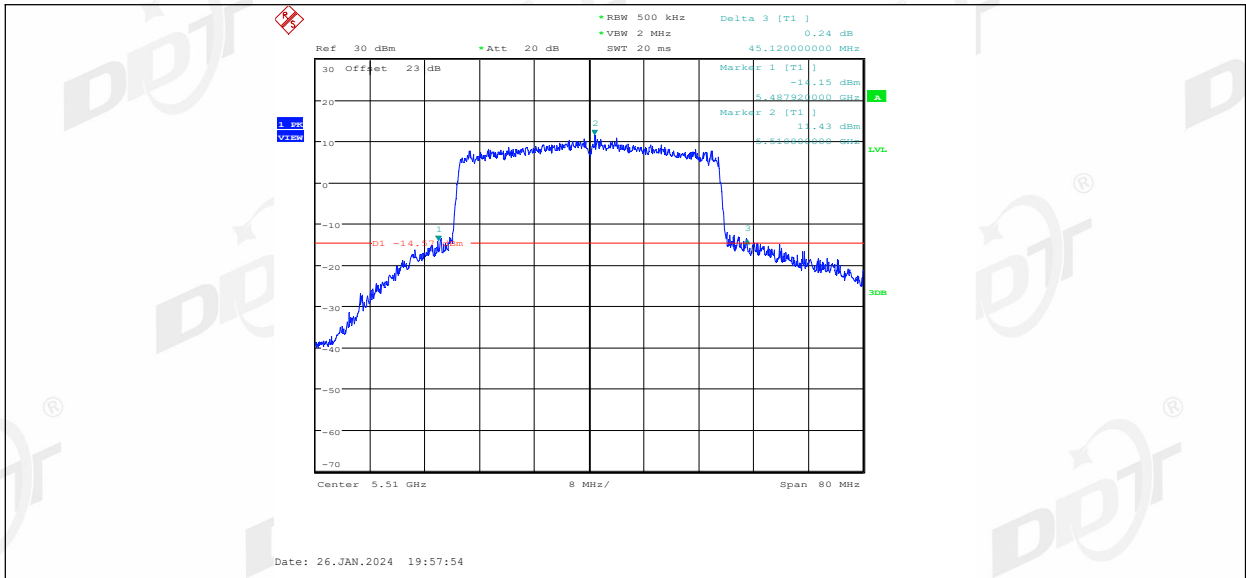

11AX40MIMO Ant2 5510

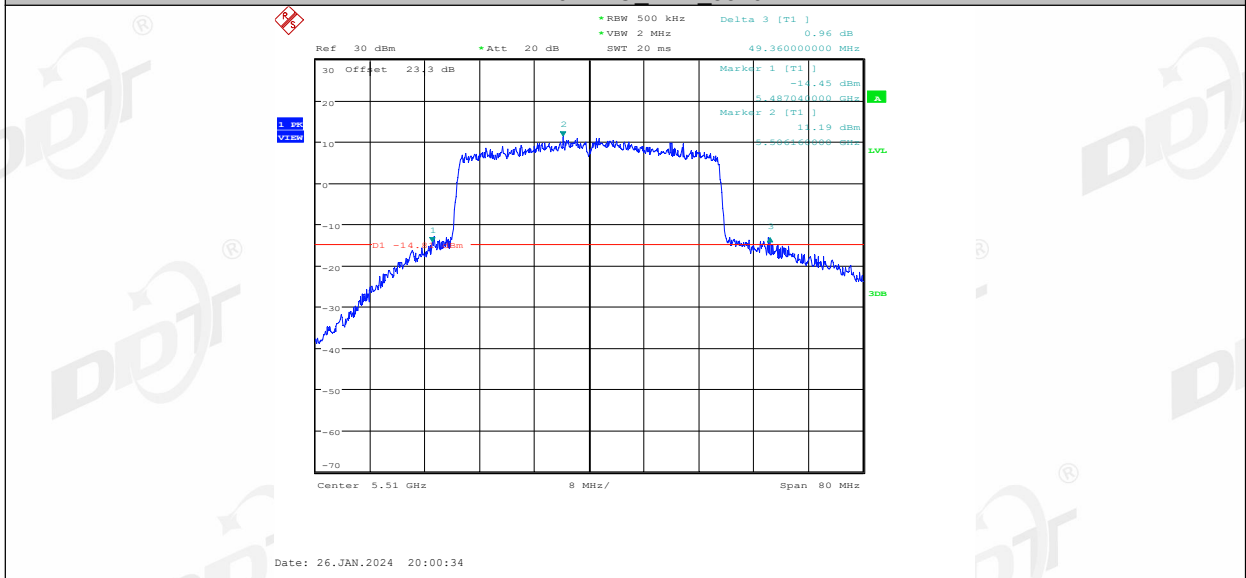

11AX40MIMO Ant1 5550

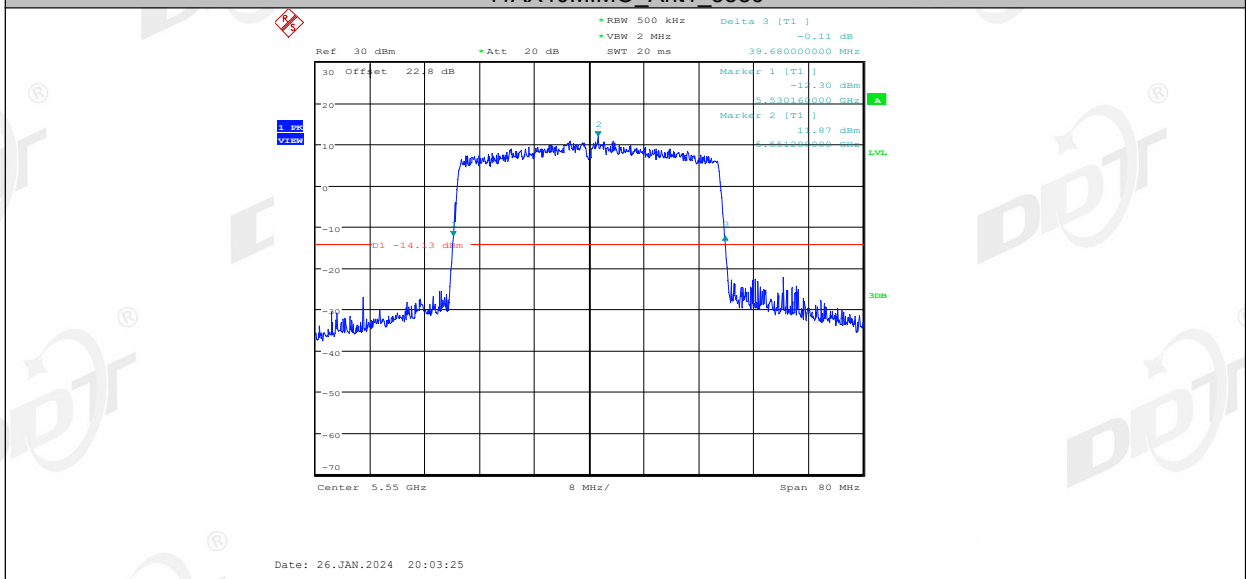

11AX40MIMO Ant2 5550

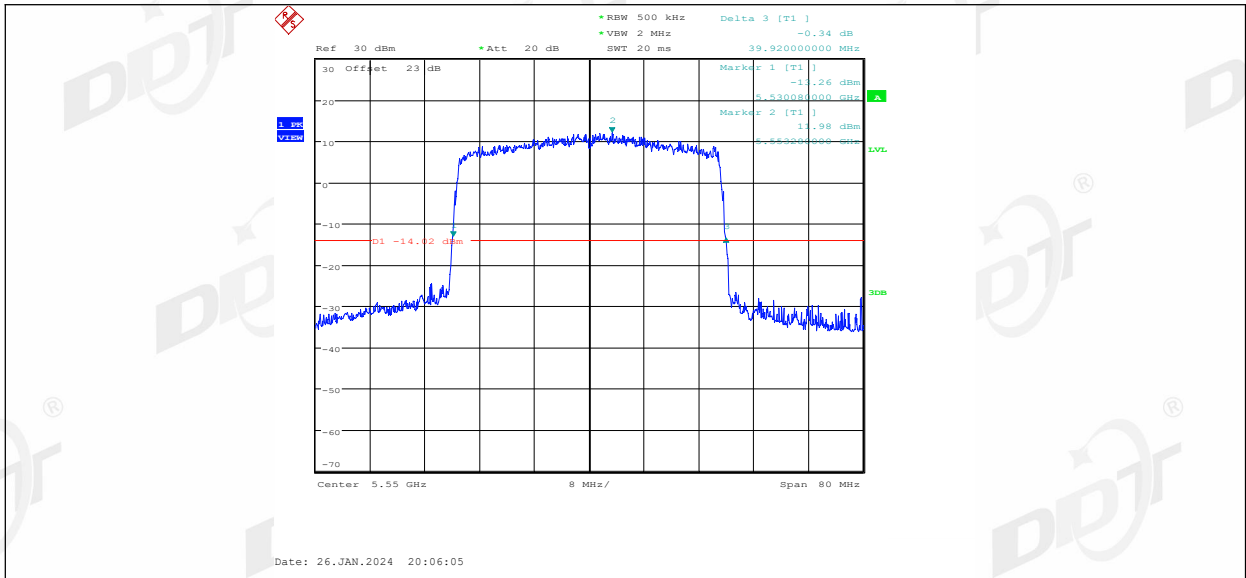

11AX40MIMO Ant1 5670

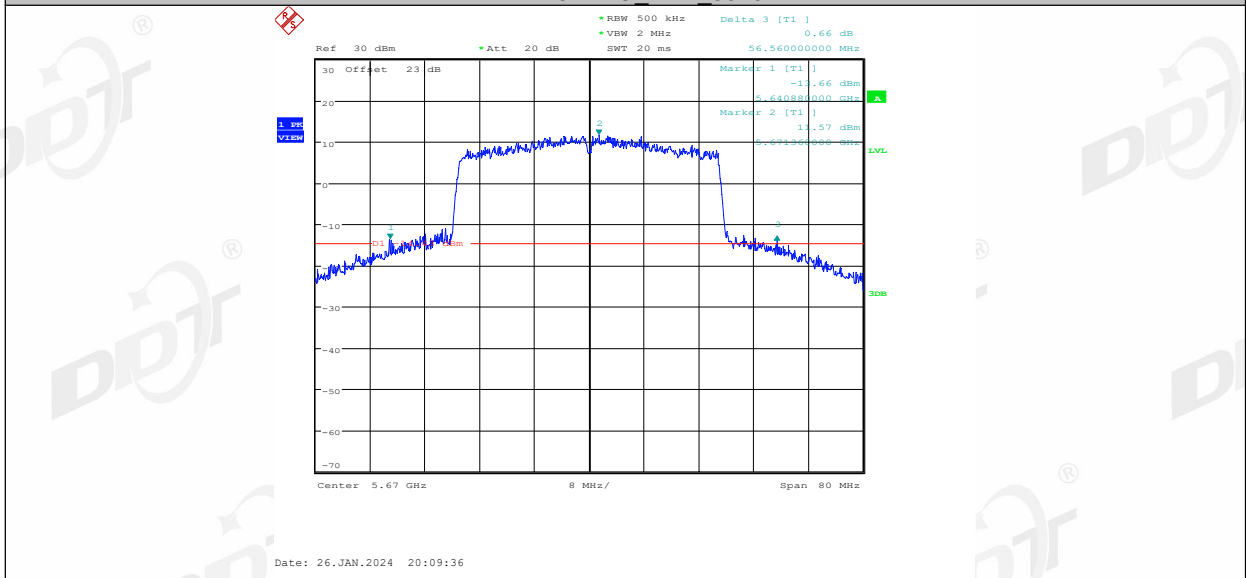

11AX40MIMO Ant2 5670

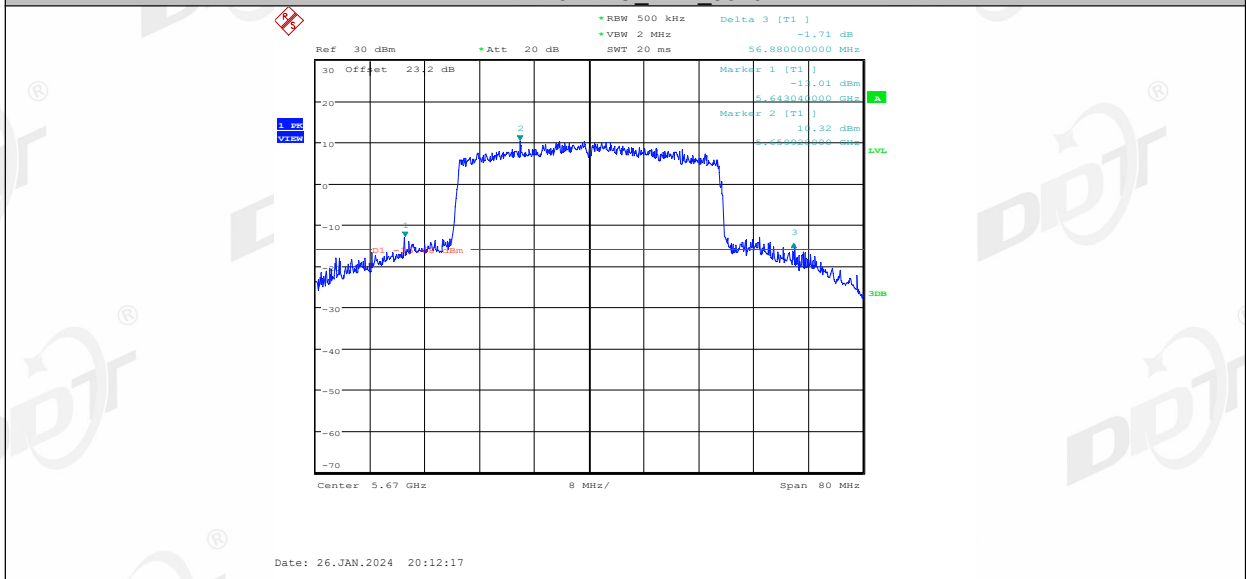

11AX40MIMO Ant1 5710

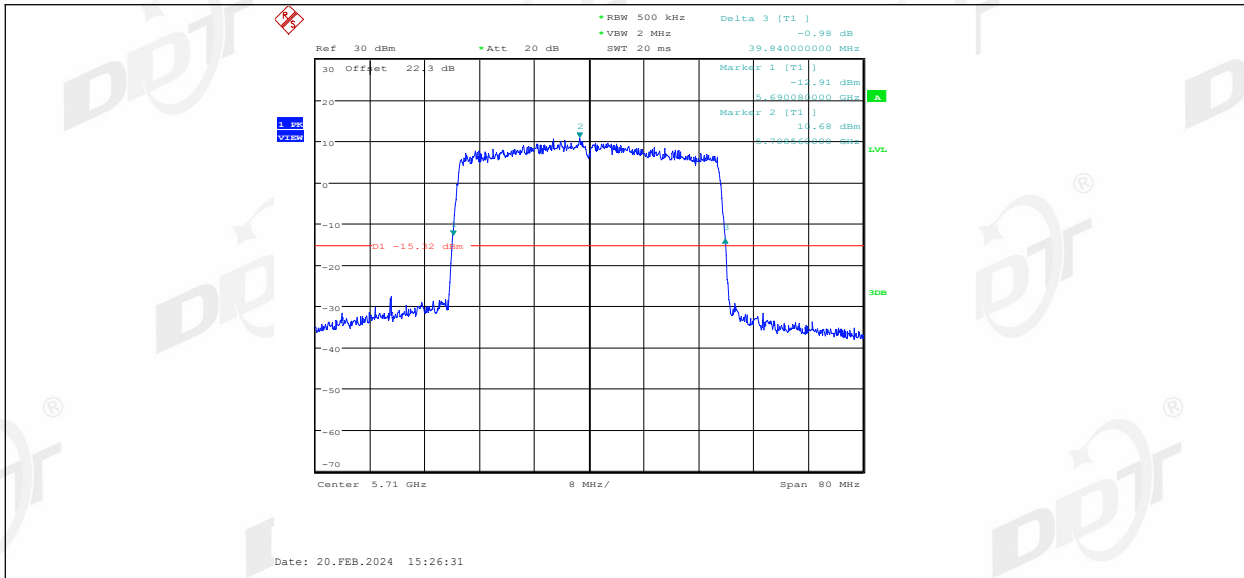

11AX40MIMO Ant2 5710

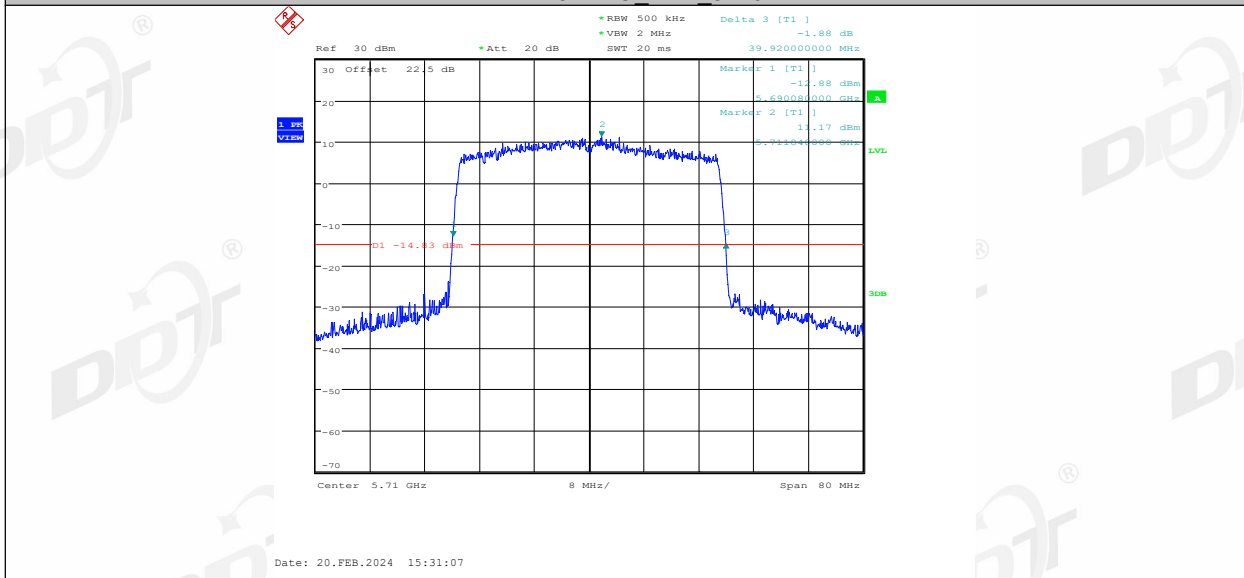

11AX40MIMO Ant1 5755

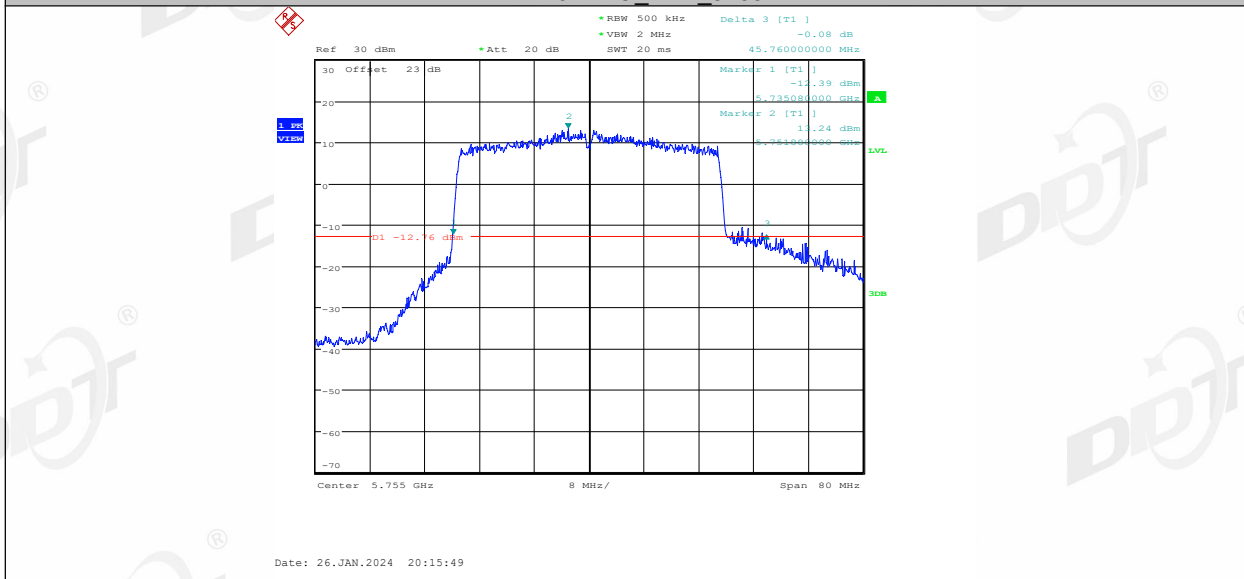

11AX40MIMO Ant2 5755

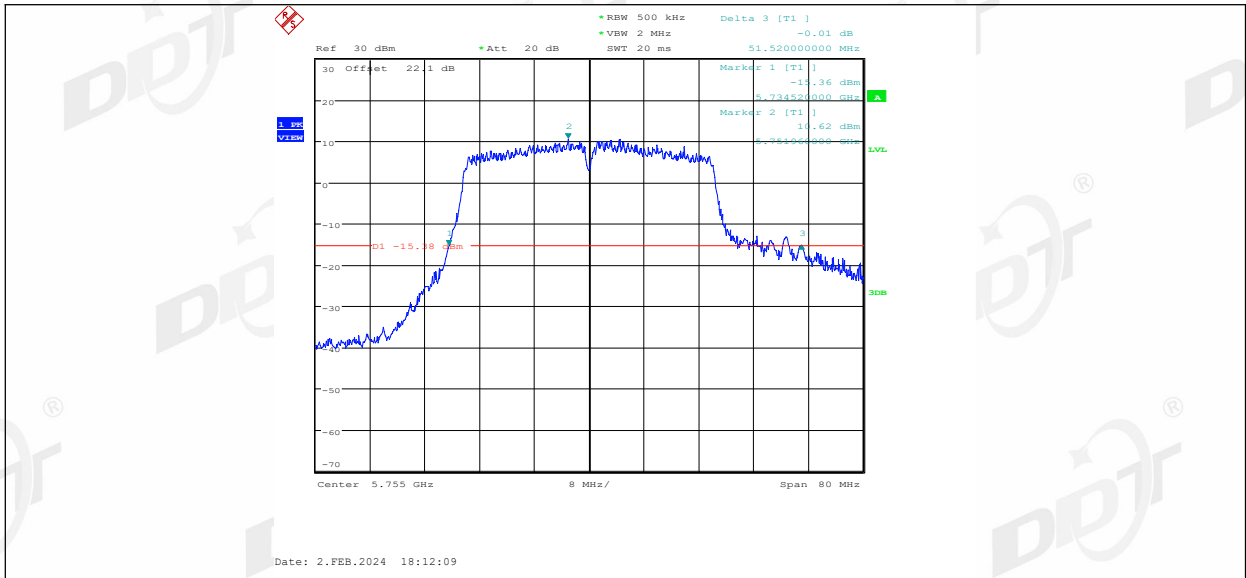

11AX40MIMO Ant1 5795

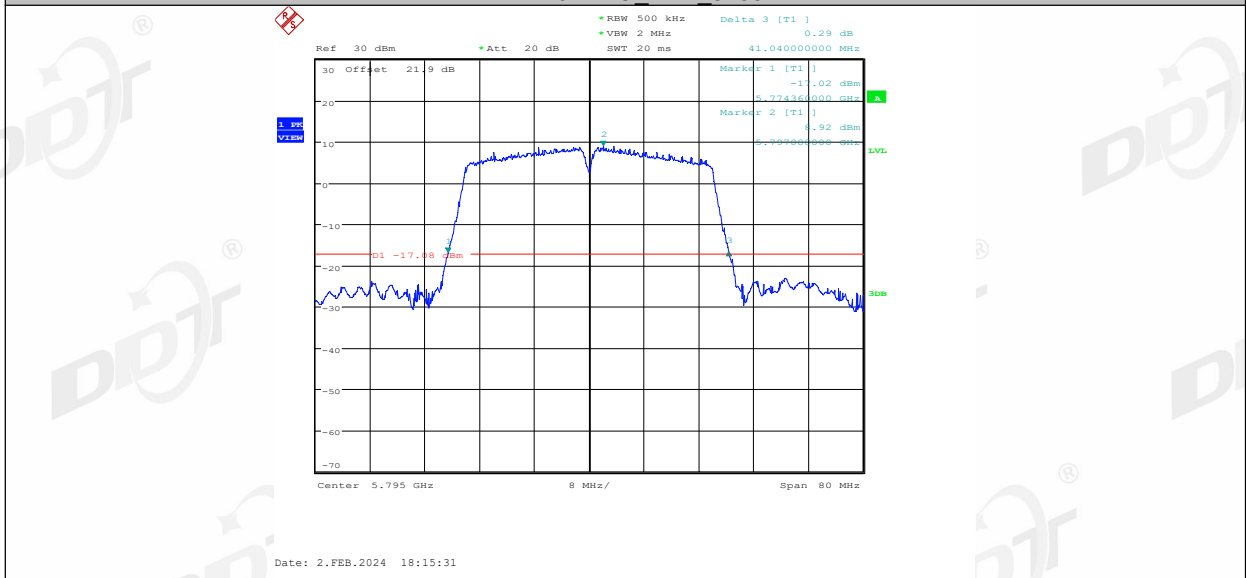

11AX40MIMO Ant2 5795

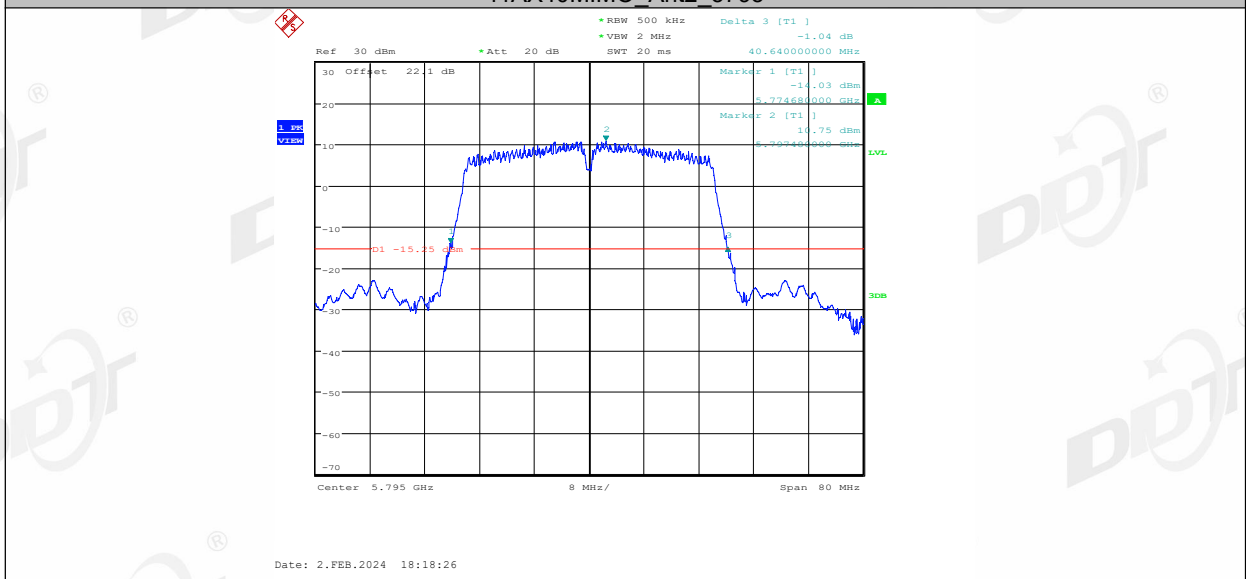

11AX80MIMO Ant1 5210

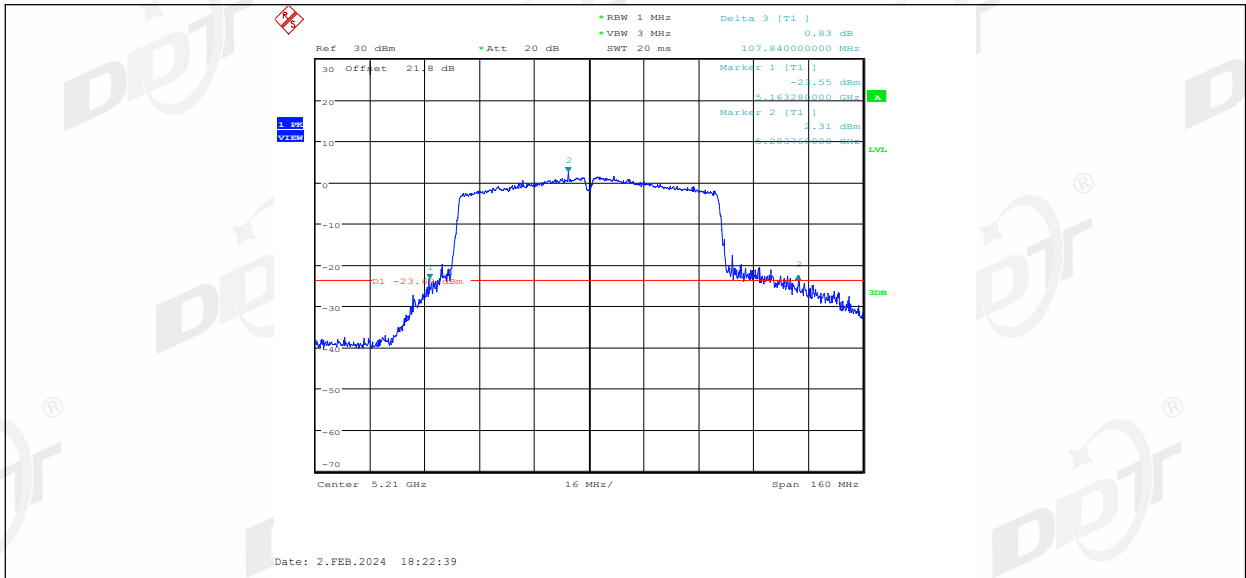

11AX80MIMO Ant2 5210

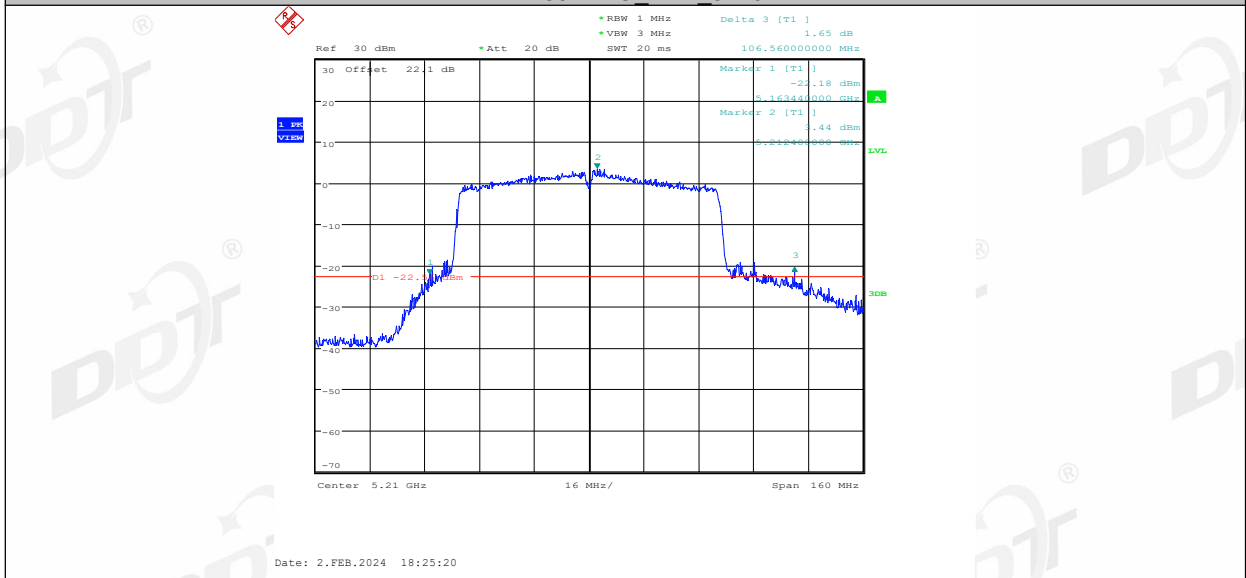

11AX80MIMO Ant1 5290

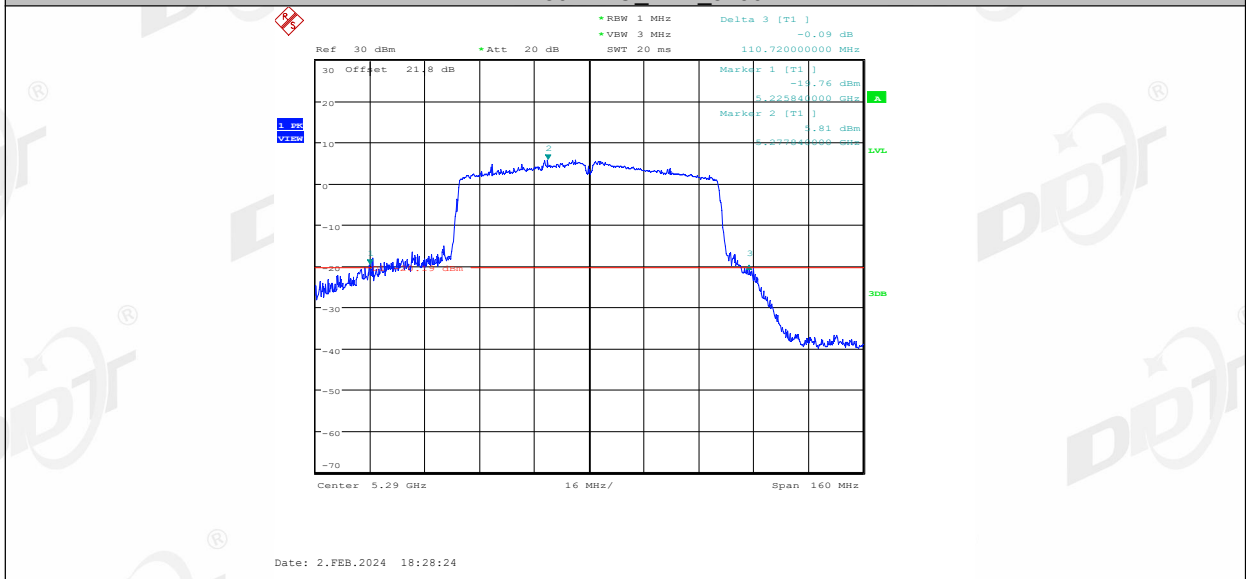

11AX80MIMO Ant2 5290

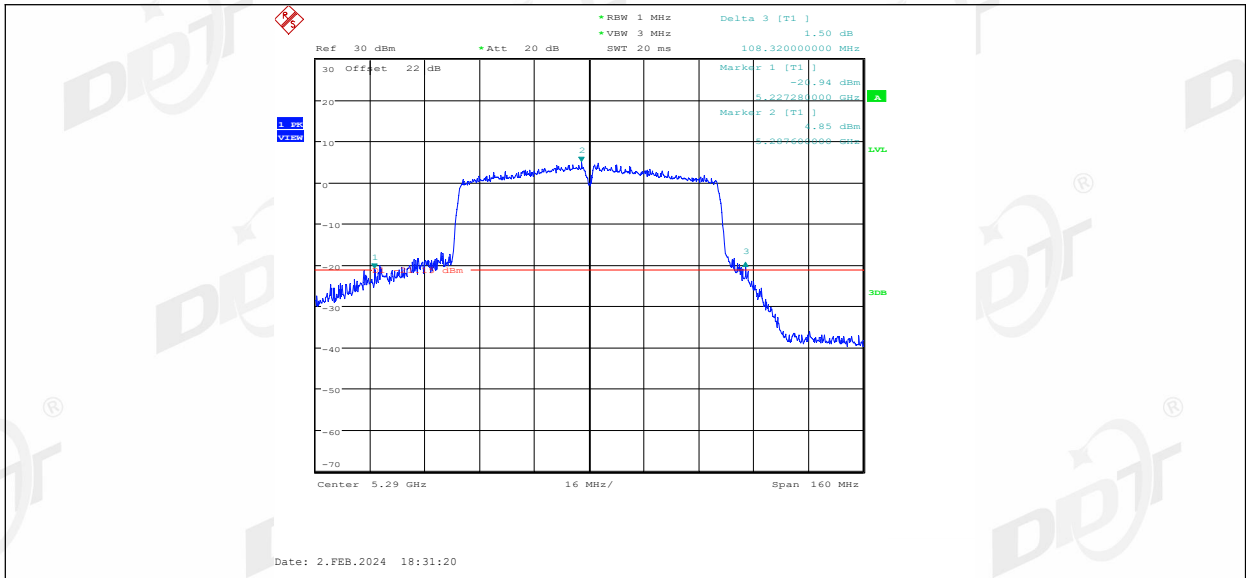

11AX80MIMO Ant1 5530

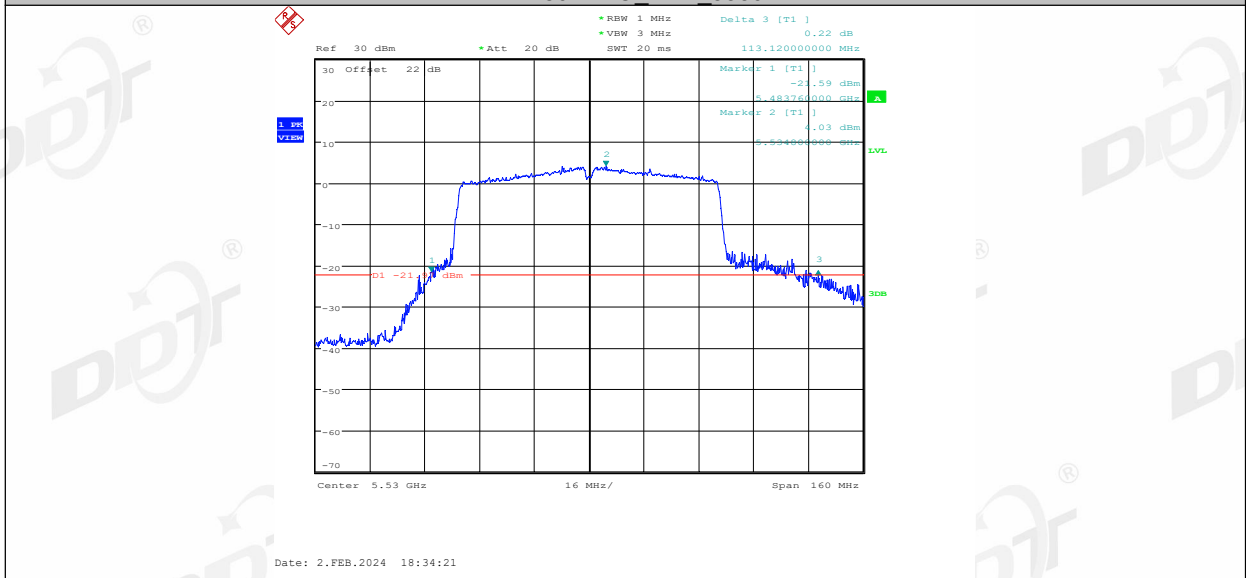

11AX80MIMO Ant2 5530

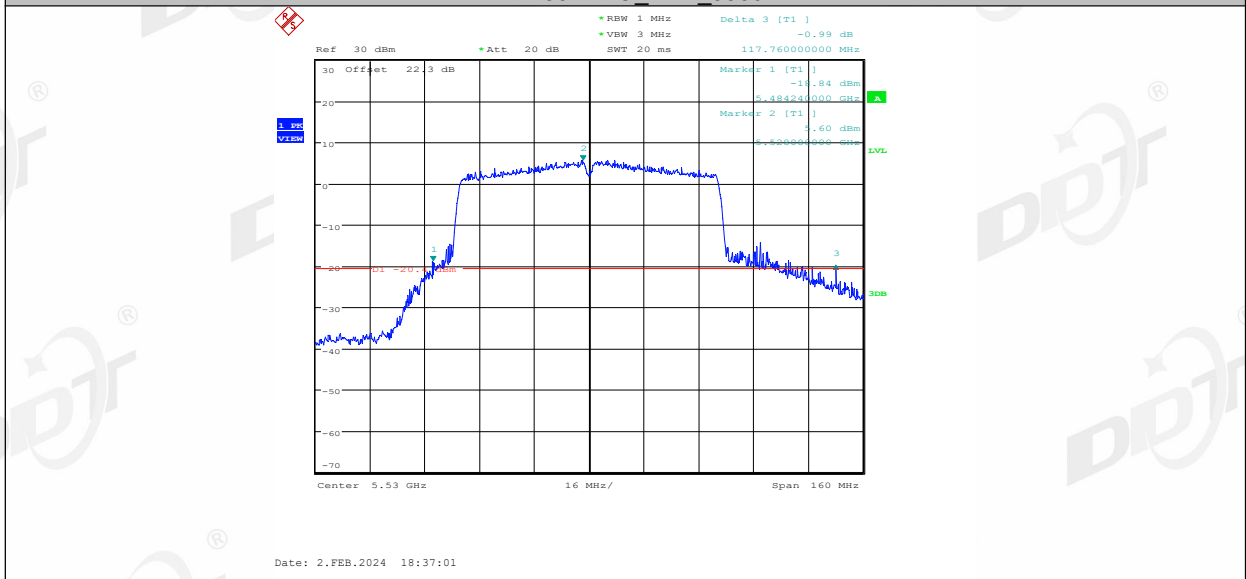

11AX80MIMO Ant1 5610

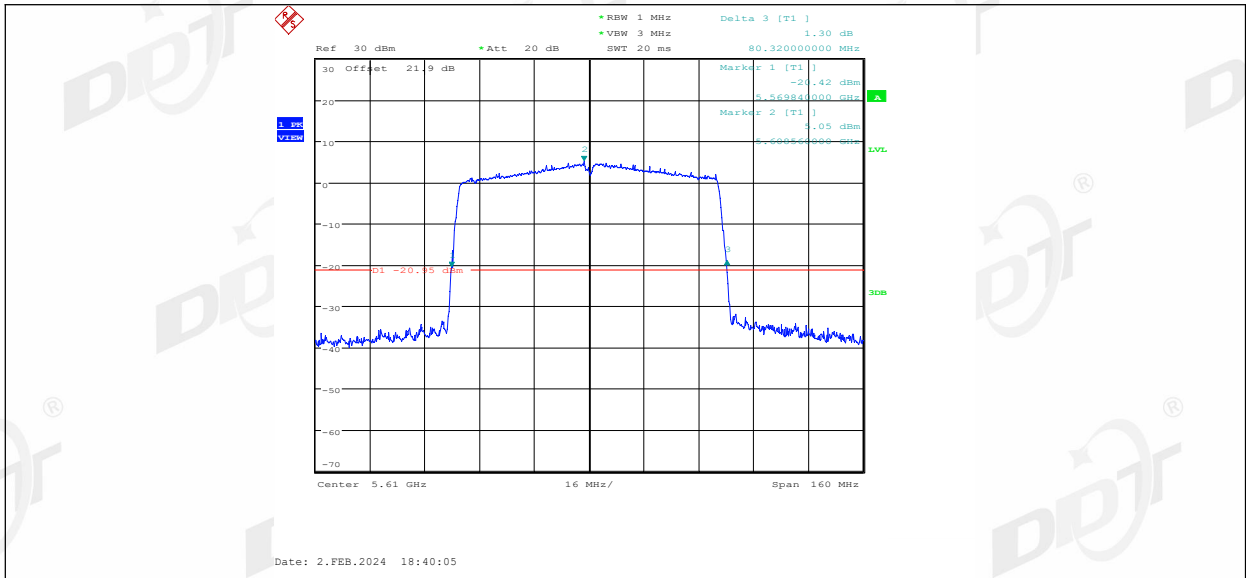

11AX80MIMO Ant2 5610

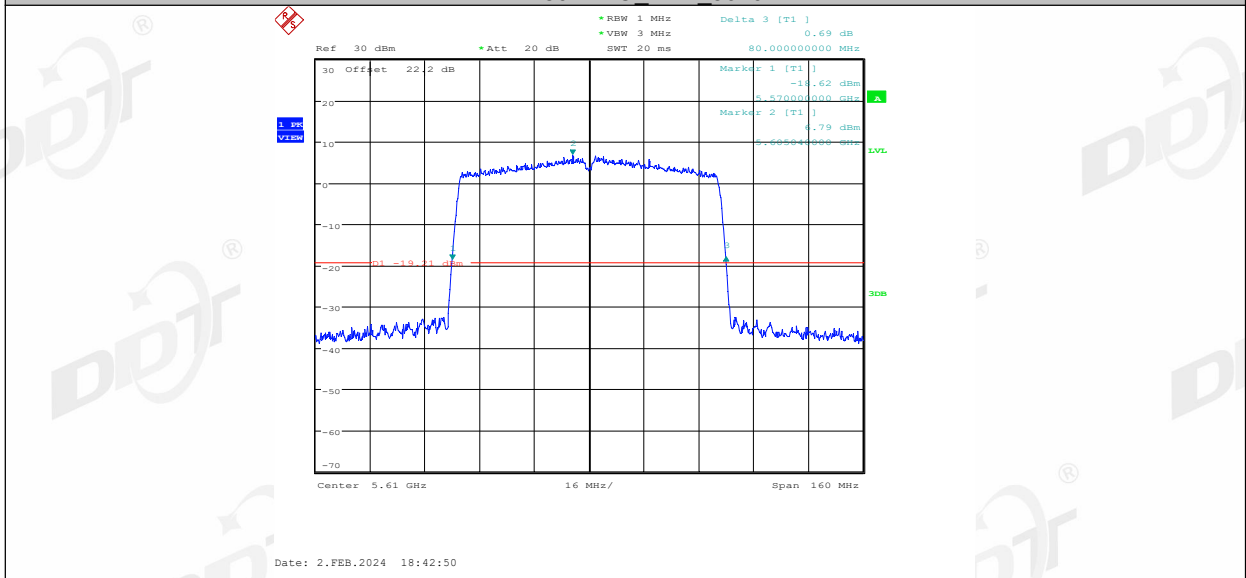

11AX80MIMO Ant1 5690

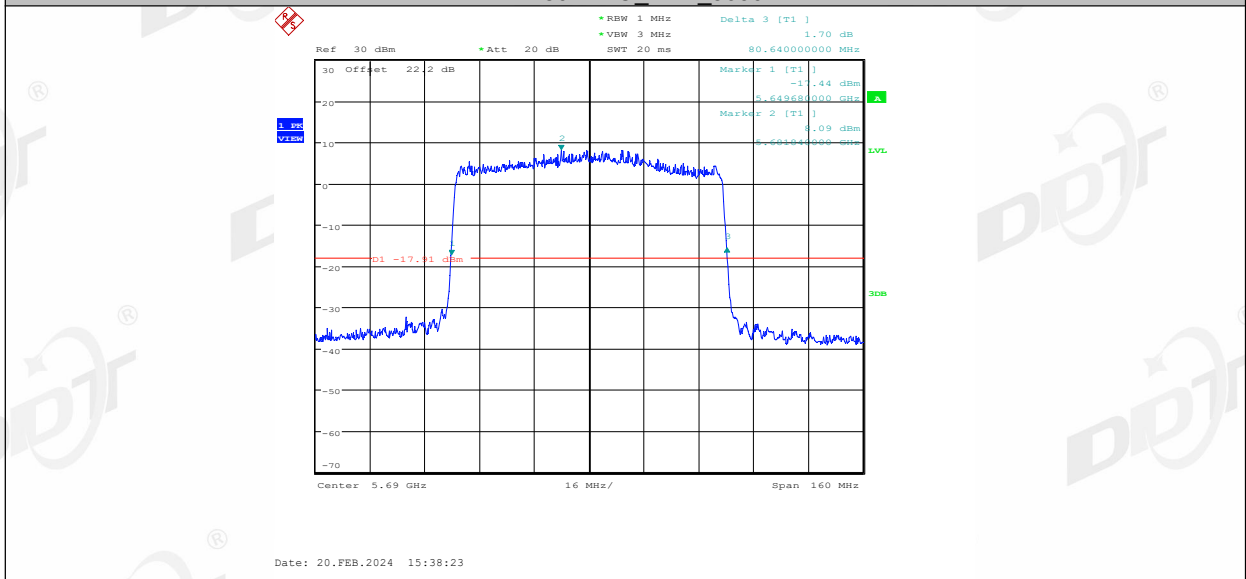

11AX80MIMO Ant2 5690

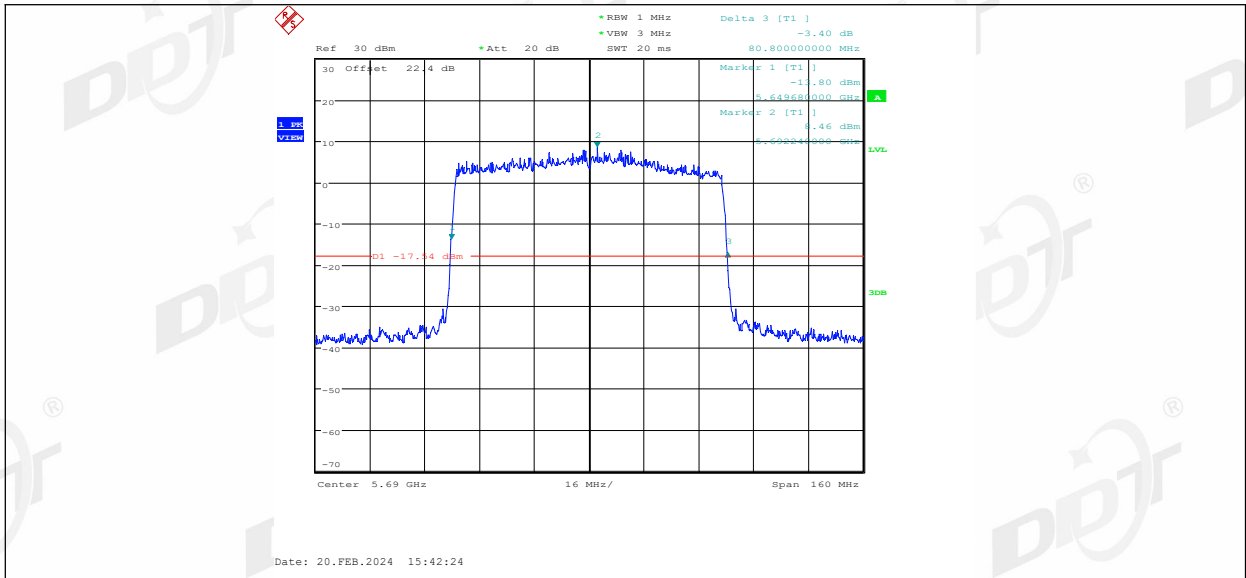

11AX80MIMO_Ant1_5775

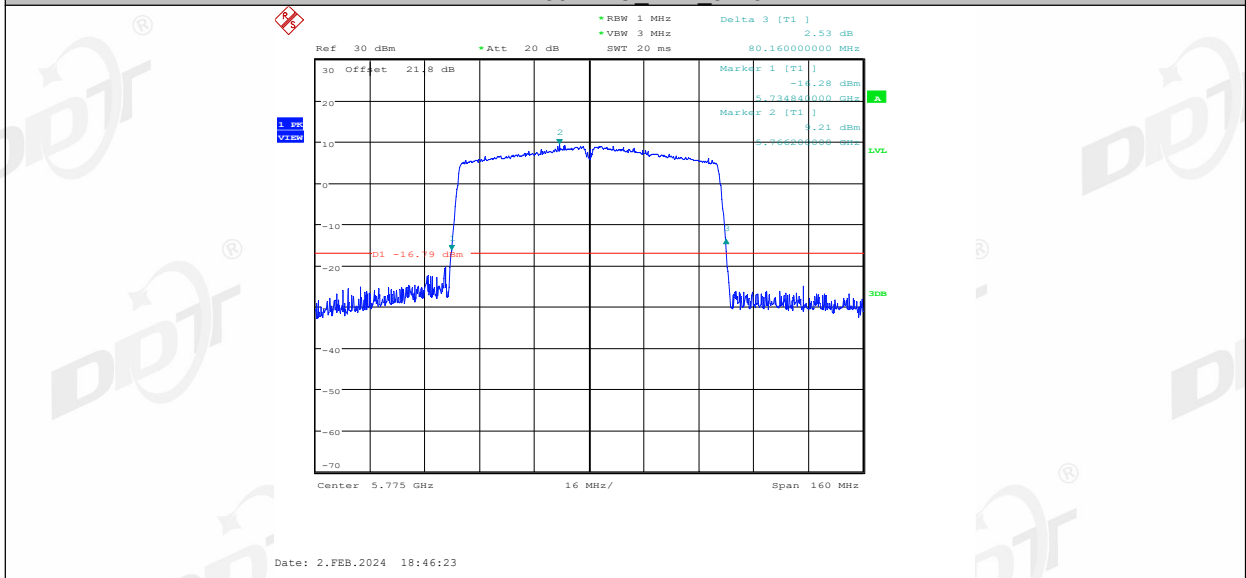

11AX80MIMO_Ant2_5775

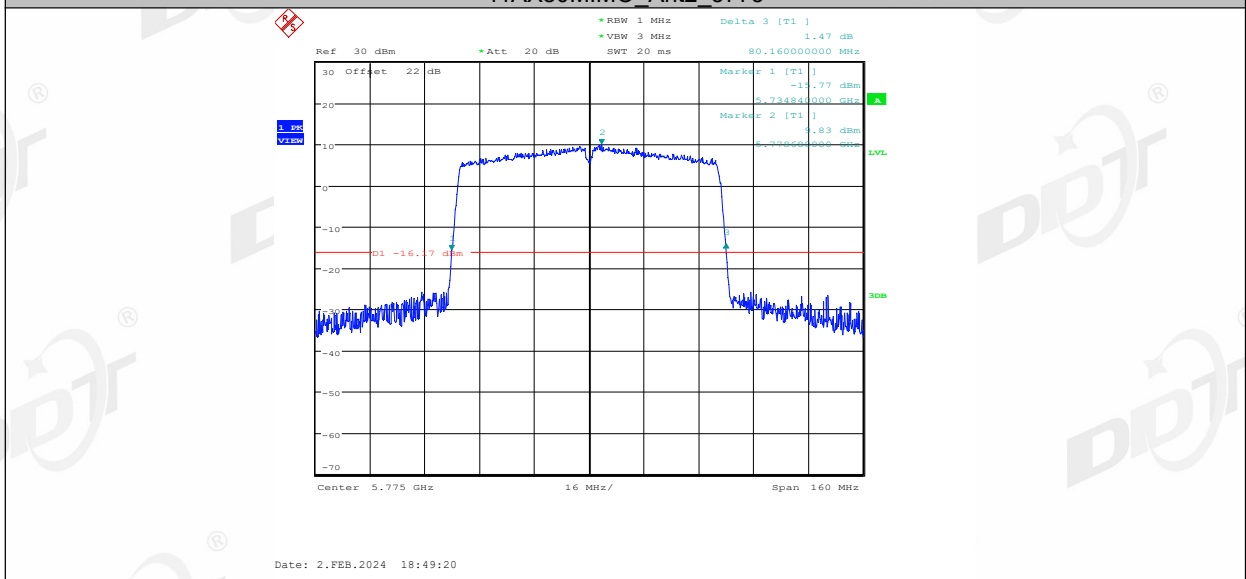

11AX160MIMO_Ant1_5250

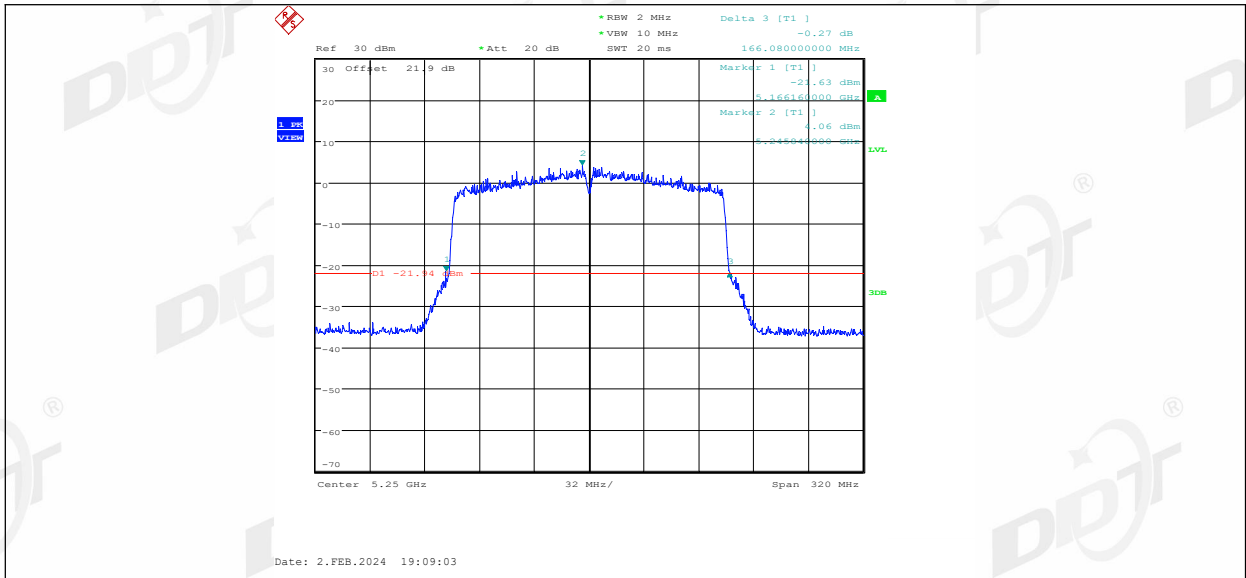

11AX160MIMO Ant2_5250

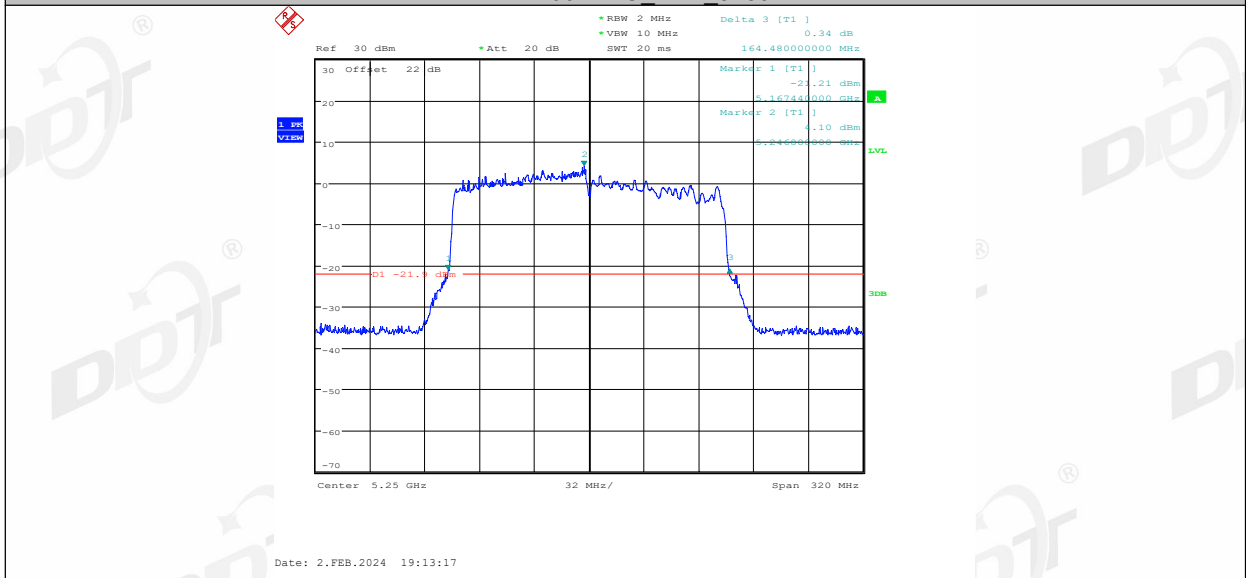

11AX160MIMO Ant1_5570

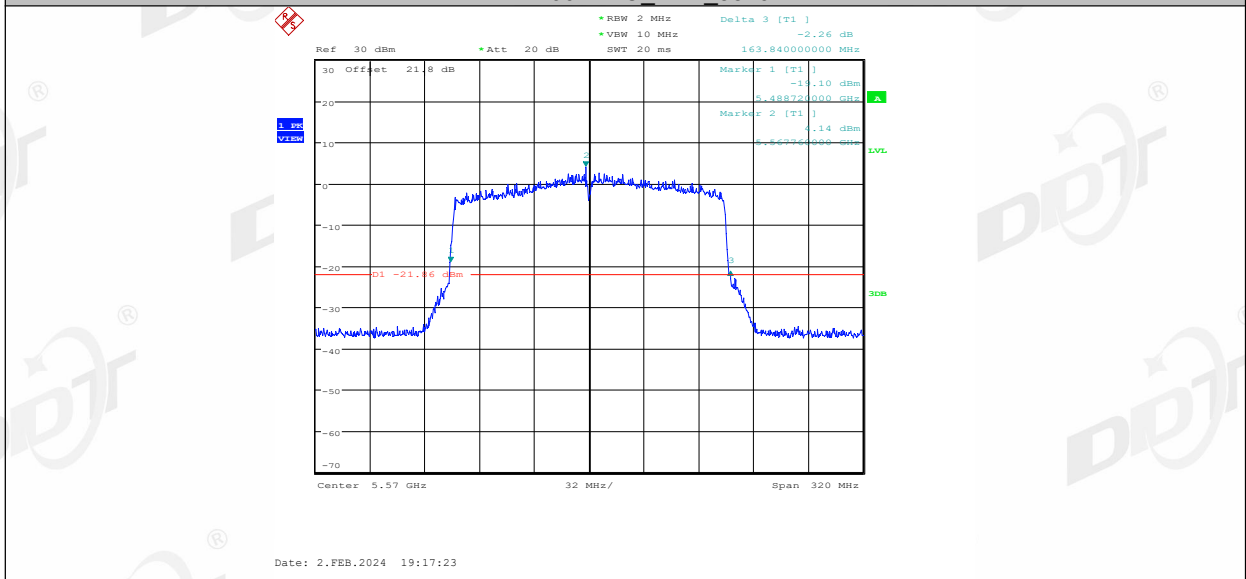

11AX160MIMO Ant2_5570

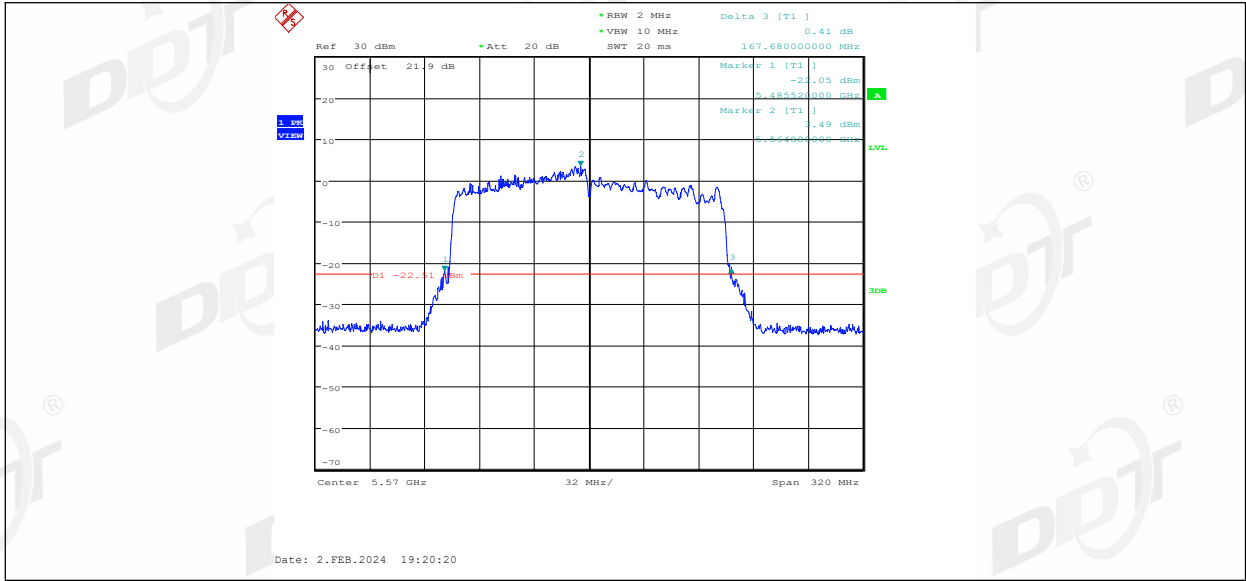

5. 6dB Bandwidth

5.1. Block diagram of test setup

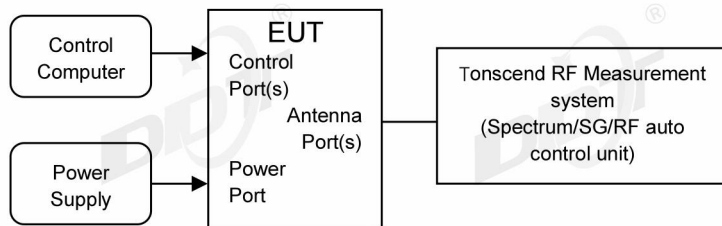

5.2. Limits

FCC Part15, Subpart E/ RSS-247		
Test Item	Limit	Frequency Range (MHz)
6 dB Bandwidth	Minimum 500 kHz	5725 - 5850

5.3. Test procedure

Connect EUT's antenna output to spectrum analyzer by RF cable.

Center Frequency	The center frequency of the channel under test
Detector	Peak
RBW	For 6 dB Bandwidth: RBW=100 kHz For 26 dB Bandwidth: approximately 1% of the emission bandwidth.
VBW	For 6 dB Bandwidth: VBW=300 kHz For 26 dB Bandwidth: >3 RBW
Trace	Max hold
Sweep	Auto couple

Allow the trace to stabilize, measure the maximum width of the emission that is constrained by the frequencies associated with the two outermost amplitude points (upper and lower frequencies) that are attenuated by 6 dB relative to the maximum level measured in the fundamental emission.

5.4. Test result B4

Test Engineer:	Zora Zhang	Test Site:	RF Measurement System 1#
Ambient Condition:	23.6°C,64%RH	Test Date:	2024.01.29-2024.02.21
Test Power Supply:	AC230V/50Hz	EUT:	Mercku M6s Nano Mesh Wi-Fi Router
Sample Number:	S23111605-01	Model No.:	MBAA0

Test Mode	Antenna	Frequency[MHz]	6db EBW [MHz]	FL[MHz]	FH[MHz]	Limit[MHz]	Verdict
11A	Ant1	5745	16.32	5736.84	5753.16	0.5	PASS
	Ant2	5745	16.28	5736.84	5753.12	0.5	PASS
	Ant1	5785	16.28	5776.84	5793.12	0.5	PASS
	Ant2	5785	16.28	5776.84	5793.12	0.5	PASS
	Ant1	5825	16.28	5816.84	5833.12	0.5	PASS
	Ant2	5825	16.28	5816.84	5833.12	0.5	PASS
11N20MIMO	Ant1	5745	17.04	5736.44	5753.48	0.5	PASS
	Ant2	5745	17.56	5736.20	5753.76	0.5	PASS
	Ant1	5785	17.56	5776.20	5793.76	0.5	PASS
	Ant2	5785	17.56	5776.20	5793.76	0.5	PASS
	Ant1	5825	17.32	5816.20	5833.52	0.5	PASS
	Ant2	5825	17.56	5816.20	5833.76	0.5	PASS
11N40MIMO	Ant1	5755	35.12	5737.40	5772.52	0.5	PASS
	Ant2	5755	35.12	5737.40	5772.52	0.5	PASS
	Ant1	5795	35.12	5777.40	5812.52	0.5	PASS
	Ant2	5795	35.12	5777.40	5812.52	0.5	PASS
11AC20MIMO	Ant1	5745	17.72	5736.12	5753.84	0.5	PASS
	Ant2	5745	17.72	5736.12	5753.84	0.5	PASS
	Ant1	5785	17.72	5776.12	5793.84	0.5	PASS
	Ant2	5785	17.72	5776.12	5793.84	0.5	PASS
	Ant1	5825	17.76	5816.12	5833.88	0.5	PASS
	Ant2	5825	17.72	5816.12	5833.84	0.5	PASS
11AC40MIMO	Ant1	5755	35.12	5737.40	5772.52	0.5	PASS
	Ant2	5755	35.12	5737.40	5772.52	0.5	PASS
	Ant1	5795	35.12	5777.40	5812.52	0.5	PASS
	Ant2	5795	35.12	5777.40	5812.52	0.5	PASS
11AC80MIMO	Ant1	5775	75.20	5737.40	5812.60	0.5	PASS
	Ant2	5775	75.20	5737.40	5812.60	0.5	PASS
11AX20MIMO	Ant1	5745	18.80	5735.52	5754.32	0.5	PASS
	Ant2	5745	18.76	5735.48	5754.24	0.5	PASS
	Ant1	5785	18.80	5775.56	5794.36	0.5	PASS
	Ant2	5785	18.72	5775.60	5794.32	0.5	PASS
	Ant1	5825	18.76	5815.60	5834.36	0.5	PASS
	Ant2	5825	18.24	5816.08	5834.32	0.5	PASS
11AX40MIMO	Ant1	5755	36.80	5736.44	5773.24	0.5	PASS
	Ant2	5755	35.12	5737.40	5772.52	0.5	PASS
	Ant1	5795	35.12	5777.40	5812.52	0.5	PASS
	Ant2	5795	35.12	5777.40	5812.52	0.5	PASS
11AX80MIMO	Ant1	5775	75.20	5737.40	5812.60	0.5	PASS
	Ant2	5775	75.20	5737.40	5812.60	0.5	PASS

5.5. Test graphs B4

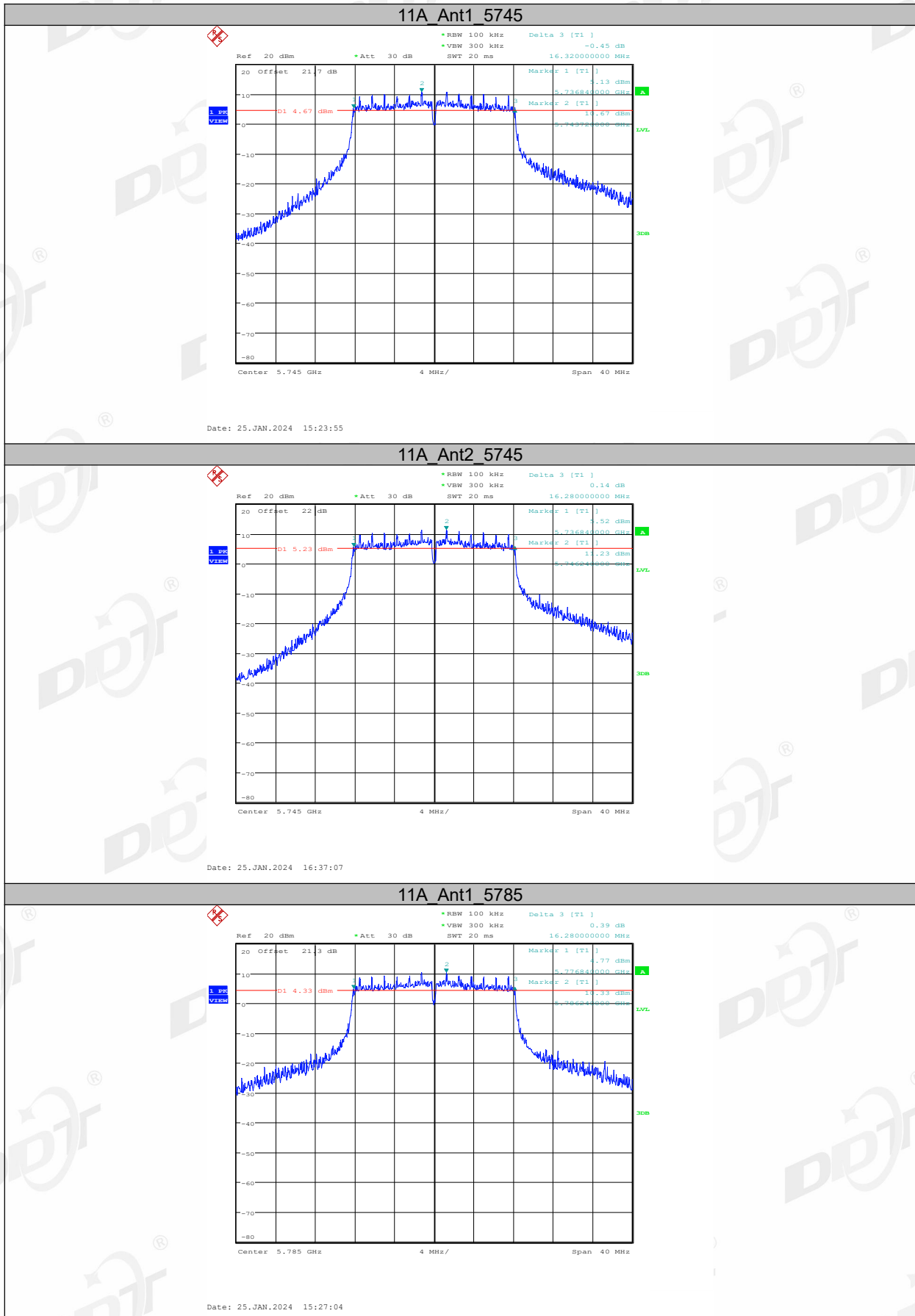

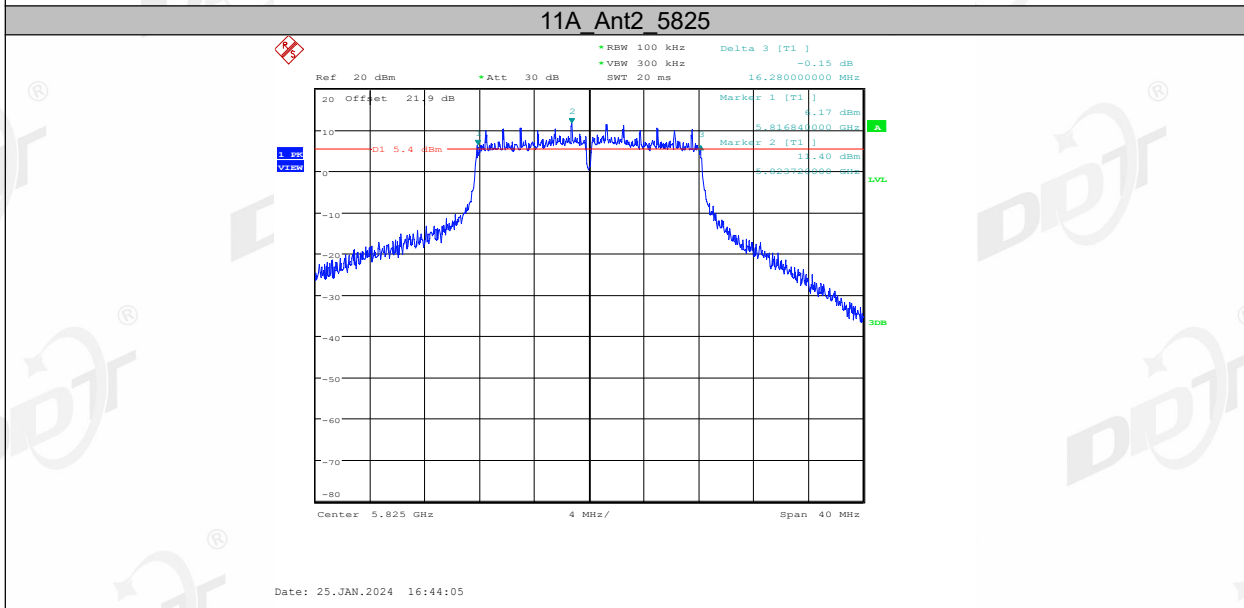
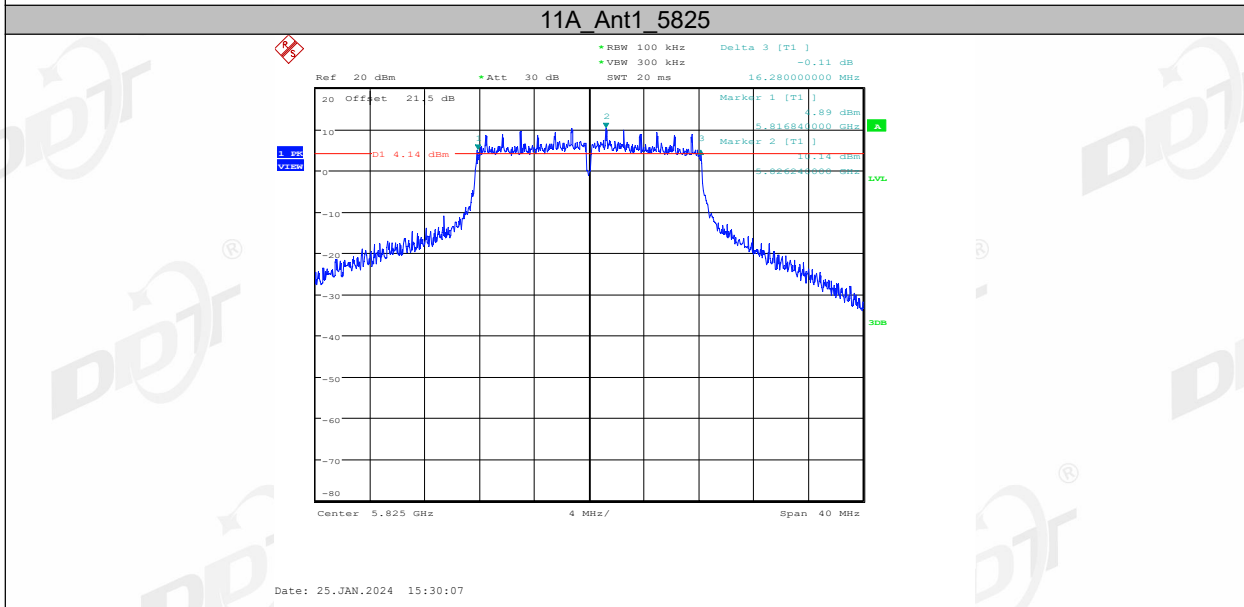
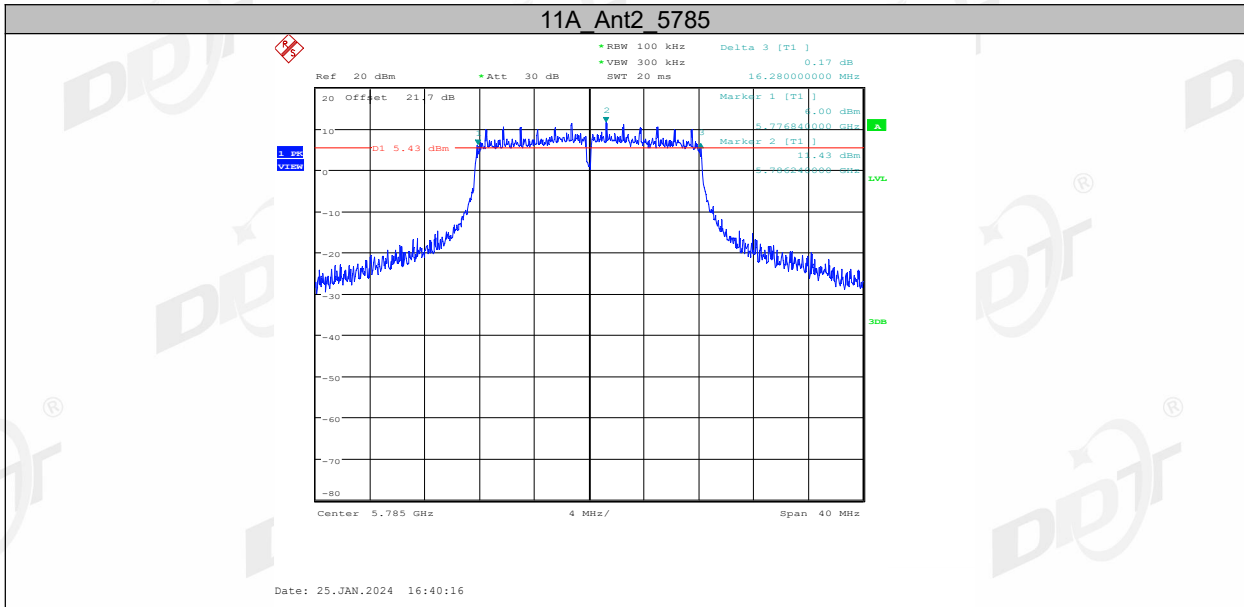

11N20MIMO_Ant1_5745

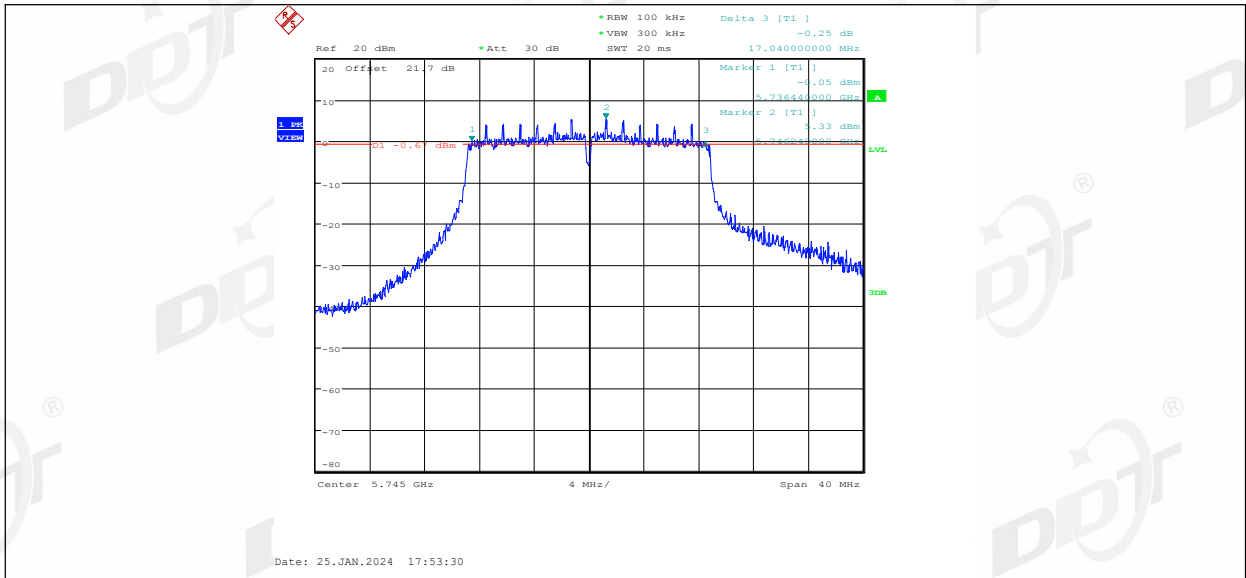

11N20MIMO_Ant2_5745

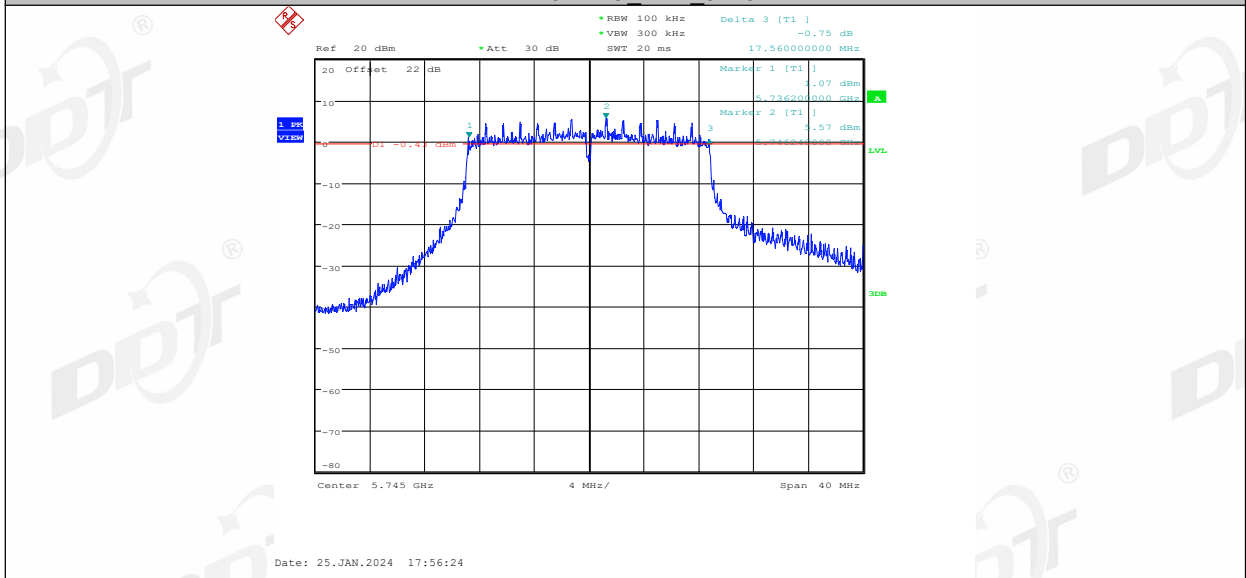

11N20MIMO_Ant1_5785

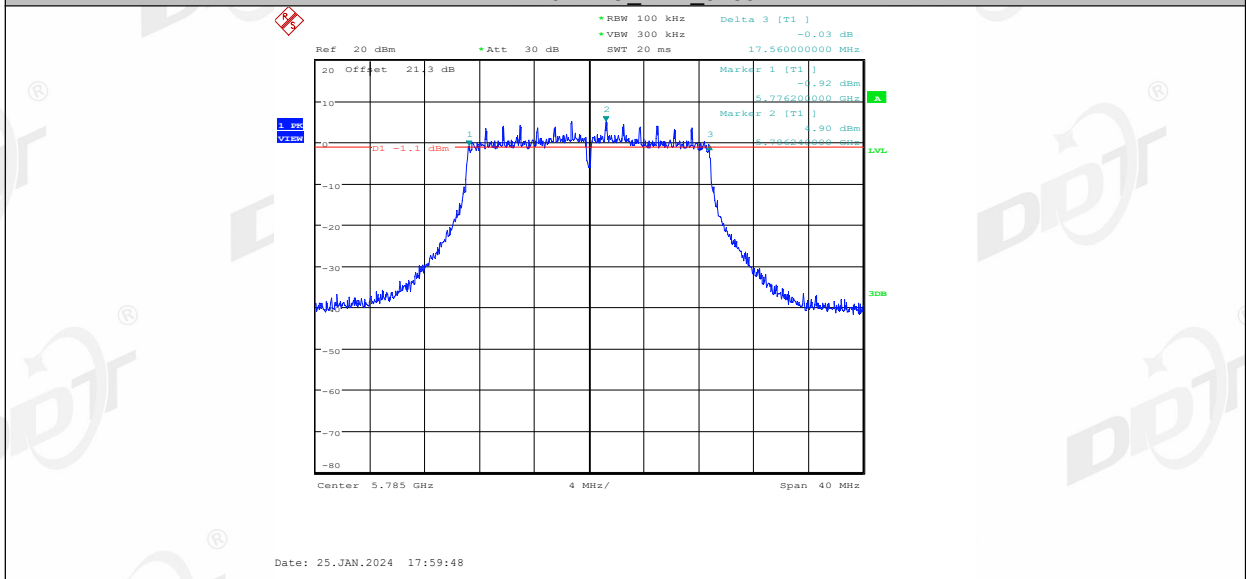

11N20MIMO_Ant2_5785

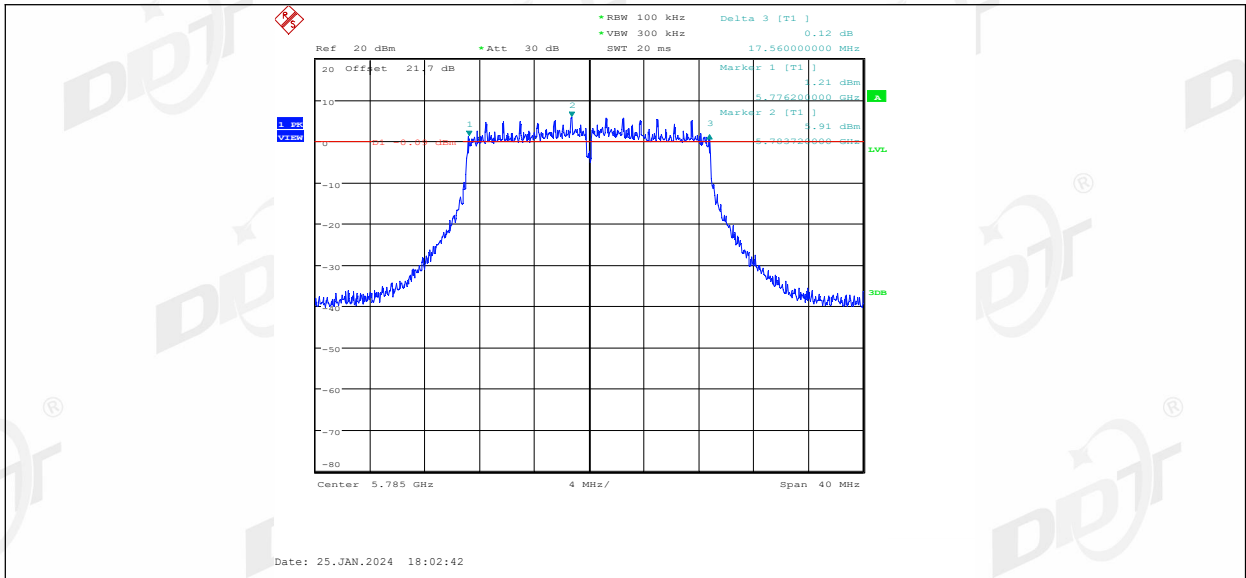

11N20MIMO_Ant1_5825

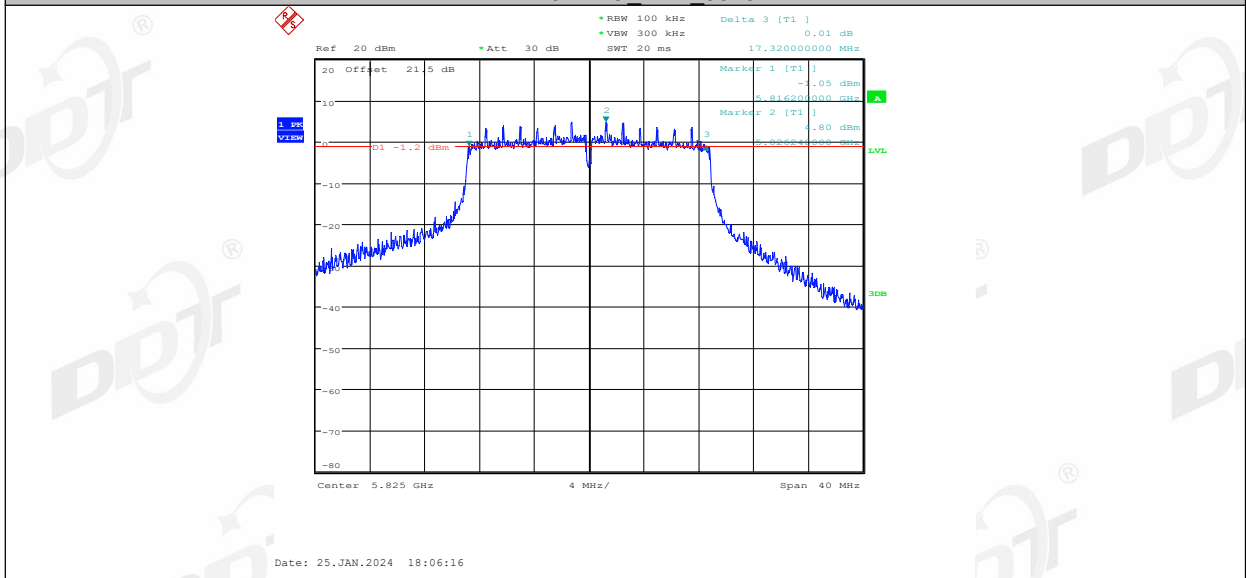

11N20MIMO_Ant2_5825

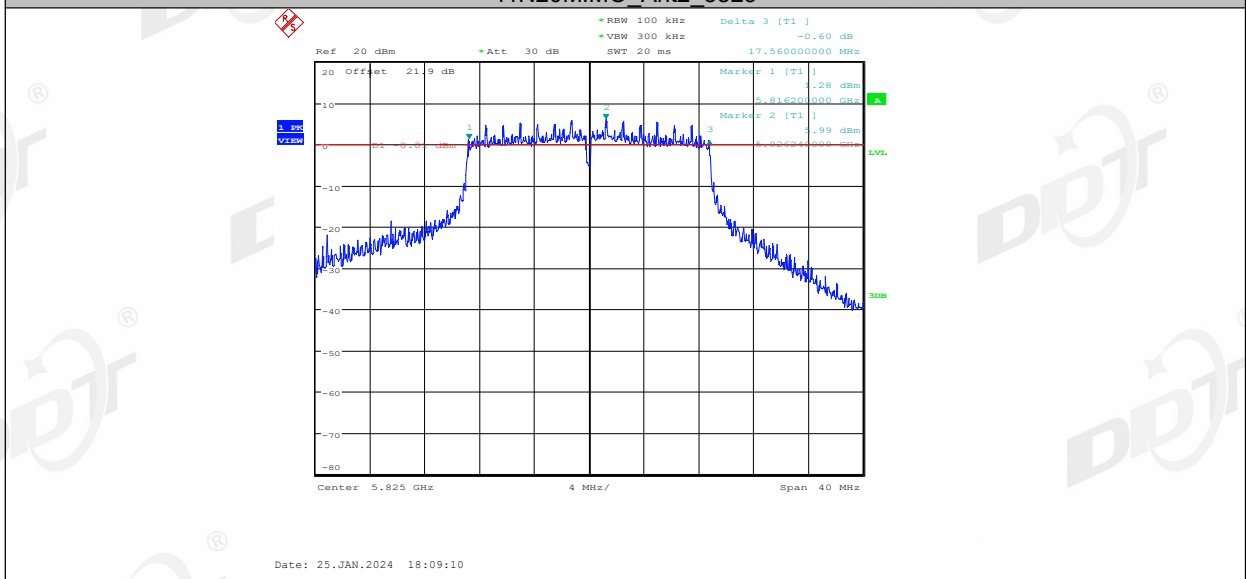

11N40MIMO_Ant1_5755

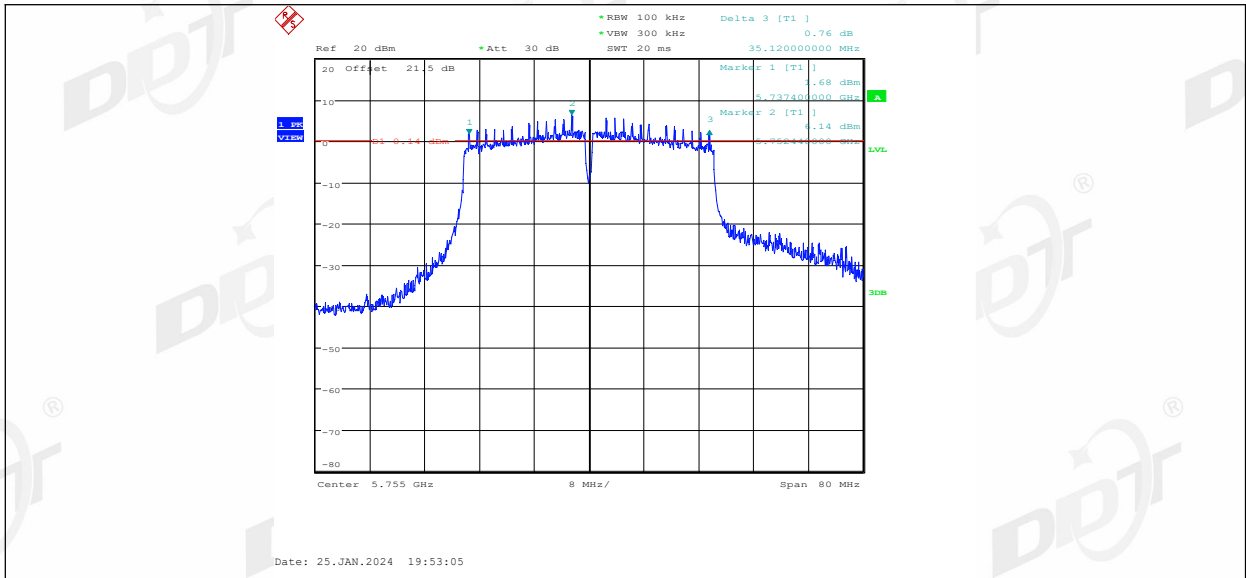

11N40MIMO_Ant2_5755

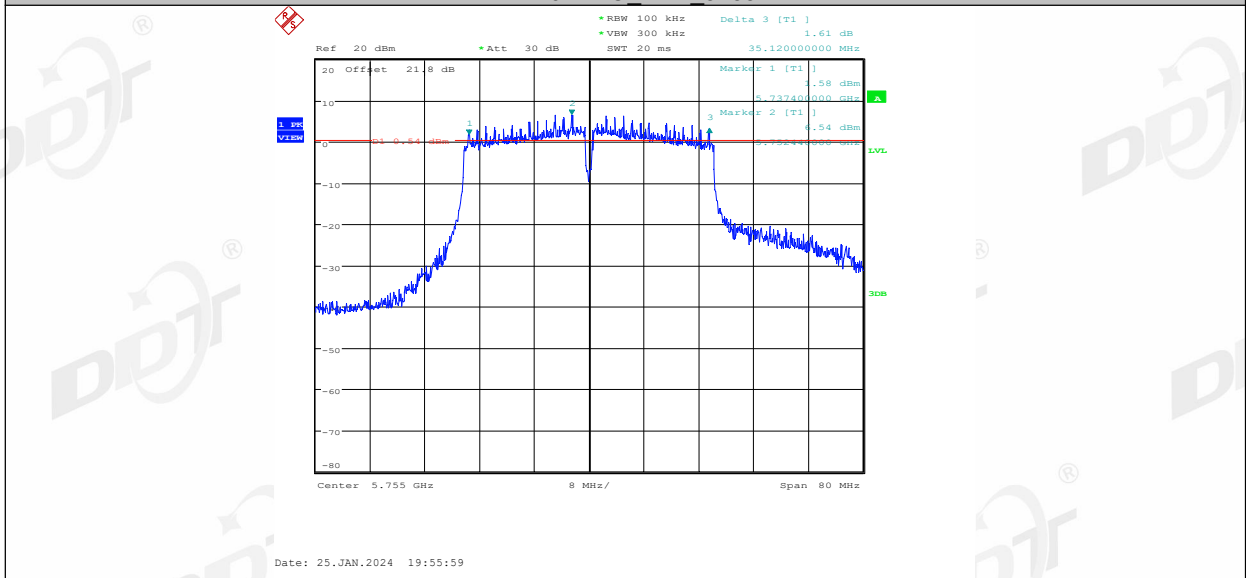

11N40MIMO_Ant1_5795

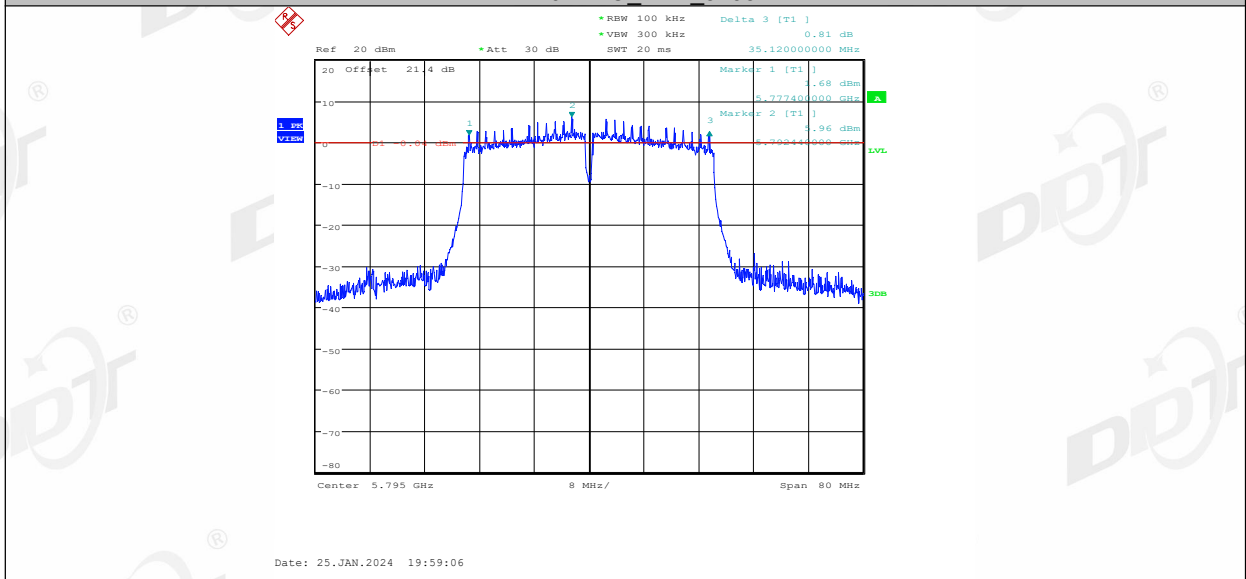

11N40MIMO_Ant2_5795

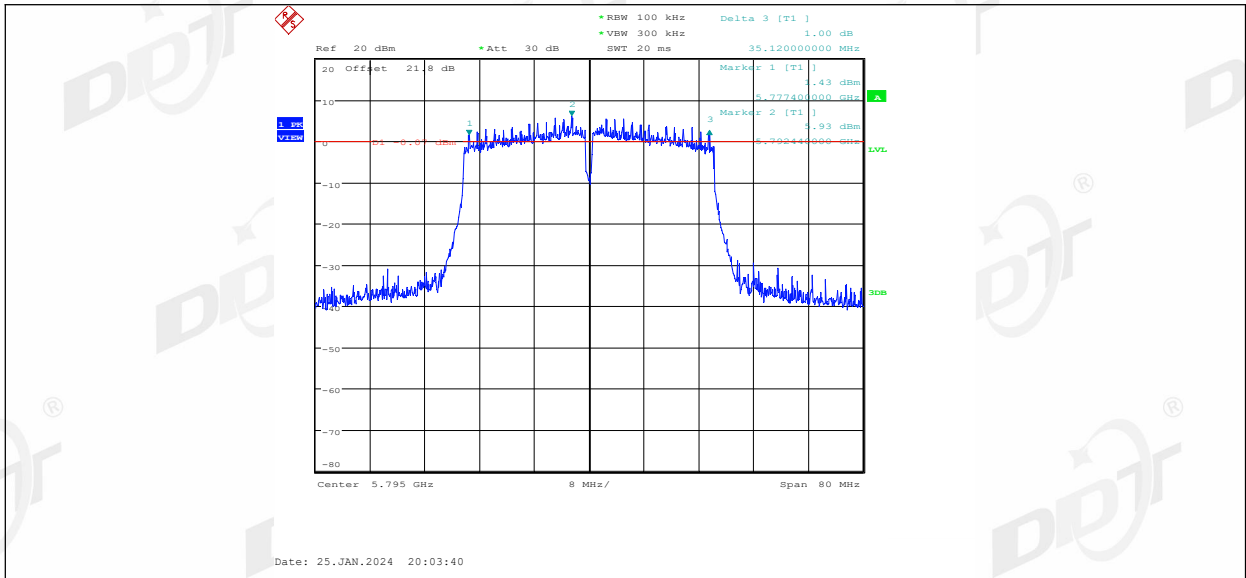

11AC20MIMO Ant1 5745

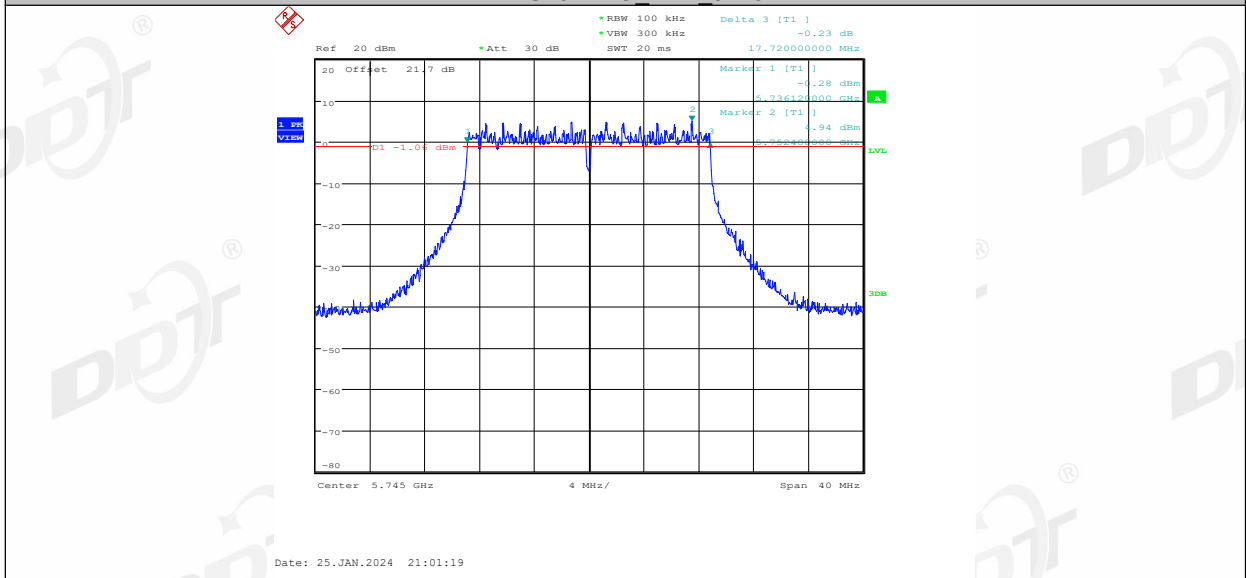

11AC20MIMO Ant2 5745

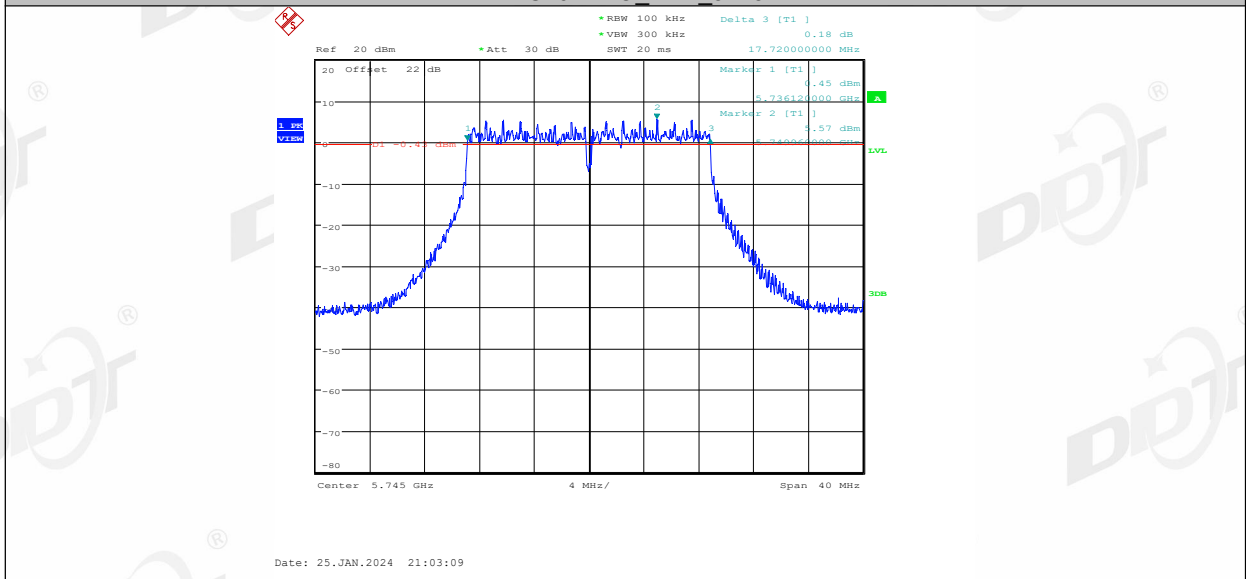

11AC20MIMO Ant1 5785

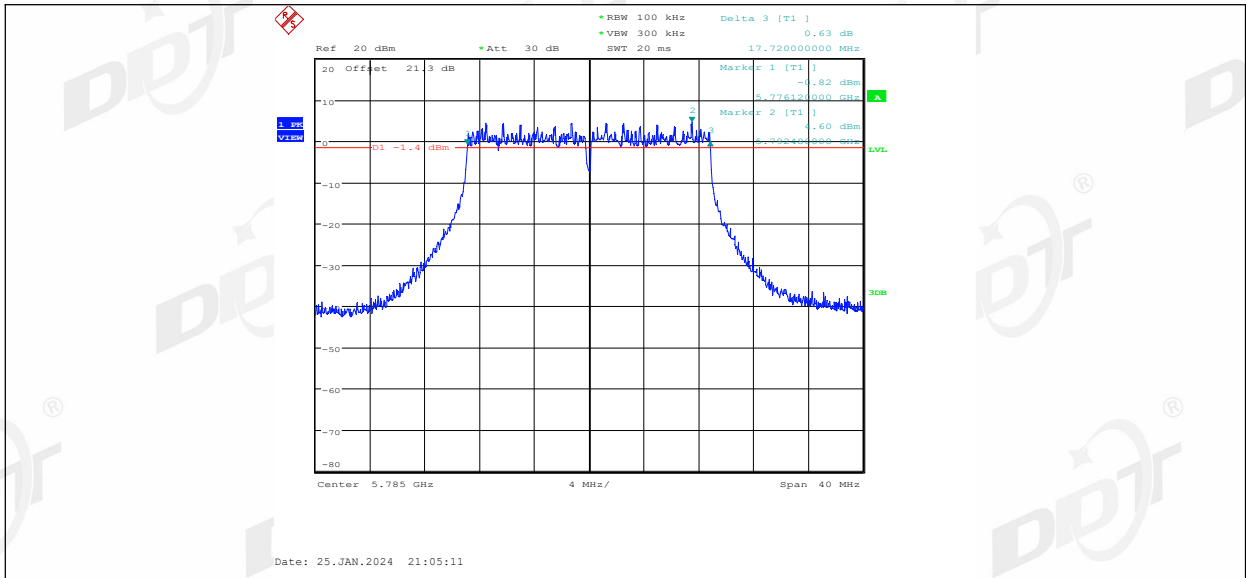

11AC20MIMO Ant2 5785

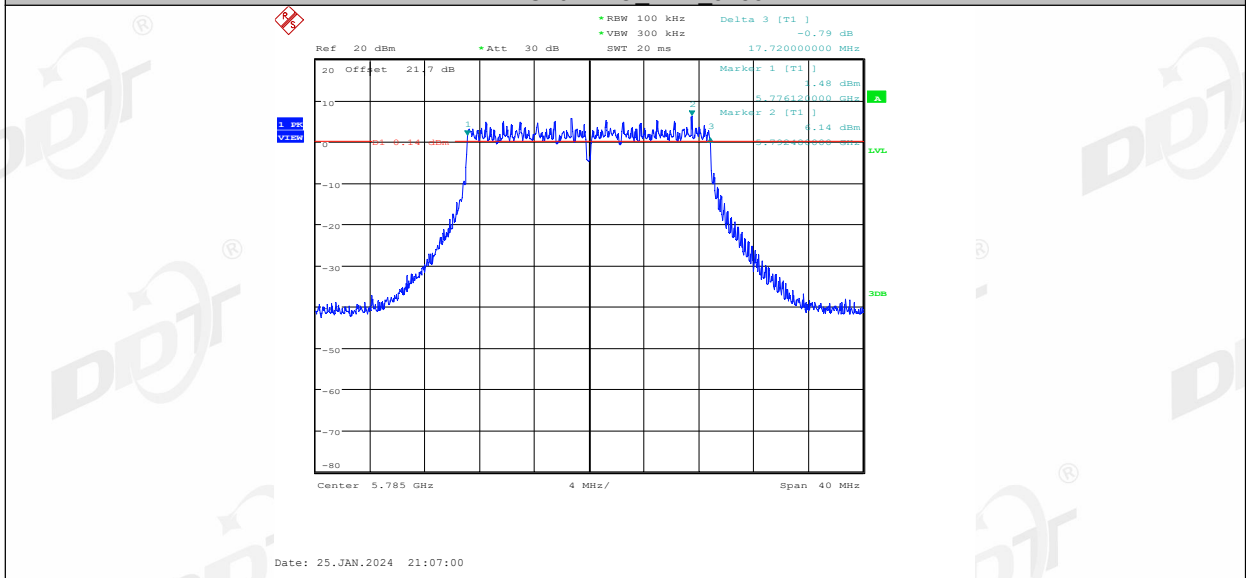

11AC20MIMO Ant1 5825

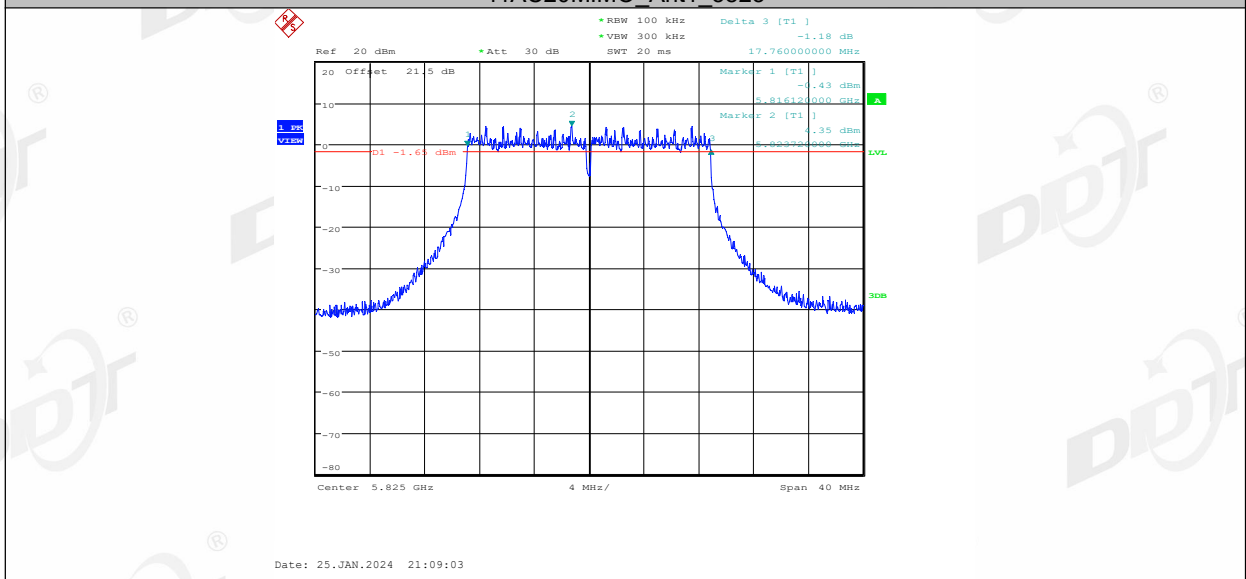

11AC20MIMO Ant2 5825

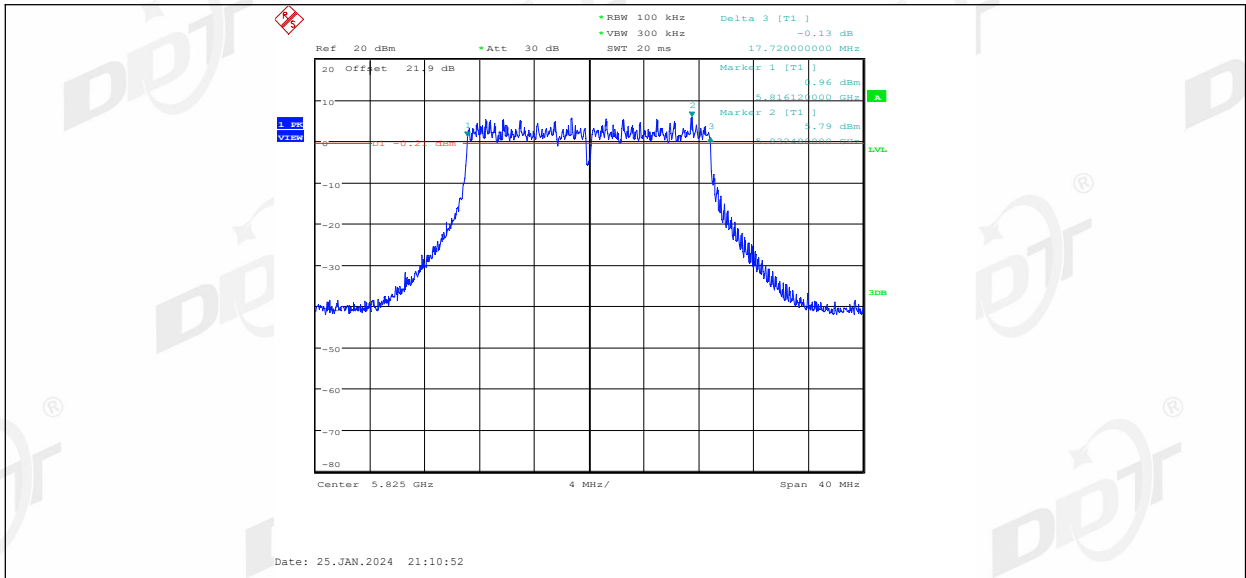

11AC40MIMO Ant1 5755

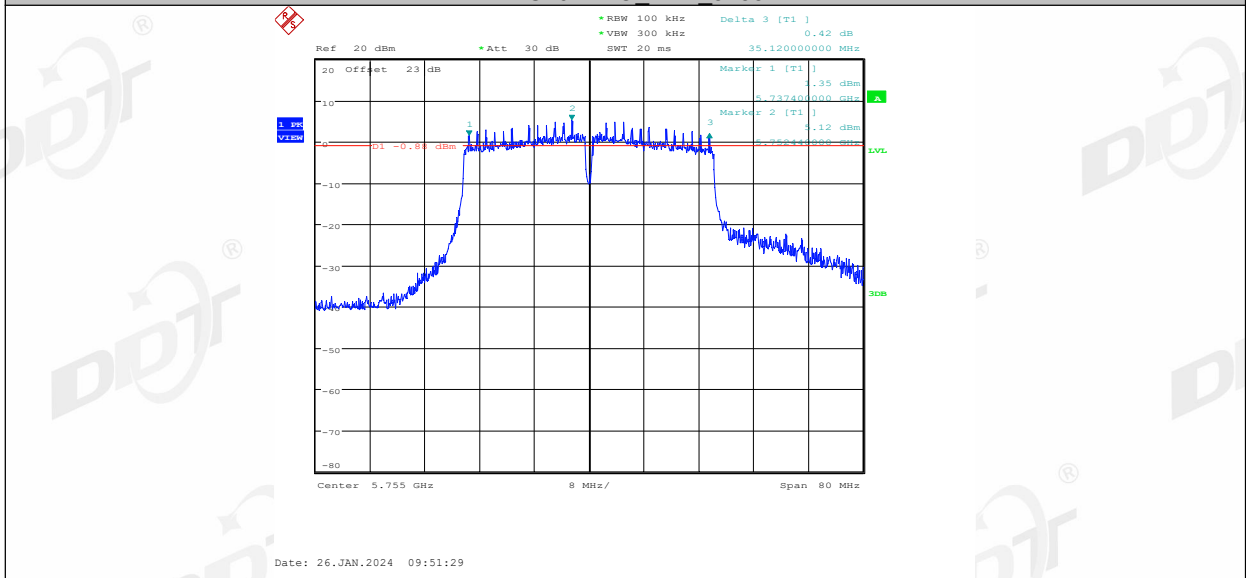

11AC40MIMO Ant2 5755

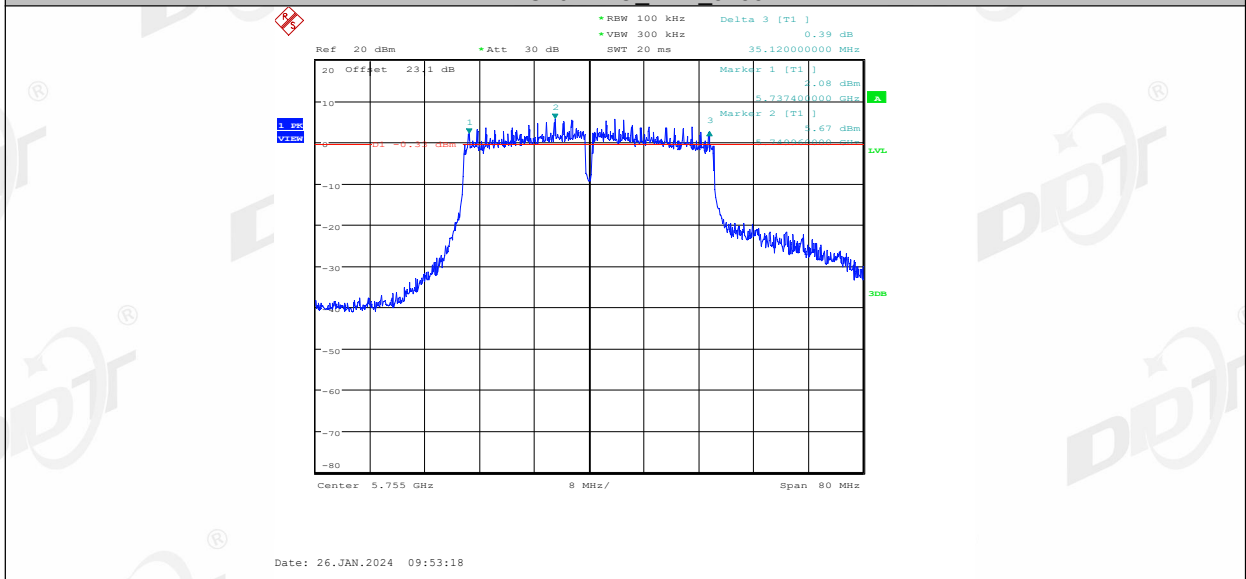

11AC40MIMO Ant1 5795

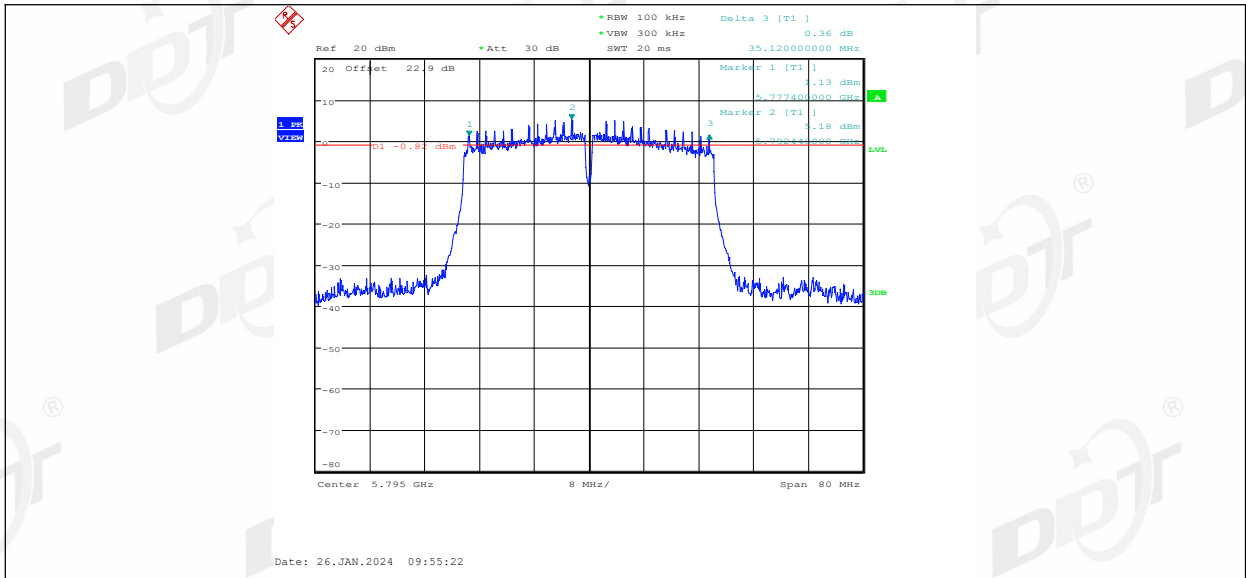

11AC40MIMO Ant2 5795

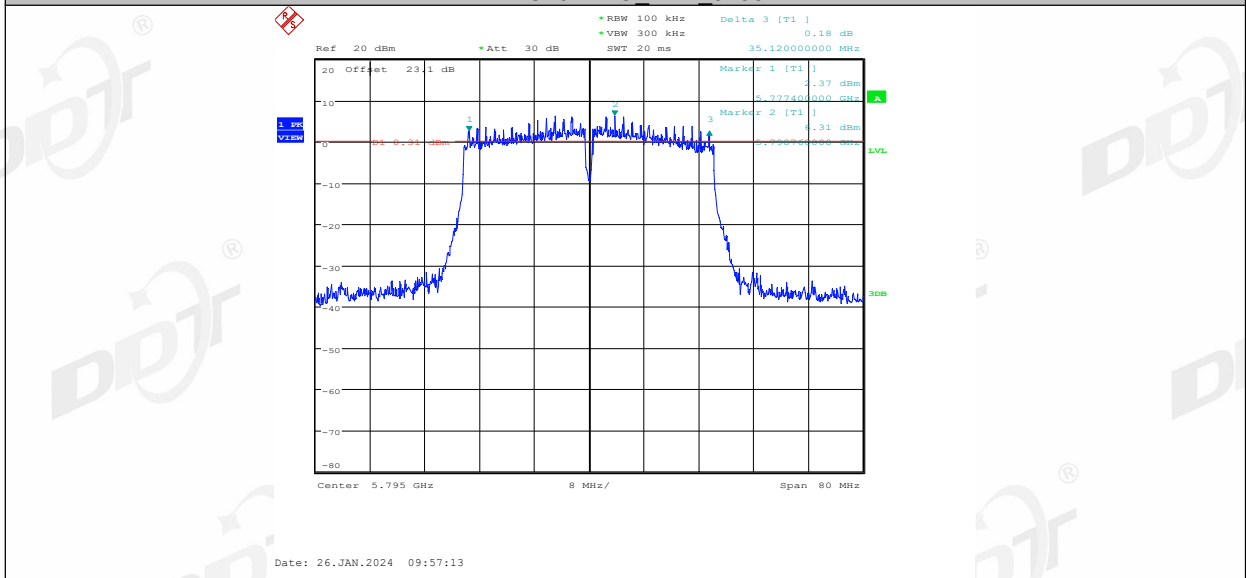

11AC80MIMO Ant1 5775

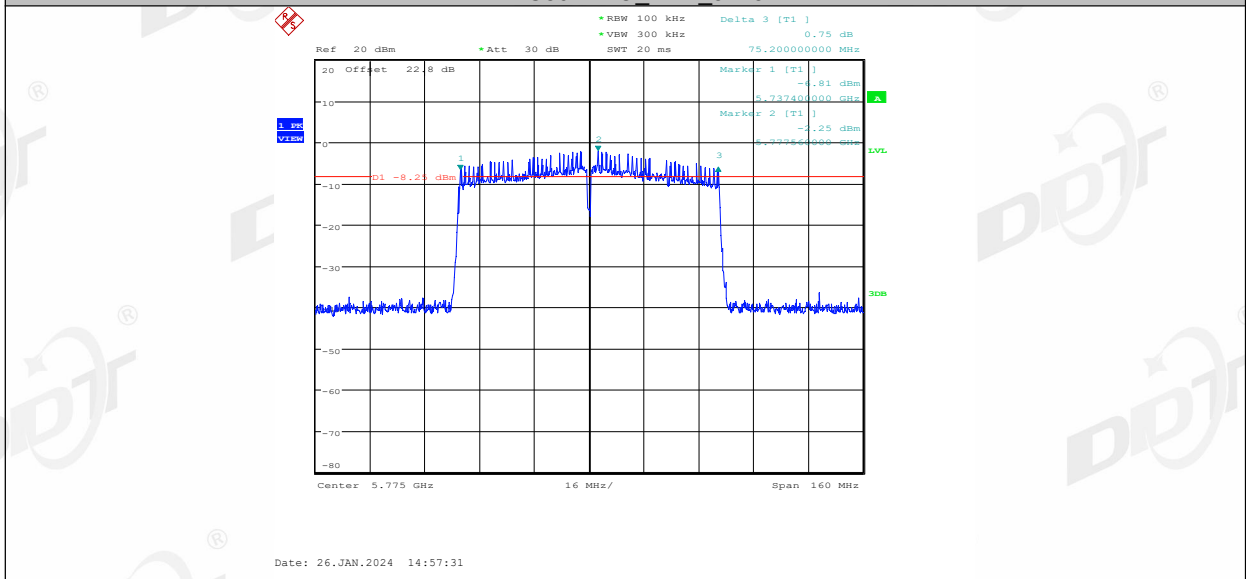

11AC80MIMO Ant2 5775

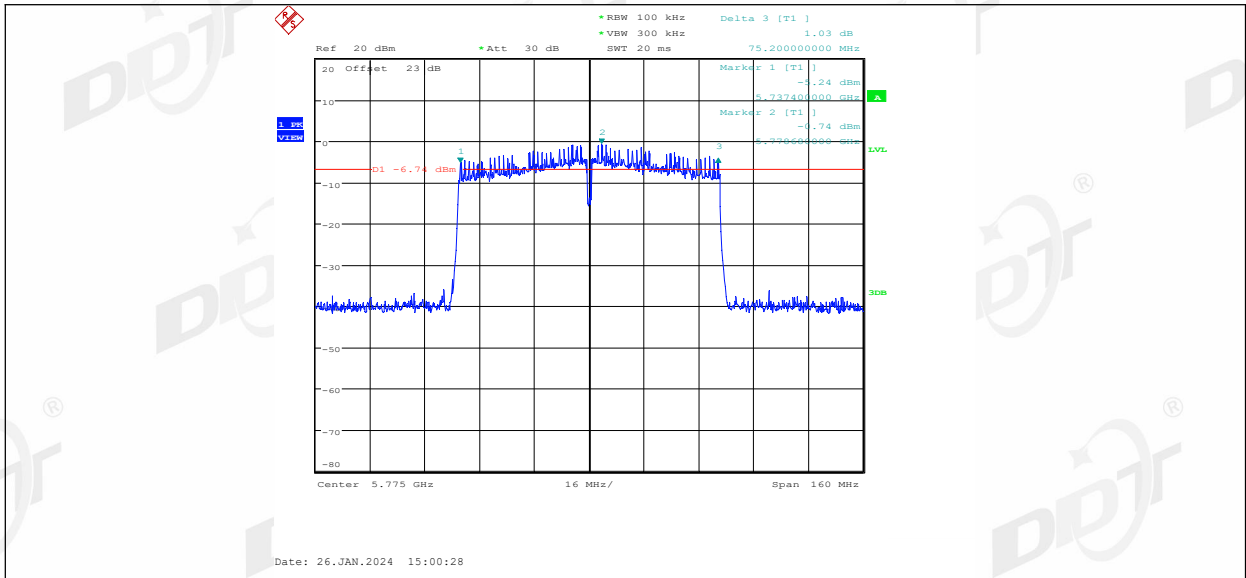

11AX20MIMO Ant1 5745

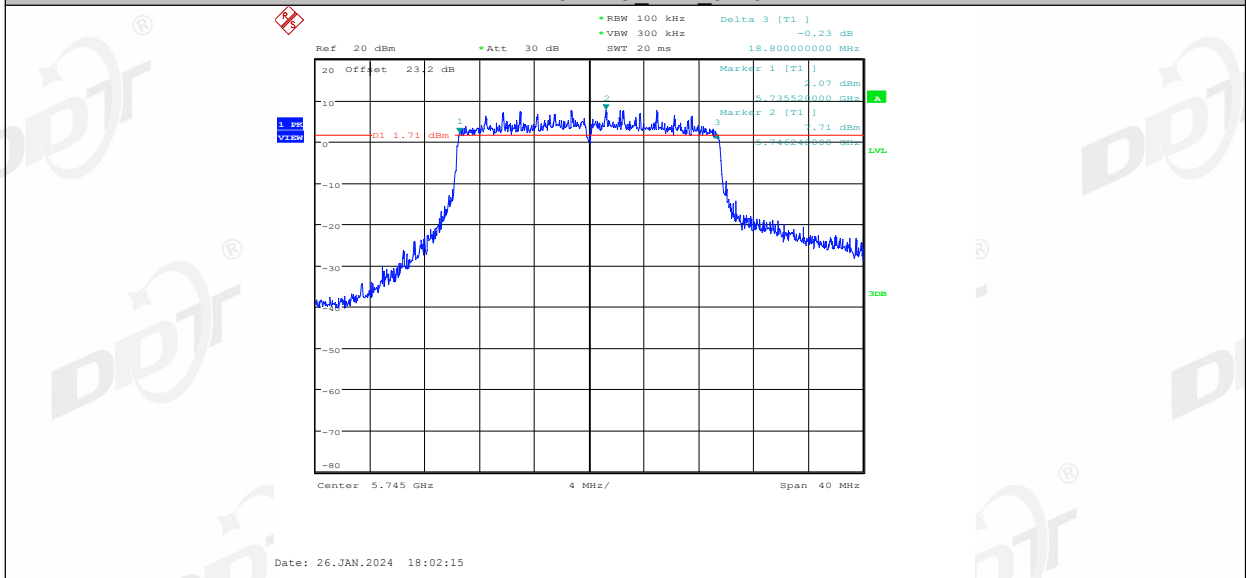

11AX20MIMO Ant2 5745

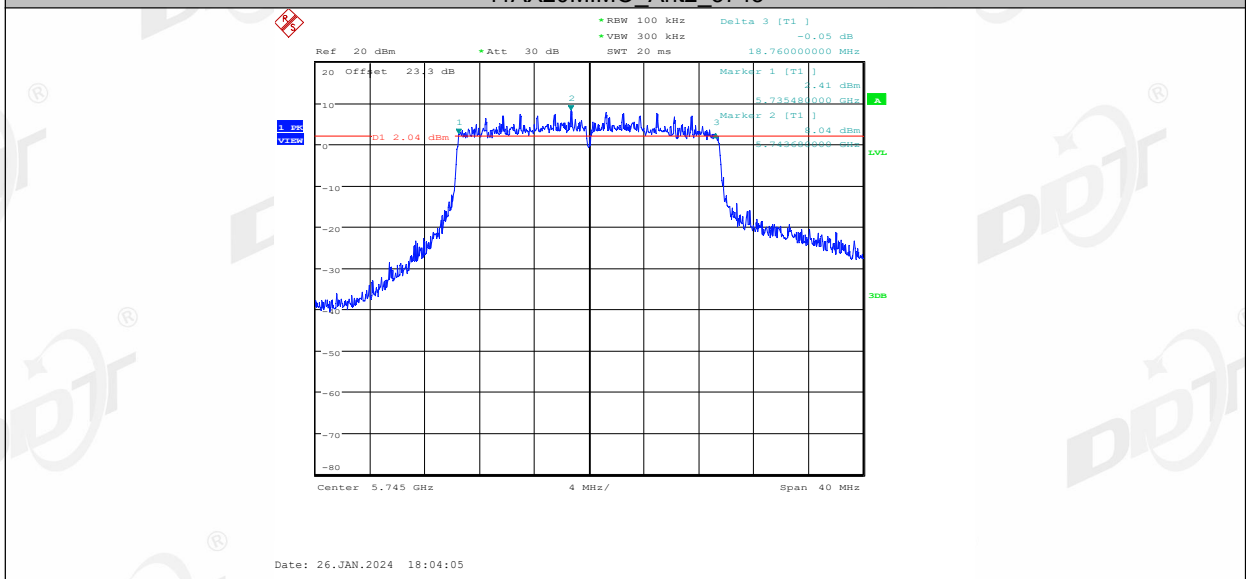

11AX20MIMO Ant1 5785

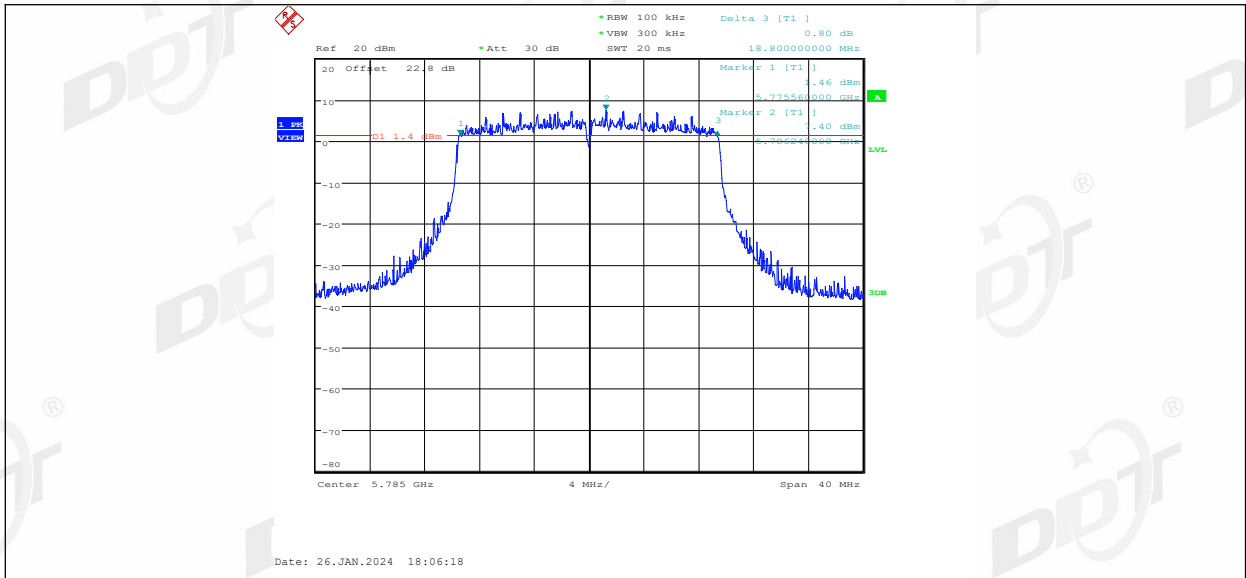

11AX20MIMO Ant2 5785

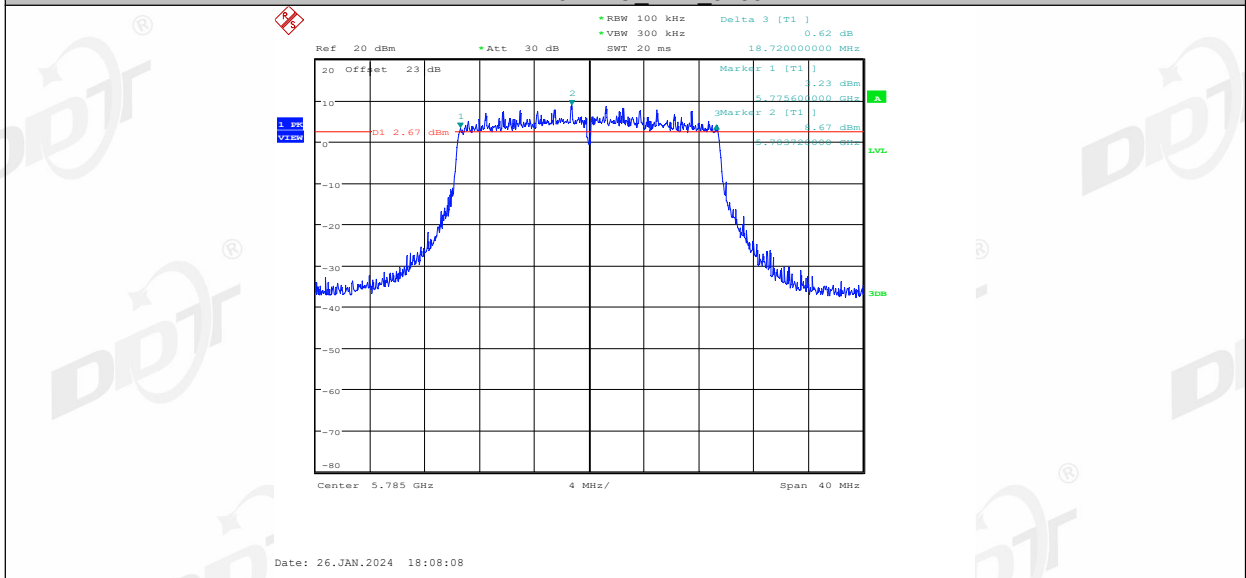

11AX20MIMO Ant1 5825

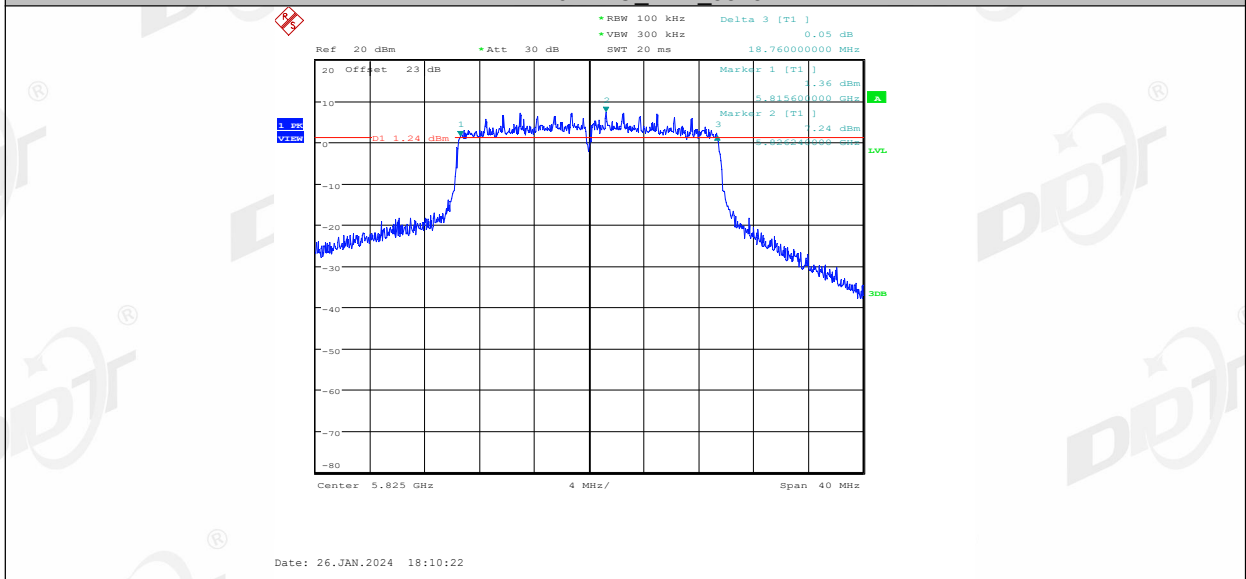

11AX20MIMO Ant2 5825

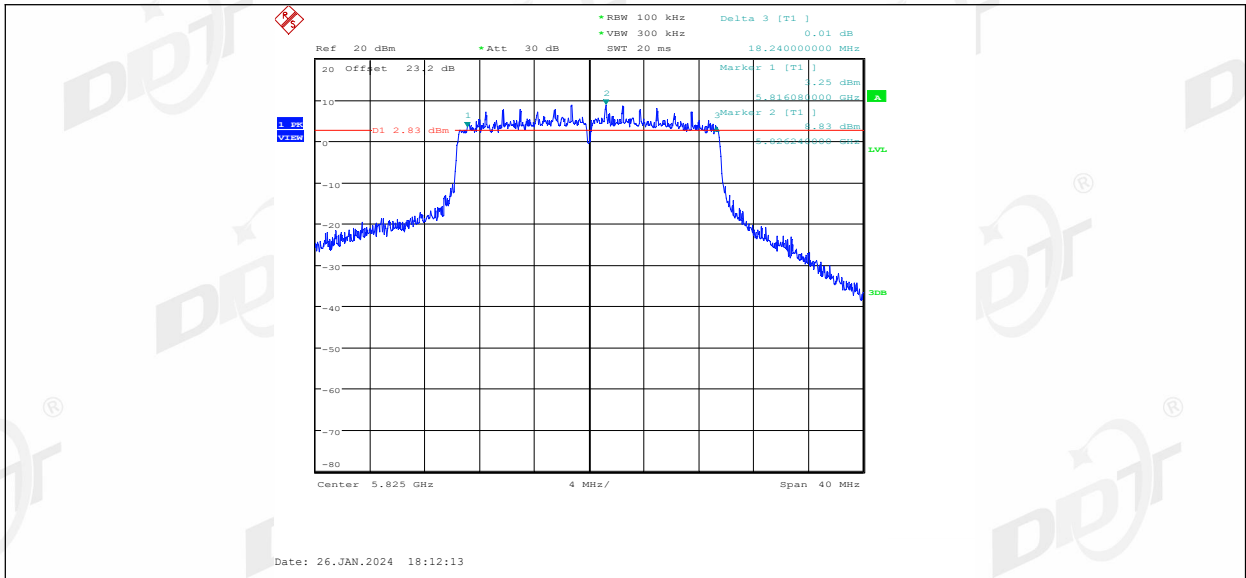

11AX40MIMO Ant1 5755

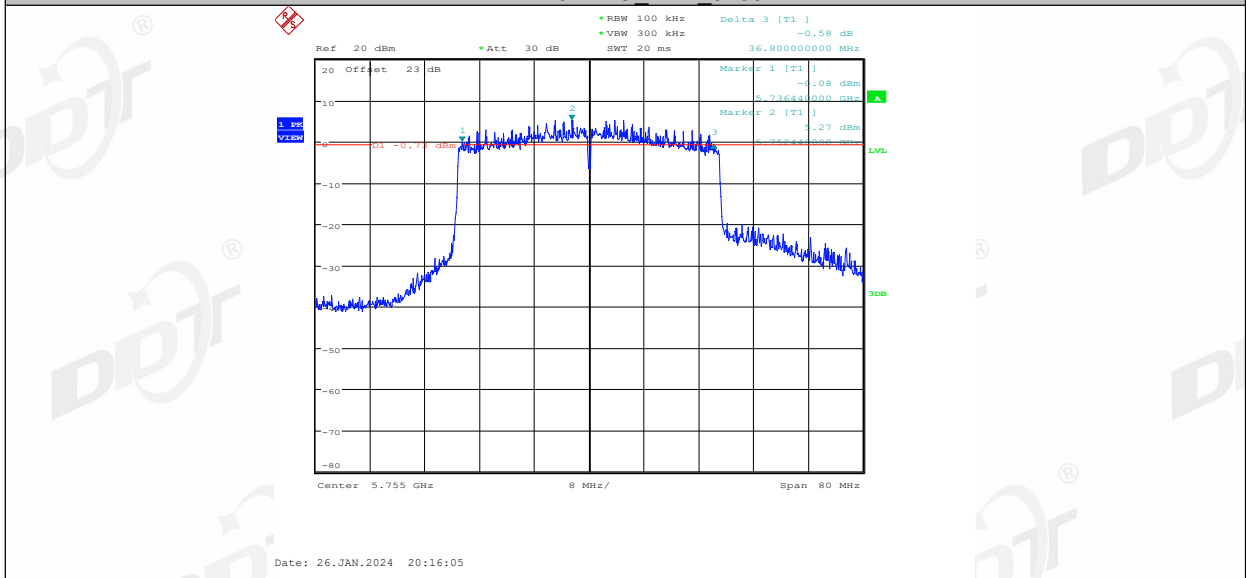

11AX40MIMO Ant2 5755

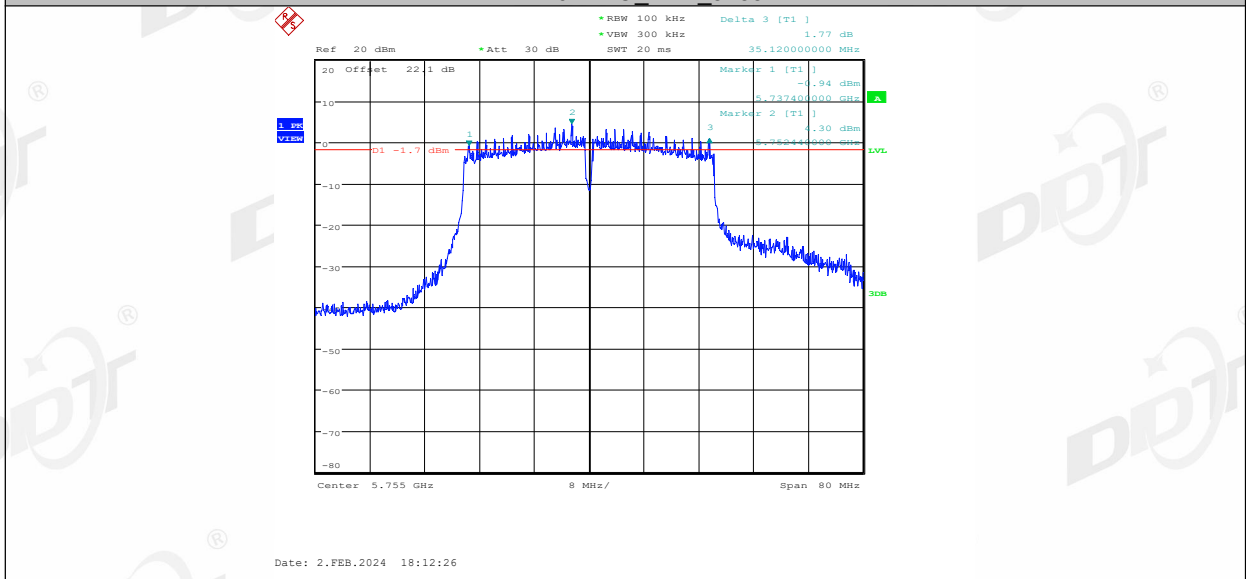

11AX40MIMO Ant1 5795

