



FCC RF Test Report

APPLICANT : KonnectONE, LLC
EQUIPMENT : 5G MiFi
BRAND NAME : moxee
MODEL NAME : K873HSVL
FCC ID : 2APQU-K873HSVL
STANDARD : 47 CFR Part 2, 22, 24, 27
CLASSIFICATION : PCS Licensed Transmitter (PCB)
TEST DATE(S) : Jun. 25, 2021 ~ Sep. 02, 2021

We, Sporton International (Kunshan) Inc., would like to declare that the tested sample has been evaluated in accordance with the procedures given in ANSI C63.26-2015 and shown compliance with the applicable technical standards.

This report contains data that were produced under subcontract by Sporton International (Shenzhen) Inc.

The test results in this report apply exclusively to the tested model / sample. Without written approval of Sporton International (Kunshan) Inc., the test report shall not be reproduced except in full.

Jason Jia

Reviewed by: Jason Jia / Supervisor

Alex Wang

Approved by: Alex Wang / Manager



Sporton International (Kunshan) Inc.

**No. 1098, Pengxi North Road, Kunshan Economic Development Zone Jiangsu Province 215300
People's Republic of China**



TABLE OF CONTENTS

REVISION HISTORY... 3
SUMMARY OF TEST RESULT ... 4
1 GENERAL DESCRIPTION ... 5
1.1 Applicant ... 5
1.2 Manufacturer ... 5
1.3 Product Feature of Equipment Under Test ... 5
1.4 Product Specification of Equipment Under Test ... 5
1.5 Modification of EUT ... 6
1.6 Maximum ERP/EIRP Power and Emission Designator ... 7
1.7 Testing Location ... 10
1.8 Test Software ... 10
1.9 Applicable Standards ... 10
2 TEST CONFIGURATION OF EQUIPMENT UNDER TEST ... 11
2.1 Test Mode ... 11
2.2 Connection Diagram of Test System ... 13
2.3 Support Unit used in test configuration and system ... 13
2.4 Measurement Results Explanation Example ... 13
2.5 Frequency List of Low/Middle/High Channels ... 14
3 CONDUCTED TEST ITEMS ... 16
3.1 Measuring Instruments ... 16
3.2 Test Setup ... 16
3.3 Test Result of Conducted Test ... 16
3.4 Conducted Output Power and ERP/EIRP ... 17
3.5 Peak-to-Average Ratio ... 18
3.6 Occupied Bandwidth ... 19
3.7 Conducted Band Edge ... 20
3.8 Conducted Spurious Emission ... 22
3.9 Frequency Stability ... 23
4 RADIATED TEST ITEMS ... 24
4.1 Measuring Instruments ... 24
4.2 Test Setup ... 24
4.3 Test Result of Radiated Test ... 25
4.4 Radiated Spurious Emission ... 26
5 LIST OF MEASURING EQUIPMENT ... 27
6 UNCERTAINTY OF EVALUATION ... 28
APPENDIX A. TEST RESULTS OF CONDUCTED TEST
APPENDIX B. TEST RESULTS OF RADIATED TEST
APPENDIX C. TEST SETUP PHOTOGRAPHS



REVISION HISTORY

REPORT NO.	VERSION	DESCRIPTION	ISSUED DATE
FG182710E	Rev. 01	Initial issue of report	Dec. 03, 2021



SUMMARY OF TEST RESULT

Report Section	FCC Rule	Description	Limit	Result	Remark
3.4	§2.1046	Conducted Output Power	-	Reporting Only	-
	§22.913(a)(5)	Effective Radiated Power (5G NR n5)	ERP < 7 Watt	PASS	
	§24.232(c)	Equivalent Isotropic Radiated Power (5G NR n2)	EIRP < 2Watt		
	§27.50(d)(4)	Equivalent Isotropic Radiated Power (5G NR n66)	EIRP < 1Watt		
	§27.50(j)(3)	Equivalent Isotropic Radiated Power (5G NR n77)	EIRP < 1Watt		
3.5	§24.232(d) §27.50(j)(4)	Peak-to-Average Ratio	<13 dB	PASS	-
3.6	§2.1049	Occupied Bandwidth	-	Reporting Only	-
3.7	§2.1051 §22.917(a) §24.238(a) §27.53(h) §27.53(l)(2)	Conducted Band Edge Measurement (5G NR n5) (5G NR n2) (5G NR n66) (5G NR n77)	< 43+10log10(P[Watts])	PASS	-
3.8	§2.1051 §22.917(a) §24.238(a) §27.53(h) §27.53(l)(2)	Conducted Spurious Emission (5G NR n5) (5G NR n2) (5G NR n66) (5G NR n77)	< 43+10log10(P[Watts])	PASS	-
3.9	§2.1055 §22.355	Frequency Stability Temperature & Voltage	< 2.5 ppm for Part 22	PASS	-
	§24.235 §27.54		Within Authorized Band		
4.4	§2.1053 §22.917(a) §24.238(a) §27.53(h) §27.53(l)(2)	Radiated Spurious Emission (5G NR n5) (5G NR n2) (5G NR n66) (5G NR n77)	< 43+10log10(P[Watts])	PASS	Under limit 29.69 dB at 7488.000 MHz

Declaration of Conformity:
 The test results with all measurement uncertainty excluded are presented in accordance with the regulation limits or requirements declared by manufacturers.

Comments and Explanations:
 The declared of product specification for EUT presented in the report are provided by the manufacturer, and the manufacturer takes all the responsibilities for the accuracy of product specification.



1 General Description

1.1 Applicant

KonnnectONE, LLC
40 Lake Bellevue Drive, Suite 350, Bellevue, WA 98005

1.2 Manufacturer

MeiG Smart Technology Co., Ltd
Floor 2, Office Building No.5, Lingxia Road, Fenghuang Community, Fuyong Street, Bao 'an District, Shenzhen

1.3 Product Feature of Equipment Under Test

Product Feature	
Equipment	5G MiFi
Brand Name	moxee
Model Name	K873HSVL
FCC ID	2APQU-K873HSVL
HW Version	873_V1.01_PCB
SW Version	K873HSVL_6.0.01_EQ102
EUT Stage	Identical Prototype

Remark:

1. Only 5G NR bands are tested in this report, all the other RF bands are tested in the other reports separately.
2. This is a report for change in FCC ID, there is no difference on the product design, all the test results are leveraged from original FCC ID: 2APJ4-SRT873, report number FG133010E.

1.4 Product Specification of Equipment Under Test

Standards-related Product Specification	
Tx Frequency	5G NR n2 : 1850 MHz ~ 1910 MHz 5G NR n5 : 824 MHz ~ 849 MHz 5G NR n66 : 1710 MHz ~ 1780 MHz 5G NR n77: 3700 MHz ~ 3980 MHz
Rx Frequency	5G NR n2 : 1930 MHz ~ 1990 MHz 5G NR n5 : 869 MHz ~ 894 MHz 5G NR n66 : 2110 MHz~ 2200 MHz 5G NR n77: 3700 MHz ~ 3980 MHz
SCS	n2, n5, n7, n66: 15kHz n77: 30kHz
Bandwidth	n2, n5, n66: 5MHz / 10MHz / 15MHz / 20MHz n77: 20MHz / 40MHz / 50MHz / 60MHz / 80MHz / 90MHz / 100MHz
Maximum Output Power to Antenna	<Ant.0>: 5G NR n2 : 24..95 dBm 5G NR n5 : 24.75 dBm



	5G NR n66 : 24.95 dBm <Ant.4> : 5G NR n77 : 24.76 dBm <Ant.4+5> : 5G NR n77 UL MIMO : 23.21 dBm
Antenna Gain	<Ant. 0> : 5G NR n2: 1.90 dBi 5G NR n5: 1.90 dBi 5G NR n66: 3.30 dBi <Ant. 1> : 5G NR n5: -2.20 dBi <Ant. 4> : 5G NR n77: 5.00 dBi <Ant. 5> : 5G NR n77: 4.60 dBi <Ant. 6> : 5G NR n2: 0.30 dBi 5G NR n66: 0.40 dBi
Type of Modulation	CP-OFDM: QPSK / 16QAM / 64QAM / 256QAM DFT-s-OFDM: PI/2 BPSK / QPSK / 16QAM / 64QAM / 256QAM

Remark:

1. The maximum ERP/EIRP is calculated from max output power and max antenna gain, only the maximum ERP/EIRP is shown in the report, 5G NR SA n2/n5/n66 for Antenna 0, 5G NR SA n77 for Antenna 4.
2. 5G NR n77 support UL MIMO mode.
3. 5G NR supports SA and NSA mode, all the EN-DC modes are tested, and according to the maximum power, only show the worst EN-DC mode in the report
4. The EN-DC mode combination could be referred to the product spec.

1.5 Modification of EUT

No modifications are made to the EUT during all test items.



1.6 Maximum ERP/EIRP Power and Emission Designator

5G NR n2		PI/2 BPSK / QPSK		16QAM / 64QAM / 256QAM	
BW (MHz)	Frequency Range (MHz)	Maximum EIRP(W)	Emission Designator (99%OBW)	Maximum EIRP(W)	Emission Designator (99%OBW)
5	1852.5 ~ 1907.5	0.4395	4M47G7D	0.3573	4M48W7D
10	1855.0 ~ 1905.0	0.4529	9M26G7D	0.3656	9M28W7D
15	1857.5 ~ 1902.5	0.4603	14M1G7D	0.3648	14M1W7D
20	1860.0 ~ 1900.0	0.4842	18M9G7D	0.3698	19M0W7D

5G NR n2 (EN DC_5A_n2A)		PI/2 BPSK / QPSK		16QAM / 64QAM / 256QAM	
BW (MHz)	Frequency Range (MHz)	Maximum EIRP(W)	Emission Designator (99%OBW)	Maximum EIRP(W)	Emission Designator (99%OBW)
5	1852.5 ~ 1907.5	0.3112	4M47G7D	0.2500	4M47W7D
10	1855.0 ~ 1905.0	0.3236	9M25G7D	0.2472	9M28W7D
15	1857.5 ~ 1902.5	0.3281	14M1G7D	0.2582	14M1W7D
20	1860.0 ~ 1900.0	0.3289	18M9G7D	0.2541	19M0W7D

5G NR n5		PI/2 BPSK / QPSK		16QAM / 64QAM / 256QAM	
BW (MHz)	Frequency Range (MHz)	Maximum ERP(W)	Emission Designator (99%OBW)	Maximum ERP(W)	Emission Designator (99%OBW)
5	826.5 ~ 846.5	0.2793	4M47G7D	0.2244	4M49W7D
10	829.0 ~ 844.0	0.2698	9M27G7D	0.2173	9M27W7D
15	831.5 ~ 841.5	0.2799	14M1G7D	0.2228	14M1W7D
20	834.0 ~ 839.0	0.2818	18M9G7D	0.2183	18M9W7D

5G NR n5 (EN DC_2A_66A_n5A)		PI/2 BPSK / QPSK		16QAM / 64QAM / 256QAM	
BW (MHz)	Frequency Range (MHz)	Maximum ERP(W)	Emission Designator (99%OBW)	Maximum ERP(W)	Emission Designator (99%OBW)
5	826.5 ~ 846.5	0.0881	4M47G7D	0.0731	4M49W7D
10	829.0 ~ 844.0	0.0883	9M27G7D	0.0726	9M28W7D
15	831.5 ~ 841.5	0.0879	14M1G7D	0.0723	14M1W7D
20	834.0 ~ 839.0	0.0914	18M9G7D	0.0729	18M9W7D



5G NR n66		PI/2 BPSK / QPSK		16QAM / 64QAM / 256QAM	
BW (MHz)	Frequency Range (MHz)	Maximum EIRP(W)	Emission Designator (99%OBW)	Maximum EIRP(W)	Emission Designator (99%OBW)
5	1712.5 ~ 1777.5	0.6427	4M48G7D	0.5164	4M48W7D
10	1715.0 ~ 1775.0	0.6516	9M27G7D	0.5649	9M28W7D
15	1717.5 ~ 1772.5	0.6637	14M1G7D	0.5623	14M1W7D
20	1720.0 ~ 1770.0	0.6683	18M9G7D	0.5248	19M0W7D

5G NR n66 (EN DC_2A_n66A)		PI/2 BPSK / QPSK		16QAM / 64QAM / 256QAM	
BW (MHz)	Frequency Range (MHz)	Maximum EIRP(W)	Emission Designator (99%OBW)	Maximum EIRP(W)	Emission Designator (99%OBW)
5	1712.5 ~ 1777.5	0.3221	4M48G7D	0.2570	4M48W7D
10	1715.0 ~ 1775.0	0.3251	9M25G7D	0.2582	9M28W7D
15	1717.5 ~ 1772.5	0.3357	14M1G7D	0.2685	14M1W7D
20	1720.0 ~ 1770.0	0.3365	18M9G7D	0.2692	19M0W7D

5G NR n77		PI/2 BPSK / QPSK		16QAM / 64QAM / 256QAM	
BW (MHz)	Frequency Range (MHz)	Maximum EIRP(W)	Emission Designator (99%OBW)	Maximum EIRP(W)	Emission Designator (99%OBW)
20	3710.01 ~ 3969.99	0.9036	18M2G7D	0.7244	18M2W7D
40	3720.00 ~ 3960.00	0.9376	37M8G7D	0.7621	37M9W7D
50	3725.01 ~ 3954.99	0.8414	47M6G7D	0.6668	47M9W7D
60	3730.02 ~ 3949.98	0.8810	58M0G7D	0.7079	57M9W7D
80	3740.01 ~ 3939.99	0.9078	77M6G7D	0.7194	77M6W7D
90	3745.02 ~ 3934.98	0.8590	88M1G7D	0.6918	88M4W7D
100	3750.00 ~ 3930.00	0.9462	97M5G7D	0.7482	97M7W7D



5G NR n77 UL MIMO		PI/2 BPSK / QPSK		16QAM / 64QAM / 256QAM	
BW (MHz)	Frequency Range (MHz)	Maximum EIRP(W)	Emission Designator (99%OBW)	Maximum EIRP(W)	Emission Designator (99%OBW)
20	3710.01 ~ 3969.99	0.6080	18M3G7D	0.5334	18M3W7D
40	3720.00 ~ 3960.00	0.6350	37M9G7D	0.5673	38M2W7D
50	3725.01 ~ 3954.99	0.6088	47M8G7D	0.5180	47M8W7D
60	3730.02 ~ 3949.98	0.6344	58M1G7D	0.5444	58M1W7D
80	3740.01 ~ 3939.99	0.6255	77M8G7D	0.5460	77M7W7D
90	3745.02 ~ 3934.98	0.6616	87M6G7D	0.5681	87M8W7D
100	3750.00 ~ 3930.00	0.6369	97M7G7D	0.5604	97M7W7D

5G NR n77 (EN DC_2A_n77A)		PI/2 BPSK / QPSK		16QAM / 64QAM / 256QAM	
BW (MHz)	Frequency Range (MHz)	Maximum EIRP(W)	Emission Designator (99%OBW)	Maximum EIRP(W)	Emission Designator (99%OBW)
20	3710.01 ~ 3969.99	0.9036	18M2G7D	0.7907	18M2W7D
40	3720.00 ~ 3960.00	0.9311	37M8G7D	0.7762	37M9W7D
50	3725.01 ~ 3954.99	0.8954	47M4G7D	0.7345	47M5W7D
60	3730.02 ~ 3949.98	0.9376	57M9G7D	0.7691	57M8W7D
80	3740.01 ~ 3939.99	0.9099	77M5G7D	0.7638	77M5W7D
90	3745.02 ~ 3934.98	0.8913	87M5G7D	0.7178	87M5W7D
100	3750.00 ~ 3930.00	0.9376	97M3G7D	0.7925	97M5W7D

Note: All modulations have been tested, only the worst test results of PSK & QAM are shown in the report.



1.7 Testing Location

Sporton International (Kunshan) Inc. is accredited to ISO/IEC 17025:2017 by American Association for Laboratory Accreditation with Certificate Number 5145.02.

Test Firm	Sporton International (Kunshan) Inc.		
Test Site Location	No. 1098, Pengxi North Road, Kunshan Economic Development Zone Jiangsu Province 215300 People's Republic of China TEL : +86-512-57900158 FAX : +86-512-57900958		
Test Site No.	Sporton Site No.	FCC Designation No.	FCC Test Firm Registration No.
	03CH04-KS	CN1257	314309

Sporton International (Shenzhen) Inc. is accredited to ISO/IEC 17025:2017 by American Association for Laboratory Accreditation with Certificate Number 5145.01.

Test Firm	Sporton International (Shenzhen) Inc.		
Test Site Location	1/F, 2/F, Bldg 5, Shiling Industrial Zone, Xinwei Village, Xili, Nanshan, Shenzhen, 518055 People's Republic of China TEL: +86-755-86379589 FAX: +86-755-86379595		
Test Site No.	Sporton Site No.	FCC Designation No.	FCC Test Firm Registration No.
	TH01-SZ	CN1256	421272

Test data subcontracted: conducted test items in section 3.4 ~ 3.9 of this report.

1.8 Test Software

Item	Site	Manufacturer	Name	Version
1.	03CH04-KS	AUDIX	E3	6.2009-8-24a

1.9 Applicable Standards

According to the specifications of the manufacturer, the EUT must comply with the requirements of the following standards:

- ♦ 47 CFR Part 2, 22, 24, 27
- ♦ ANSI C63.26-2015
- ♦ FCC KDB 971168 D01 Power Meas License Digital Systems v03r01
- ♦ FCC KDB 412172 D01 Determining ERP and EIRP v01r01

Remark: All test items were verified and recorded according to the standards and without any deviation during the test.



2 Test Configuration of Equipment Under Test

2.1 Test Mode

Antenna port conducted and radiated test items are performed according to KDB 971168 D01 Power Meas License Digital Systems v03r01 with maximum output power.

For radiated measurement, pre-scanned in three orthogonal panels, X, Y, Z. The worst cases (X plane) were recorded in this report.

The device is investigated from 30MHz to 10 times of fundamental signal for radiated spurious emission test under different RB size/offset and modulations in exploratory test. Subsequently, only the worst case emissions are reported.

Orthogonal Planes of EUT	X Plane	Y Plane	Z Plane
			

Test Cases	Band	Bandwidth (MHz)	Modulation	RB #	Test Channel
		eg. 5M, 10M, 15M, 20M	eg. QPSK, 16QAM, 64QAM	1RB, Partial RB, Full RB	L/M/H
Max. Output Power	5G n2	5M, 10M, 15M, 20M	PI/2 BPSK, QPSK, 16QAM, 64QAM, 256QAM	1RB, Partial RB, Full RB	L, M, H
	5G n5	5M, 10M, 15M, 20M	PI/2 BPSK, QPSK, 16QAM, 64QAM, 256QAM	1RB, Partial RB, Full RB	L, M, H
	5G n66	5M, 10M, 15M, 20M,	PI/2 BPSK, QPSK, 16QAM, 64QAM, 256QAM	1RB, Partial RB, Full RB	L, M, H
	5G n77	20M, 40M, 50M, 60M, 80M, 90M, 100M	PI/2 BPSK, QPSK, 16QAM, 64QAM, 256QAM	1RB, Partial RB, Full RB	L, M, H
	5G n77 UL-MIMO	20M, 40M, 50M, 60M, 80M, 90M, 100M	QPSK, 16QAM, 64QAM, 256QAM	1RB, Partial RB, Full RB	L, M, H
Peak-to-Average Ratio	5G n2	20M	PI/2 BPSK, QPSK	1RB, Full RB	L, M, H
	5G n5	20M	PI/2 BPSK, QPSK	1RB, Full RB	L, M, H
	5G n66	20M	PI/2 BPSK, QPSK	1RB, Full RB	L, M, H
	5G n77	20M	PI/2 BPSK, QPSK	1RB, Full RB	L, M, H
	5G n77 UL-MIMO	20M	QPSK	1RB, Full RB	L, M, H
E.I.R.P	5G n2	5M, 10M, 15M, 20M	PI/2 BPSK, QPSK, 16QAM, 64QAM, 256QAM	1RB, Partial RB, Full RB	L, M, H
	5G n5	5M, 10M, 15M, 20M	PI/2 BPSK, QPSK, 16QAM, 64QAM, 256QAM	1RB, Partial RB, Full RB	L, M, H
	5G n66	5M, 10M, 15M, 20M,	PI/2 BPSK, QPSK, 16QAM, 64QAM, 256QAM	1RB, Partial RB, Full RB	L, M, H
	5G n77	20M, 40M, 50M, 60M, 80M, 90M, 100M	PI/2 BPSK, QPSK, 16QAM, 64QAM, 256QAM	1RB, Partial RB, Full RB	L, M, H
	5G n77 UL-MIMO	20M, 40M, 50M, 60M, 80M, 90M, 100M	QPSK, 16QAM, 64QAM, 256QAM	1RB, Partial RB, Full RB	L, M, H



Test Cases	Band	Bandwidth (MHz)	Modulation	RB #	Test Channel
		eg. 5M, 10M, 15M, 20M	eg. QPSK, 16QAM, 64QAM	1RB, Partial RB, Full RB	L/M/H
26dB and 99% Bandwidth	5G n2	5M, 10M, 15M, 20M	PI/2 BPSK, QPSK, 16QAM, 64QAM, 256QAM	Full RB	M
	5G n5	5M, 10M, 15M, 20M	PI/2 BPSK, QPSK, 16QAM, 64QAM, 256QAM	Full RB	M
	5G n66	5M, 10M, 15M, 20M,	PI/2 BPSK, QPSK, 16QAM, 64QAM, 256QAM	Full RB	M
	5G n77	20M, 40M, 50M, 60M, 80M, 90M, 100M	PI/2 BPSK, QPSK, 16QAM, 64QAM, 256QAM	Full RB	M
	5G n77 UL-MIMO	20M, 40M, 50M, 60M, 80M, 90M, 100M	QPSK, 16QAM, 64QAM, 256QAM	Full RB	M
Conducted Band Edge	5G n2	5M, 10M, 20M	PI/2 BPSK, QPSK	1RB, Full RB	L, H
	5G n5	5M, 10M, 20M	PI/2 BPSK, QPSK	1RB, Full RB	L, H
	5G n66	5M, 10M, 20M	PI/2 BPSK, QPSK	1RB, Full RB	L, H
	5G n77	20M, 60M, 100M	PI/2 BPSK, QPSK	1RB, Full RB	L, H
	5G n77 UL-MIMO	20M, 60M, 100M	QPSK	1RB, Full RB	L, H
Conducted Spurious Emission	5G n2	5M, 10M, 20M	PI/2 BPSK, QPSK	1RB	L, M, H
	5G n5	5M, 10M, 20M	PI/2 BPSK, QPSK	1RB	L, M, H
	5G n66	5M, 10M, 20M	PI/2 BPSK, QPSK	1RB	L, M, H
	5G n77	20M, 60M, 100M	PI/2 BPSK, QPSK	1RB	L, M, H
	5G n77 UL-MIMO	20M, 60M, 100M	QPSK	1RB	L, M, H
Frequency Stability	5G n2	20M	QPSK	Full RB	M
	5G n5	20M	QPSK	Full RB	M
	5G n66	20M	QPSK	Full RB	M
	5G n77/ n77 UL-MIMO	20M	QPSK	Full RB	M
Radiated Spurious Emission	5G n2	Worst case from maximum power			M
	5G n5	Worst case from maximum power			M
	5G n66	Worst case from maximum power			M
	5G n77	Worst case from maximum power			M

Note:

1. The device is investigated from 30MHz to 10 times of fundamental signal for radiated spurious emission test under different RB size/offset and modulations in exploratory test. Subsequently, only the worst case emissions are reported.
2. Based on engineering evaluation, only the worst modulations test results are shown in the report.

2.2 Connection Diagram of Test System

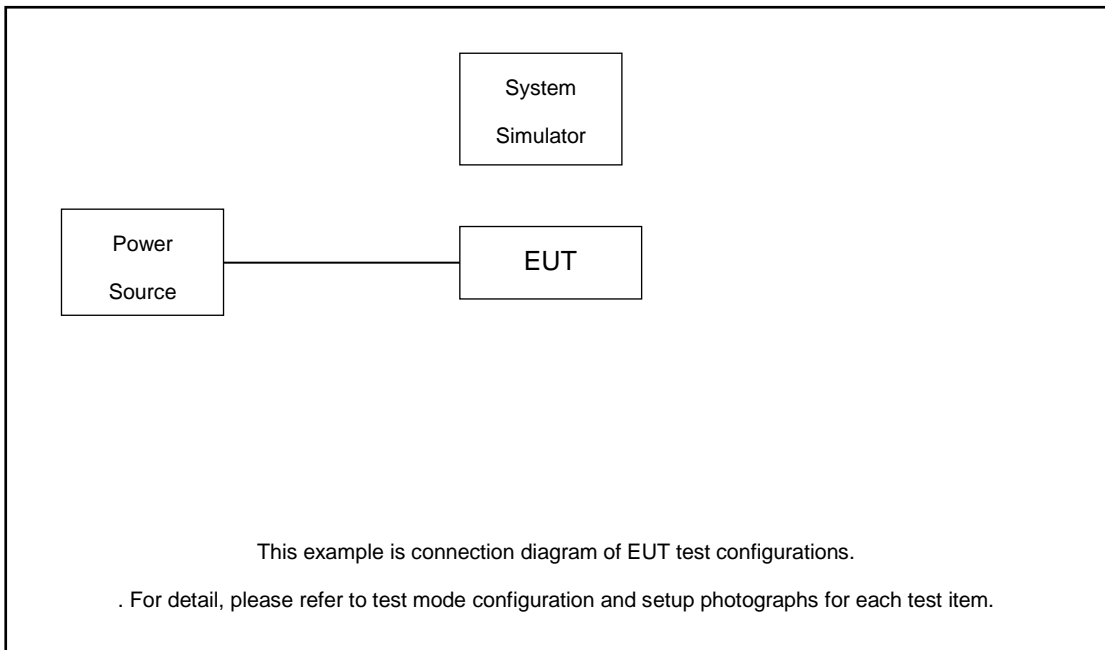

2.3 Support Unit used in test configuration and system

Item	Equipment	Trade Name	Model No.	FCC ID	Data Cable	Power Cord
1.	DC Power Supply	GW	GPS-3030D	N/A	N/A	Unshielded, 1.8 m
2.	LTE Base Station	Anritsu	MT8821C	N/A	N/A	Unshielded, 1.8 m
3.	NR Base Station	Anritsu	MT8000A	N/A	N/A	Unshielded, 1.8 m

2.4 Measurement Results Explanation Example

For all conducted test items:

The offset level is set in the spectrum analyzer to compensate the RF cable loss and attenuator factor between EUT conducted output port and spectrum analyzer. With the offset compensation, the spectrum analyzer reading level is exactly the EUT RF output level.

The spectrum analyzer offset is derived from RF cable loss and attenuator factor.

Offset = RF cable loss + attenuator factor.

Following shows an offset computation example with cable loss 1.76 dB and 10dB attenuator.

Example :

$$\begin{aligned} \text{Offset(dB)} &= \text{RF cable loss(dB)} + \text{attenuator factor(dB)}. \\ &= 1.76 + 10 = 11.76 \text{ (dB)} \end{aligned}$$



2.5 Frequency List of Low/Middle/High Channels

5G NR n2 Channel and Frequency List				
BW [MHz]	Channel/Frequency(MHz)	Lowest	Middle	Highest
20	Channel	388000	392000	396000
	Frequency	1860	1880	1900
15	Channel	387500	392000	396500
	Frequency	1857.5	1880	1902.5
10	Channel	387000	392000	397000
	Frequency	1855	1880	1905
5	Channel	386500	392000	397500
	Frequency	1852.5	1880	1907.5

5G NR n5 Channel and Frequency List				
BW [MHz]	Channel/Frequency(MHz)	Lowest	Middle	Highest
20	Channel	175800	176300	176800
	Frequency	834	836.5	839
15	Channel	175300	176300	177300
	Frequency	831.5	836.5	841.5
10	Channel	174800	176300	177800
	Frequency	829	836.5	844
5	Channel	174300	176300	178300
	Frequency	826.5	836.5	846.5



5G NR n66 Channel and Frequency List				
BW [MHz]	Channel/Frequency(MHz)	Lowest	Middle	Highest
20	Channel	424000	429000	434000
	Frequency	1720	1745	1770
15	Channel	423500	429000	434500
	Frequency	1717.5	1745	1772.5
10	Channel	423000	429000	435000
	Frequency	1715	1745	1775
5	Channel	422500	429000	435500
	Frequency	1712.5	1745	1777.5

5G NR n77 Channel and Frequency List				
BW [MHz]	Channel/Frequency(MHz)	Lowest	Middle	Highest
100	Channel	650000	656000	662000
	Frequency	3750	3840	3930
90	Channel	649668	656000	662332
	Frequency	3745.02	3840	3934.98
80	Channel	649334	656000	662666
	Frequency	3740.01	3840	3939.99
60	Channel	648668	656000	663332
	Frequency	3730.02	3840	3949.98
50	Channel	648334	656000	663666
	Frequency	3725.01	3840	3954.99
40	Channel	648000	656000	664000
	Frequency	3720	3840	3960
20	Channel	647334	656000	664666
	Frequency	3710.01	3840	3969.99

3 Conducted Test Items

3.1 Measuring Instruments

See list of measuring instruments of this test report.

3.2 Test Setup

3.2.1 Conducted Output Power



3.2.2 Peak-to-Average Ratio, Occupied Bandwidth ,Conducted Band-Edge and Conducted Spurious Emission

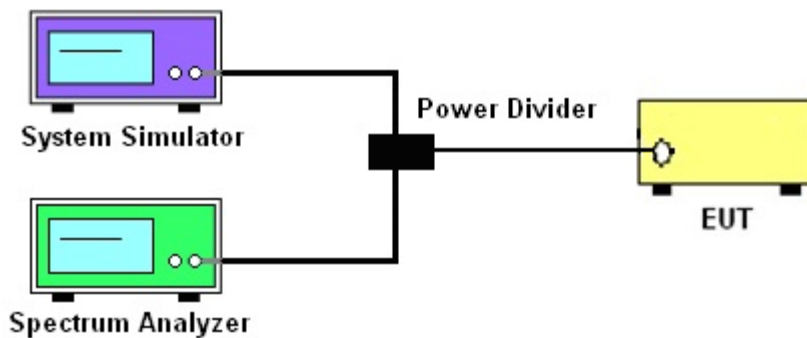

3.2.3 Frequency Stability

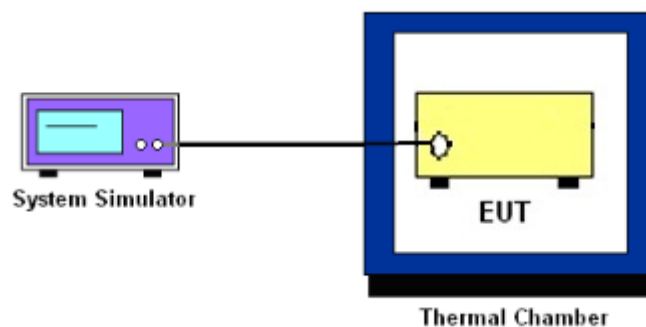

3.3 Test Result of Conducted Test

Please refer to Appendix A.



3.4 Conducted Output Power and ERP/EIRP

3.4.1 Description of the Conducted Output Power Measurement and ERP/EIRP Measurement

A system simulator was used to establish communication with the EUT. Its parameters were set to force the EUT transmitting at maximum output power. The measured power in the radio frequency on the transmitter output terminals shall be reported.

The ERP of mobile transmitters must not exceed 7 Watts for 5G NR n5.

The EIRP of mobile transmitters must not exceed 2 Watts for 5G NR n2.

The EIRP of mobile transmitters must not exceed 1 Watts for 5G NR n66, n77.

According to KDB 412172 D01 Power Approach,

$EIRP = P_T + G_T - L_C$, $ERP = EIRP - 2.15$, where

P_T = transmitter output power in dBm

G_T = gain of the transmitting antenna in dBi

L_C = signal attenuation in the connecting cable between the transmitter and antenna in dB

3.4.2 Test Procedures

1. The testing follows ANSI C63.26 Section 5.2
2. The transmitter output port was connected to the system simulator.
3. Set EUT at maximum power through the system simulator.
4. Select lowest, middle, and highest channels for each band and different modulation.
5. Measure and record the power level from the system simulator.



3.5 Peak-to-Average Ratio

3.5.1 Description of the PAR Measurement

Power Complementary Cumulative Distribution Function (CCDF) curves provide a means for characterizing the power peaks of a digitally modulated signal on a statistical basis. A CCDF curve depicts the probability of the peak signal amplitude exceeding the average power level. Most contemporary measurement instrumentation include the capability to produce CCDF curves for an input signal provided that the instrument's resolution bandwidth can be set wide enough to accommodate the entire input signal bandwidth. In measuring transmissions in this band using an average power technique, the peak-to-average ratio (PAR) of the transmission may not exceed 13 dB.

3.5.2 Test Procedures

1. The testing follows ANSI C63.26 Section 5.2.3.4 (CCDF).
2. The EUT was connected to spectrum and system simulator via a power divider.
3. Set the CCDF (Complementary Cumulative Distribution Function) option in spectrum analyzer.
4. The highest RF powers were measured and recorded the maximum PAPR level associated with a probability of 0.1 %.
5. Record the deviation as Peak to Average Ratio.



3.6 Occupied Bandwidth

3.6.1 Description of Occupied Bandwidth Measurement

The occupied bandwidth is the width of a frequency band such that, below the lower and above the upper frequency limits, the mean powers emitted are each equal to a specified percentage 0.5% of the total mean transmitted power.

The 26 dB emission bandwidth is defined as the frequency range between two points, one above and one below the carrier frequency, at which the spectral density of the emission is attenuated 26 dB below the maximum in-band spectral density of the modulated signal. Spectral density (power per unit bandwidth) is to be measured with a detector of resolution bandwidth equal to approximately 1.0% of the emission bandwidth.

3.6.2 Test Procedures

1. The testing follows ANSI C63.26 Section 5.4
2. The EUT was connected to spectrum analyzer and system simulator via a power divider.
3. The spectrum analyzer center frequency is set to the nominal EUT channel center frequency. The span range for the spectrum analyzer shall be between two and five times the anticipated OBW.
4. The nominal resolution bandwidth (RBW) shall be in the range of 1 to 5 % of the anticipated OBW, and the VBW shall be at least 3 times the RBW.
5. Set the detection mode to peak, and the trace mode to max hold.
6. Determine the reference value: Set the EUT to transmit a modulated signal. Allow the trace to stabilize. Set the spectrum analyzer marker to the highest level of the displayed trace.
(this is the reference value)
7. Determine the “-26 dB down amplitude” as equal to (Reference Value – X).
8. Place two markers, one at the lowest and the other at the highest frequency of the envelope of the spectral display such that each marker is at or slightly below the “-X dB down amplitude” determined in step 6. If a marker is below this “-X dB down amplitude” value it shall be placed as close as possible to this value. The OBW is the positive frequency difference between the two markers.
9. Use the 99 % power bandwidth function of the spectrum analyzer and report the measured bandwidth.



3.7 Conducted Band Edge

3.7.1 Description of Conducted Band Edge Measurement

22.917(a)

For operations in the 824 – 849 MHz band, the FCC limit is $43 + 10\log_{10}(P[\text{Watts}])$ dB below the transmitter power $P(\text{Watts})$ in a 100kHz bandwidth. However, in the 1MHz bands immediately outside and adjacent to the licensee's frequency block, a resolution bandwidth of at least one percent of the emission bandwidth of the fundamental emission of the transmitter may be employed.

24.238 (a)

For operations in the 1850-1910 and 1930-1990 MHz band, the FCC limit is $43 + 10\log_{10}(P[\text{Watts}])$ dB below the transmitter power $P(\text{Watts})$ in a 1MHz bandwidth. However, in the 1 MHz bands immediately outside and adjacent to the frequency block a resolution bandwidth of at least one percent of the emission bandwidth of the fundamental emission of the transmitter may be employed.

27.53 (h)

For operations in the 1710 – 1755 MHz band, the FCC limit is $43 + 10\log_{10}(P[\text{Watts}])$ dB below the transmitter power $P(\text{Watts})$ in a 1 MHz bandwidth. However, in the 1MHz bands immediately outside and adjacent to the licensee's frequency block, a resolution bandwidth of at least one percent of the emission bandwidth of the fundamental emission of the transmitter may be employed.

27.53(l)(2)

For mobile operations in the 3700-3980 MHz band, the conducted power of any emission outside the licensee's authorized bandwidth shall not exceed -13 dBm/MHz. Compliance with this paragraph is based on the use of measurement instrumentation employing a resolution bandwidth of 1 megahertz or greater. However, in the 1 megahertz bands immediately outside and adjacent to the licensee's frequency block, the minimum resolution bandwidth for the measurement shall be either one percent of the emission bandwidth of the fundamental emission of the transmitter or 350 kHz. In the bands between 1 and 5 MHz removed from the licensee's frequency block, the minimum resolution bandwidth for the measurement shall be 500 kHz.



3.7.2 Test Procedures

1. The testing follows ANSI C63.26 section 5.7
2. The EUT was connected to spectrum analyzer and system simulator via a power divider.
3. The band edges of low and high channels for the highest RF powers were measured.
4. Set RBW \geq 1% EBW in the 1MHz band immediately outside and adjacent to the band edge.
5. Beyond the 1 MHz band from the band edge, RBW=1MHz was used.
6. Set spectrum analyzer with RMS detector.
7. The RF fundamental frequency should be excluded against the limit line in the operating frequency band.
8. Checked that all the results comply with the emission limit line.

Example:

The limit line is derived from $43 + 10\log(P)$ dB below the transmitter power P(Watts)
= P(W)- [43 + 10log(P)] (dB)
= [30 + 10log(P)] (dBm) - [43 + 10log(P)] (dB) = -13dBm.



3.8 Conducted Spurious Emission

3.8.1 Description of Conducted Spurious Emission Measurement

The power of any emission outside of the authorized operating frequency ranges must be lower than the transmitter power (P) by a factor of at least $43 + 10 \log (P)$ dB.

It is measured by means of a calibrated spectrum analyzer and scanned from 30 MHz up to a frequency including its 10th harmonic.

3.8.2 Test Procedures

1. The testing follows ANSI C63.26 section 5.7
2. The EUT was connected to spectrum analyzer and system simulator via a power divider.
3. The RF output of EUT was connected to the spectrum analyzer by RF cable and attenuator. The path loss was compensated to the results for each measurement.
4. The middle channel for the highest RF power within the transmitting frequency was measured.
5. The conducted spurious emission for the whole frequency range was taken.
6. Make the measurement with the spectrum analyzer's RBW = 1MHz, VBW = 3MHz.
7. Set spectrum analyzer with RMS detector.
8. Taking the record of maximum spurious emission.
9. The RF fundamental frequency should be excluded against the limit line in the operating frequency band.
10. The limit line is derived from $43 + 10\log(P)$ dB below the transmitter power P(Watts)
= P(W)- [43 + 10log(P)] (dB)
= [30 + 10log(P)] (dBm) - [43 + 10log(P)] (dB)
= -13dBm.



3.9 Frequency Stability

3.9.1 Description of Frequency Stability Measurement

The frequency stability shall be measured by variation of ambient temperature and variation of primary supply voltage to ensure that the fundamental emission stays within the authorized frequency block. The frequency stability of the transmitter shall be maintained within $\pm 0.00025\%$ ($\pm 2.5\text{ppm}$) of the center frequency.

3.9.2 Test Procedures for Temperature Variation

1. The testing follows ANSI C63.26 section 5.6.4
2. The EUT was set up in the thermal chamber and connected with the system simulator.
3. With power OFF, the temperature was decreased to -30°C and the EUT was stabilized before testing. Power was applied and the maximum change in frequency was recorded within one minute.
4. With power OFF, the temperature was raised in 10°C step up to 50°C . The EUT was stabilized at each step for at least half an hour. Power was applied and the maximum frequency change was recorded within one minute.

3.9.3 Test Procedures for Voltage Variation

1. The testing follows ANSI C63.26 section 5.6.5
2. The EUT was placed in a temperature chamber at $20\pm 5^{\circ}\text{C}$ and connected with the system simulator.
3. The power supply voltage to the EUT was varied from 85% to 115% of the nominal value for other than hand carried battery equipment.
4. For hand carried, battery powered equipment, reduce the primary ac or dc supply voltage to the battery operating end point, which shall be specified by the manufacturer.
5. The variation in frequency was measured for the worst case.

4 Radiated Test Items

4.1 Measuring Instruments

See list of measuring instruments of this test report.

4.2 Test Setup

4.2.1 For radiated test below 30MHz

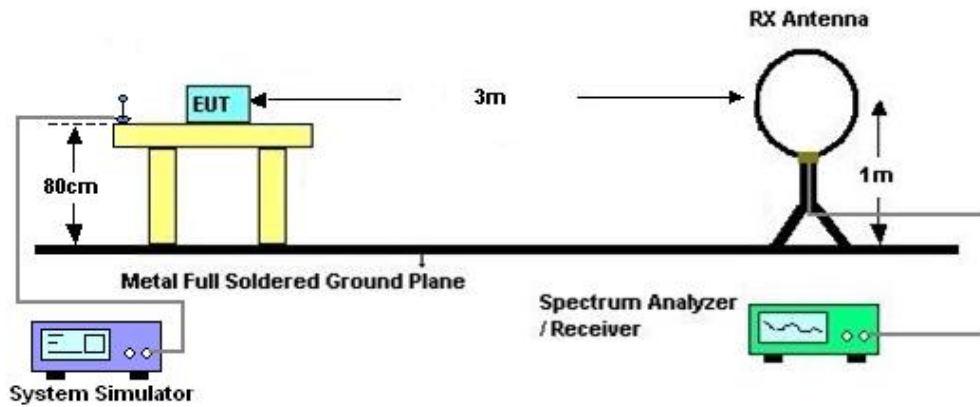

4.2.2 For radiated test from 30MHz to 1GHz

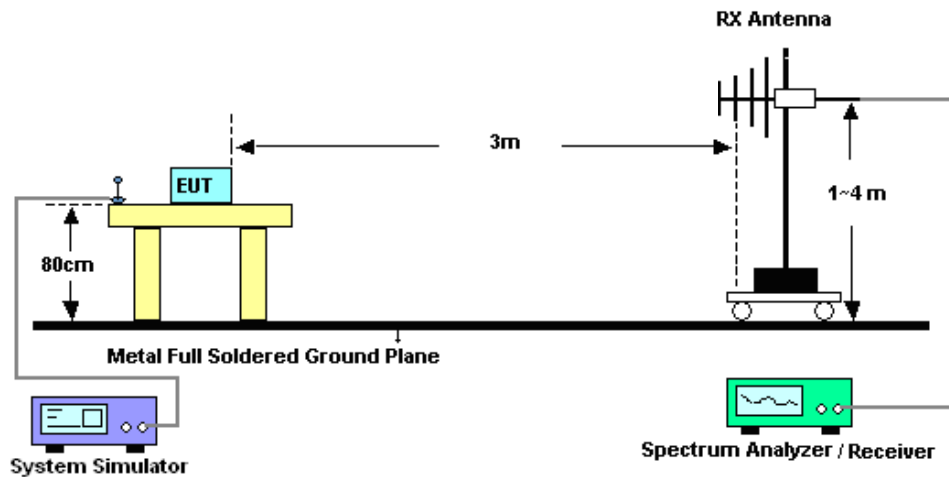

4.2.3 For radiated test above 1GHz

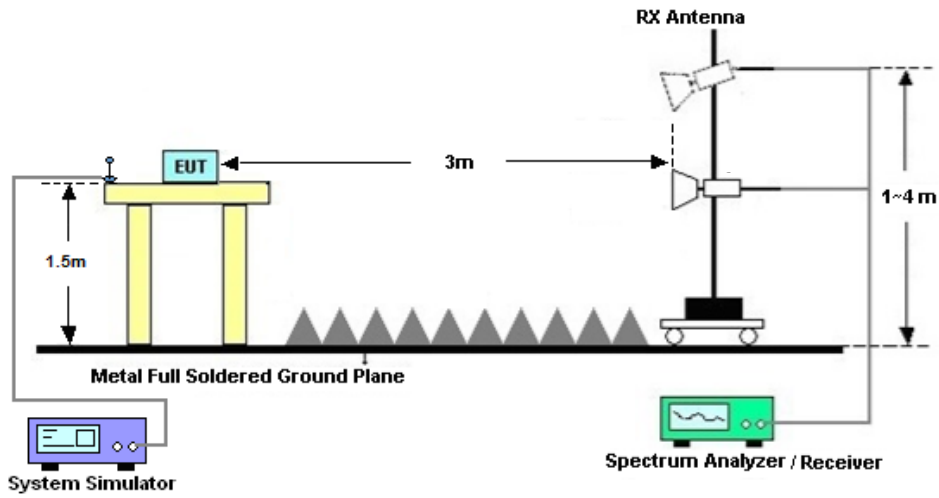

4.3 Test Result of Radiated Test

The low frequency, which started from 9 kHz to 30MHz, was pre-scanned and the result which was 20dB lower than the limit line was not reported.

Please refer to Appendix B.



4.4 Radiated Spurious Emission

4.4.1 Description of Radiated Spurious Emission

The radiated spurious emission was measured by substitution method according to ANSI C63.26. The power of any emission outside of the authorized operating frequency ranges must be attenuated below the transmitter power (P) by a factor of at least $43 + 10 \log (P)$ dB.

The spectrum is scanned from 30 MHz up to a frequency including its 10th harmonic.

4.4.2 Test Procedures

1. The testing follows ANSI C63.26 Section 5.5
2. The EUT was placed on a turntable with 0.8 meter height for frequency below 1GHz and 1.5 meter height for frequency above 1GHz respectively above ground.
3. The EUT was set 3 meters from the receiving antenna mounted on the antenna tower.
4. The table was rotated 360 degrees to determine the position of the highest spurious emission.
5. The height of the receiving antenna is varied between 1m to 4m to search the maximum spurious emission for both horizontal and vertical polarizations.
6. During the measurement, the system simulator parameters were set to force the EUT transmitting at maximum output power.
7. Make the measurement with the spectrum analyzer's RBW = 1MHz, VBW = 3MHz, taking the record of maximum spurious emission.
8. A horn antenna was substituted in place of the EUT and was driven by a signal generator.
9. Tune the output power of signal generator to the same emission level with EUT maximum spurious emission.
10. $EIRP (dBm) = S.G. Power - Tx Cable Loss + Tx Antenna Gain$
11. $ERP (dBm) = EIRP - 2.15$
12. The RF fundamental frequency should be excluded against the limit line in the operating frequency band.

The limit line is derived from $43 + 10\log(P)$ dB below the transmitter power P(Watts)
 $= P(W) - [43 + 10\log(P)] (dB)$
 $= [30 + 10\log(P)] (dBm) - [43 + 10\log(P)] (dB)$
 $= -13dBm.$



5 List of Measuring Equipment

Instrument	Manufacturer	Model No.	Serial No.	Characteristics	Calibration Date	Test Date	Due Date	Remark
EXA Signal Analyzer	KEYSIGHT	N9010B	MY60240803	10Hz~44GHz	Apr. 03, 2021	Jun. 25, 2021~ Jul. 21, 2021	Apr. 02, 2022	Conducted (TH01-SZ)
Power Divider	TOJOIN	PS-2SM-04 265	60.06.020.007 7	0.4GHz~26.5GHz	Dec. 26, 2020	Jun. 25, 2021~ Jul. 21, 2021	Dec. 25, 2021	Conducted (TH01-SZ)
Thermal Chamber	Ten Billion Hongzhangroup	LP-150U	H2014081803	-40~+150°C	Jul. 15, 2020	Jun. 25, 2021~ Jul. 21, 2021	Jul. 14, 2021	Conducted (TH01-KS)
Thermal Chamber	Ten Billion Hongzhangroup	LP-150U	H2014081803	-40~+150°C	Jul. 14, 2021		Jul. 13, 2022	Conducted (TH01-SZ)
EXA Spectrum Analyzer	Keysight	N9010A	MY55150244	10Hz~44G,MAX 30dB	Apr. 13, 2021	Jul. 10, 2021~ Sep. 02, 2021	Apr. 12, 2022	Radiation (03CH04-KS)
Loop Antenna	R&S	HFH2-Z2	100321	9kHz~30MHz	Nov. 01, 2020	Jul. 10, 2021~ Sep. 02, 2021	Oct. 31, 2021	Radiation (03CH04-KS)
Bilog Antenna	TeseQ	CBL6111D	49922	30MHz-1GHz	Jun. 07, 2021	Jul. 10, 2021~ Sep. 02, 2021	Jun. 06, 2022	Radiation (03CH04-KS)
Double Ridge Horn Antenna	ETS-Lindgren	3117	75957	1GHz~18GHz	Nov. 01, 2020	Jul. 10, 2021~ Sep. 02, 2021	Oct. 31, 2021	Radiation (03CH04-KS)
SHF-EHF Horn	Com-power	AH-840	101115	18GHz~40GHz	Jan. 06, 2021	Jul. 10, 2021~ Sep. 02, 2021	Jan. 05, 2022	Radiation (03CH04-KS)
Amplifier	SONOMA	310N	187289	9KHz-1GHz	Jan. 06, 2021	Jul. 10, 2021~ Sep. 02, 2021	Jan. 05, 2022	Radiation (03CH04-KS)
Amplifier	MITEQ	EM18G40G GA	060728	18~40GHz	Jan. 07, 2021	Jul. 10, 2021~ Sep. 02, 2021	Jan. 06, 2022	Radiation (03CH04-KS)
high gain Amplifier	MITEQ	AMF-7D-00 101800-30-1 0P	2025788	1Ghz-18Ghz	Jan. 06, 2021	Jul. 10, 2021~ Sep. 02, 2021	Jan. 05, 2022	Radiation (03CH04-KS)
Amplifier	Keysight	83017A	MY57280106	500MHz~26.5GHz	Oct. 14, 2020	Jul. 10, 2021~ Sep. 02, 2021	Oct. 13, 2021	Radiation (03CH04-KS)
AC Power Source	Chroma	61601	F104090004	N/A	NCR	Jul. 10, 2021~ Sep. 02, 2021	NCR	Radiation (03CH04-KS)
Turn Table	ChamPro	EM 1000-T	060762-T	0~360 degree	NCR	Jul. 10, 2021~ Sep. 02, 2021	NCR	Radiation (03CH04-KS)
Antenna Mast	ChamPro	EM 1000-A	060762-A	1 m~4 m	NCR	Jul. 10, 2021~ Sep. 02, 2021	NCR	Radiation (03CH04-KS)

NCR: No Calibration Required



6 Uncertainty of Evaluation

The measurement uncertainties shown below were calculated in accordance with the requirements of ANSI 63.26-2015. All the measurement uncertainty value were shown with a coverage K=2 to indicate 95% level of confidence. The measurement data show herein meets or exceeds the CISPR measurement uncertainty values specified in CISPR 16-4-2 and can be compared directly to specified limit to determine compliance.

Uncertainty of Radiated Emission Measurement (30 MHz ~ 1000 MHz)

Measuring Uncertainty for a Level of Confidence of 95% (U = 2Uc(y))	3.3dB
---	-------

Uncertainty of Radiated Emission Measurement (1 GHz ~ 18 GHz)

Measuring Uncertainty for a Level of Confidence of 95% (U = 2Uc(y))	2.8dB
---	-------

Uncertainty of Radiated Emission Measurement (18 GHz ~ 40 GHz)

Measuring Uncertainty for a Level of Confidence of 95% (U = 2Uc(y))	2.8dB
---	-------

----- THE END -----



Appendix A. Test Results of Conducted Test

FR1 N2

<Ant. 0>

Transmitter Conducted Output Power And EIRP, (GT - LC)=1.9dBi

NR Band	SCS (kHz)	Bandwidth (MHz)	Arfcn	Freq (MHz)	Modulation	RB	Conducted Power(dBm)	EIRP (dBm)	EIRP (W)
2	15	5	386500	1852.5	DFT-s-OFDM PI/2 BPSK	12@6	24.15	26.05	0.4027
2	15	5	386500	1852.5	DFT-s-OFDM PI/2 BPSK	1@1	24.24	26.14	0.4111
2	15	5	386500	1852.5	DFT-s-OFDM PI/2 BPSK	1@23	24.2	26.1	0.4074
2	15	5	386500	1852.5	DFT-s-OFDM QPSK	12@6	24.23	26.13	0.4102
2	15	5	386500	1852.5	DFT-s-OFDM QPSK	1@1	24.19	26.09	0.4064
2	15	5	386500	1852.5	DFT-s-OFDM QPSK	1@23	24.29	26.19	0.4159
2	15	5	386500	1852.5	DFT-s-OFDM 16 QAM	12@6	23.63	25.53	0.3573
2	15	5	386500	1852.5	DFT-s-OFDM 16 QAM	1@1	22.91	24.81	0.3027
2	15	5	386500	1852.5	DFT-s-OFDM 16 QAM	1@23	23.44	25.34	0.3420
2	15	5	386500	1852.5	DFT-s-OFDM 64 QAM	12@6	21.74	23.64	0.2312
2	15	5	386500	1852.5	DFT-s-OFDM 64 QAM	1@1	22.09	23.99	0.2506
2	15	5	386500	1852.5	DFT-s-OFDM 64 QAM	1@23	22.01	23.91	0.2460
2	15	5	386500	1852.5	DFT-s-OFDM 256 QAM	12@6	20.14	22.04	0.1600
2	15	5	386500	1852.5	DFT-s-OFDM 256 QAM	1@1	19.3	21.2	0.1318
2	15	5	386500	1852.5	DFT-s-OFDM 256 QAM	1@23	19.14	21.04	0.1271
2	15	5	386500	1852.5	CP-OFDM QPSK	13@6	22.96	24.86	0.3062
2	15	5	386500	1852.5	CP-OFDM QPSK	1@1	22.76	24.66	0.2924
2	15	5	386500	1852.5	CP-OFDM QPSK	1@23	22.77	24.67	0.2931
2	15	5	392000	1852.5	DFT-s-OFDM PI/2 BPSK	12@6	24.53	26.43	0.4395
2	15	5	392000	1880	DFT-s-OFDM PI/2	1@1	24.25	26.15	0.4121

					BPSK					
2	15	5	392000	1880	DFT-s-OFDM PI/2 BPSK	1@23	24.3	26.2	0.4169	
2	15	5	392000	1880	DFT-s-OFDM QPSK	12@6	24.3	26.2	0.4169	
2	15	5	392000	1880	DFT-s-OFDM QPSK	1@1	24.37	26.27	0.4236	
2	15	5	392000	1880	DFT-s-OFDM QPSK	1@23	24.32	26.22	0.4188	
2	15	5	392000	1880	DFT-s-OFDM 16 QAM	12@6	23.42	25.32	0.3404	
2	15	5	392000	1880	DFT-s-OFDM 16 QAM	1@1	23.01	24.91	0.3097	
2	15	5	392000	1880	DFT-s-OFDM 16 QAM	1@23	23.32	25.22	0.3327	
2	15	5	392000	1880	DFT-s-OFDM 64 QAM	12@6	21.91	23.81	0.2404	
2	15	5	392000	1880	DFT-s-OFDM 64 QAM	1@1	22.02	23.92	0.2466	
2	15	5	392000	1880	DFT-s-OFDM 64 QAM	1@23	22.04	23.94	0.2477	
2	15	5	392000	1880	DFT-s-OFDM 256 QAM	12@6	19.9	21.8	0.1514	
2	15	5	392000	1880	DFT-s-OFDM 256 QAM	1@1	19.33	21.23	0.1327	
2	15	5	392000	1880	DFT-s-OFDM 256 QAM	1@23	19.34	21.24	0.1330	
2	15	5	392000	1880	CP-OFDM QPSK	13@6	22.84	24.74	0.2979	
2	15	5	392000	1880	CP-OFDM QPSK	1@1	22.72	24.62	0.2897	
2	15	5	392000	1880	CP-OFDM QPSK	1@23	22.84	24.74	0.2979	
2	15	5	397500	1880	DFT-s-OFDM PI/2 BPSK	12@6	24.31	26.21	0.4178	
2	15	5	397500	1907.5	DFT-s-OFDM PI/2 BPSK	1@1	24.44	26.34	0.4305	
2	15	5	397500	1907.5	DFT-s-OFDM PI/2 BPSK	1@23	24.48	26.38	0.4345	
2	15	5	397500	1907.5	DFT-s-OFDM QPSK	12@6	24.39	26.29	0.4256	
2	15	5	397500	1907.5	DFT-s-OFDM QPSK	1@1	24.45	26.35	0.4315	
2	15	5	397500	1907.5	DFT-s-OFDM QPSK	1@23	24.47	26.37	0.4335	
2	15	5	397500	1907.5	DFT-s-OFDM 16 QAM	12@6	23.5	25.4	0.3467	
2	15	5	397500	1907.5	DFT-s-	1@1	23.39	25.29	0.3381	

					OFDM 16 QAM					
2	15	5	397500	1907.5	DFT-s- OFDM 16 QAM	1@23	23.41	25.31	0.3396	
2	15	5	397500	1907.5	DFT-s- OFDM 64 QAM	12@6	22.17	24.07	0.2553	
2	15	5	397500	1907.5	DFT-s- OFDM 64 QAM	1@1	22.2	24.1	0.2570	
2	15	5	397500	1907.5	DFT-s- OFDM 64 QAM	1@23	22.26	24.16	0.2606	
2	15	5	397500	1907.5	DFT-s- OFDM 256 QAM	12@6	20.07	21.97	0.1574	
2	15	5	397500	1907.5	DFT-s- OFDM 256 QAM	1@1	19.55	21.45	0.1396	
2	15	5	397500	1907.5	DFT-s- OFDM 256 QAM	1@23	19.68	21.58	0.1439	
2	15	5	397500	1907.5	CP-OFDM QPSK	13@6	23.01	24.91	0.3097	
2	15	5	397500	1907.5	CP-OFDM QPSK	1@1	23.03	24.93	0.3112	
2	15	5	397500	1907.5	CP-OFDM QPSK	1@23	22.95	24.85	0.3055	
2	15	10	387000	1907.5	DFT-s- OFDM PI/2 BPSK	25@12	24.04	25.94	0.3926	
2	15	10	387000	1907.5	DFT-s- OFDM PI/2 BPSK	1@1	24.44	26.34	0.4305	
2	15	10	387000	1907.5	DFT-s- OFDM PI/2 BPSK	1@50	24.54	26.44	0.4406	
2	15	10	387000	1855	DFT-s- OFDM QPSK	25@12	24.39	26.29	0.4256	
2	15	10	387000	1855	DFT-s- OFDM QPSK	1@1	24.41	26.31	0.4276	
2	15	10	387000	1855	DFT-s- OFDM QPSK	1@50	24.26	26.16	0.4130	
2	15	10	387000	1855	DFT-s- OFDM 16 QAM	25@12	23.47	25.37	0.3443	
2	15	10	387000	1855	DFT-s- OFDM 16 QAM	1@1	23.3	25.2	0.3311	
2	15	10	387000	1855	DFT-s- OFDM 16 QAM	1@50	23.3	25.2	0.3311	
2	15	10	387000	1855	DFT-s- OFDM 64 QAM	25@12	21.98	23.88	0.2443	
2	15	10	387000	1855	DFT-s- OFDM 64 QAM	1@1	22.24	24.14	0.2594	
2	15	10	387000	1855	DFT-s- OFDM 64 QAM	1@50	22.18	24.08	0.2559	
2	15	10	387000	1855	DFT-s- OFDM 256 QAM	25@12	20	21.9	0.1549	

2	15	10	387000	1855	DFT-s-OFDM 256 QAM	1@1	19.55	21.45	0.1396
2	15	10	387000	1855	DFT-s-OFDM 256 QAM	1@50	19.46	21.36	0.1368
2	15	10	387000	1855	CP-OFDM QPSK	26@13	22.93	24.83	0.3041
2	15	10	387000	1855	CP-OFDM QPSK	1@1	22.85	24.75	0.2985
2	15	10	387000	1855	CP-OFDM QPSK	1@50	22.73	24.63	0.2904
2	15	10	392000	1880	DFT-s-OFDM PI/2 BPSK	25@12	24.55	26.45	0.4416
2	15	10	392000	1880	DFT-s-OFDM PI/2 BPSK	1@1	24.33	26.23	0.4198
2	15	10	392000	1880	DFT-s-OFDM PI/2 BPSK	1@50	24.4	26.3	0.4266
2	15	10	392000	1880	DFT-s-OFDM QPSK	25@12	24.37	26.27	0.4236
2	15	10	392000	1880	DFT-s-OFDM QPSK	1@1	24.33	26.23	0.4198
2	15	10	392000	1880	DFT-s-OFDM QPSK	1@50	24.4	26.3	0.4266
2	15	10	392000	1880	DFT-s-OFDM 16 QAM	25@12	23.48	25.38	0.3451
2	15	10	392000	1880	DFT-s-OFDM 16 QAM	1@1	23.36	25.26	0.3357
2	15	10	392000	1880	DFT-s-OFDM 16 QAM	1@50	23.49	25.39	0.3459
2	15	10	392000	1880	DFT-s-OFDM 64 QAM	25@12	21.98	23.88	0.2443
2	15	10	392000	1880	DFT-s-OFDM 64 QAM	1@1	21.81	23.71	0.2350
2	15	10	392000	1880	DFT-s-OFDM 64 QAM	1@50	21.89	23.79	0.2393
2	15	10	392000	1880	DFT-s-OFDM 256 QAM	25@12	19.89	21.79	0.1510
2	15	10	392000	1880	DFT-s-OFDM 256 QAM	1@1	19.36	21.26	0.1337
2	15	10	392000	1880	DFT-s-OFDM 256 QAM	1@50	19.52	21.42	0.1387
2	15	10	392000	1880	CP-OFDM QPSK	26@13	22.88	24.78	0.3006
2	15	10	392000	1880	CP-OFDM QPSK	1@1	22.73	24.63	0.2904
2	15	10	392000	1880	CP-OFDM QPSK	1@50	22.74	24.64	0.2911
2	15	10	397000	1905	DFT-s-OFDM PI/2 BPSK	25@12	24.62	26.52	0.4487
2	15	10	397000	1905	DFT-s-OFDM PI/2 BPSK	1@1	24.63	26.53	0.4498

2	15	10	397000	1905	DFT-s-OFDM PI/2 BPSK	1@50	24.51	26.41	0.4375
2	15	10	397000	1905	DFT-s-OFDM QPSK	25@12	24.66	26.56	0.4529
2	15	10	397000	1905	DFT-s-OFDM QPSK	1@1	24.66	26.56	0.4529
2	15	10	397000	1905	DFT-s-OFDM QPSK	1@50	24.5	26.4	0.4365
2	15	10	397000	1905	DFT-s-OFDM 16 QAM	25@12	23.73	25.63	0.3656
2	15	10	397000	1905	DFT-s-OFDM 16 QAM	1@1	23.49	25.39	0.3459
2	15	10	397000	1905	DFT-s-OFDM 16 QAM	1@50	23.45	25.35	0.3428
2	15	10	397000	1905	DFT-s-OFDM 64 QAM	25@12	22.06	23.96	0.2489
2	15	10	397000	1905	DFT-s-OFDM 64 QAM	1@1	22.31	24.21	0.2636
2	15	10	397000	1905	DFT-s-OFDM 64 QAM	1@50	22.35	24.25	0.2661
2	15	10	397000	1905	DFT-s-OFDM 256 QAM	25@12	19.87	21.77	0.1503
2	15	10	397000	1905	DFT-s-OFDM 256 QAM	1@1	19.56	21.46	0.1400
2	15	10	397000	1905	DFT-s-OFDM 256 QAM	1@50	19.59	21.49	0.1409
2	15	10	397000	1905	CP-OFDM QPSK	26@13	23.07	24.97	0.3141
2	15	10	397000	1905	CP-OFDM QPSK	1@1	23.05	24.95	0.3126
2	15	10	397000	1905	CP-OFDM QPSK	1@50	23	24.9	0.3090
2	15	15	387500	1905	DFT-s-OFDM PI/2 BPSK	36@18	24.51	26.41	0.4375
2	15	15	387500	1905	DFT-s-OFDM PI/2 BPSK	1@1	24.67	26.57	0.4539
2	15	15	387500	1905	DFT-s-OFDM PI/2 BPSK	1@77	24.67	26.57	0.4539
2	15	15	387500	1857.5	DFT-s-OFDM QPSK	36@18	24.51	26.41	0.4375
2	15	15	387500	1857.5	DFT-s-OFDM QPSK	1@1	24.52	26.42	0.4385
2	15	15	387500	1857.5	DFT-s-OFDM QPSK	1@77	24.56	26.46	0.4426
2	15	15	387500	1857.5	DFT-s-OFDM 16 QAM	36@18	23.56	25.46	0.3516
2	15	15	387500	1857.5	DFT-s-OFDM 16 QAM	1@1	23.53	25.43	0.3491

2	15	15	387500	1857.5	DFT-s-OFDM 16 QAM	1@77	23.48	25.38	0.3451
2	15	15	387500	1857.5	DFT-s-OFDM 64 QAM	36@18	22.09	23.99	0.2506
2	15	15	387500	1857.5	DFT-s-OFDM 64 QAM	1@1	22.54	24.44	0.2780
2	15	15	387500	1857.5	DFT-s-OFDM 64 QAM	1@77	22.51	24.41	0.2761
2	15	15	387500	1857.5	DFT-s-OFDM 256 QAM	36@18	20.02	21.92	0.1556
2	15	15	387500	1857.5	DFT-s-OFDM 256 QAM	1@1	19.52	21.42	0.1387
2	15	15	387500	1857.5	DFT-s-OFDM 256 QAM	1@77	19.53	21.43	0.1390
2	15	15	387500	1857.5	CP-OFDM QPSK	39@191	21.55	23.45	0.2213
2	15	15	387500	1857.5	CP-OFDM QPSK	1@1	23.19	25.09	0.3228
2	15	15	387500	1857.5	CP-OFDM QPSK	1@77	23.09	24.99	0.3155
2	15	15	392000	1880	DFT-s-OFDM PI/2 BPSK	36@18	24.63	26.53	0.4498
2	15	15	392000	1880	DFT-s-OFDM PI/2 BPSK	1@1	24.39	26.29	0.4256
2	15	15	392000	1880	DFT-s-OFDM PI/2 BPSK	1@77	24.63	26.53	0.4498
2	15	15	392000	1880	DFT-s-OFDM QPSK	36@18	24.64	26.54	0.4508
2	15	15	392000	1880	DFT-s-OFDM QPSK	1@1	24.59	26.49	0.4457
2	15	15	392000	1880	DFT-s-OFDM QPSK	1@77	24.56	26.46	0.4426
2	15	15	392000	1880	DFT-s-OFDM 16 QAM	36@18	23.62	25.52	0.3565
2	15	15	392000	1880	DFT-s-OFDM 16 QAM	1@1	23.5	25.4	0.3467
2	15	15	392000	1880	DFT-s-OFDM 16 QAM	1@77	23.5	25.4	0.3467
2	15	15	392000	1880	DFT-s-OFDM 64 QAM	36@18	22.22	24.12	0.2582
2	15	15	392000	1880	DFT-s-OFDM 64 QAM	1@1	22.21	24.11	0.2576
2	15	15	392000	1880	DFT-s-OFDM 64 QAM	1@77	22.34	24.24	0.2655
2	15	15	392000	1880	DFT-s-OFDM 256 QAM	36@18	19.65	21.55	0.1429
2	15	15	392000	1880	DFT-s-OFDM 256 QAM	1@1	19.45	21.35	0.1365

2	15	15	392000	1880	DFT-s-OFDM 256 QAM	1@77	19.6	21.5	0.1413
2	15	15	392000	1880	CP-OFDM QPSK	39@191	21.6	23.5	0.2239
2	15	15	392000	1880	CP-OFDM QPSK	1@1	23.07	24.97	0.3141
2	15	15	392000	1880	CP-OFDM QPSK	1@77	22.95	24.85	0.3055
2	15	15	396500	1902.5	DFT-s-OFDM PI/2 BPSK	36@18	24.71	26.61	0.4581
2	15	15	396500	1902.5	DFT-s-OFDM PI/2 BPSK	1@1	24.64	26.54	0.4508
2	15	15	396500	1902.5	DFT-s-OFDM PI/2 BPSK	1@77	24.6	26.5	0.4467
2	15	15	396500	1902.5	DFT-s-OFDM QPSK	36@18	24.41	26.31	0.4276
2	15	15	396500	1902.5	DFT-s-OFDM QPSK	1@1	24.73	26.63	0.4603
2	15	15	396500	1902.5	DFT-s-OFDM QPSK	1@77	24.69	26.59	0.4560
2	15	15	396500	1902.5	DFT-s-OFDM 16 QAM	36@18	23.72	25.62	0.3648
2	15	15	396500	1902.5	DFT-s-OFDM 16 QAM	1@1	23.6	25.5	0.3548
2	15	15	396500	1902.5	DFT-s-OFDM 16 QAM	1@77	23.59	25.49	0.3540
2	15	15	396500	1902.5	DFT-s-OFDM 64 QAM	36@18	22.26	24.16	0.2606
2	15	15	396500	1902.5	DFT-s-OFDM 64 QAM	1@1	22.37	24.27	0.2673
2	15	15	396500	1902.5	DFT-s-OFDM 64 QAM	1@77	22.4	24.3	0.2692
2	15	15	396500	1902.5	DFT-s-OFDM 256 QAM	36@18	20.2	22.1	0.1622
2	15	15	396500	1902.5	DFT-s-OFDM 256 QAM	1@1	19.64	21.54	0.1426
2	15	15	396500	1902.5	DFT-s-OFDM 256 QAM	1@77	19.71	21.61	0.1449
2	15	15	396500	1902.5	CP-OFDM QPSK	39@191	21.7	23.6	0.2291
2	15	15	396500	1902.5	CP-OFDM QPSK	1@1	23.1	25	0.3162
2	15	15	396500	1902.5	CP-OFDM QPSK	1@77	22.95	24.85	0.3055
2	15	20	388000	1860	DFT-s-OFDM PI/2 BPSK	50@25	24.68	26.58	0.4550
2	15	20	388000	1860	DFT-s-OFDM PI/2 BPSK	1@1	24.56	26.46	0.4426
2	15	20	388000	1860	DFT-s-OFDM PI/2 BPSK	1@104	24.47	26.37	0.4335

2	15	20	388000	1860	DFT-s-OFDM QPSK	50@25	24.64	26.54	0.4508
2	15	20	388000	1860	DFT-s-OFDM QPSK	1@1	24.65	26.55	0.4519
2	15	20	388000	1860	DFT-s-OFDM QPSK	1@104	24.52	26.42	0.4385
2	15	20	388000	1860	DFT-s-OFDM 16 QAM	50@25	23.66	25.56	0.3597
2	15	20	388000	1860	DFT-s-OFDM 16 QAM	1@1	23.46	25.36	0.3436
2	15	20	388000	1860	DFT-s-OFDM 16 QAM	1@104	23.27	25.17	0.3289
2	15	20	388000	1860	DFT-s-OFDM 64 QAM	50@25	22.16	24.06	0.2547
2	15	20	388000	1860	DFT-s-OFDM 64 QAM	1@1	22.36	24.26	0.2667
2	15	20	388000	1860	DFT-s-OFDM 64 QAM	1@104	22.23	24.13	0.2588
2	15	20	388000	1860	DFT-s-OFDM 256 QAM	50@25	20.03	21.93	0.1560
2	15	20	388000	1860	DFT-s-OFDM 256 QAM	1@1	19.56	21.46	0.1400
2	15	20	388000	1860	DFT-s-OFDM 256 QAM	1@104	19.44	21.34	0.1361
2	15	20	388000	1860	CP-OFDM QPSK	53@26	23.01	24.91	0.3097
2	15	20	388000	1860	CP-OFDM QPSK	1@1	23.18	25.08	0.3221
2	15	20	388000	1860	CP-OFDM QPSK	1@104	23.02	24.92	0.3105
2	15	20	392000	1880	DFT-s-OFDM PI/2 BPSK	50@25	24.72	26.62	0.4592
2	15	20	392000	1880	DFT-s-OFDM PI/2 BPSK	1@1	24.49	26.39	0.4355
2	15	20	392000	1880	DFT-s-OFDM PI/2 BPSK	1@104	24.52	26.42	0.4385
2	15	20	392000	1880	DFT-s-OFDM QPSK	50@25	24.57	26.47	0.4436
2	15	20	392000	1880	DFT-s-OFDM QPSK	1@1	24.55	26.45	0.4416
2	15	20	392000	1880	DFT-s-OFDM QPSK	1@104	24.58	26.48	0.4446
2	15	20	392000	1880	DFT-s-OFDM 16 QAM	50@25	23.72	25.62	0.3648
2	15	20	392000	1880	DFT-s-OFDM 16 QAM	1@1	23.62	25.52	0.3565
2	15	20	392000	1880	DFT-s-OFDM 16 QAM	1@104	23.49	25.39	0.3459

2	15	20	392000	1880	DFT-s-OFDM 64 QAM	50@25	22.24	24.14	0.2594
2	15	20	392000	1880	DFT-s-OFDM 64 QAM	1@1	22.19	24.09	0.2564
2	15	20	392000	1880	DFT-s-OFDM 64 QAM	1@104	22.31	24.21	0.2636
2	15	20	392000	1880	DFT-s-OFDM 256 QAM	50@25	19.21	21.11	0.1291
2	15	20	392000	1880	DFT-s-OFDM 256 QAM	1@1	19.48	21.38	0.1374
2	15	20	392000	1880	DFT-s-OFDM 256 QAM	1@104	19.54	21.44	0.1393
2	15	20	392000	1880	CP-OFDM QPSK	53@26	23.15	25.05	0.3199
2	15	20	392000	1880	CP-OFDM QPSK	1@1	23.32	25.22	0.3327
2	15	20	392000	1880	CP-OFDM QPSK	1@104	23.07	24.97	0.3141
2	15	20	396000	1900	DFT-s-OFDM PI/2 BPSK	50@25	24.95	26.85	0.4842
2	15	20	396000	1900	DFT-s-OFDM PI/2 BPSK	1@1	24.62	26.52	0.4487
2	15	20	396000	1900	DFT-s-OFDM PI/2 BPSK	1@104	24.56	26.46	0.4426
2	15	20	396000	1900	DFT-s-OFDM QPSK	50@25	24.75	26.65	0.4624
2	15	20	396000	1900	DFT-s-OFDM QPSK	1@1	24.67	26.57	0.4539
2	15	20	396000	1900	DFT-s-OFDM QPSK	1@104	24.56	26.46	0.4426
2	15	20	396000	1900	DFT-s-OFDM 16 QAM	50@25	23.78	25.68	0.3698
2	15	20	396000	1900	DFT-s-OFDM 16 QAM	1@1	23.51	25.41	0.3475
2	15	20	396000	1900	DFT-s-OFDM 16 QAM	1@104	23.51	25.41	0.3475
2	15	20	396000	1900	DFT-s-OFDM 64 QAM	50@25	22.38	24.28	0.2679
2	15	20	396000	1900	DFT-s-OFDM 64 QAM	1@1	22.32	24.22	0.2642
2	15	20	396000	1900	DFT-s-OFDM 64 QAM	1@104	22.37	24.27	0.2673
2	15	20	396000	1900	DFT-s-OFDM 256 QAM	50@25	20.25	22.15	0.1641
2	15	20	396000	1900	DFT-s-OFDM 256 QAM	1@1	19.49	21.39	0.1377
2	15	20	396000	1900	DFT-s-OFDM 256 QAM	1@104	19.57	21.47	0.1403

2	15	20	396000	1900	CP-OFDM QPSK	53@26	23.3	25.2	0.3311
2	15	20	396000	1900	CP-OFDM QPSK	1@1	23.19	25.09	0.3228
2	15	20	396000	1900	CP-OFDM QPSK	1@104	23.13	25.03	0.3184

Frequency Stability

NR Band	SCS (kHz)	Bandwidth (MHz)	Arfcn	Freq (MHz)	Modulation	RB	Deviation (ppm)	Verdict	Environment
2	15	20	392000	1880.0	DFT-s-OFDM QPSK	100@0	-0.00755	PASS	NV
2	15	20	392000	1880.0	DFT-s-OFDM QPSK	100@0	-0.0061	PASS	LV
2	15	20	392000	1880.0	DFT-s-OFDM QPSK	100@0	-0.0066	PASS	HV
2	15	20	392000	1880.0	DFT-s-OFDM QPSK	100@0	-0.00505	PASS	-30°C
2	15	20	392000	1880.0	DFT-s-OFDM QPSK	100@0	-0.00604	PASS	-20°C
2	15	20	392000	1880.0	DFT-s-OFDM QPSK	100@0	-0.00728	PASS	-10°C
2	15	20	392000	1880.0	DFT-s-OFDM QPSK	100@0	-0.00667	PASS	0°C
2	15	20	392000	1880.0	DFT-s-OFDM QPSK	100@0	-0.00534	PASS	10°C
2	15	20	392000	1880.0	DFT-s-OFDM QPSK	100@0	-0.00768	PASS	20°C
2	15	20	392000	1880.0	DFT-s-OFDM QPSK	100@0	-0.00903	PASS	30°C
2	15	20	392000	1880.0	DFT-s-OFDM QPSK	100@0	-0.00674	PASS	40°C
2	15	20	392000	1880.0	DFT-s-OFDM QPSK	100@0	-0.00654	PASS	50°C

Peak to Average Ratio

NR Band	SCS (kHz)	Bandwidth (MHz)	Arfcn	Freq (MHz)	Modulation	RB	Result (dB)	Limit (dB)	Verdict
2	15	20	388000	1860.0	DFT-s-OFDM PI/2 BPSK	100@0	3.9	13	PASS
2	15	20	388000	1860.0	DFT-s-OFDM PI/2 BPSK	1@0	4.01	13	PASS
2	15	20	388000	1860.0	DFT-s-OFDM QPSK	100@0	4.52	13	PASS
2	15	20	388000	1860.0	DFT-s-OFDM QPSK	1@0	3.67	13	PASS
2	15	20	392000	1880.0	DFT-s-OFDM PI/2 BPSK	100@0	3.84	13	PASS
2	15	20	392000	1880.0	DFT-s-OFDM PI/2 BPSK	1@0	3.96	13	PASS
2	15	20	392000	1880.0	DFT-s-OFDM QPSK	100@0	4.53	13	PASS
2	15	20	392000	1880.0	DFT-s-OFDM QPSK	1@0	3.59	13	PASS
2	15	20	396000	1900.0	DFT-s-OFDM PI/2 BPSK	100@0	3.82	13	PASS
2	15	20	396000	1900.0	DFT-s-OFDM PI/2 BPSK	1@0	3.87	13	PASS
2	15	20	396000	1900.0	DFT-s-OFDM QPSK	100@0	4.59	13	PASS
2	15	20	396000	1900.0	DFT-s-OFDM QPSK	1@0	3.65	13	PASS

B5_N2(20M)_DFT-s-OFDM_PI_2-BPSK_Outer_Full_Low_CH

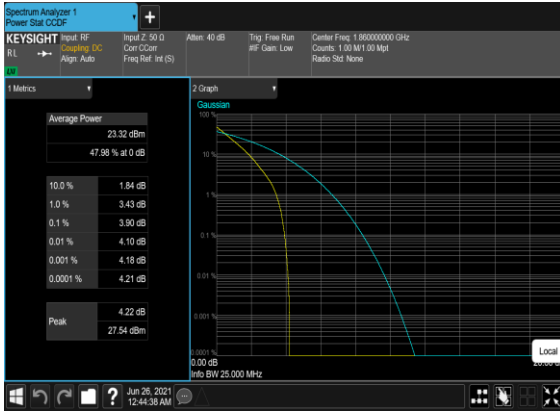

B5_N2(20M)_DFT-s-OFDM_PI_2-BPSK_Edge_1RB_Left_Low_CH



B5_N2(20M)_DFT-s-OFDM_QPSK_Outer_Full_Low_CH



B5_N2(20M)_DFT-s-OFDM_QPSK_Edge_1RB_Left_Low_CH

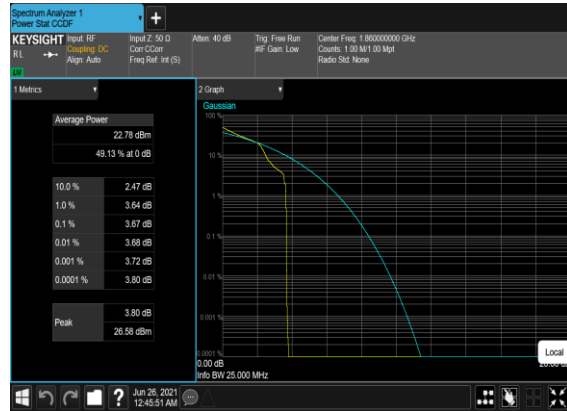

B5_N2(20M)_DFT-s-OFDM_PI_2-BPSK_Outer_Full_Mid_CH



B5_N2(20M)_DFT-s-OFDM_PI_2-BPSK_Edge_1RB_Left_Mid_CH



B5_N2(20M)_DFT-s-OFDM_QPSK_Outer_Full_Mid_CH



B5_N2(20M)_DFT-s-OFDM_QPSK_Edge_1RB_Left_Mid_CH

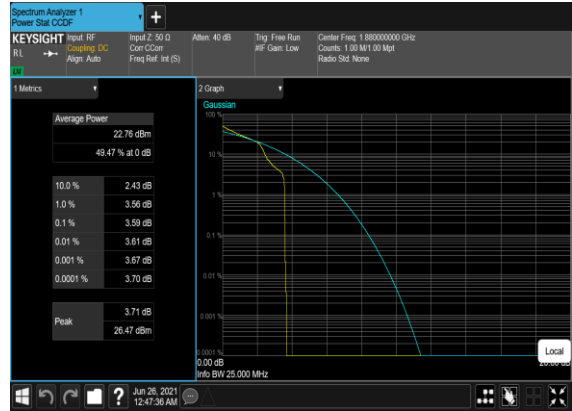

B5_N2(20M)_DFT-s-OFDM_PI_2-BPSK_Outer_Full_High_CH



B5_N2(20M)_DFT-s-OFDM_PI_2-BPSK_Edge_1RB_Left_High_CH



B5_N2(20M)_DFT-s-OFDM_QPSK_Outer_Full_High_CH



B5_N2(20M)_DFT-s-OFDM_QPSK_Edge_1RB_Left_High_CH



Occupied Bandwidth

NR Band	SCS (kHz)	Bandwidth (MHz)	Arfcn	Freq (MHz)	Modulation	RB	OBW (MHz)	26dB OBW (MHz)
2	15	5	392000	1880.0	DFT-s-OFDM PI/2 BPSK	25@0	4.4701	4.863
2	15	5	392000	1880.0	DFT-s-OFDM QPSK	25@0	4.4669	4.878
2	15	5	392000	1880.0	CP-OFDM QPSK	25@0	4.4723	4.943
2	15	5	392000	1880.0	CP-OFDM 16 QAM	25@0	4.473	4.918
2	15	5	392000	1880.0	CP-OFDM 64 QAM	25@0	4.4758	4.982
2	15	5	392000	1880.0	CP-OFDM 256 QAM	25@0	4.4669	4.895
2	15	10	392000	1880.0	DFT-s-OFDM PI/2 BPSK	50@0	8.893	9.458
2	15	10	392000	1880.0	DFT-s-OFDM QPSK	50@0	8.9079	9.538
2	15	10	392000	1880.0	CP-OFDM QPSK	52@0	9.2617	9.864
2	15	10	392000	1880.0	CP-OFDM 16 QAM	52@0	9.2643	9.858
2	15	10	392000	1880.0	CP-OFDM 64 QAM	52@0	9.2572	9.868
2	15	10	392000	1880.0	CP-OFDM 256 QAM	52@0	9.2765	9.899
2	15	15	392000	1880.0	DFT-s-OFDM PI/2 BPSK	75@0	13.376	14.1
2	15	15	392000	1880.0	DFT-s-OFDM QPSK	75@0	13.397	14.11
2	15	15	392000	1880.0	CP-OFDM QPSK	79@0	14.097	14.87
2	15	15	392000	1880.0	CP-OFDM 16 QAM	79@0	14.104	14.89
2	15	15	392000	1880.0	CP-OFDM 64 QAM	79@0	14.112	14.77
2	15	15	392000	1880.0	CP-OFDM 256 QAM	79@0	14.067	14.8
2	15	20	392000	1880.0	DFT-s-OFDM PI/2 BPSK	100@0	17.829	18.68
2	15	20	392000	1880.0	DFT-s-OFDM QPSK	100@0	17.851	18.68
2	15	20	392000	1880.0	CP-OFDM QPSK	106@0	18.885	19.88
2	15	20	392000	1880.0	CP-OFDM 16 QAM	106@0	18.916	19.83
2	15	20	392000	1880.0	CP-OFDM 64 QAM	106@0	18.897	19.81
2	15	20	392000	1880.0	CP-OFDM 256 QAM	106@0	18.967	19.76

B5_N2(5M)_DFT-s-OFDM_PI_2-
BPSK_Outer_Full_Mid_CH

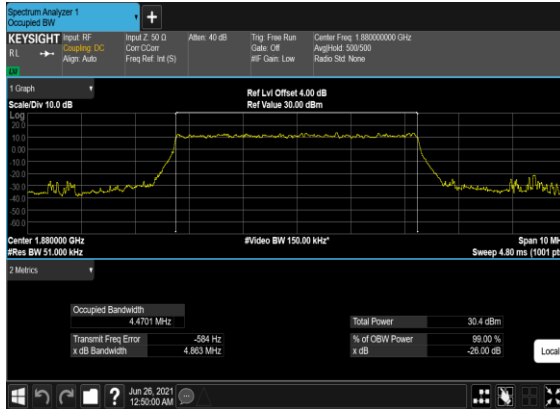

B5_N2(5M)_DFT-s-
OFDM_QPSK_Outer_Full_Mid_CH

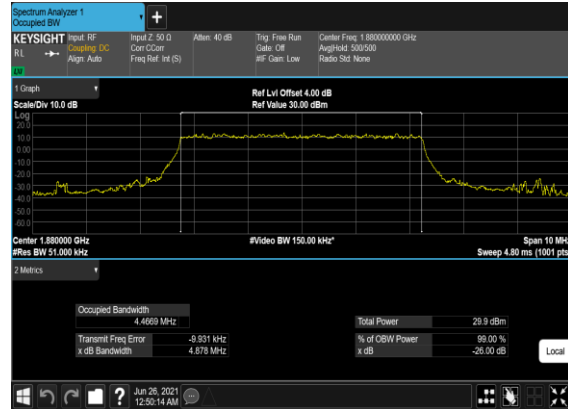

B5_N2(5M)_CP-
OFDM_QPSK_Outer_Full_Mid_CH

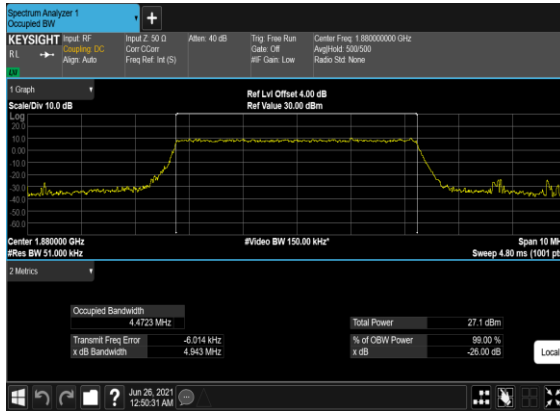

B5_N2(5M)_CP-OFDM_16
QAM_Outer_Full_Mid_CH

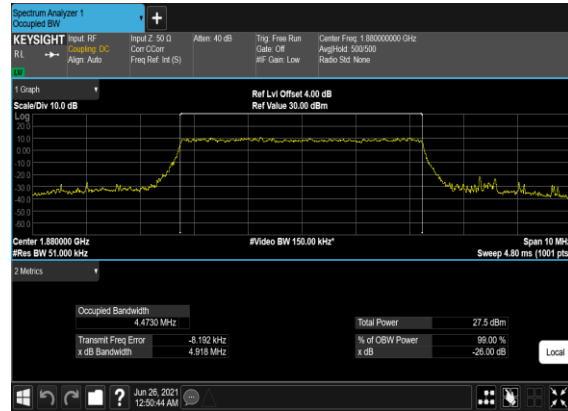

B5_N2(5M)_CP-OFDM_64
QAM_Outer_Full_Mid_CH

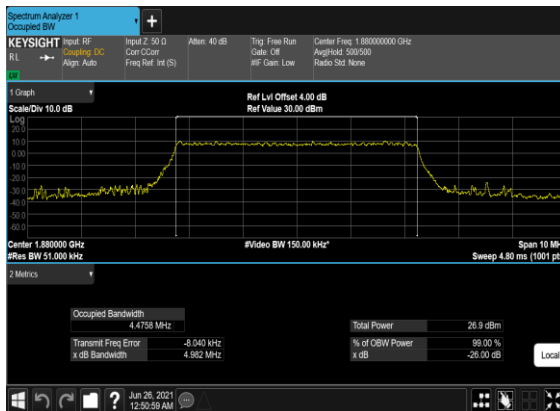

B5_N2(5M)_CP-OFDM_256
QAM_Outer_Full_Mid_CH

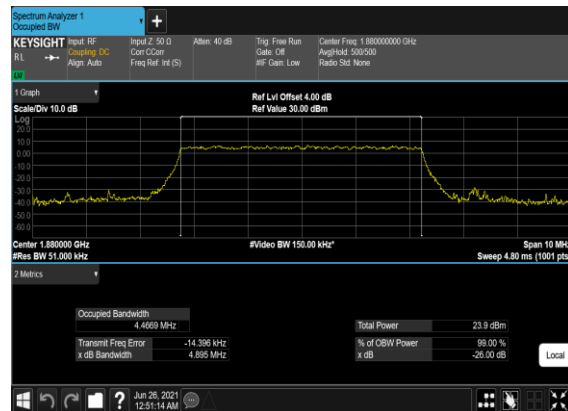

B5_N2(10M)_DFT-s-OFDM_PI_2- BPSK_Outer_Full_Mid_CH

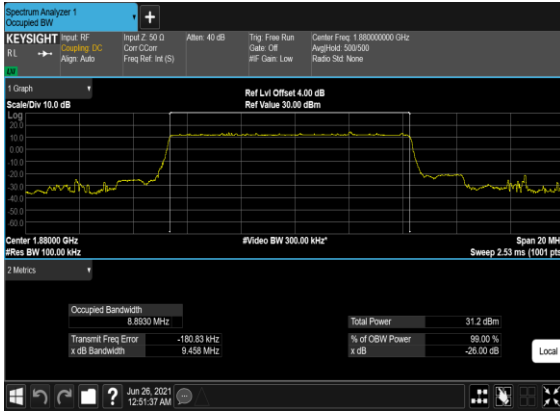

B5_N2(10M)_DFT-s- OFDM_QPSK_Outer_Full_Mid_CH



B5_N2(10M)_CP- OFDM_QPSK_Outer_Full_Mid_CH

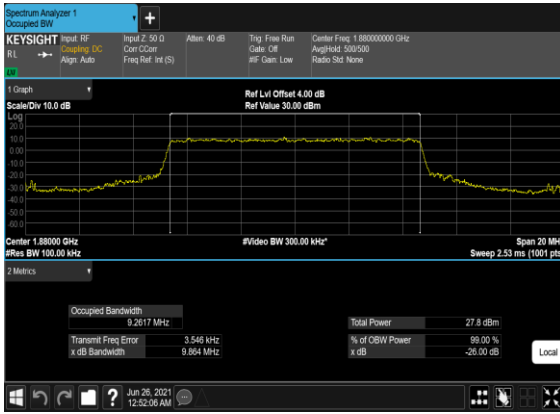

B5_N2(10M)_CP-OFDM_16 QAM_Outer_Full_Mid_CH



B5_N2(10M)_CP-OFDM_64 QAM_Outer_Full_Mid_CH



B5_N2(10M)_CP-OFDM_256 QAM_Outer_Full_Mid_CH

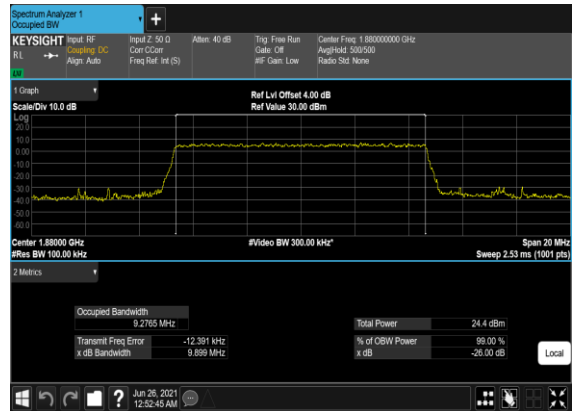

B5_N2(15M)_DFT-s-OFDM_PI_2- BPSK_Outer_Full_Mid_CH



B5_N2(15M)_DFT-s- OFDM_QPSK_Outer_Full_Mid_CH



B5_N2(15M)_CP- OFDM_QPSK_Outer_Full_Mid_CH

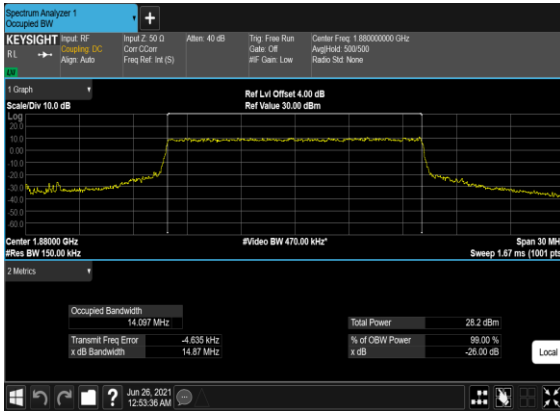

B5_N2(15M)_CP-OFDM_16 QAM_Outer_Full_Mid_CH



B5_N2(15M)_CP-OFDM_64 QAM_Outer_Full_Mid_CH

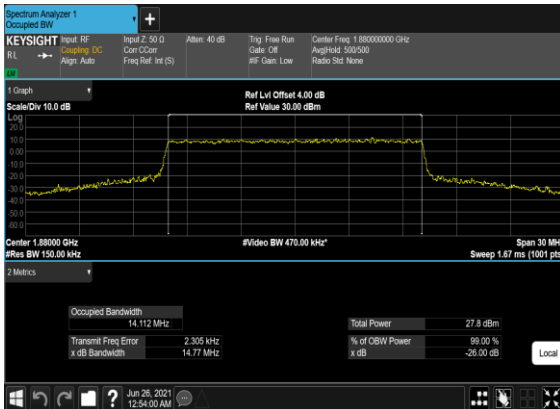

B5_N2(15M)_CP-OFDM_256 QAM_Outer_Full_Mid_CH

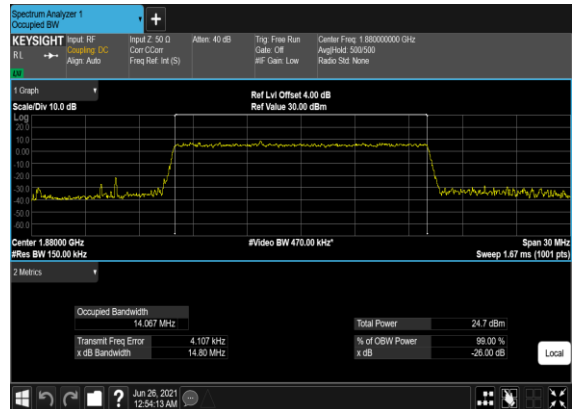

B5_N2(20M)_DFT-s-OFDM_PI_2- BPSK_Outer_Full_Mid_CH

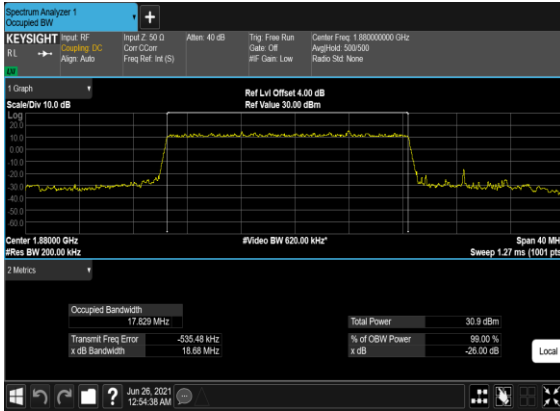

B5_N2(20M)_DFT-s- OFDM_QPSK_Outer_Full_Mid_CH



B5_N2(20M)_CP- OFDM_QPSK_Outer_Full_Mid_CH



B5_N2(20M)_CP-OFDM_16 QAM_Outer_Full_Mid_CH

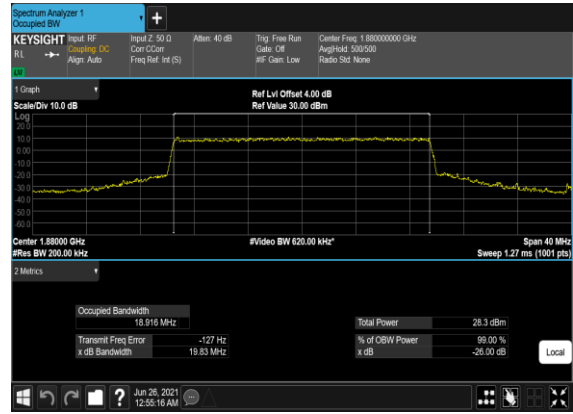

B5_N2(20M)_CP-OFDM_64 QAM_Outer_Full_Mid_CH

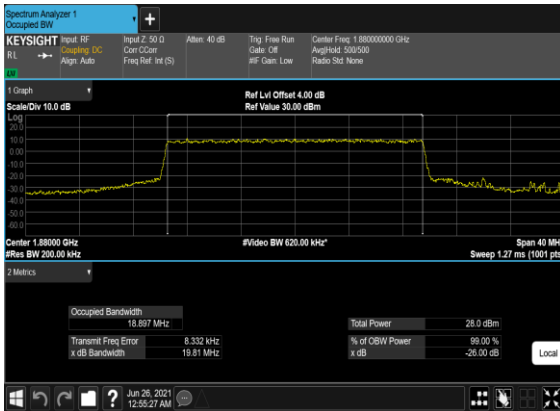

B5_N2(20M)_CP-OFDM_256 QAM_Outer_Full_Mid_CH

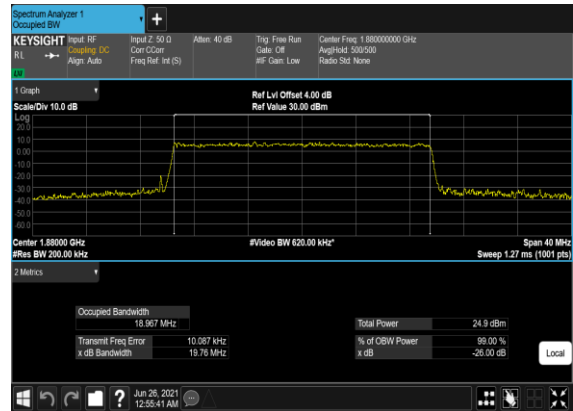

Conducted Spurious Emissions

NR Band	SCS (kHz)	Bandwidth (MHz)	Arfcn	Freq (MHz)	Modulation	RB	Result	Verdict
2	15	5	386500	1852.5	DFT-s-OFDM BPSK	1@0	see graph	---
2	15	5	386500	1852.5	DFT-s-OFDM BPSK	1@0	see graph	PASS
2	15	5	386500	1852.5	DFT-s-OFDM QPSK	1@0	see graph	---
2	15	5	386500	1852.5	DFT-s-OFDM QPSK	1@0	see graph	PASS
2	15	5	392000	1880.0	DFT-s-OFDM BPSK	1@0	see graph	---
2	15	5	392000	1880.0	DFT-s-OFDM BPSK	1@0	see graph	PASS
2	15	5	392000	1880.0	DFT-s-OFDM QPSK	1@0	see graph	---
2	15	5	392000	1880.0	DFT-s-OFDM QPSK	1@0	see graph	PASS
2	15	5	397500	1907.5	DFT-s-OFDM BPSK	1@0	see graph	---
2	15	5	397500	1907.5	DFT-s-OFDM BPSK	1@0	see graph	PASS
2	15	5	397500	1907.5	DFT-s-OFDM QPSK	1@0	see graph	---
2	15	5	397500	1907.5	DFT-s-OFDM QPSK	1@0	see graph	PASS
2	15	10	387000	1855.0	DFT-s-OFDM BPSK	1@0	see graph	---
2	15	10	387000	1855.0	DFT-s-OFDM BPSK	1@0	see graph	PASS
2	15	10	387000	1855.0	DFT-s-OFDM QPSK	1@0	see graph	---
2	15	10	387000	1855.0	DFT-s-OFDM QPSK	1@0	see graph	PASS
2	15	10	392000	1880.0	DFT-s-OFDM BPSK	1@0	see graph	---
2	15	10	392000	1880.0	DFT-s-OFDM BPSK	1@0	see graph	PASS
2	15	10	392000	1880.0	DFT-s-OFDM QPSK	1@0	see graph	---
2	15	10	392000	1880.0	DFT-s-OFDM QPSK	1@0	see graph	PASS
2	15	10	397000	1905.0	DFT-s-OFDM BPSK	1@0	see graph	---
2	15	10	397000	1905.0	DFT-s-OFDM BPSK	1@0	see graph	PASS

2	15	10	397000	1905.0	DFT-s-OFDM QPSK	1@0	see graph	---
2	15	10	397000	1905.0	DFT-s-OFDM QPSK	1@0	see graph	PASS
2	15	20	388000	1860.0	DFT-s-OFDM BPSK	1@0	see graph	---
2	15	20	388000	1860.0	DFT-s-OFDM BPSK	1@0	see graph	PASS
2	15	20	388000	1860.0	DFT-s-OFDM QPSK	1@0	see graph	---
2	15	20	388000	1860.0	DFT-s-OFDM QPSK	1@0	see graph	PASS
2	15	20	392000	1880.0	DFT-s-OFDM BPSK	1@0	see graph	---
2	15	20	392000	1880.0	DFT-s-OFDM BPSK	1@0	see graph	PASS
2	15	20	392000	1880.0	DFT-s-OFDM QPSK	1@0	see graph	---
2	15	20	392000	1880.0	DFT-s-OFDM QPSK	1@0	see graph	PASS
2	15	20	396000	1900.0	DFT-s-OFDM BPSK	1@0	see graph	---
2	15	20	396000	1900.0	DFT-s-OFDM BPSK	1@0	see graph	PASS
2	15	20	396000	1900.0	DFT-s-OFDM QPSK	1@0	see graph	---
2	15	20	396000	1900.0	DFT-s-OFDM QPSK	1@0	see graph	PASS

B5_N2(5M)_DFT-s-OFDM_BPSK_Edge_1RB_Left_Low_CH

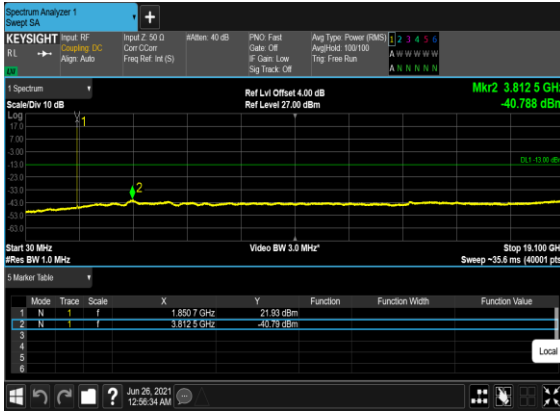

B5_N2(5M)_DFT-s-OFDM_QPSK_Edge_1RB_Left_Low_CH

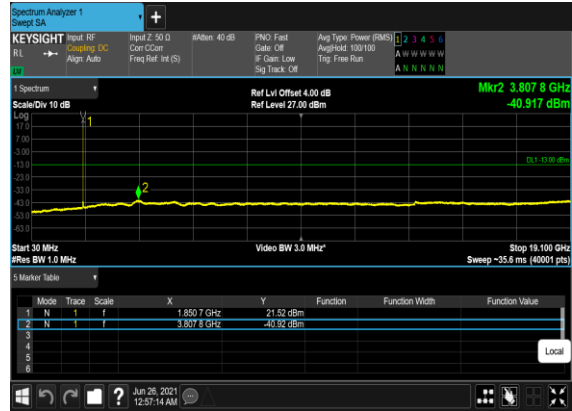

B5_N2(5M)_DFT-s-OFDM_BPSK_Edge_1RB_Left_Mid_CH

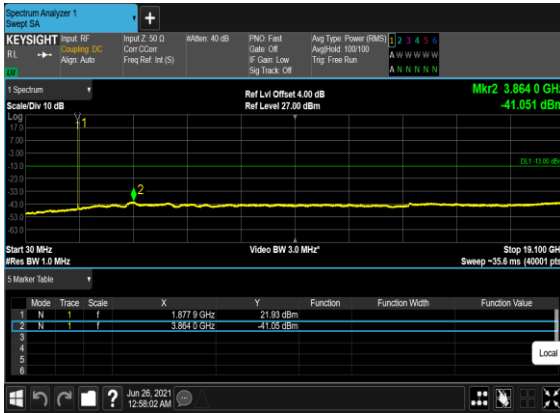

B5_N2(5M)_DFT-s-OFDM_QPSK_Edge_1RB_Left_Mid_CH

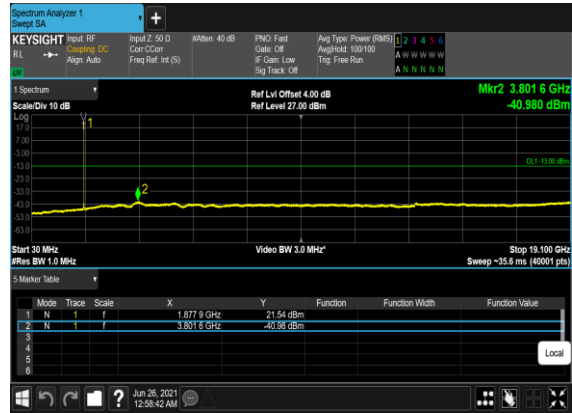

B5_N2(5M)_DFT-s-OFDM_BPSK_Edge_1RB_Left_High_CH



B5_N2(5M)_DFT-s-OFDM_QPSK_Edge_1RB_Left_High_CH

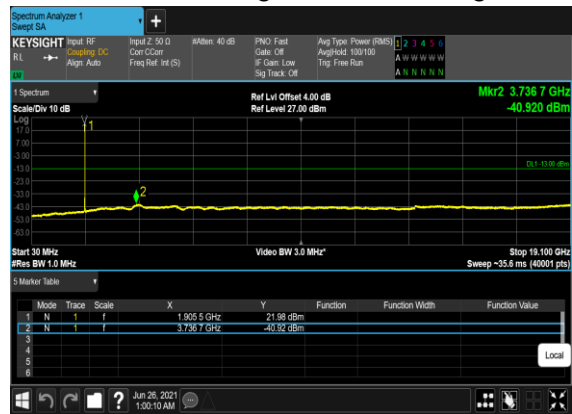

B5_N2(10M)_DFT-s-OFDM_BPSK_Edge_1RB_Left_Low_CH



B5_N2(10M)_DFT-s-OFDM_QPSK_Edge_1RB_Left_Low_CH

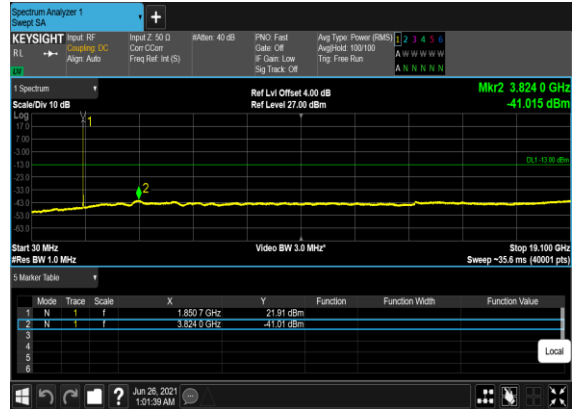

B5_N2(10M)_DFT-s-OFDM_BPSK_Edge_1RB_Left_Mid_CH

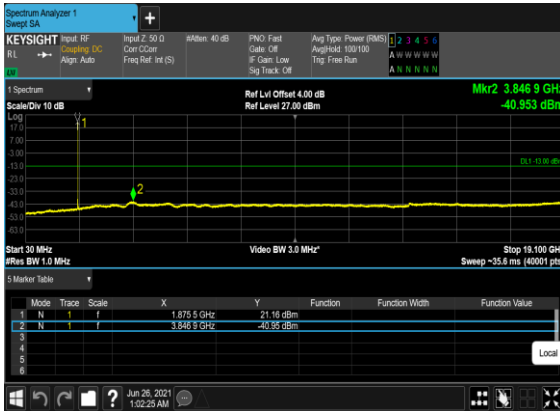

B5_N2(10M)_DFT-s-OFDM_QPSK_Edge_1RB_Left_Mid_CH

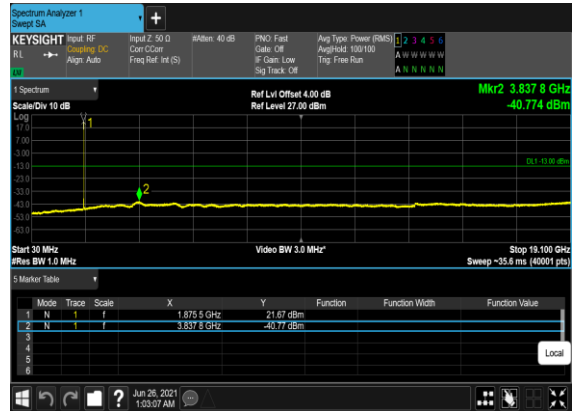

B5_N2(10M)_DFT-s-OFDM_BPSK_Edge_1RB_Left_High_CH

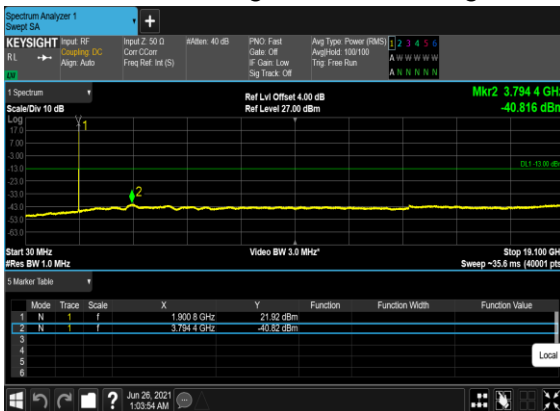

B5_N2(10M)_DFT-s-OFDM_QPSK_Edge_1RB_Left_High_CH

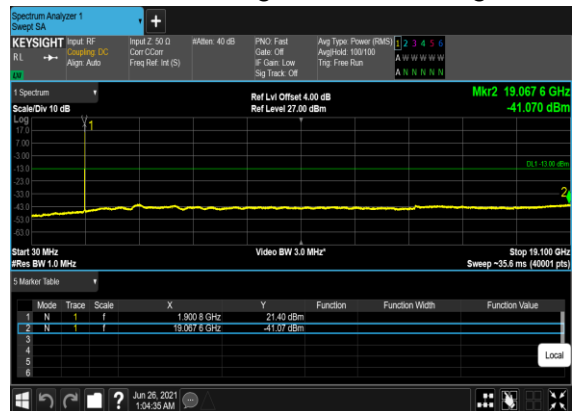

B5_N2(20M)_DFT-s-OFDM_BPSK_Edge_1RB_Left_Low_CH

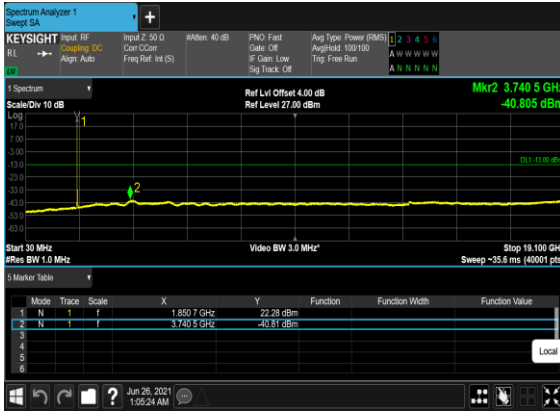

B5_N2(20M)_DFT-s-OFDM_QPSK_Edge_1RB_Left_Low_CH

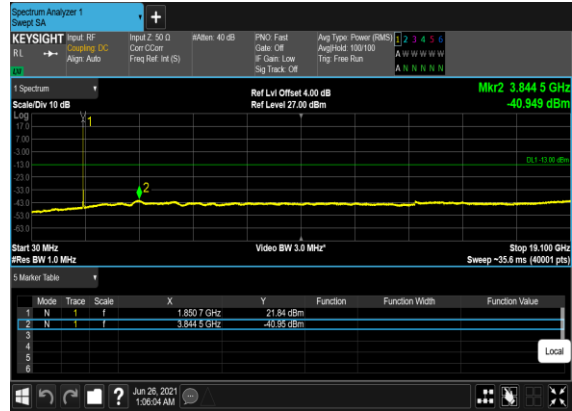

B5_N2(20M)_DFT-s-OFDM_BPSK_Edge_1RB_Left_Mid_CH

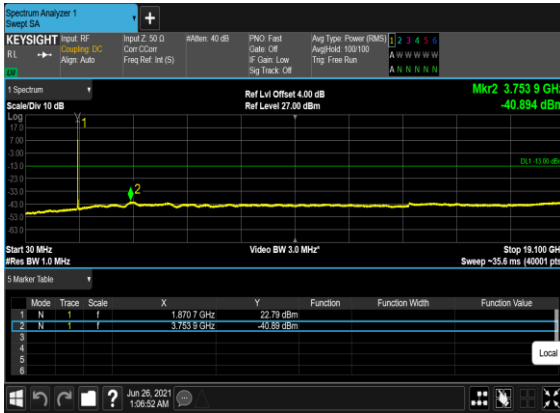

B5_N2(20M)_DFT-s-OFDM_QPSK_Edge_1RB_Left_Mid_CH

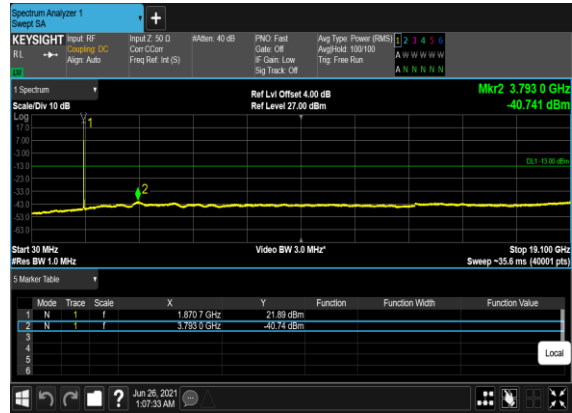

B5_N2(20M)_DFT-s-OFDM_BPSK_Edge_1RB_Left_High_CH



B5_N2(20M)_DFT-s-OFDM_QPSK_Edge_1RB_Left_High_CH

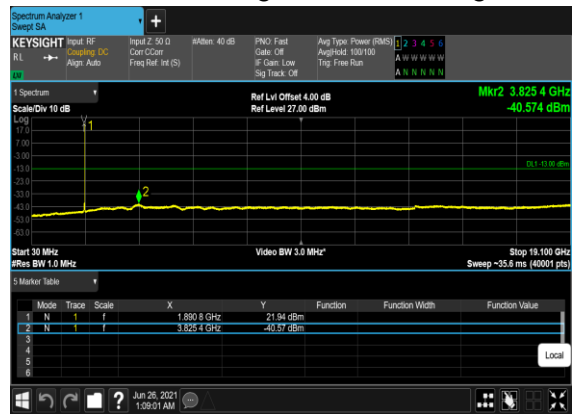

Conducted Band Edge

NR Band	SCS (kHz)	Bandwidth (MHz)	Arfcn	Freq (MHz)	Modulation	RB	Result	Verdict
2	15	5	386500	1852.5	DFT-s-OFDM BPSK	1@0	see graph	PASS
2	15	5	386500	1852.5	DFT-s-OFDM QPSK	1@0	see graph	PASS
2	15	5	386500	1852.5	DFT-s-OFDM BPSK	25@0	see graph	PASS
2	15	5	386500	1852.5	DFT-s-OFDM QPSK	25@0	see graph	PASS
2	15	5	397500	1907.5	DFT-s-OFDM BPSK	1@24	see graph	PASS
2	15	5	397500	1907.5	DFT-s-OFDM QPSK	1@24	see graph	PASS
2	15	5	397500	1907.5	DFT-s-OFDM BPSK	25@0	see graph	PASS
2	15	5	397500	1907.5	DFT-s-OFDM QPSK	25@0	see graph	PASS
2	15	10	387000	1855.0	DFT-s-OFDM BPSK	1@0	see graph	PASS
2	15	10	387000	1855.0	DFT-s-OFDM QPSK	1@0	see graph	PASS
2	15	10	387000	1855.0	DFT-s-OFDM BPSK	50@0	see graph	PASS
2	15	10	387000	1855.0	DFT-s-OFDM QPSK	50@0	see graph	PASS
2	15	10	397000	1905.0	DFT-s-OFDM BPSK	1@51	see graph	PASS
2	15	10	397000	1905.0	DFT-s-OFDM QPSK	1@51	see graph	PASS
2	15	10	397000	1905.0	DFT-s-OFDM BPSK	50@0	see graph	PASS
2	15	10	397000	1905.0	DFT-s-OFDM QPSK	50@0	see graph	PASS
2	15	20	388000	1860.0	DFT-s-OFDM BPSK	1@0	see graph	PASS
2	15	20	388000	1860.0	DFT-s-OFDM QPSK	1@0	see graph	PASS
2	15	20	388000	1860.0	DFT-s-OFDM BPSK	100@0	see graph	PASS
2	15	20	388000	1860.0	DFT-s-OFDM QPSK	100@0	see graph	PASS
2	15	20	396000	1900.0	DFT-s-OFDM BPSK	1@105	see graph	PASS
2	15	20	396000	1900.0	DFT-s-OFDM QPSK	1@105	see graph	PASS

2	15	20	396000	1900.0	DFT-s-OFDM BPSK	100@0	see graph	PASS
2	15	20	396000	1900.0	DFT-s-OFDM QPSK	100@0	see graph	PASS

B5_N2(5M)_DFT-s-OFDM_BPSK_Edge_1RB_Left_Low_CH

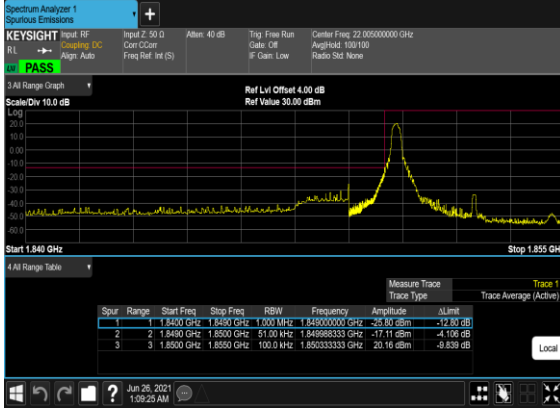

B5_N2(5M)_DFT-s-OFDM_QPSK_Edge_1RB_Left_Low_CH



B5_N2(5M)_DFT-s-OFDM_BPSK_Outer_Full_Low_CH

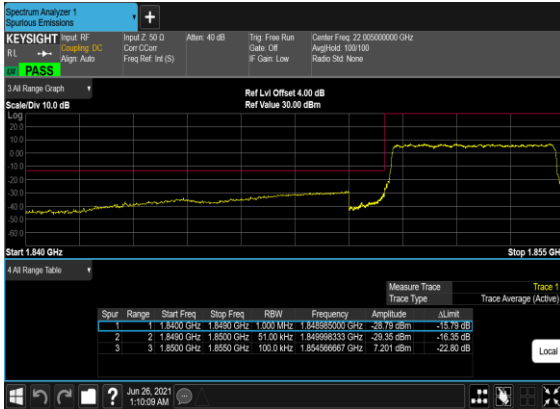

B5_N2(5M)_DFT-s-OFDM_QPSK_Outer_Full_Low_CH

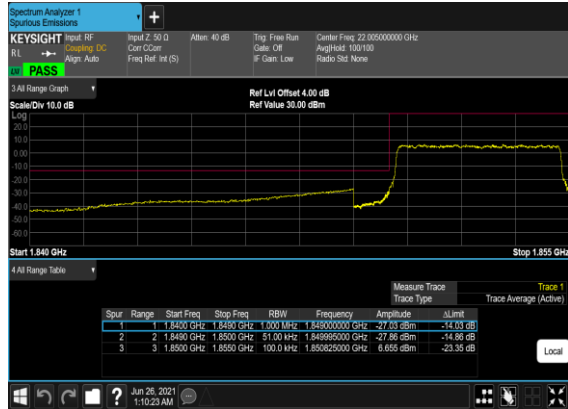

B5_N2(5M)_DFT-s-OFDM_BPSK_Edge_1RB_Right_High_CH

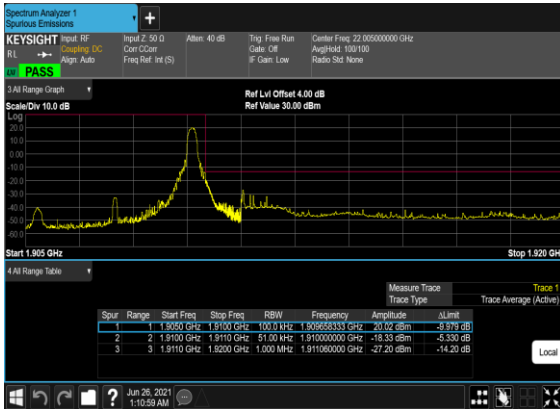

B5_N2(5M)_DFT-s-OFDM_QPSK_Edge_1RB_Right_High_CH

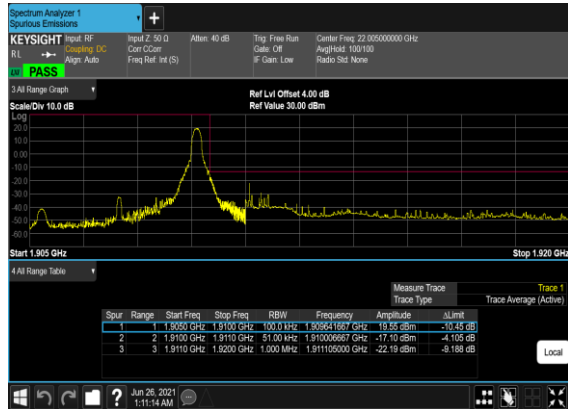

B5_N2(5M)_DFT-s-OFDM_BPSK_Outer_Full_High_CH

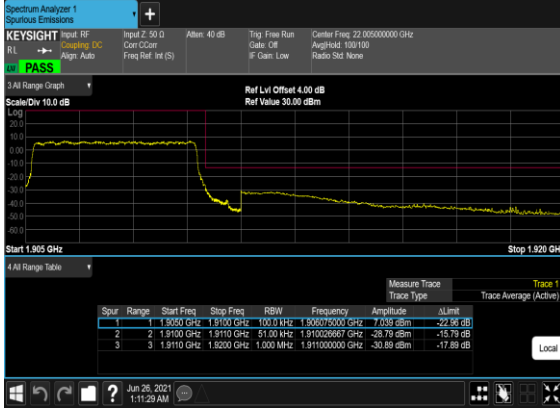

B5_N2(5M)_DFT-s-OFDM_QPSK_Outer_Full_High_CH

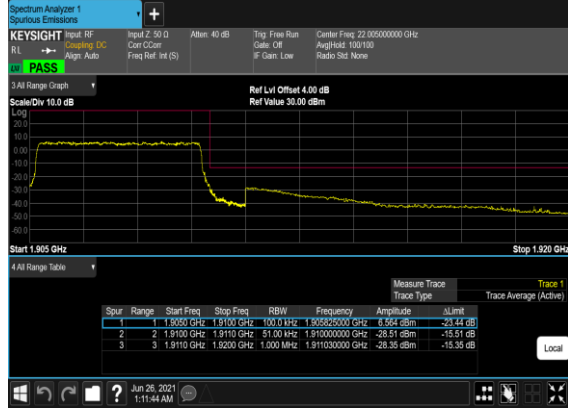

B5_N2(10M)_DFT-s-OFDM_BPSK_Edge_1RB_Left_Low_CH

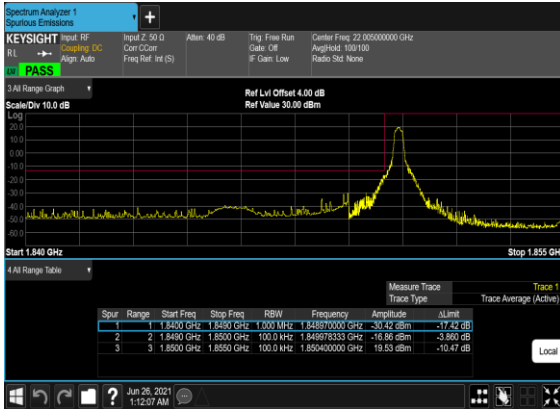

B5_N2(10M)_DFT-s-OFDM_QPSK_Edge_1RB_Left_Low_CH

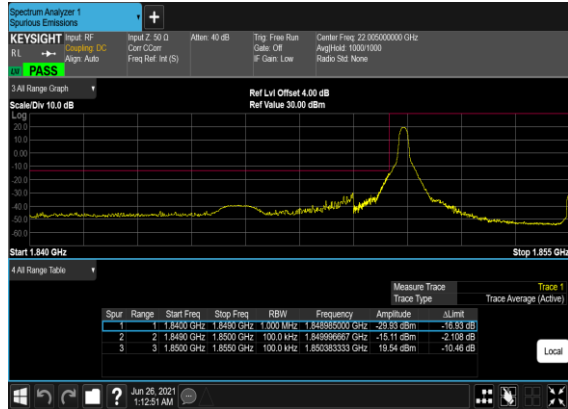

B5_N2(10M)_DFT-s-OFDM_QPSK_Edge_1RB_Left_Low_CH_CHP_PASS

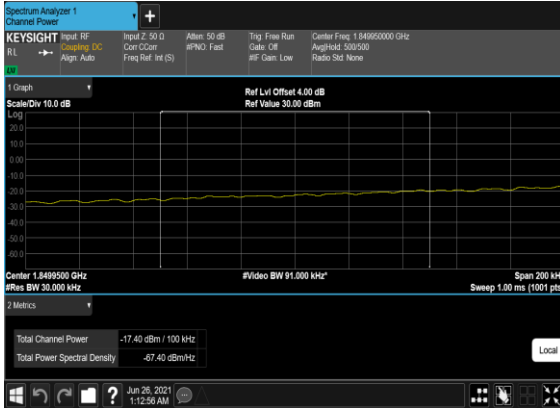

B5_N2(10M)_DFT-s-OFDM_BPSK_Outer_Full_Low_CH

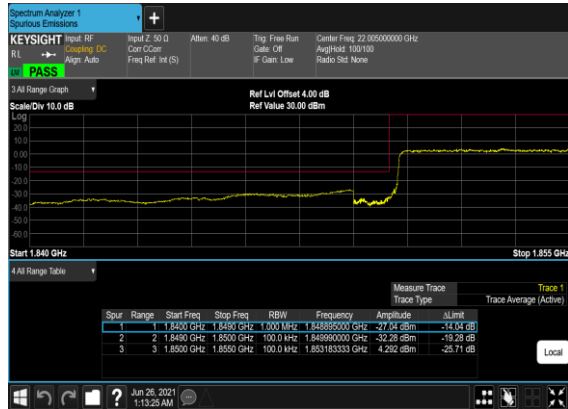

B5_N2(10M)_DFT-s-OFDM_QPSK_Outer_Full_Low_CH

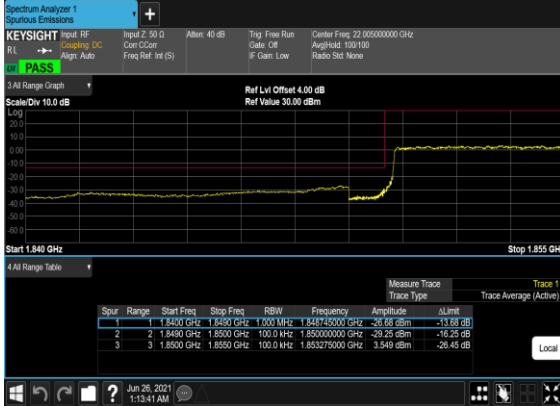

B5_N2(10M)_DFT-s-OFDM_BPSK_Edge_1RB_Right_High_CH

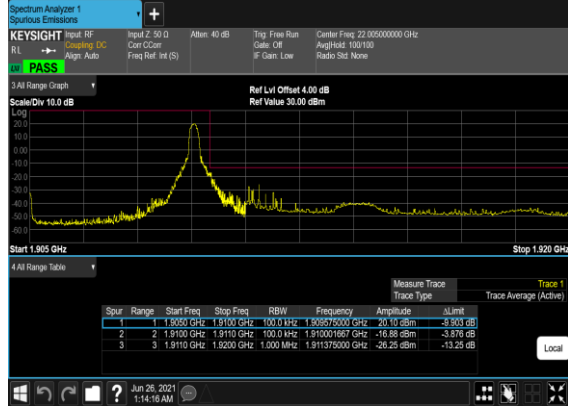

B5_N2(10M)_DFT-s-OFDM_QPSK_Edge_1RB_Right_High_CH

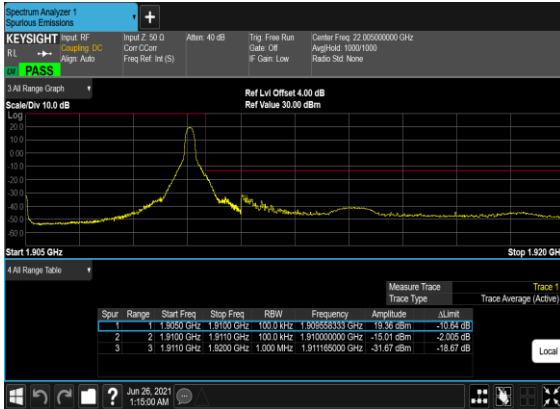

B5_N2(10M)_DFT-s-OFDM_QPSK_Edge_1RB_Right_High_CH_CHP_PASS

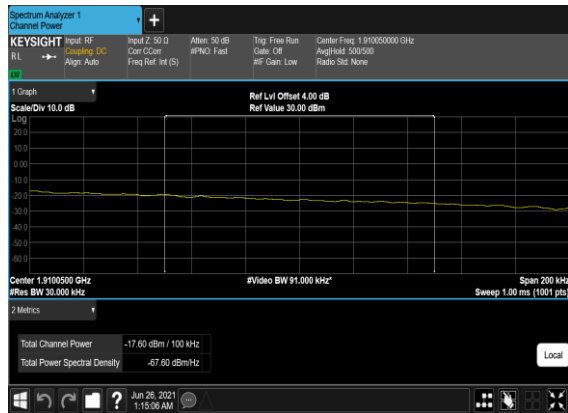

B5_N2(10M)_DFT-s-OFDM_BPSK_Outer_Full_High_CH



B5_N2(10M)_DFT-s-OFDM_QPSK_Outer_Full_High_CH



B5_N2(20M)_DFT-s-OFDM_BPSK_Edge_1RB_Left_Low_CH

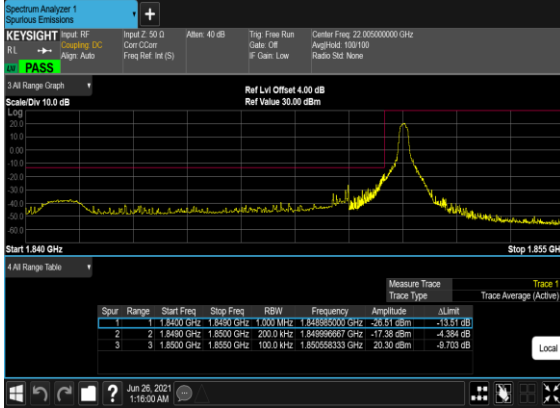

B5_N2(20M)_DFT-s-OFDM_QPSK_Edge_1RB_Left_Low_CH

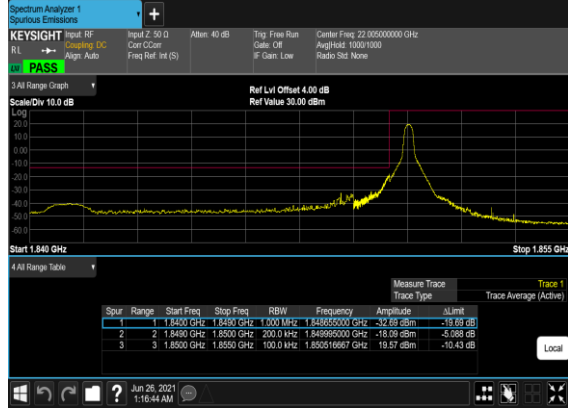

B5_N2(20M)_DFT-s-OFDM_BPSK_Outer_Full_Low_CH



B5_N2(20M)_DFT-s-OFDM_QPSK_Outer_Full_Low_CH

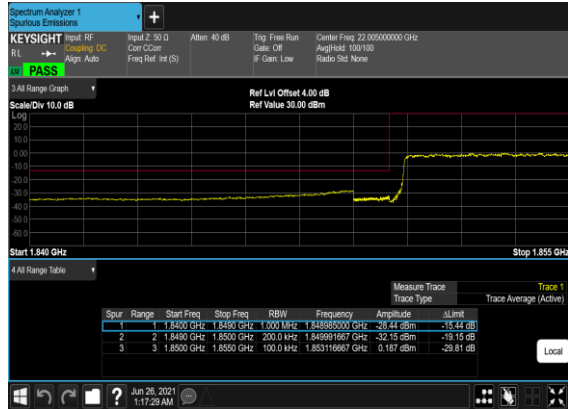

B5_N2(20M)_DFT-s-OFDM_BPSK_Edge_1RB_Right_High_CH

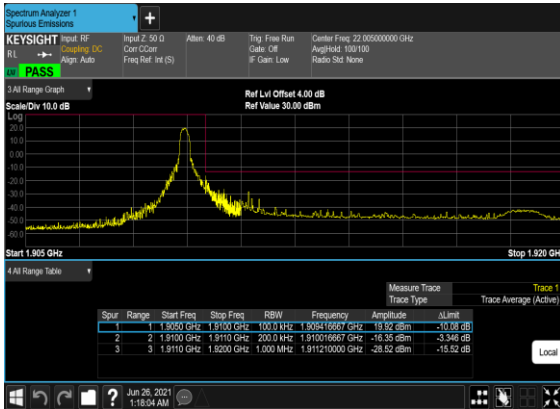

B5_N2(20M)_DFT-s-OFDM_QPSK_Edge_1RB_Right_High_CH

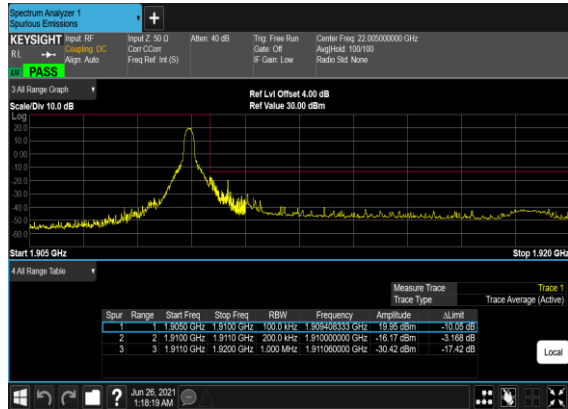

B5_N2(20M)_DFT-s-OFDM_BPSK_Outer_Full_High_CH

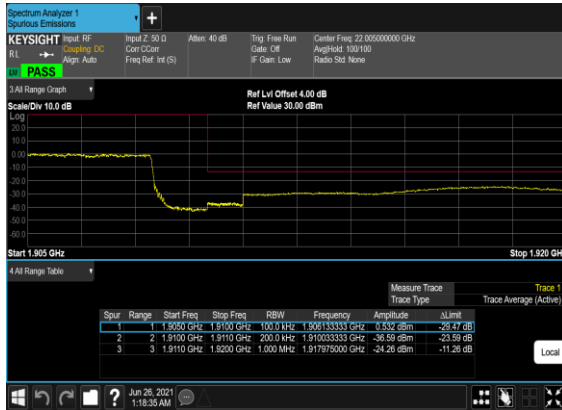

B5_N2(20M)_DFT-s-OFDM_QPSK_Outer_Full_High_CH



FR1 N2

LTE Band: 5, LTE BW: 10M, LTE ARFCN: Mid

<Ant. 6>

Transmitter Conducted Output Power And EIRP, (GT - LC)=0.3dB

NR Band	SCS (kHz)	Bandwidth (MHz)	Arfcn	Freq (MHz)	Modulation	RB	Conducted Power(dBm)	EIRP (dBm)	EIRP (W)
2	15	5	386500	1852.5	DFT-s-OFDM PI/2 BPSK	12@6	24.63	24.93	0.3112
2	15	5	386500	1852.5	DFT-s-OFDM PI/2 BPSK	1@1	24.44	24.74	0.2979
2	15	5	386500	1852.5	DFT-s-OFDM PI/2 BPSK	1@23	24.42	24.72	0.2965
2	15	5	386500	1852.5	DFT-s-OFDM QPSK	12@6	24.52	24.82	0.3034
2	15	5	386500	1852.5	DFT-s-OFDM QPSK	1@1	24.44	24.74	0.2979
2	15	5	386500	1852.5	DFT-s-OFDM QPSK	1@23	24.54	24.84	0.3048
2	15	5	386500	1852.5	DFT-s-OFDM 16 QAM	12@6	23.57	23.87	0.2438
2	15	5	386500	1852.5	DFT-s-OFDM 16 QAM	1@1	23.58	23.88	0.2443
2	15	5	386500	1852.5	DFT-s-OFDM 16 QAM	1@23	23.59	23.89	0.2449
2	15	5	386500	1852.5	DFT-s-OFDM 64 QAM	12@6	22.12	22.42	0.1746
2	15	5	386500	1852.5	DFT-s-OFDM 64 QAM	1@1	21.97	22.27	0.1687
2	15	5	386500	1852.5	DFT-s-OFDM 64 QAM	1@23	21.94	22.24	0.1675
2	15	5	386500	1852.5	DFT-s-OFDM 256 QAM	12@6	20.01	20.31	0.1074
2	15	5	386500	1852.5	DFT-s-OFDM 256 QAM	1@1	19.67	19.97	0.0993
2	15	5	386500	1852.5	DFT-s-OFDM 256 QAM	1@23	19.73	20.03	0.1007
2	15	5	386500	1852.5	CP-OFDM QPSK	13@6	22.99	23.29	0.2133
2	15	5	386500	1852.5	CP-OFDM QPSK	1@1	22.8	23.1	0.2042
2	15	5	386500	1852.5	CP-OFDM QPSK	1@23	22.98	23.28	0.2128
2	15	5	392000	1880	DFT-s-OFDM PI/2	12@6	24.59	24.89	0.3083

					BPSK					
2	15	5	392000	1880	DFT-s-OFDM PI/2 BPSK	1@1	24.42	24.72	0.2965	
2	15	5	392000	1880	DFT-s-OFDM PI/2 BPSK	1@23	24.47	24.77	0.2999	
2	15	5	392000	1880	DFT-s-OFDM QPSK	12@6	24.59	24.89	0.3083	
2	15	5	392000	1880	DFT-s-OFDM QPSK	1@1	24.48	24.78	0.3006	
2	15	5	392000	1880	DFT-s-OFDM QPSK	1@23	24.43	24.73	0.2972	
2	15	5	392000	1880	DFT-s-OFDM 16 QAM	12@6	23.68	23.98	0.2500	
2	15	5	392000	1880	DFT-s-OFDM 16 QAM	1@1	23.46	23.76	0.2377	
2	15	5	392000	1880	DFT-s-OFDM 16 QAM	1@23	23.61	23.91	0.2460	
2	15	5	392000	1880	DFT-s-OFDM 64 QAM	12@6	22.24	22.54	0.1795	
2	15	5	392000	1880	DFT-s-OFDM 64 QAM	1@1	21.88	22.18	0.1652	
2	15	5	392000	1880	DFT-s-OFDM 64 QAM	1@23	21.94	22.24	0.1675	
2	15	5	392000	1880	DFT-s-OFDM 256 QAM	12@6	20.09	20.39	0.1094	
2	15	5	392000	1880	DFT-s-OFDM 256 QAM	1@1	19.58	19.88	0.0973	
2	15	5	392000	1880	DFT-s-OFDM 256 QAM	1@23	19.63	19.93	0.0984	
2	15	5	392000	1880	CP-OFDM QPSK	13@6	22.99	23.29	0.2133	
2	15	5	392000	1880	CP-OFDM QPSK	1@1	23.09	23.39	0.2183	
2	15	5	392000	1880	CP-OFDM QPSK	1@23	23.24	23.54	0.2259	
2	15	5	397500	1907.5	DFT-s-OFDM PI/2 BPSK	12@6	24.58	24.88	0.3076	
2	15	5	397500	1907.5	DFT-s-OFDM PI/2 BPSK	1@1	24.48	24.78	0.3006	
2	15	5	397500	1907.5	DFT-s-OFDM PI/2 BPSK	1@23	24.35	24.65	0.2917	
2	15	5	397500	1907.5	DFT-s-OFDM QPSK	12@6	24.35	24.65	0.2917	
2	15	5	397500	1907.5	DFT-s-OFDM QPSK	1@1	24.38	24.68	0.2938	
2	15	5	397500	1907.5	DFT-s-OFDM QPSK	1@23	24.24	24.54	0.2844	
2	15	5	397500	1907.5	DFT-s-	12@6	23.43	23.73	0.2360	

					OFDM 16 QAM					
2	15	5	397500	1907.5	DFT-s- OFDM 16 QAM	1@1	23.56	23.86	0.2432	
2	15	5	397500	1907.5	DFT-s- OFDM 16 QAM	1@23	23.45	23.75	0.2371	
2	15	5	397500	1907.5	DFT-s- OFDM 64 QAM	12@6	22.03	22.33	0.1710	
2	15	5	397500	1907.5	DFT-s- OFDM 64 QAM	1@1	21.85	22.15	0.1641	
2	15	5	397500	1907.5	DFT-s- OFDM 64 QAM	1@23	21.88	22.18	0.1652	
2	15	5	397500	1907.5	DFT-s- OFDM 256 QAM	12@6	19.97	20.27	0.1064	
2	15	5	397500	1907.5	DFT-s- OFDM 256 QAM	1@1	19.59	19.89	0.0975	
2	15	5	397500	1907.5	DFT-s- OFDM 256 QAM	1@23	19.63	19.93	0.0984	
2	15	5	397500	1907.5	CP-OFDM QPSK	13@6	22.87	23.17	0.2075	
2	15	5	397500	1907.5	CP-OFDM QPSK	1@1	22.78	23.08	0.2032	
2	15	5	397500	1907.5	CP-OFDM QPSK	1@23	22.92	23.22	0.2099	
2	15	10	387000	1855	DFT-s- OFDM PI/2 BPSK	25@12	24.8	25.1	0.3236	
2	15	10	387000	1855	DFT-s- OFDM PI/2 BPSK	1@1	24.33	24.63	0.2904	
2	15	10	387000	1855	DFT-s- OFDM PI/2 BPSK	1@50	24.67	24.97	0.3141	
2	15	10	387000	1855	DFT-s- OFDM QPSK	25@12	24.61	24.91	0.3097	
2	15	10	387000	1855	DFT-s- OFDM QPSK	1@1	24.28	24.58	0.2871	
2	15	10	387000	1855	DFT-s- OFDM QPSK	1@50	24.56	24.86	0.3062	
2	15	10	387000	1855	DFT-s- OFDM 16 QAM	25@12	23.63	23.93	0.2472	
2	15	10	387000	1855	DFT-s- OFDM 16 QAM	1@1	23.51	23.81	0.2404	
2	15	10	387000	1855	DFT-s- OFDM 16 QAM	1@50	23.59	23.89	0.2449	
2	15	10	387000	1855	DFT-s- OFDM 64 QAM	25@12	22.08	22.38	0.1730	
2	15	10	387000	1855	DFT-s- OFDM 64 QAM	1@1	21.96	22.26	0.1683	
2	15	10	387000	1855	DFT-s- OFDM 64 QAM	1@50	21.98	22.28	0.1690	

2	15	10	387000	1855	DFT-s-OFDM 256 QAM	25@12	20.06	20.36	0.1086
2	15	10	387000	1855	DFT-s-OFDM 256 QAM	1@1	19.77	20.07	0.1016
2	15	10	387000	1855	DFT-s-OFDM 256 QAM	1@50	19.75	20.05	0.1012
2	15	10	387000	1855	CP-OFDM QPSK	26@13	23.15	23.45	0.2213
2	15	10	387000	1855	CP-OFDM QPSK	1@1	22.75	23.05	0.2018
2	15	10	387000	1855	CP-OFDM QPSK	1@50	23.28	23.58	0.2280
2	15	10	392000	1880	DFT-s-OFDM PI/2 BPSK	25@12	24.53	24.83	0.3041
2	15	10	392000	1880	DFT-s-OFDM PI/2 BPSK	1@1	24.16	24.46	0.2793
2	15	10	392000	1880	DFT-s-OFDM PI/2 BPSK	1@50	24.44	24.74	0.2979
2	15	10	392000	1880	DFT-s-OFDM QPSK	25@12	24.62	24.92	0.3105
2	15	10	392000	1880	DFT-s-OFDM QPSK	1@1	24.09	24.39	0.2748
2	15	10	392000	1880	DFT-s-OFDM QPSK	1@50	24.39	24.69	0.2944
2	15	10	392000	1880	DFT-s-OFDM 16 QAM	25@12	23.47	23.77	0.2382
2	15	10	392000	1880	DFT-s-OFDM 16 QAM	1@1	23.32	23.62	0.2301
2	15	10	392000	1880	DFT-s-OFDM 16 QAM	1@50	23.46	23.76	0.2377
2	15	10	392000	1880	DFT-s-OFDM 64 QAM	25@12	21.97	22.27	0.1687
2	15	10	392000	1880	DFT-s-OFDM 64 QAM	1@1	21.89	22.19	0.1656
2	15	10	392000	1880	DFT-s-OFDM 64 QAM	1@50	21.99	22.29	0.1694
2	15	10	392000	1880	DFT-s-OFDM 256 QAM	25@12	20.04	20.34	0.1081
2	15	10	392000	1880	DFT-s-OFDM 256 QAM	1@1	19.67	19.97	0.0993
2	15	10	392000	1880	DFT-s-OFDM 256 QAM	1@50	19.61	19.91	0.0979
2	15	10	392000	1880	CP-OFDM QPSK	26@13	23.04	23.34	0.2158
2	15	10	392000	1880	CP-OFDM QPSK	1@1	22.63	22.93	0.1963
2	15	10	392000	1880	CP-OFDM QPSK	1@50	23.21	23.51	0.2244
2	15	10	397000	1905	DFT-s-OFDM PI/2 BPSK	25@12	24.5	24.8	0.3020

2	15	10	397000	1905	DFT-s-OFDM PI/2 BPSK	1@1	24.15	24.45	0.2786
2	15	10	397000	1905	DFT-s-OFDM PI/2 BPSK	1@50	23.99	24.29	0.2685
2	15	10	397000	1905	DFT-s-OFDM QPSK	25@12	24.28	24.58	0.2871
2	15	10	397000	1905	DFT-s-OFDM QPSK	1@1	24.05	24.35	0.2723
2	15	10	397000	1905	DFT-s-OFDM QPSK	1@50	23.86	24.16	0.2606
2	15	10	397000	1905	DFT-s-OFDM 16 QAM	25@12	23.48	23.78	0.2388
2	15	10	397000	1905	DFT-s-OFDM 16 QAM	1@1	23.37	23.67	0.2328
2	15	10	397000	1905	DFT-s-OFDM 16 QAM	1@50	23.23	23.53	0.2254
2	15	10	397000	1905	DFT-s-OFDM 64 QAM	25@12	22.01	22.31	0.1702
2	15	10	397000	1905	DFT-s-OFDM 64 QAM	1@1	21.85	22.15	0.1641
2	15	10	397000	1905	DFT-s-OFDM 64 QAM	1@50	21.95	22.25	0.1679
2	15	10	397000	1905	DFT-s-OFDM 256 QAM	25@12	19.98	20.28	0.1067
2	15	10	397000	1905	DFT-s-OFDM 256 QAM	1@1	19.58	19.88	0.0973
2	15	10	397000	1905	DFT-s-OFDM 256 QAM	1@50	19.67	19.97	0.0993
2	15	10	397000	1905	CP-OFDM QPSK	26@13	22.95	23.25	0.2113
2	15	10	397000	1905	CP-OFDM QPSK	1@1	22.57	22.87	0.1936
2	15	10	397000	1905	CP-OFDM QPSK	1@50	22.59	22.89	0.1945
2	15	15	387500	1857.5	DFT-s-OFDM PI/2 BPSK	36@18	24.86	25.16	0.3281
2	15	15	387500	1857.5	DFT-s-OFDM PI/2 BPSK	1@1	24.52	24.82	0.3034
2	15	15	387500	1857.5	DFT-s-OFDM PI/2 BPSK	1@77	24.79	25.09	0.3228
2	15	15	387500	1857.5	DFT-s-OFDM QPSK	36@18	24.74	25.04	0.3192
2	15	15	387500	1857.5	DFT-s-OFDM QPSK	1@1	24.46	24.76	0.2992
2	15	15	387500	1857.5	DFT-s-OFDM QPSK	1@77	24.64	24.94	0.3119
2	15	15	387500	1857.5	DFT-s-OFDM 16 QAM	36@18	23.59	23.89	0.2449

2	15	15	387500	1857.5	DFT-s-OFDM 16 QAM	1@1	23.65	23.95	0.2483
2	15	15	387500	1857.5	DFT-s-OFDM 16 QAM	1@77	23.82	24.12	0.2582
2	15	15	387500	1857.5	DFT-s-OFDM 64 QAM	36@18	22.25	22.55	0.1799
2	15	15	387500	1857.5	DFT-s-OFDM 64 QAM	1@1	22.1	22.4	0.1738
2	15	15	387500	1857.5	DFT-s-OFDM 64 QAM	1@77	22.22	22.52	0.1786
2	15	15	387500	1857.5	DFT-s-OFDM 256 QAM	36@18	20.11	20.41	0.1099
2	15	15	387500	1857.5	DFT-s-OFDM 256 QAM	1@1	19.73	20.03	0.1007
2	15	15	387500	1857.5	DFT-s-OFDM 256 QAM	1@77	19.94	20.24	0.1057
2	15	15	387500	1857.5	CP-OFDM QPSK	39@191	21.66	21.96	0.1570
2	15	15	387500	1857.5	CP-OFDM QPSK	1@1	23.11	23.41	0.2193
2	15	15	387500	1857.5	CP-OFDM QPSK	1@77	23.38	23.68	0.2333
2	15	15	392000	1880	DFT-s-OFDM PI/2 BPSK	36@18	24.76	25.06	0.3206
2	15	15	392000	1880	DFT-s-OFDM PI/2 BPSK	1@1	24.47	24.77	0.2999
2	15	15	392000	1880	DFT-s-OFDM PI/2 BPSK	1@77	24.7	25	0.3162
2	15	15	392000	1880	DFT-s-OFDM QPSK	36@18	24.53	24.83	0.3041
2	15	15	392000	1880	DFT-s-OFDM QPSK	1@1	24.27	24.57	0.2864
2	15	15	392000	1880	DFT-s-OFDM QPSK	1@77	24.56	24.86	0.3062
2	15	15	392000	1880	DFT-s-OFDM 16 QAM	36@18	23.59	23.89	0.2449
2	15	15	392000	1880	DFT-s-OFDM 16 QAM	1@1	23.47	23.77	0.2382
2	15	15	392000	1880	DFT-s-OFDM 16 QAM	1@77	23.76	24.06	0.2547
2	15	15	392000	1880	DFT-s-OFDM 64 QAM	36@18	22.2	22.5	0.1778
2	15	15	392000	1880	DFT-s-OFDM 64 QAM	1@1	22.12	22.42	0.1746
2	15	15	392000	1880	DFT-s-OFDM 64 QAM	1@77	22.09	22.39	0.1734
2	15	15	392000	1880	DFT-s-OFDM 256 QAM	36@18	20.14	20.44	0.1107

2	15	15	392000	1880	DFT-s-OFDM 256 QAM	1@1	19.84	20.14	0.1033
2	15	15	392000	1880	DFT-s-OFDM 256 QAM	1@77	19.83	20.13	0.1030
2	15	15	392000	1880	CP-OFDM QPSK	39@191	21.79	22.09	0.1618
2	15	15	392000	1880	CP-OFDM QPSK	1@1	23	23.3	0.2138
2	15	15	392000	1880	CP-OFDM QPSK	1@77	23.31	23.61	0.2296
2	15	15	396500	1902.5	DFT-s-OFDM PI/2 BPSK	36@18	24.62	24.92	0.3105
2	15	15	396500	1902.5	DFT-s-OFDM PI/2 BPSK	1@1	24.63	24.93	0.3112
2	15	15	396500	1902.5	DFT-s-OFDM PI/2 BPSK	1@77	24.29	24.59	0.2877
2	15	15	396500	1902.5	DFT-s-OFDM QPSK	36@18	24.42	24.72	0.2965
2	15	15	396500	1902.5	DFT-s-OFDM QPSK	1@1	24.32	24.62	0.2897
2	15	15	396500	1902.5	DFT-s-OFDM QPSK	1@77	24.08	24.38	0.2742
2	15	15	396500	1902.5	DFT-s-OFDM 16 QAM	36@18	23.45	23.75	0.2371
2	15	15	396500	1902.5	DFT-s-OFDM 16 QAM	1@1	23.57	23.87	0.2438
2	15	15	396500	1902.5	DFT-s-OFDM 16 QAM	1@77	23.27	23.57	0.2275
2	15	15	396500	1902.5	DFT-s-OFDM 64 QAM	36@18	22.15	22.45	0.1758
2	15	15	396500	1902.5	DFT-s-OFDM 64 QAM	1@1	22.06	22.36	0.1722
2	15	15	396500	1902.5	DFT-s-OFDM 64 QAM	1@77	22.01	22.31	0.1702
2	15	15	396500	1902.5	DFT-s-OFDM 256 QAM	36@18	20.04	20.34	0.1081
2	15	15	396500	1902.5	DFT-s-OFDM 256 QAM	1@1	19.69	19.99	0.0998
2	15	15	396500	1902.5	DFT-s-OFDM 256 QAM	1@77	19.74	20.04	0.1009
2	15	15	396500	1902.5	CP-OFDM QPSK	39@191	21.66	21.96	0.1570
2	15	15	396500	1902.5	CP-OFDM QPSK	1@1	23	23.3	0.2138
2	15	15	396500	1902.5	CP-OFDM QPSK	1@77	22.72	23.02	0.2004
2	15	20	388000	1860	DFT-s-OFDM PI/2 BPSK	50@25	24.87	25.17	0.3289
2	15	20	388000	1860	DFT-s-OFDM PI/2 BPSK	1@1	24.31	24.61	0.2891

2	15	20	388000	1860	DFT-s-OFDM PI/2 BPSK	1@104	24.6	24.9	0.3090
2	15	20	388000	1860	DFT-s-OFDM QPSK	50@25	24.82	25.12	0.3251
2	15	20	388000	1860	DFT-s-OFDM QPSK	1@1	24.25	24.55	0.2851
2	15	20	388000	1860	DFT-s-OFDM QPSK	1@104	24.53	24.83	0.3041
2	15	20	388000	1860	DFT-s-OFDM 16 QAM	50@25	23.72	24.02	0.2523
2	15	20	388000	1860	DFT-s-OFDM 16 QAM	1@1	23.47	23.77	0.2382
2	15	20	388000	1860	DFT-s-OFDM 16 QAM	1@104	23.75	24.05	0.2541
2	15	20	388000	1860	DFT-s-OFDM 64 QAM	50@25	22.38	22.68	0.1854
2	15	20	388000	1860	DFT-s-OFDM 64 QAM	1@1	22.09	22.39	0.1734
2	15	20	388000	1860	DFT-s-OFDM 64 QAM	1@104	22.1	22.4	0.1738
2	15	20	388000	1860	DFT-s-OFDM 256 QAM	50@25	20.3	20.6	0.1148
2	15	20	388000	1860	DFT-s-OFDM 256 QAM	1@1	19.79	20.09	0.1021
2	15	20	388000	1860	DFT-s-OFDM 256 QAM	1@104	19.9	20.2	0.1047
2	15	20	388000	1860	CP-OFDM QPSK	53@26	23.25	23.55	0.2265
2	15	20	388000	1860	CP-OFDM QPSK	1@1	22.86	23.16	0.2070
2	15	20	388000	1860	CP-OFDM QPSK	1@104	23.18	23.48	0.2228
2	15	20	392000	1880	DFT-s-OFDM PI/2 BPSK	50@25	24.67	24.97	0.3141
2	15	20	392000	1880	DFT-s-OFDM PI/2 BPSK	1@1	24.34	24.64	0.2911
2	15	20	392000	1880	DFT-s-OFDM PI/2 BPSK	1@104	24.42	24.72	0.2965
2	15	20	392000	1880	DFT-s-OFDM QPSK	50@25	24.54	24.84	0.3048
2	15	20	392000	1880	DFT-s-OFDM QPSK	1@1	24.25	24.55	0.2851
2	15	20	392000	1880	DFT-s-OFDM QPSK	1@104	24.38	24.68	0.2938
2	15	20	392000	1880	DFT-s-OFDM 16 QAM	50@25	23.59	23.89	0.2449
2	15	20	392000	1880	DFT-s-OFDM 16 QAM	1@1	23.43	23.73	0.2360

2	15	20	392000	1880	DFT-s-OFDM 16 QAM	1@104	23.5	23.8	0.2399
2	15	20	392000	1880	DFT-s-OFDM 64 QAM	50@25	22.25	22.55	0.1799
2	15	20	392000	1880	DFT-s-OFDM 64 QAM	1@1	22.08	22.38	0.1730
2	15	20	392000	1880	DFT-s-OFDM 64 QAM	1@104	22.02	22.32	0.1706
2	15	20	392000	1880	DFT-s-OFDM 256 QAM	50@25	20.2	20.5	0.1122
2	15	20	392000	1880	DFT-s-OFDM 256 QAM	1@1	19.68	19.98	0.0995
2	15	20	392000	1880	DFT-s-OFDM 256 QAM	1@104	19.77	20.07	0.1016
2	15	20	392000	1880	CP-OFDM QPSK	53@26	22.93	23.23	0.2104
2	15	20	392000	1880	CP-OFDM QPSK	1@1	22.85	23.15	0.2065
2	15	20	392000	1880	CP-OFDM QPSK	1@104	23.08	23.38	0.2178
2	15	20	396000	1900	DFT-s-OFDM PI/2 BPSK	50@25	24.51	24.81	0.3027
2	15	20	396000	1900	DFT-s-OFDM PI/2 BPSK	1@1	24.15	24.45	0.2786
2	15	20	396000	1900	DFT-s-OFDM PI/2 BPSK	1@104	23.73	24.03	0.2529
2	15	20	396000	1900	DFT-s-OFDM QPSK	50@25	24.32	24.62	0.2897
2	15	20	396000	1900	DFT-s-OFDM QPSK	1@1	24.15	24.45	0.2786
2	15	20	396000	1900	DFT-s-OFDM QPSK	1@104	23.72	24.02	0.2523
2	15	20	396000	1900	DFT-s-OFDM 16 QAM	50@25	23.59	23.89	0.2449
2	15	20	396000	1900	DFT-s-OFDM 16 QAM	1@1	23.56	23.86	0.2432
2	15	20	396000	1900	DFT-s-OFDM 16 QAM	1@104	23.15	23.45	0.2213
2	15	20	396000	1900	DFT-s-OFDM 64 QAM	50@25	22.12	22.42	0.1746
2	15	20	396000	1900	DFT-s-OFDM 64 QAM	1@1	21.94	22.24	0.1675
2	15	20	396000	1900	DFT-s-OFDM 64 QAM	1@104	22.05	22.35	0.1718
2	15	20	396000	1900	DFT-s-OFDM 256 QAM	50@25	20.13	20.43	0.1104
2	15	20	396000	1900	DFT-s-OFDM 256 QAM	1@1	19.69	19.99	0.0998

2	15	20	396000	1900	DFT-s-OFDM 256 QAM	1@104	19.8	20.1	0.1023
2	15	20	396000	1900	CP-OFDM QPSK	53@26	22.9	23.2	0.2089
2	15	20	396000	1900	CP-OFDM QPSK	1@1	23.01	23.31	0.2143
2	15	20	396000	1900	CP-OFDM QPSK	1@104	22.64	22.94	0.1968

Frequency Stability

NR Band	SCS (kHz)	Bandwidth (MHz)	Arfcn	Freq (MHz)	Modulation	RB	Deviation (ppm)	Verdict	Environment
2	15	20	392000	1880.0	DFT-s-OFDM QPSK	100@0	-0.00176	PASS	NV
2	15	20	392000	1880.0	DFT-s-OFDM QPSK	100@0	-0.0056	PASS	LV
2	15	20	392000	1880.0	DFT-s-OFDM QPSK	100@0	-0.00743	PASS	HV
2	15	20	392000	1880.0	DFT-s-OFDM QPSK	100@0	-0.00494	PASS	-30°C
2	15	20	392000	1880.0	DFT-s-OFDM QPSK	100@0	-0.00154	PASS	-20°C
2	15	20	392000	1880.0	DFT-s-OFDM QPSK	100@0	-0.00254	PASS	-10°C
2	15	20	392000	1880.0	DFT-s-OFDM QPSK	100@0	-0.00591	PASS	0°C
2	15	20	392000	1880.0	DFT-s-OFDM QPSK	100@0	-0.00725	PASS	10°C
2	15	20	392000	1880.0	DFT-s-OFDM QPSK	100@0	-0.00668	PASS	20°C
2	15	20	392000	1880.0	DFT-s-OFDM QPSK	100@0	-0.00261	PASS	30°C
2	15	20	392000	1880.0	DFT-s-OFDM QPSK	100@0	-0.00564	PASS	40°C
2	15	20	392000	1880.0	DFT-s-OFDM QPSK	100@0	-0.00772	PASS	50°C

Peak to Average Ratio

NR Band	SCS (kHz)	Bandwidth (MHz)	Arfcn	Freq (MHz)	Modulation	RB	Result (dB)	Limit (dB)	Verdict
2	15	20	388000	1860.0	DFT-s-OFDM PI/2 BPSK	100@0	3.86	13	PASS
2	15	20	388000	1860.0	DFT-s-OFDM PI/2 BPSK	1@0	3.96	13	PASS
2	15	20	388000	1860.0	DFT-s-OFDM QPSK	100@0	4.5	13	PASS
2	15	20	388000	1860.0	DFT-s-OFDM QPSK	1@0	3.71	13	PASS
2	15	20	392000	1880.0	DFT-s-OFDM PI/2 BPSK	100@0	3.83	13	PASS
2	15	20	392000	1880.0	DFT-s-OFDM PI/2 BPSK	1@0	3.93	13	PASS
2	15	20	392000	1880.0	DFT-s-OFDM QPSK	100@0	4.53	13	PASS
2	15	20	392000	1880.0	DFT-s-OFDM QPSK	1@0	3.63	13	PASS
2	15	20	396000	1900.0	DFT-s-OFDM PI/2 BPSK	100@0	3.83	13	PASS
2	15	20	396000	1900.0	DFT-s-OFDM PI/2 BPSK	1@0	4.0	13	PASS
2	15	20	396000	1900.0	DFT-s-OFDM QPSK	100@0	4.59	13	PASS
2	15	20	396000	1900.0	DFT-s-OFDM QPSK	1@0	3.64	13	PASS

B5_N2(20M)_DFT-s-OFDM_PI_2-BPSK_Outer_Full_Low_CH



B5_N2(20M)_DFT-s-OFDM_PI_2-BPSK_Edge_1RB_Left_Low_CH



B5_N2(20M)_DFT-s-OFDM_QPSK_Outer_Full_Low_CH



B5_N2(20M)_DFT-s-OFDM_QPSK_Edge_1RB_Left_Low_CH



B5_N2(20M)_DFT-s-OFDM_PI_2-BPSK_Outer_Full_Mid_CH

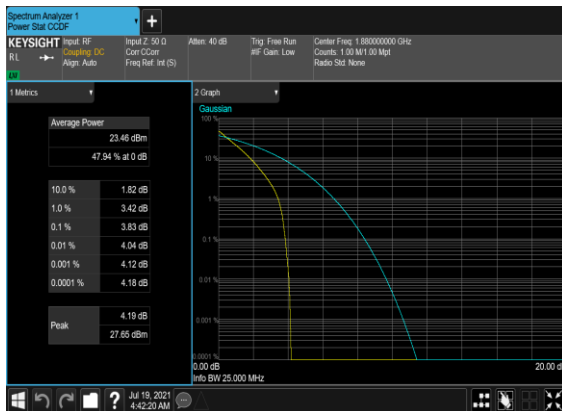

B5_N2(20M)_DFT-s-OFDM_PI_2-BPSK_Edge_1RB_Left_Mid_CH



B5_N2(20M)_DFT-s-OFDM_QPSK_Outer_Full_Mid_CH



B5_N2(20M)_DFT-s-OFDM_QPSK_Edge_1RB_Left_Mid_CH

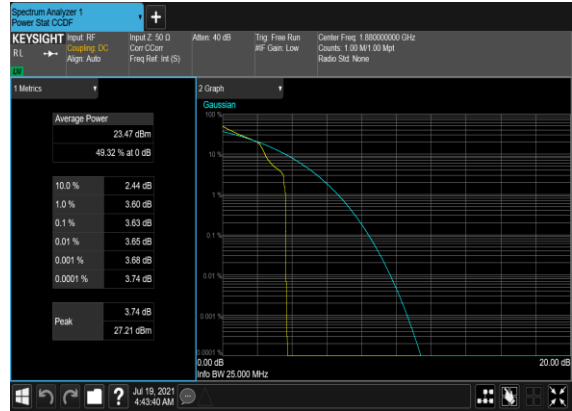

B5_N2(20M)_DFT-s-OFDM_PI_2-BPSK_Outer_Full_High_CH



B5_N2(20M)_DFT-s-OFDM_PI_2-BPSK_Edge_1RB_Left_High_CH



B5_N2(20M)_DFT-s-OFDM_QPSK_Outer_Full_High_CH



B5_N2(20M)_DFT-s-OFDM_QPSK_Edge_1RB_Left_High_CH



Occupied Bandwidth

NR Band	SCS (kHz)	Bandwidth (MHz)	Arfcn	Freq (MHz)	Modulation	RB	OBW (MHz)	26dB OBW (MHz)
2	15	5	392000	1880.0	DFT-s-OFDM PI/2 BPSK	25@0	4.4703	4.864
2	15	5	392000	1880.0	DFT-s-OFDM QPSK	25@0	4.4714	4.89
2	15	5	392000	1880.0	CP-OFDM QPSK	25@0	4.4701	4.969
2	15	5	392000	1880.0	CP-OFDM 16 QAM	25@0	4.4719	4.919
2	15	5	392000	1880.0	CP-OFDM 64 QAM	25@0	4.4721	4.938
2	15	5	392000	1880.0	CP-OFDM 256 QAM	25@0	4.4653	4.89
2	15	10	392000	1880.0	DFT-s-OFDM PI/2 BPSK	50@0	8.8969	9.422
2	15	10	392000	1880.0	DFT-s-OFDM QPSK	50@0	8.9106	9.541
2	15	10	392000	1880.0	CP-OFDM QPSK	52@0	9.2548	9.879
2	15	10	392000	1880.0	CP-OFDM 16 QAM	52@0	9.2652	9.841
2	15	10	392000	1880.0	CP-OFDM 64 QAM	52@0	9.2625	9.842
2	15	10	392000	1880.0	CP-OFDM 256 QAM	52@0	9.2813	9.872
2	15	15	392000	1880.0	DFT-s-OFDM PI/2 BPSK	75@0	13.384	14.19
2	15	15	392000	1880.0	DFT-s-OFDM QPSK	75@0	13.386	14.09
2	15	15	392000	1880.0	CP-OFDM QPSK	79@0	14.098	14.8
2	15	15	392000	1880.0	CP-OFDM 16 QAM	79@0	14.099	14.91
2	15	15	392000	1880.0	CP-OFDM 64 QAM	79@0	14.103	14.79
2	15	15	392000	1880.0	CP-OFDM 256 QAM	79@0	14.065	14.81
2	15	20	392000	1880.0	DFT-s-OFDM PI/2 BPSK	100@0	17.83	18.67
2	15	20	392000	1880.0	DFT-s-OFDM QPSK	100@0	17.857	18.65
2	15	20	392000	1880.0	CP-OFDM QPSK	106@0	18.888	19.83
2	15	20	392000	1880.0	CP-OFDM 16 QAM	106@0	18.93	19.78
2	15	20	392000	1880.0	CP-OFDM 64 QAM	106@0	18.892	19.75
2	15	20	392000	1880.0	CP-OFDM 256 QAM	106@0	18.963	19.79