

ANT 1(11AC40)

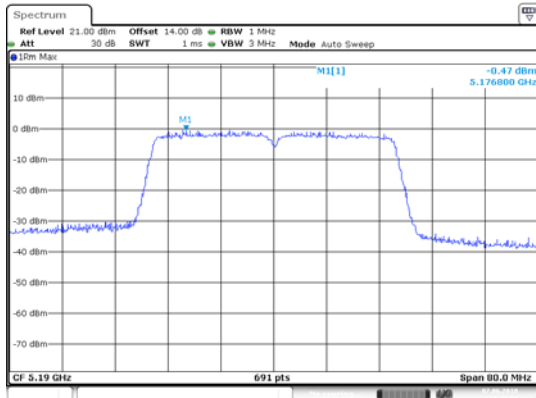

Date: 7 JUN 2018 11:44:53

ANT 2(11AC40)

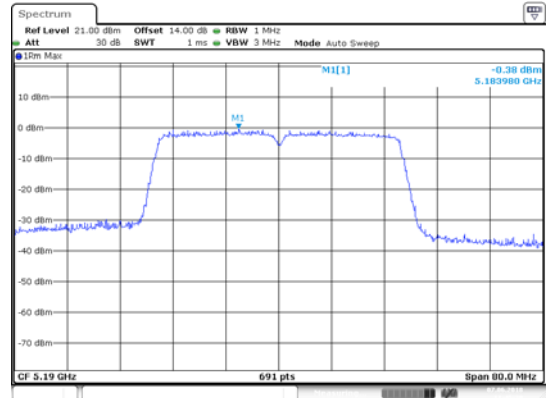

Date: 7 JUN 2018 11:45:29

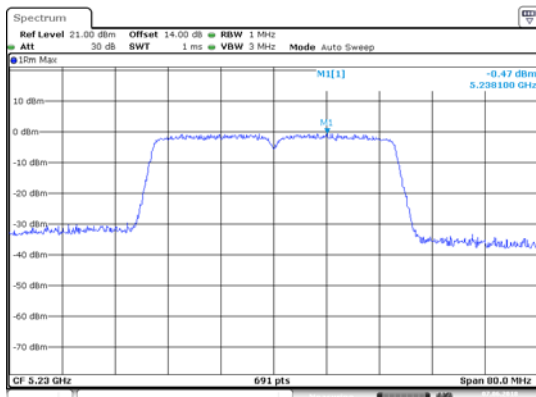

Date: 7 JUN 2018 11:47:08

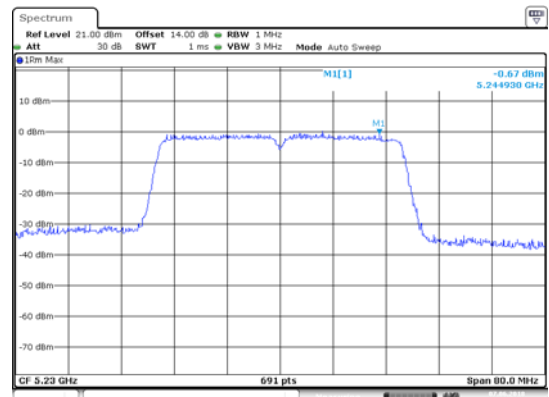

Date: 7 JUN 2018 11:47:35

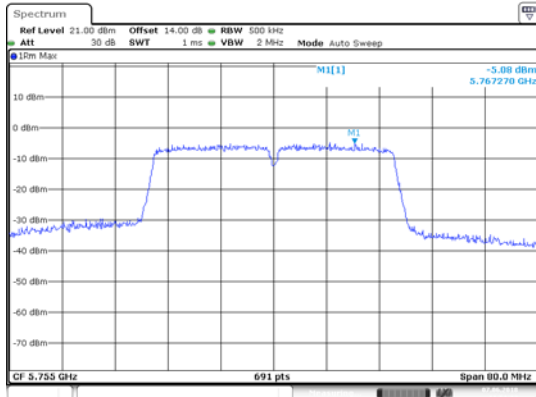

Date: 7 JUN 2018 11:51:11

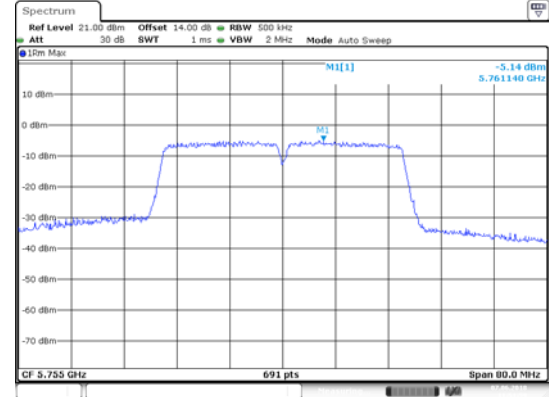

Date: 7 JUN 2018 11:51:58

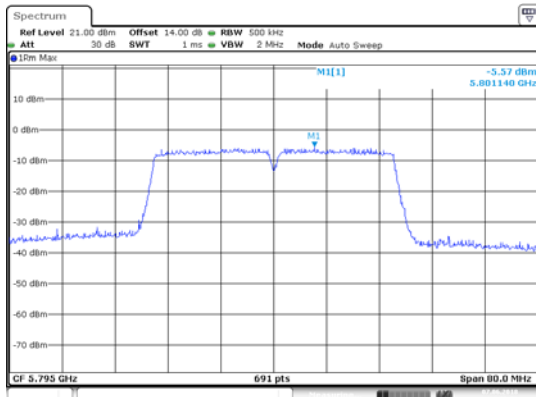

Date: 7 JUN 2018 11:53:58

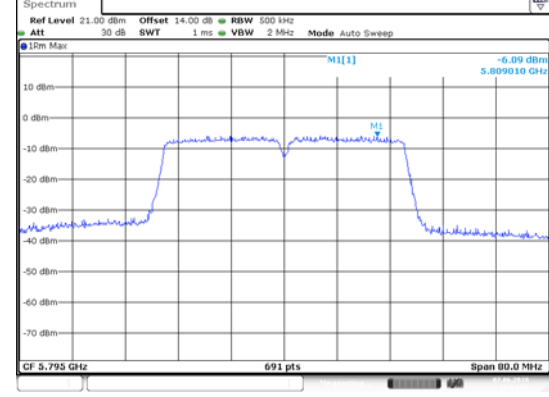

Date: 7 JUN 2018 11:54:25

ANT 1(11AC80)

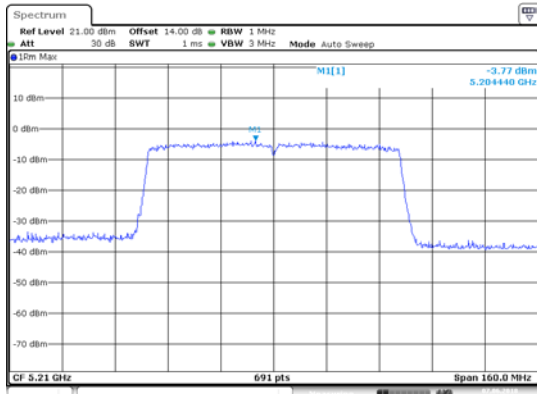

Date: 7.JUN.2018 12:04:33

ANT 2(11AC80)

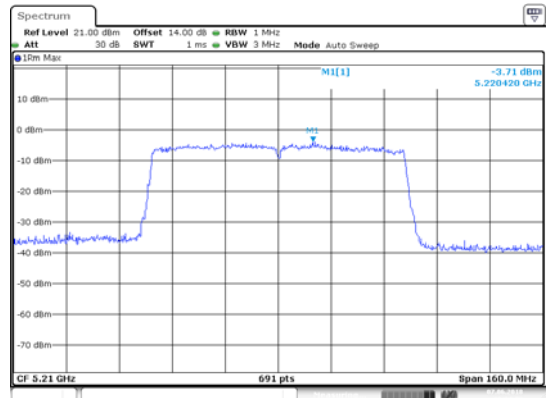

Date: 7.JUN.2018 12:04:59

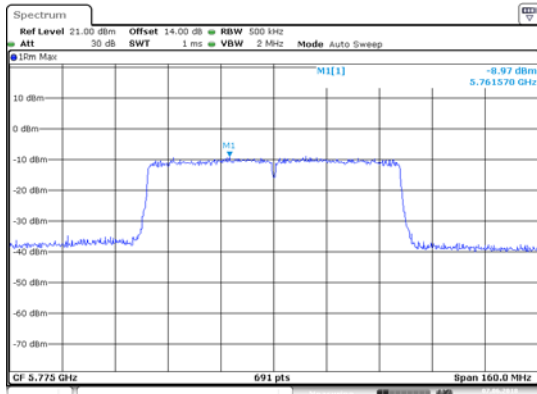

Date: 7.JUN.2018 12:09:41

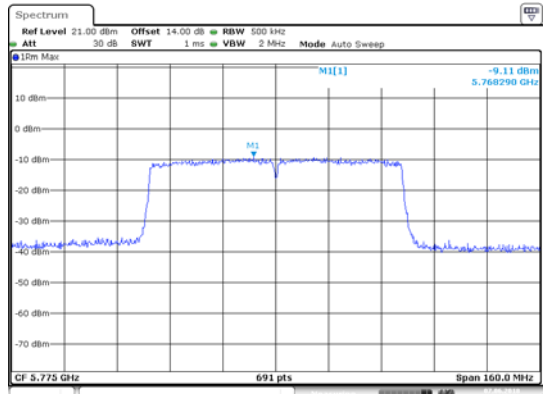

Date: 7.JUN.2018 12:10:12

10. MAXIMUM CONDUCTED (AVERAGE) OUTPUT POWER

10.1. Block Diagram of Test Setup

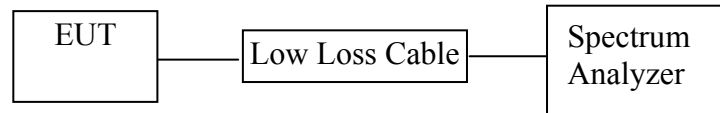

10.2. The Requirement For Section 15.407

Section 15.407: For the band 5.15–5.25 GHz, the maximum conducted output power over the frequency band of operation shall not exceed the lesser of 50 mW or $4 \text{ dBm} + 10 \log B$, where B is the 26-dB emission bandwidth in MHz.

For the band 5.725–5.825 GHz, the maximum conducted output power over the frequency band of operation shall not exceed the lesser of 1 W or $17 \text{ dBm} + 10 \log B$, where B is the 26-dB emission bandwidth in MHz.

10.3. EUT Configuration on Measurement

The equipment is installed on the emission Measurement to meet the commission requirements and operating regulations in a manner which tends to maximize its emission characteristics in normal application.

10.4. Operating Condition of EUT

10.4.1. Setup the EUT and simulator as shown as Section 10.1.

10.4.2. Turn on the power of all equipment.

10.4.3. Let the EUT work in TX modes measure it. The transmit frequency are 5150-5250 and 5725-5850MHz.

10.5. Test Procedure

10.5.1. The transmitter output was connected to the spectrum analyzer through a low loss cable.

10.5.2. Set $\text{RBW} = 1\text{-}5\%$ of the OBW, $\text{VBW} \geq 3 \times \text{RBW}$, Sweep time = auto, Set span to at least 1.5 times the OBW, Detector = RMS.

10.5.3. Measurement the Maximum conducted (average) output power.

10.6. Test Result

Final Ave output power ANT 1= Ave output power ANT 1+10log(1/x) ANT 1

Final Ave output power ANT 2= Ave output power ANT 2+10log(1/x) ANT 2

The test was performed with 802.11A					
Channel	Frequency (MHz)	Ave output power ANT 1(dBm)	Ave output power ANT 2 (dBm)	10log(1/x) ANT 1	10log(1/x) ANT 2
Low	5180	15.05	15.00	0.14	0.14
High	5240	15.29	15.53	0.14	0.14
Low	5745	12.83	12.80	0.14	0.14
High	5825	11.48	11.08	0.14	0.14

The test was performed with 802.11A						
Channel	Frequency (MHz)	Final Ave output power ANT 1(dBm)	Final Ave output power ANT 2 (dBm)	Final Ave output power ANT 1(mW)	Final Ave output power ANT 2 (mW)	Limits dBm
Low	5180	15.19	15.14	33.04	32.66	24 dBm
High	5240	15.43	15.67	34.91	36.90	24 dBm
Low	5745	12.97	12.94	19.82	19.68	30 dBm
High	5825	11.62	11.22	14.52	13.24	30 dBm

The test was performed with 802.11 N20					
Channel	Frequency (MHz)	Ave output power ANT 1(dBm)	Ave output power ANT 2 (dBm)	10log(1/x) ANT 1	10log(1/x) ANT 2
Low	5180	16.41	16.51	0.14	0.15
High	5240	16.69	16.81	0.14	0.15
Low	5745	12.43	12.69	0.14	0.15
High	5825	11.61	11.51	0.14	0.15

The test was performed with 802.11 N20						
Channel	Frequency (MHz)	Final Ave output power ANT 1(dBm)	Final Ave output power ANT 2 (dBm)	Ave output Total power (dBm)	Ave output Total power (mW)	Limits dBm
Low	5180	16.55	16.66	19.62	91.53	24 dBm
High	5240	16.83	16.96	19.91	97.85	24 dBm
Low	5745	12.57	12.84	15.72	37.30	30 dBm
High	5825	11.75	11.66	14.72	29.62	30 dBm

The test was performed with 802.11 AC(20MHz)

Channel	Frequency (MHz)	Ave output power ANT 1(dBm)	Ave output power ANT 2 (dBm)	10log(1/x) ANT 1	10log(1/x) ANT 2
Low	5180	16.48	16.46	0.15	0.15
High	5240	16.64	16.72	0.15	0.15
Low	5745	12.78	12.84	0.15	0.15
High	5825	11.57	11.67	0.15	0.15

The test was performed with 802.11 AC(20MHz)

Channel	Frequency (MHz)	Final Ave output power ANT 1(dBm)	Final Ave output power ANT 2 (dBm)	Ave output Total power (dBm)	Ave output Total power (mW)	Limits dBm
Low	5180	16.63	16.61	19.63	91.84	24 dBm
High	5240	16.79	16.87	19.84	96.39	24 dBm
Low	5745	12.93	12.99	15.97	39.54	30 dBm
High	5825	11.72	11.82	14.78	30.06	30 dBm

The test was performed with 802.11 N40

Channel	Frequency (MHz)	Ave output power ANT 1(dBm)	Ave output power ANT 2 (dBm)	10log(1/x) ANT 1	10log(1/x) ANT 2
Low	5190	13.93	13.84	0.29	0.29
High	5230	14.18	14.19	0.29	0.29
Low	5755	11.56	11.66	0.29	0.29
High	5795	10.81	10.70	0.29	0.29

The test was performed with 802.11 N40

Channel	Frequency (MHz)	Final Ave output power ANT 1(dBm)	Final Ave output power ANT 2 (dBm)	Ave output Total power (dBm)	Ave output Total power (mW)	Limits dBm
Low	5190	14.22	14.13	17.19	52.31	24 dBm
High	5230	14.47	14.48	17.49	56.04	24 dBm
Low	5755	11.85	11.95	14.91	30.98	30 dBm
High	5795	11.10	10.99	14.06	25.44	30 dBm

The test was performed with 802.11 AC(40MHz)

Channel	Frequency (MHz)	Ave output power ANT 1(dBm)	Ave output power ANT 2 (dBm)	10log(1/x) ANT 1	10log(1/x) ANT 2
Low	5190	14.49	14.26	0.29	0.29
High	5230	14.40	14.47	0.29	0.29
Low	5755	11.25	11.39	0.29	0.29
High	5795	10.72	10.78	0.29	0.29

The test was performed with 802.11 AC(40MHz)

Channel	Frequency (MHz)	Final Ave output power ANT 1(dBm)	Final Ave output power ANT 2 (dBm)	Ave output Total power (dBm)	Ave output Total power (mW)	Limits dBm
Low	5190	14.78	14.55	17.68	58.57	24 dBm
High	5230	14.69	14.76	17.74	59.37	24 dBm
Low	5755	11.54	11.68	14.62	28.98	30 dBm
High	5795	11.01	11.07	14.05	25.41	30 dBm

The test was performed with 802.11 AC(80MHz)

Channel	Frequency (MHz)	Ave output power ANT 1(dBm)	Ave output power ANT 2 (dBm)	10log(1/x) ANT 1	10log(1/x) ANT 2
42	5210	13.57	13.58	0.58	0.58
155	5775	10.66	10.50	0.58	0.58

The test was performed with 802.11 AC(80MHz)

Channel	Frequency (MHz)	Final Ave output power ANT 1(dBm)	Final Ave output power ANT 2 (dBm)	Ave output Total power (dBm)	Ave output Total power (mW)	Limits dBm
42	5210	14.15	14.16	17.17	52.06	24 dBm
155	5775	11.24	11.08	14.17	26.13	30 dBm

The spectrum analyzer plots are attached as below.

ANT 1(802.11A)

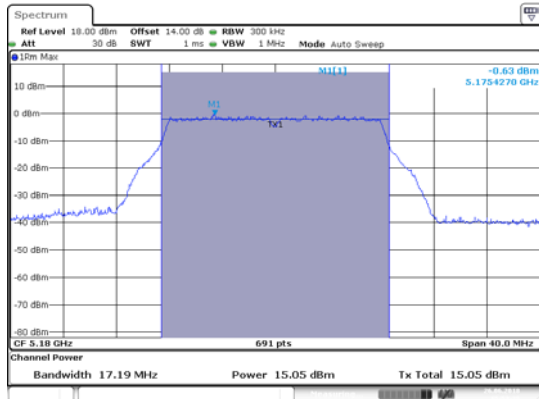

Date: 26.JUN.2018 15:53:25

ANT 2(802.11A)

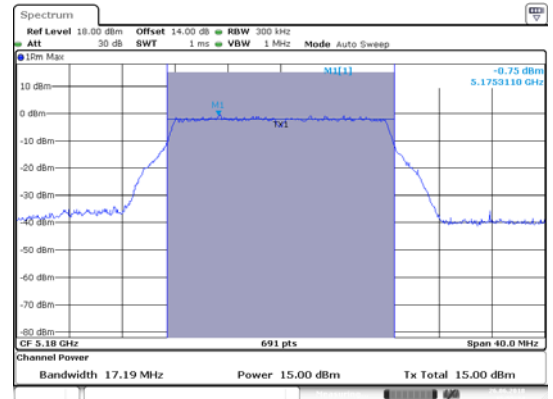

Date: 26.JUN.2018 15:55:24

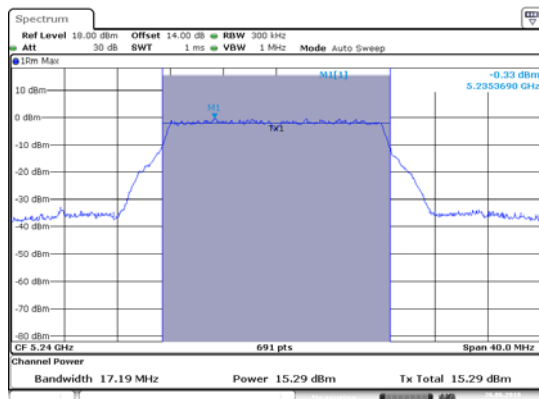

Date: 26.JUN.2018 15:56:54

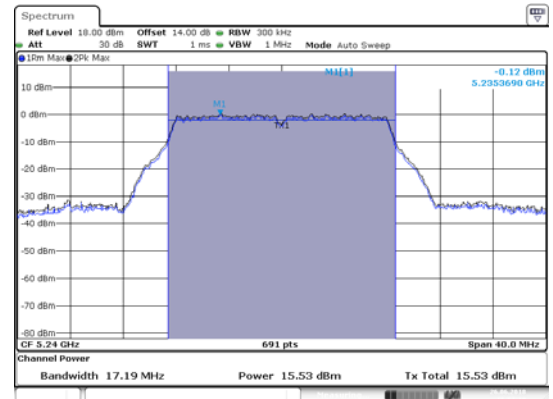

Date: 26.JUN.2018 15:57:18

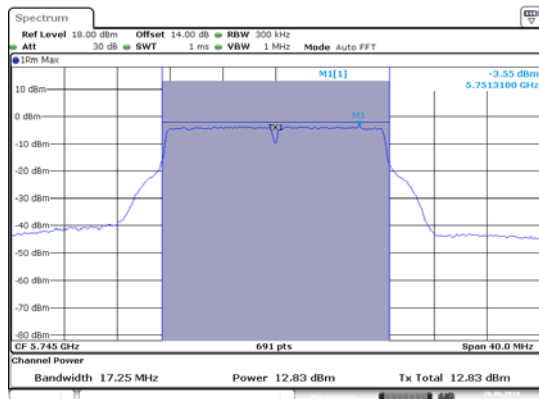

Date: 26.JUN.2018 16:06:52

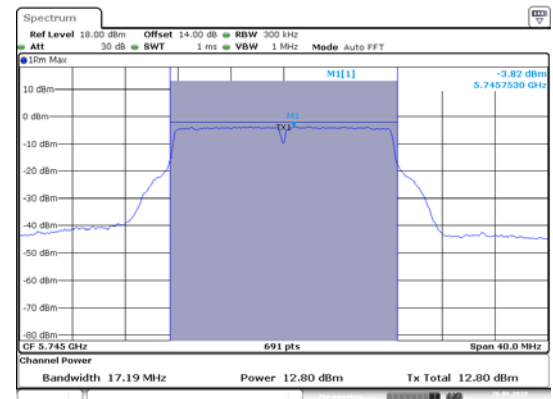

Date: 26.JUN.2018 16:08:24

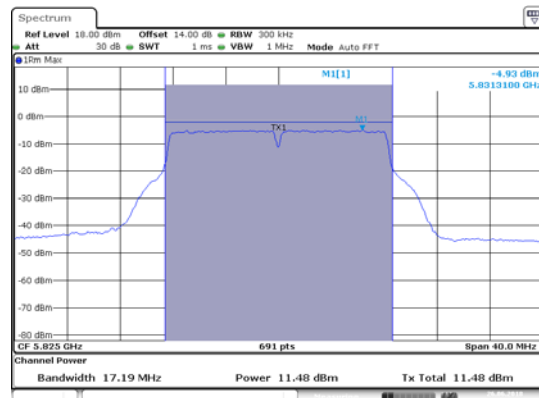

Date: 26.JUN.2018 16:05:03

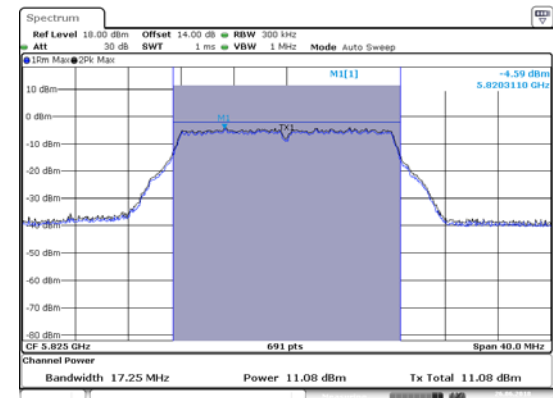

Date: 26.JUN.2018 16:03:29

ANT 1(802.11N20)

ANT 2(802.11 N20)

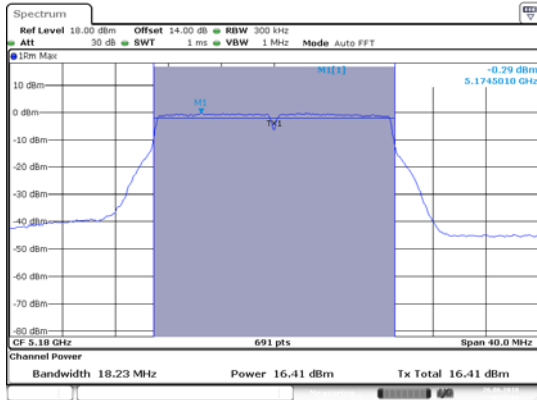

Date: 26.JUN.2018 16:11:10

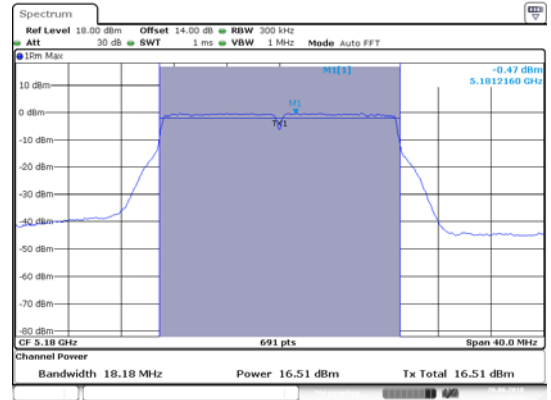

Date: 26.JUN.2018 16:12:17

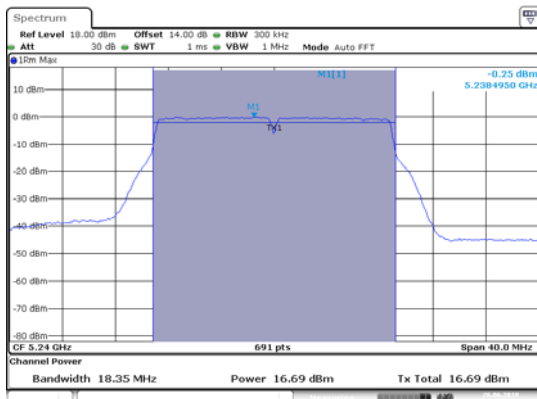

Date: 26.JUN.2018 16:15:08

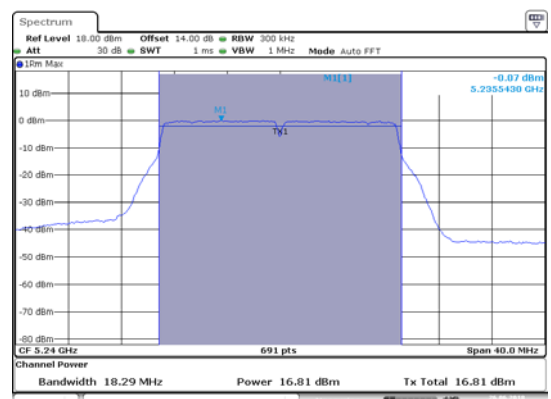

Date: 26.JUN.2018 16:17:43

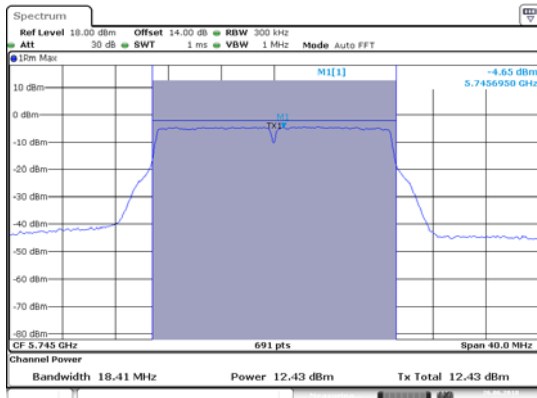

Date: 26.JUN.2018 16:18:55

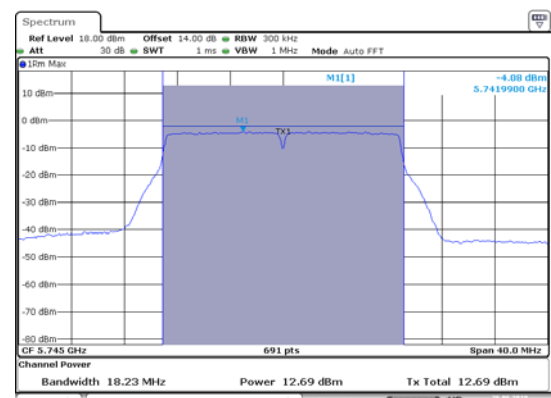

Date: 26.JUN.2018 16:19:41

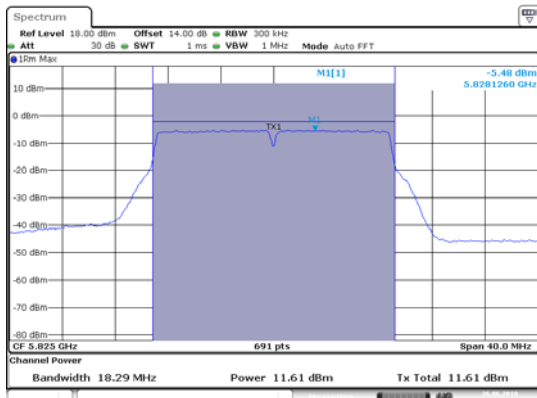

Date: 26.JUN.2018 16:21:36

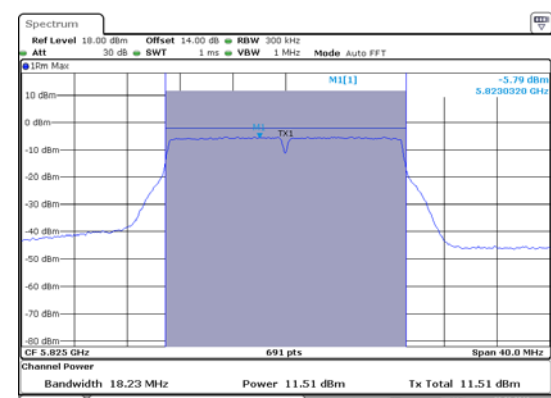

Date: 26.JUN.2018 16:20:39

ANT 1(802.11 AC 20MHz)

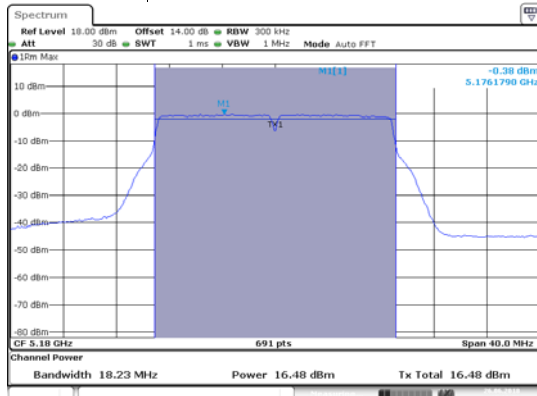

Date: 26 JUN 2018 16:22:59

ANT 2(802.11 AC 20MHz)

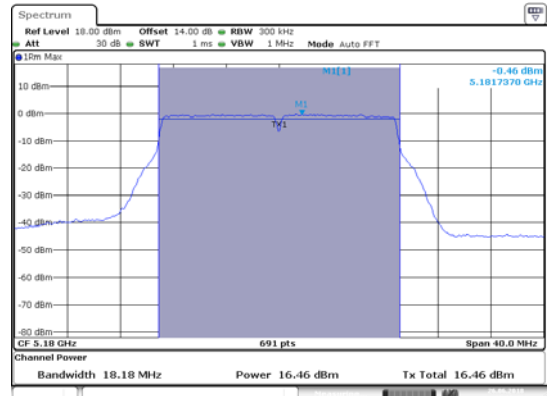

Date: 26 JUN 2018 16:23:42

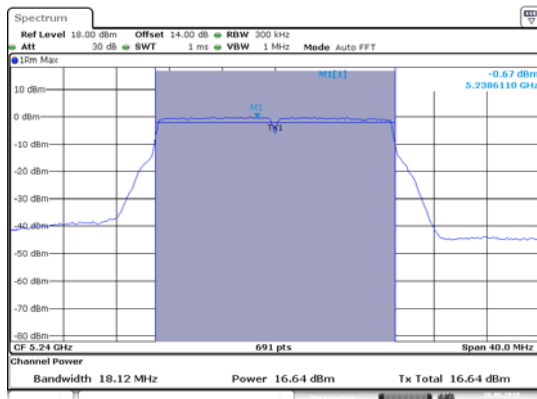

Date: 26 JUN 2018 16:25:25

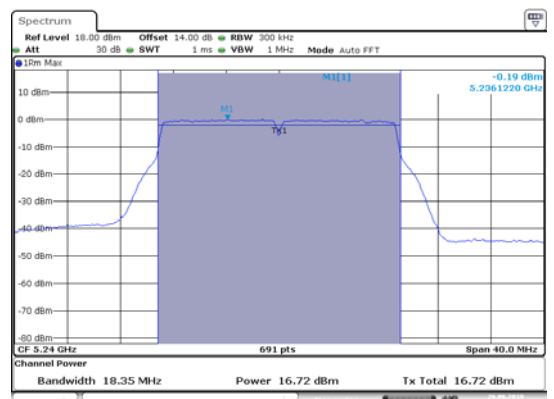

Date: 26 JUN 2018 16:26:18

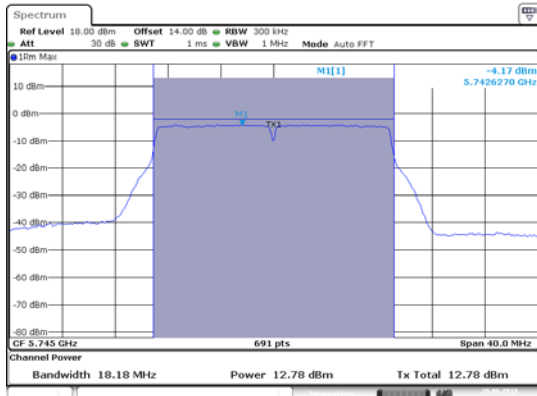

Date: 26 JUN 2018 16:27:38

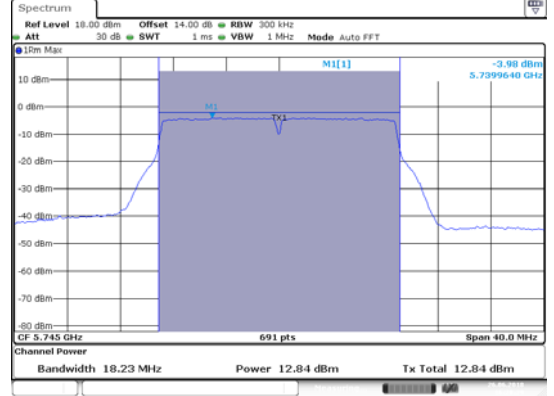

Date: 26 JUN 2018 16:28:30

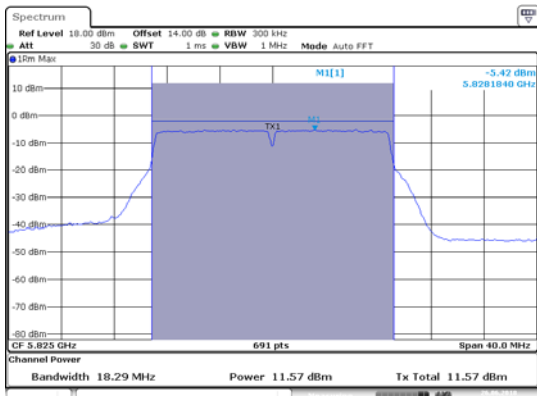

Date: 26 JUN 2018 16:29:48

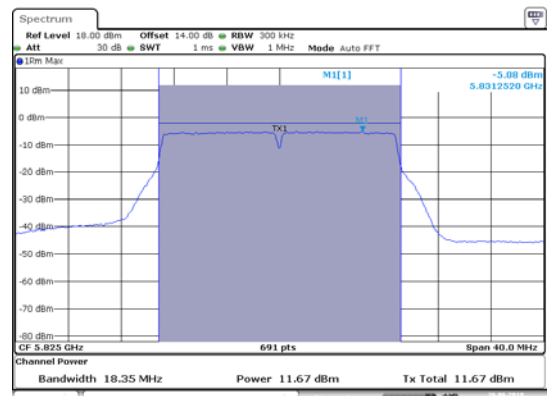

Date: 26 JUN 2018 16:30:55

ANT 1(802.11N40)

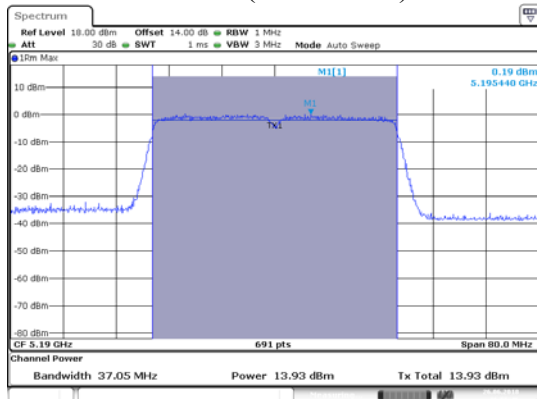

ANT 2(802.11N40)

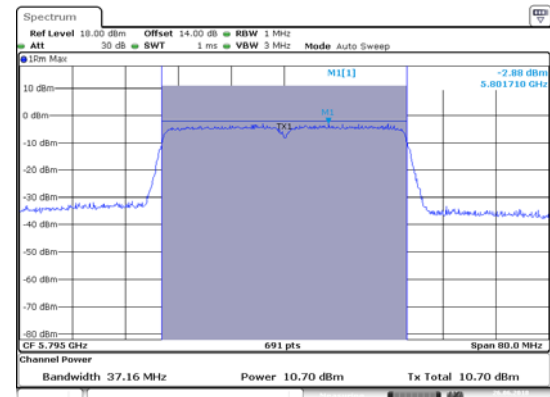
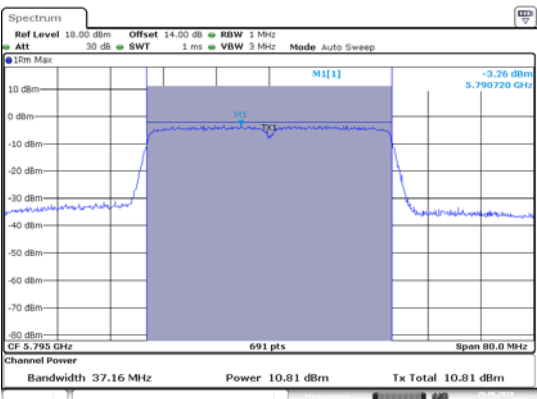
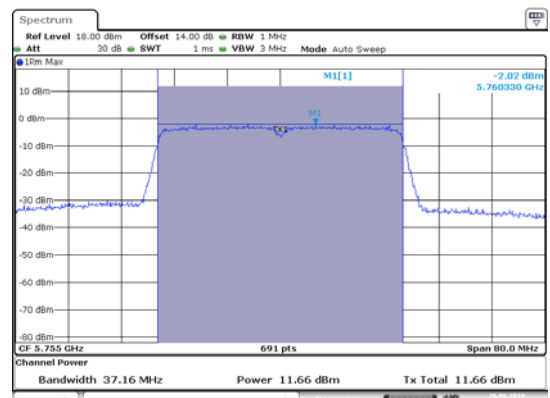
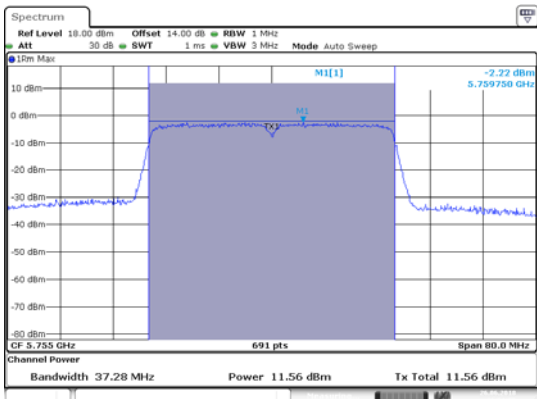
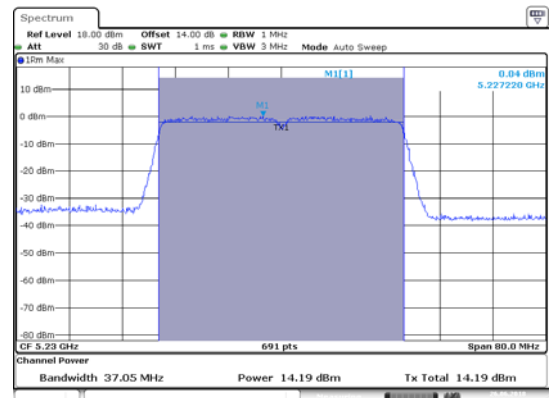
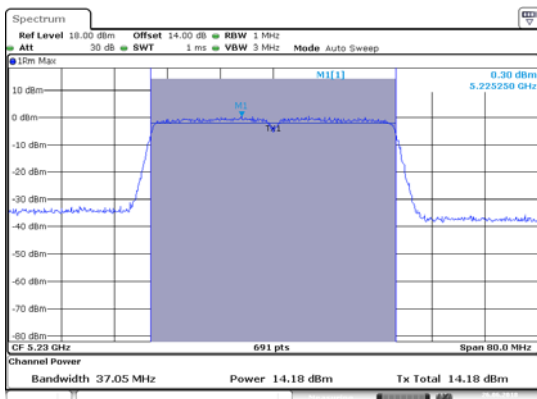
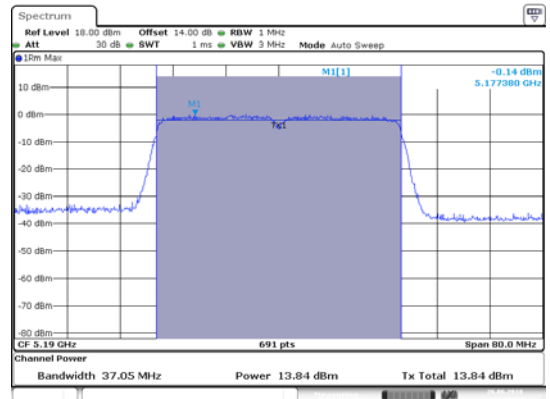

ANT 1(802.11 AC 40MHz)

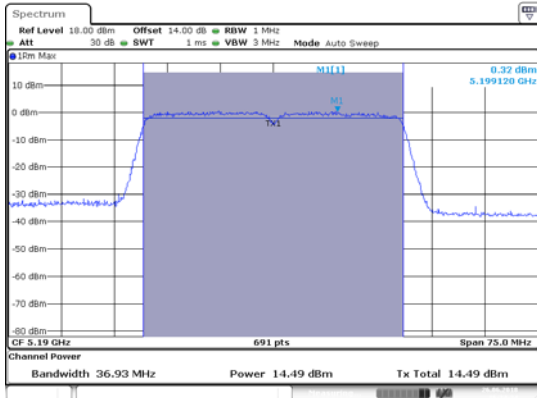

Date: 26 JUN 2018 16:34:25

ANT 2(802.11 AC 40MHz)

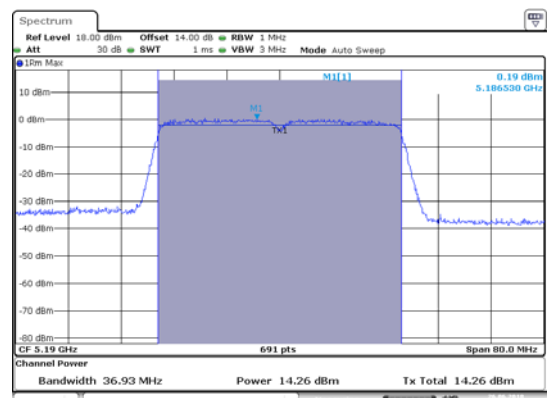

Date: 26 JUN 2018 16:38:13

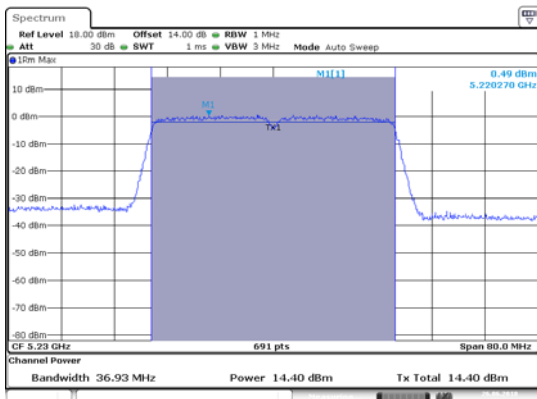

Date: 26 JUN 2018 16:40:35

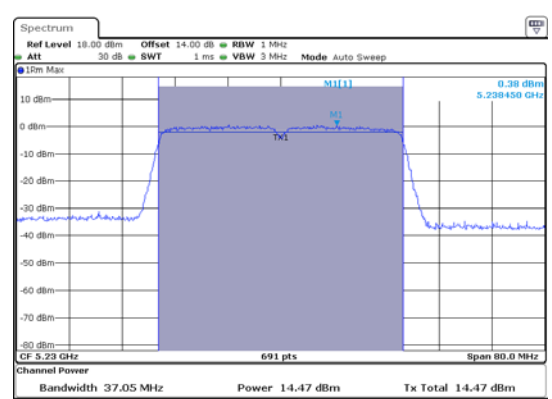

Date: 26 JUN 2018 16:42:54

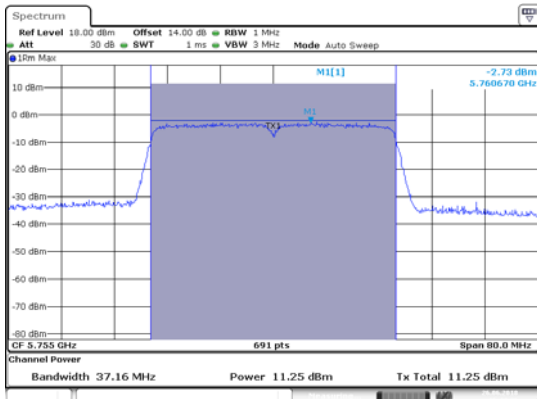

Date: 26 JUN 2018 16:44:26

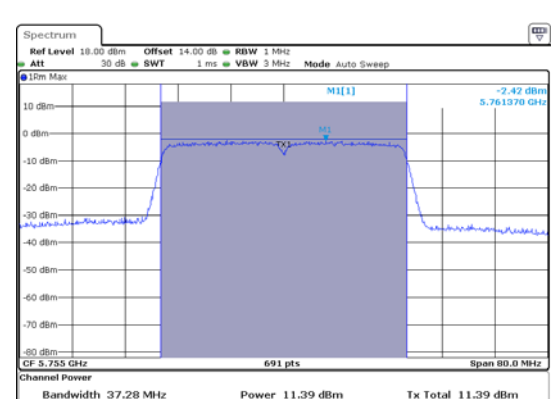

Date: 26 JUN 2018 16:45:39

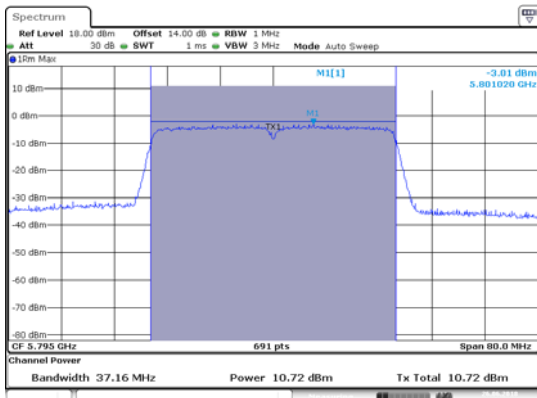

Date: 26 JUN 2018 16:47:05

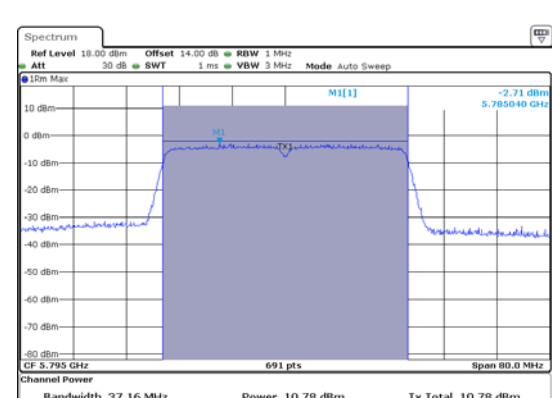

Date: 26 JUN 2018 16:47:53

ANT 1(802.11 AC 80MHz)

ANT 2(802.11 AC 80MHz)

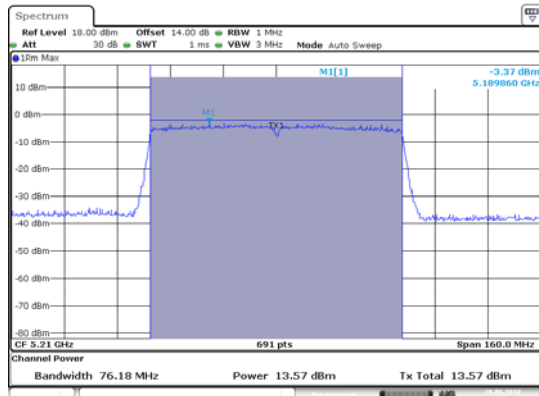

Date: 26 JUN 2018 16:59:45

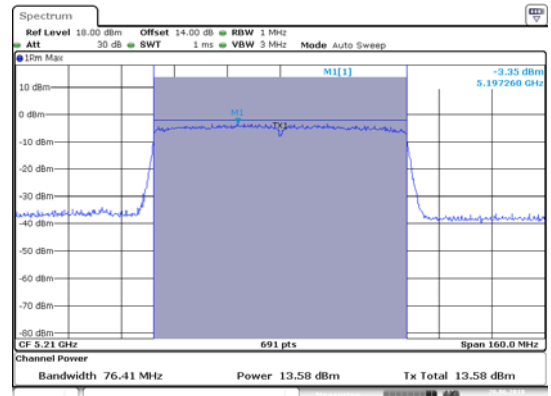

Date: 26 JUN 2018 17:01:06

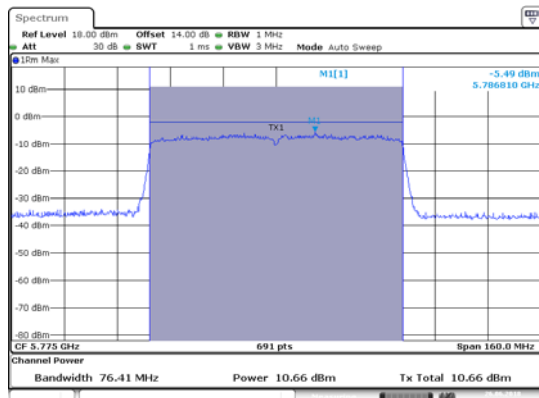

Date: 26 JUN 2018 17:03:20

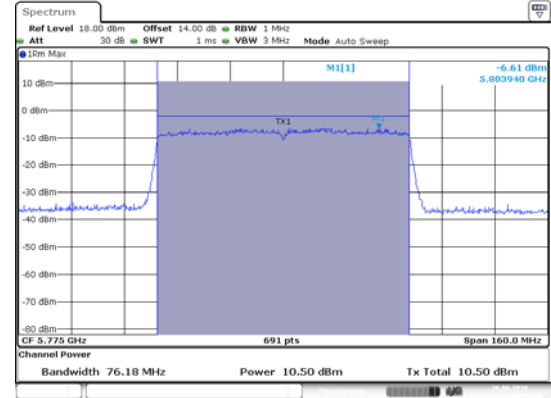

Date: 26 JUN 2018 17:04:20

11.RADIATED SPURIOUS EMISSION TEST

11.1.Block Diagram of Test Setup

11.1.1.Block diagram of connection between the EUT and peripherals

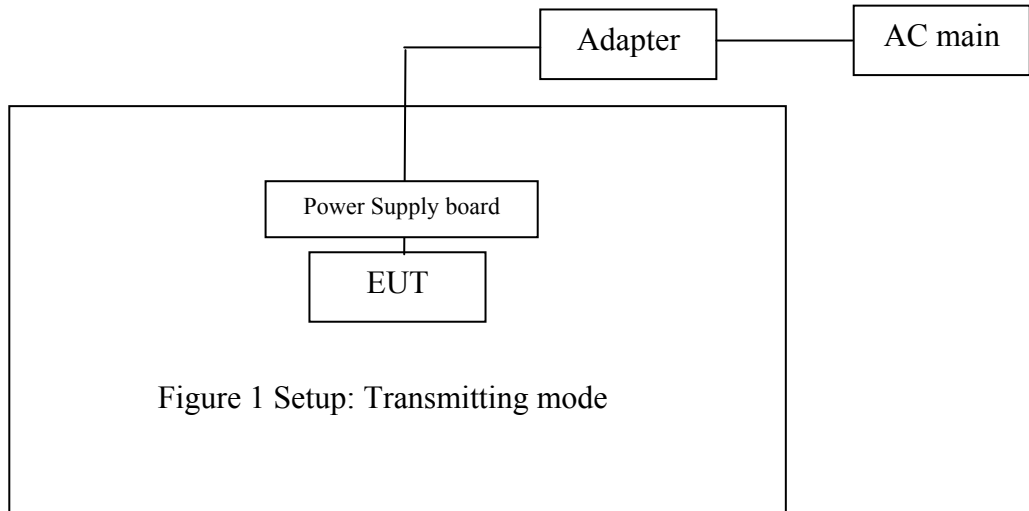

(EUT: UP-Android 7 module)

11.1.2.Semi-Anechoic Chamber Test Setup Diagram

(A) Radiated Emission Test Set-Up, Frequency below 30MHz

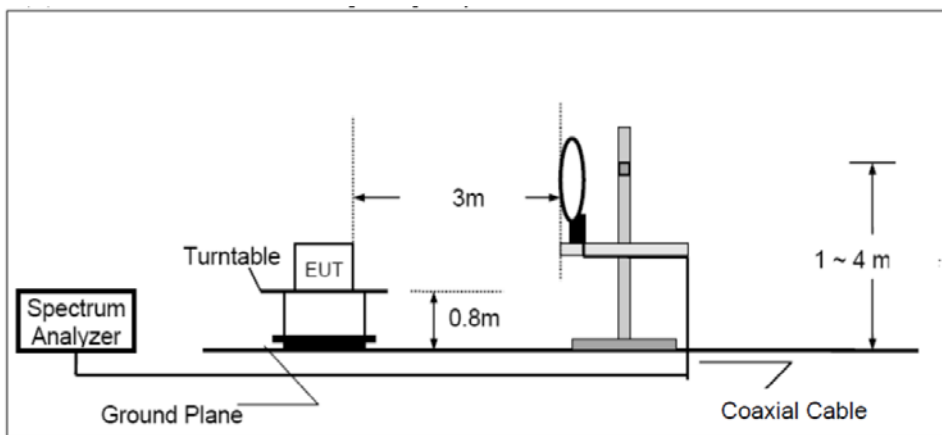

(B) Radiated Emission Test Set-Up, Frequency below 1GHz

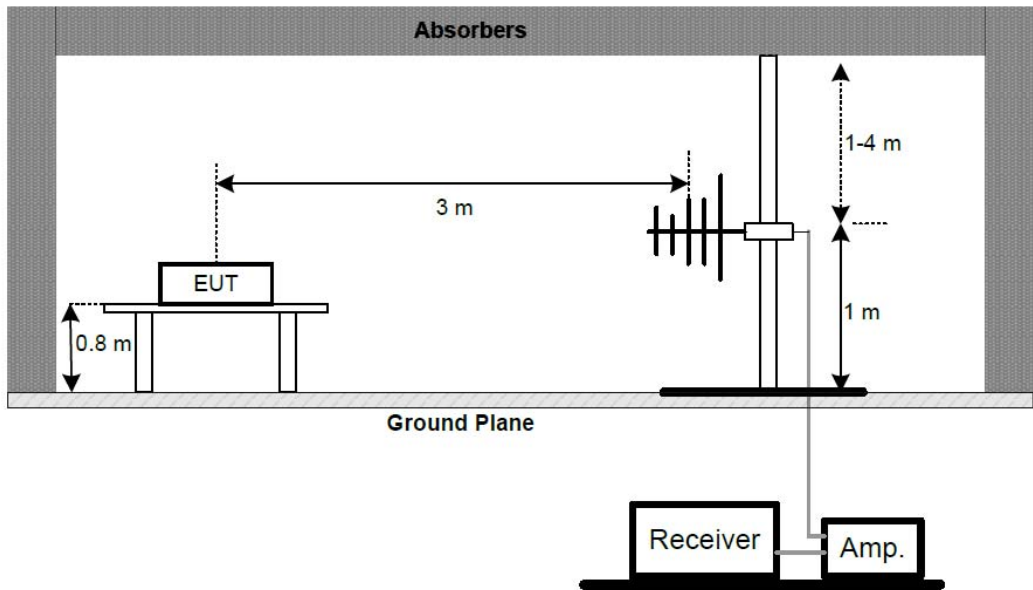

Above 1GHz:

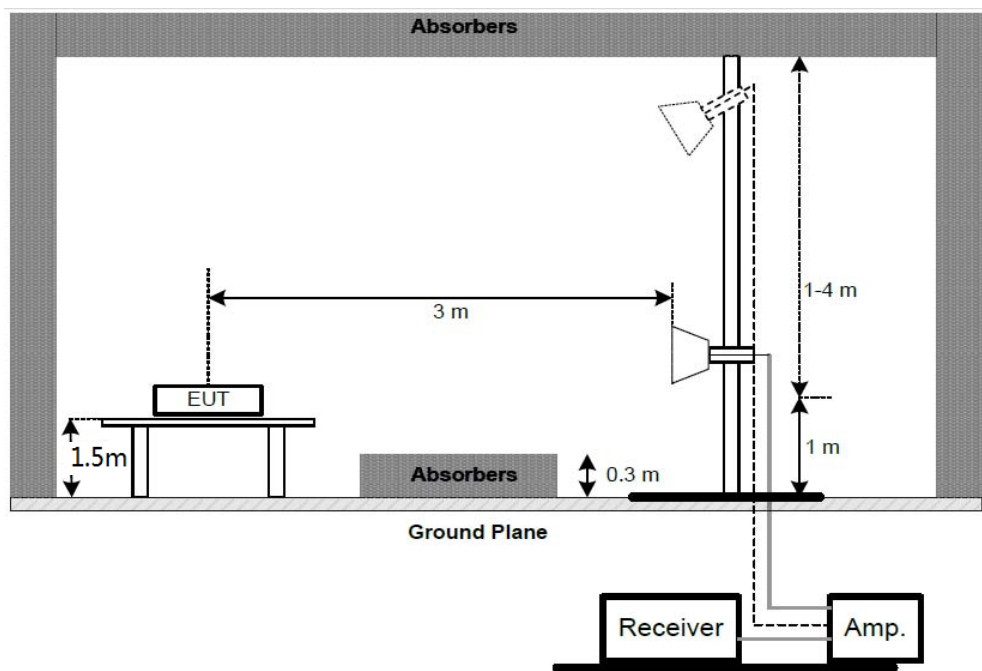

11.2.Restricted bands of operation

11.2.1.FCC Part 15.205 Restricted bands of operation

(a) Except as shown in paragraph (d) of this section, Only spurious emissions are permitted in any of the frequency bands listed below:

MHz	MHz	MHz	GHz
0.090-0.110	16.42-16.423	399.9-410	4.5-5.15
¹ 0.495-0.505	16.69475-16.69525	608-614	5.35-5.46
2.1735-2.1905	16.80425-16.80475	960-1240	7.25-7.75
4.125-4.128	25.5-25.67	1300-1427	8.025-8.5
4.17725-4.17775	37.5-38.25	1435-1626.5	9.0-9.2
4.20725-4.20775	73-74.6	1645.5-1646.5	9.3-9.5
6.215-6.218	74.8-75.2	1660-1710	10.6-12.7
6.26775-6.26825	108-121.94	1718.8-1722.2	13.25-13.4
6.31175-6.31225	123-138	2200-2300	14.47-14.5
8.291-8.294	149.9-150.05	2310-2390	15.35-16.2
8.362-8.366	156.52475-156.52525	2483.5-2500	17.7-21.4
8.37625-8.38675	156.7-156.9	2690-2900	22.01-23.12
8.41425-8.41475	162.0125-167.17	3260-3267	23.6-24.0
12.29-12.293	167.72-173.2	3332-3339	31.2-31.8
12.51975-12.52025	240-285	3345.8-3358	36.43-36.5
12.57675-12.57725	322-335.4	3600-4400	(²)
13.36-13.41			

¹Until February 1, 1999, this restricted band shall be 0.490-0.510

²Above 38.6

(b) Except as provided in paragraphs (d) and (e), the field strength of emission appearing within these frequency bands shall not exceed the limits shown in Section 15.209.

At frequencies equal to or less than 1000MHz, Compliance with the limits in Section 15.209 shall be demonstrated using measurement instrumentation employing a CISPR quasi-peak detector. Above 1000MHz, compliance with the emission limits in Section 15.209 shall be demonstrated

based on the average value of the measured emissions. The provisions in Section 15.35 apply to these measurements.

11.3.Configuration of EUT on Measurement

The equipment are installed on Radiated Emission Measurement to meet the commission requirements and operating regulations in a manner which tends to maximize its emission characteristics in normal application.

11.4. The Limit For Section 15.407

Section 15.247(d): For transmitters operating in the 5.15–5.25 GHz band: all emissions out-side of the 5.15–5.35 GHz band shall not exceed an EIRP of –27dBm/MHz.

For transmitters operating in the 5.725–5.825 GHz band: all emissions within the frequency range from the band edge to 10 MHz above or below the band edge shall not exceed an EIRP of –17dBm/MHz; for frequencies 10 MHz or greater above or below the band edge, emissions shall not exceed an EIRP of –27dBm/MHz.

11.5. Operating Condition of EUT

11.5.1. Setup the EUT and simulator as shown as Section 11.1.

11.5.2. Turn on the power of all equipment.

11.5.3. Let the EUT work in TX modes measure it. The transmit frequency are 5150-5250 and 5725-5825MHz.

11.6. Test Procedure

The EUT and its simulators are placed on a turntable, which is 0.8 meter high above ground(Below 1GHz). The EUT and its simulators are placed on a turntable, which is 1.5 meter high above ground(Above 1GHz). The turntable can rotate 360 degrees to determine the position of the maximum emission level. EUT is set 3.0 meters away from the receiving antenna, which is mounted on an antenna tower. The antenna can be moved up and down between 1.0 meter and 4 meters to find out the maximum emission level. Broadband antenna (calibrated bi-log antenna) is used as receiving antenna. Both horizontal and vertical polarizations of the antenna are set on measurement. In order to find the maximum emission levels, all of the EUT location must be manipulated according to ANSI C63.10:2013 on radiated emission measurement. The EUT was tested in 3 orthogonal planes.

The frequency range from 9KHz to 40000MHz is checked.

Result = Reading + Corrected Factor

Where Corrected Factor = Antenna Factor + Cable Loss – Amplifier Gain

During the radiated emission test, the spectrum analyzer was set with the following configurations:

1. The resolution bandwidth and video bandwidth of test receiver/spectrum analyzer is 120kHz for Quasi-peak at frequency below 1GHz.
2. The resolution bandwidth of test receiver/spectrum analyzer is 1MHz and video bandwidth is 3MHz for peak measurement with peak detector at frequency above 1GHz.
3. The resolution bandwidth of test receiver/spectrum analyzer is 1MHz and video bandwidth is 10Hz for Average measurement with peak detection at frequency above 1GHz.
4. All modes of operation were investigated and the worst-case emissions are reported.

11.7.DATA SAMPLE

Frequency (MHz)	Reading (dB μ v)	Factor (dB/m)	Result (dB μ v/m)	Limit (dB μ v/m)	Margin (dB)	Remark
X.XX	49.83	-22.03	27.80	43.50	-15.70	QP

Frequency(MHz) = Emission frequency in MHz

Reading(dB μ v) = Uncorrected Analyzer/Receiver reading

Factor (dB/m)= Antenna factor + Cable Loss – Amplifier gain

Result(dB μ v/m) = Reading + Factor

Limit (dB μ v/m)= Limit stated in standard

Margin (dB) = Result(dB μ v/m) - Limit (dB μ v/m)

Calculation Formula:

Margin(dB) = Result (dB μ v/m)–Limit(dB μ v/m)

Result(dB μ v/m)= Reading(dB μ v)+ Factor(dB/m)

The “Margin” column of the following data tables indicates the degree of compliance with the applicable limit. For example, a margin of -7dB means the emission is 7dB below the limit.

11.8.The Field Strength of Radiation Emission Measurement Results

Note: 1. Emissions attenuated more than 20 dB below the permissible value are not reported.

2. *: Denotes restricted band of operation.

3. The fundamental radiated emissions were reduced by Band Reject Filter in the attached plots.

4. The EUT is tested radiation emission at each test mode (802.11a/ac/n) in three axes. Besides, We have tested the single antenna transmit mode and the dual antenna emission mode. The worst emissions are reflected in the following plots.

5. The radiation emissions from 9kHz-30MHz is not reported, because the test values lower than the limits of 20dB.

6. The average measurement was not performed when peak measured data under the limit of average detection.

Below 1G



ACCURATE TECHNOLOGY CO., LTD.

F1,Bldg,A,Changyuan New Material Port Keyuan Rd,
Science & Industry Park,Nanshan Shenzhen,P.R.China

Site: 2# Chamber

Tel:+86-0755-26503290

Fax:+86-0755-26503396

Job No.: CLN65 XHUA #20	Polarization: Horizontal
Standard: FCC Class B 3M Radiated	Power Source: DC 12V
Test item: Radiation Test	Date: 18/06/25/
Temp.(C)/Hum.(%) 23 C / 48 %	Time: 11/36/47
EUT: UP-Android 7 module	Engineer Signature: WADE
Mode: TX 5180MHz	Distance: 3m
Model: UPA000AN	
Manufacturer: CTOUCH Europe B.V.	

Note: Report NO.:ATE20180786

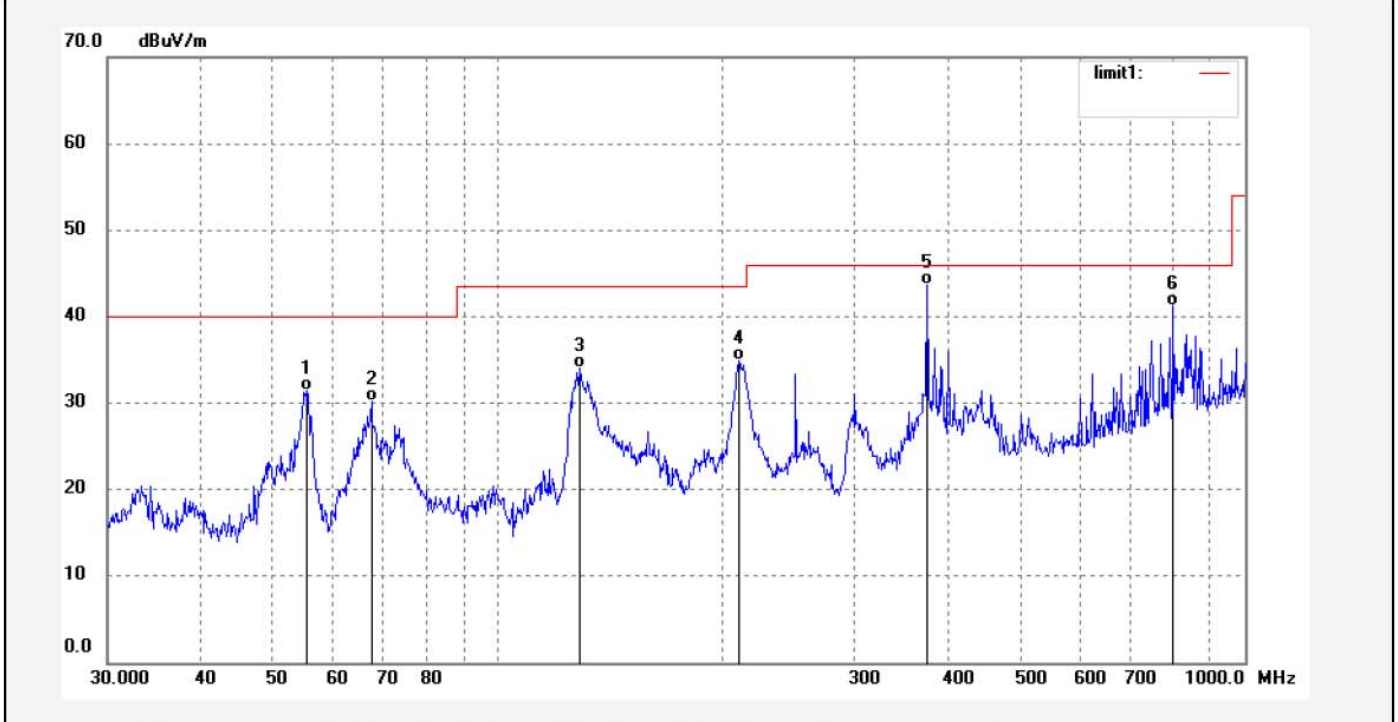

No.	Freq. (MHz)	Reading (dBuV/m)	Factor (dB)	Result (dBuV/m)	Limit (dBuV/m)	Margin (dB)	Detector	Height (cm)	Degree (deg.)	Remark
1	55.4147	44.44	-13.03	31.41	40.00	-8.59	QP	100	318	
2	67.6751	46.10	-15.89	30.21	40.00	-9.79	QP	100	131	
3	128.5629	47.78	-13.72	34.06	43.50	-9.44	QP	100	32	
4	210.0482	46.85	-11.99	34.86	43.50	-8.64	QP	100	319	
5	375.9384	50.77	-7.06	43.71	46.00	-2.29	QP	100	312	
6	801.7862	40.39	0.87	41.26	46.00	-4.74	QP	100	179	

Job No.: CLN65 XHUA #19
 Standard: FCC Class B 3M Radiated
 Test item: Radiation Test
 Temp.(C)/Hum.(%) 23 C / 48 %
 EUT: UP-Android 7 module
 Mode: TX 5180MHz
 Model: UPA000AN
 Manufacturer: CTOUCH Europe B.V.

Polarization: Vertical
 Power Source: DC 12V
 Date: 18/06/25/
 Time: 11/36/01
 Engineer Signature: WADE
 Distance: 3m

Note: Report NO.:ATE20180786

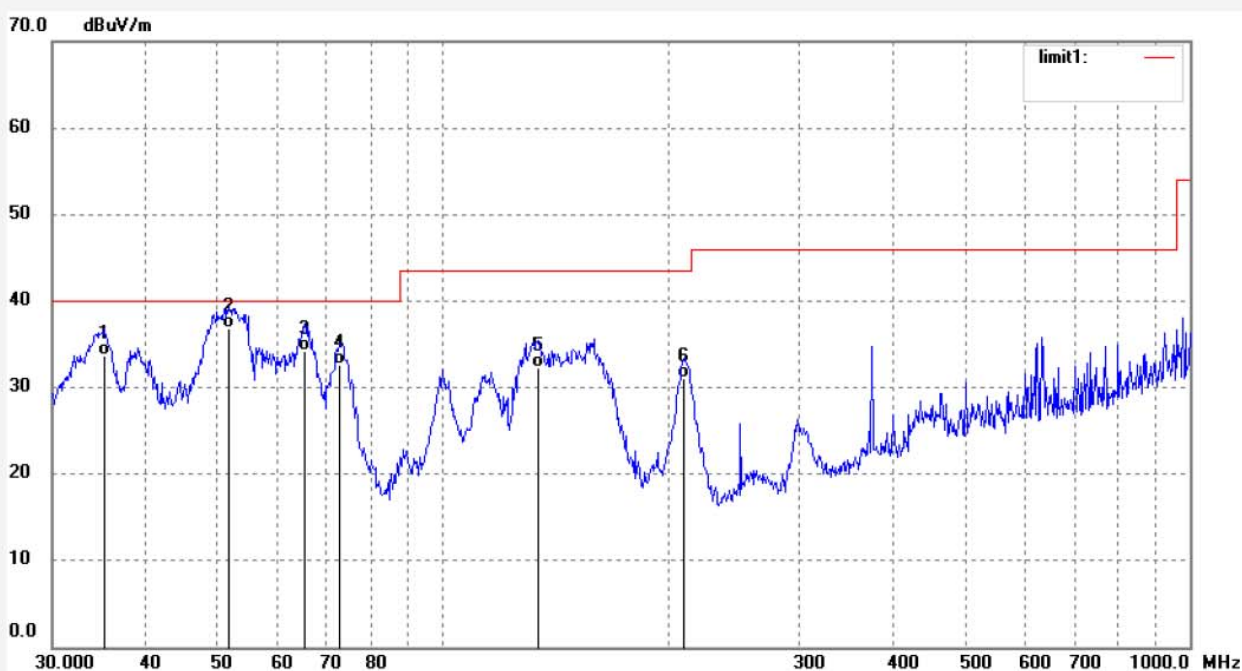

No.	Freq. (MHz)	Reading (dBuV/m)	Factor (dB)	Result (dBuV/m)	Limit (dBuV/m)	Margin (dB)	Detector	Height (cm)	Degree (deg.)	Remark
1	35.2511	44.10	-10.47	33.63	40.00	-6.37	QP	100	198	
2	51.6615	49.54	-12.71	36.83	40.00	-3.17	QP	100	219	
3	65.3431	50.00	-15.72	34.28	40.00	-5.72	QP	100	275	
4	72.5916	49.00	-16.40	32.60	40.00	-7.40	QP	100	31	
5	134.0882	46.23	-13.92	32.31	43.50	-11.19	QP	100	320	
6	210.0482	43.08	-11.99	31.09	43.50	-12.41	QP	100	147	

Job No.: CLN65 XHUA #21
 Standard: FCC Class B 3M Radiated
 Test item: Radiation Test
 Temp.(C)/Hum.(%) 23 C / 48 %
 EUT: UP-Android 7 module
 Mode: TX 5240MHz
 Model: UPA000AN
 Manufacturer: CTOUCH Europe B.V.

Polarization: Horizontal
 Power Source: DC 12V
 Date: 18/06/25/
 Time: 11/37/40
 Engineer Signature: WADE
 Distance: 3m

Note: Report NO.:ATE20180786

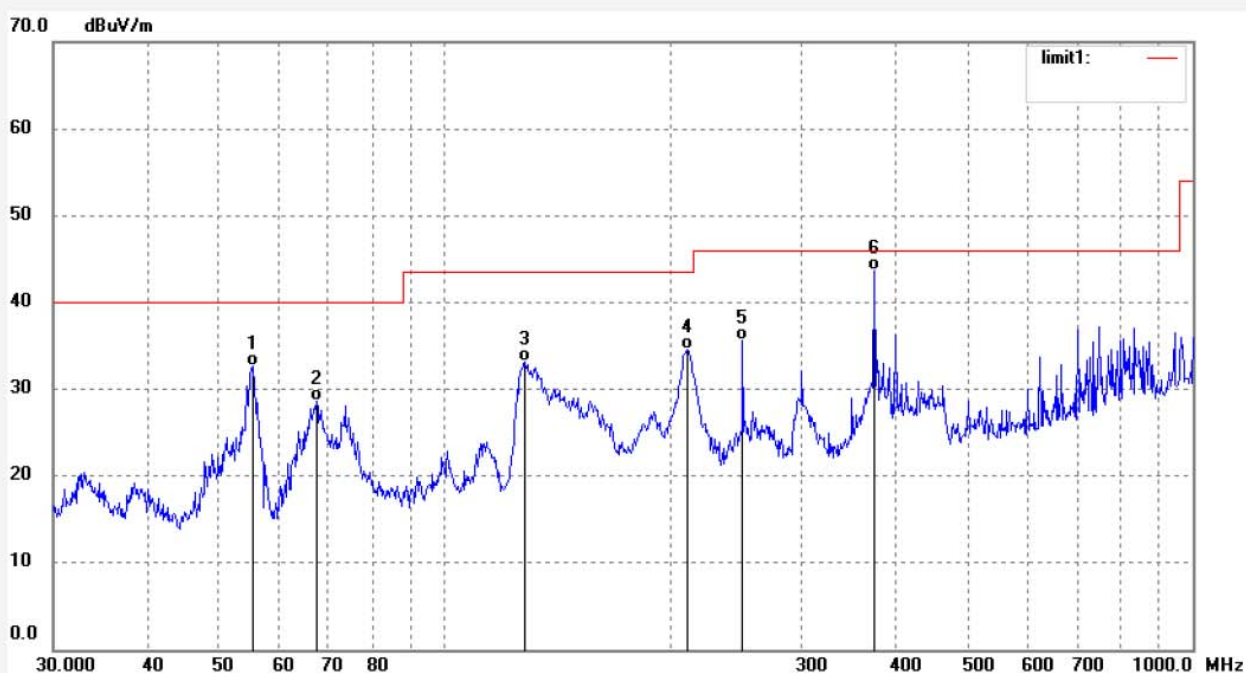

No.	Freq. (MHz)	Reading (dBuV/m)	Factor (dB)	Result (dBuV/m)	Limit (dBuV/m)	Margin (dB)	Detector	Height (cm)	Degree (deg.)	Remark
1	55.4147	45.65	-13.03	32.62	40.00	-7.38	QP	100	319	
2	67.4381	44.48	-15.87	28.61	40.00	-11.39	QP	100	334	
3	128.1129	46.84	-13.71	33.13	43.50	-10.37	QP	100	131	
4	211.5264	46.41	-11.90	34.51	43.50	-8.99	QP	100	210	
5	250.3011	46.11	-10.54	35.57	46.00	-10.43	QP	100	310	
6	375.9384	50.76	-7.06	43.70	46.00	-2.30	QP	100	192	



ACCURATE TECHNOLOGY CO., LTD.

F1,Bldg,A,Changyuan New Material Port Keyuan Rd,
Science & Industry Park,Nanshan Shenzhen,P.R.China

Site: 2# Chamber
Tel:+86-0755-26503290
Fax:+86-0755-26503396

Job No.: CLN65 XHUA #22
Standard: FCC Class B 3M Radiated
Test item: Radiation Test
Temp.(C)/Hum.(%) 23 C / 48 %
EUT: UP-Android 7 module
Mode: TX 5240MHz
Model: UPA000AN
Manufacturer: CTOUCH Europe B.V.

Polarization: Vertical
Power Source: DC 12V
Date: 18/06/25/
Time: 11/38/30
Engineer Signature: WADE
Distance: 3m

Note: Report NO.:ATE20180786

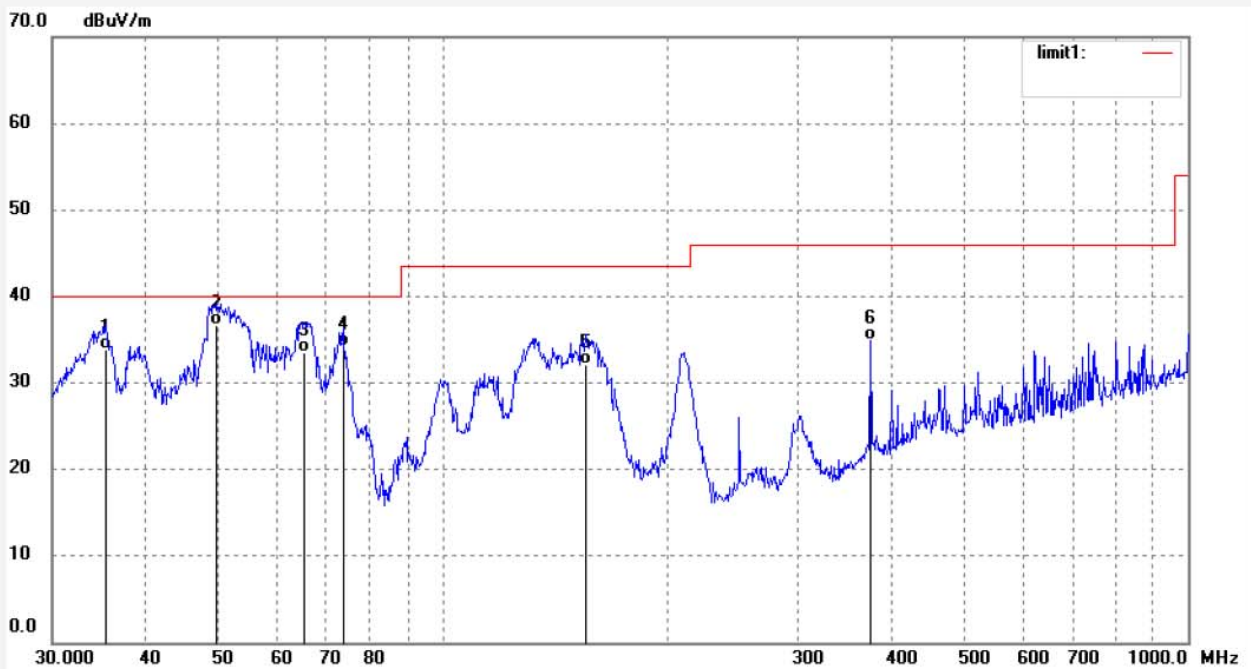

No.	Freq. (MHz)	Reading (dBuV/m)	Factor (dB)	Result (dBuV/m)	Limit (dBuV/m)	Margin (dB)	Detector	Height (cm)	Degree (deg.)	Remark
1	35.3750	44.40	-10.49	33.91	40.00	-6.09	QP	100	319	
2	49.7068	49.20	-12.59	36.61	40.00	-3.39	QP	100	137	
3	65.3431	49.23	-15.72	33.51	40.00	-6.49	QP	100	316	
4	73.6170	50.70	-16.54	34.16	40.00	-5.84	QP	100	131	
5	155.9100	47.02	-14.87	32.15	43.50	-11.35	QP	100	126	
6	375.9384	41.89	-7.06	34.83	46.00	-11.17	QP	100	127	

ACCURATE TECHNOLOGY CO., LTD.

 F1,Bldg,A,Changyuan New Material Port Keyuan Rd,
 Science & Industry Park,Nanshan Shenzhen,P.R.China

Site: 2# Chamber

Tel:+86-0755-26503290

Fax:+86-0755-26503396

 Job No.: CLN65 XHUA #24
 Standard: FCC Class B 3M Radiated
 Test item: Radiation Test
 Temp.(C)/Hum.(%) 23 C / 48 %
 EUT: UP-Android 7 module
 Mode: TX 5500MHz
 Model: UPA000AN
 Manufacturer: CTOUCH Europe B.V.

 Polarization: Horizontal
 Power Source: DC 12V
 Date: 18/06/25/
 Time: 11/40/07
 Engineer Signature: WADE
 Distance: 3m

Note: Report NO.:ATE20180786

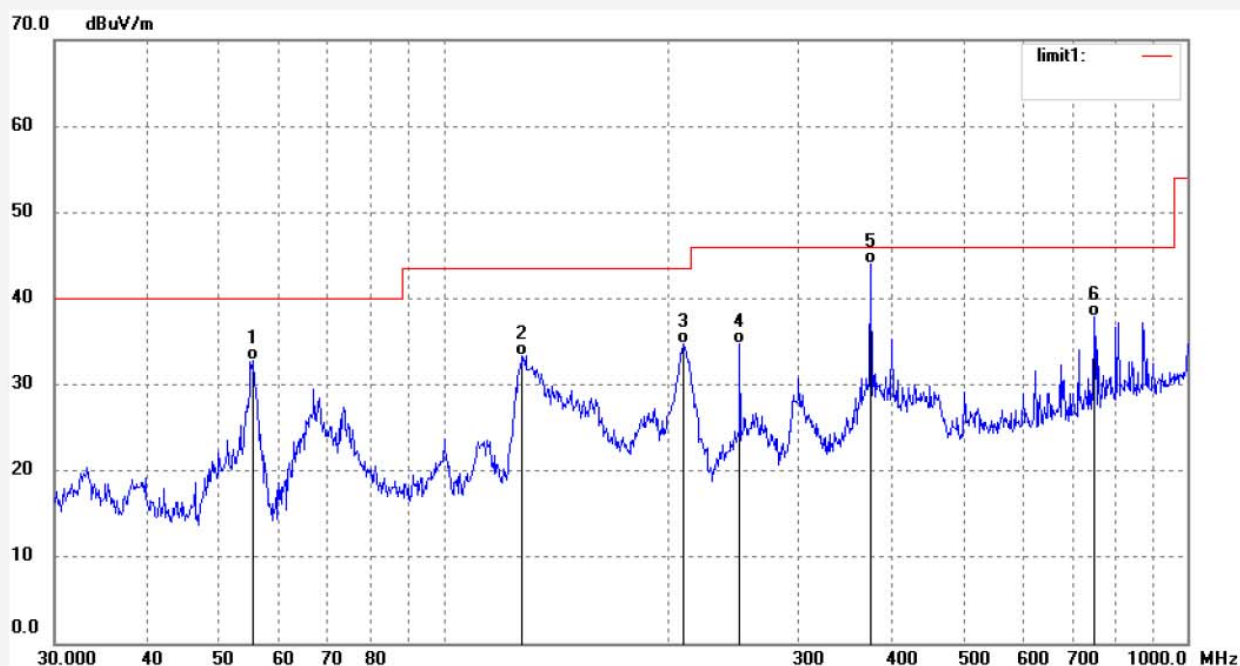

No.	Freq. (MHz)	Reading (dBuV/m)	Factor (dB)	Result (dBuV/m)	Limit (dBuV/m)	Margin (dB)	Detector	Height (cm)	Degree (deg.)	Remark
1	55.4147	45.88	-13.03	32.85	40.00	-7.15	QP	100	237	
2	127.6645	47.08	-13.70	33.38	43.50	-10.12	QP	100	119	
3	210.0482	46.73	-11.99	34.74	43.50	-8.76	QP	100	322	
4	250.3011	45.20	-10.54	34.66	46.00	-11.34	QP	100	146	
5	374.6225	51.10	-7.08	44.02	46.00	-1.98	QP	100	329	
6	750.1082	38.26	-0.29	37.97	46.00	-8.03	QP	100	148	



ACCURATE TECHNOLOGY CO., LTD.

F1,Bldg,A,Changyuan New Material Port Keyuan Rd,
Science & Industry Park,Nanshan Shenzhen,P.R.China

Site: 2# Chamber

Tel:+86-0755-26503290

Fax:+86-0755-26503396

Job No.: CLN65 XHUA #23	Polarization: Vertical
Standard: FCC Class B 3M Radiated	Power Source: DC 12V
Test item: Radiation Test	Date: 18/06/25/
Temp.(C)/Hum.(%) 23 C / 48 %	Time: 11/39/23
EUT: UP-Android 7 module	Engineer Signature: WADE
Mode: TX 5500MHz	Distance: 3m
Model: UPA000AN	
Manufacturer: CTOUCH Europe B.V.	

Note: Report NO.:ATE20180786

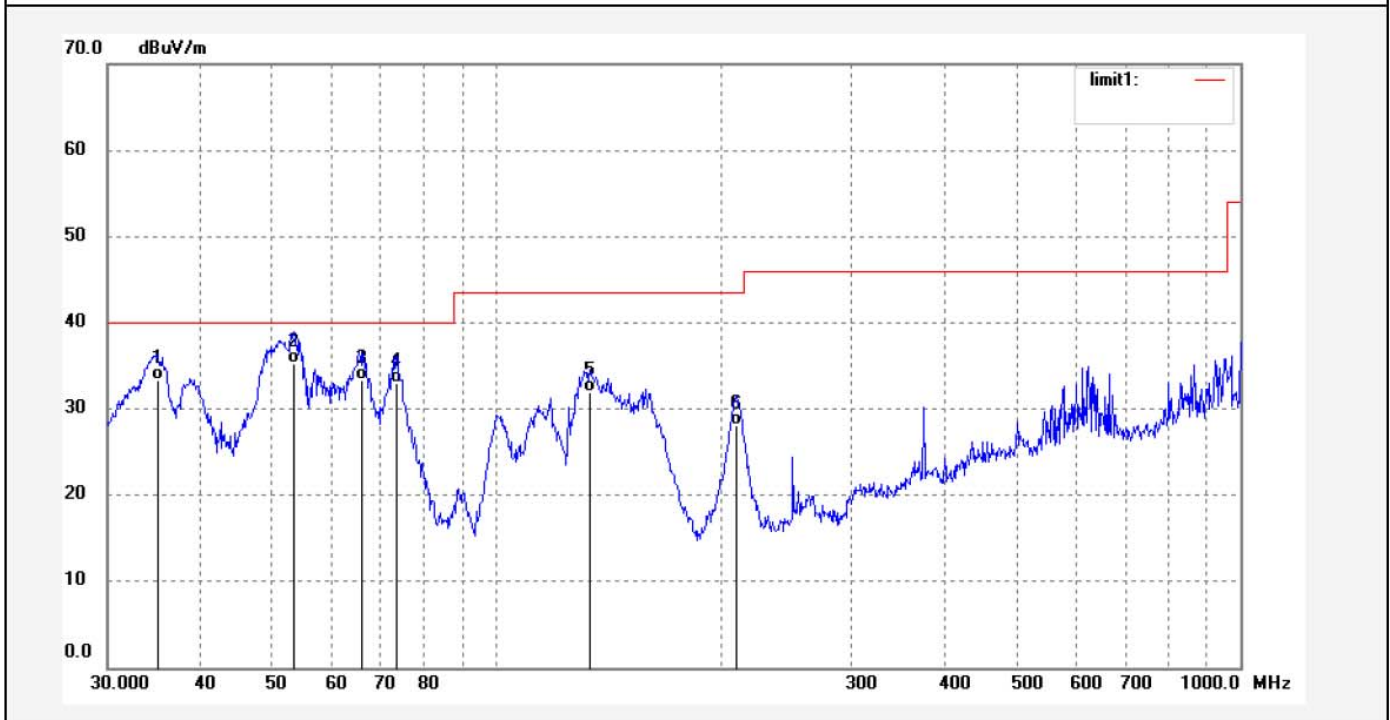

No.	Freq. (MHz)	Reading (dBuV/m)	Factor (dB)	Result (dBuV/m)	Limit (dBuV/m)	Margin (dB)	Detector	Height (cm)	Degree (deg.)	Remark
1	35.0048	43.69	-10.41	33.28	40.00	-6.72	QP	100	28	
2	53.3179	48.10	-12.83	35.27	40.00	-4.73	QP	100	148	
3	66.0341	49.14	-15.77	33.37	40.00	-6.63	QP	100	249	
4	73.3593	49.52	-16.51	33.01	40.00	-6.99	QP	100	193	
5	133.6187	45.87	-13.91	31.96	43.50	-11.54	QP	100	243	
6	210.0482	40.10	-11.99	28.11	43.50	-15.39	QP	100	147	



ACCURATE TECHNOLOGY CO., LTD.

F1,Bldg,A,Changyuan New Material Port Keyuan Rd,
Science & Industry Park,Nanshan Shenzhen,P.R.China

Site: 2# Chamber

Tel:+86-0755-26503290

Fax:+86-0755-26503396

Job No.: CLN65 XHUA #25
Standard: FCC Class B 3M Radiated
Test item: Radiation Test
Temp.(C)/Hum.(%) 23 C / 48 %
EUT: UP-Android 7 module
Mode: TX 5700MHz
Model: UPA000AN
Manufacturer: CTOUCH Europe B.V.

Polarization: Horizontal
Power Source: DC 12V
Date: 18/06/25/
Time: 11/41/04
Engineer Signature: WADE
Distance: 3m

Note: Report NO.:ATE20180786

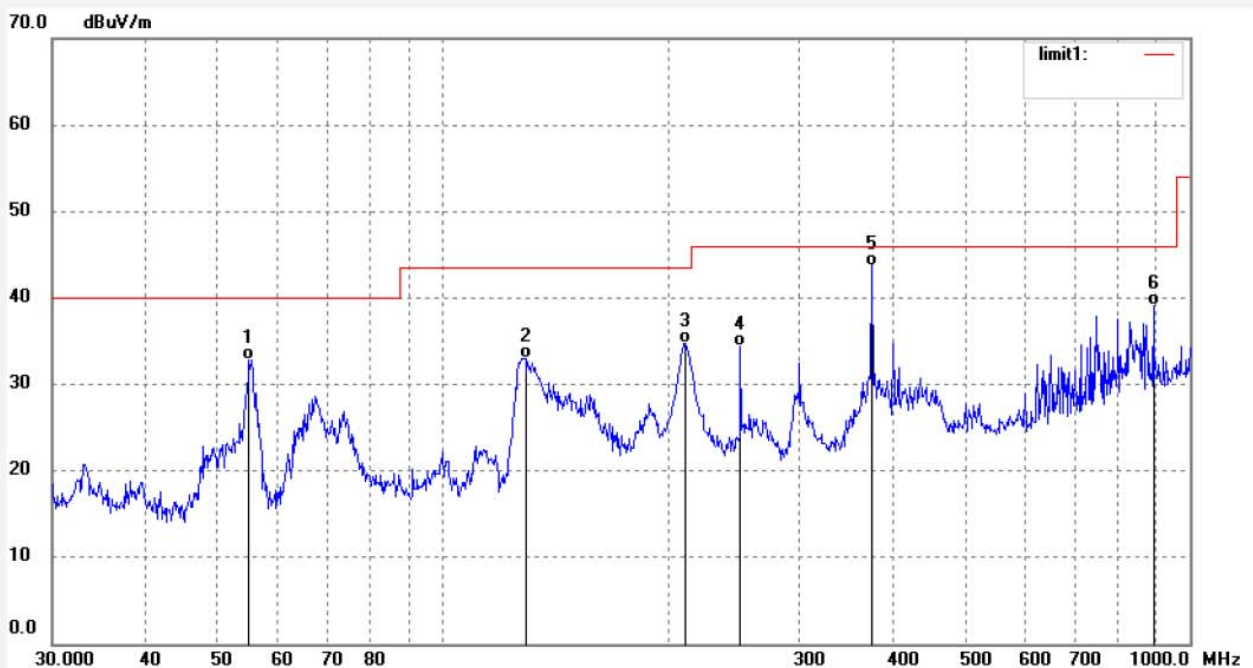

No.	Freq. (MHz)	Reading (dBuV/m)	Factor (dB)	Result (dBuV/m)	Limit (dBuV/m)	Margin (dB)	Detector	Height (cm)	Degree (deg.)	Remark
1	55.0274	45.83	-12.95	32.88	40.00	-7.12	QP	100	318	
2	129.0146	46.73	-13.74	32.99	43.50	-10.51	QP	100	283	
3	211.5264	46.59	-11.90	34.69	43.50	-8.81	QP	100	228	
4	250.3011	44.95	-10.54	34.41	46.00	-11.59	QP	100	290	
5	375.9384	50.81	-7.06	43.75	46.00	-2.25	QP	100	139	
6	893.8567	36.93	2.15	39.08	46.00	-6.92	QP	100	312	



ACCURATE TECHNOLOGY CO., LTD.

F1,Bldg,A,Changyuan New Material Port Keyuan Rd,
Science & Industry Park,Nanshan Shenzhen,P.R.China

Site: 2# Chamber

Tel:+86-0755-26503290

Fax:+86-0755-26503396

Job No.: CLN65 XHUA #26
Standard: FCC Class B 3M Radiated
Test item: Radiation Test
Temp.(C)/Hum.(%) 23 C / 48 %
EUT: UP-Android 7 module
Mode: TX 5700MHz
Model: UPA000AN
Manufacturer: CTOUCH Europe B.V.

Polarization: Vertical
Power Source: DC 12V
Date: 18/06/25/
Time: 11/41/55
Engineer Signature: WADE
Distance: 3m

Note: Report NO.:ATE20180786

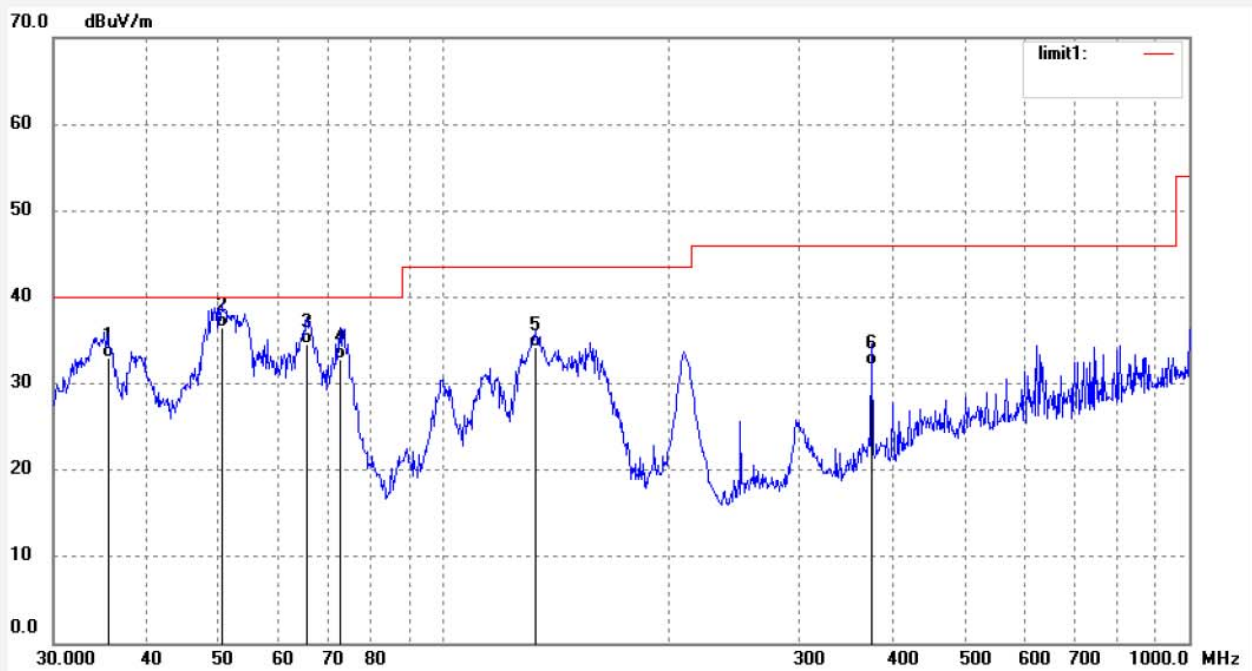

No.	Freq. (MHz)	Reading (dBuV/m)	Factor (dB)	Result (dBuV/m)	Limit (dBuV/m)	Margin (dB)	Detector	Height (cm)	Degree (deg.)	Remark
1	35.4992	43.57	-10.52	33.05	40.00	-6.95	QP	100	192	
2	50.4089	49.14	-12.62	36.52	40.00	-3.48	QP	100	319	
3	65.5726	50.25	-15.73	34.52	40.00	-5.48	QP	100	239	
4	72.5916	49.14	-16.40	32.74	40.00	-7.26	QP	100	192	
5	132.6850	48.00	-13.87	34.13	43.50	-9.37	QP	100	232	
6	375.9384	39.14	-7.06	32.08	46.00	-13.92	QP	100	298	

Job No.: CLN65 XHUA #28
 Standard: FCC Class B 3M Radiated
 Test item: Radiation Test
 Temp.(C)/Hum.(%) 23 C / 48 %
 EUT: UP-Android 7 module
 Mode: TX 5745MHz
 Model: UPA000AN
 Manufacturer: CTOUCH Europe B.V.

Polarization: Horizontal
 Power Source: DC 12V
 Date: 18/06/25/
 Time: 11/43/50
 Engineer Signature: WADE
 Distance: 3m

Note: Report NO.:ATE20180786

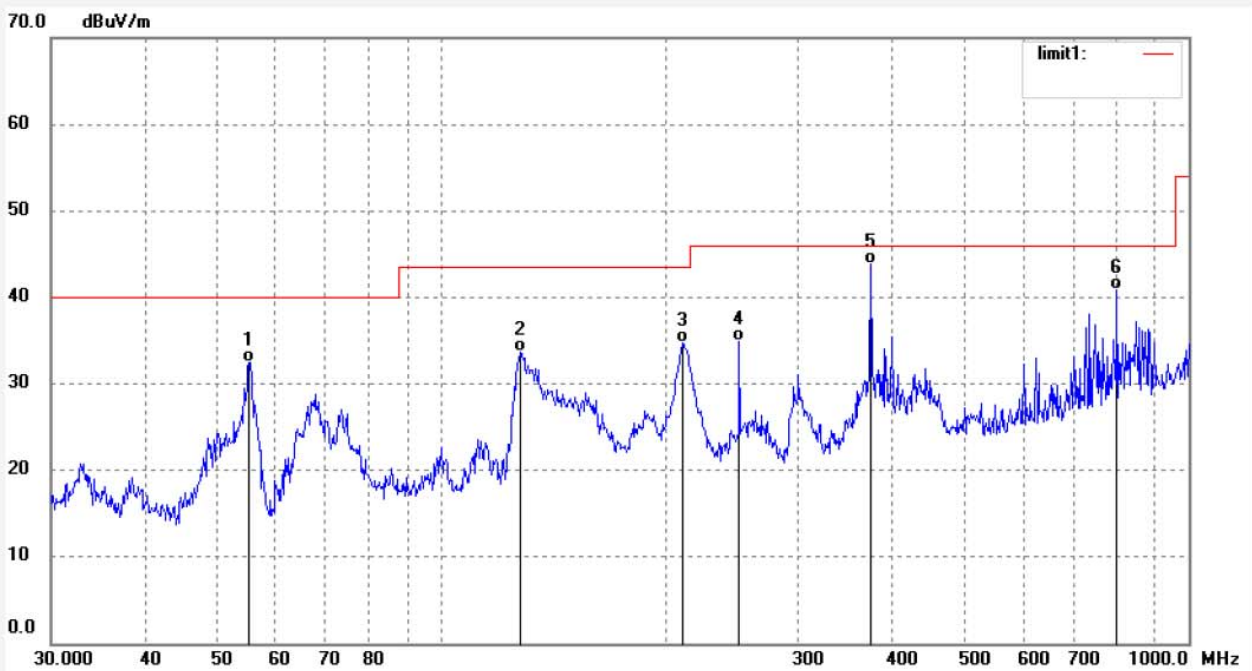

No.	Freq. (MHz)	Reading (dBuV/m)	Factor (dB)	Result (dBuV/m)	Limit (dBuV/m)	Margin (dB)	Detector	Height (cm)	Degree (deg.)	Remark
1	55.2207	45.52	-12.99	32.53	40.00	-7.47	QP	100	321	
2	127.2176	47.43	-13.69	33.74	43.50	-9.76	QP	100	310	
3	210.0482	46.72	-11.99	34.73	43.50	-8.77	QP	100	127	
4	250.3011	45.44	-10.54	34.90	46.00	-11.10	QP	100	290	
5	375.9384	50.96	-7.06	43.90	46.00	-2.10	QP	100	223	
6	801.7862	40.01	0.87	40.88	46.00	-5.12	QP	100	328	



ACCURATE TECHNOLOGY CO., LTD.

F1,Bldg,A,Changyuan New Material Port Keyuan Rd,
Science & Industry Park,Nanshan Shenzhen,P.R.China

Site: 2# Chamber

Tel:+86-0755-26503290

Fax:+86-0755-26503396

Job No.: CLN65 XHUA #27
Standard: FCC Class B 3M Radiated
Test item: Radiation Test
Temp.(C)/Hum.(%) 23 C / 48 %
EUT: UP-Android 7 module
Mode: TX 5745MHz
Model: UPA000AN
Manufacturer: CTOUCH Europe B.V.

Polarization: Vertical
Power Source: DC 12V
Date: 18/06/25/
Time: 11/42/56
Engineer Signature: WADE
Distance: 3m

Note: Report NO.:ATE20180786

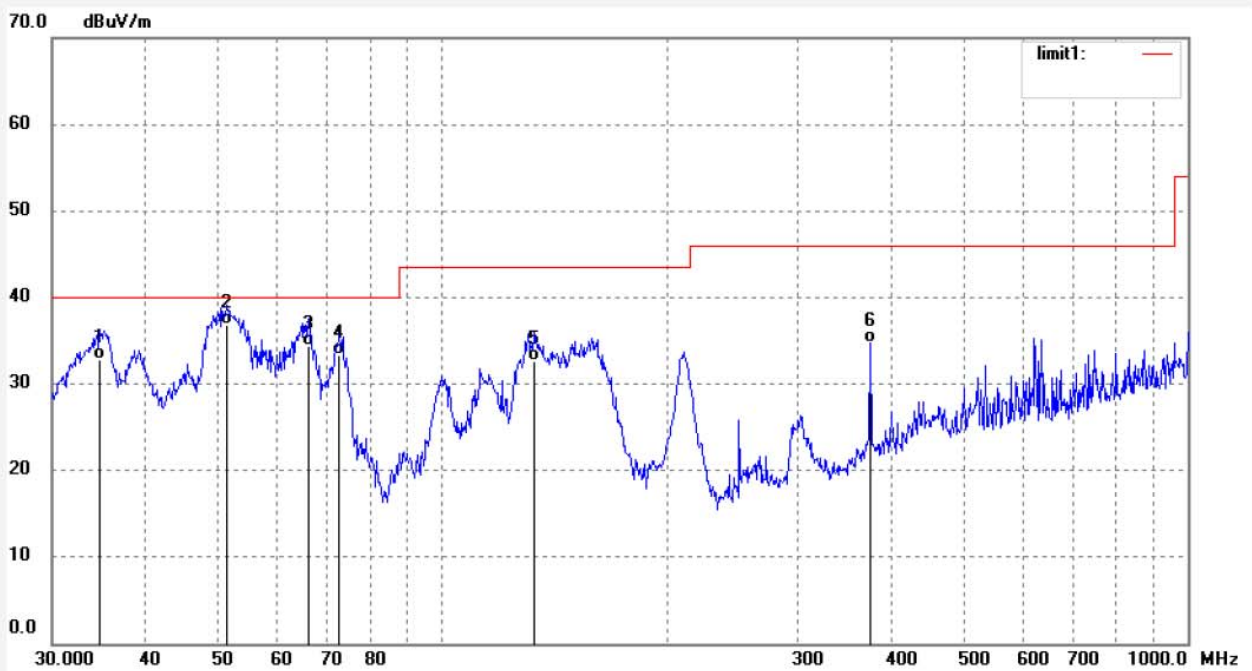

No.	Freq. (MHz)	Reading (dBuV/m)	Factor (dB)	Result (dBuV/m)	Limit (dBuV/m)	Margin (dB)	Detector	Height (cm)	Degree (deg.)	Remark
1	34.7601	43.10	-10.34	32.76	40.00	-7.24	QP	100	312	
2	51.4806	49.50	-12.69	36.81	40.00	-3.19	QP	100	238	
3	66.2661	50.10	-15.79	34.31	40.00	-5.69	QP	100	167	
4	72.8465	49.77	-16.44	33.33	40.00	-6.67	QP	100	65	
5	133.1511	46.57	-13.89	32.68	43.50	-10.82	QP	100	319	
6	375.9384	41.78	-7.06	34.72	46.00	-11.28	QP	100	323	



ACCURATE TECHNOLOGY CO., LTD.

F1,Bldg,A,Changyuan New Material Port Keyuan Rd,
Science & Industry Park,Nanshan Shenzhen,P.R.China

Site: 2# Chamber

Tel:+86-0755-26503290

Fax:+86-0755-26503396

Job No.: CLN65 XHUA #29
Standard: FCC Class B 3M Radiated
Test item: Radiation Test
Temp.(C)/Hum.(%) 23 C / 48 %
EUT: UP-Android 7 module
Mode: TX 5825MHz
Model: UPA000AN
Manufacturer:CTOUCH Europe B.V.

Polarization: Horizontal
Power Source: DC 12V
Date: 18/06/25/
Time: 11/44/42
Engineer Signature: WADE
Distance: 3m

Note: Report NO.:ATE20180786

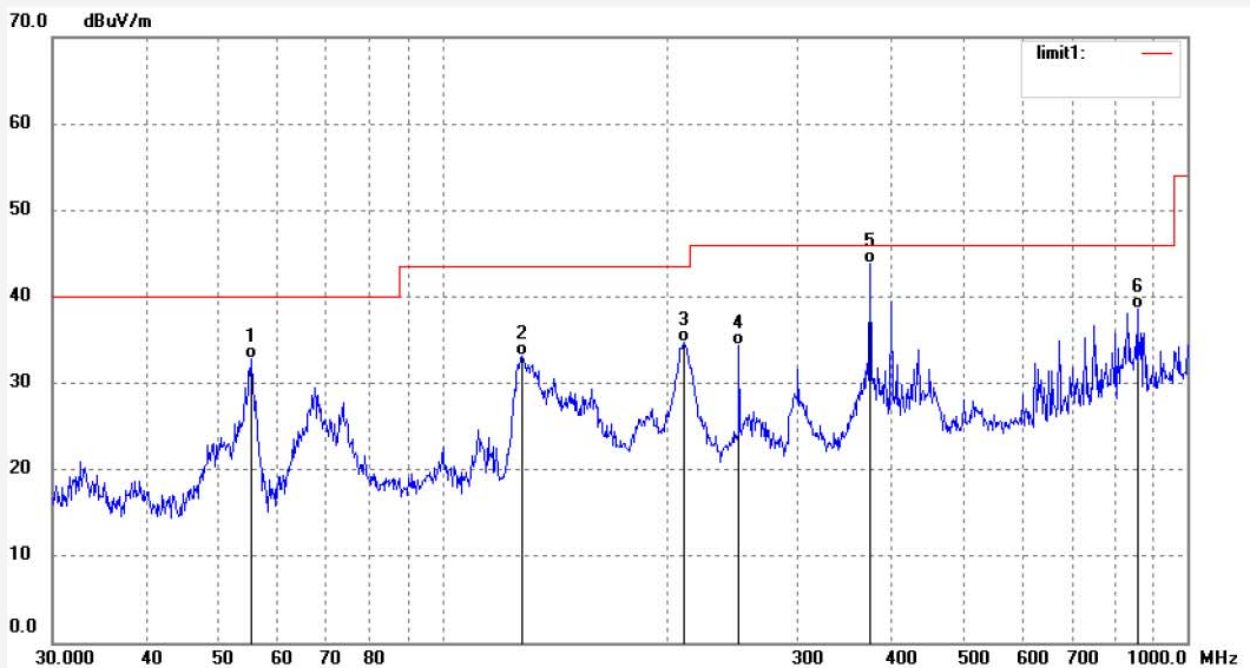

No.	Freq. (MHz)	Reading (dBuV/m)	Factor (dB)	Result (dBuV/m)	Limit (dBuV/m)	Margin (dB)	Detector	Height (cm)	Degree (deg.)	Remark
1	55.4147	45.84	-13.03	32.81	40.00	-7.19	QP	100	129	
2	128.1129	46.87	-13.71	33.16	43.50	-10.34	QP	100	292	
3	210.7860	46.61	-11.94	34.67	43.50	-8.83	QP	100	84	
4	250.3011	44.92	-10.54	34.38	46.00	-11.62	QP	100	41	
5	375.9384	50.97	-7.06	43.91	46.00	-2.09	QP	100	57	
6	857.0247	36.87	1.65	38.52	46.00	-7.48	QP	100	311	

Job No.: CLN65 XHUA #30
 Standard: FCC Class B 3M Radiated
 Test item: Radiation Test
 Temp.(C)/Hum.(%) 23 C / 48 %
 EUT: UP-Android 7 module
 Mode: TX 5825MHz
 Model: UPA000AN
 Manufacturer:CTOUCH Europe B.V.

Polarization: Vertical
 Power Source: DC 12V
 Date: 18/06/25/
 Time: 11/45/37
 Engineer Signature: WADE
 Distance: 3m

Note: Report NO.:ATE20180786



No.	Freq. (MHz)	Reading (dBuV/m)	Factor (dB)	Result (dBuV/m)	Limit (dBuV/m)	Margin (dB)	Detector	Height (cm)	Degree (deg.)	Remark
1	34.7602	43.70	-10.34	33.36	40.00	-6.64	QP	100	327	
2	51.3005	49.25	-12.68	36.57	40.00	-3.43	QP	100	316	
3	66.0342	49.70	-15.77	33.93	40.00	-6.07	QP	100	239	
4	72.8466	49.25	-16.44	32.81	40.00	-7.19	QP	100	42	
5	133.6188	48.00	-13.91	34.09	43.50	-9.41	QP	100	329	
6	210.0482	45.71	-11.99	33.72	43.50	-9.78	QP	100	165	

Above 1G(1G-26.5GHz)

802.11A(20MHz) TX Mode:

Indicated		Detector (PK/AV)	Table Angle Degree	Antenna		Correction Factor			FCC Part 15.407			
Frequency (MHz)	Receiver Reading (dBμV)			Height (m)	Polar (H/V)	Ant. Factor (dB/m)	Cable Loss (dB)	Pre-Amp. Gain (dB)	Cord. Amp. (dBμV/m)	Limit (dBμV/m)	Margin (dB)	Comment
Channel 36 (5180 MHz)												
10360	39.75	AV	128	1.5	V	31.2	4.3	26.7	48.55	54	5.45	harmonic
10360	38.12	AV	15	1.5	H	31.2	4.3	26.7	46.92	54	7.08	harmonic
10360	52.81	PK	128	1.5	V	31.2	4.3	26.7	61.61	74	12.39	harmonic
10360	51.98	PK	15	1.5	H	31.2	4.3	26.7	60.78	74	13.22	harmonic
Channel 48 (5240 MHz)												
10480	39.72	AV	310	1.5	V	31.2	4.3	26.7	48.52	54	5.48	harmonic
10480	37.15	AV	10	1.5	H	31.2	4.3	26.7	45.95	54	8.05	harmonic
10480	52.13	PK	310	1.5	V	31.2	4.3	26.7	60.93	74	13.07	harmonic
10480	51.53	PK	10	1.5	H	31.2	4.3	26.7	60.33	74	13.67	harmonic
Channel 149 (5745 MHz)												
11490	36.41	AV	125	1.5	V	31.9	4.4	26.6	46.11	54	7.89	harmonic
11490	36.24	AV	130	1.5	H	31.9	4.4	26.6	45.94	54	8.06	harmonic
11490	50.22	PK	125	1.5	V	31.9	4.4	26.6	59.92	74	14.08	harmonic
11490	49.42	PK	130	1.5	H	31.9	4.4	26.6	59.12	74	14.88	harmonic
Channel 165 (5825 MHz)												
11650	37.41	AV	25	1.5	V	31.9	4.4	26.6	47.11	54	6.89	harmonic
11650	37.24	AV	125	1.5	H	31.9	4.4	26.6	46.94	54	7.06	harmonic
11650	51.22	PK	25	1.5	V	31.9	4.4	26.6	60.92	74	13.08	harmonic
11650	50.42	PK	125	1.5	H	31.9	4.4	26.6	60.12	74	13.88	harmonic

802.11N(20MHz) TX Mode:

Indicated		Detector (PK/AV)	Table Angle Degree	Antenna		Correction Factor			FCC Part 15.407			
Frequency (MHz)	Receiver Reading (dBμV)			Height (m)	Polar (H/V)	Ant. Factor (dB/m)	Cable Loss (dB)	Pre-Amp. Gain (dB)	Cord. Amp. (dBμV/m)	Limit (dBμV/m)	Margin (dB)	Comment
Channel 36 (5180 MHz)												
10360	38.13	AV	146	1.5	V	31.2	4.3	26.7	46.93	54	7.07	harmonic
10360	37.64	AV	127	1.5	H	31.2	4.3	26.7	46.44	54	7.56	harmonic
10360	51.06	PK	146	1.5	V	31.2	4.3	26.7	59.86	74	14.14	harmonic
10360	50.48	PK	127	1.5	H	31.2	4.3	26.7	59.28	74	14.72	harmonic
Channel 48 (5240 MHz)												
10480	37.13	AV	330	1.5	V	31.2	4.3	26.7	45.93	54	8.07	harmonic
10480	36.87	AV	109	1.5	H	31.2	4.3	26.7	45.67	54	8.33	harmonic
10480	50.18	PK	330	1.5	V	31.2	4.3	26.7	58.98	74	15.02	harmonic
10480	49.32	PK	109	1.5	H	31.2	4.3	26.7	58.12	74	15.88	harmonic
Channel 149 (5745 MHz)												
11490	35.56	AV	167	1.5	V	31.9	4.4	26.6	45.26	54	8.74	harmonic
11490	37.10	AV	192	1.5	H	31.9	4.4	26.6	46.80	54	7.20	harmonic
11490	49.56	PK	167	1.5	V	31.9	4.4	26.6	59.26	74	14.74	harmonic
11490	48.45	PK	192	1.5	H	31.9	4.4	26.6	58.15	74	15.85	harmonic
Channel 165 (5825 MHz)												
11650	36.17	AV	225	1.5	V	31.9	4.4	26.6	45.87	54	8.13	harmonic
11650	36.78	AV	118	1.5	H	31.9	4.4	26.6	46.48	54	7.52	harmonic
11650	50.83	PK	225	1.5	V	31.9	4.4	26.6	60.53	74	13.47	harmonic
11650	51.02	PK	118	1.5	H	31.9	4.4	26.6	60.72	74	13.28	harmonic

802.11AC(20MHz) TX Mode:

Indicated		Detector (PK/AV)	Table Angle Degree	Antenna		Correction Factor			FCC Part 15.407			
Frequency (MHz)	Receiver Reading (dBμV)			Height (m)	Polar (H/V)	Ant. Factor (dB/m)	Cable Loss (dB)	Pre-Amp. Gain (dB)	Cord. Amp. (dBμV/m)	Limit (dBμV/m)	Margin (dB)	Comment
Channel 36 (5180 MHz)												
10360	38.02	AV	165	1.5	V	31.2	4.3	26.7	46.82	54	7.18	harmonic
10360	37.89	AV	139	1.5	H	31.2	4.3	26.7	46.69	54	7.31	harmonic
10360	50.74	PK	165	1.5	V	31.2	4.3	26.7	59.54	74	14.46	harmonic
10360	51.03	PK	139	1.5	H	31.2	4.3	26.7	59.83	74	14.17	harmonic
Channel 48 (5240 MHz)												
10480	36.75	AV	338	1.5	V	31.2	4.3	26.7	45.55	54	8.45	harmonic
10480	37.03	AV	124	1.5	H	31.2	4.3	26.7	45.83	54	8.17	harmonic
10480	50.63	PK	338	1.5	V	31.2	4.3	26.7	59.43	74	14.57	harmonic
10480	50.07	PK	124	1.5	H	31.2	4.3	26.7	58.87	74	15.13	harmonic
Channel 149 (5745 MHz)												
11490	36.64	AV	29	1.5	V	31.9	4.4	26.6	46.34	54	7.66	harmonic
11490	36.18	AV	137	1.5	H	31.9	4.4	26.6	45.88	54	8.12	harmonic
11490	50.36	PK	29	1.5	V	31.9	4.4	26.6	60.06	74	13.94	harmonic
11490	49.65	PK	137	1.5	H	31.9	4.4	26.6	59.35	74	14.65	harmonic
Channel 165 (5825 MHz)												
11650	37.17	AV	267	1.5	V	31.9	4.4	26.6	46.87	54	7.13	harmonic
11650	37.78	AV	172	1.5	H	31.9	4.4	26.6	47.48	54	6.52	harmonic
11650	51.83	PK	267	1.5	V	31.9	4.4	26.6	61.53	74	12.47	harmonic
11650	51.02	PK	172	1.5	H	31.9	4.4	26.6	60.72	74	13.28	harmonic

802.11N(40MHz) TX Mode:

Indicated		Detector (PK/AV)	Table Angle Degree	Antenna		Correction Factor			FCC Part 15.407			
Frequency (MHz)	Receiver Reading (dBμV)			Height (m)	Polar (H/V)	Ant. Factor (dB/m)	Cable Loss (dB)	Pre-Amp. Gain (dB)	Cord. Amp. (dBμV/m)	Limit (dBμV/m)	Margin (dB)	Comment
Channel 38 (5190 MHz)												
10380	40.14	AV	188	1.6	V	31.2	4.3	26.7	48.94	54	5.06	harmonic
10380	39.25	AV	216	1.5	H	31.2	4.3	26.7	48.05	54	5.95	harmonic
10380	51.89	PK	188	1.6	V	31.2	4.3	26.7	60.69	74	13.31	harmonic
10380	51.35	PK	216	1.5	H	31.2	4.3	26.7	60.15	74	13.85	harmonic
Channel 46 (5230 MHz)												
10460	40.16	AV	354	1.6	V	31.2	4.3	26.7	48.96	54	5.04	harmonic
10460	39.53	AV	109	1.5	H	31.2	4.3	26.7	48.33	54	5.67	harmonic
10460	51.51	PK	354	1.6	V	31.2	4.3	26.7	60.31	74	13.69	harmonic
10460	51.26	PK	109	1.5	H	31.2	4.3	26.7	60.06	74	13.94	harmonic
Channel 151 (5755 MHz)												
11510	37.28	AV	146	1.6	V	31.9	4.4	26.6	46.98	54	7.02	harmonic
11510	38.16	AV	138	1.5	H	31.9	4.4	26.6	47.86	54	6.14	harmonic
11510	49.17	PK	146	1.6	V	31.9	4.4	26.6	58.87	74	15.13	harmonic
11510	50.23	PK	138	1.5	H	31.9	4.4	26.6	59.93	74	14.07	harmonic
Channel 159 (5795 MHz)												
11590	37.68	AV	225	1.6	V	31.9	4.4	26.6	47.38	54	6.62	harmonic
11590	37.11	AV	106	1.5	H	31.9	4.4	26.6	46.81	54	7.19	harmonic
11590	50.02	PK	225	1.6	V	31.9	4.4	26.6	59.72	74	14.28	harmonic
11590	49.87	PK	106	1.5	H	31.9	4.4	26.6	59.57	74	14.43	harmonic

802.11AC(40MHz) TX Mode:

Indicated		Detector (PK/AV)	Table Angle Degree	Antenna		Correction Factor			FCC Part 15.407			
Frequency (MHz)	Receiver Reading (dBμV)			Height (m)	Polar (H/V)	Ant. Factor (dB/m)	Cable Loss (dB)	Pre-Amp. Gain (dB)	Cord. Amp. (dBμV/m)	Limit (dBμV/m)	Margin (dB)	Comment
Channel 38 (5190 MHz)												
10380	40.26	AV	162	1.6	V	31.2	4.3	26.7	49.06	54	4.94	harmonic
10380	39.59	AV	229	1.5	H	31.2	4.3	26.7	48.39	54	5.61	harmonic
10380	52.01	PK	161	1.6	V	31.2	4.3	26.7	60.81	74	13.19	harmonic
10380	51.46	PK	229	1.5	H	31.2	4.3	26.7	60.26	74	13.74	harmonic
Channel 46 (5230 MHz)												
10460	41.24	AV	301	1.6	V	31.2	4.3	26.7	50.04	54	3.96	harmonic
10460	40.18	AV	117	1.5	H	31.2	4.3	26.7	48.98	54	5.02	harmonic
10460	51.97	PK	301	1.6	V	31.2	4.3	26.7	60.77	74	13.23	harmonic
10460	50.88	PK	117	1.5	H	31.2	4.3	26.7	59.68	74	14.32	harmonic
Channel 151 (5755 MHz)												
11510	37.34	AV	157	1.6	V	31.9	4.4	26.6	47.04	54	6.96	harmonic
11510	38.08	AV	162	1.5	H	31.9	4.4	26.6	47.78	54	6.22	harmonic
11510	49.11	PK	157	1.6	V	31.9	4.4	26.6	58.81	74	15.19	harmonic
11510	50.05	PK	162	1.5	H	31.9	4.4	26.6	59.75	74	14.25	harmonic
Channel 159 (5795 MHz)												
11590	38.12	AV	229	1.6	V	31.9	4.4	26.6	47.82	54	6.18	harmonic
11590	37.85	AV	137	1.5	H	31.9	4.4	26.6	47.55	54	6.45	harmonic
11590	51.15	PK	229	1.6	V	31.9	4.4	26.6	60.85	74	13.15	harmonic
11590	50.18	PK	137	1.5	H	31.9	4.4	26.6	59.88	74	14.12	harmonic

802.11ac(80MHz) TX Mode:

Indicated		Detector (PK/AV)	Table Angle Degree	Antenna		Correction Factor			FCC Part 15.407			
Frequency (MHz)	Receiver Reading (dBμV)			Height (m)	Polar (H/V)	Ant. Factor (dB/m)	Cable Loss (dB)	Pre-Amp. Gain (dB)	Cord. Amp. (dBμV/m)	Limit (dBμV/m)	Margin (dB)	Comment
Channel 42 (5210 MHz)												
10420	35.47	AV	148	1.6	V	31.2	4.3	26.7	44.27	54	9.73	harmonic
10420	34.19	AV	187	1.5	H	31.2	4.3	26.7	42.99	54	11.01	harmonic
10420	47.12	PK	148	1.6	V	31.2	4.3	26.7	55.92	74	18.08	harmonic
10420	46.63	PK	187	1.5	H	31.2	4.3	26.7	55.43	74	18.57	harmonic
Channel 155 (5775 MHz)												
11550	35.16	AV	126	1.5	V	31.9	4.4	26.6	44.86	54	9.14	harmonic
11550	34.75	AV	32	1.5	H	31.9	4.4	26.6	44.45	54	9.55	harmonic
11550	46.18	PK	126	1.5	V	31.9	4.4	26.6	55.88	74	18.12	harmonic
11550	45.25	PK	32	1.5	H	31.9	4.4	26.6	54.95	74	19.05	harmonic

Test mode: 802.11a,N20,ac TX Frequency: 5180MHz, 5240MHz

The EUT is tested radiation emission at each test mode in three axes. Besides, We have tested the single antenna transmit mode and the dual antenna emission mode. The worst emissions are reflected in the following plots

Common Information

Test Site: SMQ EMC Lab.
Environment Conditions:
Antenna Polarization: Horizontal
Operator Name:
Comment:

Copy of FCC Electric Field Strength 26.5-40GHz

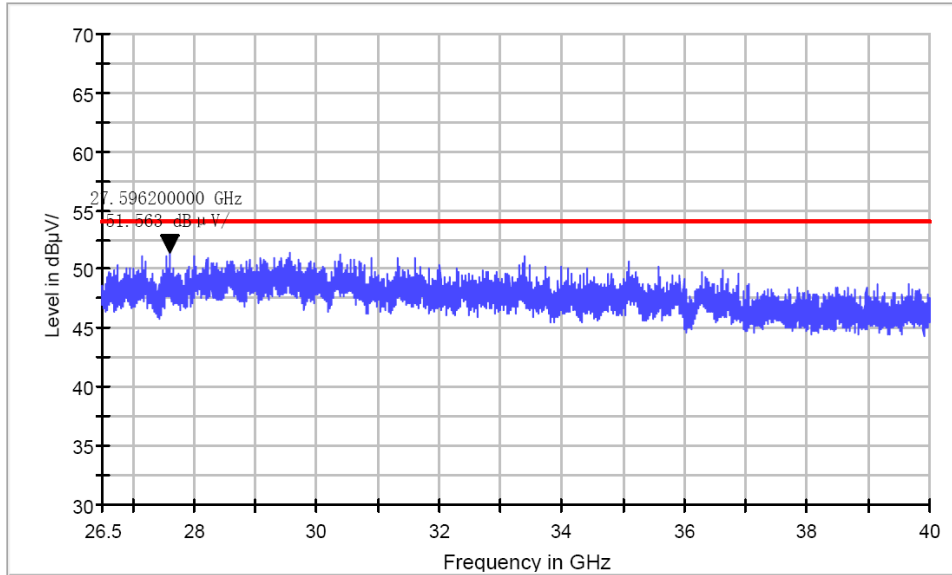

Common Information

Test Site: SMQ EMC Lab.
Environment Conditions:
Antenna Polarization: Vertical
Operator Name:
Comment:

Copy of FCC Electric Field Strength 26.5-40GHz

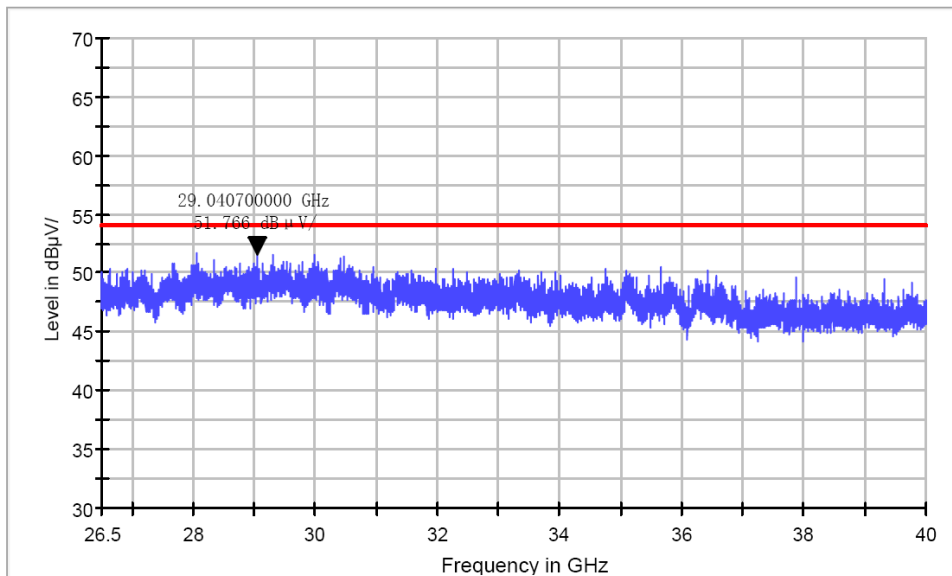

Test mode: 802.11a,N20,ac TX Frequency: 5745MHz, 5825MHz

The EUT is tested radiation emission at each test mode in three axes. Besides, We have tested the single antenna transmit mode and the dual antenna emission mode. The worst emissions are reflected in the following plots

Common Information

Test Site: SMQ EMC Lab.
Environment Conditions:
Antenna Polarization: Horizontal
Operator Name:
Comment:

Copy of FCC Electric Field Strength 26.5-40GHz

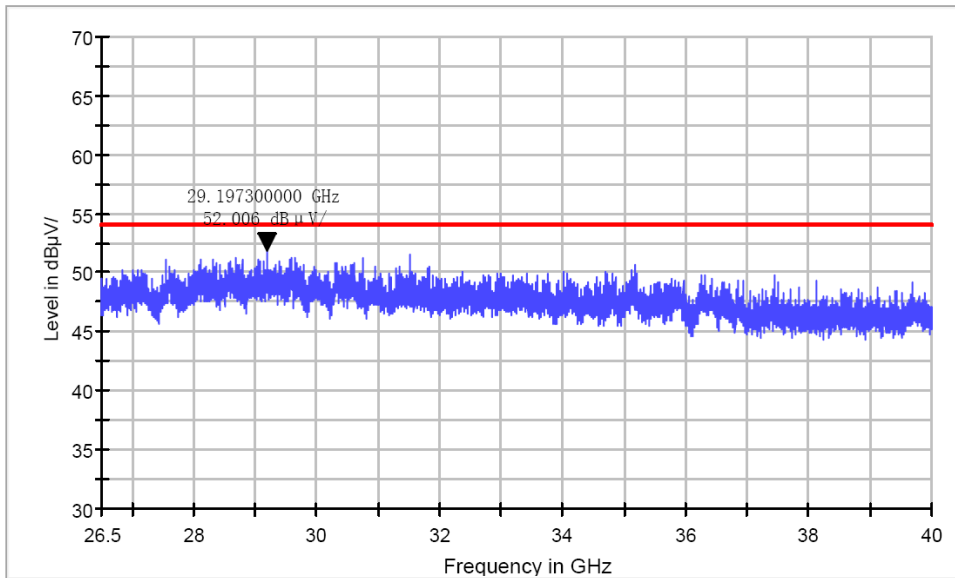

Common Information

Test Site: SMQ EMC Lab.
Environment Conditions:
Antenna Polarization: Vertical
Operator Name:
Comment:

Copy of FCC Electric Field Strength 26.5-40GHz

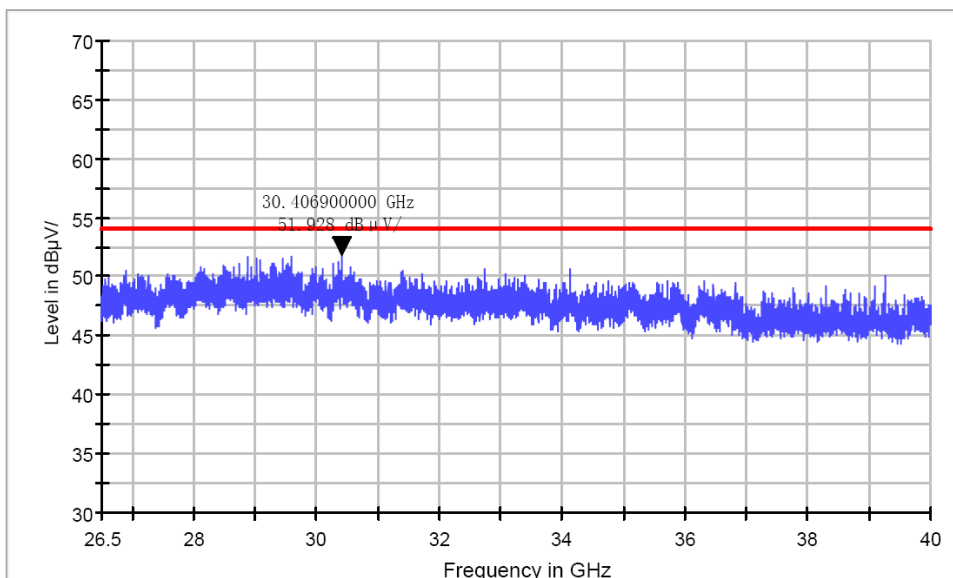

Test mode: 802.11N40, ac TX Frequency: 5190MHz, 5230MHz

The EUT is tested radiation emission at each test mode in three axes. Besides, We have tested the single antenna transmit mode and the dual antenna emission mode. The worst emissions are reflected in the following plots

Common Information

Test Site: SMQ EMC Lab.
Environment Conditions:
Antenna Polarization: Horizontal
Operator Name:
Comment:

Copy of FCC Electric Field Strength 26.5-40GHz

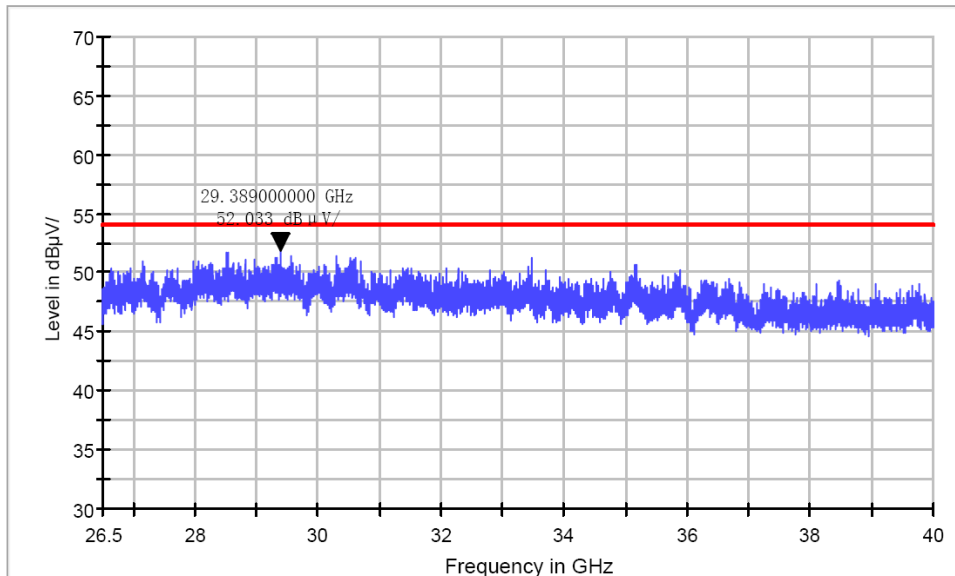

Common Information

Test Site: SMQ EMC Lab.
Environment Conditions:
Antenna Polarization: Vertical
Operator Name:
Comment:

Copy of FCC Electric Field Strength 26.5-40GHz

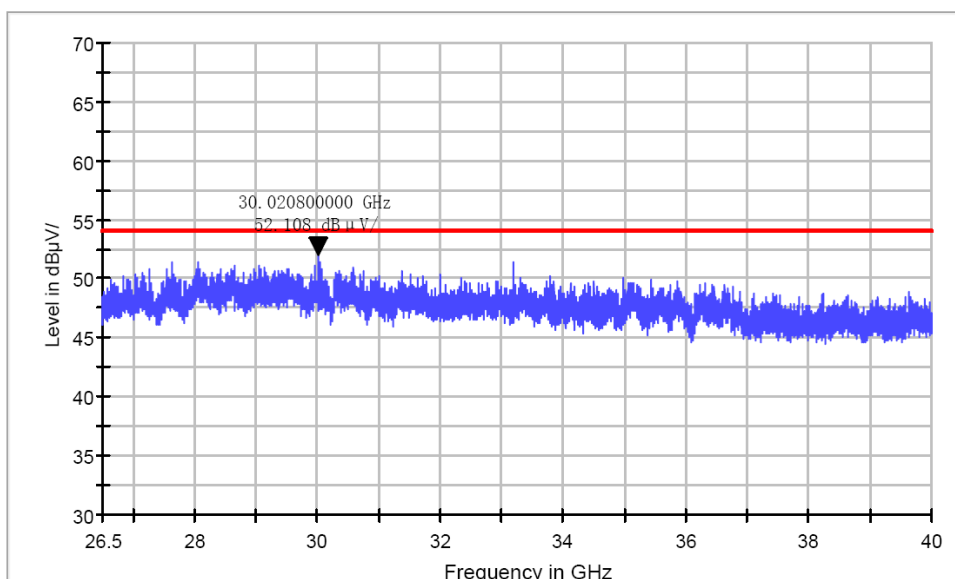

Test mode: 802.11N40, ac TX Frequency: 5755MHz, 5795MHz

The EUT is tested radiation emission at each test mode in three axes. Besides, We have tested the single antenna transmit mode and the dual antenna emission mode. The worst emissions are reflected in the following plots

Common Information

Test Site: SMQ EMC Lab.
Environment Conditions:
Antenna Polarization: Horizontal
Operator Name:
Comment:

Copy of FCC Electric Field Strength 26.5-40GHz

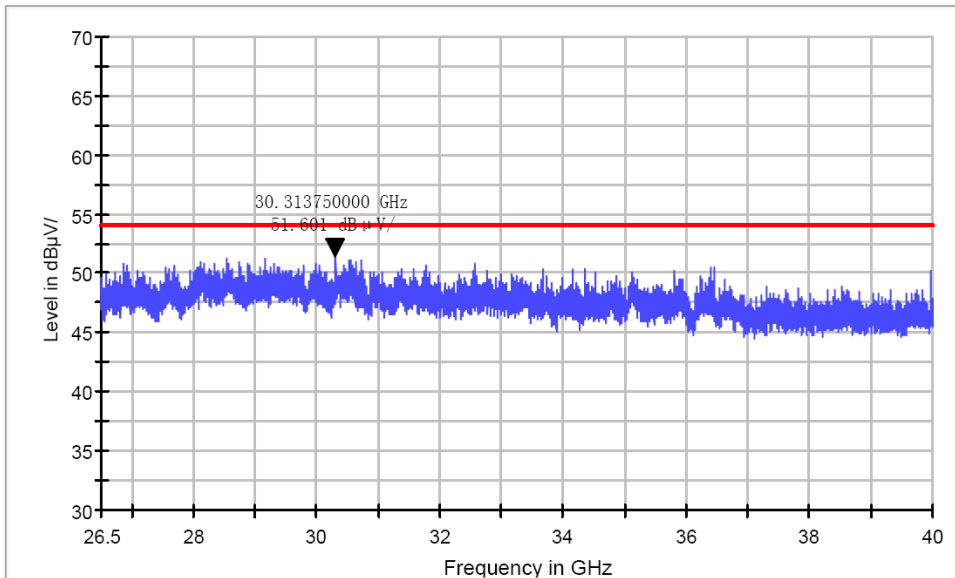

Common Information

Test Site: SMQ EMC Lab.
Environment Conditions:
Antenna Polarization: Vertical
Operator Name:
Comment:

Copy of FCC Electric Field Strength 26.5-40GHz

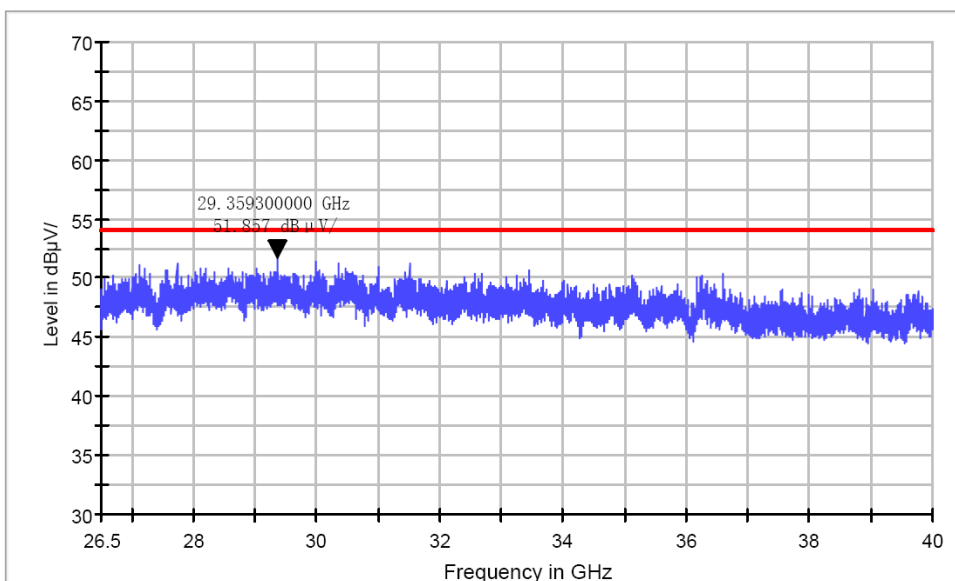

Test mode: 802.11ac(80MHz) TX Frequency: 5210MHz, 5775MHz

The EUT is tested radiation emission at each test mode in three axes. Besides, We have tested the single antenna transmit mode and the dual antenna emission mode. The worst emissions are reflected in the following plots

Common Information

Test Site: SMQ EMC Lab.
Environment Conditions:
Antenna Polarization: Horizontal
Operator Name:
Comment:

Copy of FCC Electric Field Strength 26.5-40GHz

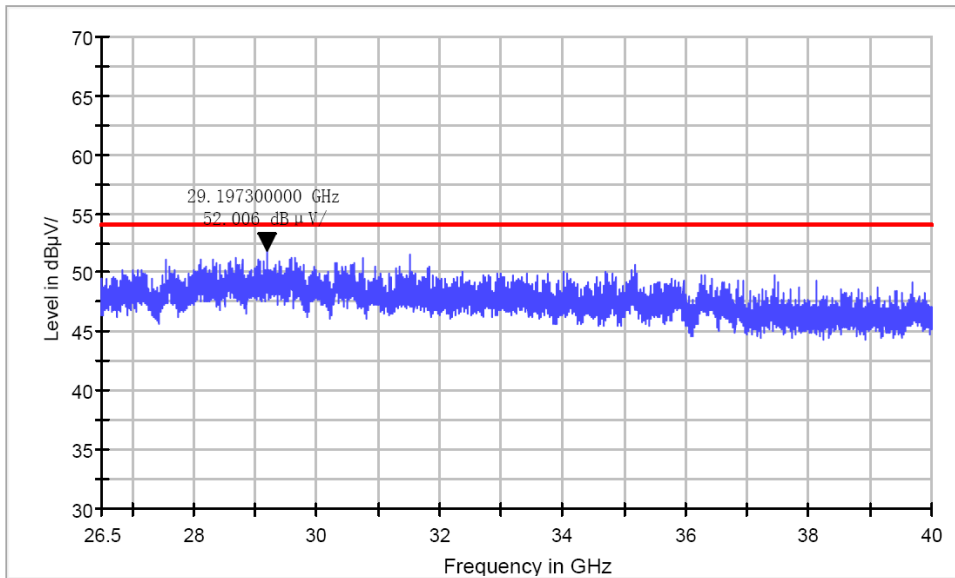

Common Information

Test Site: SMQ EMC Lab.
Environment Conditions:
Antenna Polarization: Vertical
Operator Name:
Comment:

Copy of FCC Electric Field Strength 26.5-40GHz

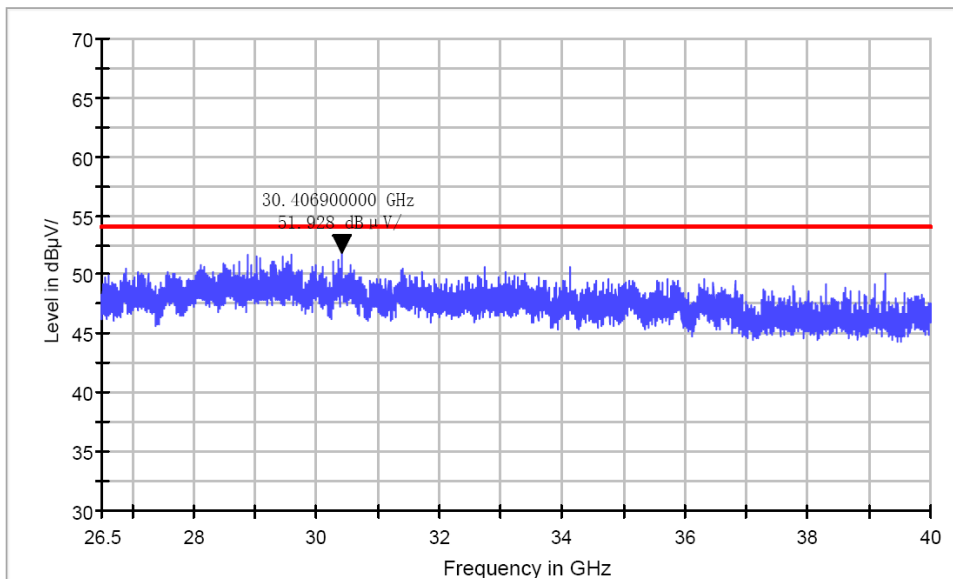

Co-location Spurious Emission
Test mode : 2.4GHz and 5GHz Wi-Fi Transmitting simultaneously

Indicated		Detector (PK/AV)	Table Angle Degree	Antenna		Correction Factor			FCC Part 15.247&FCC Part 15.407			
Frequency (MHz)	Receiver Reading (dBμV)			Height (m)	Polar (H/V)	Ant. Factor (dB/m)	Cable Loss (dB)	Pre-Amp. Gain (dB)	Cord. Amp. (dBμV/m)	Limit (dBμV/m)	Margin (dB)	Comment
30MHz-1GHz												
55	43.67	QP	285	1.0	H	0	0.1	13.09	30.68	40	9.32	Spurious
210	46.62	QP	322	1.0	H	0	0.4	12.39	34.63	43.5	8.87	Spurious
375	50.78	QP	80	1.0	H	0	0.6	7.66	43.72	46	2.28	Spurious
750	37.71	QP	320	1.0	H	0	0.9	1.19	37.42	46	8.58	Spurious
35.1	44.84	QP	60	1.0	V	0	0.1	10.54	34.40	40	5.60	Spurious
49.5	49.32	QP	176	1.0	V	0	0.1	12.68	36.74	40	3.26	Spurious
72.8	49.73	QP	300	1.0	V	0	0.1	16.54	33.29	40	6.71	Spurious
157.6	48.01	QP	180	1.0	V	0	0.3	14.99	33.32	43.5	10.18	Spurious
1GHz-26.5GHz												
4814	35.47	AV	130	1.5	V	15.9	2.7	12.6	41.47	54	12.53	harmonic
4814	44.28	PK	132	1.5	H	15.9	2.7	12.6	50.28	74	23.72	harmonic
11550	34.75	AV	33	1.5	V	31.9	4.4	26.6	44.45	54	9.55	harmonic
11550	45.25	PK	32	1.5	H	31.9	4.4	26.6	54.95	74	19.05	harmonic
14450	39.43	PK	320	1.5	V	33.0	5.6	28.5	49.53	74	24.47	Spurious
11335	39.14	PK	190	1.5	H	31.9	4.4	26.6	48.84	74	25.16	Spurious
26.5GHz-40GHz												
29197.3	35.11	PK	126	1.5	V	42.5	10.1	35.7	52.01	74	21.99	Spurious
30406.9	35.03	PK	32	1.5	H	42.5	10.1	35.7	51.93	74	22.07	Spurious

Note: 1. The radiation emissions from 9kHz-30MHz is not reported, because the test values lower than the limits of 20dB.

2. We tested various combinations of simultaneous transmitting status and recorded the worst case test values.

12. BAND EDGE COMPLIANCE TEST

12.1. Block Diagram of Test Setup



12.2. The Requirement For Unwanted Emissions in the Restricted Bands

1. For all measurements, follow the requirements in section II.G.3., “General Requirements for Unwanted Emissions Measurements.
2. At frequencies below 1000 MHz, use the procedure described in section II.G.4., “Procedure for Unwanted Emissions Measurements Below 1000 MHz.”
3. At frequencies above 1000 MHz, measurements performed using the peak and average measurement procedures described in sections II.G.5. and II.G.6, respectively, must satisfy the respective peak and average limits.

If all peak measurements satisfy the average limit, then average measurements are not required.

4. For conducted measurements above 1000 MHz, EIRP shall be computed as specified in section II.G.3.b) and then field strength shall be computed as follows (see KDB Publication 412172):

$$E[\text{dB}\mu\text{V}/\text{m}] = \text{EIRP}[\text{dBm}] - 20 \log(d[\text{meters}]) + 104.77,$$

where E = field strength and d = distance at which field strength limit is specified in the rules;

$$E[\text{dB}\mu\text{V}/\text{m}] = \text{EIRP}[\text{dBm}] + 95.2, \text{ for } d = 3 \text{ meters.}$$

12.3. EUT Configuration on Measurement

The equipment are installed on the emission Measurement to meet the commission requirements and operating regulations in a manner which tends to maximize its emission characteristics in normal application.

12.4. Operating Condition of EUT

12.4.1. Setup the EUT and simulator as shown as Section 12.1.

12.4.2. Turn on the power of all equipment.

12.4.3. Let the EUT work in TX modes measure it. The transmit frequency are 5150-5250 and 5725-5825MHz .

12.5. Test Procedure

Conducted Band Edge:

12.5.1. The transmitter output was connected to the spectrum analyzer via a low loss cable.

12.5.2. Set RBW of spectrum analyzer to 100kHz and VBW to 300kHz.

Radiate Band Edge:

12.5.3. The EUT is placed on a turntable, which is 1.5m above the ground plane and worked at highest radiated power.

12.5.4. The turntable was rotated for 360 degrees to determine the position of maximum emission level.

12.5.5. EUT is set 3m away from the receiving antenna, which is varied from 1m to 4m to find out the highest emission.

12.5.6. Set the spectrum analyzer in the following setting in order to capture the lower and upper band-edges of the emission:

12.5.7. RBW=1MHz, VBW=1MHz

12.5.8. The band edges was measured and recorded.

12.6. Test Result

PASS

ANT 1(11A)

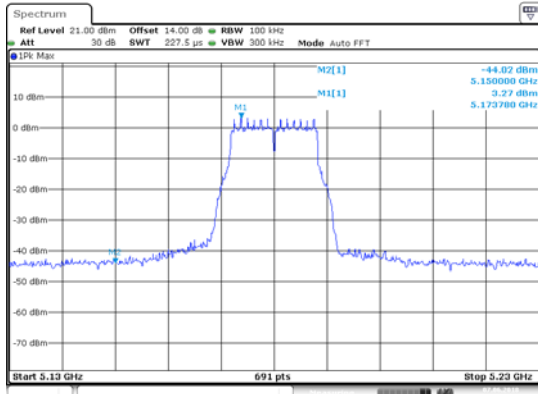

Date: 7 JUN 2018 12:27:33

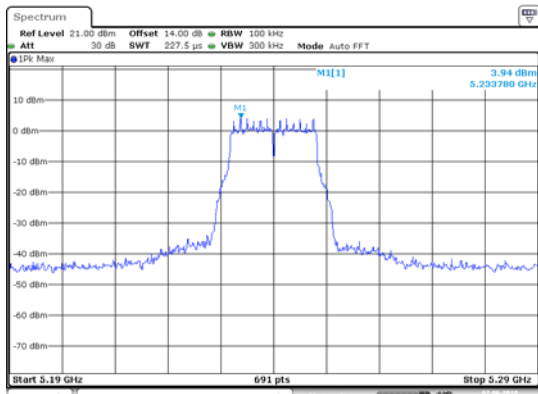

Date: 7 JUN 2018 12:37:21

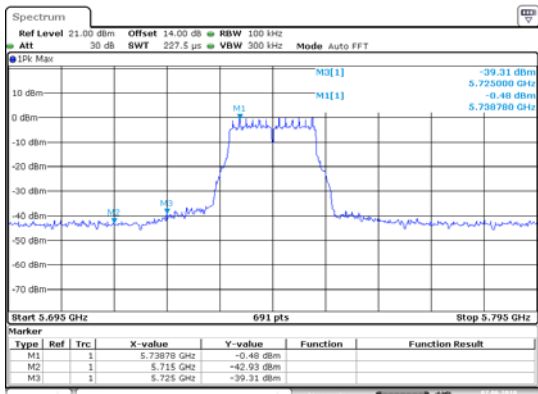

Date: 7 JUN 2018 12:40:18

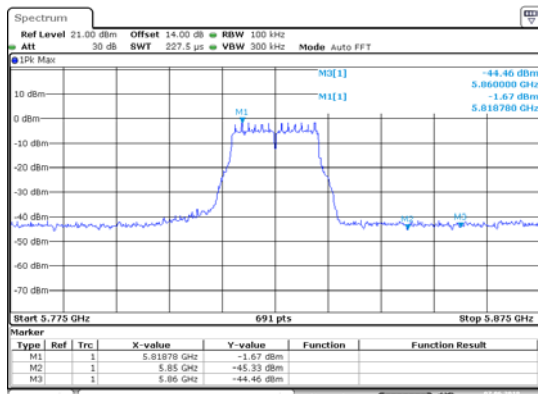

Date: 7 JUN 2018 12:48:49

ANT 2(11A)

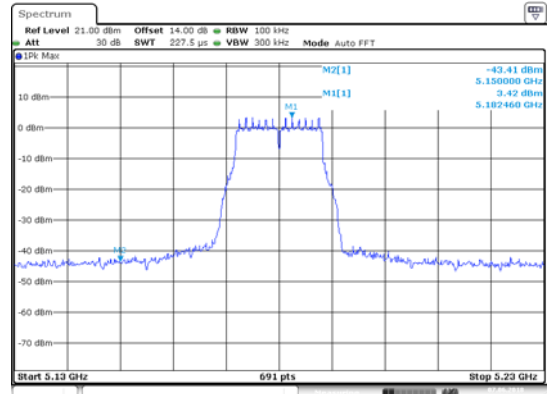

Date: 7 JUN 2018 12:28:16

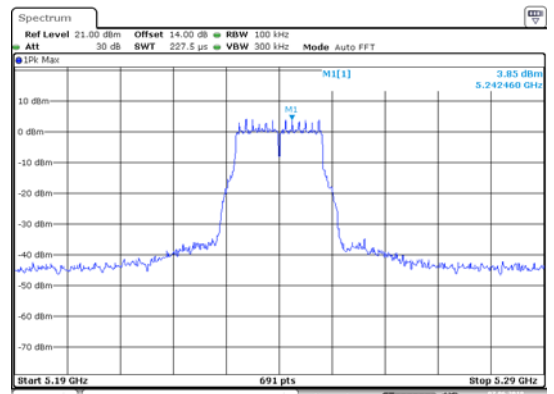

Date: 7 JUN 2018 12:37:50

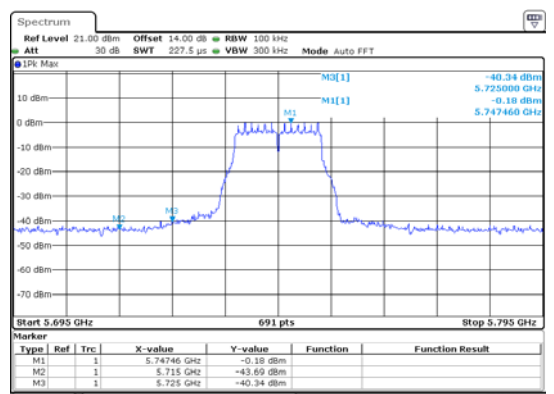

Date: 7 JUN 2018 12:41:04

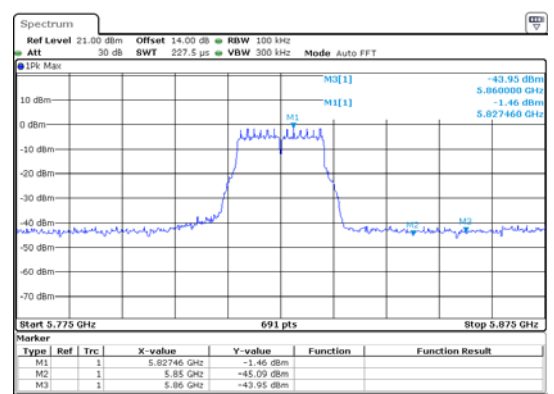

Date: 7 JUN 2018 12:49:22

ANT 1(11N20)

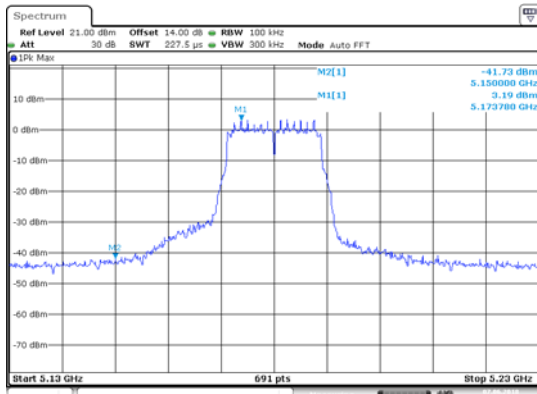

Date: 7 JUN. 2018 12:30:09

ANT 2(11N20)

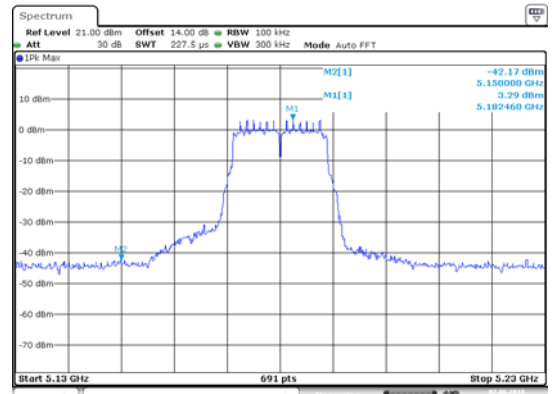

Date: 7 JUN. 2018 12:29:06

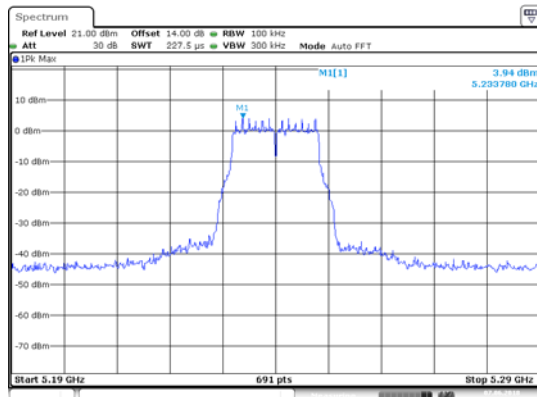

Date: 7 JUN. 2018 12:37:21

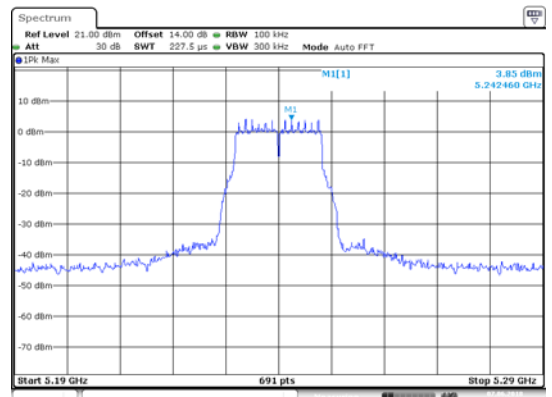

Date: 7 JUN. 2018 12:37:50

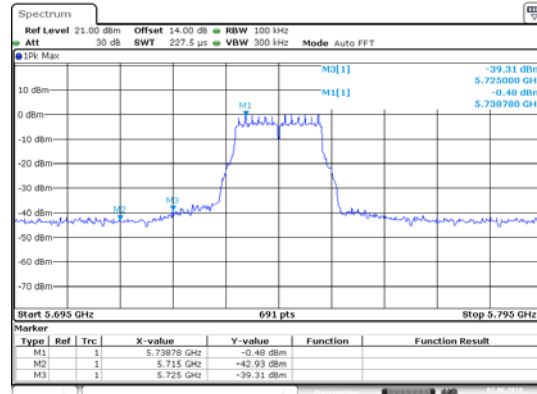

Date: 7 JUN. 2018 12:40:18

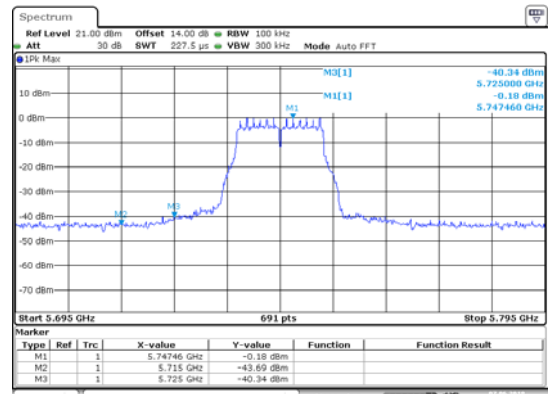

Date: 7 JUN. 2018 12:41:04

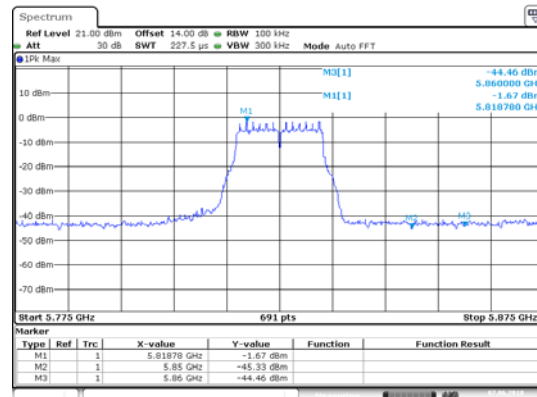

Date: 7 JUN. 2018 12:48:49

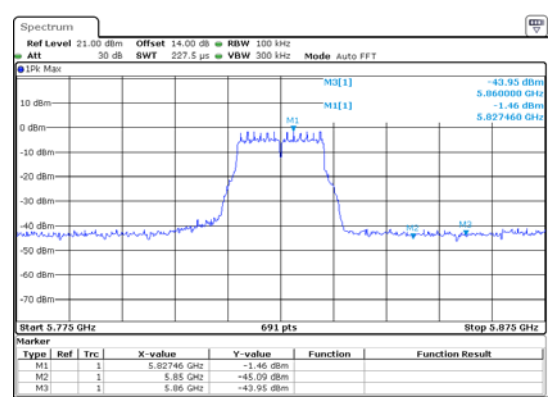

Date: 7 JUN. 2018 12:49:22

ANT 1(11AC20)

ANT 2(11AC20)

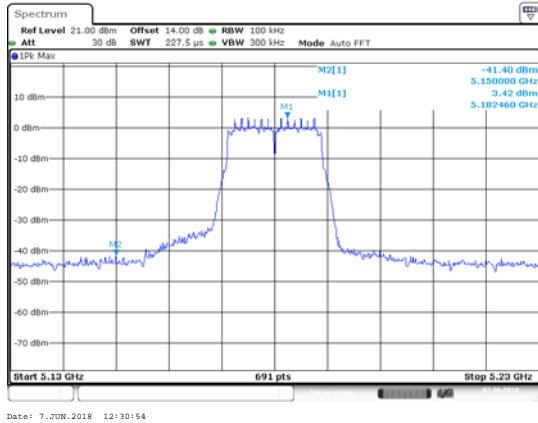

Date: 7. JUN. 2018 12:30:54

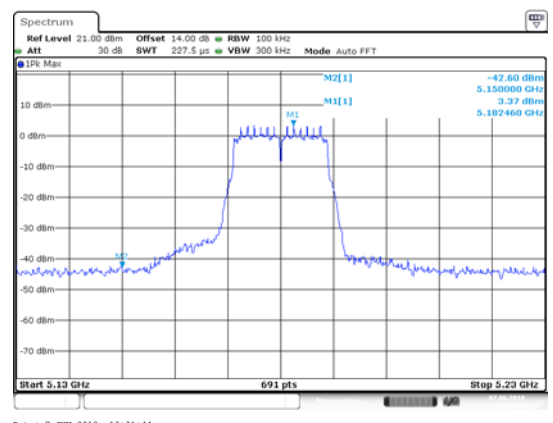

Date: 7. JUN. 2018 12:31:44

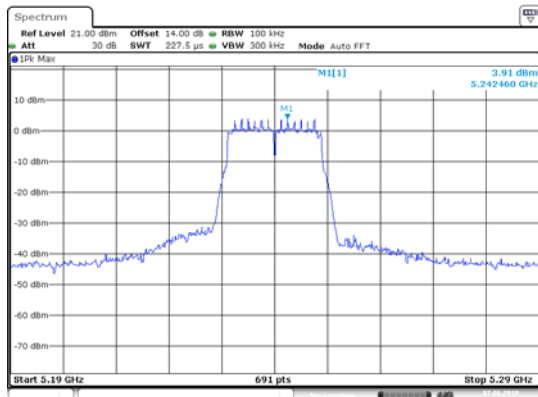

Date: 7. JUN. 2018 12:34:37

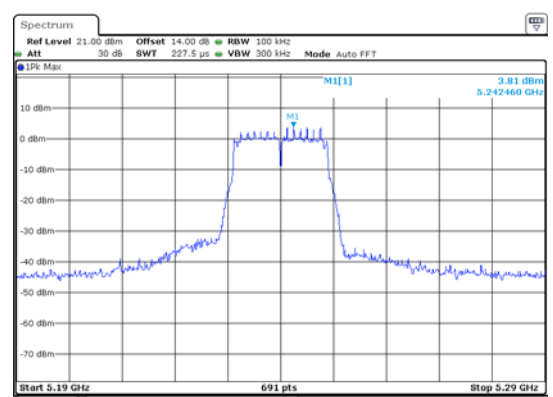

Date: 7. JUN. 2018 12:35:08

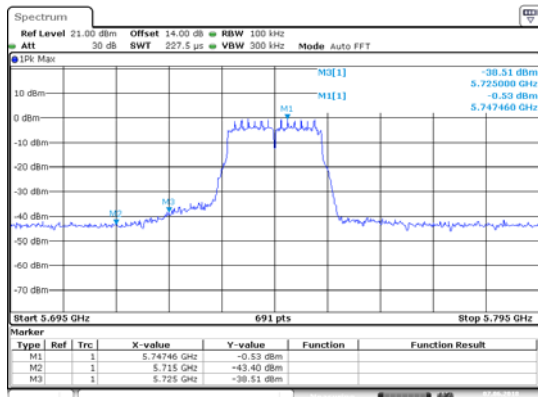

Date: 7. JUN. 2018 12:43:57

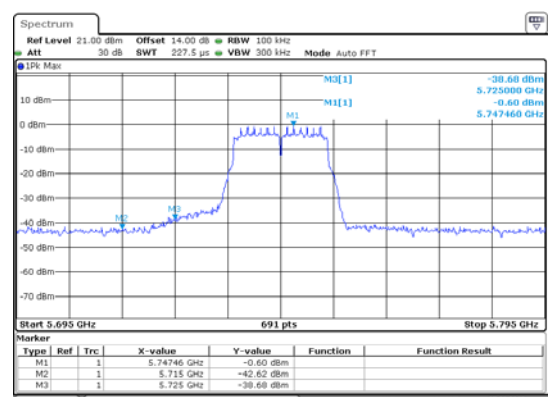

Date: 7. JUN. 2018 12:44:58

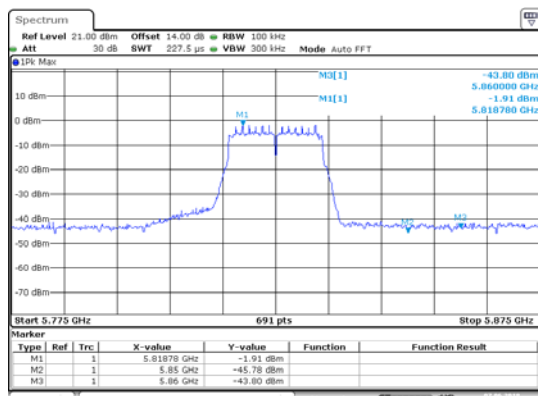

Date: 7. JUN. 2018 12:46:41

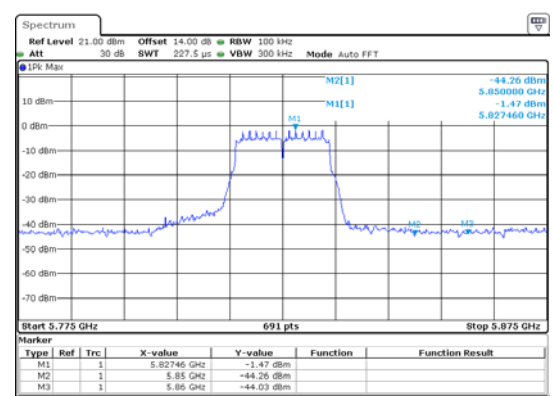

Date: 7. JUN. 2018 12:47:52

ANT 1(11N40)

ANT 2(11N40)

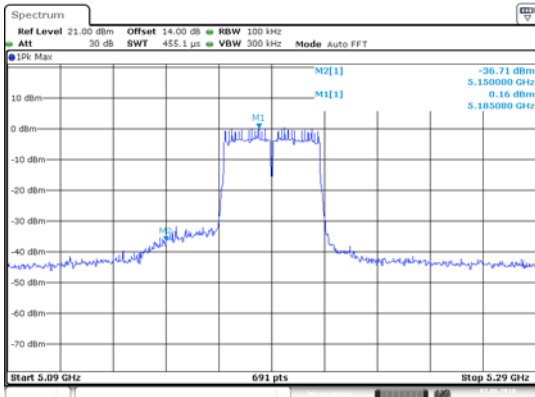

Date: 7 JUN 2018 12:52:23

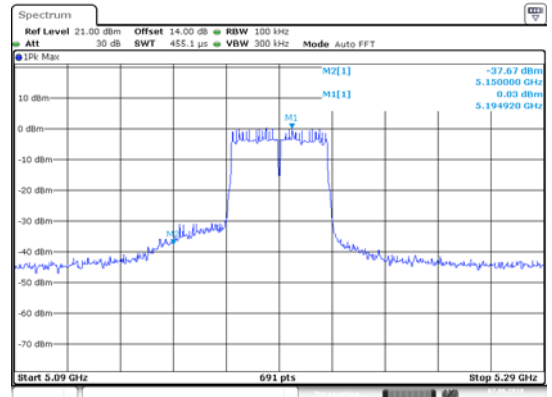

Date: 7 JUN 2018 12:53:10

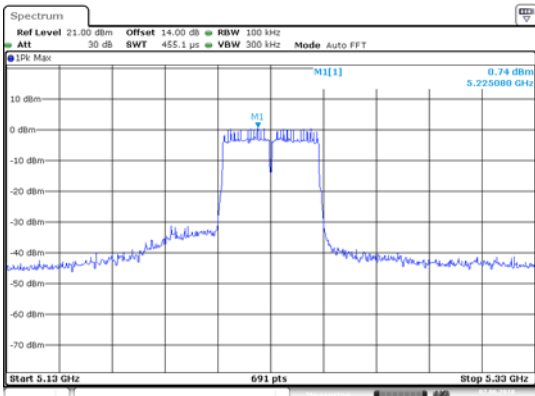

Date: 7 JUN 2018 12:57:49

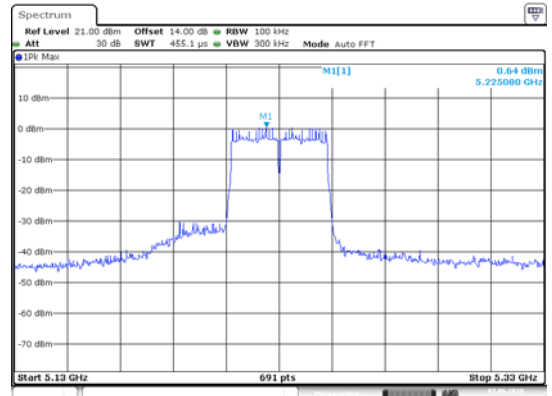

Date: 7 JUN 2018 12:58:24

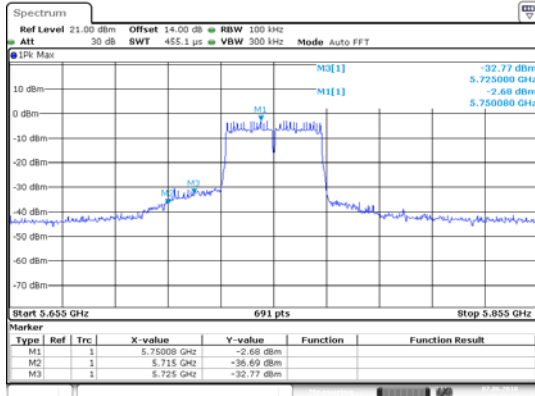

Date: 7 JUN 2018 13:01:41

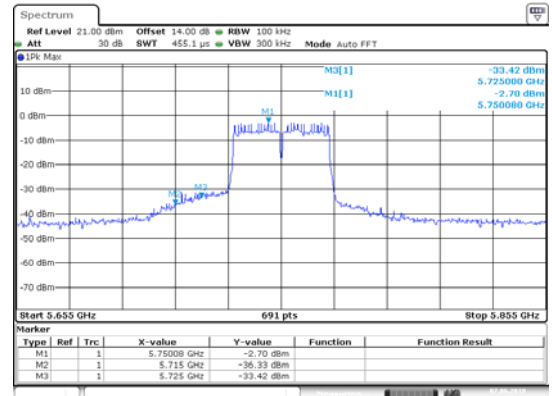

Date: 7 JUN 2018 13:02:30

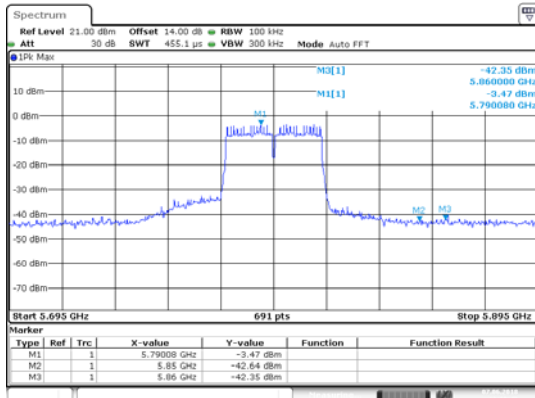

Date: 7 JUN 2018 13:08:45

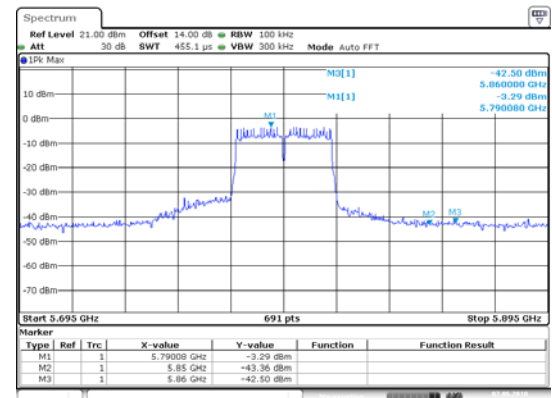

Date: 7 JUN 2018 13:09:36

ANT 1(11AC40)

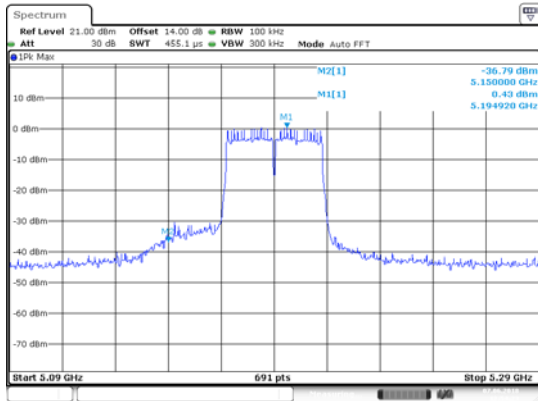

Date: 7.JUN.2018 12:54:23

ANT 2(11AC40)

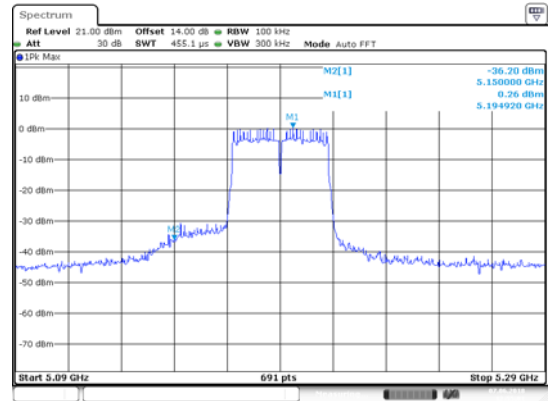

Date: 7.JUN.2018 12:55:01

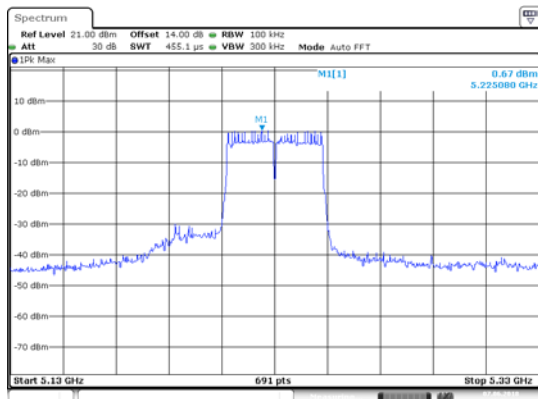

Date: 7.JUN.2018 12:56:28

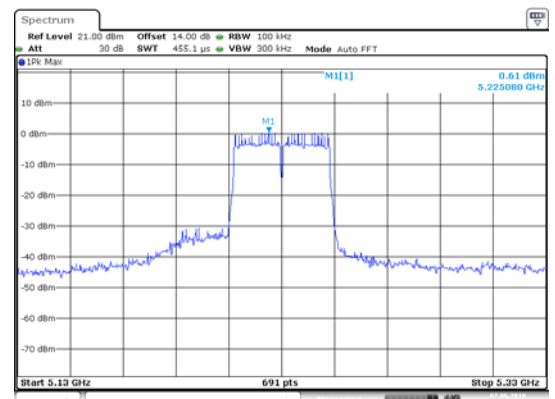

Date: 7.JUN.2018 12:57:06

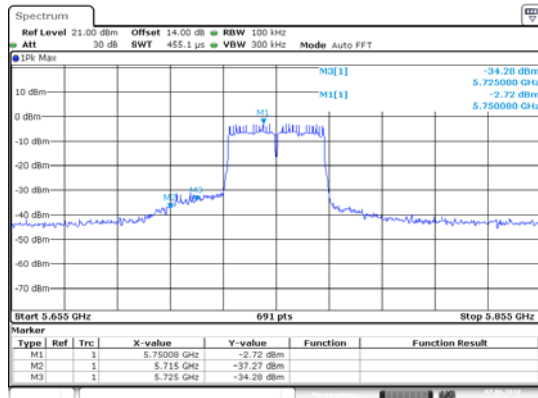

Date: 7.JUN.2018 13:05:02

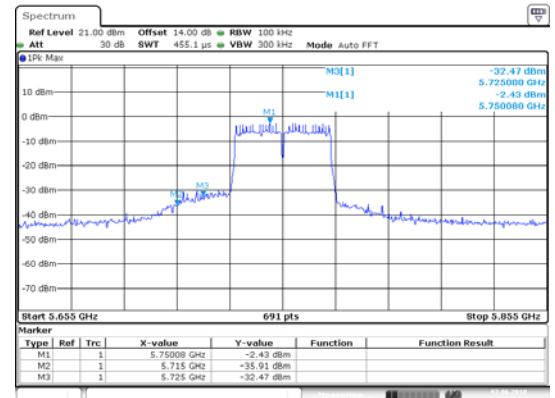

Date: 7.JUN.2018 13:12:52

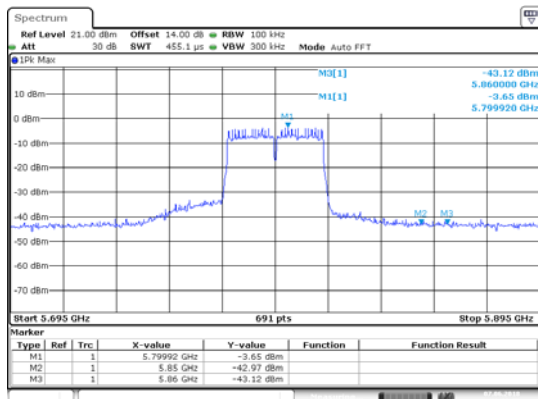

Date: 7.JUN.2018 13:06:55

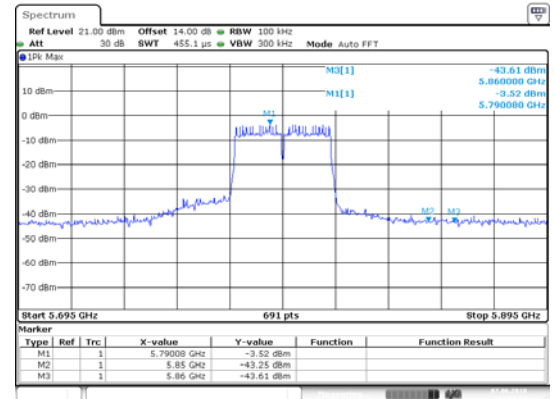

Date: 7.JUN.2018 13:07:53

ANT 1(11AC80)

ANT 2(11AC80)

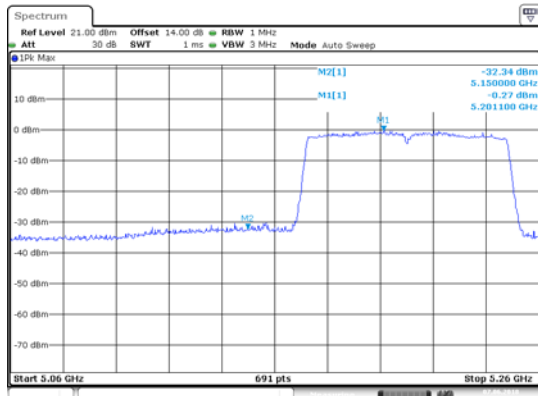

Date: 7.JUN.2018 12:22:59

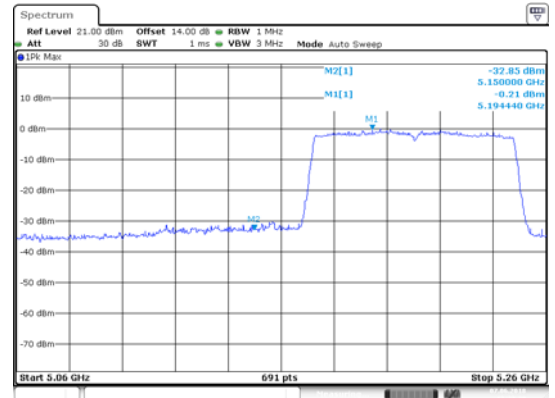

Date: 7.JUN.2018 12:23:38

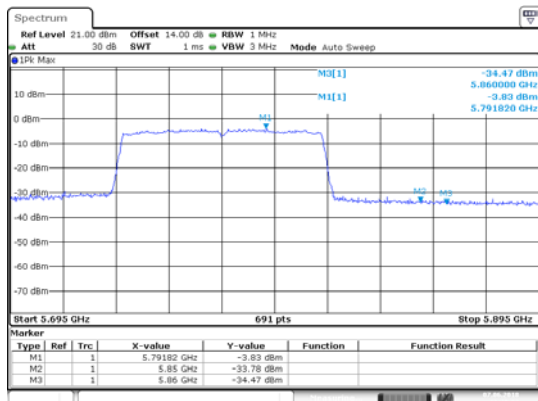

Date: 7.JUN.2018 12:20:03

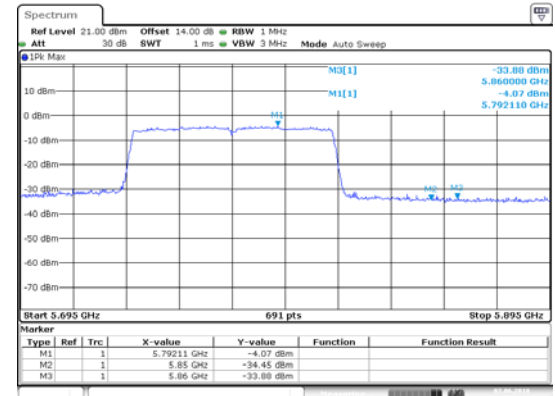

Date: 7.JUN.2018 12:21:10