

APPLICATION CERTIFICATION FCC Part 15C

On Behalf of
CTOUCH Europe B.V.

UP-Android 7 module

Model No.: UPA000AN

FCC ID: 2APQQ-UPA000AN

Prepared for : CTOUCH Europe B.V.
Address : Achtseweg Zuid 153R, 5651 GW Eindhoven, The
Netherlands

Prepared by : Shenzhen Accurate Technology Co., Ltd.
Address : 1/F., Building A, Changyuan New Material Port,
Science & Industry Park, Nanshan District,
Shenzhen, Guangdong, P.R. China

Tel: (0755) 26503290

Fax: (0755) 26503396

Report No. : ATE20180786
Date of Test : June 01, 2018-Aug. 02, 2018
Date of Report : Aug. 03, 2018

TABLE OF CONTENTS

Description	Page
Test Report Certification	
1. GENERAL INFORMATION	5
1.1. Description of Device (EUT).....	5
1.2. Special Accessory and Auxiliary Equipment	6
1.3. Description of Test Facility	7
1.4. Measurement Uncertainty	7
2. MEASURING DEVICE AND TEST EQUIPMENT	8
3. OPERATION OF EUT DURING TESTING	9
3.1. Test setups	9
3.2. Configuration and peripherals	9
3.3. Test mode.....	10
4. TEST PROCEDURES AND RESULTS	11
5. 6DB OCCUPIED BANDWIDTH TEST	13
5.1. Block Diagram of Test Setup.....	13
5.2. EUT Configuration on Measurement	13
5.3. Operating Condition of EUT	13
5.4. Test Procedure	13
5.5. Test Result	14
6. 26DB OCCUPIED BANDWIDTH TEST	21
6.1. Block Diagram of Test Setup.....	21
6.2. EUT Configuration on Measurement	21
6.3. Operating Condition of EUT	21
6.4. Test Procedure	21
6.5. Test Result	22
7. 99% BANDWIDTH MEASUREMENT	29
7.1. Block Diagram of Test Setup.....	29
7.2. The Requirement For Section 15.407	29
7.3. EUT Configuration on Measurement	29
7.4. Operating Condition of EUT	29
7.5. Test Procedure	29
7.6. Test Result	30
8. DUTY CYCLE MEASUREMENT.....	38
8.1. Block Diagram of Test Setup.....	38
8.2. EUT Configuration on Measurement	38
8.3. Operating Condition of EUT	38
8.4. Test Procedure	38
8.5. Test Result	39
9. MAXIMUM POWER SPECTRAL DENSITY TEST	42
9.1. Block Diagram of Test Setup.....	42
9.2. The Requirement For Section 15.407	42
9.3. EUT Configuration on Measurement	42
9.4. Operating Condition of EUT	42
9.5. Test Procedure	43
9.6. Test Result	44

10. MAXIMUM CONDUCTED (AVERAGE) OUTPUT POWER	59
10.1. Block Diagram of Test Setup.....	59
10.2. The Requirement For Section 15.407	59
10.3. EUT Configuration on Measurement	59
10.4. Operating Condition of EUT	59
10.5. Test Procedure	59
10.6. Test Result	60
11. RADIATED SPURIOUS EMISSION TEST	69
11.1. Block Diagram of Test Setup.....	69
11.2. Restricted bands of operation	71
11.3. Configuration of EUT on Measurement	71
11.4. The Limit For Section 15.407.....	72
11.5. Operating Condition of EUT	72
11.6. Test Procedure	72
11.7. DATA SAMPLE	73
11.8. The Field Strength of Radiation Emission Measurement Results	73
12. BAND EDGE COMPLIANCE TEST	97
12.1. Block Diagram of Test Setup.....	97
12.2. The Requirement For Unwanted Emissions in the Restricted Bands	97
12.3. EUT Configuration on Measurement	97
12.4. Operating Condition of EUT	97
12.5. Test Procedure	98
12.6. Test Result	98
13. IN BAND EMISSION	150
13.1. Block Diagram of Test Setup.....	150
13.2. For transmitters operating in the 5.725-5.85 GHz band:	150
13.3. EUT Configuration on Measurement	150
13.4. Operating Condition of EUT	150
13.5. Test Procedure	150
13.6. Test Result	150
14. FREQUENCIES STABILITY	162
14.1. Block Diagram of Test Setup.....	162
14.2. EUT Configuration on Measurement	162
14.3. Operating Condition of EUT	162
14.4. Test Result	162
15. ANTENNA REQUIREMENT.....	164
15.1. The Requirement	164
15.2. Antenna Construction	164

Test Report Certification

Applicant : CTOUCH Europe B.V.
Address : Achtseweg Zuid 153R, 5651 GW Eindhoven, The Netherlands
Manufacturer : CTOUCH Europe B.V.
Address : Achtseweg Zuid 153R, 5651 GW Eindhoven, The Netherlands
Product : UP-Android 7 module
Model No. : UPA000AN
Trade name : CTOUCH

Measurement Procedure Used:

FCC Rules and Regulations Part 15 Subpart E Section 15.407

ANSI C63.10: 2013

KDB 789033 D02 General UNII Test Procedures New Rules v01r04

KDB 558074 D01 DTS Meas Guidance v04

KDB 662911 D01 Multiple Transmitter Output v02r01

The device described above is tested by SHENZHEN ACCURATE TECHNOLOGY CO. LTD to determine the maximum emission levels emanating from the device. The maximum emission levels are compared to the FCC Part 15 Subpart E Section 15.407 limits. The measurement results are contained in this test report and SHENZHEN ACCURATE TECHNOLOGY CO. LTD is assumed full responsibility for the accuracy and completeness of these measurements. Also, this report shows that the Equipment Under Test (EUT) is to be technically compliant with the FCC requirements.

This report applies to above tested sample only. This report shall not be reproduced in part without written approval of SHENZHEN ACCURATE TECHNOLOGY CO. LTD.

Date of Test : June 01, 2018-Aug. 02, 2018

Date of Report : Aug. 03, 2018

Prepared by : _____

(Tim  Eng  er)

Approved & Authorized Signer : _____

(Sean Liu, Manager)

1. GENERAL INFORMATION

1.1. Description of Device (EUT)

EUT	:	UP-Android 7 module
Model Number	:	UPA000AN
IEEE 802.11 WLAN	:	802.11a (20 MHz channel bandwidth) , 802.11n (20 MHz channel bandwidth), 802.11n (40 MHz channel bandwidth), 802.11ac (20 MHz channel bandwidth), 802.11ac (40 MHz channel bandwidth) 802.11ac (80 MHz channel bandwidth)
Frequency Range	:	U-NII(5150-5250, 5725-5850MHz)
Number of Channels	:	$f_c = 5000 \text{ MHz} + N * 5 \text{ MHz}$, where: - f_c = “Operating Frequency” in MHz, - N = “Channel Number”. 5150-5250 MHz: $N = 36$ to 48 with step of 4 for the 20 MHz channel bandwidth. $N = 38$ to 46 with step of 4 for the 40 MHz channel bandwidth. $N = 42$ for the 80 MHz channel bandwidth. 5725-5850 MHz: $N = 149$ to 165 with step of 4 for the 20 MHz channel bandwidth. $N = 151$ to 159 with step of 4 for the 40 MHz channel bandwidth. $N = 155$ for the 80 MHz channel bandwidth.
$G_{\text{ANT MAX}}$:	ANT1:2 dBi (per antenna port, max.) ANT2:2 dBi(per antenna port, max.)
Directional gain	:	5.01
Type of Antenna	:	SISO (for 802.11a/n/ac) MIMO Antenna(for 802.11n/ac)
Power Supply	:	DC 12-19V
Modulation Type	:	BPSK/QPSK/16QAM/64QAM (OFDM)

1.3. Description of Test Facility

EMC Lab	:	Recognition of accreditation by Federal Communications Commission (FCC) The Designation Number is CN1189 The Registration Number is 708358
		Listed by Innovation, Science and Economic Development Canada (ISED) The Registration Number is 5077A-2
		Accredited by China National Accreditation Service for Conformity Assessment (CNAS) The Registration Number is CNAS L3193
		Accredited by American Association for Laboratory Accreditation (A2LA) The Certificate Number is 4297.01
Name of Firm	:	Shenzhen Accurate Technology Co., Ltd
Site Location	:	1/F., Building A, Changyuan New Material Port, Science & Industry Park, Nanshan District, Shenzhen, Guangdong, P.R. China

1.4. Measurement Uncertainty

Conducted Emission Expanded Uncertainty	=	2.23dB, k=2
Radiated emission expanded uncertainty (9kHz-30MHz)	=	3.08dB, k=2
Radiated emission expanded uncertainty (30MHz-1000MHz)	=	4.42dB, k=2
Radiated emission expanded uncertainty (Above 1GHz)	=	4.06dB, k=2

2. MEASURING DEVICE AND TEST EQUIPMENT

Table 1: List of Test and Measurement Equipment

Kind of equipment	Manufacturer	Type	S/N	Calibrated dates	Calibrated until
EMI Test Receiver	Rohde&Schwarz	ESCS30	100307	Jan. 06, 2018	Jan. 05, 2019
EMI Test Receiver	Rohde&Schwarz	ESPI3	101526/003	Jan. 06, 2018	Jan. 05, 2019
Spectrum Analyzer	Rohde&Schwarz	FSV-40	101495	Jan. 06, 2018	Jan. 05, 2019
Spectrum Analyzer	Agilent	E7405A	MY45115511	Jan. 06, 2018	Jan. 05, 2019
Pre-Amplifier	Rohde&Schwarz	CBLU118354 0-01	3791	Jan. 06, 2018	Jan. 05, 2019
Loop Antenna	Schwarzbeck	FMZB1516	1516131	Jan. 06, 2018	Jan. 05, 2019
Bilog Antenna	Schwarzbeck	VULB9163	9163-323	Jan. 06, 2018	Jan. 05, 2019
Horn Antenna	Schwarzbeck	BBHA9120D	9120D-655	Jan. 06, 2018	Jan. 05, 2019
Horn Antenna	Schwarzbeck	BBHA9170	9170-359	Jan. 06, 2018	Jan. 05, 2019
Open Switch and Control Unit	Rohde&Schwarz	OSP120 + OSP-B157	101244 + 100866	Jan. 06, 2018	Jan. 05, 2019
LISN	Rohde&Schwarz	ESH3-Z5	100305	Jan. 06, 2018	Jan. 05, 2019
LISN	Schwarzbeck	NSLK8126	8126431	Jan. 06, 2018	Jan. 05, 2019
Highpass Filter	Wainwright Instruments	WHKX3.6/18 G-10SS	N/A	Jan. 06, 2018	Jan. 05, 2019
Band Reject Filter	Wainwright Instruments	WRCG2400/2 485-2375/2510 -60/11SS	N/A	Jan. 06, 2018	Jan. 05, 2019

3. OPERATION OF EUT DURING TESTING

3.1. Test setups

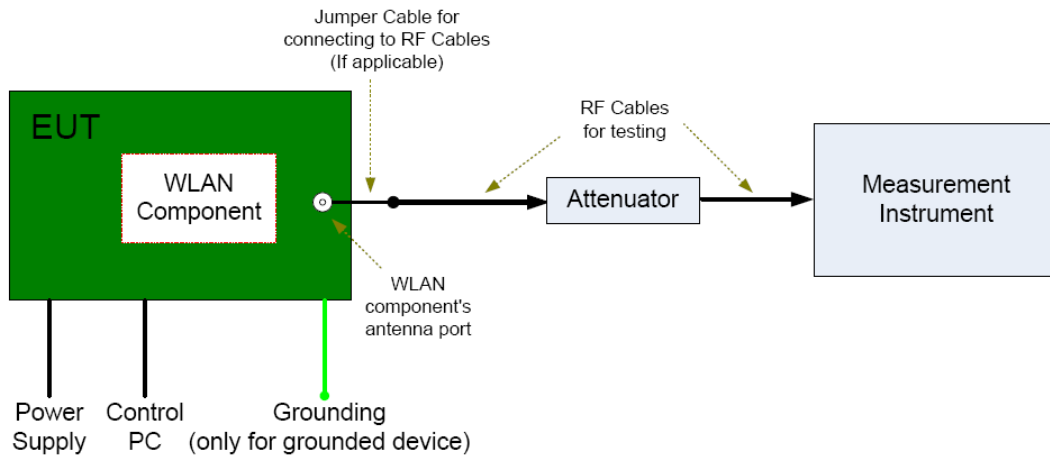

3.2. Configuration and peripherals

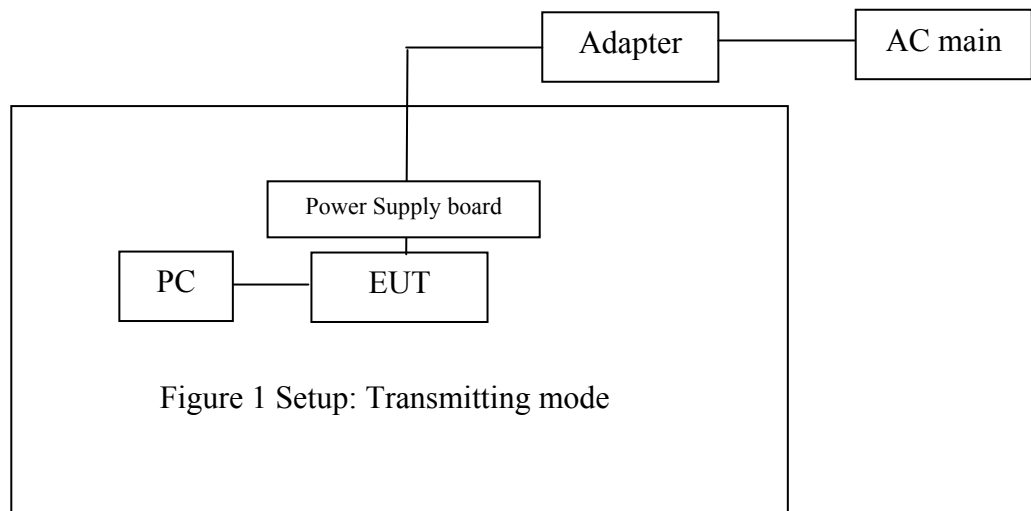

(EUT: UP-Android 7 module)

Note: The EUT have two antenna(1 and 2), They can transmit simultaneously

3.3. Test mode

Test Mode	Test Modes Description
11A	IEEE 802.11a with data rate of 6 Mbps using SISO mode.
11N20	IEEE 802.11n with data rate of MCS0 and bandwidth of 20 MHz using SISO mode.
11N20m	IEEE 802.11n with data rate of MCS8 and bandwidth of 20 MHz using MIMO mode.
11N40	IEEE 802.11n with data rate of MCS0 and bandwidth of 40 MHz using SISO mode.
11N40m	IEEE 802.11n with data rate of MCS8 and bandwidth of 40 MHz using MIMO mode.
11AC20	IEEE 802.11ac with data rate of MCS0 and bandwidth of 20 MHz using SISO mode.
11AC20m	IEEE 802.11ac with data rate of MCS8 and bandwidth of 20 MHz using SISO mode.
11AC40	IEEE 802.11ac with data rate of MCS0 and bandwidth of 40 MHz using SISO mode.
11AC40m	IEEE 802.11ac with data rate of MCS8 and bandwidth of 40 MHz using MIMO mode.
11AC80m	IEEE 802.11ac with data rate of MCS8 and bandwidth of 80 MHz using MIMO mode.

NOTE: Worst cases for each IEEE 802.11 mode are selected to perform tests.

4. TEST PROCEDURES AND RESULTS

Description of Test	Band	FCC Rules	Requirements	Result
AC power Line Conducted Emission Test	N/A	N/A	N/A	N/A
Emission Bandwidth	5150-5250	15.403(i), 15.407(a)(1)	No limit.	Compliant
	5725-5850	15.403(i), 15.407(e)	≥ 500 kHz.	
Occupied Bandwidth	5150-5250 5725-5850	KDB 789033 §D	No limit	Compliant
Duty Cycle	5150-5250 5725-5850	--	No limit	Compliant
Maximum Conducted Output Power	5150-5250	15.407(a)(1) 15.407(a)(4)	< 250mW (avg during transmission)	Compliant
	5725-5850	15.407(a)(3)	< 1W (avg during transmission)	
Peak Power Spectral Density	5150-5250	15.407(a)(1) 15.407(a)(4)	FCC: For client devices in the 5.15-5.25 GHz band <11dBm/MHz (avg during transmission)	Compliant
	5725-5850	15.407(a)(3) 15.407(a)(4)	<30dBm/500KHz (avg during transmission)	
Unwanted Emissions	5150-5250	15.407(b)(1) 15.407(b)(6) 15.407(b)(7) 15.209	F<1GHz: § 15.209/§7.2.5 limit (QP). F \geq 1GHz & out-restricted: <-27dBm/MHz PK e.i.r.p. (exl. 5.15-5.35 GHz). F \geq 1GHz & in-restricted: § 15.209/§7.2.5 limit (AV&PK).	
	5725-5850	15.407(b)(4) 15.407(b)(6) 15.407(b)(7) 15.209	F<1GHz: § 15.209/§7.2.5 limit (QP). All emissions shall be limited to a level of -27 dBm/MHz at 75 MHz or more above or below the band edge increasing linearly to 10 dBm/MHz at 25 MHz above or below the band edge, and from 25 MHz above or below the band edge increasing linearly to a level of 15.6 dBm/MHz at 5 MHz above or	

			below the band edge, and from 5 MHz above or below the band edge increasing linearly to a level of 27 dBm/MHz at the band edge F ≥ 1GHz & in-restricted: § 15.209/§7.2.5 limit (AV&PK).	
Frequency Stability	5150-5250 5725-5850	15.407(g)	FCC Part 15.407(g)	Compliant
Antenna Requirement	N/A	15.203, 15.204(b), 15.204(c), 15.212(a), 2.929(b)	N/A	Compliant

Note: The power supply mode of the EUT is DC 12-19V, According to the FCC standard requirements, conducted emission is not applicable.

5. 6DB OCCUPIED BANDWIDTH TEST

5.1. Block Diagram of Test Setup

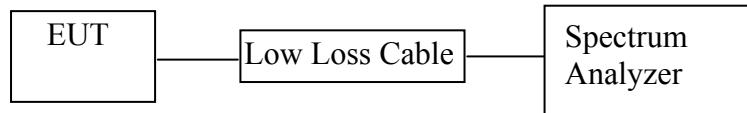

(EUT: UP-Android 7 module)

5.2. EUT Configuration on Measurement

The equipment are installed on the emission measurement to meet the commission requirements and operating regulations in a manner which tends to maximize its emission characteristics in normal application.

Section 15.407(e) specifies the minimum 6 dB emission bandwidth of at least 500 kHz for the band 5.725-5.85 GHz

5.3. Operating Condition of EUT

5.3.1. Setup the EUT and simulator as shown as Section 5.1.

5.3.2. Turn on the power of all equipment.

5.3.3. Let the EUT work in TX modes measure it. The transmit frequency are 5725-5850MHz.

5.4. Test Procedure

5.4.1. The transmitter output was connected to the spectrum analyzer through a low loss cable.

5.4.2. Set RBW of spectrum analyzer to 100 kHz and VBW to 300 kHz.

5.4.3. The 6dB bandwidth is defined as the total spectrum the power of which is higher than peak power minus 6dB.

5.5. Test Result

The test was performed with 802.11a				
Channel	Frequency (MHz)	6dB Bandwidth ANT 1 (MHz)	6dB Bandwidth ANT 2(MHz)	Limit (MHz)
149	5745	16.324	16.324	> 0.5MHz
165	5825	16.382	16.382	> 0.5MHz

The test was performed with 802.11n20				
Channel	Frequency (MHz)	6dB Bandwidth ANT 1 (MHz)	6dB Bandwidth ANT 2(MHz)	Limit (MHz)
149	5745	17.598	17.598	> 0.5MHz
165	5825	17.598	17.598	> 0.5MHz

The test was performed with 802.11ac20				
Channel	Frequency (MHz)	6dB Bandwidth ANT 1 (MHz)	6dB Bandwidth ANT 2(MHz)	Limit (MHz)
149	5745	17.598	17.598	> 0.5MHz
165	5825	17.598	17.598	> 0.5MHz

The test was performed with 802.11n40				
Channel	Frequency (MHz)	6dB Bandwidth ANT 1 (MHz)	6dB Bandwidth ANT 2(MHz)	Limit (MHz)
151	5755	36.350	36.350	> 0.5MHz
159	5795	36.350	36.350	> 0.5MHz

The test was performed with 802.11ac40				
Channel	Frequency (MHz)	6dB Bandwidth ANT 1 (MHz)	6dB Bandwidth ANT 2(MHz)	Limit (MHz)
151	5755	36.350	36.350	> 0.5MHz
159	5795	36.350	36.350	> 0.5MHz

The test was performed with 802.11ac80				
Channel	Frequency (MHz)	6dB Bandwidth ANT 1 (MHz)	6dB Bandwidth ANT 2(MHz)	Limit (MHz)
155	5775	75.250	75.250	> 0.5MHz

The spectrum analyzer plots are attached as below.

6dB Bandwidth

ANT 1(802.11A)

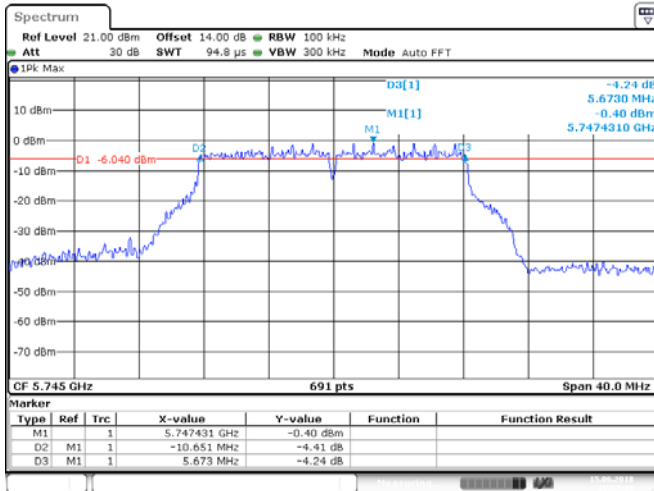

Date: 15.JUN.2018 10:53:39

ANT 2(802.11A)



Date: 15.JUN.2018 10:56:03

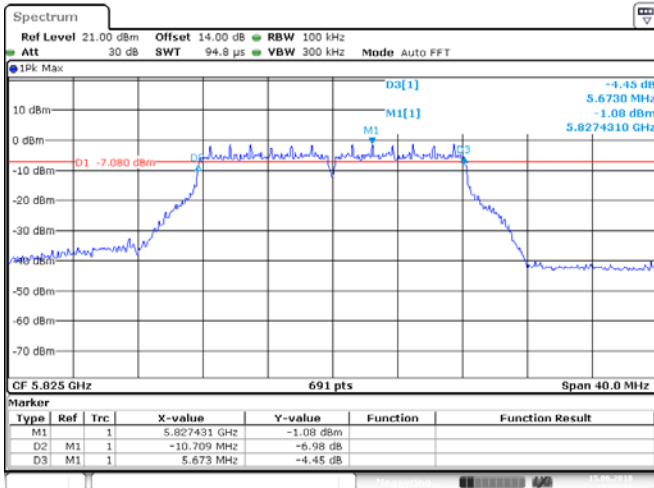

Date: 15.JUN.2018 10:59:10

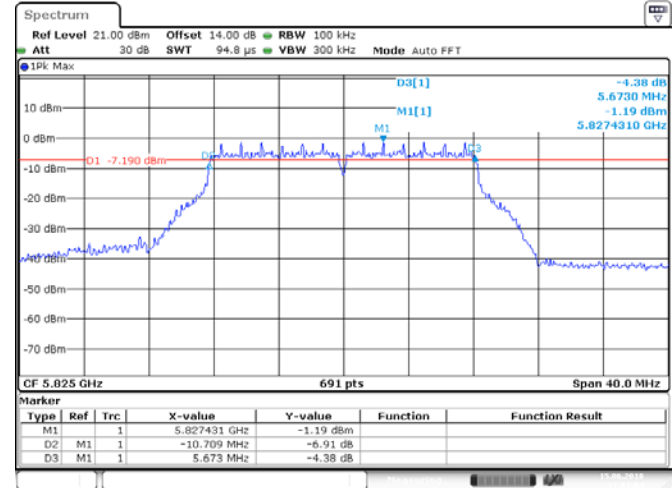

Date: 15.JUN.2018 11:01:04

ANT 1(802.11N20)

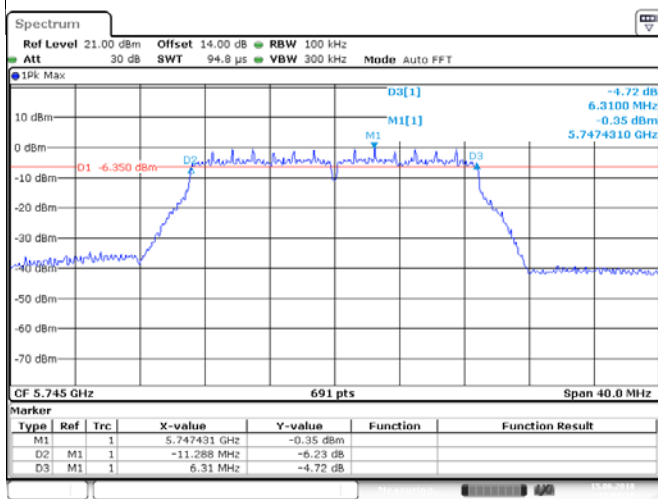

Date: 15 JUN. 2018 11:08:39

ANT 2(802.11N20)



Date: 15 JUN. 2018 11:09:31

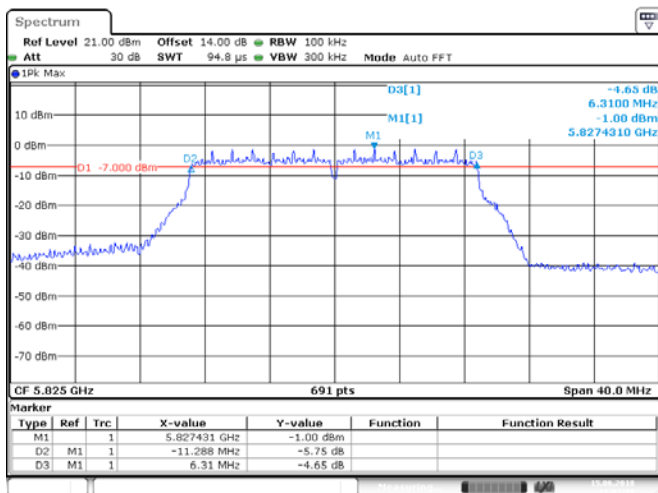

Date: 15 JUN. 2018 11:03:38



Date: 15 JUN. 2018 11:05:26

ANT 1(802.11ac20)

ANT 2(802.11ac20)

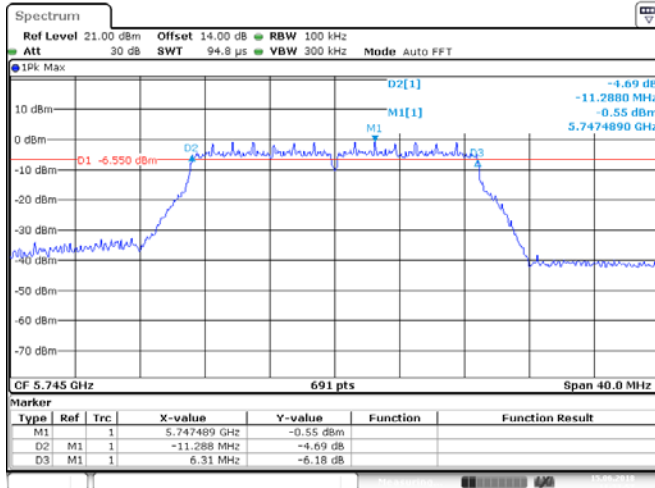

Date: 15 JUN.2018 11:33:57

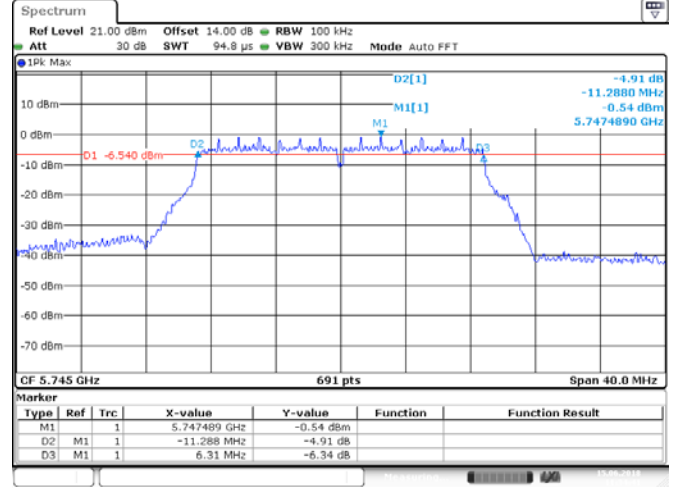

Date: 15 JUN.2018 11:34:41

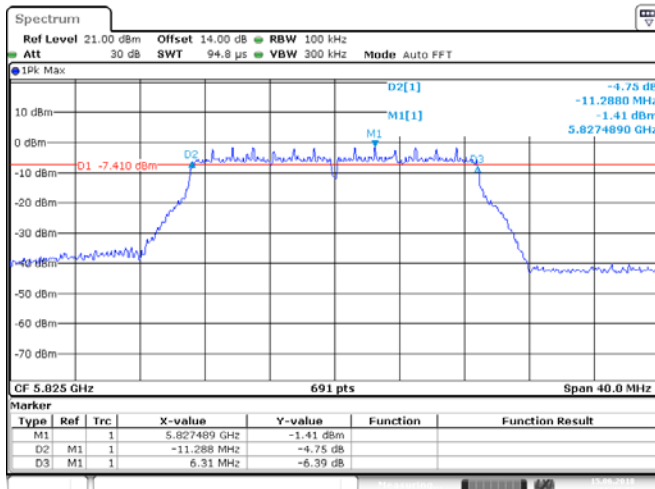

Date: 15 JUN.2018 11:41:21

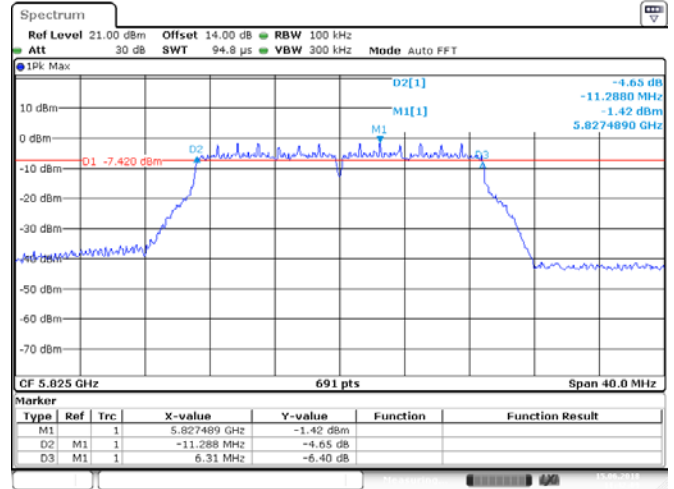

Date: 15 JUN.2018 11:42:09

ANT 1(802.11N40)

ANT 2(802.11N40)

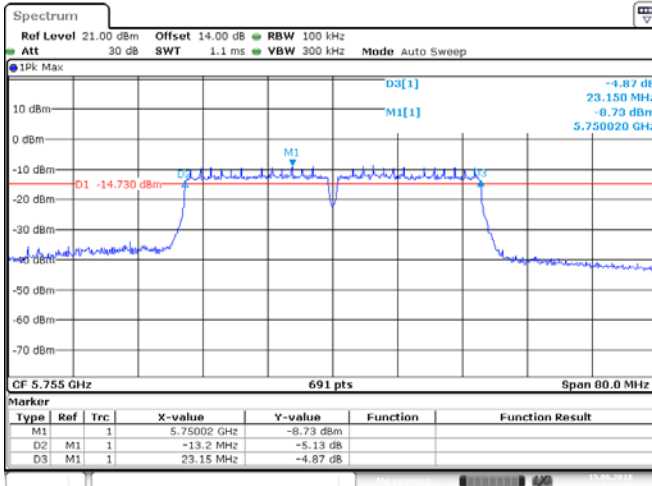

Date: 15.JUN.2018 11:12:56

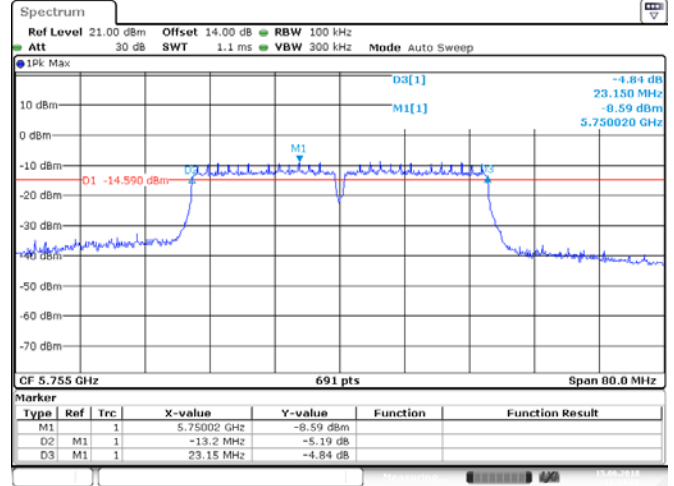

Date: 15.JUN.2018 11:14:26

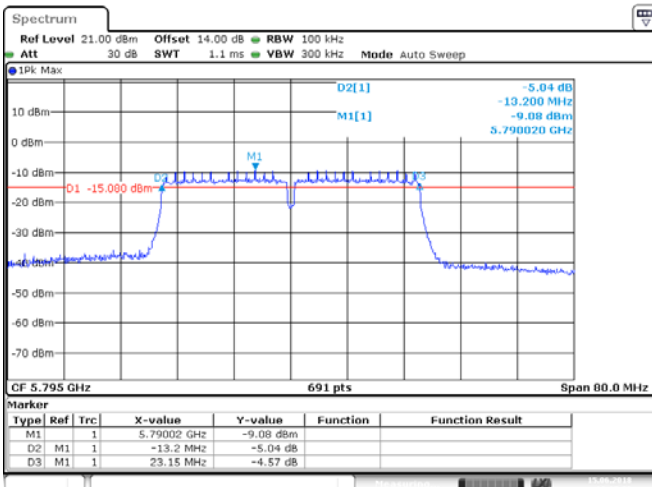

Date: 15.JUN.2018 11:17:36

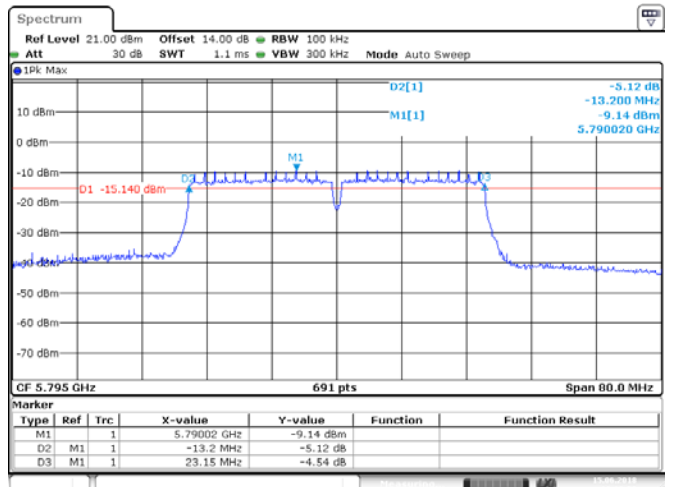

Date: 15.JUN.2018 11:18:58

ANT 1(802.11ac40)

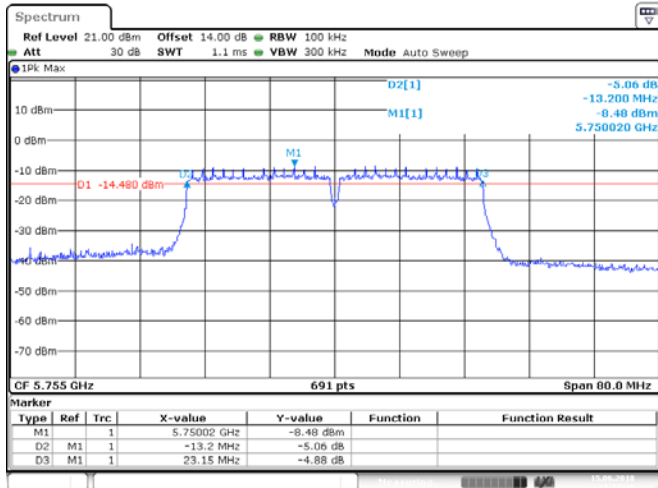

Date: 15 JUN 2018 11:26:46

ANT 2(802.11ac40)

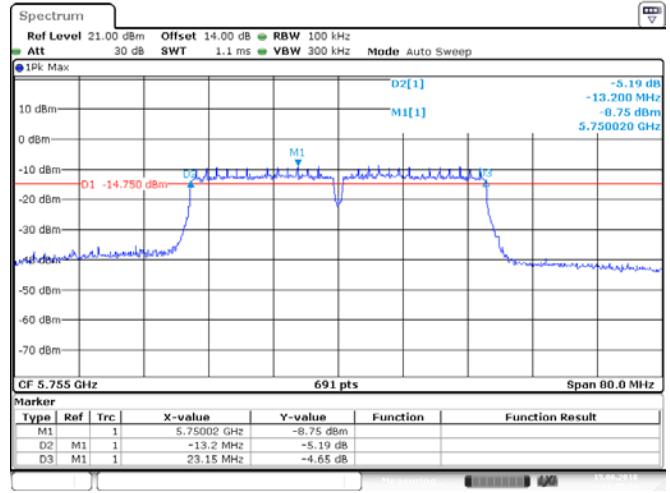

Date: 15 JUN 2018 11:25:34

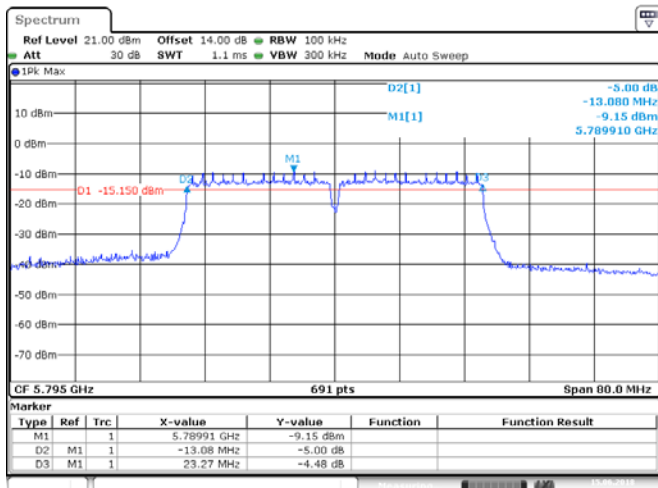

Date: 15 JUN 2018 11:22:34

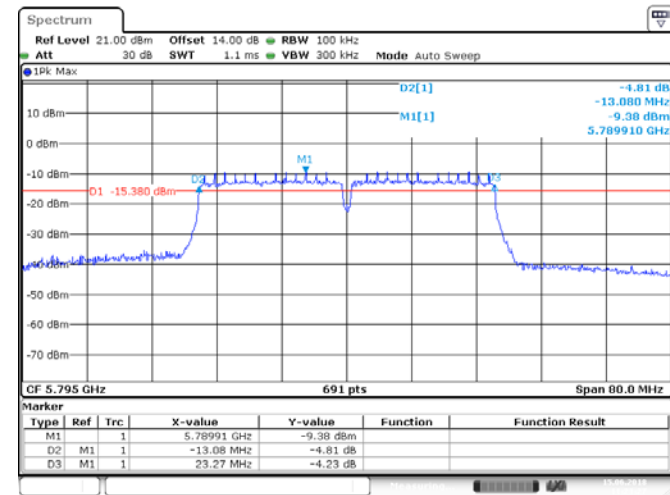

Date: 15 JUN 2018 11:23:27

ANT 1(802.11ac80)

ANT 2(802.11ac80)

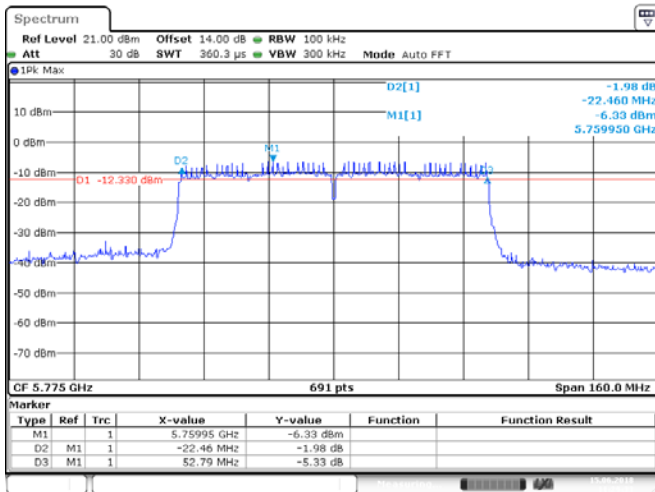

Date: 15 JUN. 2018 11:29:33

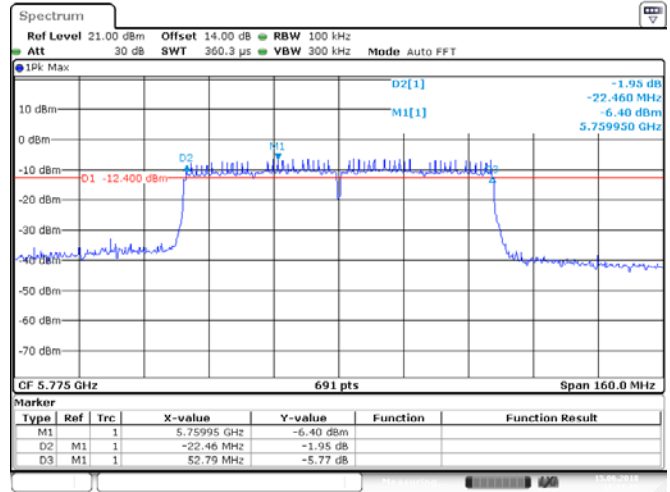

Date: 15 JUN. 2018 11:31:10

6. 26DB OCCUPIED BANDWIDTH TEST

6.1. Block Diagram of Test Setup

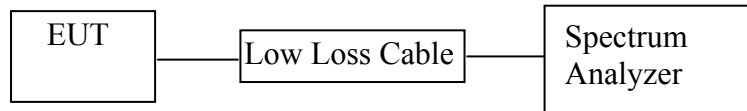

(EUT: UP-Android 7 module)

6.2. EUT Configuration on Measurement

The equipment are installed on the emission measurement to meet the commission requirements and operating regulations in a manner which tends to maximize its emission characteristics in normal application.

6.3. Operating Condition of EUT

6.3.1. Setup the EUT and simulator as shown as Section 6.1.

6.3.2. Turn on the power of all equipment.

6.3.3. Let the EUT work in TX modes measure it. The transmit frequency are 5150-5250MHz.

6.4. Test Procedure

6.4.1. The transmitter output was connected to the spectrum analyzer through a low loss cable.

6.4.2. Set Set RBW = approximately 1% of the emission bandwidth.

6.4.3. Set the VBW > RBW.

6.4.4. Detector = Peak.

6.4.5. Trace mode = max hold.

6.4.6. Measure the maximum width of the emission that is 26 dB down from the maximum of the emission. Compare this with the RBW setting of the analyzer. Readjust RBW and repeat measurement as needed until the RBW/EBW ratio is approximately 1%.

6.5. Test Result

The test was performed with 802.11a			
Channel	Frequency (MHz)	26dB Bandwidth ANT 1 (MHz)	26dB Bandwidth ANT 2(MHz)
36	5180	21.823	21.823
48	5240	21.708	21.766

The test was performed with 802.11n20			
Channel	Frequency (MHz)	26dB Bandwidth ANT 1 (MHz)	26dB Bandwidth ANT 2(MHz)
36	5180	22.171	22.229
48	5240	22.229	22.055

The test was performed with 802.11ac20			
Channel	Frequency (MHz)	26dB Bandwidth ANT 1 (MHz)	26dB Bandwidth ANT 2(MHz)
36	5180	21.997	22.287
48	5240	22.055	21.997

The test was performed with 802.11n40			
Channel	Frequency (MHz)	26dB Bandwidth ANT 1 (MHz)	26dB Bandwidth ANT 2(MHz)
38	5190	40.520	40.640
46	5230	40.640	40.640

The test was performed with 802.11ac40			
Channel	Frequency (MHz)	26dB Bandwidth ANT 1 (MHz)	26dB Bandwidth ANT 2(MHz)
38	5190	40.640	40.750
46	5230	40.750	40.750

The test was performed with 802.11ac80			
Channel	Frequency (MHz)	26dB Bandwidth ANT 1 (MHz)	26dB Bandwidth ANT 2(MHz)
42	5210	82.890	83.130

The spectrum analyzer plots are attached as below.

26dB Bandwidth

ANT 1(11A)

ANT 2(11A)

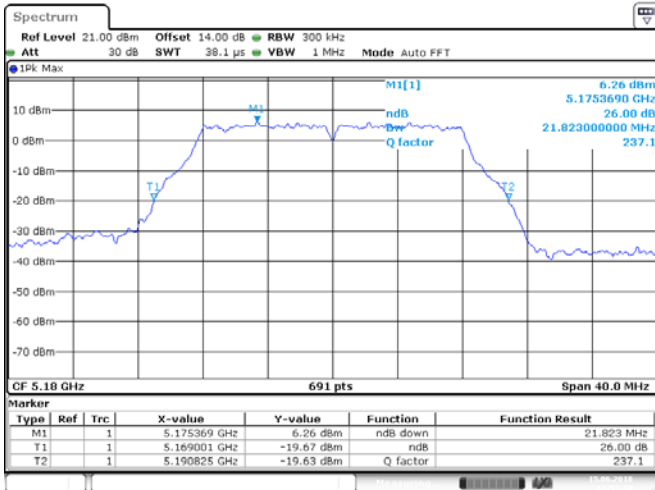

Date: 15.JUN.2018 11:51:18

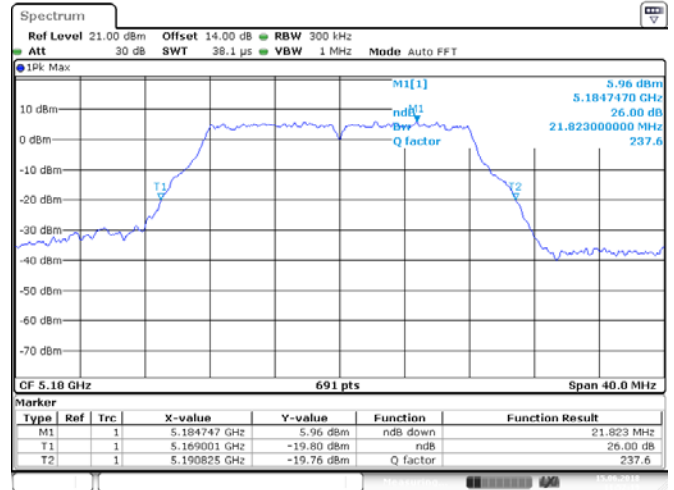

Date: 15.JUN.2018 11:52:19

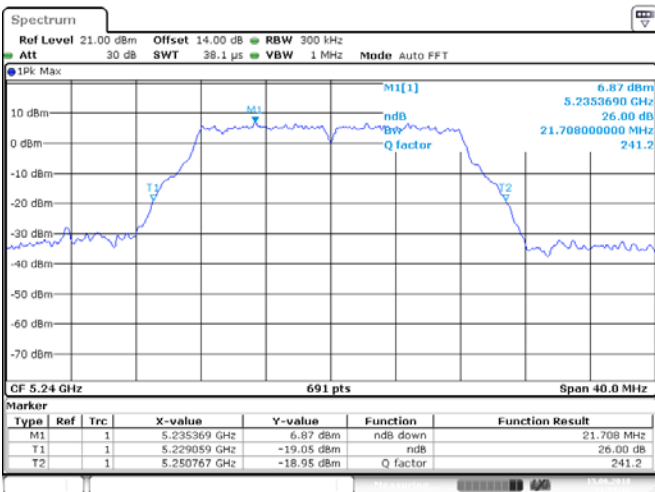

Date: 15.JUN.2018 11:53:16

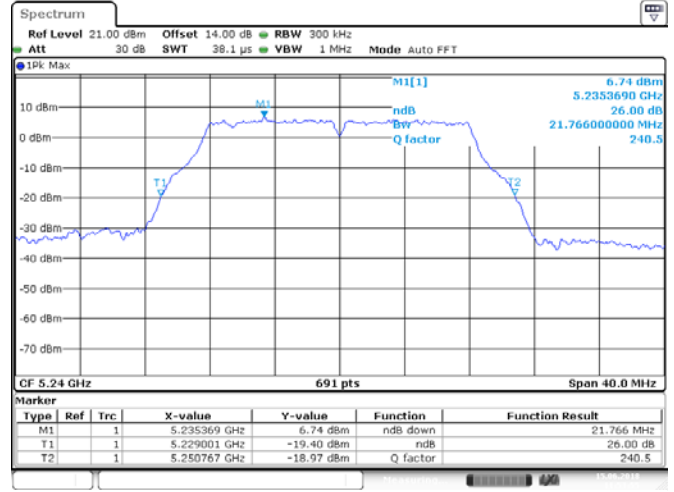

Date: 15.JUN.2018 11:53:55

ANT 1(11N20)

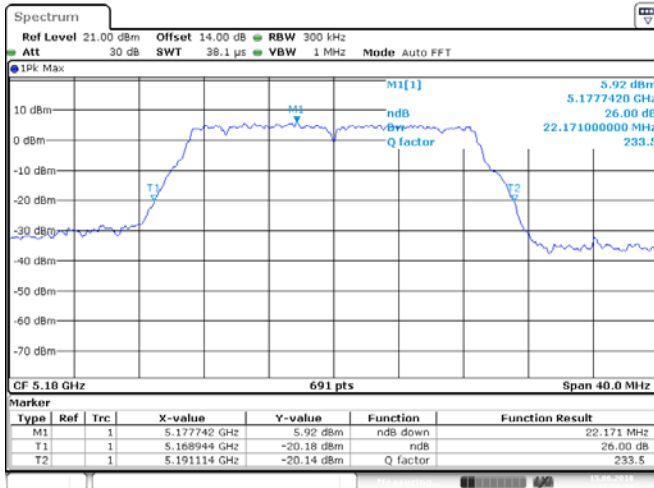

Date: 15.JUN.2018 11:58:38

ANT 2(11N20)

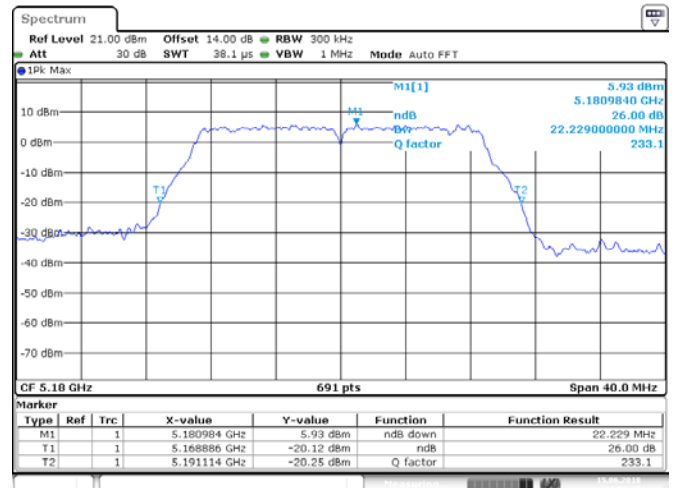

Date: 15.JUN.2018 11:57:47

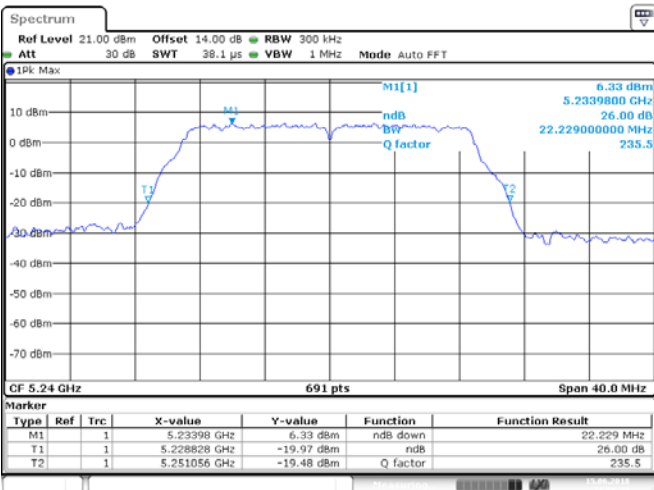

Date: 15.JUN.2018 11:56:22

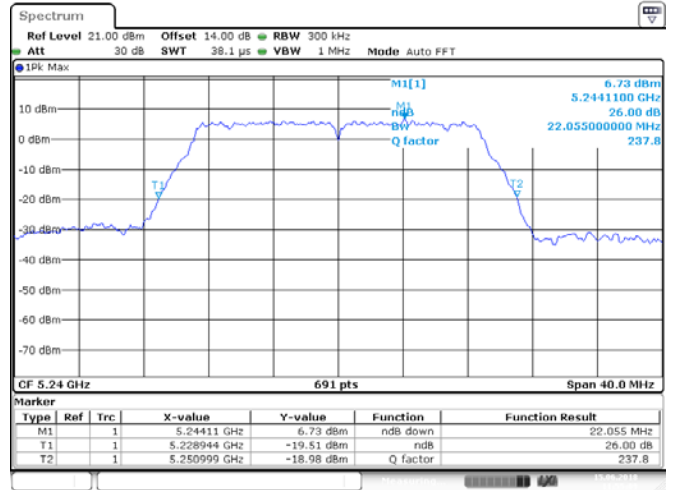

Date: 15.JUN.2018 11:55:09

ANT 1(802.11ac20)

ANT 2(802.11ac20)

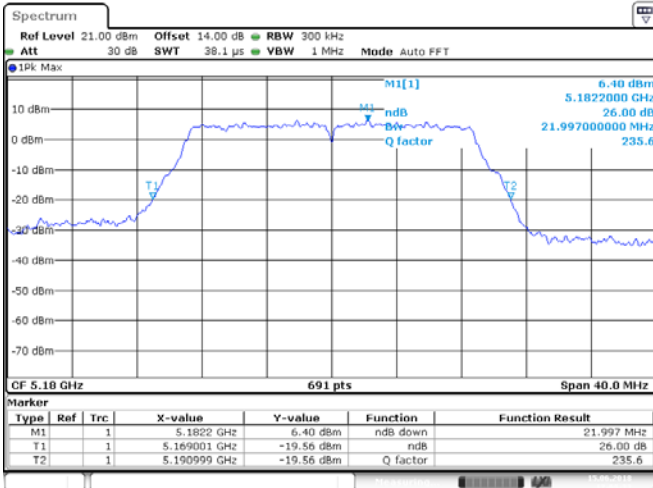

Date: 15.JUN.2018 12:00:33

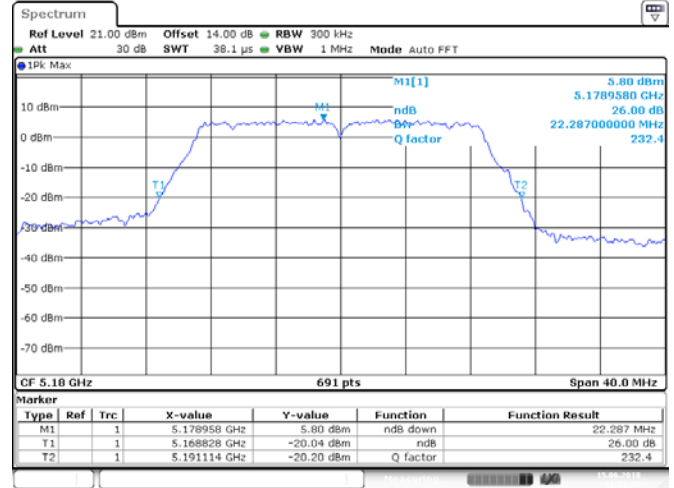

Date: 15.JUN.2018 11:59:49

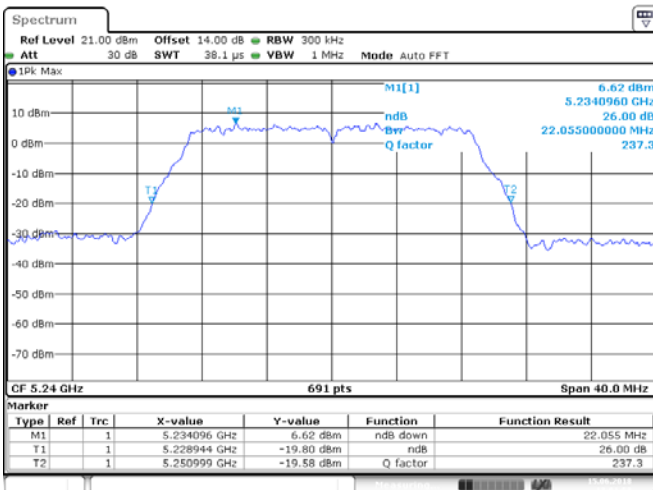

Date: 15.JUN.2018 12:01:58

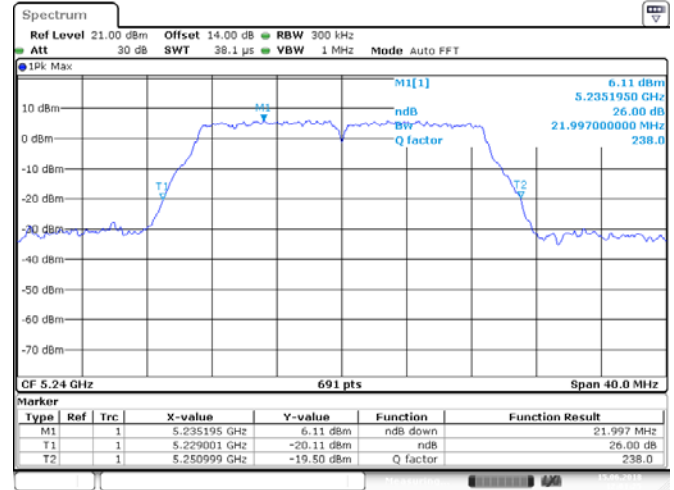

Date: 15.JUN.2018 12:01:25

ANT 1(802.11n40)

ANT 2(802.11n40)

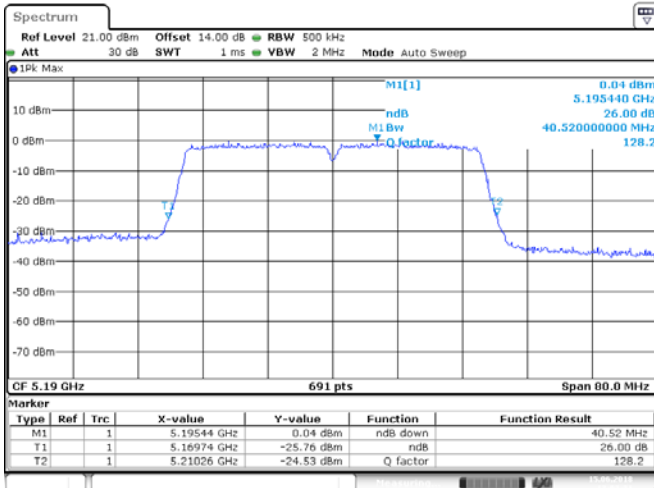

Date: 15.JUN.2018 12:03:31

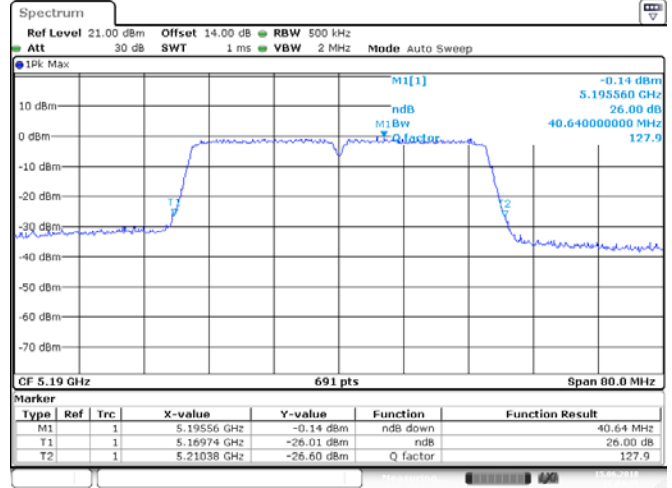

Date: 15.JUN.2018 12:04:35

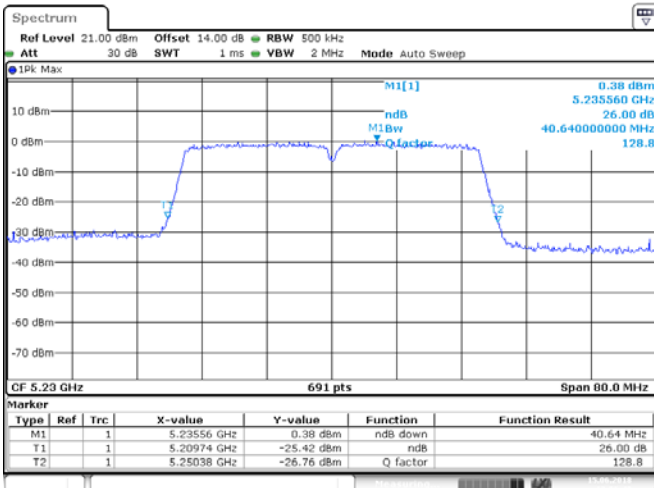

Date: 15.JUN.2018 12:06:40

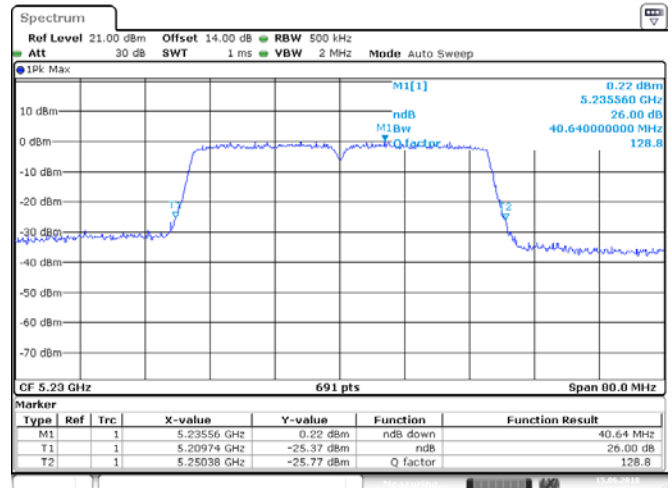

Date: 15.JUN.2018 12:07:11

ANT 1(802.11ac40)

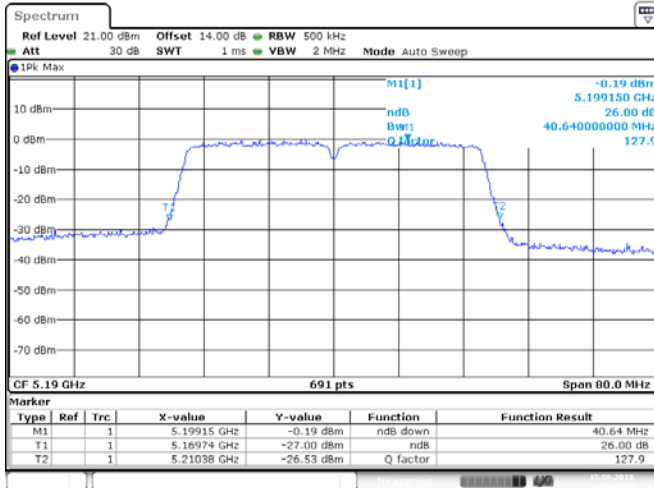

Date: 15.JUN.2018 12:13:24

ANT 2(802.11ac40)

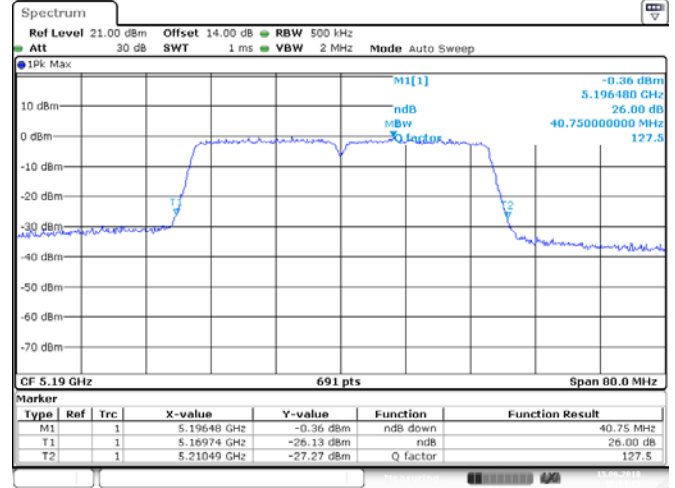

Date: 15.JUN.2018 12:14:15

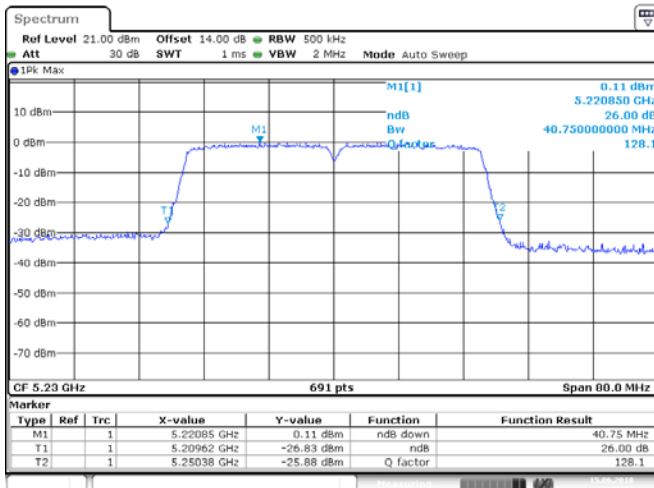

Date: 15.JUN.2018 12:08:11

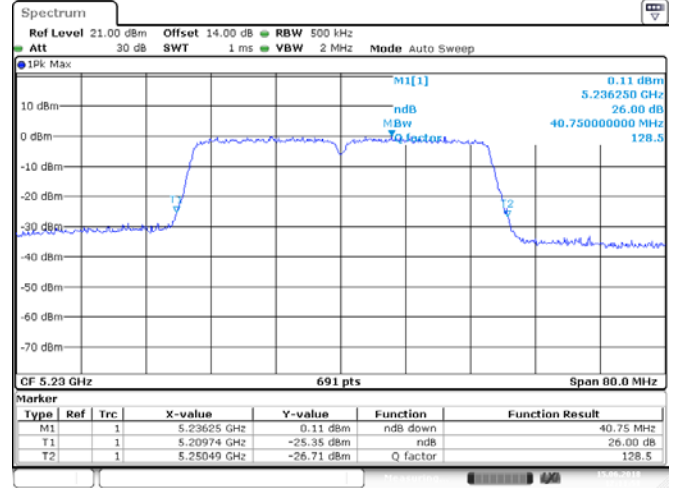

Date: 15.JUN.2018 12:11:58

ANT 1(802.11ac80)

ANT 2(802.11ac80)

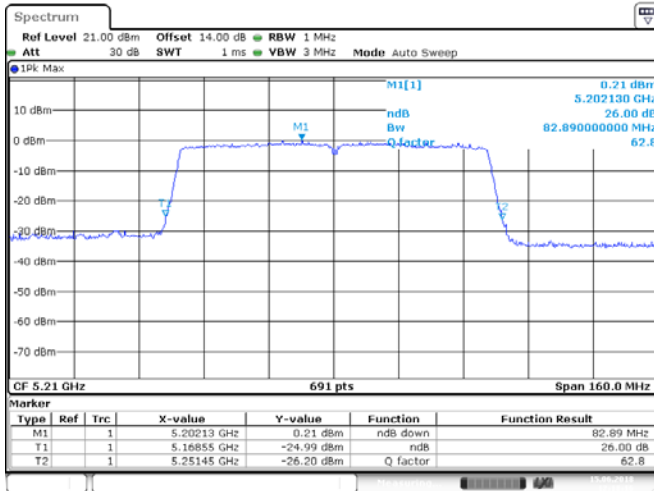

Date: 15.JUN.2018 12:18:16

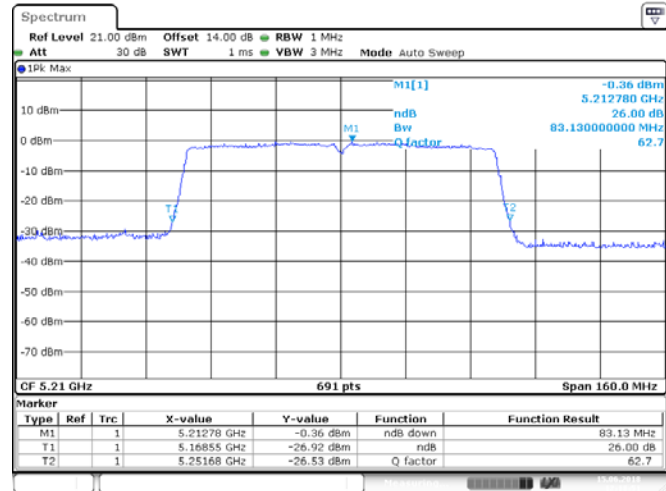

Date: 15.JUN.2018 12:18:51

7. 99% BANDWIDTH MEASUREMENT

7.1. Block Diagram of Test Setup

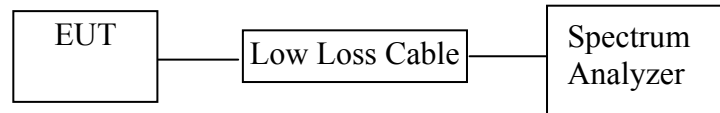

7.2. The Requirement For Section 15.407

The 99% occupied bandwidth is the frequency bandwidth such that, below its lower and above its upper frequency limits, the mean powers are each equal to 0.5 % of the total mean power of the given emission. Measurement of the 99% occupied bandwidth is required only as a condition for using the optional band-edge measurement techniques described in section II.G.3.d). Measurements of 99% occupied bandwidth may also optionally be used in lieu of the EBW to define the minimum frequency range over which the spectrum is integrated when measuring maximum conducted output power as described in section II.E. However, the EBW must be measured to determine bandwidth dependent limits on maximum conducted output power in accordance with 15.407(a).

7.3. EUT Configuration on Measurement

The equipment are installed on the emission measurement to meet the commission requirements and operating regulations in a manner which tends to maximize its emission characteristics in normal application.

7.4. Operating Condition of EUT

7.4.1. Setup the EUT and simulator as shown as Section 7.1.

7.4.2. Turn on the power of all equipment.

7.4.3. Let the EUT work in TX modes measure it. The transmit frequency are 5150-5250 and 5725-5850MHz.

7.5. Test Procedure

1. Set center frequency to the nominal EUT channel center frequency.
2. Set span = 1.5 times to 5.0 times the OBW.
3. Set RBW = 1 % to 5 % of the OBW. Set VBW $\geq 3 * RBW$
4. Video averaging is not permitted. Where practical, a sample detection and single sweep mode shall be used. Otherwise, peak detection and max hold mode (until the trace stabilizes) shall be used.
5. Use the 99 % power bandwidth function of the instrument.

6. If the instrument does not have a 99 % power bandwidth function, the trace data points are recovered and directly summed in power units. The recovered amplitude data points, beginning at the lowest frequency, are placed in a running sum until 0.5 % of the total is reached; that frequency is recorded as the lower frequency. The process is repeated until 99.5 % of the total is reached; that frequency is recorded as the upper frequency. The 99% occupied bandwidth is the difference between these two frequencies.

7.6. Test Result

The test was performed with 802.11a				
Channel	Frequency (MHz)	99% Bandwidth ANT 1 (MHz)	99% Bandwidth ANT 2(MHz)	Verdict
36	5180	17.192	17.192	PASS
48	5240	17.192	17.192	PASS
149	5745	17.250	17.192	PASS
165	5825	17.192	17.250	PASS

The test was performed with 802.11n20				
Channel	Frequency (MHz)	99% Bandwidth ANT 1 (MHz)	99% Bandwidth ANT 2(MHz)	Verdict
36	5180	18.234	18.177	PASS
48	5240	18.350	18.292	PASS
149	5745	18.408	18.234	PASS
165	5825	18.292	18.234	PASS

The test was performed with 802.11ac20				
Channel	Frequency (MHz)	99% Bandwidth ANT 1 (MHz)	99% Bandwidth ANT 2(MHz)	Verdict
36	5180	18.234	18.177	PASS
48	5240	18.119	18.350	PASS
149	5745	18.177	18.234	PASS
165	5825	18.292	18.350	PASS

The test was performed with 802.11n40				
Channel	Frequency (MHz)	99% Bandwidth ANT 1 (MHz)	99% Bandwidth ANT 2(MHz)	Verdict
38	5190	37.048	37.048	PASS
46	5230	37.048	37.048	PASS
151	5755	37.279	37.164	PASS
159	5795	37.164	37.164	PASS

The test was performed with 802.11ac40				
Channel	Frequency (MHz)	99% Bandwidth ANT 1 (MHz)	99% Bandwidth ANT 2(MHz)	Verdict
38	5190	36.932	36.932	PASS
46	5230	36.932	37.048	PASS
151	5755	37.164	37.279	PASS
159	5795	37.164	37.164	PASS

The test was performed with 802.11ac80				
Channel	Frequency (MHz)	99% Bandwidth ANT 1 (MHz)	99% Bandwidth ANT 2(MHz)	Verdict
42	5210	76.179	76.411	PASS
155	5775	76.411	76.179	PASS

The spectrum analyzer plots are attached as below.

99% Bandwidth

ANT 1(11A)

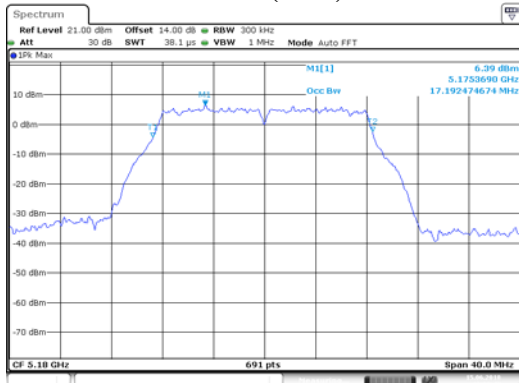

Date: 15 JUN 2018 12:20:47

ANT 2(11A)

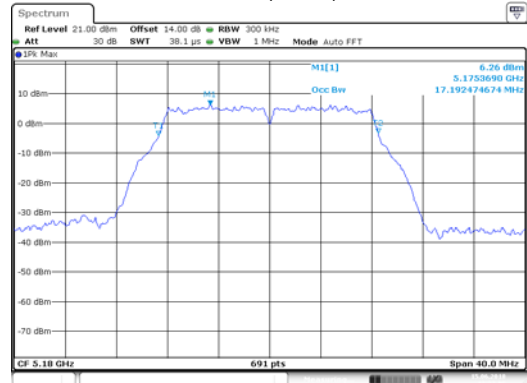

Date: 15 JUN 2018 12:22:05

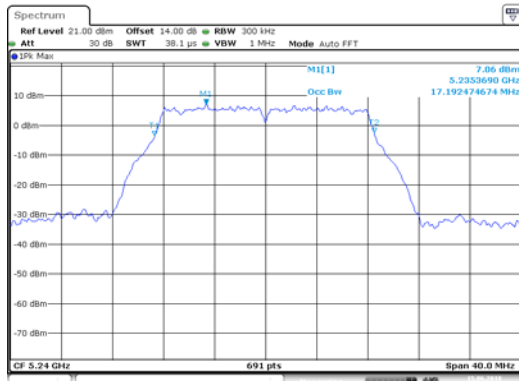

Date: 15 JUN 2018 12:23:21

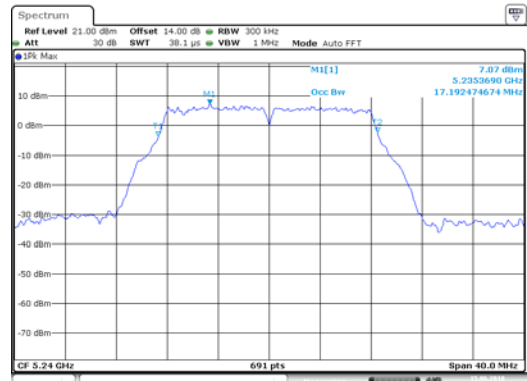

Date: 15 JUN 2018 12:24:04

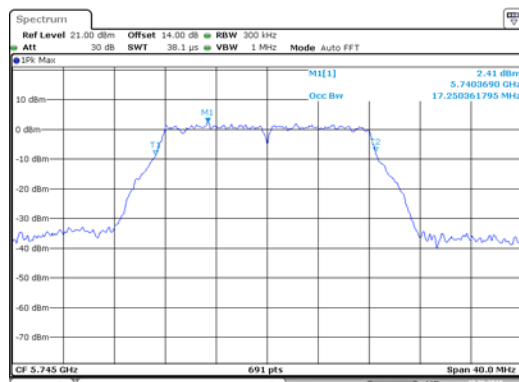

Date: 15 JUN 2018 12:38:59

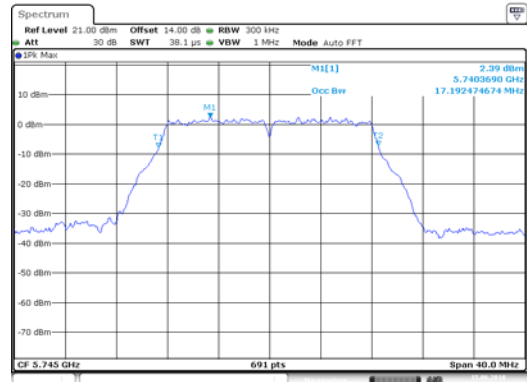

Date: 15 JUN 2018 12:39:59

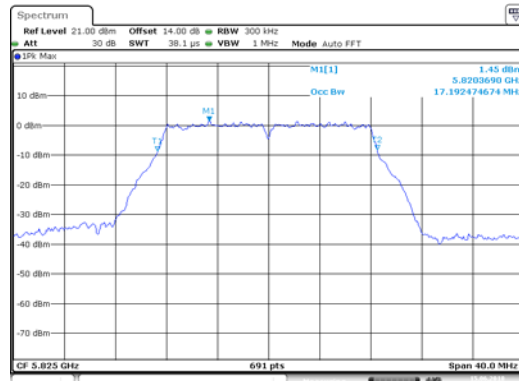

Date: 15 JUN 2018 12:41:14

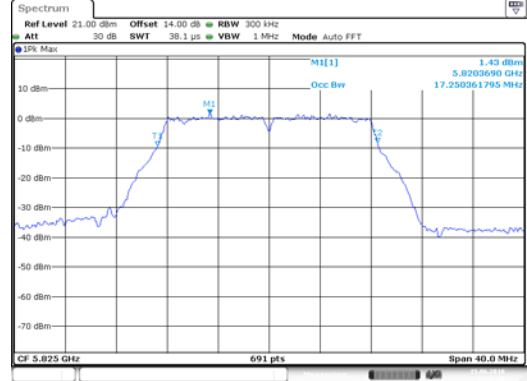

Date: 15 JUN 2018 12:42:23

ANT 1(11N20)

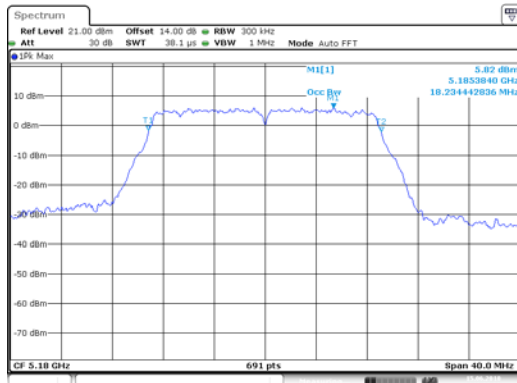

Date: 15.JUN.2018 12:26:03

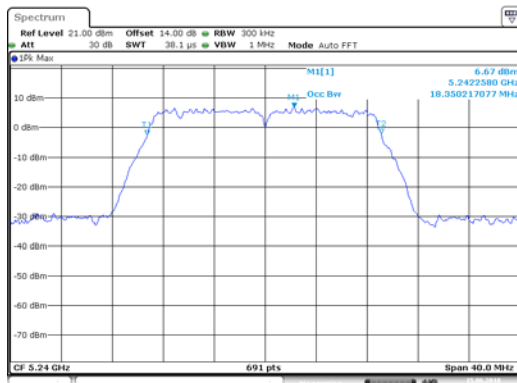

Date: 15.JUN.2018 12:27:08

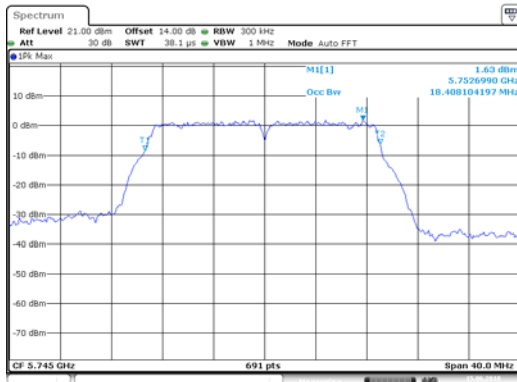

Date: 15.JUN.2018 12:37:12

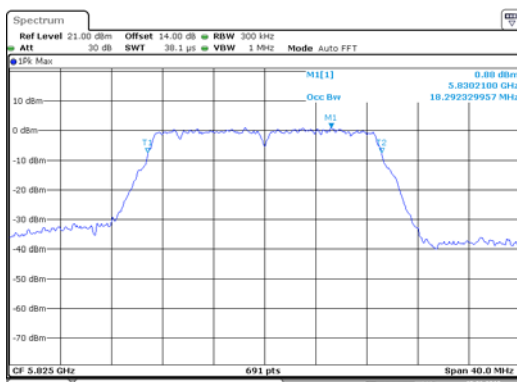

Date: 15.JUN.2018 12:35:45

ANT 2(11N20)

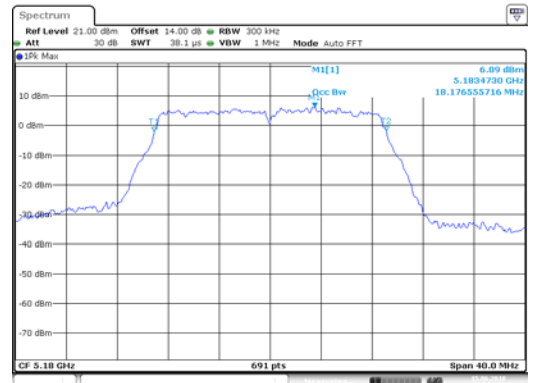

Date: 15.JUN.2018 12:25:07

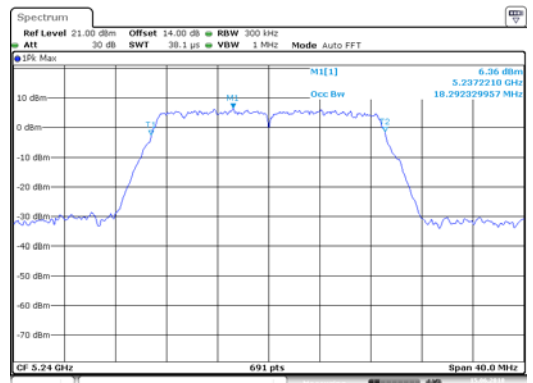

Date: 15.JUN.2018 12:27:45

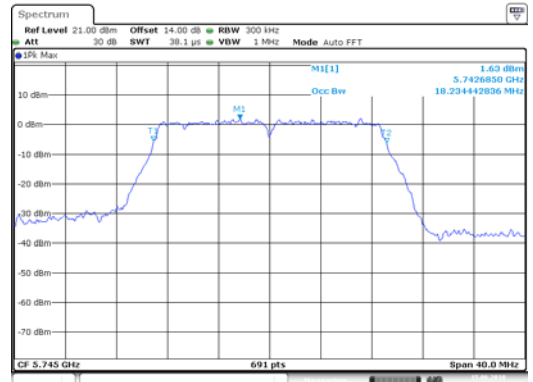

Date: 15.JUN.2018 12:36:33

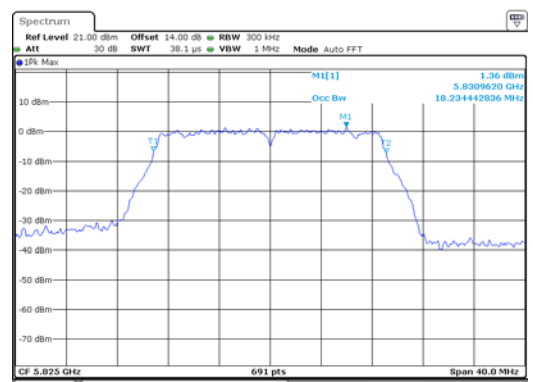

Date: 15.JUN.2018 12:35:06

ANT 1(11AC20)

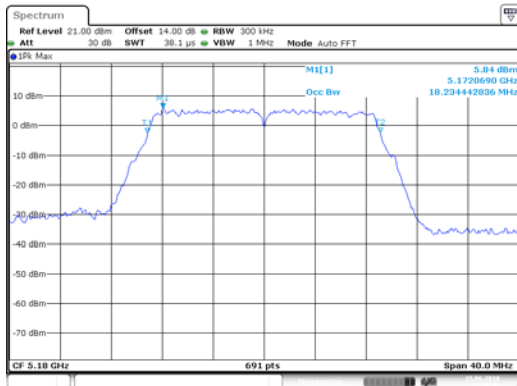

Date: 15 JUN 2018 12:28:40

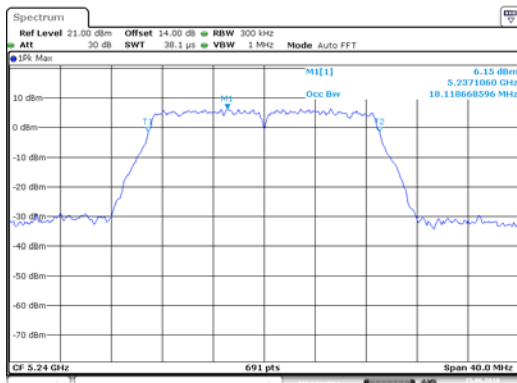

Date: 15 JUN 2018 12:30:16

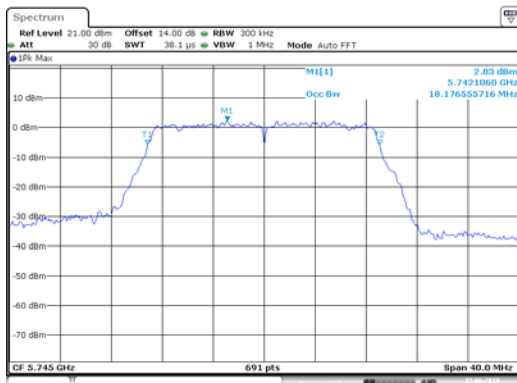

Date: 15 JUN 2018 12:32:03

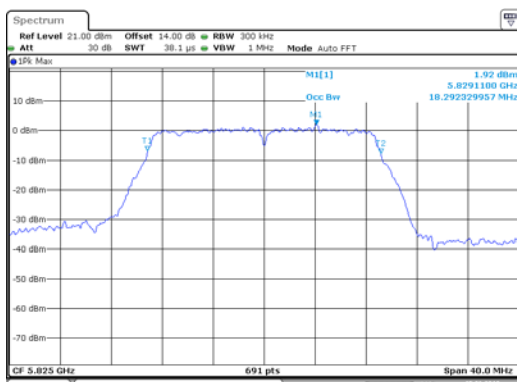

Date: 15 JUN 2018 12:33:35

ANT 2(11AC20)

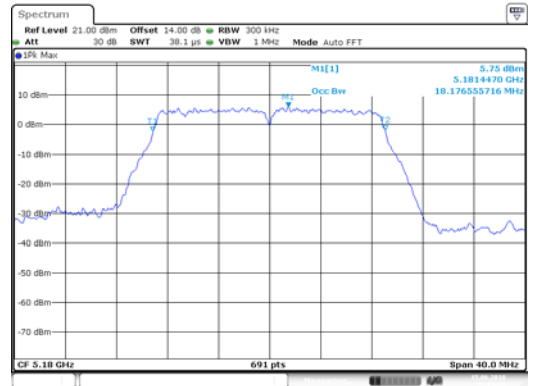

Date: 15 JUN 2018 12:29:25

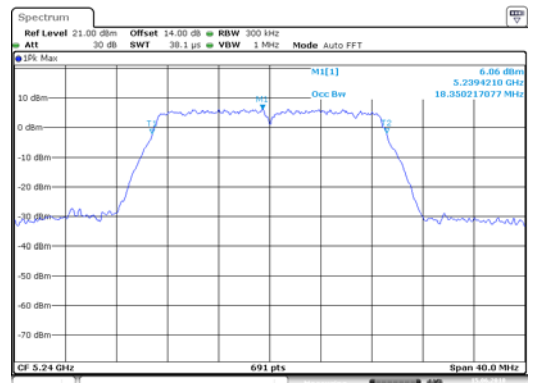

Date: 15 JUN 2018 12:30:59

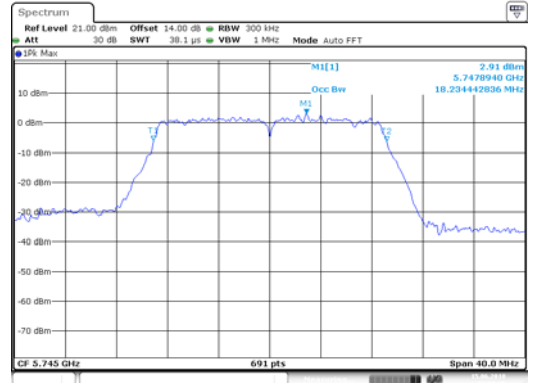

Date: 15 JUN 2018 12:32:34

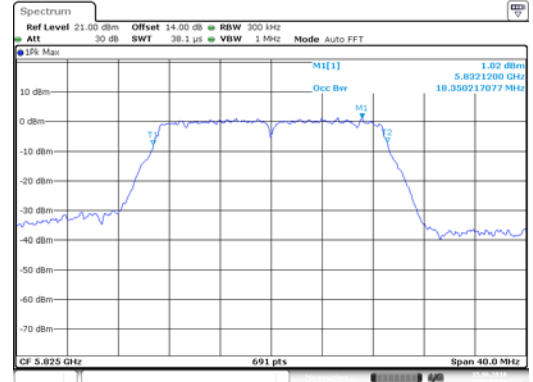

Date: 15 JUN 2018 12:34:12

ANT 1(11N40)

ANT 2(11N40)

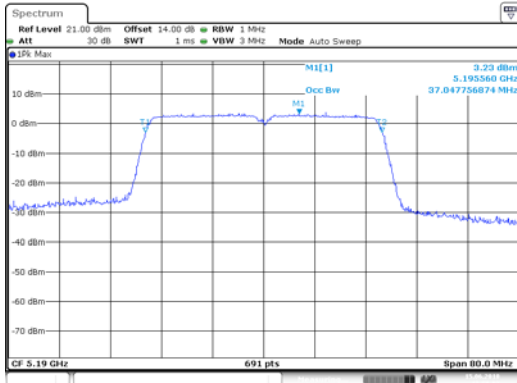

Date: 15 JUN 2018 13:50:07

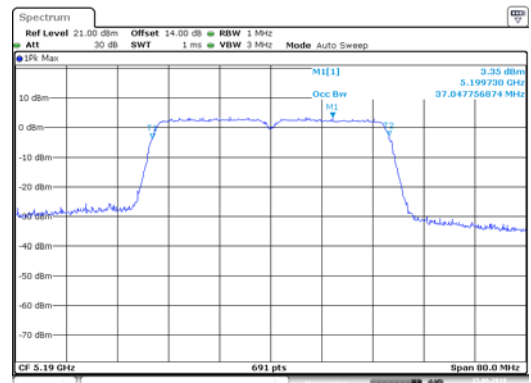

Date: 15 JUN 2018 13:49:11

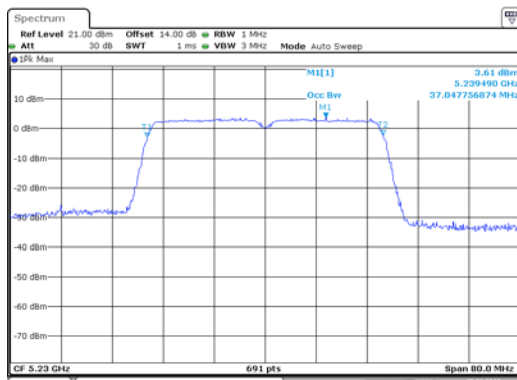

Date: 15 JUN 2018 13:51:08

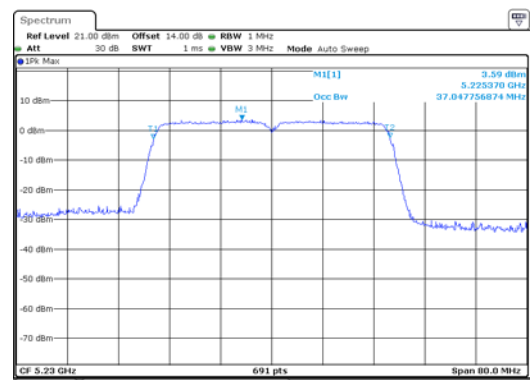

Date: 15 JUN 2018 13:51:45

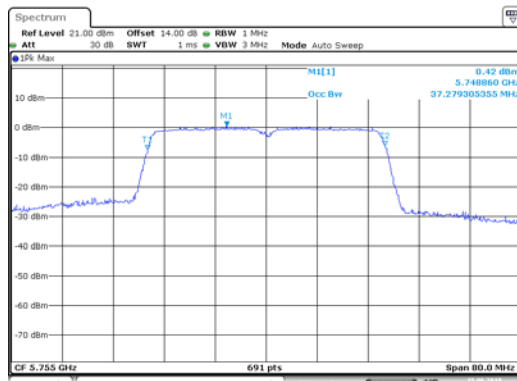

Date: 15 JUN 2018 14:02:13

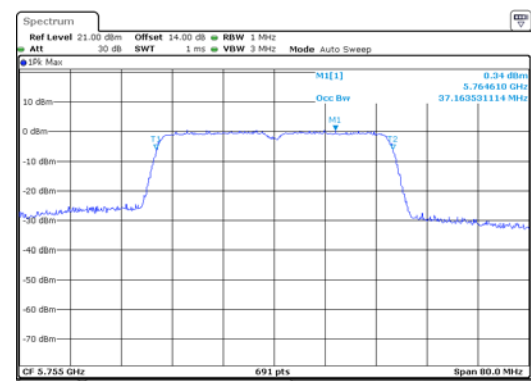

Date: 15 JUN 2018 14:01:38

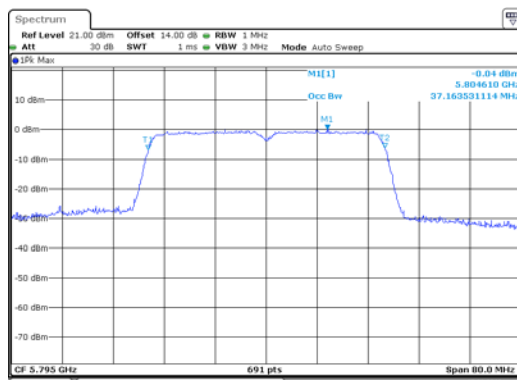

Date: 15 JUN 2018 14:00:13

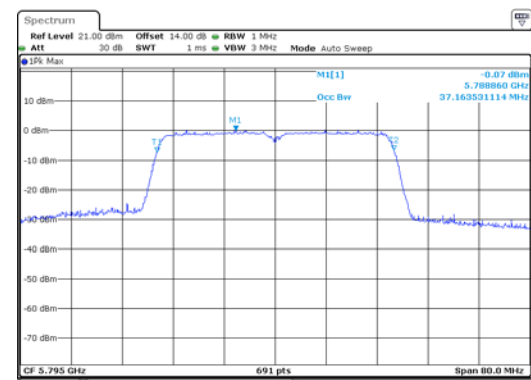

Date: 15 JUN 2018 13:59:31

ANT 1(11AC40)

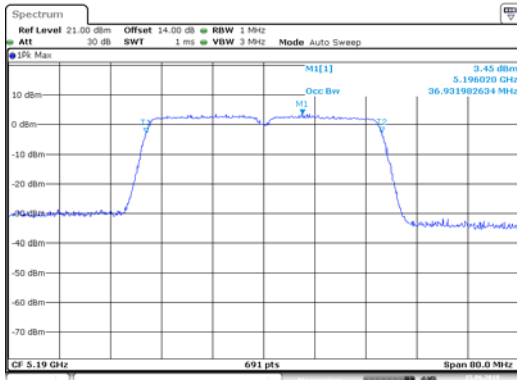

Date: 15 JUN 2018 13:52:37

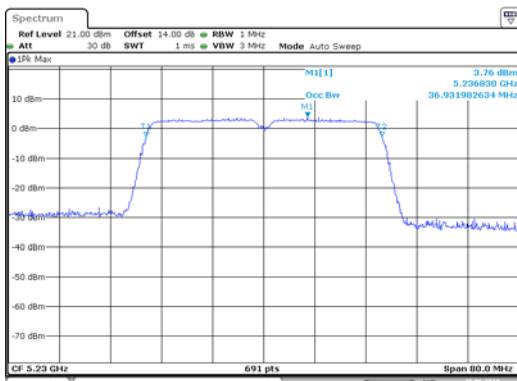

Date: 15 JUN 2018 13:54:16

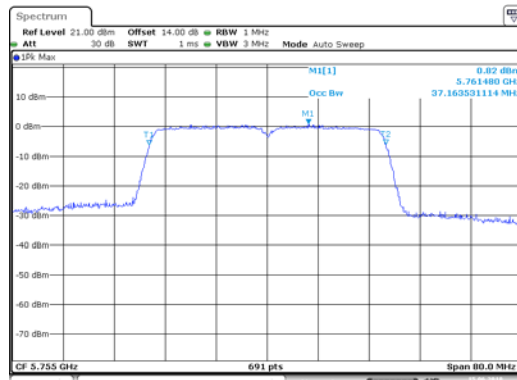

Date: 15 JUN 2018 13:56:19

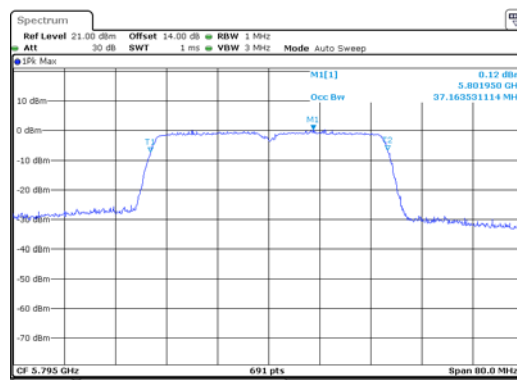

Date: 15 JUN 2018 13:58:33

ANT 2(11AC40)

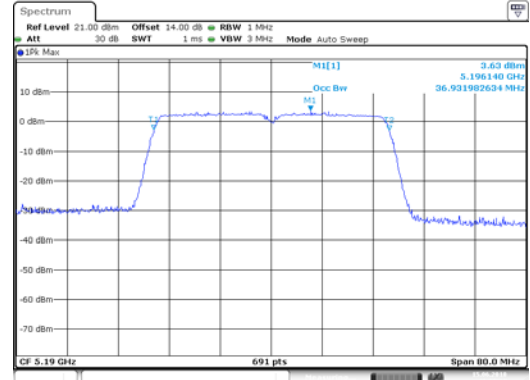

Date: 15 JUN 2018 13:53:17

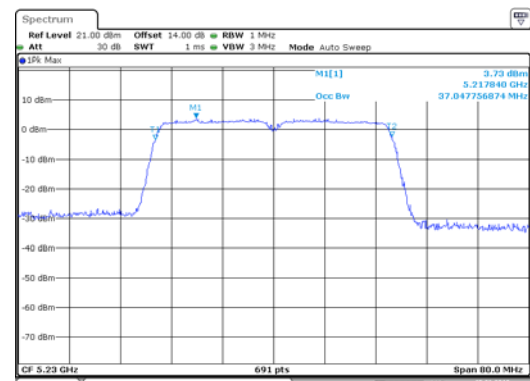

Date: 15 JUN 2018 13:54:54

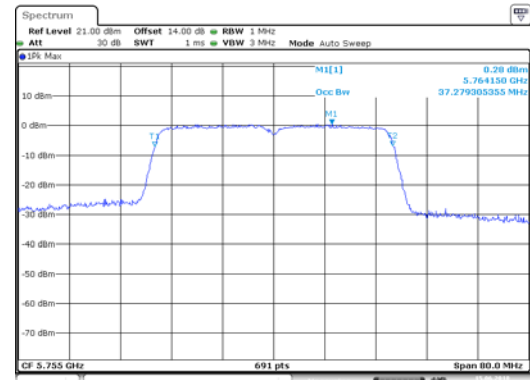

Date: 15 JUN 2018 13:57:07

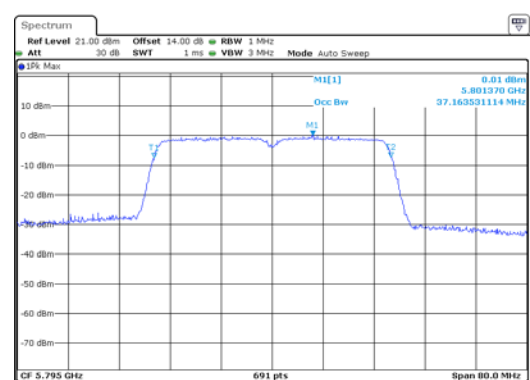

Date: 15 JUN 2018 13:58:02

ANT 1(11AC80)

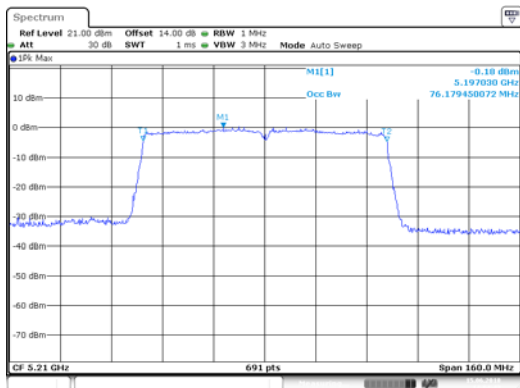

Date: 15 JUN 2018 14:04:43

ANT 2(11AC80)

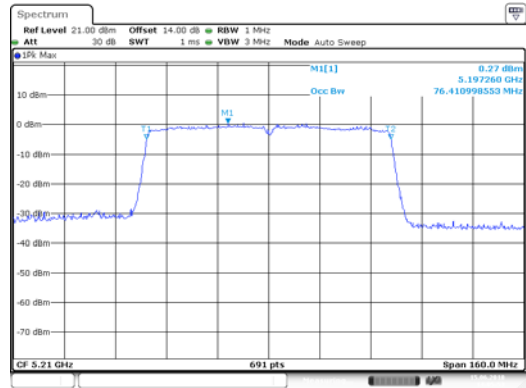

Date: 15 JUN 2018 14:05:53

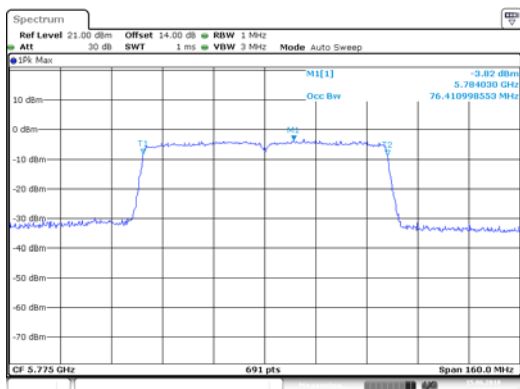

Date: 15 JUN 2018 14:07:47

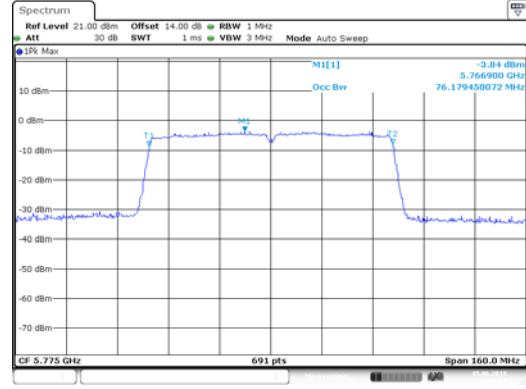

Date: 15 JUN 2018 14:07:08

8. DUTY CYCLE MEASUREMENT

8.1. Block Diagram of Test Setup

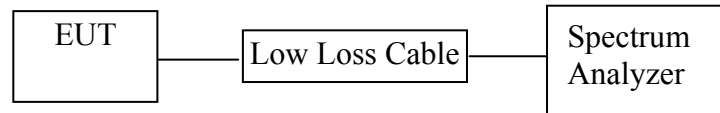

8.2. EUT Configuration on Measurement

The equipment are installed on the emission measurement to meet the commission requirements and operating regulations in a manner which tends to maximize its emission characteristics in normal application.

8.3. Operating Condition of EUT

8.3.1. Setup the EUT and simulator as shown as Section 8.1.

8.3.2. Turn on the power of all equipment.

8.3.3. Let the EUT work in TX modes measure it. The transmit frequency are 5150-5250 and 5725-5850MHz.

8.4. Test Procedure

Measurements of duty cycle and transmission duration shall be performed using one of the following techniques:

1. A diode detector and an oscilloscope that together have sufficiently short response time to permit accurate measurements of the on- and off-times of the transmitted signal.
2. The zero-span mode on a spectrum analyzer or EMI receiver if the response time and spacing between bins on the sweep are sufficient to permit accurate measurements of the on- and off-times of the transmitted signal
 - a. Set the center frequency of the instrument to the centre frequency of the transmission
 - b. Set $RBW \geq OBW$ if possible; otherwise, set RBW to the largest available value(10MHz).
 - c. Set detector = Peak or average.
 - d. The zero-span measurement method shall not be used unless both RBW and VBW are $> 50/T$ and the number of sweep points across duration T exceeds 100.
(For example, if VBW and/or RBW are limited to 3MHz, then the zero-span method of measuring duty cycle shall not be used if $T \leq 16.7$ microseconds.)

8.5. Test Result

Test mode	Frequency (MHz)	Duty cycle(%) ANT 1	Duty cycle(%) ANT 2	10log(1/x)) ANT 1	10log(1/x)) ANT 2
802.11a20	5180	96.86	96.86	0.14	0.14
802.11n20	5180	96.86	96.66	0.14	0.15
802.11ac20	5180	96.69	96.68	0.15	0.15
802.11n40	5190	93.45	93.45	0.29	0.29
802.11ac40	5190	93.55	93.53	0.29	0.29
802.11ac80	5210	87.59	87.59	0.58	0.58

Note: The duty cycle of other frequency points in the same mode is the same, so we select a frequency point to test for each mode.

Duty cycle=x

The spectrum analyzer plots are attached as below.

802.11a20 5180MHz

ANT 1

ANT 2

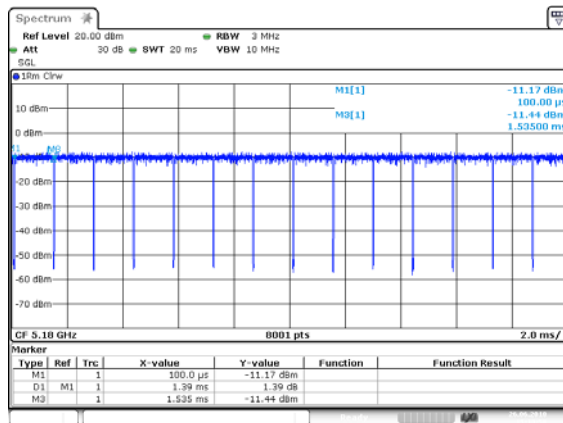

Date: 26 JUN 2018 15:13:58

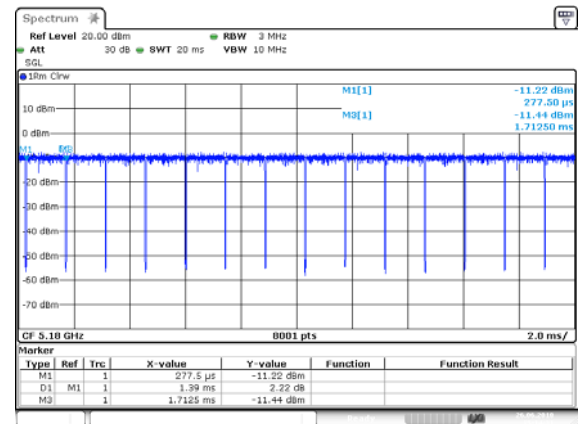

Date: 26 JUN 2018 15:14:31

802.11n20 5180MHz

ANT 1

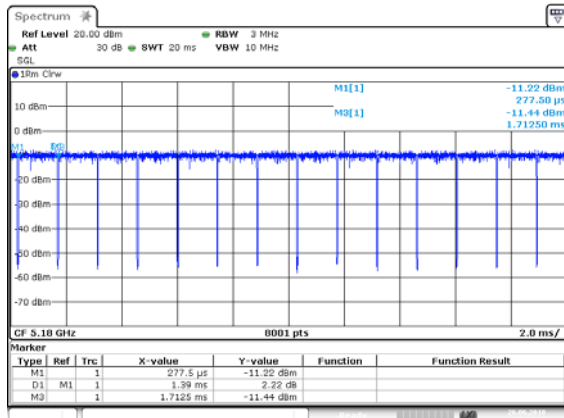

Date: 26 JUN 2018 15:14:31

ANT 2

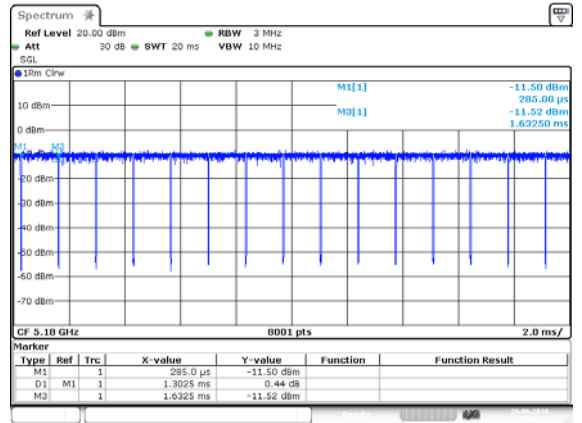

Date: 26 JUN 2018 15:16:54

802.11ac20 5180MHz

ANT 1

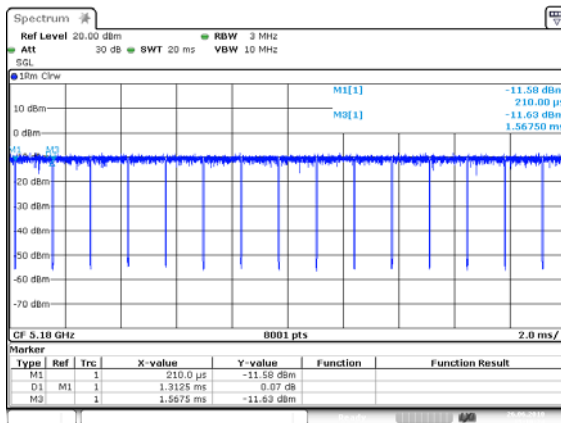

Date: 26 JUN 2018 15:18:25

ANT 2

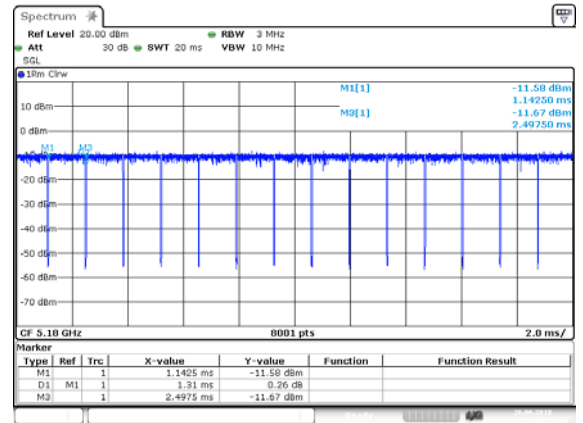

Date: 26 JUN 2018 15:18:51

802.11N40 5190MHz

ANT 1

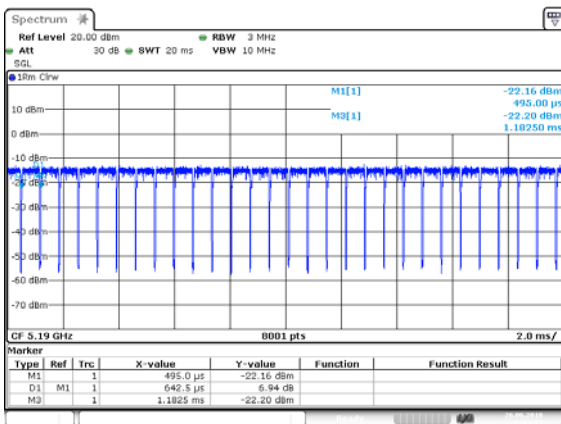

Date: 26 JUN 2018 15:31:58

ANT 2

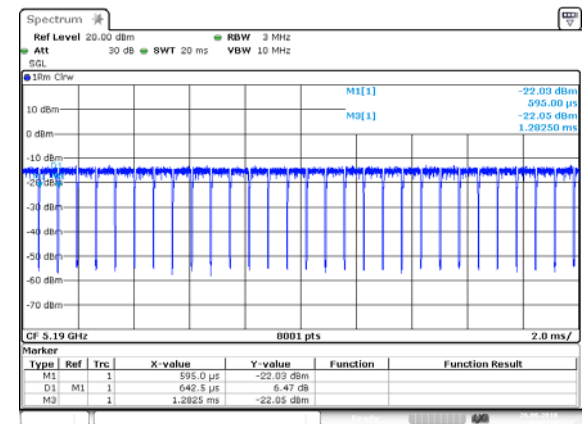

Date: 26 JUN 2018 15:32:17

802.11ac40 5190MHz

ANT 1

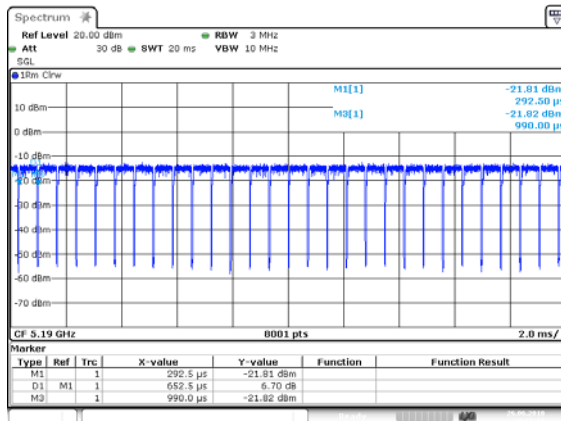

Date: 26.JUN.2018 15:25:58

ANT 2

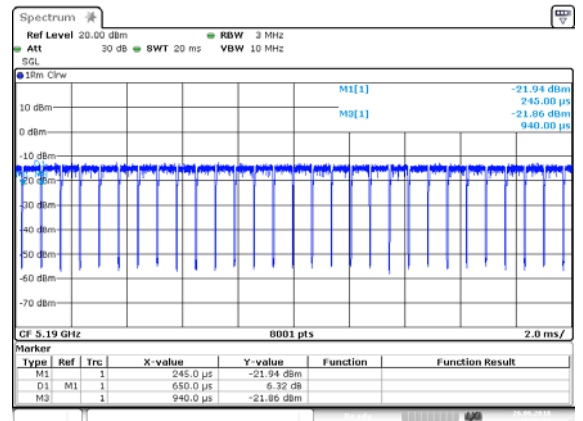

Date: 26.JUN.2018 15:26:13

802.11ac80 5210MHz

ANT 1

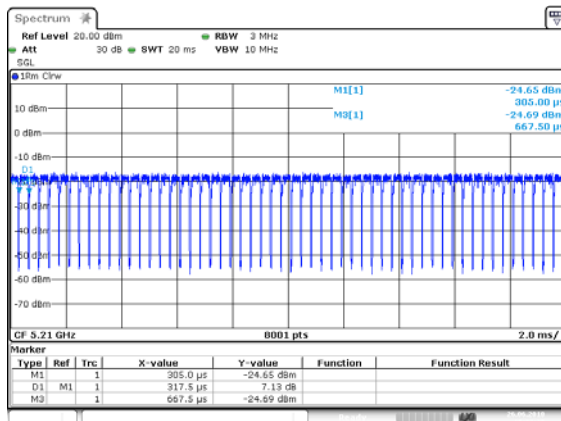

Date: 26.JUN.2018 15:33:21

ANT 2

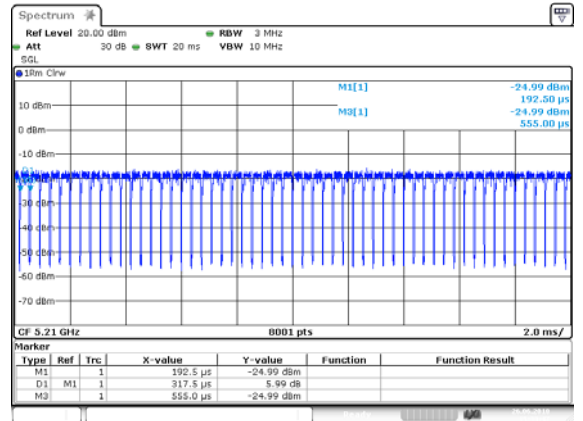

Date: 26.JUN.2018 15:33:47

9. MAXIMUM POWER SPECTRAL DENSITY TEST

9.1. Block Diagram of Test Setup

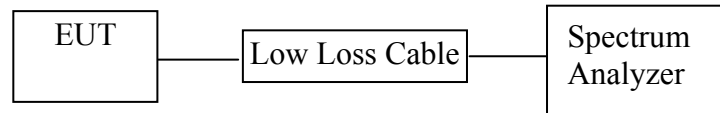

9.2. The Requirement For Section 15.407

Section 15.407: For mobile and portable client devices in the 5.15–5.25 GHz band, the maximum conducted output power over the frequency band of operation shall not exceed 250 mW provided the maximum antenna gain does not exceed 6 dBi. In addition, the maximum power spectral density shall not exceed 11 dBm in any 1 megahertz band. If transmitting antennas of directional gain greater than 6 dBi are used, both the maximum conducted output power and the maximum power spectral density shall be reduced by the amount in dB that the directional gain of the antenna exceeds 6 dBi.

For the band 5.725–5.85 GHz, the maximum conducted output power over the frequency band of operation shall not exceed 1 W. In addition, the maximum power spectral density shall not exceed 30 dBm in any 500-kHz band. If transmitting antennas of directional gain greater than 6 dBi are used, both the maximum conducted output power and the maximum power spectral density shall be reduced by the amount in dB that the directional gain of the antenna exceeds 6 dBi.

9.3. EUT Configuration on Measurement

The equipment are installed on the emission Measurement to meet the commission requirements and operating regulations in a manner which tends to maximize its emission characteristics in normal application.

9.4. Operating Condition of EUT

9.4.1. Setup the EUT and simulator as shown as Section 9.1.

9.4.2. Turn on the power of all equipment.

9.4.3. Let the EUT work in TX modes measure it. The transmit frequency are 5150-5250 and 5725-5850MHz.

9.5. Test Procedure

9.5.1. The transmitter output was connected to the spectrum analyzer through a low loss cable.

9.5.2. Measurement Procedure PKPSD:

For devices operating in the bands 5.15-5.25 GHz, 5.25-5.35 GHz, and 5.47-5.725 GHz, the above procedures make use of 1 MHz RBW to satisfy directly the 1 MHz reference bandwidth specified in § 15.407(a)(5). For devices operating in the band 5.725-5.85 GHz, the rules specify a measurement bandwidth of 500 kHz. Many spectrum analyzers do not have 500 kHz RBW, thus a narrower RBW may need to be used. The rules permit the use of a RBW less than 1 MHz, or 500 kHz, “provided that the measured power is integrated over the full reference bandwidth” to show the total power over the specified measurement bandwidth (i.e., 1 MHz, or 500 kHz). If measurements are performed using a reduced resolution bandwidth (< 1 MHz, or < 500 kHz) and integrated over 1 MHz, or 500 kHz bandwidth, the following adjustments to the procedures apply:

1. Set $RBW \geq 1/T$, where T is defined in section II.B.1.a). Set $VBW \geq 3 RBW$.
2. If measurement bandwidth of Maximum PSD is specified in 500 kHz, add $10 \log(500 \text{ kHz}/RBW)$ to the measured result, whereas RBW (< 500 kHz) is the reduced resolution bandwidth of the spectrum analyzer set during measurement.
3. If measurement bandwidth of Maximum PSD is specified in 1 MHz, add $10 \log(1\text{MHz}/RBW)$ to the measured result, whereas RBW (< 1 MHz) is the reduced resolution bandwidth of spectrum analyzer set during measurement.
4. Care must be taken to ensure that the measurements are performed during a period of continuous transmission or are corrected upward for duty cycle.
5. Detector = RMS.
6. Sweep time = auto couple.
7. Trace mode = max hold.
8. Allow trace to fully stabilize.
9. Use the peak marker function to determine the maximum amplitude level.

9.5.3. Measurement the maximum power spectral density.

9.6. Test Result

The test was performed with 802.11a(SISO)							
Channel	Frequency (MHz)	Power Spectral Density ANT 1 (dBm)	Power Spectral Density ANT 2 (dBm)	Final Power Spectral Density ANT 1 (dBm)	Final Power Spectral Density ANT 2 (dBm)	Limit (dBm)	Verdict
36	5180	2.54	2.53	2.68	2.67	11	PASS
48	5240	3.00	2.87	3.14	3.01	11	PASS
149	5745	-2.55	-2.72	-2.41	-2.68	30	PASS
165	5825	-3.51	-3.59	-3.37	-3.45	30	PASS

The test was performed with 802.11 n20 (SISO)							
Channel	Frequency (MHz)	Power Spectral Density ANT 1 (dBm)	Power Spectral Density ANT 2 (dBm)	Final Power Spectral Density ANT 1 (dBm)	Final Power Spectral Density ANT 2 (dBm)	Limit (dBm)	Verdict
36	5180	2.73	2.92	2.87	3.07	11	PASS
48	5240	3.70	3.19	3.84	3.34	11	PASS
149	5745	-2.42	-2.85	-2.28	-2.70	30	PASS
165	5825	-3.28	-3.28	-3.14	-3.13	30	PASS

The test was performed with 802.11 ac20 (SISO)							
Channel	Frequency (MHz)	Power Spectral Density ANT 1 (dBm)	Power Spectral Density ANT 2 (dBm)	Final Power Spectral Density ANT 1 (dBm)	Final Power Spectral Density ANT 2 (dBm)	Limit (dBm)	Verdict
36	5180	2.60	2.66	2.75	2.81	11	PASS
48	5240	2.81	2.69	2.96	2.84	11	PASS
149	5745	-2.82	-2.90	-2.67	-2.75	30	PASS
165	5825	-3.50	-3.92	-3.35	-3.77	30	PASS

The test was performed with 802.11 n40 (SISO)							
Channel	Frequency (MHz)	Power Spectral Density ANT 1 (dBm)	Power Spectral Density ANT 2 (dBm)	Final Power Spectral Density ANT 1 (dBm)	Final Power Spectral Density ANT 2 (dBm)	Limit (dBm)	Verdict
38	5190	-0.48	-0.30	-0.19	-0.01	11	PASS
46	5230	-0.72	-0.46	-0.43	-0.17	11	PASS
151	5755	-5.21	-5.05	-4.92	-4.76	30	PASS
159	5795	-5.18	-5.86	-4.89	-5.57	30	PASS

The test was performed with 802.11 ac40 (SISO)							
Channel	Frequency (MHz)	Power Spectral Density ANT 1 (dBm)	Power Spectral Density ANT 2 (dBm)	Final Power Spectral Density ANT 1 (dBm)	Final Power Spectral Density ANT 2 (dBm)	Limit (dBm)	Verdict
38	5190	-0.70	-0.50	-0.41	-0.21	11	PASS
46	5230	-0.41	-0.32	-0.12	-0.03	11	PASS
151	5755	-5.38	-5.26	-5.09	-4.97	30	PASS
159	5795	-5.60	-5.82	-5.31	-5.53	30	PASS

The test was performed with 802.11 ac80 (SISO)							
Channel	Frequency (MHz)	Power Spectral Density ANT 1 (dBm)	Power Spectral Density ANT 2 (dBm)	Final Power Spectral Density ANT 1 (dBm)	Final Power Spectral Density ANT 2 (dBm)	Limit (dBm)	Verdict
42	5210	-4.19	-3.71	-3.61	-3.13	11	PASS
155	5775	-8.70	-9.08	-8.12	-8.50	30	PASS

The test was performed with 802.11 n20 (MIMO)

Channel	Frequency (MHz)	Power Spectral Density ANT 1 (dBm)	Power Spectral Density ANT 2 (dBm)	Final Power Spectral Density ANT 1 (dBm)	Final Power Spectral Density ANT 2 (dBm)	Final Power Spectral Density Total(dBm)	Limit (dBm)
36	5180	3.42	2.84	3.56	2.99	6.29	11
48	5240	3.22	3.52	3.36	3.67	6.53	11
149	5745	-2.31	-2.61	-2.17	-2.46	0.70	30
165	5825	-3.55	-3.74	-3.41	-3.59	-0.49	30

The test was performed with 802.11 ac20 (MIMO)

Channel	Frequency (MHz)	Power Spectral Density ANT 1 (dBm)	Power Spectral Density ANT 2 (dBm)	Final Power Spectral Density ANT 1 (dBm)	Final Power Spectral Density ANT 2 (dBm)	Final Power Spectral Density Total(dBm)	Limit (dBm)
36	5180	2.99	2.57	3.14	2.72	5.95	11
48	5240	2.70	2.90	2.85	3.05	5.96	11
149	5745	-2.57	-2.82	-2.42	-2.67	0.47	30
165	5825	-3.40	-3.72	-3.25	-3.57	-0.40	30

The test was performed with 802.11 n40 (MIMO)

Channel	Frequency (MHz)	Power Spectral Density ANT 1 (dBm)	Power Spectral Density ANT 2 (dBm)	Final Power Spectral Density ANT 1 (dBm)	Final Power Spectral Density ANT 2 (dBm)	Final Power Spectral Density Total(dBm)	Limit (dBm)
38	5190	-0.46	-0.41	-0.17	-0.12	2.87	11
46	5230	-0.33	-0.29	-0.04	0	2.99	11
151	5755	-5.26	-5.16	-4.97	-4.87	-1.91	30
159	5795	-5.76	-5.93	-5.47	-5.64	-2.54	30

The test was performed with 802.11 ac40 (MIMO)							
Channel	Frequency (MHz)	Power Spectral Density ANT 1 (dBm)	Power Spectral Density ANT 2 (dBm)	Final Power Spectral Density ANT 1 (dBm)	Final Power Spectral Density ANT 2 (dBm)	Final Power Spectral Density Total(dBm)	Limit (dBm)
38	5190	-0.47	-0.38	-0.18	-0.09	2.88	11
46	5230	-0.47	-0.67	-0.18	-0.38	2.73	11
151	5755	-5.08	-5.14	-4.79	-4.85	-1.81	30
159	5795	-5.57	-6.09	-5.28	-5.80	-2.52	30

The test was performed with 802.11 ac80 (MIMO)							
Channel	Frequency (MHz)	Power Spectral Density ANT 1 (dBm)	Power Spectral Density ANT 2 (dBm)	Final Power Spectral Density ANT 1 (dBm)	Final Power Spectral Density ANT 2 (dBm)	Final Power Spectral Density Total(dBm)	Limit (dBm)
42	5210	-3.77	-3.71	-3.19	-3.13	-0.15	11
155	5775	-8.97	-9.11	-8.39	-8.53	-5.45	30

Note: Final Power Spectral Density ANT 1= Power Spectral Density ANT 1+10log(1/x) ANT 1
 Final Power Spectral Density ANT 2= Power Spectral Density ANT 2+10log(1/x) ANT 2

The spectrum analyzer plots are attached as below.

TEST MODE:SISO

ANT 1(11A)

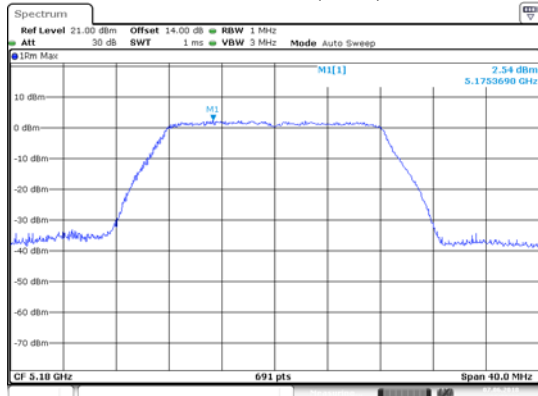

Date: 7 JUN 2018 11:31:33

ANT 2(11A)

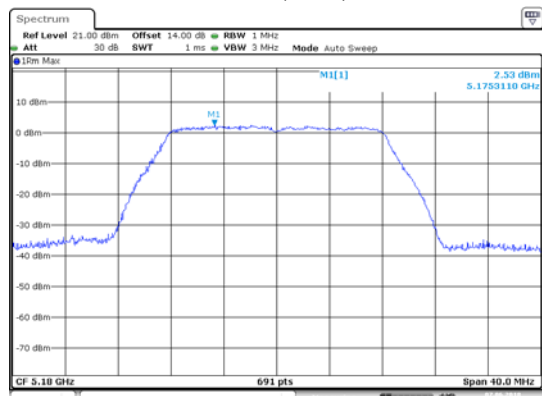

Date: 7 JUN 2018 11:32:03

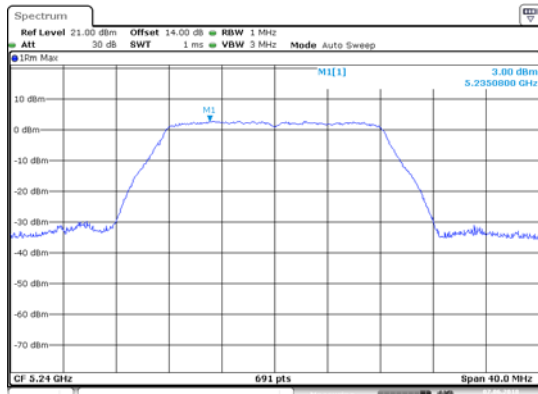

Date: 7 JUN 2018 11:32:45

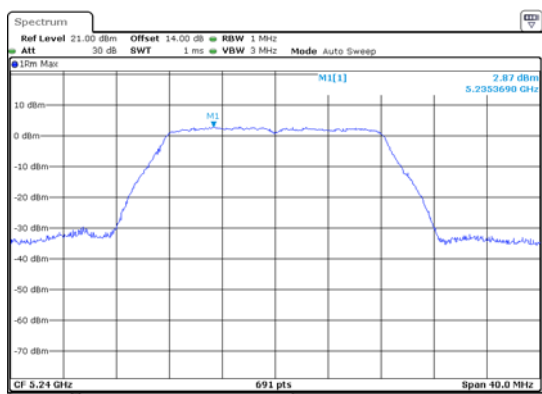

Date: 7 JUN 2018 11:33:08

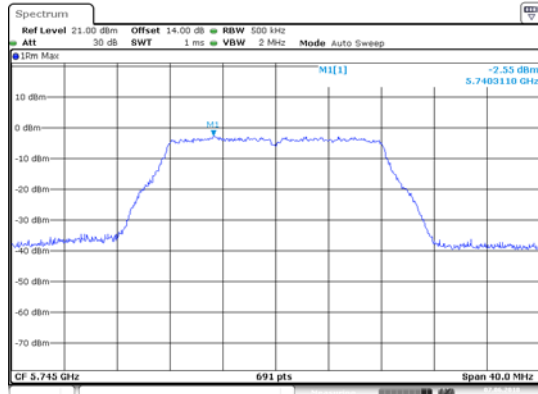

Date: 7 JUN 2018 11:34:07

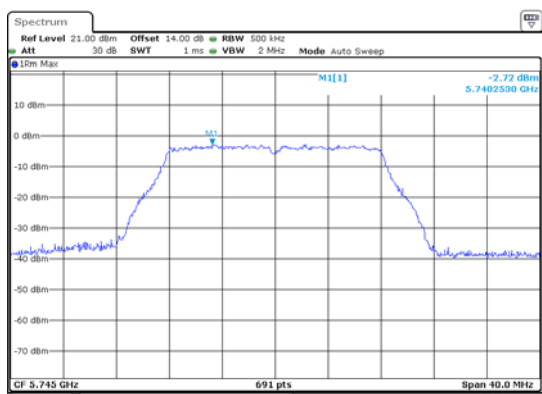

Date: 7 JUN 2018 11:34:33

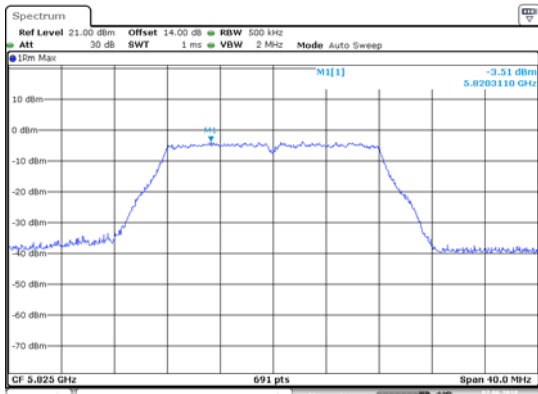

Date: 7 JUN 2018 11:35:24

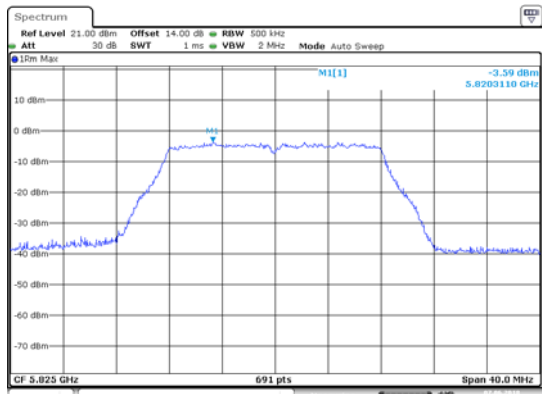

Date: 7 JUN 2018 11:35:44

ANT 1(11N20)

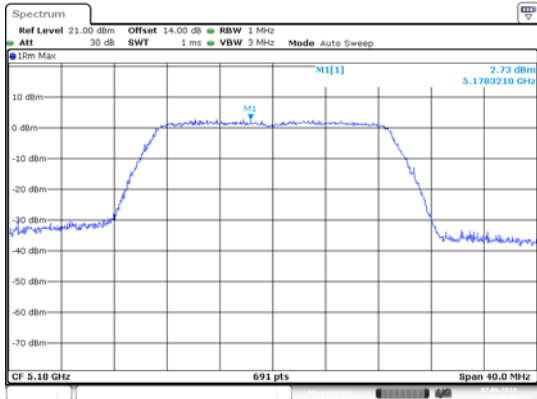

Date: 7.JUN.2018 11:28:05

ANT 2(11N20)

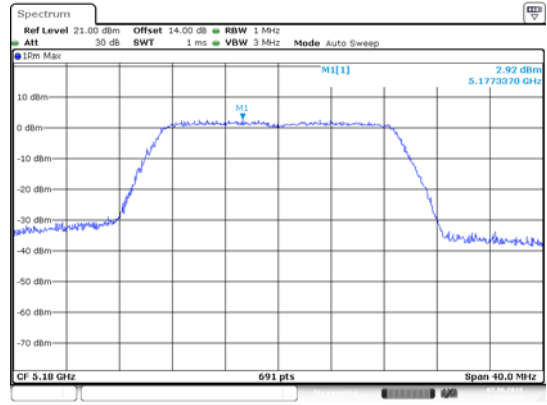

Date: 7.JUN.2018 11:28:36

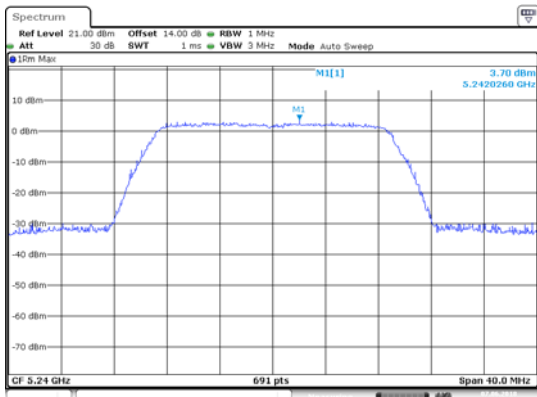

Date: 7.JUN.2018 11:29:13

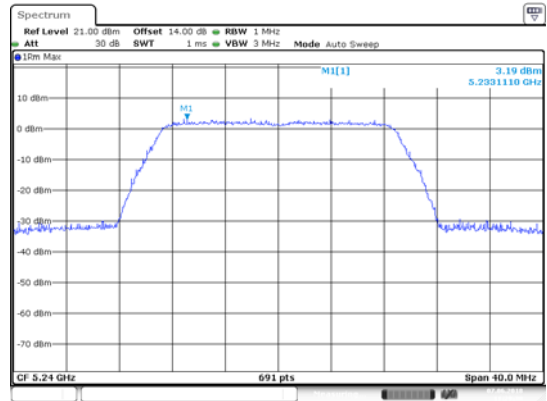

Date: 7.JUN.2018 11:29:38

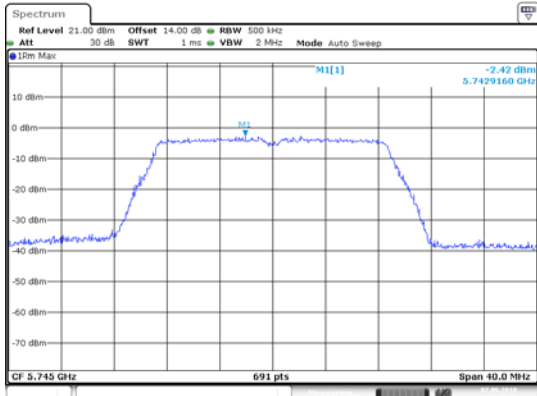

Date: 7.JUN.2018 11:26:48

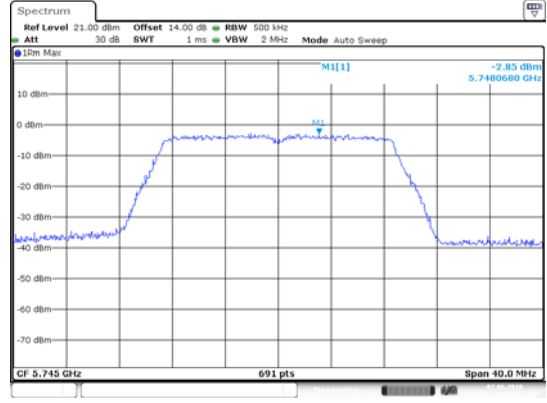

Date: 7.JUN.2018 11:27:12

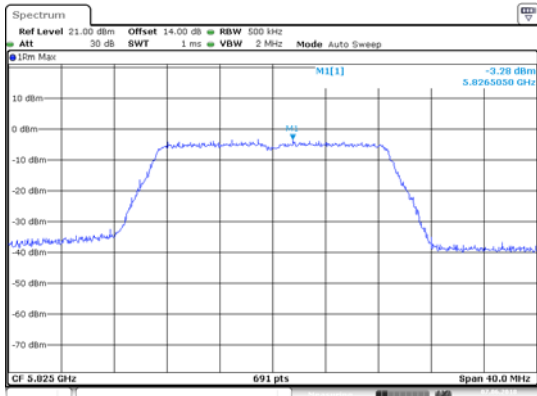

Date: 7.JUN.2018 11:25:38

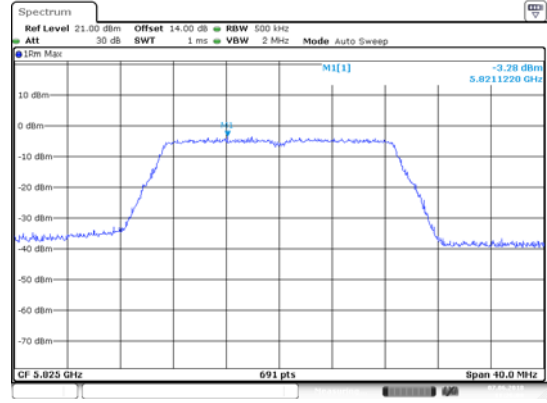

Date: 7.JUN.2018 11:26:07

ANT 1(11AC20)

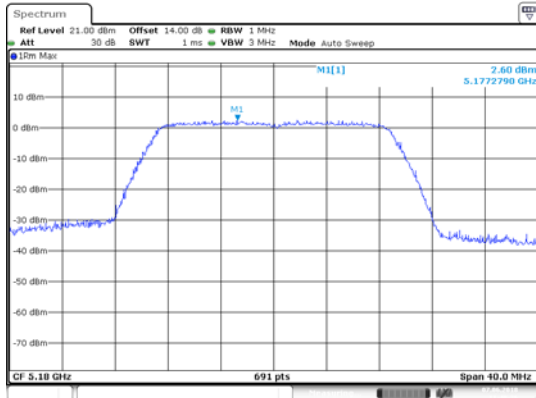

Date: 7.JUN.2018 11:40:25

ANT 2(11AC20)

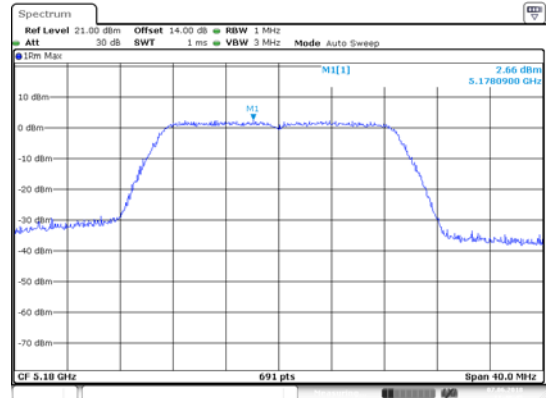

Date: 7.JUN.2018 11:40:45

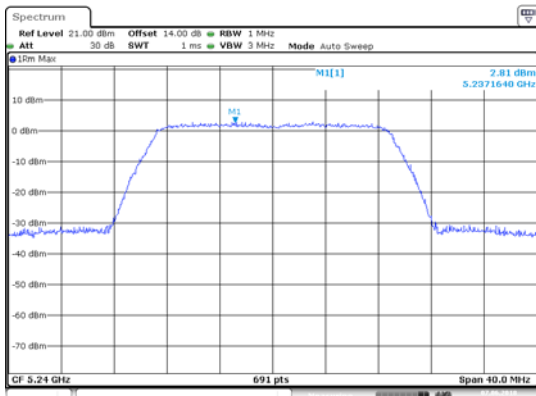

Date: 7.JUN.2018 11:42:39

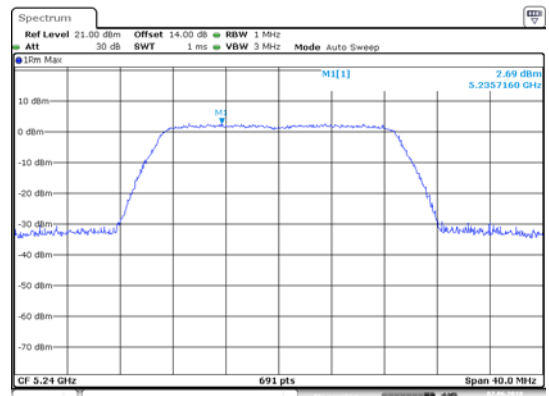

Date: 7.JUN.2018 11:42:12

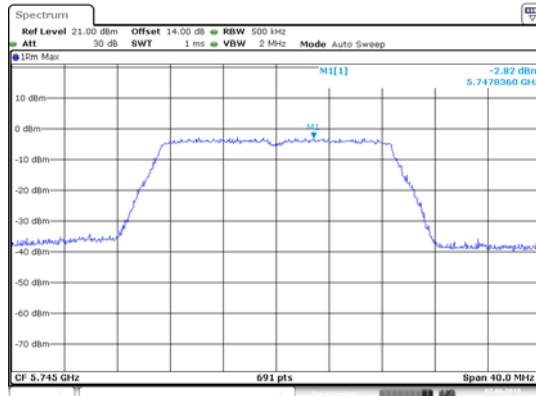

Date: 7.JUN.2018 11:37:29

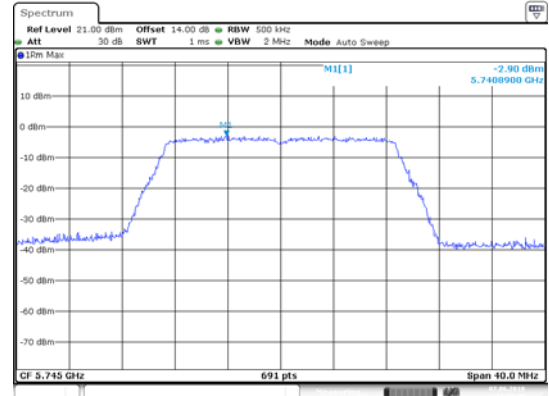

Date: 7.JUN.2018 11:37:49

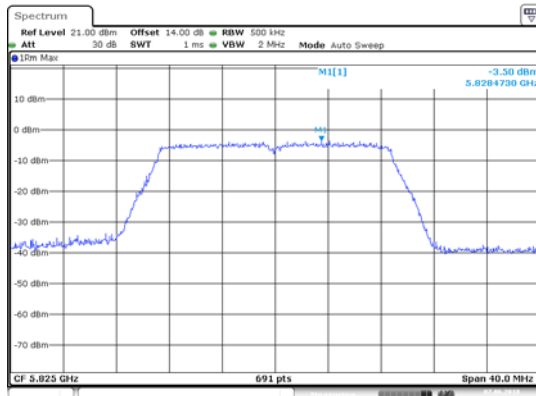

Date: 7.JUN.2018 11:36:18

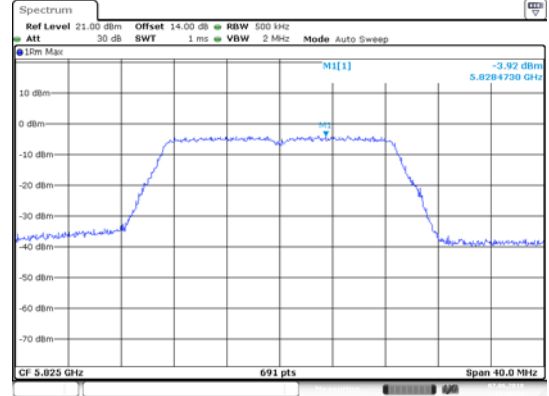

Date: 7.JUN.2018 11:36:54

ANT 1(11N40)

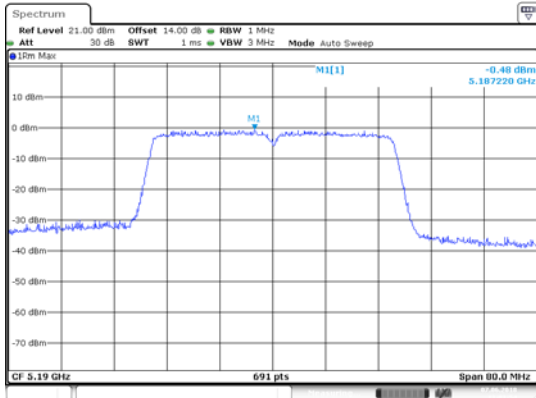

Date: 7 JUN 2018 12:01:54

ANT 2(11N40)

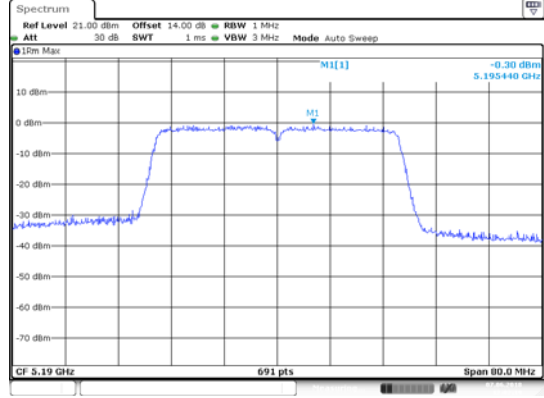

Date: 7 JUN 2018 12:02:19

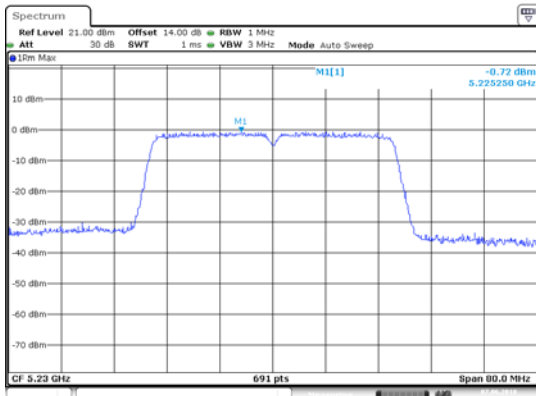

Date: 7 JUN 2018 12:01:09

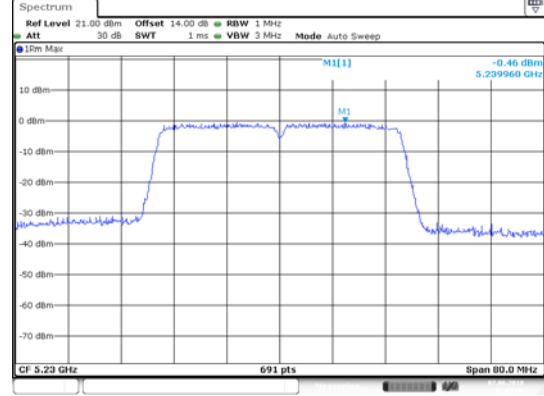

Date: 7 JUN 2018 12:00:45

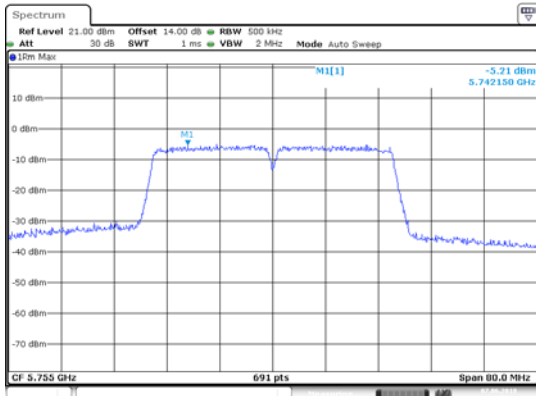

Date: 7 JUN 2018 11:57:23

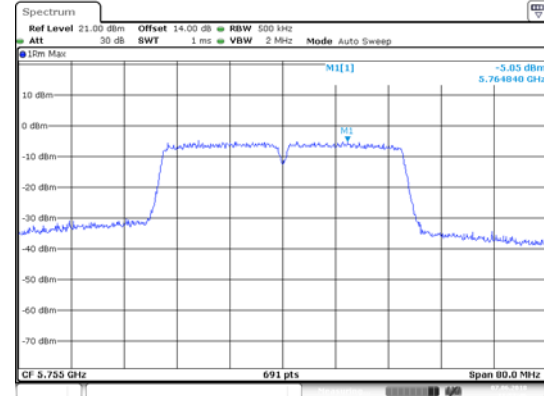

Date: 7 JUN 2018 11:57:46

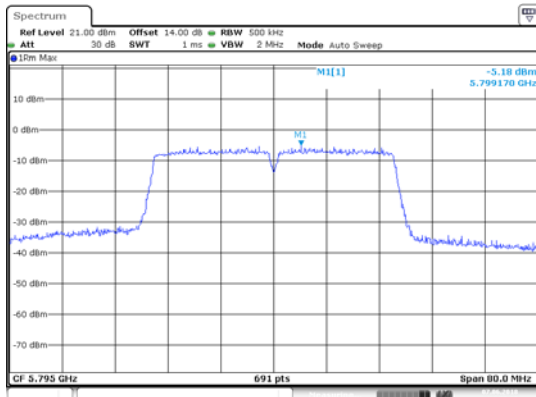

Date: 7 JUN 2018 11:55:17

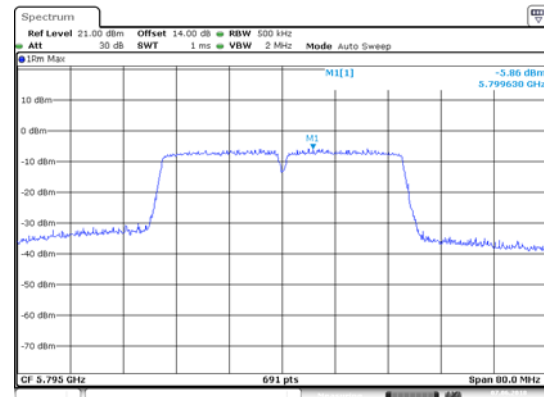

Date: 7 JUN 2018 11:55:43

ANT 1(11AC40)

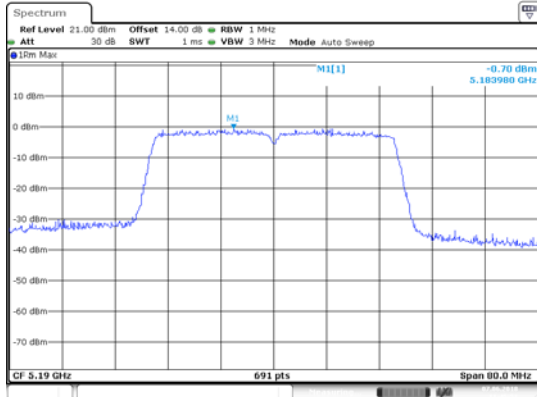

Date: 7 JUN 2018 11:45:51

ANT 2(11AC40)

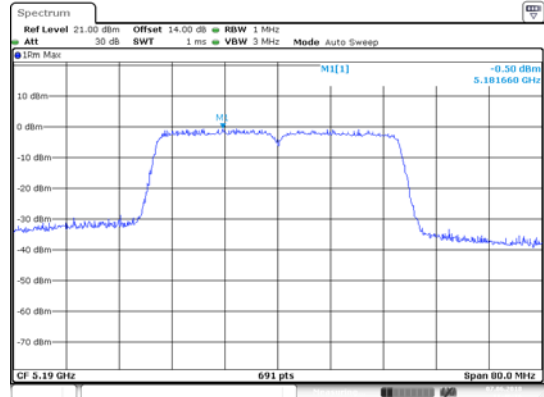

Date: 7 JUN 2018 11:46:16

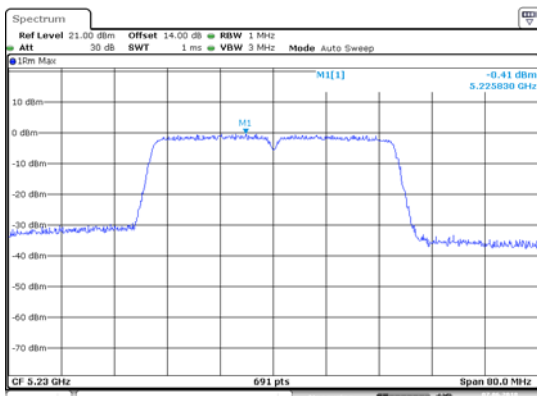

Date: 7 JUN 2018 11:48:21

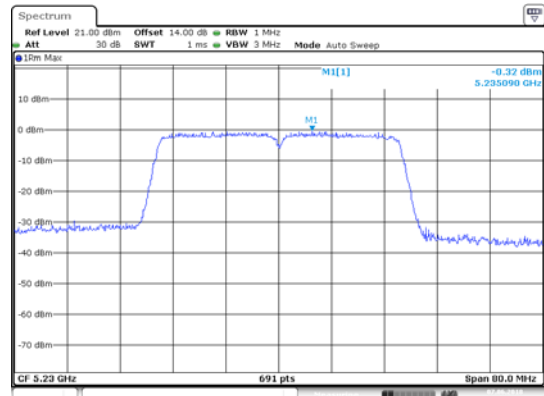

Date: 7 JUN 2018 11:48:52

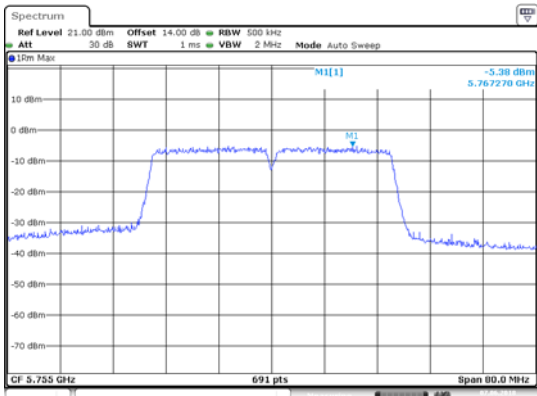

Date: 7 JUN 2018 11:50:17

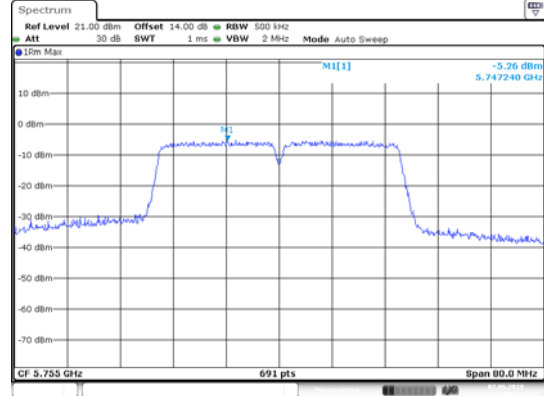

Date: 7 JUN 2018 11:50:52

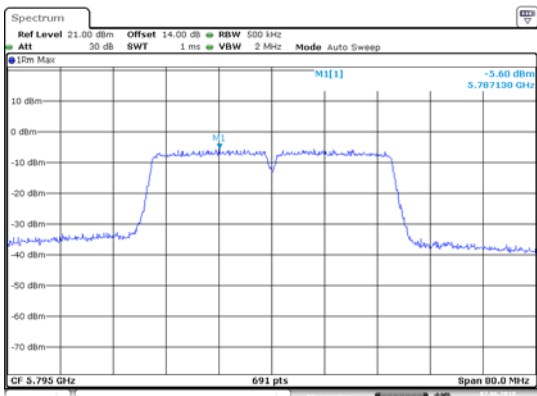

Date: 7 JUN 2018 11:53:10

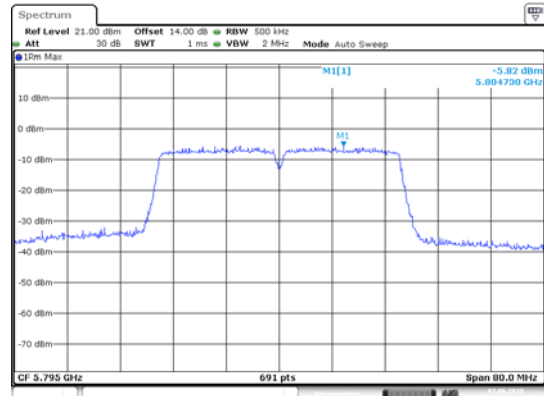

Date: 7 JUN 2018 11:53:34

ANT 1(11AC80)

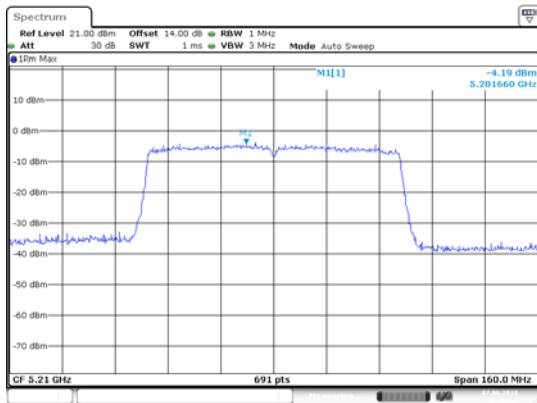

Date: 7 JUN 2018 12:05:25

ANT 2(11AC80)

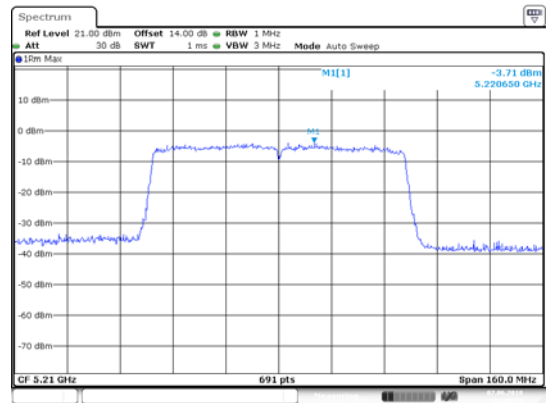

Date: 7 JUN 2018 12:05:51

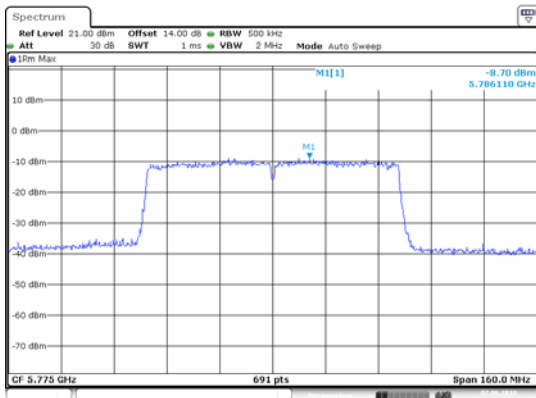

Date: 7 JUN 2018 12:10:38

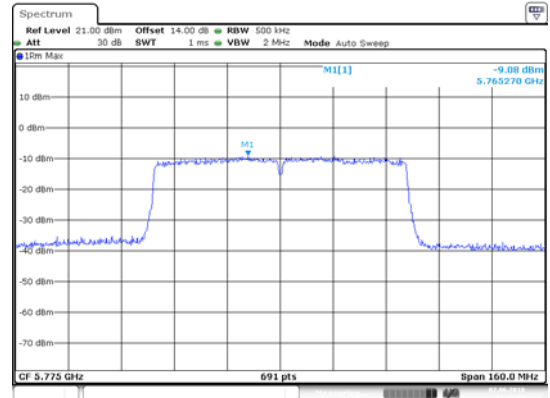

Date: 7 JUN 2018 12:11:03

TEST MODE:MIMO

ANT 1(11N20)

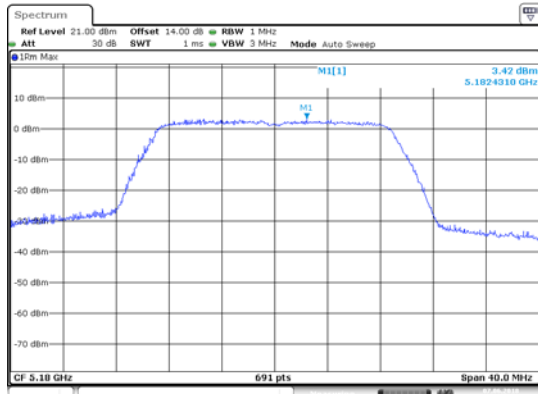

Date: 7 JUN 2018 11:15:28

ANT 2(11N20)

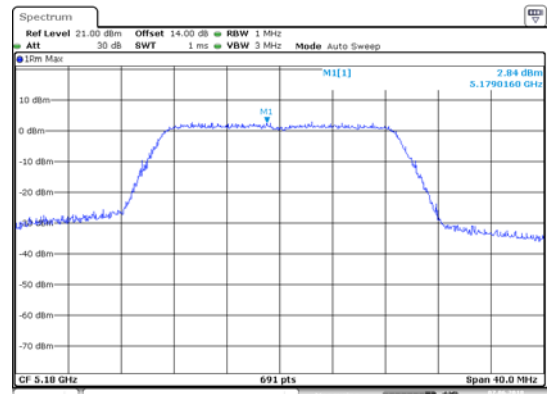

Date: 7 JUN 2018 11:16:25

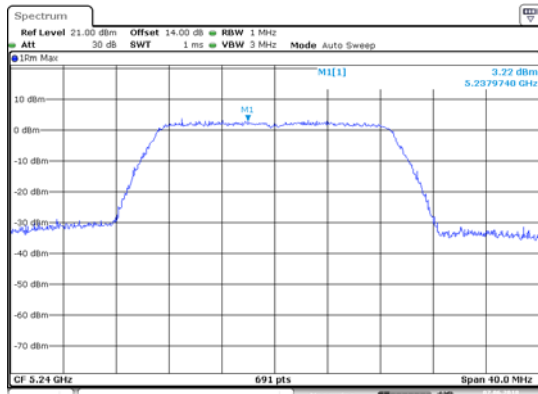

Date: 7 JUN 2018 11:17:28

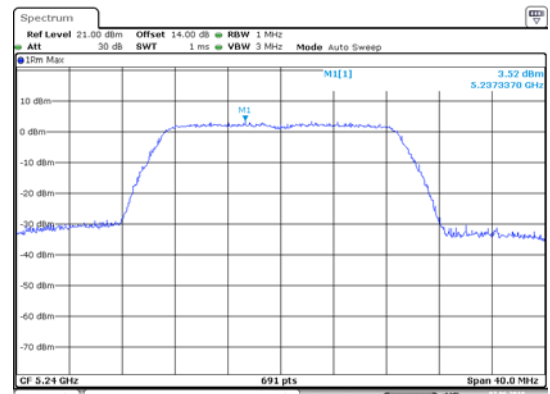

Date: 7 JUN 2018 11:17:54

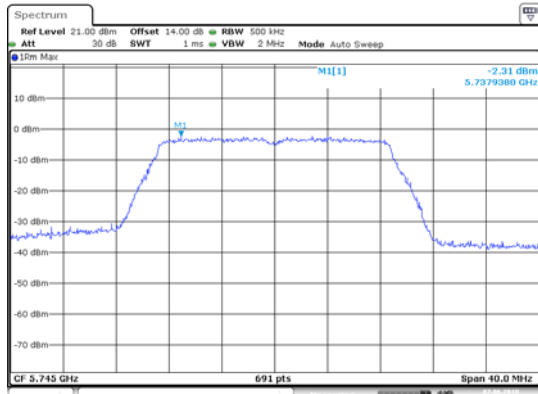

Date: 7 JUN 2018 11:22:58

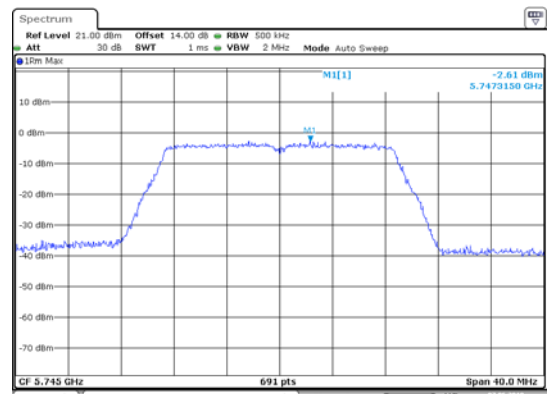

Date: 7 JUN 2018 11:38:34

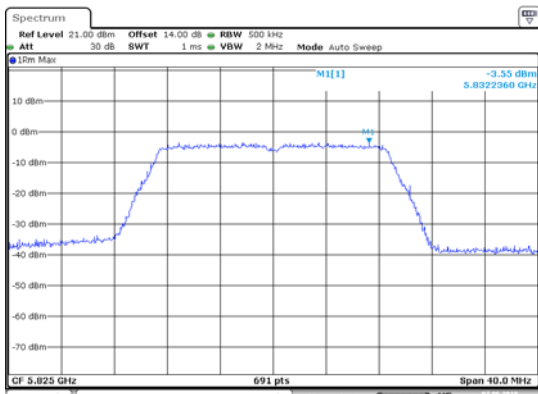

Date: 7 JUN 2018 11:24:30

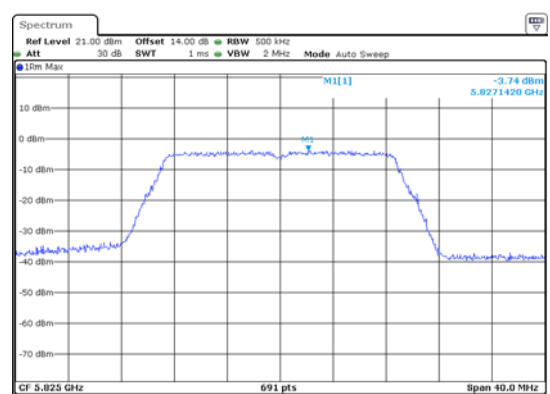

Date: 7 JUN 2018 11:25:01

ANT 1(11AC20)

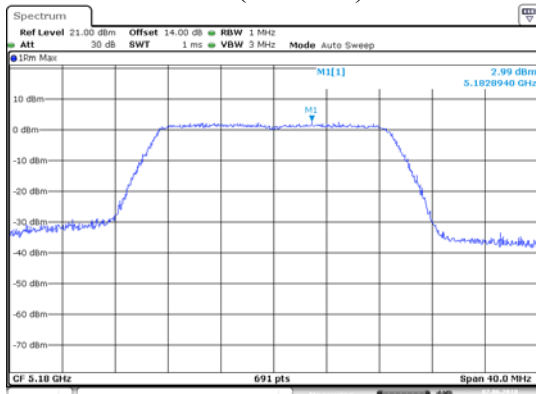

Date: 7.JUN.2018 11:41:08

ANT 2(11AC20)

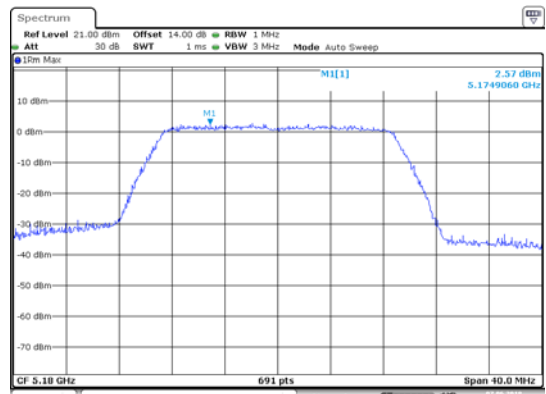

Date: 7.JUN.2018 11:41:29

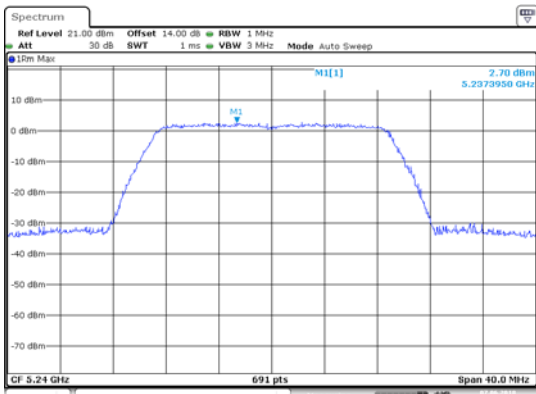

Date: 7.JUN.2018 11:43:06

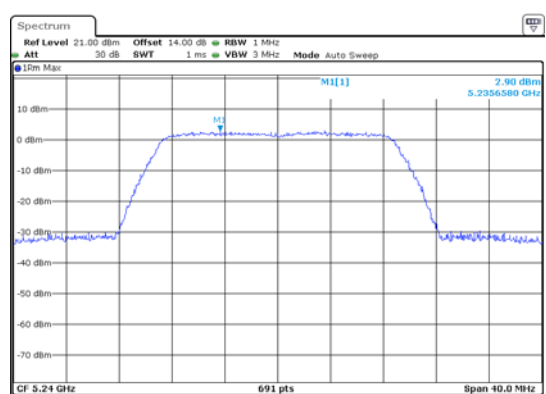

Date: 7.JUN.2018 11:43:28

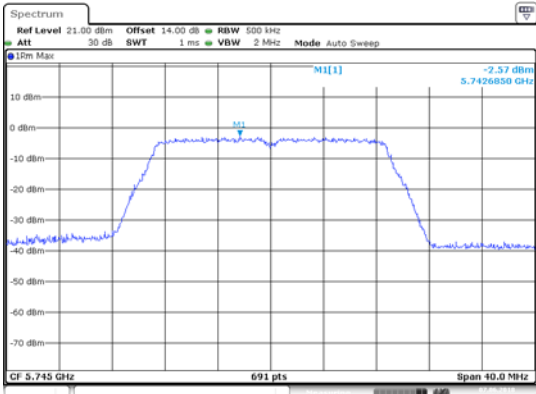

Date: 7.JUN.2018 11:38:16

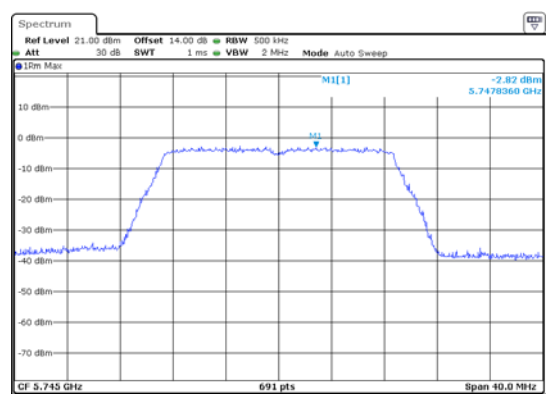

Date: 7.JUN.2018 11:37:29

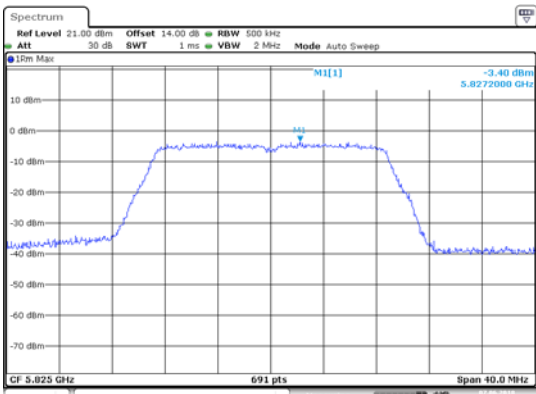

Date: 7.JUN.2018 11:39:15

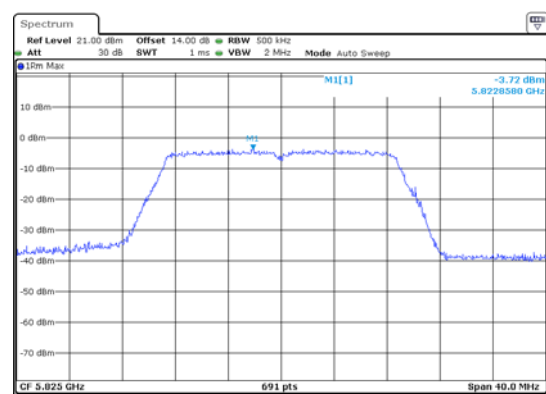

Date: 7.JUN.2018 11:39:36

ANT 1(11N40)

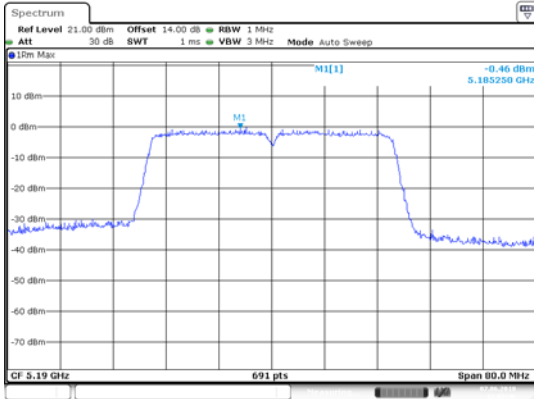

Date: 7 JUN 2018 12:02:46

ANT 2(11N40)

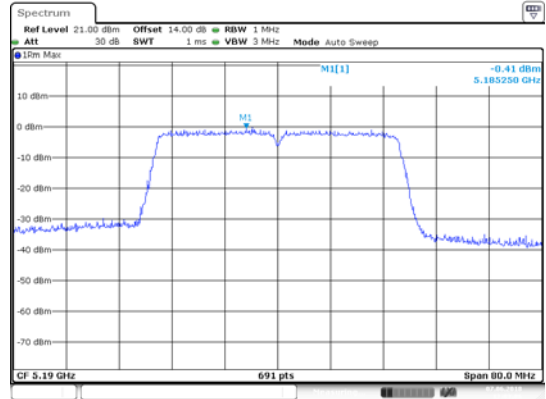

Date: 7 JUN 2018 12:03:06

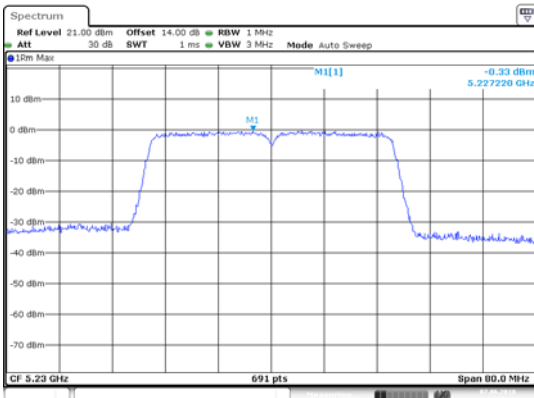

Date: 7 JUN 2018 11:59:49

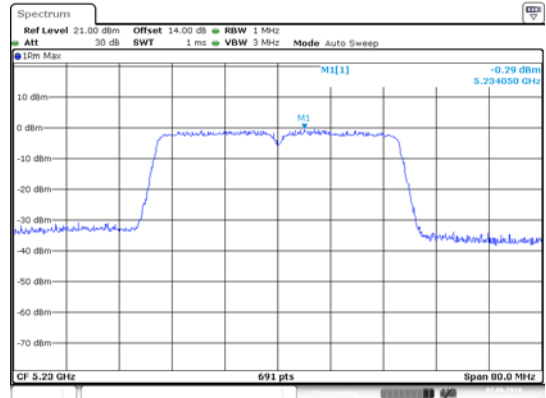

Date: 7 JUN 2018 12:00:14

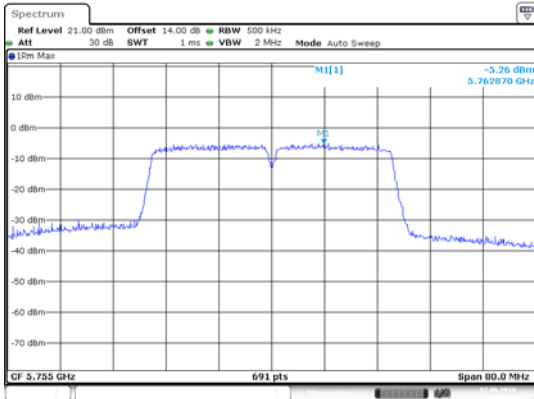

Date: 7 JUN 2018 11:58:06

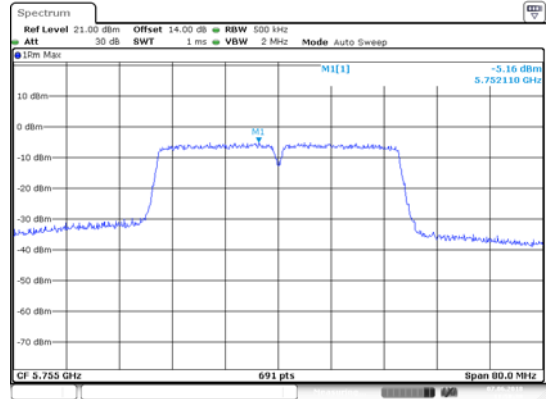

Date: 7 JUN 2018 11:58:30

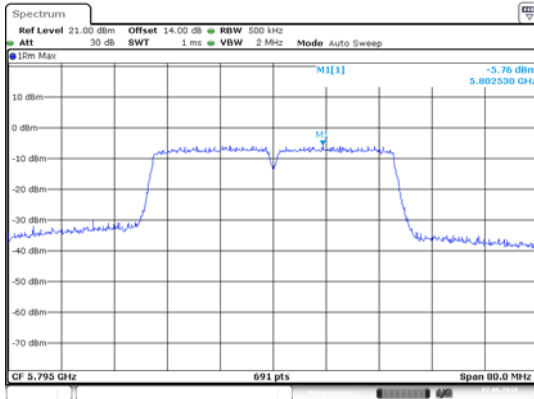

Date: 7 JUN 2018 11:56:12

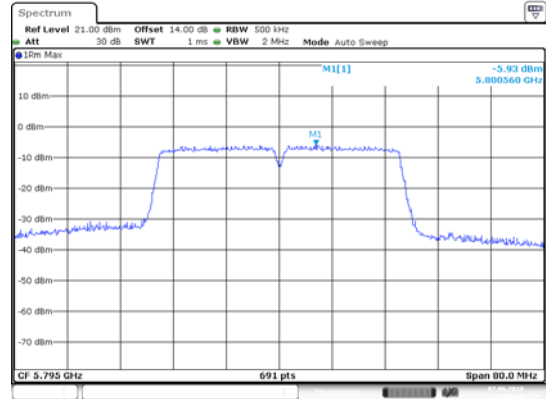

Date: 7 JUN 2018 11:56:40