

APPLICATION CERTIFICATION FCC Part 15C  
On Behalf of  
CTOUCH Europe B.V.

UP-Android 7 module

Model No.: UPA000AN

FCC ID: 2APQQ-UPA000AN

Prepared for : CTOUCH Europe B.V.  
Address : Achtseweg Zuid 153R, 5651 GW Eindhoven, The  
Netherlands

Prepared by : Shenzhen Accurate Technology Co., Ltd.  
Address : 1/F., Building A, Changyuan New Material Port,  
Science & Industry Park, Nanshan District,  
Shenzhen, Guangdong, P.R. China

Tel: (0755) 26503290  
Fax: (0755) 26503396

Report No. : ATE20180785  
Date of Test : June 01, 2018-June 28, 2018  
Date of Report : June 29, 2018

## TABLE OF CONTENTS

Description	Page
Test Report Certification	
<b>1. GENERAL INFORMATION .....</b>	<b>5</b>
1.1. Description of Device (EUT).....	5
1.2. Special Accessory and Auxiliary Equipment .....	5
1.3. Description of Test Facility .....	6
1.4. Measurement Uncertainty .....	6
<b>2. MEASURING DEVICE AND TEST EQUIPMENT .....</b>	<b>7</b>
<b>3. OPERATION OF EUT DURING TESTING .....</b>	<b>8</b>
3.1. Operating Mode .....	8
3.2. Carrier Frequency of Channels .....	8
3.3. Configuration and peripherals .....	9
3.4. Test mode.....	9
<b>4. TEST PROCEDURES AND RESULTS .....</b>	<b>10</b>
<b>5. 6DB OCCUPIED BANDWIDTH TEST .....</b>	<b>11</b>
5.1. Block Diagram of Test Setup.....	11
5.2. The Requirement For Section 15.247(a)(1).....	11
5.3. EUT Configuration on Measurement .....	11
5.4. Operating Condition of EUT .....	11
5.5. Test Procedure .....	11
5.6. Test Result .....	12
<b>6. 99% OCCUPIED BANDWIDTH .....</b>	<b>16</b>
6.1. Block Diagram of Test Setup.....	16
6.2. EUT Configuration on Measurement .....	16
6.3. Operating Condition of EUT .....	16
6.4. Test Procedure .....	16
6.5. Measurement Result .....	17
<b>7. DUTY CYCLE MEASUREMENT .....</b>	<b>21</b>
7.1. Block Diagram of Test Setup.....	21
7.2. EUT Configuration on Measurement .....	21
7.3. Operating Condition of EUT .....	21
7.4. Test Procedure .....	21
7.5. Test Result .....	22
<b>8. POWER SPECTRAL DENSITY TEST.....</b>	<b>26</b>
8.1. Block Diagram of Test Setup.....	26
8.2. The Requirement For Section 15.247(e).....	26
8.3. EUT Configuration on Measurement .....	26
8.4. Operating Condition of EUT .....	26
8.5. Test Procedure .....	26
8.6. Test Result .....	27
<b>9. MAXIMUM CONDUCTED (AVERAGE) OUTPUT POWER .....</b>	<b>33</b>
9.1. Block Diagram of Test Setup.....	33
9.2. The Requirement For Section 15.247(b)(3).....	33
9.3. EUT Configuration on Measurement .....	33
9.4. Operating Condition of EUT .....	33

9.5.	Test Procedure .....	33
9.6.	Test Result .....	34
<b>10.</b>	<b>RADIATED SPURIOUS EMISSION TEST .....</b>	<b>38</b>
10.1.	Block Diagram of Test Setup.....	38
10.2.	The Limit For Section 15.247(d) .....	40
10.3.	Restricted bands of operation .....	40
10.4.	Configuration of EUT on Measurement .....	41
10.5.	Operating Condition of EUT .....	41
10.6.	Test Procedure .....	41
10.7.	The Field Strength of Radiation Emission Measurement Results .....	42
<b>11.</b>	<b>BAND EDGE COMPLIANCE TEST .....</b>	<b>55</b>
11.1.	Block Diagram of Test Setup.....	55
11.2.	The Requirement For Section 15.247(d) .....	55
11.3.	EUT Configuration on Measurement .....	55
11.4.	Operating Condition of EUT .....	55
11.5.	Test Procedure .....	56
11.6.	Test Result .....	56
<b>12.</b>	<b>ANTENNA REQUIREMENT.....</b>	<b>73</b>
12.1.	The Requirement .....	73
12.2.	Antenna Construction .....	73

## Test Report Certification

Applicant : CTOUCH Europe B.V.  
Address : Achtseweg Zuid 153R, 5651 GW Eindhoven, The Netherlands  
Manufacturer : CTOUCH Europe B.V.  
Address : Achtseweg Zuid 153R, 5651 GW Eindhoven, The Netherlands  
Product : UP-Android 7 module  
Model No. : UPA000AN  
Trade name : CTOUCH

Measurement Procedure Used:



### **FCC Rules and Regulations Part 15 Subpart C Section 15.247 ANSI C63.10: 2013**

The EUT was tested according to DTS test procedure of Apr 05, 2017 KDB558074 D01 DTS Meas Guidance v04 for compliance to FCC 47CFR 15.247 requirements

The device described above is tested by SHENZHEN ACCURATE TECHNOLOGY CO. LTD to determine the maximum emission levels emanating from the device. The maximum emission levels are compared to the FCC Part 15 Subpart C Section 15.247 limits. The measurement results are contained in this test report and SHENZHEN ACCURATE TECHNOLOGY CO. LTD is assumed full responsibility for the accuracy and completeness of these measurements. Also, this report shows that the Equipment Under Test (EUT) is to be technically compliant with the FCC requirements.

This report applies to above tested sample only. This report shall not be reproduced in part without written approval of SHENZHEN ACCURATE TECHNOLOGY CO. LTD.

Date of Test : June 01, 2018-June 28, 2018  
Date of Report : June 29, 2018

Prepared by :   
(Tim g Engineer)

Approved & Authorized Signer :   
( Sean Liu, Manager)

## 1. GENERAL INFORMATION

### 1.1. Description of Device (EUT)

EUT	:	UP-Android 7 module
Model Number	:	UPA000AN
Frequency Range	:	802.11b/g/n(20MHz): 2412-2462MHz
Number of Channels	:	802.11b/g/n (20MHz):11
G <sub>ANT MAX</sub>	:	2dBi(two antennas have the same gain)
Directional gain	:	5.01
Type of Antenna	:	MIMO Antenna
Power Supply	:	DC 12~19V
Data Rate	:	802.11b: 11, 5.5, 2, 1 Mbps 802.11g: 54, 48, 36, 24, 18, 12, 9, 6 Mbps 802.11n: up to 150Mbps
Modulation Type	:	CCK, OFDM
Applicant	:	CTOUCH Europe B.V.
Address	:	Achtseweg Zuid 153R, 5651 GW Eindhoven, The Netherlands
Manufacturer	:	CTOUCH Europe B.V.
Address	:	Achtseweg Zuid 153R, 5651 GW Eindhoven, The Netherlands
Date of sample received	:	May 11, 2018
Date of Test	:	June 01, 2018-June 28, 2018

### 1.2. Special Accessory and Auxiliary Equipment

PC	Manufacturer: LENOVO M/N: 4290-RT8 S/N: R9-FW93G 11/08
Adapter	Manufacturer: N/A INPUT: 100-240V 50/60Hz OUTPUT: DC 12V 5A

### 1.3. Description of Test Facility

- EMC Lab : Recognition of accreditation by Federal Communications Commission (FCC)  
The Designation Number is CN1189  
The Registration Number is 708358
- Listed by Innovation, Science and Economic Development Canada (ISED)  
The Registration Number is 5077A-2
- Accredited by China National Accreditation Service for Conformity Assessment (CNAS)  
The Registration Number is CNAS L3193
- Accredited by American Association for Laboratory Accreditation (A2LA)  
The Certificate Number is 4297.01
- Name of Firm : Shenzhen Accurate Technology Co., Ltd  
Site Location : 1/F., Building A, Changyuan New Material Port, Science & Industry Park, Nanshan District, Shenzhen, Guangdong, P.R. China

### 1.4. Measurement Uncertainty

- Conducted Emission Expanded Uncertainty = 2.23dB, k=2
- Radiated emission expanded uncertainty (9kHz-30MHz) = 3.08dB, k=2
- Radiated emission expanded uncertainty (30MHz-1000MHz) = 4.42dB, k=2
- Radiated emission expanded uncertainty (Above 1GHz) = 4.06dB, k=2

## 2. MEASURING DEVICE AND TEST EQUIPMENT

**Table 1: List of Test and Measurement Equipment**

Kind of equipment	Manufacturer	Type	S/N	Calibrated dates	Calibrated until
EMI Test Receiver	Rohde&Schwarz	ESCS30	100307	Jan. 06, 2018	Jan. 05, 2019
EMI Test Receiver	Rohde&Schwarz	ESPI3	101526/003	Jan. 06, 2018	Jan. 05, 2019
Spectrum Analyzer	Rohde&Schwarz	FSV-40	101495	Jan. 06, 2018	Jan. 05, 2019
Spectrum Analyzer	Agilent	E7405A	MY45115511	Jan. 06, 2018	Jan. 05, 2019
Pre-Amplifier	Rohde&Schwarz	CBLU118354 0-01	3791	Jan. 06, 2018	Jan. 05, 2019
Loop Antenna	Schwarzbeck	FMZB1516	1516131	Jan. 06, 2018	Jan. 05, 2019
Bilog Antenna	Schwarzbeck	VULB9163	9163-323	Jan. 06, 2018	Jan. 05, 2019
Horn Antenna	Schwarzbeck	BBHA9120D	9120D-655	Jan. 06, 2018	Jan. 05, 2019
Horn Antenna	Schwarzbeck	BBHA9170	9170-359	Jan. 06, 2018	Jan. 05, 2019
Open Switch and Control Unit	Rohde&Schwarz	OSP120 + OSP-B157	101244 + 100866	Jan. 06, 2018	Jan. 05, 2019
LISN	Rohde&Schwarz	ESH3-Z5	100305	Jan. 06, 2018	Jan. 05, 2019
LISN	Schwarzbeck	NSLK8126	8126431	Jan. 06, 2018	Jan. 05, 2019
Highpass Filter	Wainwright Instruments	WHKX3.6/18 G-10SS	N/A	Jan. 06, 2018	Jan. 05, 2019
Band Reject Filter	Wainwright Instruments	WRCG2400/2 485-2375/2510 -60/11SS	N/A	Jan. 06, 2018	Jan. 05, 2019

### 3. OPERATION OF EUT DURING TESTING

#### 3.1. Operating Mode

The mode is used: **1.802.11b Transmitting mode**

Low Channel: 2412MHz

Middle Channel: 2437MHz

High Channel: 2462MHz

#### **2.802.11g Transmitting mode**

Low Channel: 2412MHz

Middle Channel: 2437MHz

High Channel: 2462MHz

#### **3.802.11n (20MHz) Transmitting mode**

Low Channel: 2412MHz

Middle Channel: 2437MHz

High Channel: 2462MHz

#### 3.2. Carrier Frequency of Channels

802.11b, 802.11g, 802.11n (20MHz)

Channel	Frequency(MHz)	Channel	Frequency(MHz)
01	2412	07	2442
02	2417	08	2447
03	2422	09	2452
04	2427	10	2457
05	2432	11	2462
06	2437	---	---



### 3.3.Configuration and peripherals

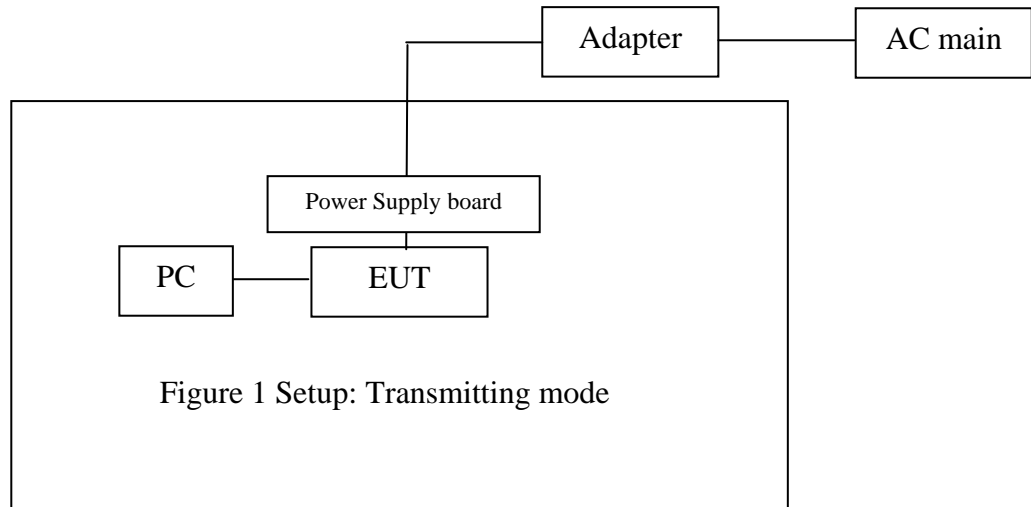

(EUT: UP-Android 7 module)

Note: The EUT have two antenna(1 and 2), They can transmit simultaneously.

### 3.4.Test mode

Test Mode	Test Modes Description
11B	IEEE 802.11b with data rate of 1 Mbps using SISO mode.
11G	IEEE 802.11b with data rate of 6 Mbps using SISO mode.
11N20MHz	IEEE 802.11n with data rate of MCS0 and bandwidth of 20 MHz using SISO mode.
11N20MHz	IEEE 802.11n with data rate of MCS0 and bandwidth of 20 MHz using MIMO mode.

NOTE: Worst cases for each IEEE 802.11 mode are selected to perform tests.

## 4. TEST PROCEDURES AND RESULTS

FCC Rules	Description of Test	Result
Section 15.207	AC power Line Conducted Emission Test	N/A
Section 15.247(a)(2)	6dB Occupied Bandwidth Test	Compliant
KDB558074 D01 DTS Meas Guidance v04	Duty cycle	Compliant
KDB558074 D01 DTS Meas Guidance v04	OBW	Compliant
Section 15.247(b)(3)	Maximum conducted (average) output power	Compliant
Section 15.247(e)	Power Spectral Density Test	Compliant
Section 15.205 Section 15.209	Radiated Spurious Emissions Test	Compliant
Section 15.247(d)	Band Edge Compliance Test	Compliant
Section 15.203	Antenna Requirement	Compliant

Note: The power supply mode of the EUT is DC 12-19V, According to the FCC standard requirements, conducted emission is not applicable.

## 5. 6DB OCCUPIED BANDWIDTH TEST

### 5.1. Block Diagram of Test Setup

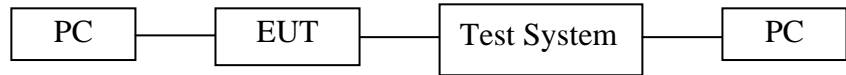

### 5.2. The Requirement For Section 15.247(a)(1)

Section 15.247(a)(2): Systems using digital modulation techniques may operate in the 902–928 MHz, 2400–2483.5 MHz, and 5725–5850 MHz bands. The minimum 6 dB band-width shall be at least 500 kHz

### 5.3. EUT Configuration on Measurement

The equipment are installed on the emission measurement to meet the commission requirements and operating regulations in a manner which tends to maximize its emission characteristics in normal application.

### 5.4. Operating Condition of EUT

5.4.1. Setup the EUT and simulator as shown as Section 5.1.

5.4.2. Turn on the power of all equipment.

5.4.3. Let the EUT work in TX modes measure it. The transmit frequency are 2412-2462MHz. We select 2412MHz, 2437MHz and 2462MHz TX frequency to transmit.

### 5.5. Test Procedure

5.5.1. The transmitter output was connected to the spectrum analyzer through a low loss cable.

5.5.2. Set RBW of spectrum analyzer to 100 kHz and VBW to 300 kHz.

5.5.3. The 6dB bandwidth is defined as the total spectrum the power of which is higher than peak power minus 6dB.

### 5.6. Test Result

The test was performed with 802.11b				
Channel	Frequency (MHz)	6dB Bandwidth ANT 1 (MHz)	6dB Bandwidth ANT 2(MHz)	Limit (MHz)
Low	2412	9.04	9.04	> 0.5MHz
Middle	2437	9.04	9.04	> 0.5MHz
High	2462	9.04	9.12	> 0.5MHz

The test was performed with 802.11g				
Channel	Frequency (MHz)	6dB Bandwidth ANT 1 (MHz)	6dB Bandwidth ANT 2(MHz)	Limit (MHz)
Low	2412	16.40	16.40	> 0.5MHz
Middle	2437	16.32	16.32	> 0.5MHz
High	2462	16.36	16.36	> 0.5MHz

The test was performed with 802.11n (Bandwidth: 20 MHz)				
Channel	Frequency (MHz)	6dB Bandwidth ANT 1 (MHz)	6dB Bandwidth ANT 2(MHz)	Limit (MHz)
Low	2412	17.52	17.60	> 0.5MHz
Middle	2437	17.68	17.68	> 0.5MHz
High	2462	17.60	17.60	> 0.5MHz

The spectrum analyzer plots are attached as below.

## 6dB Bandwidth

ANT 1(802.11b)

ANT 2(802.11b)

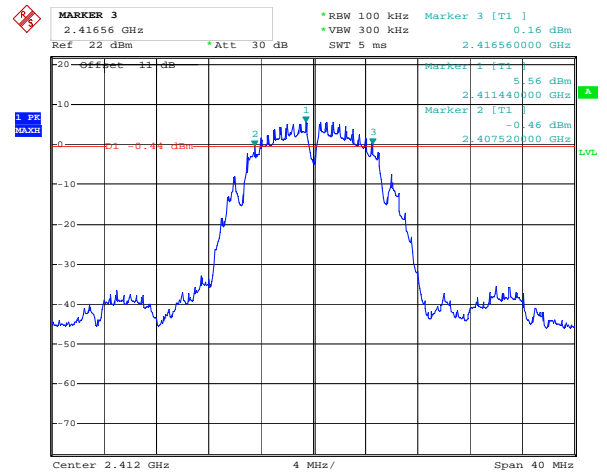
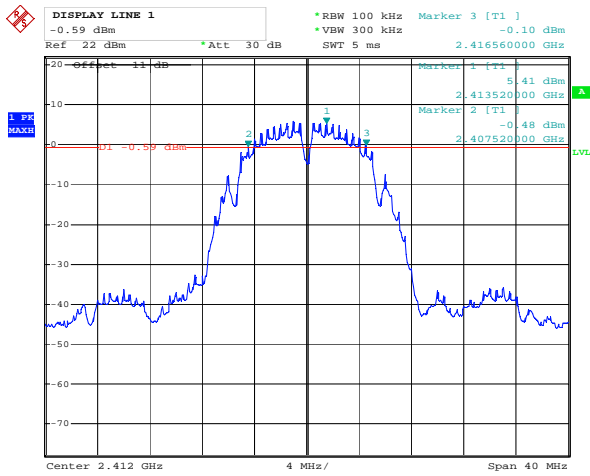

Comment A:  
Date: 6.JUN.2018 18:38:46

Comment A:  
Date: 6.JUN.2018 18:41:10

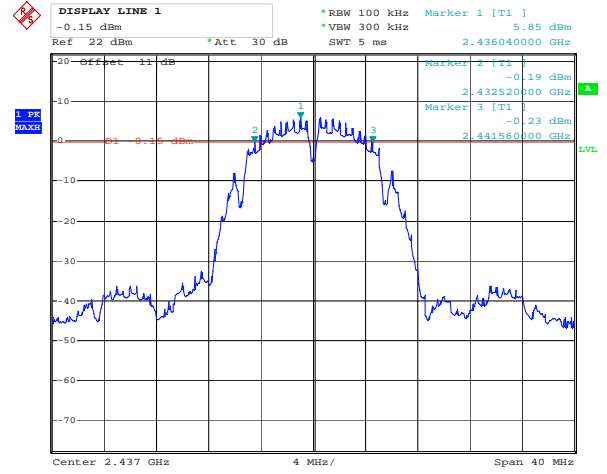
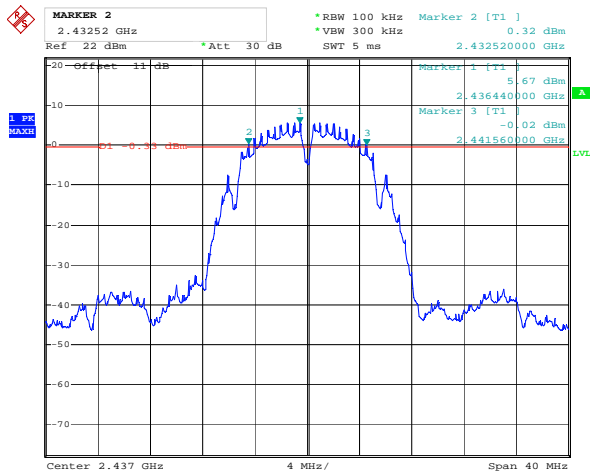

Comment A:  
Date: 6.JUN.2018 18:43:04

Comment A:  
Date: 6.JUN.2018 18:44:16

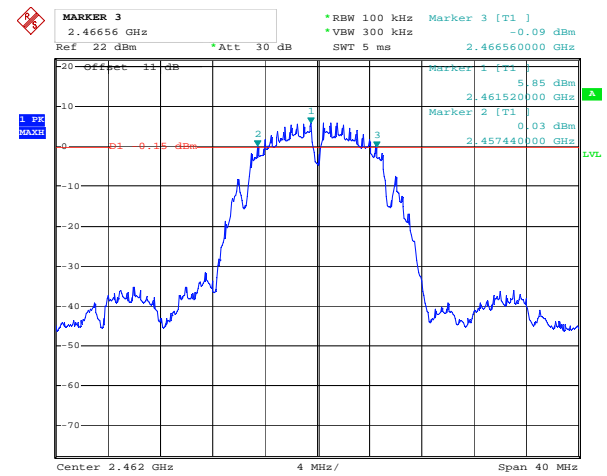
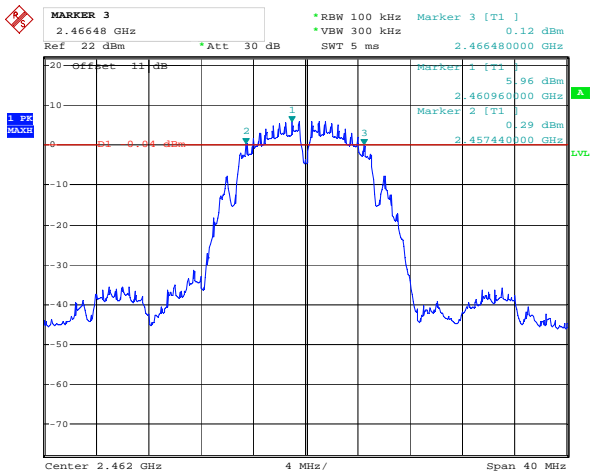

Comment A:  
Date: 6.JUN.2018 18:46:11

Comment A:  
Date: 6.JUN.2018 18:47:22

ANT 1(802.11g)

ANT 2(802.11g)

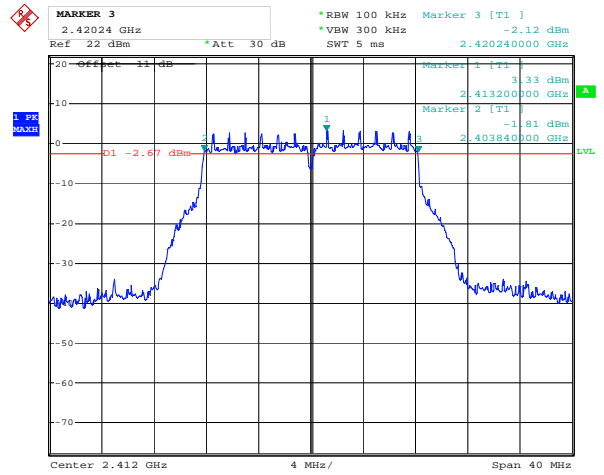
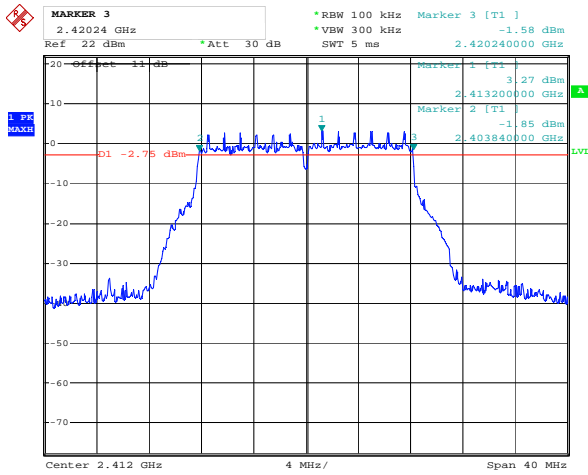

Comment A:  
Date: 6 JUN.2018 18:50:06

Comment A:  
Date: 6 JUN.2018 18:48:49

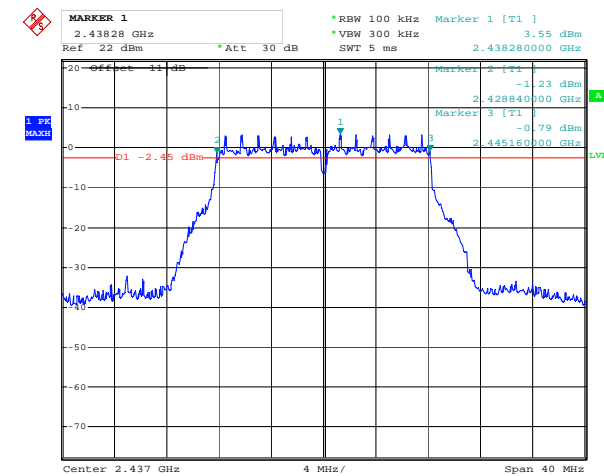
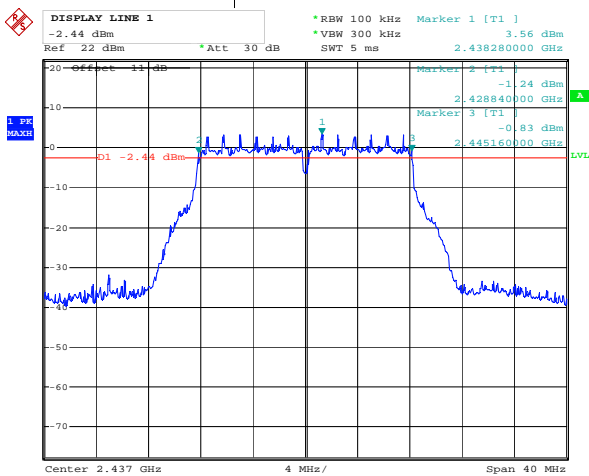

Comment A:  
Date: 6 JUN.2018 18:54:00

Comment A:  
Date: 6 JUN.2018 18:53:02

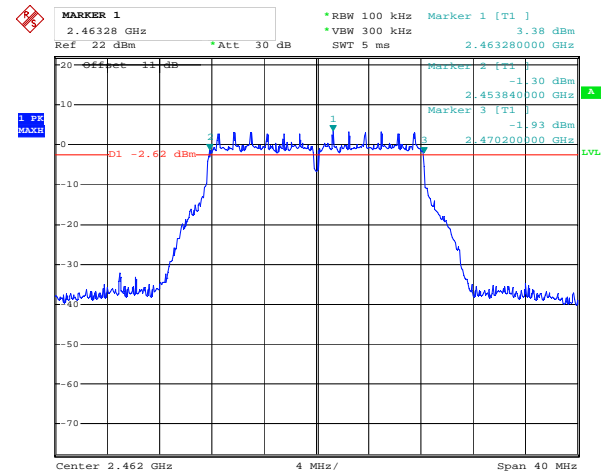
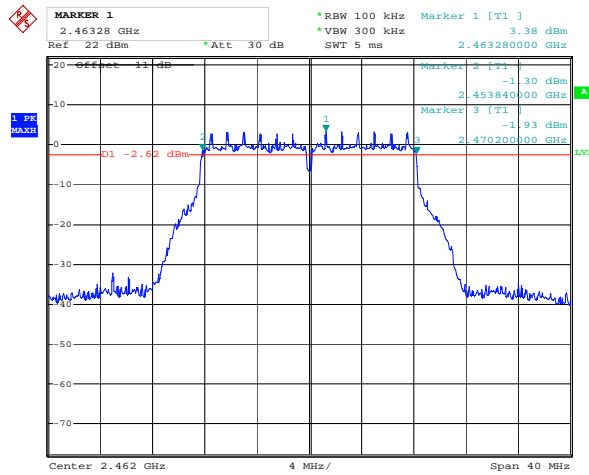

Comment A:  
Date: 6 JUN.2018 18:56:17

Comment A:  
Date: 6 JUN.2018 18:56:17

## ANT 1(802.11n20)

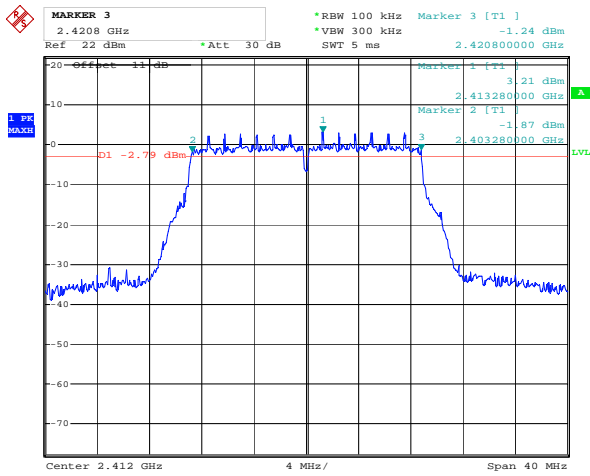

Comment A:  
Date: 6 JUN. 2018 19:00:46

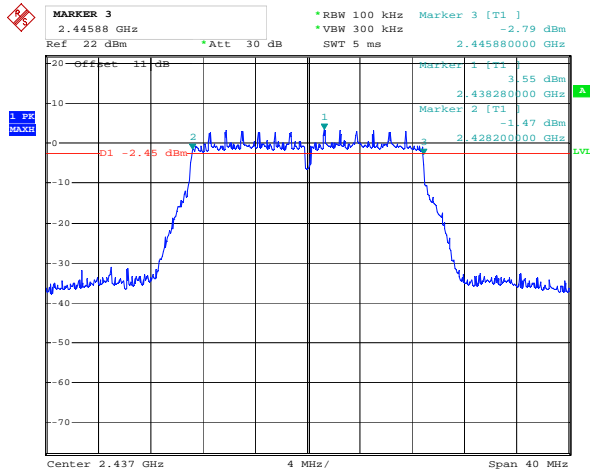

Comment A:  
Date: 6 JUN. 2018 19:02:16

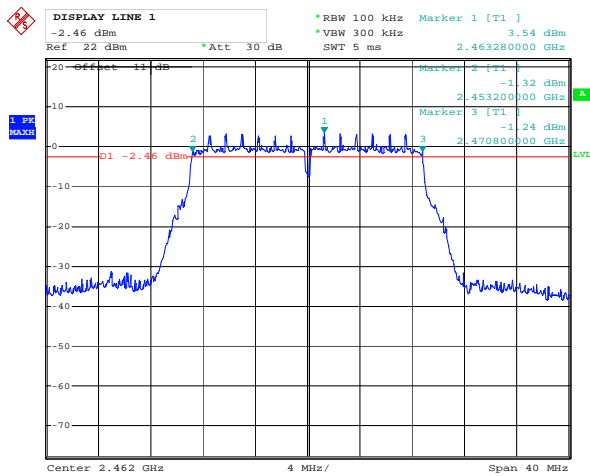

Comment A:  
Date: 6 JUN. 2018 19:05:33

## ANT 2(802.11 n20)

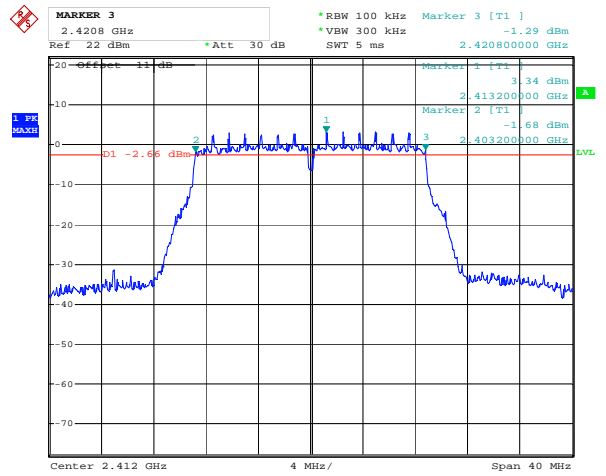

Comment A:  
Date: 6 JUN. 2018 18:59:09

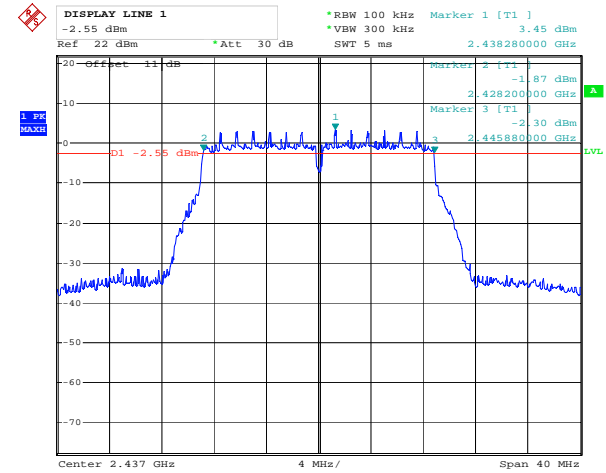

Comment A:  
Date: 6 JUN. 2018 19:03:21

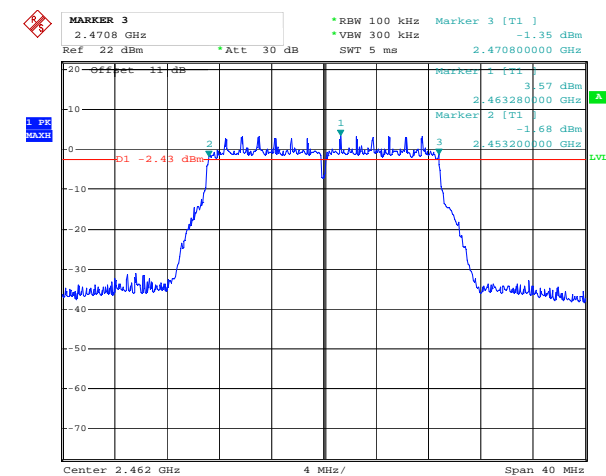

Comment A:  
Date: 6 JUN. 2018 19:04:35

## 6. 99% OCCUPIED BANDWIDTH

### 6.1. Block Diagram of Test Setup



### 6.2. EUT Configuration on Measurement

The following equipment is installed on the emission measurement to meet the commission requirements and operating regulations in a manner which tends to maximize its emission characteristics in normal application.

### 6.3. Operating Condition of EUT

6.3.1. Setup the EUT and simulator as shown as Section 6.1.

6.3.2. Turn on the power of all equipment.

6.3.3. Let the EUT work in TX modes measure it. The transmit frequency are 2412-2462MHz. We select 2412MHz, 2437MHz and 2462MHz TX frequency to transmit.

### 6.4. Test Procedure

6.4.1. The transmitter output was connected to the spectrum analyzer through a low loss cable. The transmitter shall be operated at its maximum carrier power measured under normal test conditions. The span of the analyzer shall be set to capture all products of the modulation process, including the emission skirts.

6.4.2. The resolution bandwidth (RBW) shall be in the range of 1% to 5% of the occupied bandwidth (OBW) and video bandwidth (VBW) shall be approximately 3x RBW.

6.4.3. A peak, or peak hold, may be used in place of the sampling detector as this may produce a wider bandwidth than the actual bandwidth (worst-case measurement). Use of a peak hold may be necessary to determine the occupied bandwidth if the device is not transmitting continuously.

6.4.4. Set SPA "Meas" function, Select "Occupied Bandwidth" function, Select "99% Power Bandwidth". The frequency of the upper and lower markers indicating the edges of the transmitters "99% Power" emission bandwidth shall be recorded to automate by SPA.



### 6.5.Measurement Result

The test was performed with 802.11b			
Channel	Frequency (MHz)	99% Occupied Bandwidth ANT1 (MHz)	99% Occupied Bandwidth ANT2 (MHz)
Low	2412	11.52	11.52
Middle	2437	11.52	11.52
High	2462	11.44	11.52

The test was performed with 802.11g			
Channel	Frequency (MHz)	99% Occupied Bandwidth ANT1 (MHz)	99% Occupied Bandwidth ANT2 (MHz)
Low	2412	17.28	17.28
Middle	2437	17.28	17.28
High	2462	17.28	17.28

The test was performed with 802.11 n20			
Channel	Frequency (MHz)	99% Occupied Bandwidth ANT1 (MHz)	99% Occupied Bandwidth ANT2 (MHz)
Low	2412	18.40	18.40
Middle	2437	18.40	18.40
High	2462	18.40	18.40

The spectrum analyzer plots are attached as below.

## 99% Bandwidth

ANT 1(802.11b)

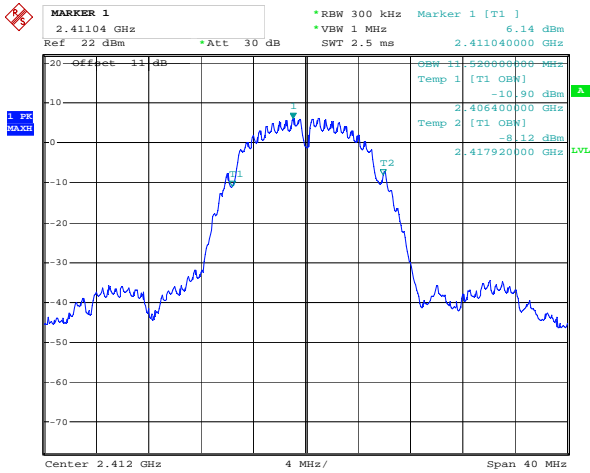

Comment A:  
Date: 6.JUN.2018 19:23:56

ANT 2(802.11b)

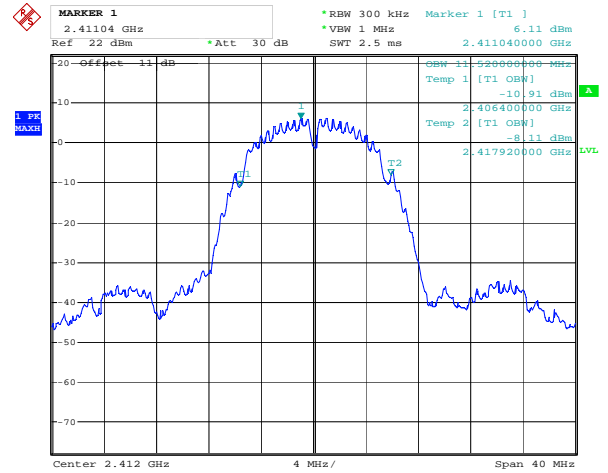

Comment A:  
Date: 6.JUN.2018 19:24:32

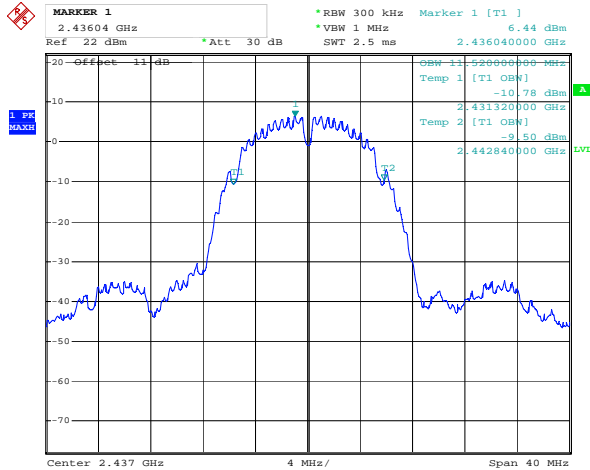

Comment A:  
Date: 6.JUN.2018 19:25:04

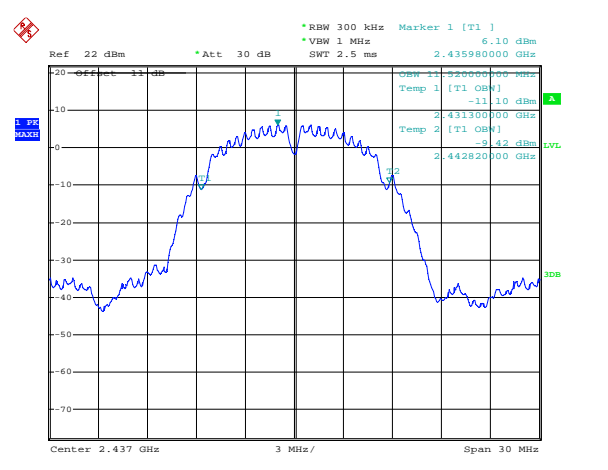

Date: 5.JUN.2018 16:19:27

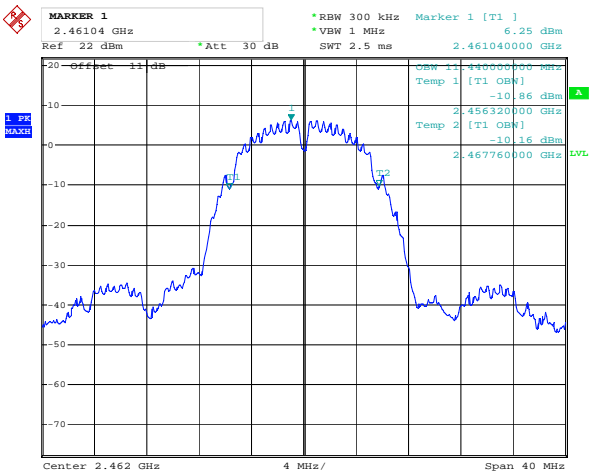

Comment A:  
Date: 6.JUN.2018 19:26:34

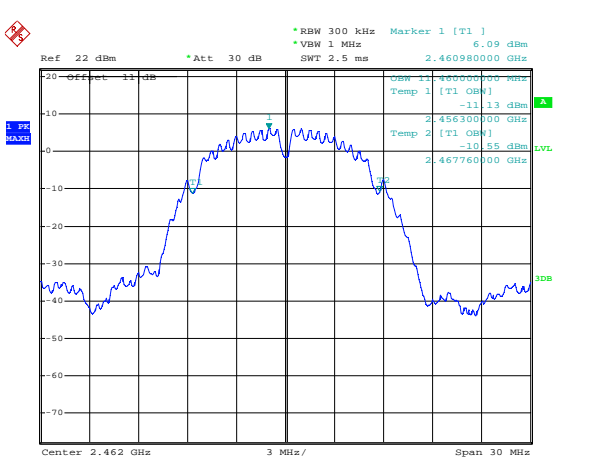

Date: 5.JUN.2018 16:20:39

## ANT 1(802.11g)

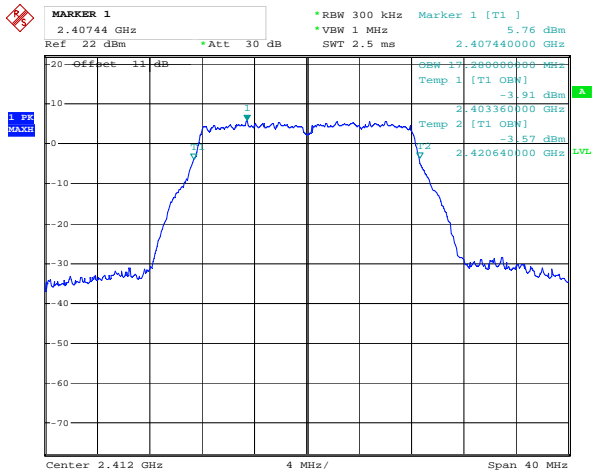

Comment A:  
Date: 6.JUN.2018 19:20:59

## ANT 2(802.11g)

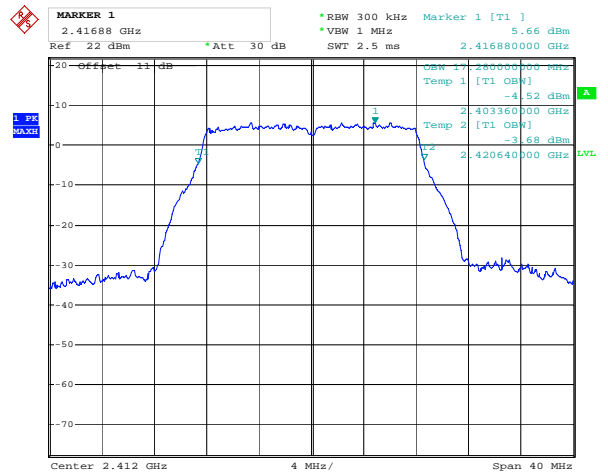

Comment A:  
Date: 6.JUN.2018 19:20:25

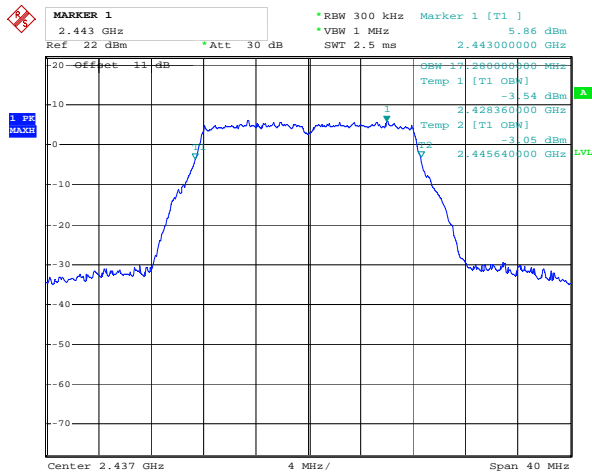

Comment A:  
Date: 6.JUN.2018 19:21:33

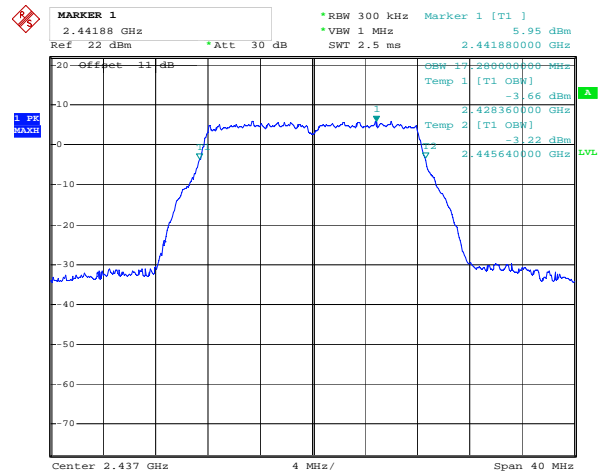

Comment A:  
Date: 6.JUN.2018 19:22:03

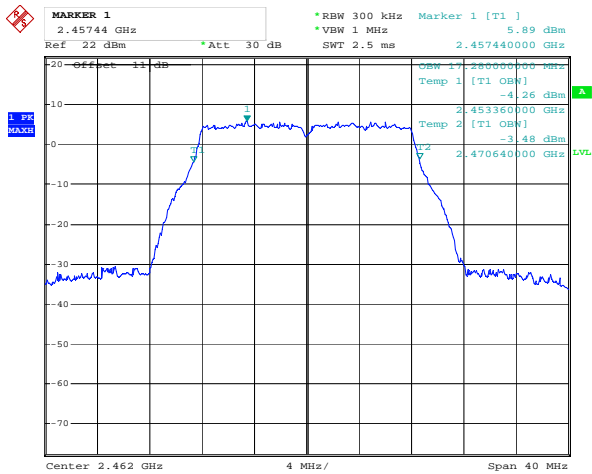

Comment A:  
Date: 6.JUN.2018 19:23:07

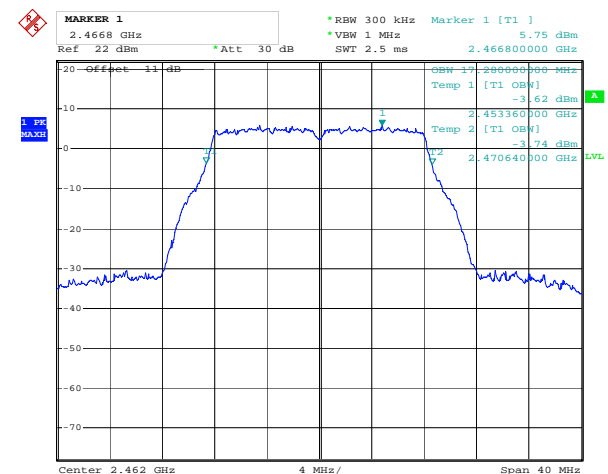

Comment A:  
Date: 6.JUN.2018 19:22:38

## ANT 1(802.11n20)

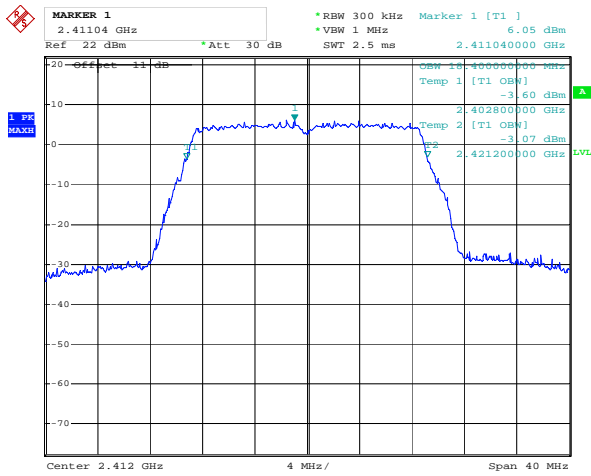

Comment A:  
Date: 6.JUN.2018 19:17:16

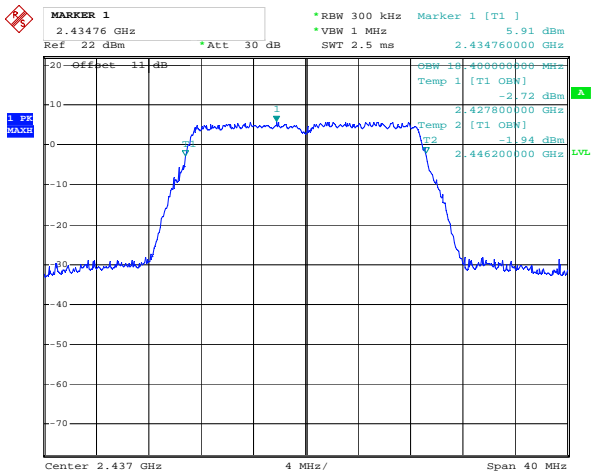

Comment A:  
Date: 6.JUN.2018 19:14:16

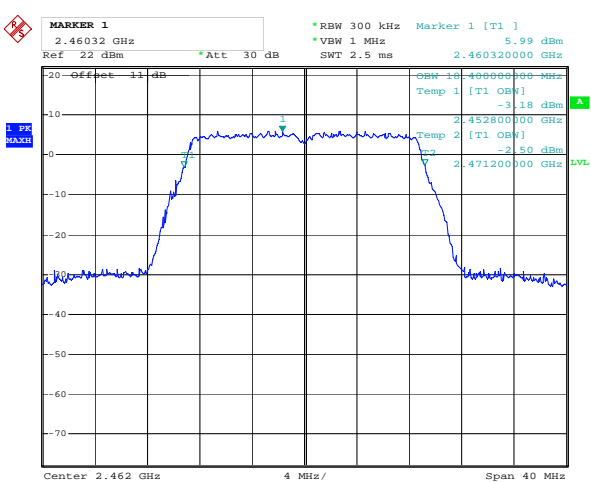

Comment A:  
Date: 6.JUN.2018 19:18:57

## ANT 2(802.11 n20)

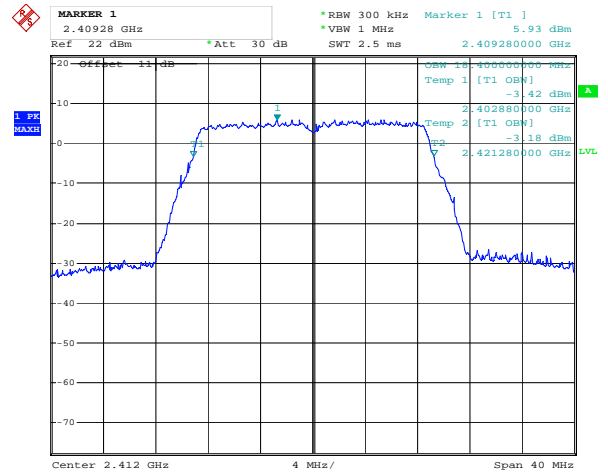

Comment A:  
Date: 6.JUN.2018 19:16:23

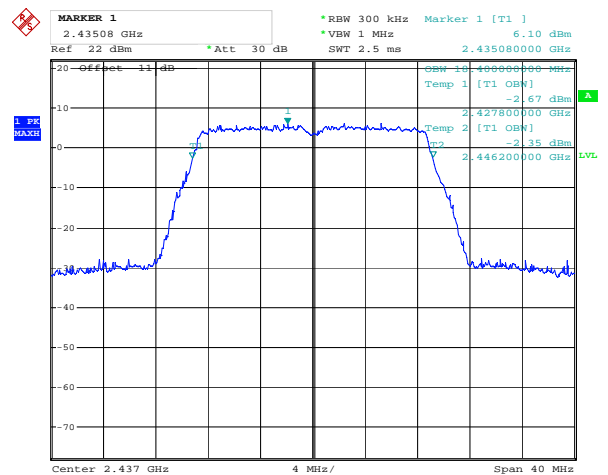

Comment A:  
Date: 6.JUN.2018 19:15:16

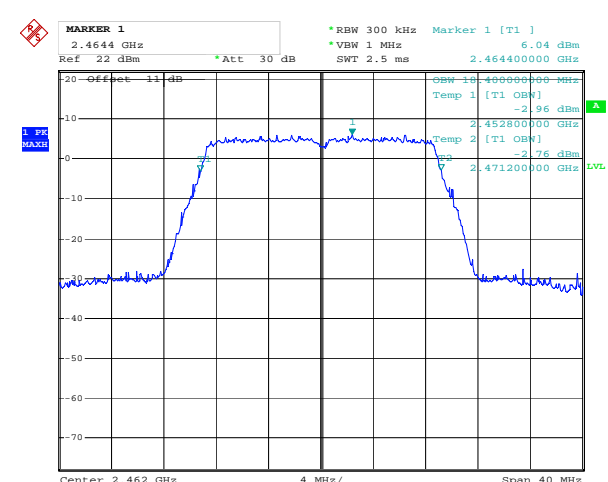

Comment A:  
Date: 6.JUN.2018 19:19:38

## 7. DUTY CYCLE MEASUREMENT

### 7.1. Block Diagram of Test Setup

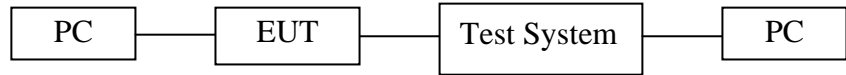

### 7.2. EUT Configuration on Measurement

The equipment are installed on the emission measurement to meet the commission requirements and operating regulations in a manner which tends to maximize its emission characteristics in normal application.

### 7.3. Operating Condition of EUT

7.3.1. Setup the EUT and simulator as shown as Section 7.1.

7.3.2. Turn on the power of all equipment.

7.3.3. Let the EUT work in TX modes measure it. The transmit frequency are 2412-2462MHz. We select 2437MHz TX frequency to transmit.

### 7.4. Test Procedure

Measurements of duty cycle and transmission duration shall be performed using one of the following techniques:

1. A diode detector and an oscilloscope that together have sufficiently short response time to permit accurate measurements of the on- and off-times of the transmitted signal.
2. The zero-span mode on a spectrum analyzer or EMI receiver if the response time and spacing between bins on the sweep are sufficient to permit accurate measurements of the on- and off-times of the transmitted signal
  - a. Set the center frequency of the instrument to the centre frequency of the transmission
  - b. Set  $RBW \geq OBW$  if possible; otherwise, set RBW to the largest available value(10MHz).
  - c. Set detector = Peak or average.
  - d. The zero-span measurement method shall not be used unless both RBW and VBW are  $> 50/T$  and the number of sweep points across duration T exceeds 100.  
(For example, if VBW and/or RBW are limited to 3MHz, then the zero-span method of measuring duty cycle shall not be used if  $T \leq 16.7$  microseconds.)

### 7.5. Test Result

The test was performed with 802.11b					
Channel	Frequency (MHz)	duty cycle(x) ANT 1	10log(1/x) ANT 1	duty cycle(x) ANT 2	10log(1/x) ANT 2
Middle	2437	99.56%	0.02	99.53%	0.02

The test was performed with 802.11g					
Channel	Frequency (MHz)	duty cycle(x) ANT 1	10log(1/x) ANT 1	duty cycle(x) ANT 2	10log(1/x) ANT 2
Middle	2437	96.86%	0.14	96.87%	0.14

The test was performed with 802.11n20					
Channel	Frequency (MHz)	duty cycle(x) ANT 1	10log(1/x) ANT 1	duty cycle(x) ANT 2	10log(1/x) ANT 2
Middle	2437	96.66%	0.15	96.48%	0.16

Note: The duty cycle's parameter settings for each mode(802.11b,g,n) are the same, Therefore, other channels can refer to the test data of the middle channel.

The spectrum analyzer plots are attached as below.

### Duty cycle

#### 802.11b Channel Middle 2437MHz(ANT 1)

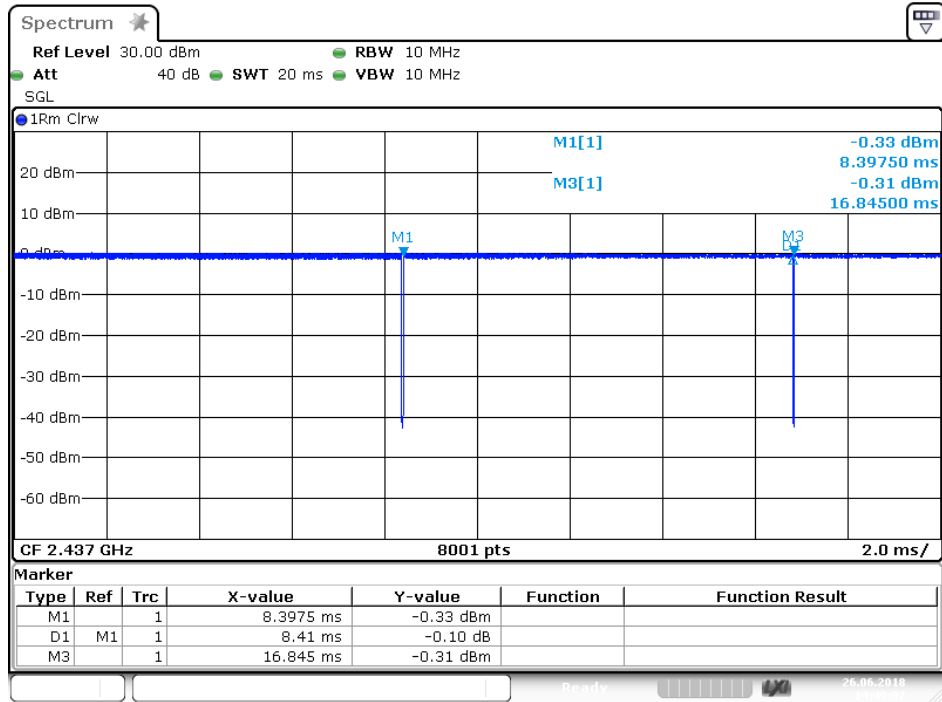

Date: 26.JUN.2018 14:49:08

#### 802.11b Channel Middle 2437MHz(ANT 2)

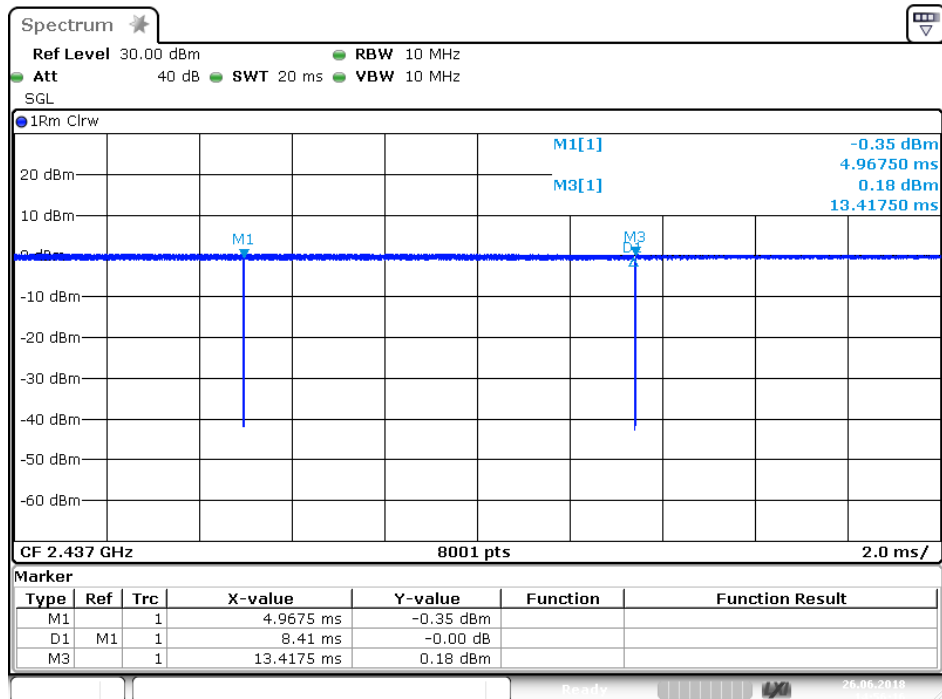

Date: 26.JUN.2018 14:56:16

duty cycle

802.11g Channel Middle 2437MHz(ANT 1)

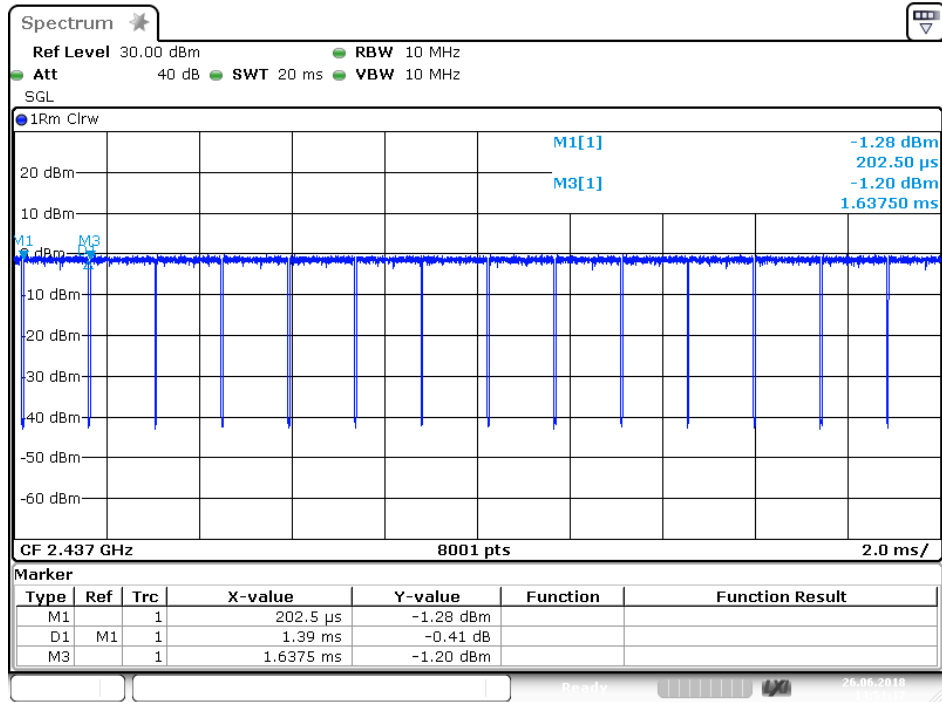

802.11g Channel Middle 2437MHz(ANT 2)

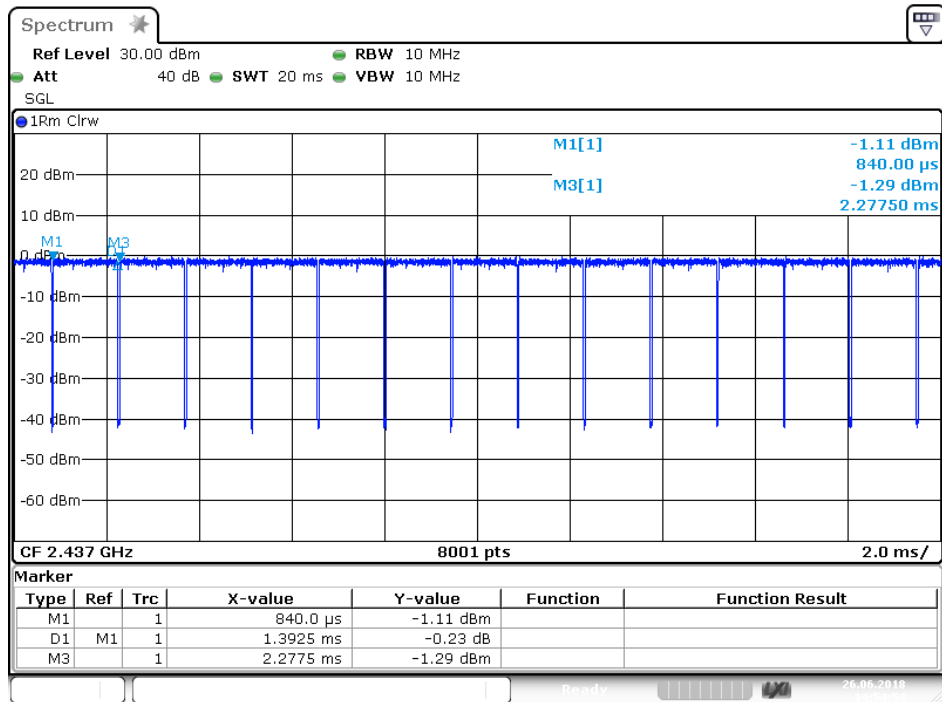



duty cycle

802.11n20 Channel Middle 2437MHz(ANT 1)

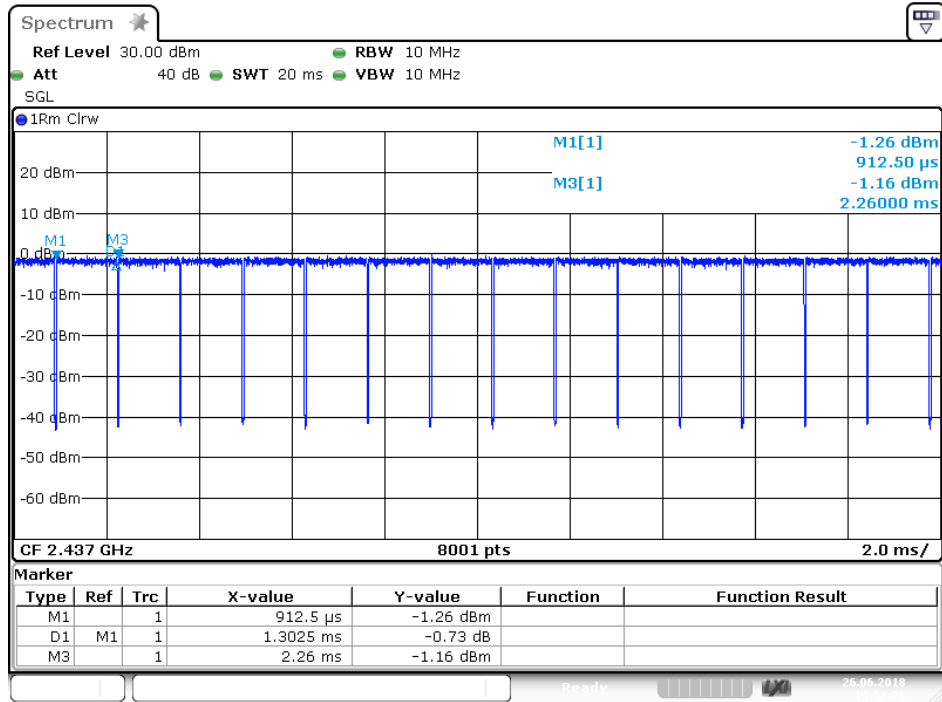

802.11n20 Channel Middle 2437MHz(ANT 2)

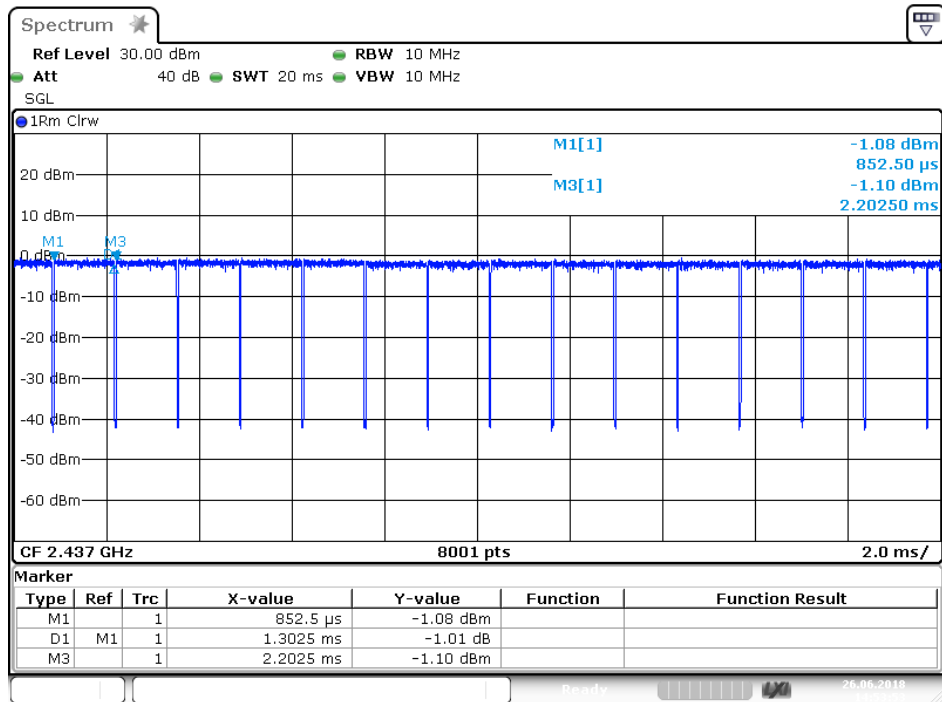

## 8. POWER SPECTRAL DENSITY TEST

### 8.1. Block Diagram of Test Setup

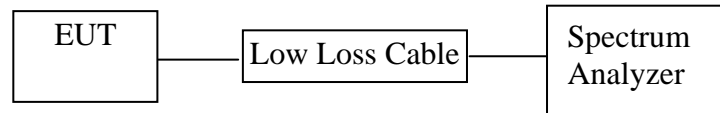

### 8.2. The Requirement For Section 15.247(e)

Section 15.247(e): For digitally modulated systems, the power spectral density conducted from the intentional radiator to the antenna shall not be greater than 8 dBm in any 3 kHz band during any time interval of continuous transmission.

### 8.3. EUT Configuration on Measurement

The equipment are installed on the emission Measurement to meet the commission requirements and operating regulations in a manner which tends to maximize its emission characteristics in normal application.

### 8.4. Operating Condition of EUT

8.4.1. Setup the EUT and simulator as shown as Section 8.1.

8.4.2. Turn on the power of all equipment.

8.4.3. Let the EUT work in TX modes measure it. The transmit frequency are 2412-2462MHz. We select 2412MHz, 2437MHz and 2462MHz TX frequency to transmit.

### 8.5. Test Procedure

8.5.1. The transmitter output was connected to the spectrum analyzer through a low loss cable.

8.5.2. Measurement Procedure PKPSD:

This procedure must be used if maximum peak conducted output power was used to demonstrate compliance to the fundamental output power limit, and is optional if the maximum (average) conducted output power was used to demonstrate compliance.

1. Set analyzer center frequency to DTS channel center frequency.
2. Set the span to 1.5 times the DTS channel bandwidth.
3. Set the RBW  $3 \text{ kHz} \leq \text{RBW} \leq 100 \text{ kHz}$ .

4. Set the VBW  $\geq 3 \times$  RBW.
5. Detector = peak.
6. Sweep time = auto couple.
7. Trace mode = max hold.
8. Allow trace to fully stabilize.
9. Use the peak marker function to determine the maximum amplitude level.
10. If measured value exceeds limit, reduce RBW (no less than 3 kHz) and repeat.

### 8.5.3.Measurement the maximum power spectral density.

## 8.6.Test Result

PASS

The test was performed with 802.11b(SISO)							
Frequency (MHz)	Power Spectral Density ANT 1 (dBm)	Power Spectral Density ANT 2 (dBm)	10log(1/x) ANT 1	10log(1/x) ANT 2	Final Power Spectral Density ANT 1 (dBm)	Final Power Spectral Density ANT 2 (dBm)	Limits (dBm)
2412	-8.36	-9.22	0.02	0.02	-8.34	-9.20	8 dBm
2437	-8.16	-8.85	0.02	0.02	-8.14	-8.83	8 dBm
2462	-8.32	-8.26	0.02	0.02	-8.30	-8.24	8 dBm

The test was performed with 802.11g(SISO)							
Frequency (MHz)	Power Spectral Density ANT 1 (dBm)	Power Spectral Density ANT 2 (dBm)	10log(1/x) ANT 1	10log(1/x) ANT 2	Final Power Spectral Density ANT 1 (dBm)	Final Power Spectral Density ANT 2 (dBm)	Limits (dBm)
2412	-10.37	-11.29	0.14	0.14	-10.23	-11.15	8 dBm
2437	-11.02	-11.57	0.14	0.14	-10.88	-11.43	8 dBm
2462	-10.17	-9.92	0.14	0.14	-10.03	-9.78	8 dBm

The test was performed with 802.11n20(SISO)							
Frequency (MHz)	Power Spectral Density ANT 1 (dBm)	Power Spectral Density ANT 2 (dBm)	10log(1/x) ANT 1	10log(1/x) ANT 2	Final Power Spectral Density ANT 1 (dBm)	Final Power Spectral Density ANT 2 (dBm)	Limits (dBm)
2412	-11.86	-11.79	0.15	0.16	-11.71	-11.63	8 dBm
2437	-10.85	-11.09	0.15	0.16	-10.70	-10.93	8 dBm
2462	-11.00	-10.66	0.15	0.16	-10.85	-10.50	8 dBm

The test was performed with 802.11n20(MIMO)

Frequency (MHz)	Power Spectral Density ANT 1 (dBm)	Power Spectral Density ANT 2 (dBm)	10log(1/x) ANT 1	10log(1/x) ANT 2	Final Power Spectral Density ANT 1 (dBm)	Final Power Spectral Density ANT 2 (dBm)	Total Power Spectral Density (dBm)	Limits (dBm)
2412	-11.74	-12.34	0.15	0.16	-11.59	-12.18	-8.86	8 dBm
2437	-12.33	-11.56	0.15	0.16	-12.18	-11.40	-8.76	8 dBm
2462	-11.49	-11.65	0.15	0.16	-11.34	-11.49	-8.40	8 dBm

Test mode: SISO  
 The spectrum analyzer plots are attached as below.

ANT 1(802.11b)

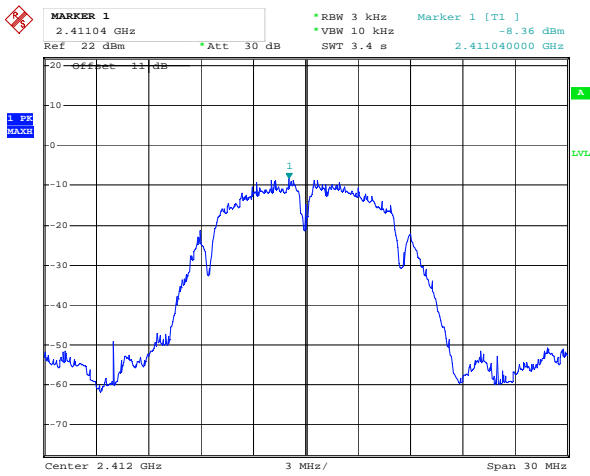

ANT 2(802.11b)

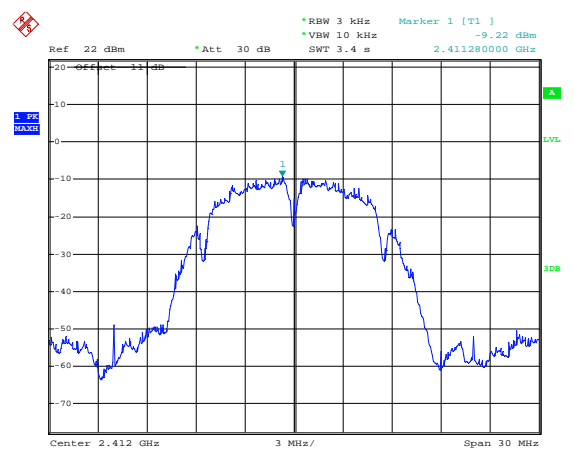

Comment A:  
 Date: 6.JUN.2018 19:34:14

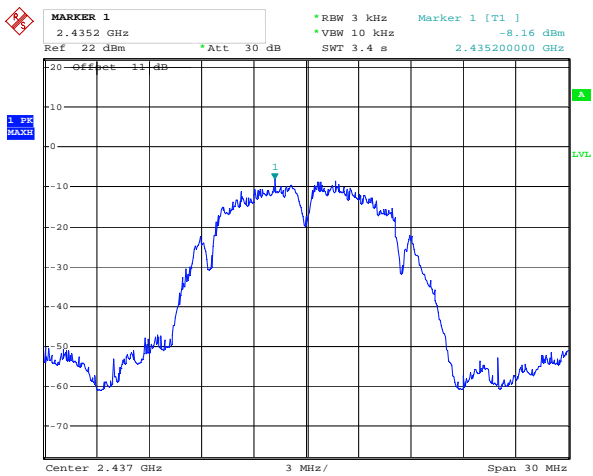

Date: 5.JUN.2018 16:17:17

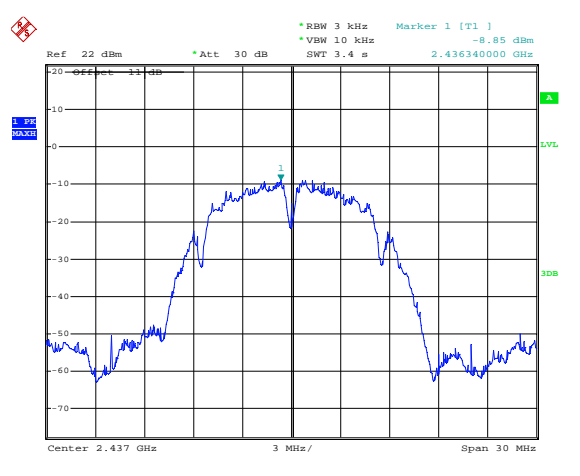

Comment A:  
 Date: 6.JUN.2018 19:30:54

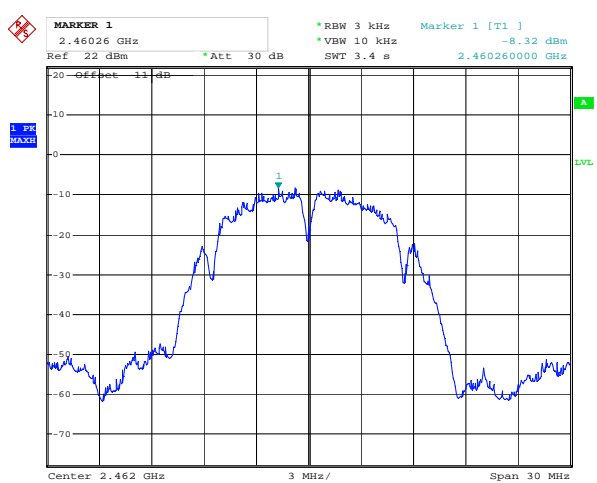

Date: 5.JUN.2018 16:18:27

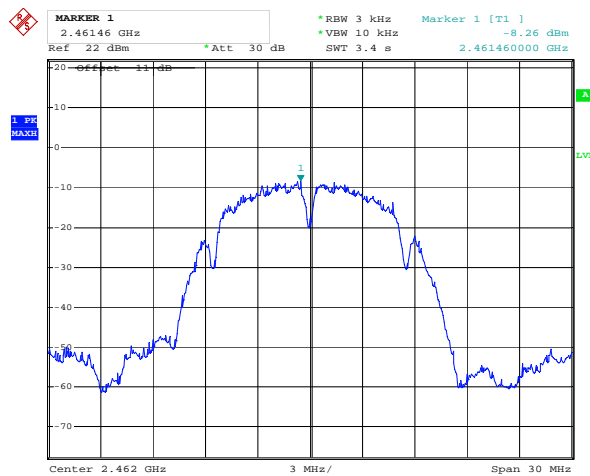

Comment A:  
 Date: 6.JUN.2018 19:30:09

Comment A:  
 Date: 6.JUN.2018 19:29:25

## ANT 1(802.11g)

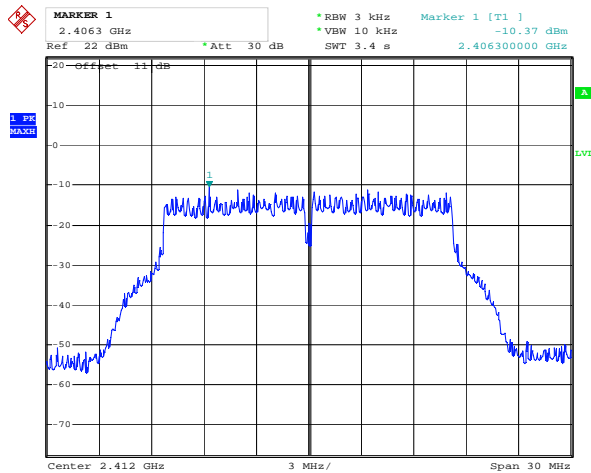

Comment A:  
Date: 6.JUN.2018 19:38:06

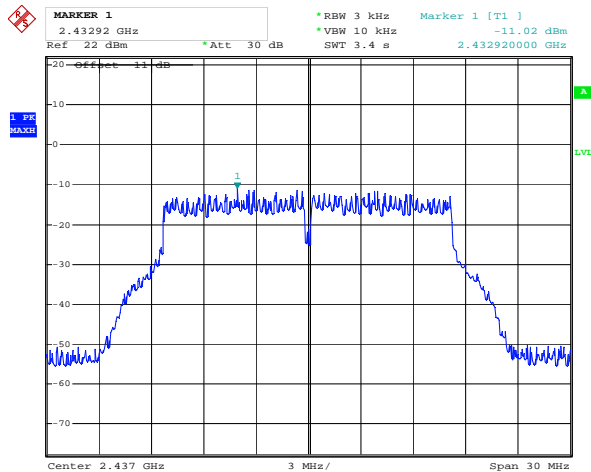

Comment A:  
Date: 6.JUN.2018 19:41:01

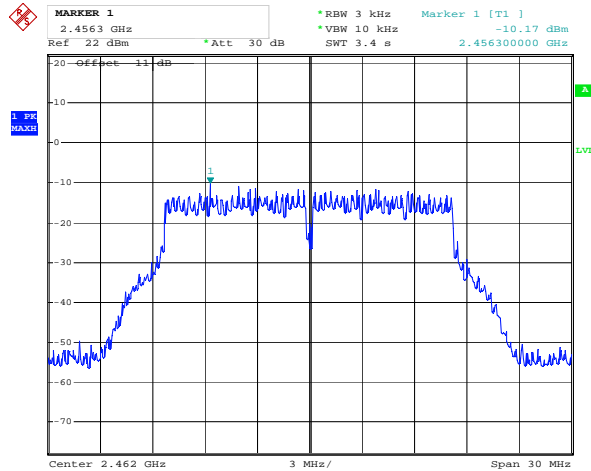

Comment A:  
Date: 6.JUN.2018 19:41:39

## ANT 2(802.11g)

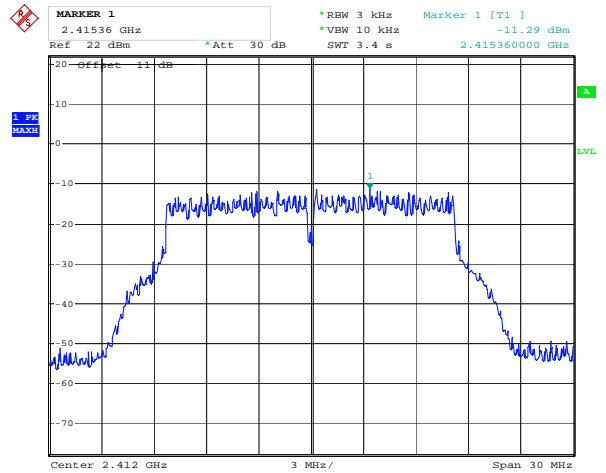

Comment A:  
Date: 6.JUN.2018 19:39:08

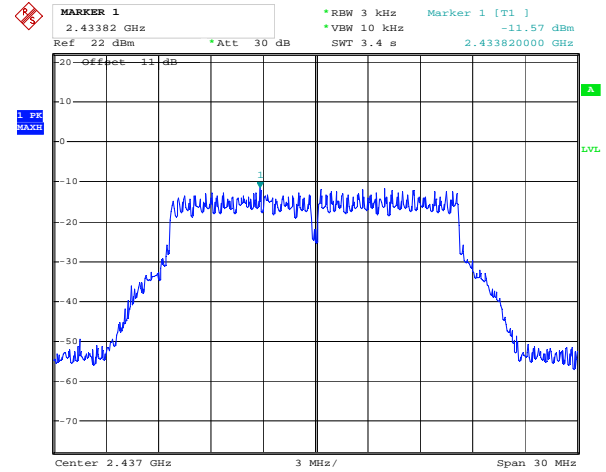

Comment A:  
Date: 6.JUN.2018 19:40:14

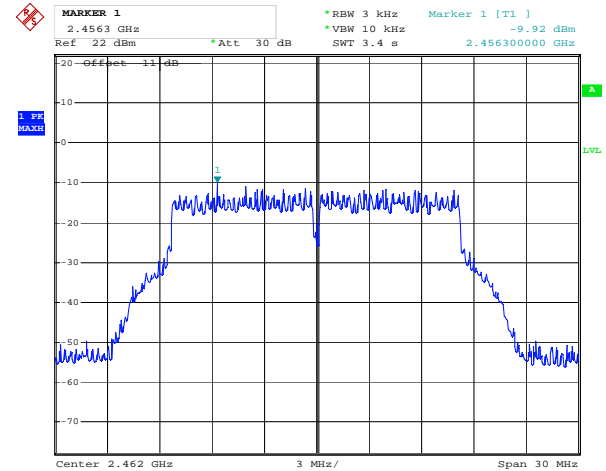

Comment A:  
Date: 6.JUN.2018 19:42:06

## ANT 1(802.11n20)

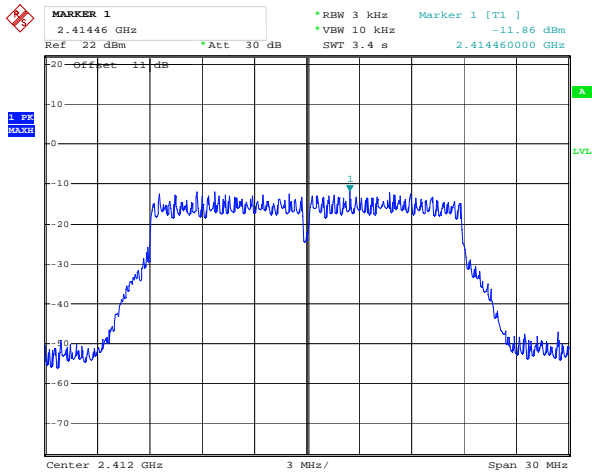

Comment A:  
Date: 6.JUN.2018 19:43:28

## ANT 2(802.11 n20)

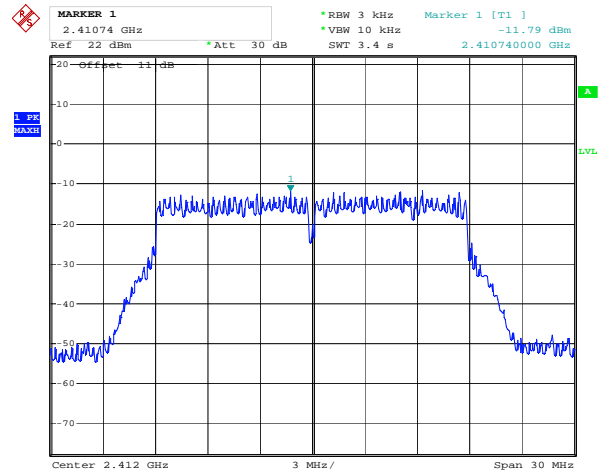

Comment A:  
Date: 6.JUN.2018 19:43:00

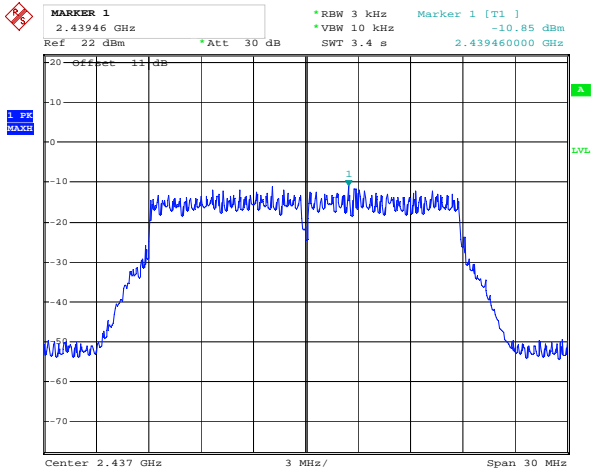

Comment A:  
Date: 6.JUN.2018 19:44:04

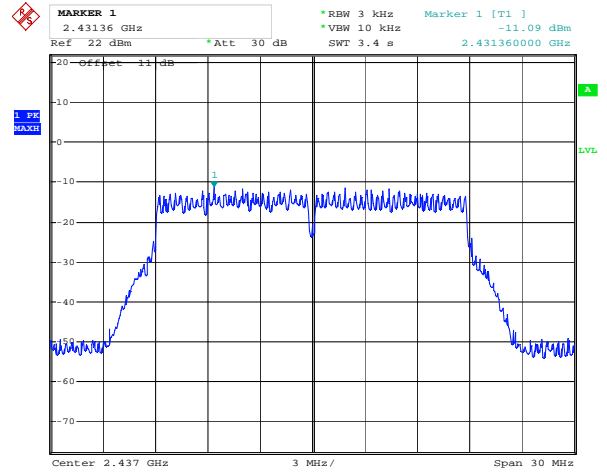

Comment A:  
Date: 6.JUN.2018 19:44:47

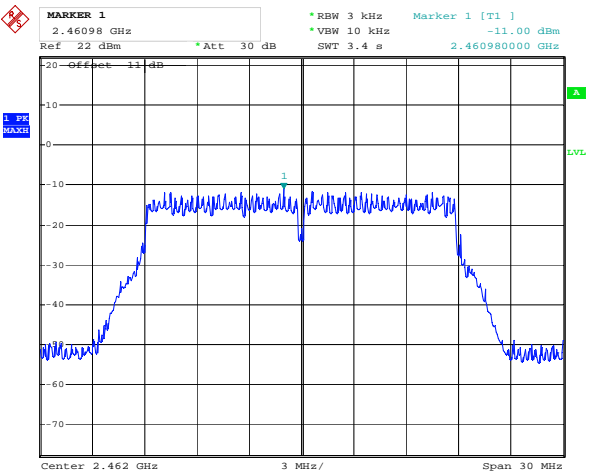

Comment A:  
Date: 6.JUN.2018 19:46:54

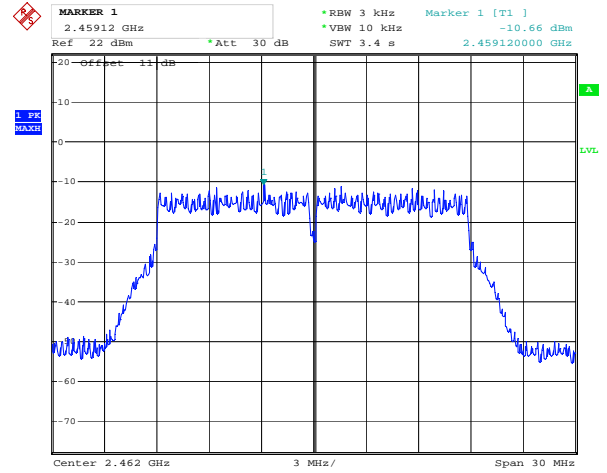

Comment A:  
Date: 6.JUN.2018 19:45:26

Test mode: MIMO  
The spectrum analyzer plots are attached as below.

### ANT 1(802.11n20)

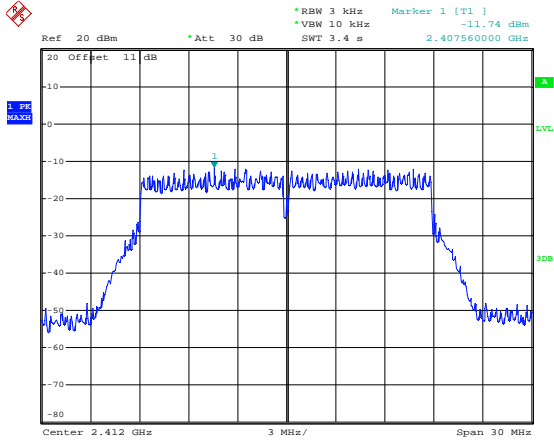

### ANT 2(802.11 n20)

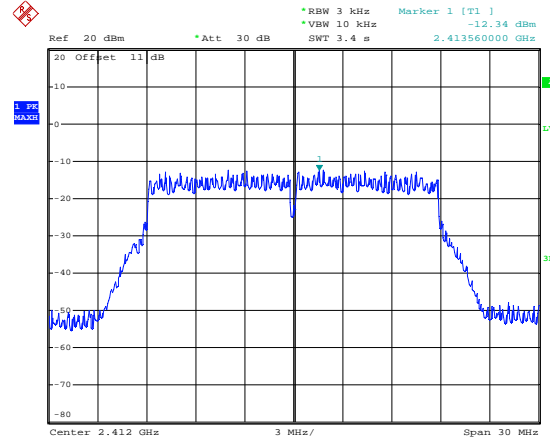

Date: 5.JUN.2018 16:22:41

Date: 5.JUN.2018 16:23:23

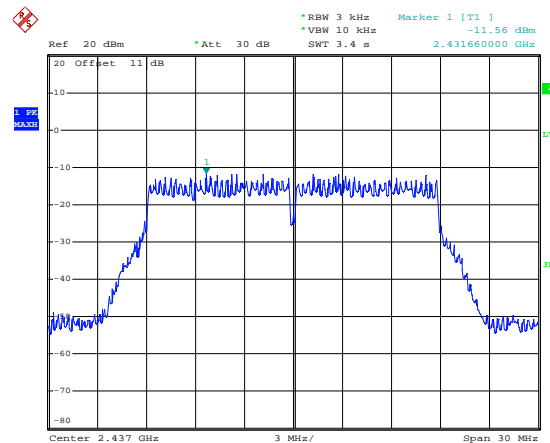
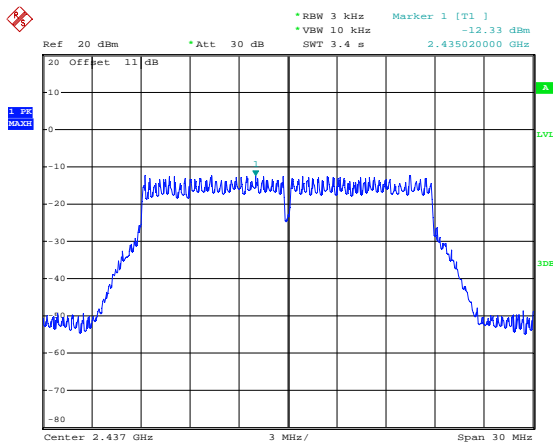

Date: 5.JUN.2018 16:24:14

Date: 5.JUN.2018 16:24:54

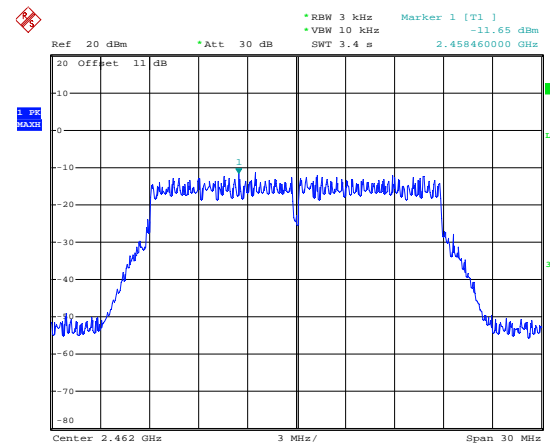
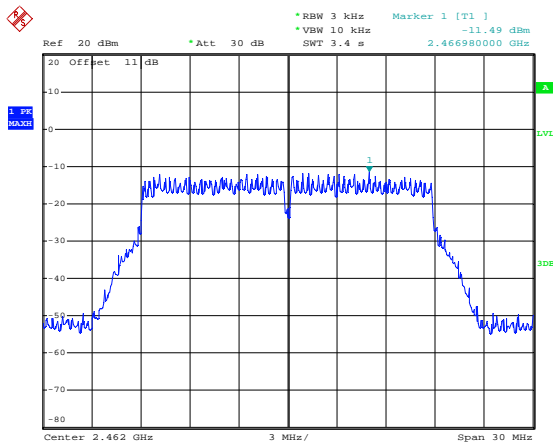

Date: 5.JUN.2018 16:25:42

Date: 5.JUN.2018 16:45:59



## 9. MAXIMUM CONDUCTED (AVERAGE) OUTPUT POWER

### 9.1. Block Diagram of Test Setup

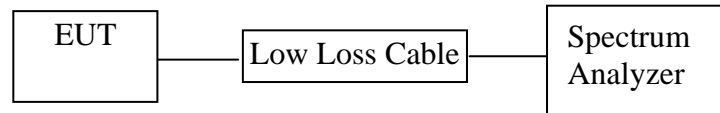

### 9.2. The Requirement For Section 15.247(b)(3)

Section 15.247(b)(3): For systems using digital modulation in the 902-928MHz, 2400-2483.5MHz, and 5725-5850MHz bands: 1 Watt.

### 9.3. EUT Configuration on Measurement

The equipment is installed on the emission Measurement to meet the commission requirements and operating regulations in a manner which tends to maximize its emission characteristics in normal application.

### 9.4. Operating Condition of EUT

9.4.1. Setup the EUT and simulator as shown as Section 9.1.

9.4.2. Turn on the power of all equipment.

9.4.3. Let the EUT work in TX modes measure it. The transmit frequency are 2412-2462MHz. We select 2412MHz, 2437MHz and 2462MHz TX frequency to transmit.

### 9.5. Test Procedure

9.5.1. The EUT was tested according to DTS test procedure of Apr 05, 2017 KDB558074 D01 DTS Meas Guidance v04 for compliance to FCC 47CFR 15.247 requirements.

9.5.2. The transmitter output was connected to the spectrum analyzer through a low loss cable.

9.5.3. Set RBW = 1-5% of the OBW, not to exceed 1 MHz, VBW  $\geq$  3 x RBW, Sweep time = auto, Set span to at least 1.5 times the OBW, Detector = RMS.

9.5.4. Measurement the Maximum conducted (average) output power.

### 9.6.Test Result

Final power= Ave output power+10log(1/ duty cycle)

The test was performed with 802.11b							
Frequency (MHz)	Ave output power ANT 1(dBm)	Ave output power ANT 2 (dBm)	10log(1/ duty cycle) ANT 1	10log(1/ duty cycle) ANT 2	Final output power ANT 1 (dBm)	Final output power ANT 2 (dBm)	Limits dBm / W
2412	17.36	17.23	0.02	0.02	17.38	17.25	30dBm/1W
2437	17.28	17.40	0.02	0.02	17.30	17.42	30dBm/1W
2462	17.47	17.43	0.02	0.02	17.49	17.45	30dBm/1W

The test was performed with 802.11g							
Frequency (MHz)	Ave output power ANT 1(dBm)	Ave output power ANT 2 (dBm)	10log(1/ duty cycle) ANT 1	10log(1/ duty cycle) ANT 2	Final output power ANT 1 (dBm)	Final output power ANT 2 (dBm)	Limits dBm / W
2412	18.43	18.51	0.14	0.14	18.57	18.65	30dBm/1W
2437	18.79	18.80	0.14	0.14	18.93	18.94	30dBm/1W
2462	18.71	18.70	0.14	0.14	18.85	18.84	30dBm/1W

The test was performed with 802.11n20								
Frequency (MHz)	Ave output power ANT1 (dBm)	Ave output power ANT 2 (dBm)	10log(1/ duty cycle) ANT 1	10log(1/ duty cycle) ANT 2	Final output power ANT 1 (dBm)	Final output power ANT 2 (dBm)	Total output power (dBm)	Limits dBm
2412	18.63	18.66	0.15	0.16	18.78	18.82	21.81	30dBm/1W
2437	18.78	18.70	0.15	0.16	18.93	18.86	21.91	30dBm/1W
2462	18.71	18.63	0.15	0.16	18.86	18.79	21.84	30dBm/1W

The spectrum analyzer plots are attached as below.

ANT 1(802.11b)

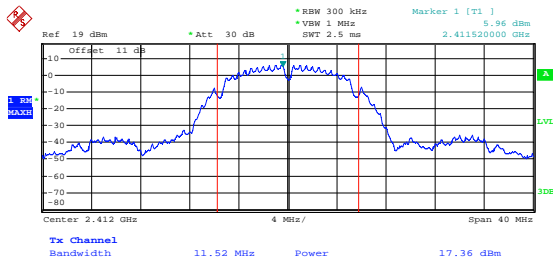

ANT 2(802.11b)

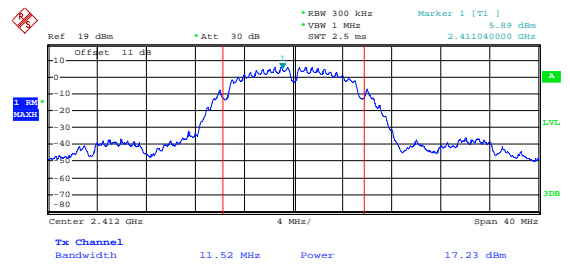

Date: 7.JUN.2018 14:53:38

Date: 7.JUN.2018 14:54:39

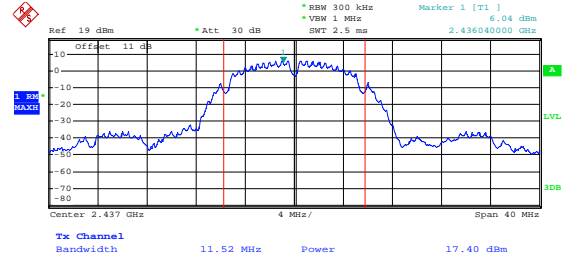
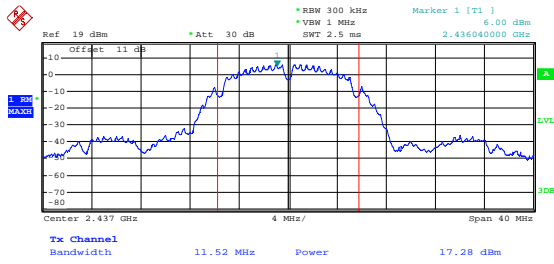

Date: 7.JUN.2018 14:56:03

Date: 7.JUN.2018 14:55:41

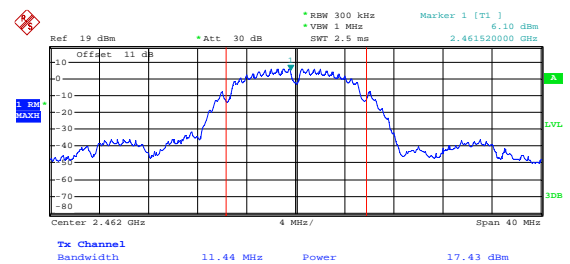
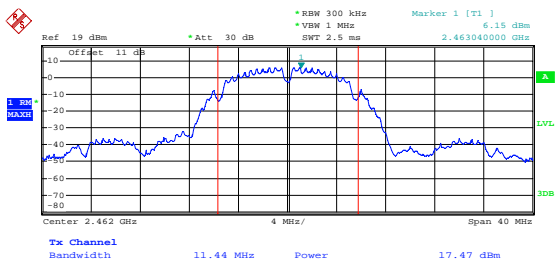

Date: 7.JUN.2018 14:58:28

Date: 7.JUN.2018 14:58:45

## ANT 1(802.11g)

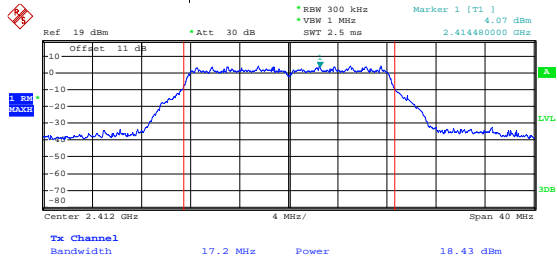

## ANT 2(802.11g)

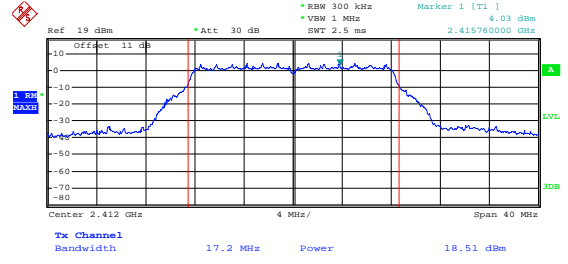

Date: 7.JUN.2018 15:00:24

Date: 7.JUN.2018 15:00:57

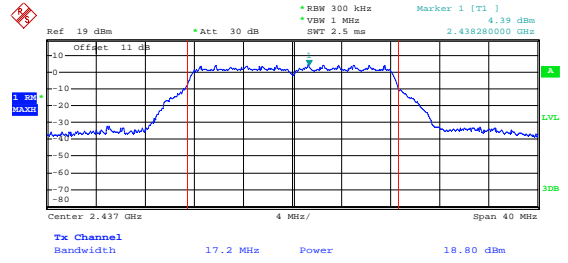
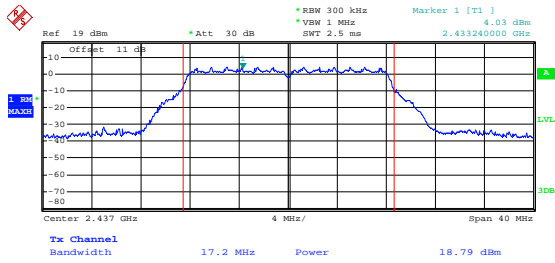

Date: 7.JUN.2018 15:02:05

Date: 7.JUN.2018 15:01:34

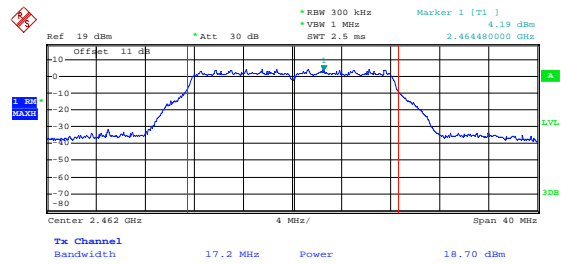
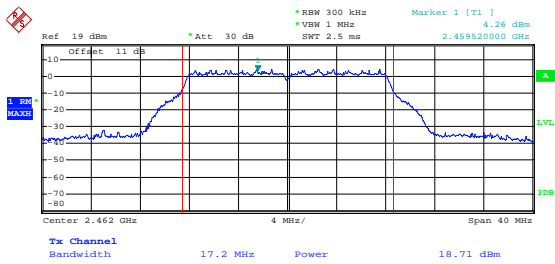

Date: 7.JUN.2018 15:02:38

Date: 7.JUN.2018 15:03:08

### ANT 1(802.11n20)

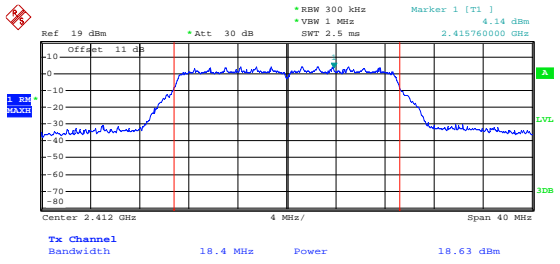

### ANT 2(802.11 n20)

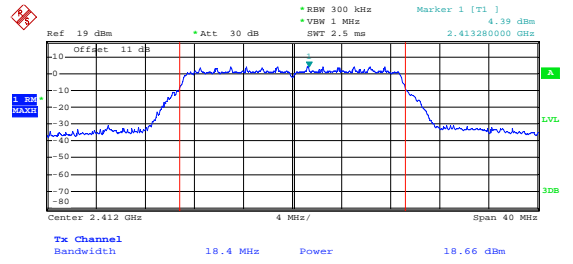

Date: 7.JUN.2018 15:05:54

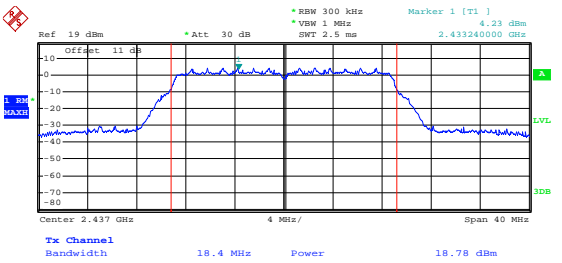

Date: 7.JUN.2018 15:05:23

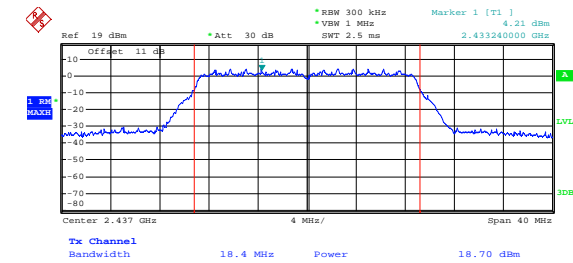

Date: 7.JUN.2018 15:06:34

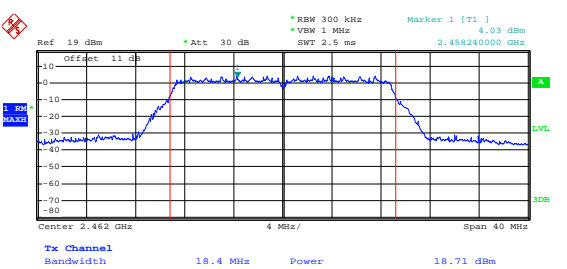

Date: 7.JUN.2018 15:06:54

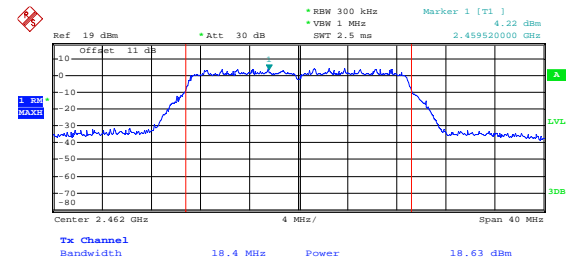

Date: 7.JUN.2018 15:07:46

Date: 7.JUN.2018 15:07:25

## 10. RADIATED SPURIOUS EMISSION TEST

### 10.1. Block Diagram of Test Setup

#### 10.1.1. Block diagram of connection between the EUT and peripherals

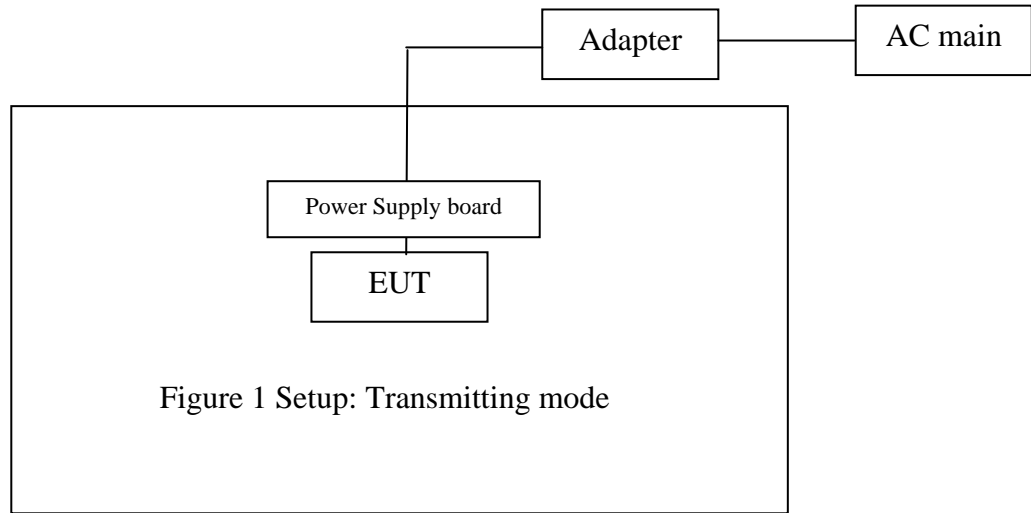

(EUT: UP-Android 7 module)

#### 10.1.2. Semi-Anechoic Chamber Test Setup Diagram

##### (A) Radiated Emission Test Set-Up, Frequency below 30MHz

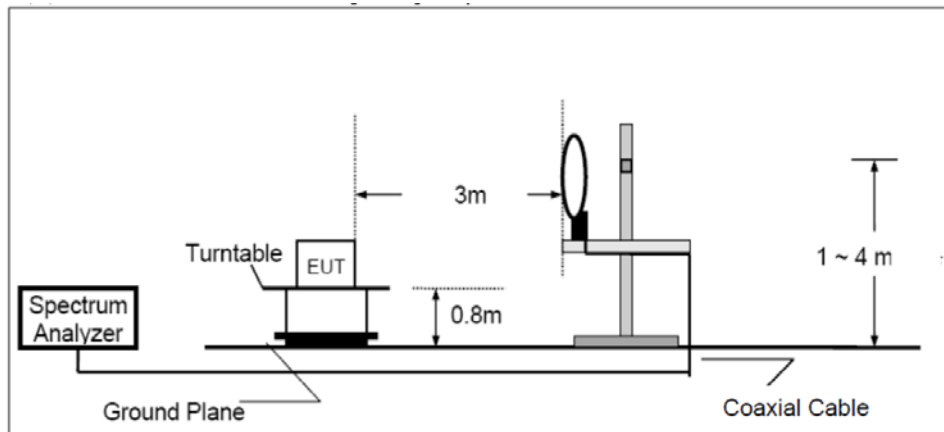

(B) Radiated Emission Test Set-Up, Frequency below 1GHz

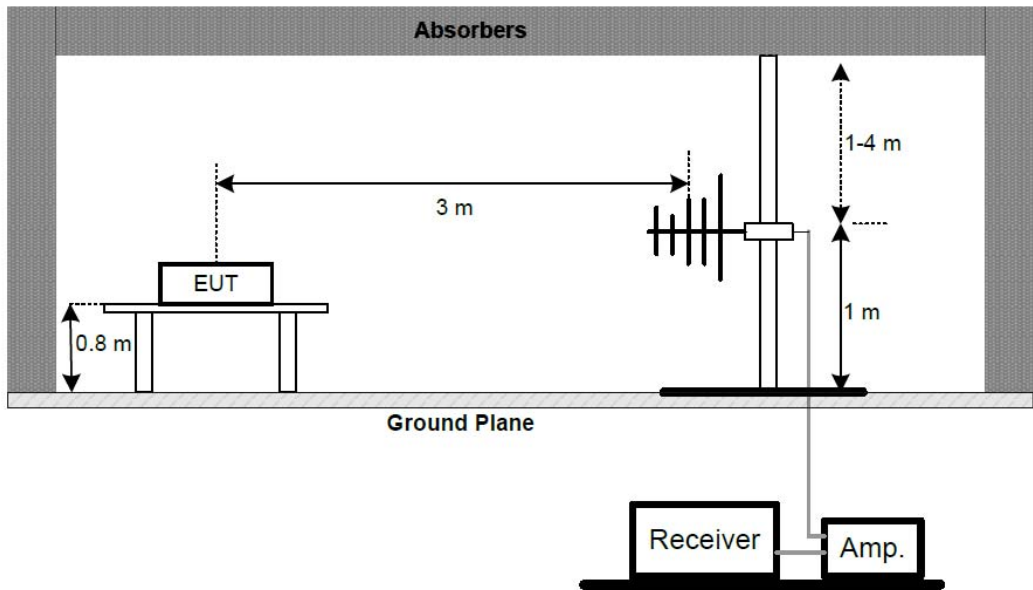

Above 1GHz:

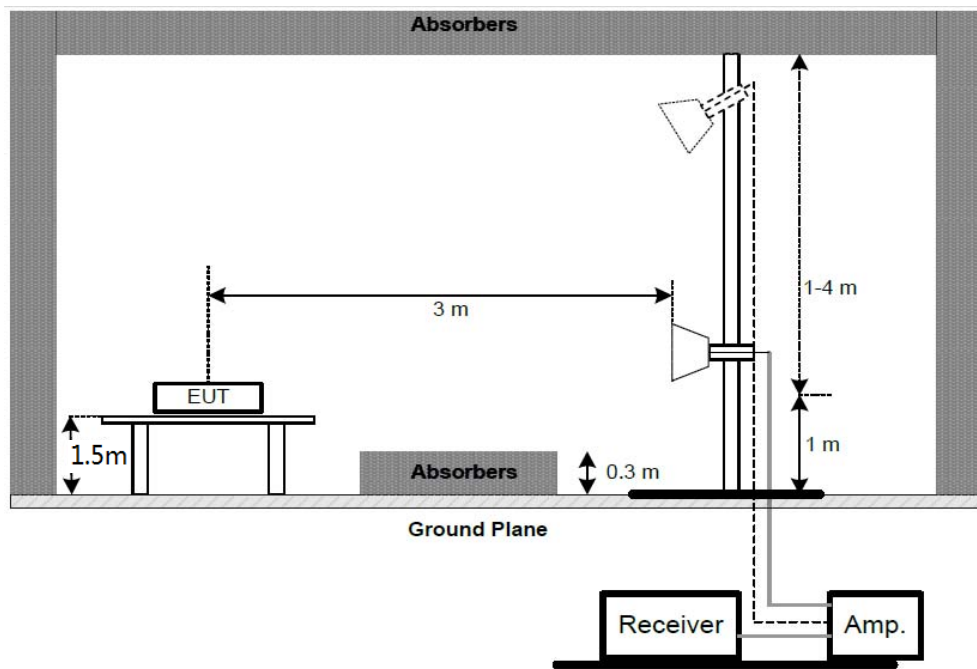

## 10.2.The Limit For Section 15.247(d)

Section 15.247(d): In any 100 kHz bandwidth outside the frequency band in which the spread spectrum or digitally modulated intentional radiator is operating, the radio frequency power that is produced by the intentional radiator shall be at least 20 dB below that in the 100 kHz bandwidth within the band that contains the highest level of the desired power, based on either an RF conducted or a radiated measurement, provided the transmitter demonstrates compliance with the peak conducted power limits. If the transmitter complies with the conducted power limits based on the use of RMS averaging over a time interval, as permitted under paragraph (b)(3) of this section, the attenuation required under this paragraph shall be 30 dB instead of 20 dB. Attenuation below the general limits specified in Section 15.209(a) is not required. In addition, radiated emissions which fall in the restricted bands, as defined in Section 15.205(a), must also comply with the radiated emission limits specified in Section 15.209(a).

## 10.3.Restricted bands of operation

### 10.3.1.FCC Part 15.205 Restricted bands of operation

(a) Except as shown in paragraph (d) of this section, Only spurious emissions are permitted in any of the frequency bands listed below:

MHz	MHz	MHz	GHz
0.090-0.110	16.42-16.423	399.9-410	4.5-5.15
<sup>1</sup> 0.495-0.505	16.69475-16.69525	608-614	5.35-5.46
2.1735-2.1905	16.80425-16.80475	960-1240	7.25-7.75
4.125-4.128	25.5-25.67	1300-1427	8.025-8.5
4.17725-4.17775	37.5-38.25	1435-1626.5	9.0-9.2
4.20725-4.20775	73-74.6	1645.5-1646.5	9.3-9.5
6.215-6.218	74.8-75.2	1660-1710	10.6-12.7
6.26775-6.26825	108-121.94	1718.8-1722.2	13.25-13.4
6.31175-6.31225	123-138	2200-2300	14.47-14.5
8.291-8.294	149.9-150.05	2310-2390	15.35-16.2
8.362-8.366	156.52475-156.52525	2483.5-2500	17.7-21.4
8.37625-8.38675	156.7-156.9	2690-2900	22.01-23.12
8.41425-8.41475	162.0125-167.17	3260-3267	23.6-24.0
12.29-12.293	167.72-173.2	3332-3339	31.2-31.8
12.51975-12.52025	240-285	3345.8-3358	36.43-36.5
12.57675-12.57725	322-335.4	3600-4400	( <sup>2</sup> )
13.36-13.41			

<sup>1</sup>Until February 1, 1999, this restricted band shall be 0.490-0.510

<sup>2</sup>Above 38.6

(b) Except as provided in paragraphs (d) and (e), the field strength of emission appearing within these frequency bands shall not exceed the limits shown in Section 15.209. At frequencies equal to or less than 1000MHz, Compliance with the limits in Section 15.209 shall be demonstrated using measurement instrumentation employing a CISPR quasi-peak detector. Above 1000MHz, compliance with the emission limits in Section 15.209 shall be demonstrated based on the average value of the measured emissions. The provisions in Section 15.35 apply to these measurements.



## 10.4. Configuration of EUT on Measurement

The equipment are installed on Radiated Emission Measurement to meet the commission requirements and operating regulations in a manner which tends to maximize its emission characteristics in normal application.

## 10.5. Operating Condition of EUT

10.5.1. Setup the EUT and simulator as shown as Section 10.1.

10.5.2. Turn on the power of all equipment.

10.5.3. Let the EUT work in TX modes measure it. The transmit frequency are 2412-2462MHz. We select 2412MHz, 2437MHz and 2462MHz TX frequency to transmit.

## 10.6. Test Procedure

The EUT and its simulators are placed on a turntable, which is 0.8 meter high above ground (Below 1GHz). The EUT and its simulators are placed on a turntable, which is 1.5 meter high above ground (Above 1GHz). The turntable can rotate 360 degrees to determine the position of the maximum emission level. EUT is set 3.0 meters away from the receiving antenna, which is mounted on an antenna tower. The antenna can be moved up and down between 1.0 meter and 4 meters to find out the maximum emission level. Broadband antenna (calibrated bi-log antenna) is used as receiving antenna. Both horizontal and vertical polarizations of the antenna are set on measurement. In order to find the maximum emission levels, all of the EUT location must be manipulated according to ANSI C63.10:2013 on radiated emission measurement. The EUT was tested in 3 orthogonal planes.

The worst-case data rate for this channel to be 1Mbps for 802.11b mode and 6Mbps for 802.11g mode and 150Mbps for 802.11n mode, based on previous with 802.11 WLAN product design architectures.

The frequency range from 30MHz to 25000MHz is checked.

Result = Reading + Corrected Factor

Where Corrected Factor = Antenna Factor + Cable Loss – Amplifier Gain

During the radiated emission test, the spectrum analyzer was set with the following configurations:

1. The resolution bandwidth and video bandwidth of test receiver/spectrum analyzer is 120kHz for Quasi-peak at frequency below 1GHz.
2. The resolution bandwidth of test receiver/spectrum analyzer is 1MHz and video bandwidth is 3MHz for peak measurement with peak detector at frequency above 1GHz.
3. The resolution bandwidth of test receiver/spectrum analyzer is 1MHz and video bandwidth is 10Hz for Average measurement with peak detection at frequency above 1GHz.
4. All modes of operation were investigated and the worst-case emissions

are reported.

## 10.7. The Field Strength of Radiation Emission Measurement Results

Note: 1. Emissions attenuated more than 20 dB below the permissible value are not reported.

2. \*: Denotes restricted band of operation.

3. The fundamental radiated emissions were reduced by Band Reject Filter in the attached plots.

4. The EUT is tested radiation emission at each test mode (802.11b/g/n) in three axes. Besides, We have tested the single antenna transmit mode and the dual antenna emission mode. The worst emissions are reflected in the following plots. Only 802.11N support Double antennas can be transmitted at the same time, the worst radiation mode is the 802.11N mode.

5. The radiation emissions from 18-25GHz are not reported, because the test values lower than the limits of 20dB

6. The average measurement was not performed when peak measured data under the limit of average detection.

Below 1G



**ACCURATE TECHNOLOGY CO., LTD.**

F1,Bldg,A,Changyuan New Material Port Keyuan Rd,  
Science & Industry Park,Nanshan Shenzhen,P.R.China

Site: 2# Chamber  
Tel:+86-0755-26503290  
Fax:+86-0755-26503396

Job No.: CLN65 XHUA #13	Polarization: Horizontal
Standard: FCC Class B 3M Radiated	Power Source: DC 12V
Test item: Radiation Test	Date: 18/06/25/
Temp.( C)/Hum.(%) 23 C / 48 %	Time: 11/18/41
EUT: UP-Android 7 module	Engineer Signature: WADE
Mode: TX 2412MHz	Distance: 3m
Model: UPA000AN	
Manufacturer: CTOUCH Europe B.V.	

Note: Report NO.:ATE20180785

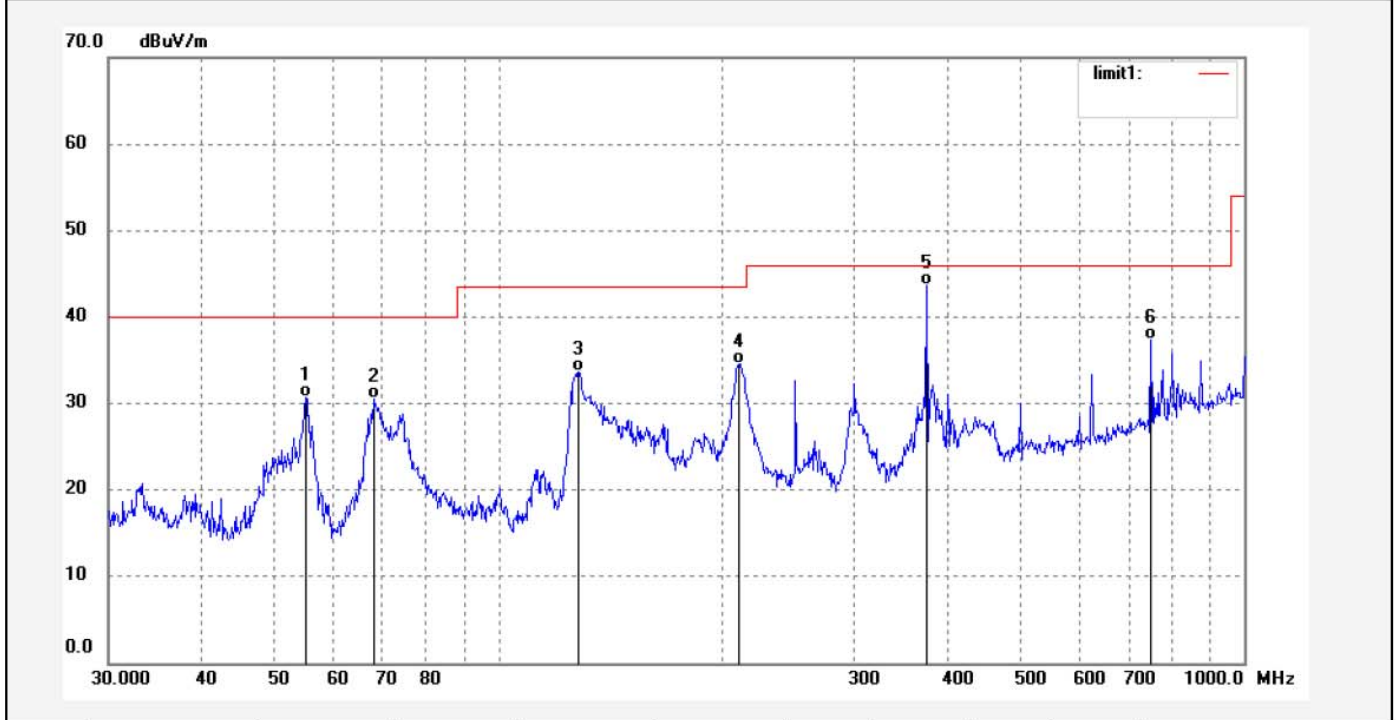

No.	Freq. (MHz)	Reading (dBuV/m)	Factor (dB)	Result (dBuV/m)	Limit (dBuV/m)	Margin (dB)	Detector	Height (cm)	Degree (deg.)	Remark
1	55.2207	43.63	-12.99	30.64	40.00	-9.36	QP	100	287	
2	68.1512	46.52	-15.93	30.59	40.00	-9.41	QP	100	92	
3	128.1129	47.35	-13.71	33.64	43.50	-9.86	QP	100	196	
4	210.0482	46.56	-11.99	34.57	43.50	-8.93	QP	100	321	
5	375.9384	50.74	-7.06	43.68	46.00	-2.32	QP	100	81	
6	750.1082	37.63	-0.29	37.34	46.00	-8.66	QP	100	318	

Job No.: CLN65 XHUA #14  
 Standard: FCC Class B 3M Radiated  
 Test item: Radiation Test  
 Temp.( C)/Hum.(%) 23 C / 48 %  
 EUT: UP-Android 7 module  
 Mode: TX 2412MHz  
 Model: UPA000AN  
 Manufacturer: CTOUCH Europe B.V.

Polarization: Vertical  
 Power Source: DC 12V  
 Date: 18/06/25/  
 Time: 11/30/54  
 Engineer Signature: WADE  
 Distance: 3m

Note: Report NO.:ATE20180785

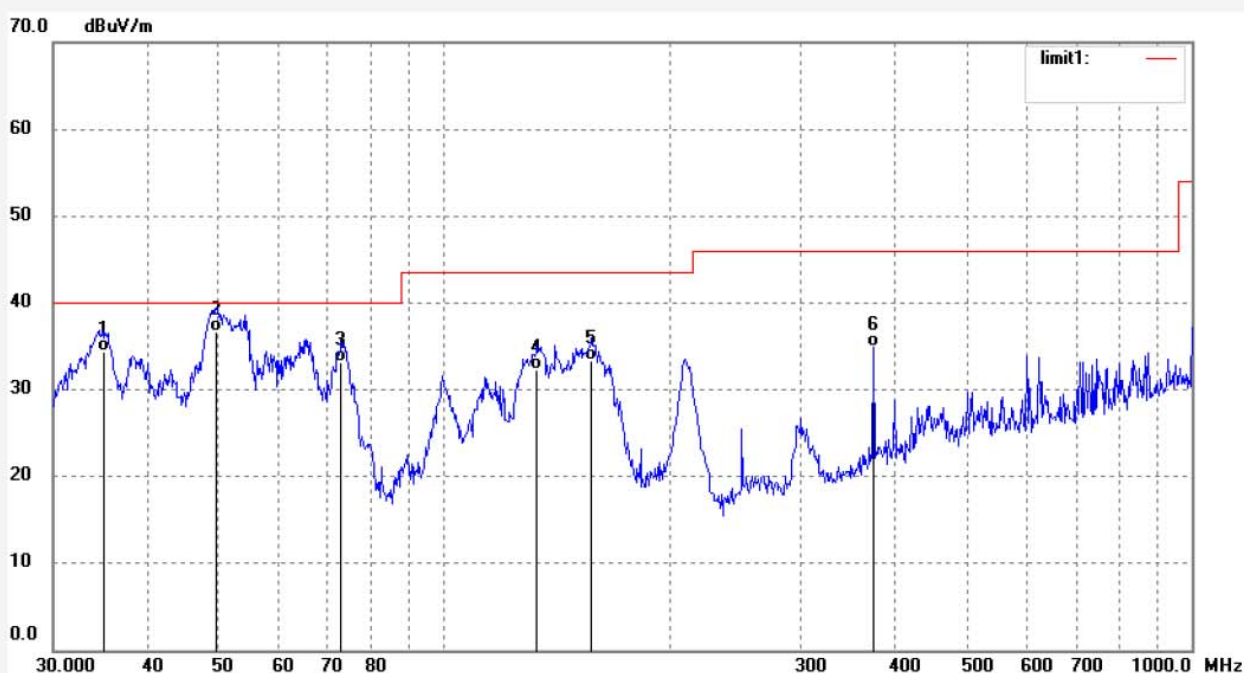

No.	Freq. (MHz)	Reading (dBuV/m)	Factor (dB)	Result (dBuV/m)	Limit (dBuV/m)	Margin (dB)	Detector	Height (cm)	Degree (deg.)	Remark
1	35.1278	44.81	-10.44	34.37	40.00	-5.63	QP	100	61	
2	49.5328	49.27	-12.58	36.69	40.00	-3.31	QP	100	175	
3	72.8465	49.69	-16.44	33.25	40.00	-6.75	QP	100	298	
4	133.1511	46.25	-13.89	32.36	43.50	-11.14	QP	100	318	
5	157.5588	48.00	-14.69	33.31	43.50	-10.19	QP	100	181	
6	375.9384	41.93	-7.06	34.87	46.00	-11.13	QP	100	178	

Job No.: CLN65 XHUA #16  
 Standard: FCC Class B 3M Radiated  
 Test item: Radiation Test  
 Temp.( C)/Hum.(%) 23 C / 48 %  
 EUT: UP-Android 7 module  
 Mode: TX 2437MHz  
 Model: UPA000AN  
 Manufacturer: CTOUCH Europe B.V.

Polarization: Horizontal  
 Power Source: DC 12V  
 Date: 18/06/25/  
 Time: 11/32/58  
 Engineer Signature: WADE  
 Distance: 3m

Note: Report NO.:ATE20180785

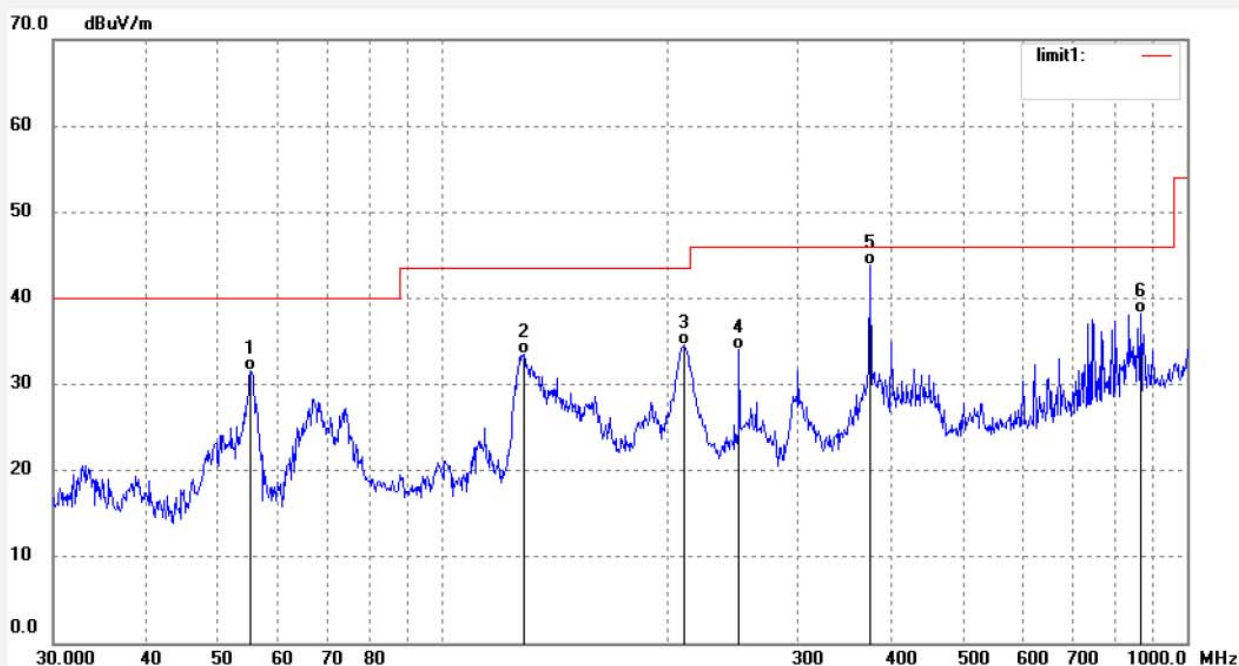

No.	Freq. (MHz)	Reading (dBuV/m)	Factor (dB)	Result (dBuV/m)	Limit (dBuV/m)	Margin (dB)	Detector	Height (cm)	Degree (deg.)	Remark
1	55.2207	44.65	-12.99	31.66	40.00	-8.34	QP	100	318	
2	128.5629	47.28	-13.72	33.56	43.50	-9.94	QP	100	231	
3	210.7860	46.56	-11.94	34.62	43.50	-8.88	QP	100	327	
4	250.3011	44.60	-10.54	34.06	46.00	-11.94	QP	100	216	
5	375.9384	50.88	-7.06	43.82	46.00	-2.18	QP	100	131	
6	866.0878	36.43	1.89	38.32	46.00	-7.68	QP	100	68	

Job No.: CLN65 XHUA #15  
 Standard: FCC Class B 3M Radiated  
 Test item: Radiation Test  
 Temp.( C)/Hum.(%) 23 C / 48 %  
 EUT: UP-Android 7 module  
 Mode: TX 2437MHz  
 Model: UPA000AN  
 Manufacturer: CTOUCH Europe B.V.

Polarization: Vertical  
 Power Source: DC 12V  
 Date: 18/06/25/  
 Time: 11/32/00  
 Engineer Signature: WADE  
 Distance: 3m

Note: Report NO.:ATE20180785

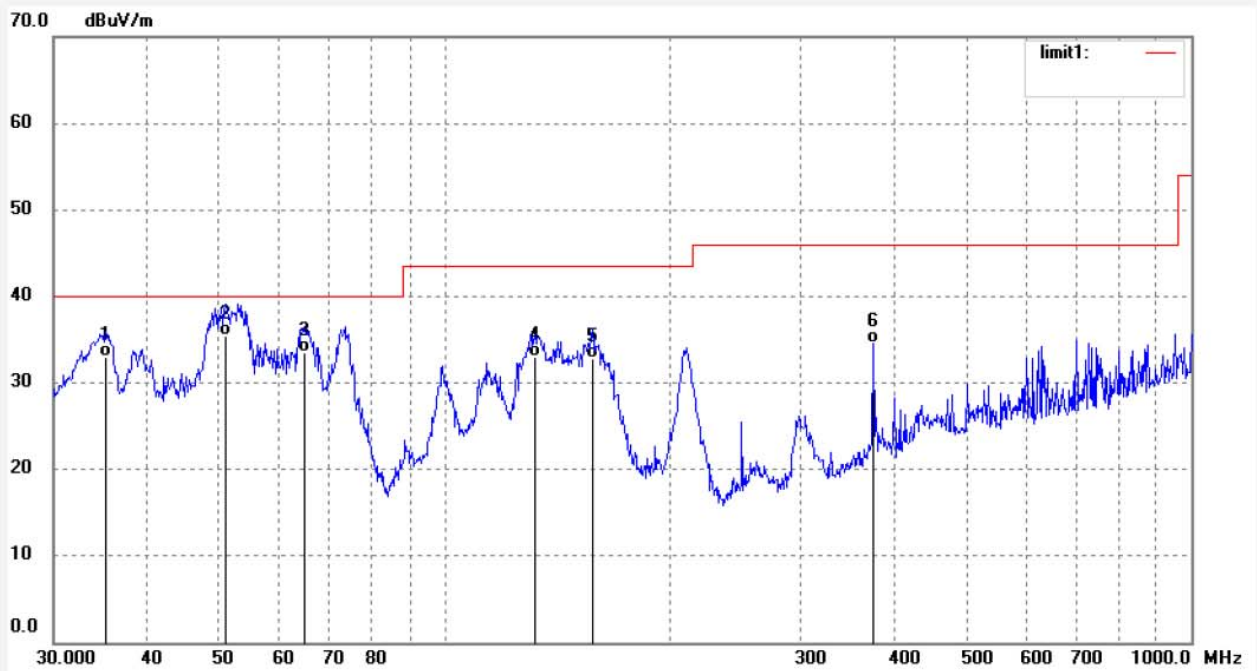

No.	Freq. (MHz)	Reading (dBuV/m)	Factor (dB)	Result (dBuV/m)	Limit (dBuV/m)	Margin (dB)	Detector	Height (cm)	Degree (deg.)	Remark
1	35.2511	43.54	-10.47	33.07	40.00	-6.93	QP	100	81	
2	50.9420	48.10	-12.65	35.45	40.00	-4.55	QP	100	319	
3	64.8864	49.20	-15.65	33.55	40.00	-6.45	QP	100	318	
4	132.2205	46.78	-13.84	32.94	43.50	-10.56	QP	100	56	
5	158.1123	47.40	-14.62	32.78	43.50	-10.72	QP	100	185	
6	375.9384	41.71	-7.06	34.65	46.00	-11.35	QP	100	276	



**ACCURATE TECHNOLOGY CO., LTD.**

F1,Bldg,A,Changyuan New Material Port Keyuan Rd,  
Science & Industry Park,Nanshan Shenzhen,P.R.China

Site: 2# Chamber  
Tel:+86-0755-26503290  
Fax:+86-0755-26503396

Job No.: CLN65 XHUA #17	Polarization: Horizontal
Standard: FCC Class B 3M Radiated	Power Source: DC 12V
Test item: Radiation Test	Date: 18/06/25/
Temp.( C)/Hum.(%) 23 C / 48 %	Time: 11/33/38
EUT: UP-Android 7 module	Engineer Signature: WADE
Mode: TX 2462MHz	Distance: 3m
Model: UPA000AN	
Manufacturer: CTOUCH Europe B.V.	

Note: Report NO.:ATE20180785

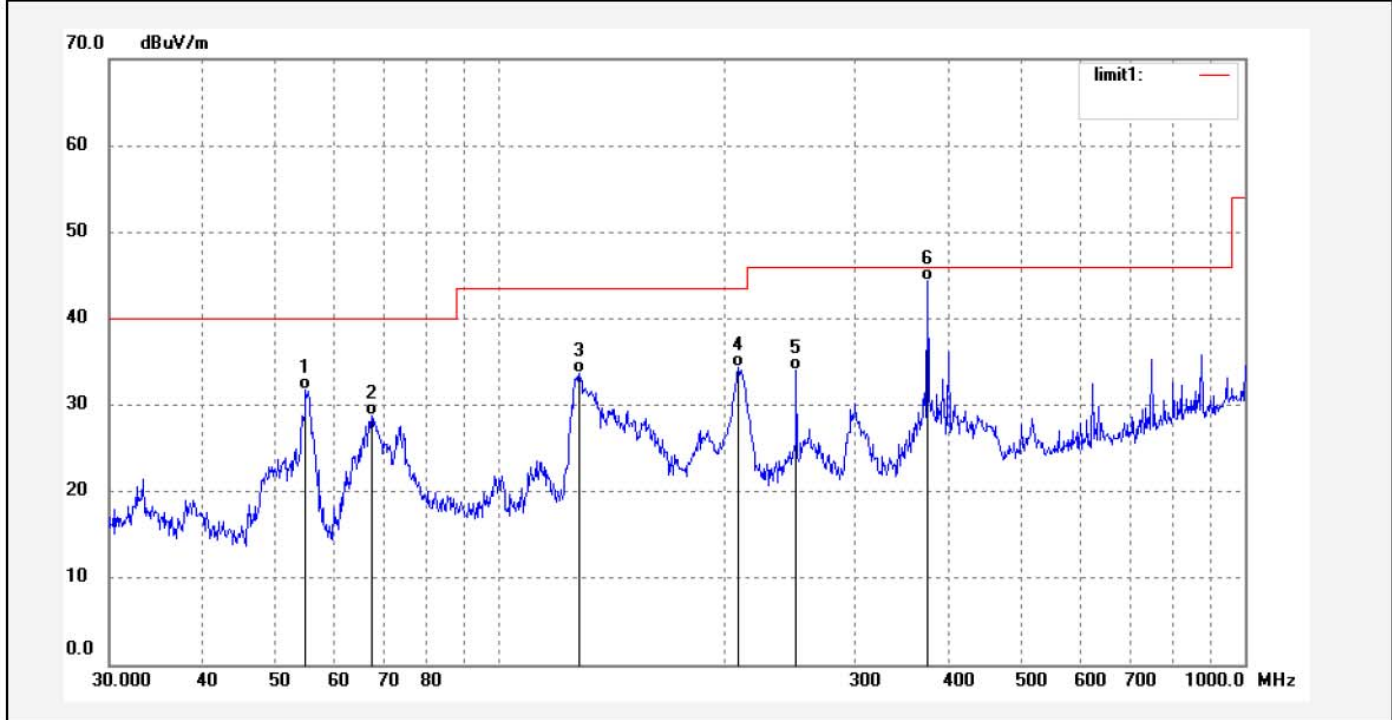

No.	Freq. (MHz)	Reading (dBuV/m)	Factor (dB)	Result (dBuV/m)	Limit (dBuV/m)	Margin (dB)	Detector	Height (cm)	Degree (deg.)	Remark
1	55.0274	44.78	-12.95	31.83	40.00	-8.17	QP	100	319	
2	67.4381	44.69	-15.87	28.82	40.00	-11.18	QP	100	167	
3	128.1129	47.47	-13.71	33.76	43.50	-9.74	QP	100	184	
4	209.3129	46.41	-12.02	34.39	43.50	-9.11	QP	100	162	
5	250.3011	44.59	-10.54	34.05	46.00	-11.95	QP	100	264	
6	375.9384	51.34	-7.06	44.28	46.00	-1.72	QP	100	297	



**ACCURATE TECHNOLOGY CO., LTD.**

F1,Bldg,A,Changyuan New Material Port Keyuan Rd,  
Science & Industry Park,Nanshan Shenzhen,P.R.China

Site: 2# Chamber

Tel:+86-0755-26503290

Fax:+86-0755-26503396

Job No.: CLN65 XHUA #18	Polarization: Vertical
Standard: FCC Class B 3M Radiated	Power Source: DC 12V
Test item: Radiation Test	Date: 18/06/25/
Temp.( C)/Hum.(%) 23 C / 48 %	Time: 11/34/27
EUT: UP-Android 7 module	Engineer Signature: WADE
Mode: TX 2462MHz	Distance: 3m
Model: UPA000AN	
Manufacturer: CTOUCH Europe B.V.	

Note: Report NO.:ATE20180785

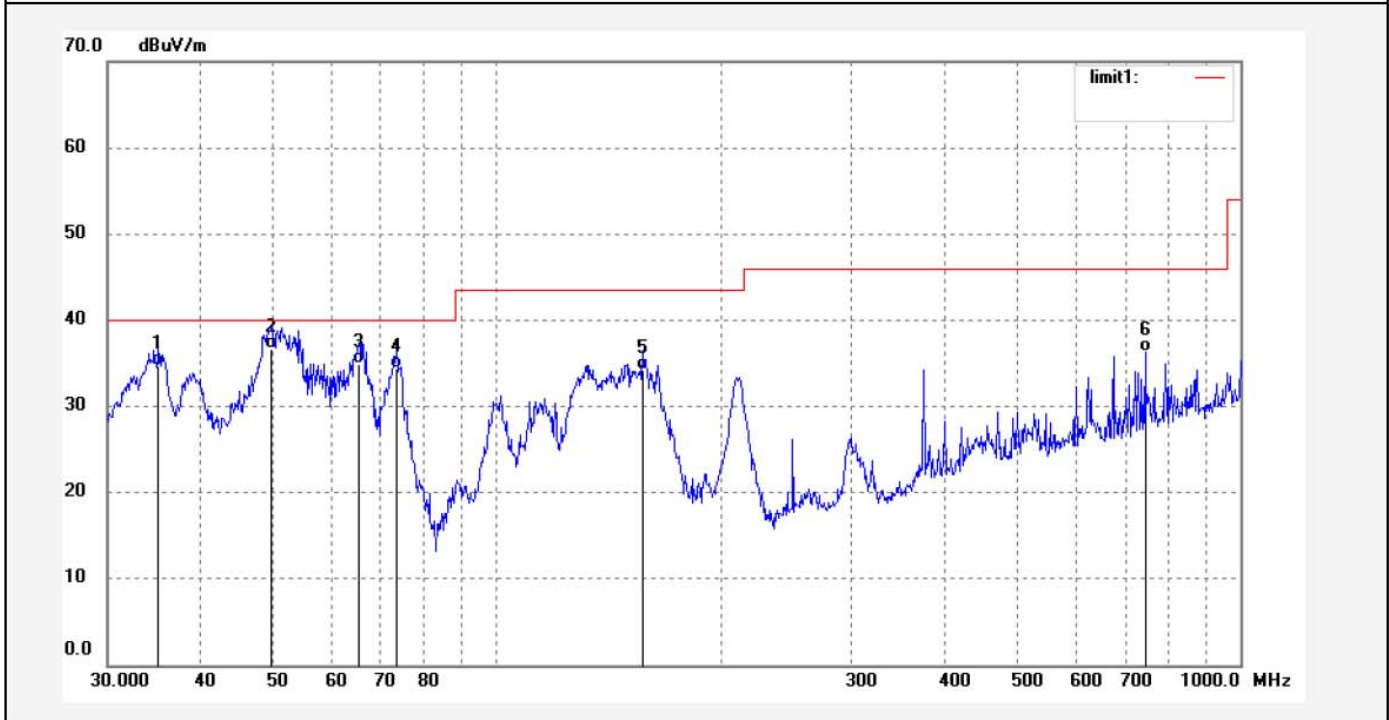

No.	Freq. (MHz)	Reading (dBuV/m)	Factor (dB)	Result (dBuV/m)	Limit (dBuV/m)	Margin (dB)	Detector	Height (cm)	Degree (deg.)	Remark
1	35.1278	45.10	-10.44	34.66	40.00	-5.34	QP	100	217	
2	49.7068	49.23	-12.59	36.64	40.00	-3.36	QP	100	181	
3	65.3431	50.57	-15.72	34.85	40.00	-5.15	QP	100	93	
4	73.3593	50.90	-16.51	34.39	40.00	-5.61	QP	100	318	
5	157.0073	49.00	-14.75	34.25	43.50	-9.25	QP	100	313	
6	744.8660	36.73	-0.37	36.36	46.00	-9.64	QP	100	321	



## Above 1G

**ACCURATE TECHNOLOGY CO., LTD.**

 F1,Bldg,A,Changyuan New Material Port Keyuan Rd,  
 Science & Industry Park,Nanshan Shenzhen,P.R.China

Site: 2# Chamber

Tel:+86-0755-26503290

Fax:+86-0755-26503396

Job No.: CLN65 XHUA #33

Standard: FCC PK

Test item: Radiation Test

Temp.( C)/Hum.(%) 23 C / 48 %

EUT: UP-Android 7 module

Mode: TX 2412MHz (802.11N)

Model: UPA000AN

Manufacturer: CTOUCH Europe B.V.

Polarization: Horizontal

Power Source: DC 12V

Date: 18/06/25/

Time: 12/00/09

Engineer Signature: WADE

Distance: 3m

Note: Report NO.:ATE20180785

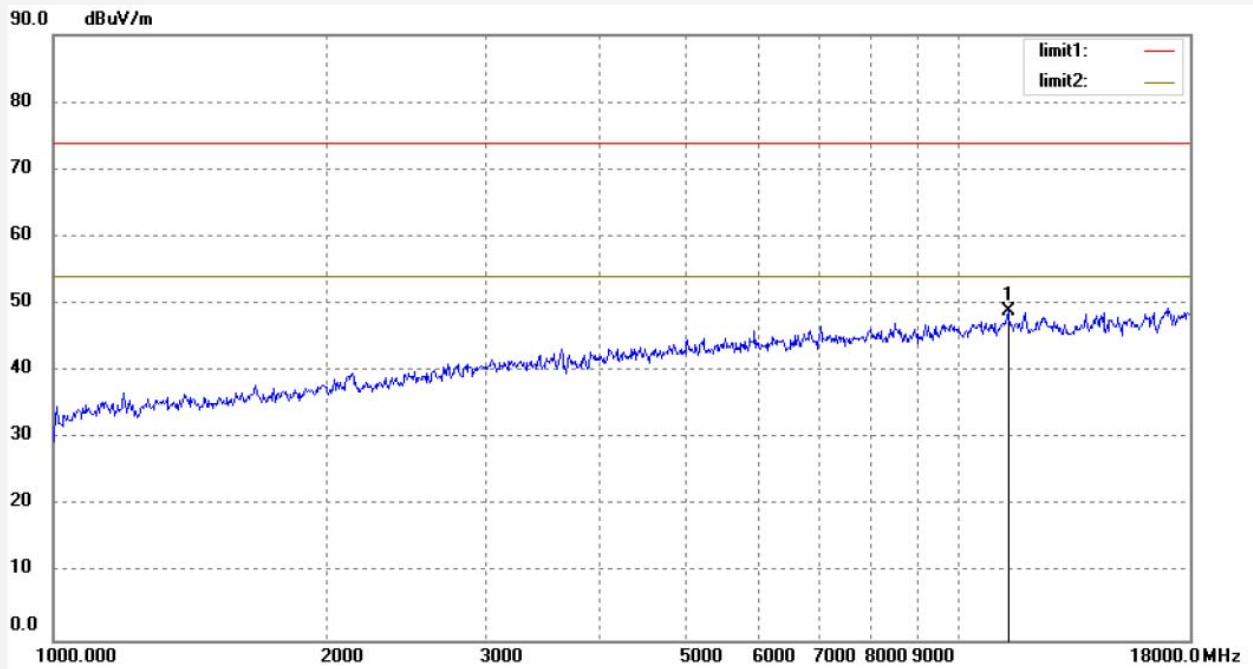

No.	Freq. (MHz)	Reading (dBuV/m)	Factor (dB)	Result (dBuV/m)	Limit (dBuV/m)	Margin (dB)	Detector	Height (cm)	Degree (deg.)	Remark
1	11335.193	-2.97	51.81	48.84	74.00	-25.16	peak	150	190	

Job No.: CLN65 XHUA #32

Standard: FCC PK

Test item: Radiation Test

Temp.( C)/Hum.(%) 23 C / 48 %

EUT: UP-Android 7 module

Mode: TX 2412MHz (802.11N)

Model: UPA000AN

Manufacturer: CTOUCH Europe B.V.

Polarization: Vertical

Power Source: DC 12V

Date: 18/06/25/

Time: 11/59/16

Engineer Signature: WADE

Distance: 3m

Note: Report NO.:ATE20180785

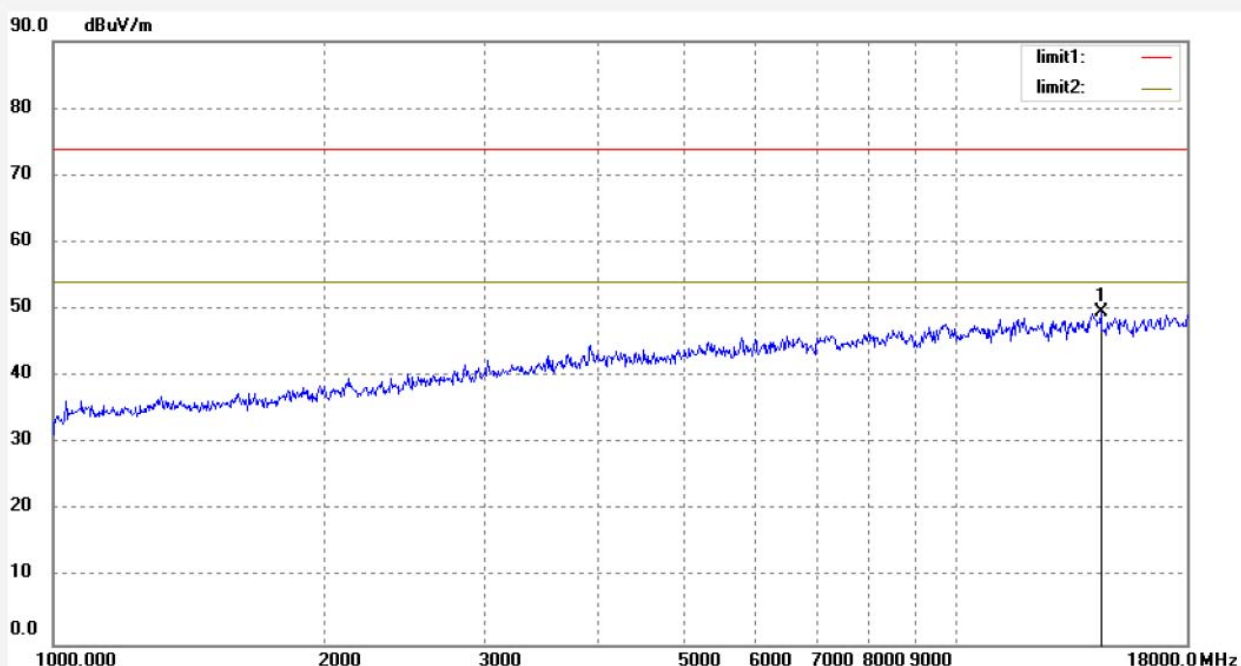

No.	Freq. (MHz)	Reading (dBuV/m)	Factor (dB)	Result (dBuV/m)	Limit (dBuV/m)	Margin (dB)	Detector	Height (cm)	Degree (deg.)	Remark
1	14450.131	-10.74	60.27	49.53	74.00	-24.47	peak	150	319	

Job No.: CLN65 XHUA #34

Standard: FCC PK

Test item: Radiation Test

Temp.( C)/Hum.(%) 23 C / 48 %

EUT: UP-Android 7 module

Mode: TX 2437MHz (802.11N)

Model: UPA000AN

Manufacturer: CTOUCH Europe B.V.

Polarization: Horizontal

Power Source: DC 12V

Date: 18/06/25/

Time: 12/01/38

Engineer Signature: WADE

Distance: 3m

Note: Report NO.:ATE20180785

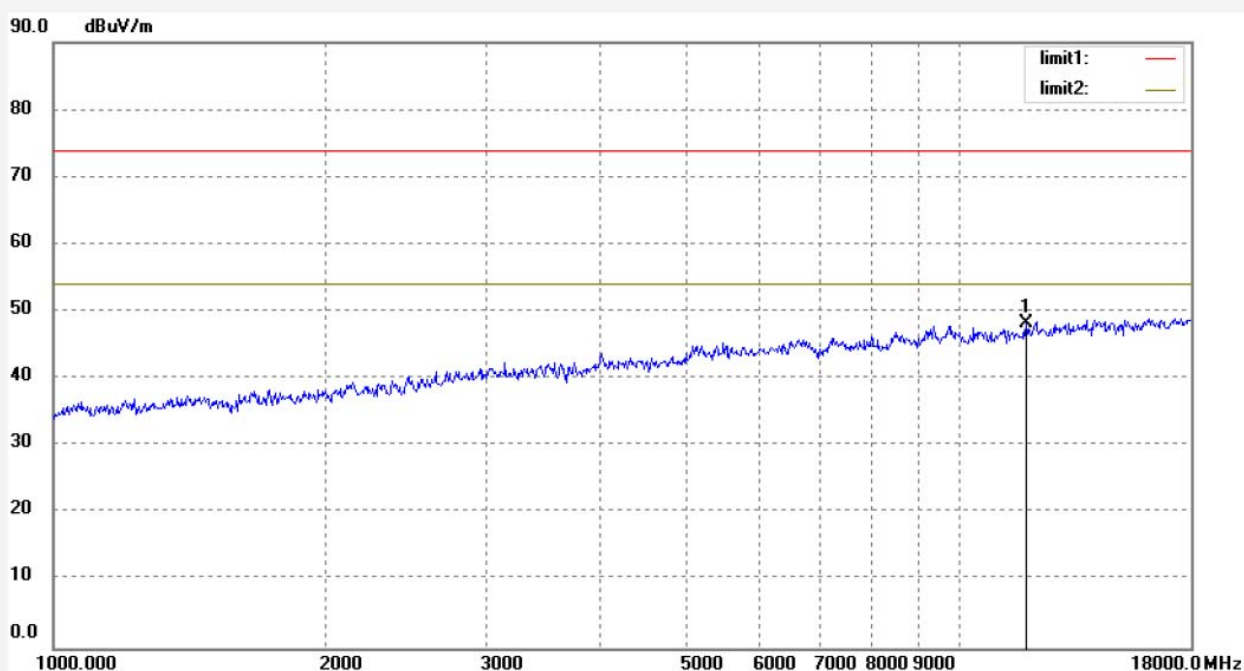

No.	Freq. (MHz)	Reading (dBuV/m)	Factor (dB)	Result (dBuV/m)	Limit (dBuV/m)	Margin (dB)	Detector	Height (cm)	Degree (deg.)	Remark
1	11837.445	-5.28	53.54	48.26	74.00	-25.74	peak	150	236	

**ACCURATE TECHNOLOGY CO., LTD.**

 F1,Bldg,A,Changyuan New Material Port Keyuan Rd,  
 Science & Industry Park,Nanshan Shenzhen,P.R.China

Site: 2# Chamber

Tel:+86-0755-26503290

Fax:+86-0755-26503396

 Job No.: CLN65 XHUA #35  
 Standard: FCC PK  
 Test item: Radiation Test  
 Temp.( C)/Hum.(%) 23 C / 48 %  
 EUT: UP-Android 7 module  
 Mode: TX 2437MHz (802.11N)  
 Model: UPA000AN  
 Manufacturer: CTOUCH Europe B.V.

 Polarization: Vertical  
 Power Source: DC 12V  
 Date: 18/06/25/  
 Time: 12/02/46  
 Engineer Signature: WADE  
 Distance: 3m

Note: Report NO.:ATE20180785

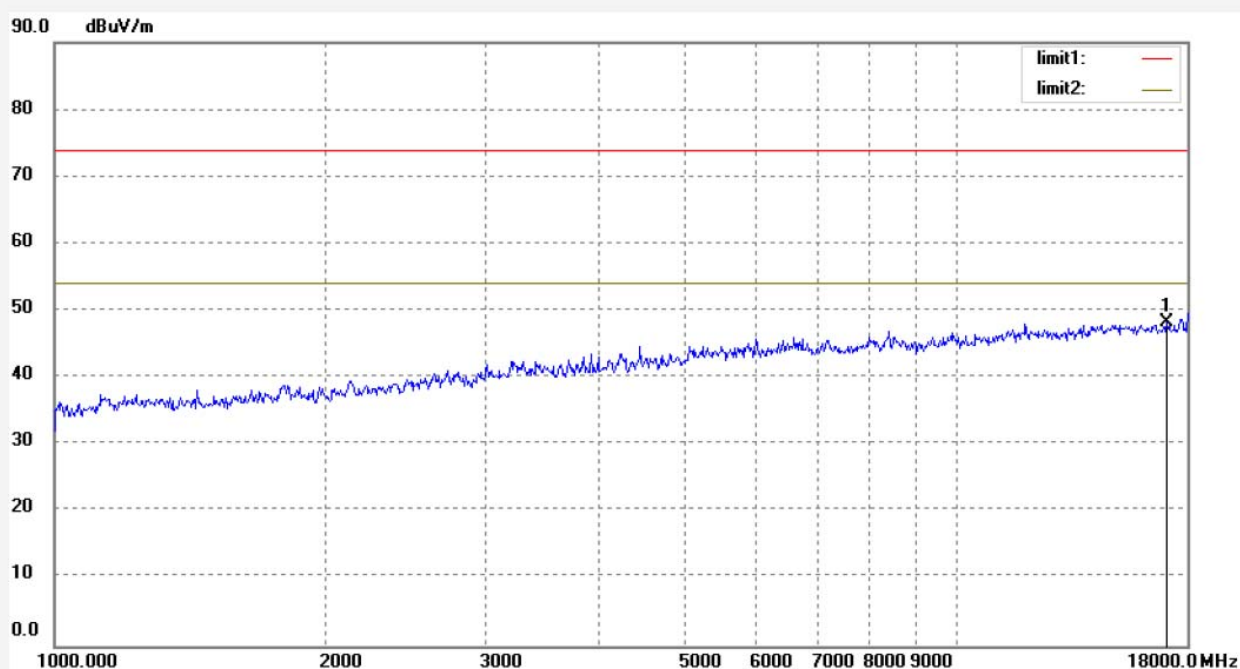

No.	Freq. (MHz)	Reading (dBuV/m)	Factor (dB)	Result (dBuV/m)	Limit (dBuV/m)	Margin (dB)	Detector	Height (cm)	Degree (deg.)	Remark
1	17087.464	-13.13	61.30	48.17	74.00	-25.83	peak	150	182	

Job No.: CLN65 XHUA #37  
 Standard: FCC PK  
 Test item: Radiation Test  
 Temp.( C)/Hum.(%) 23 C / 48 %  
 EUT: UP-Android 7 module  
 Mode: TX 2462MHz (802.11N)  
 Model: UPA000AN  
 Manufacturer: CTOUCH Europe B.V.

Polarization: Horizontal  
 Power Source: DC 12V  
 Date: 18/06/25/  
 Time: 12/05/17  
 Engineer Signature: WADE  
 Distance: 3m

Note: Report NO.:ATE20180785

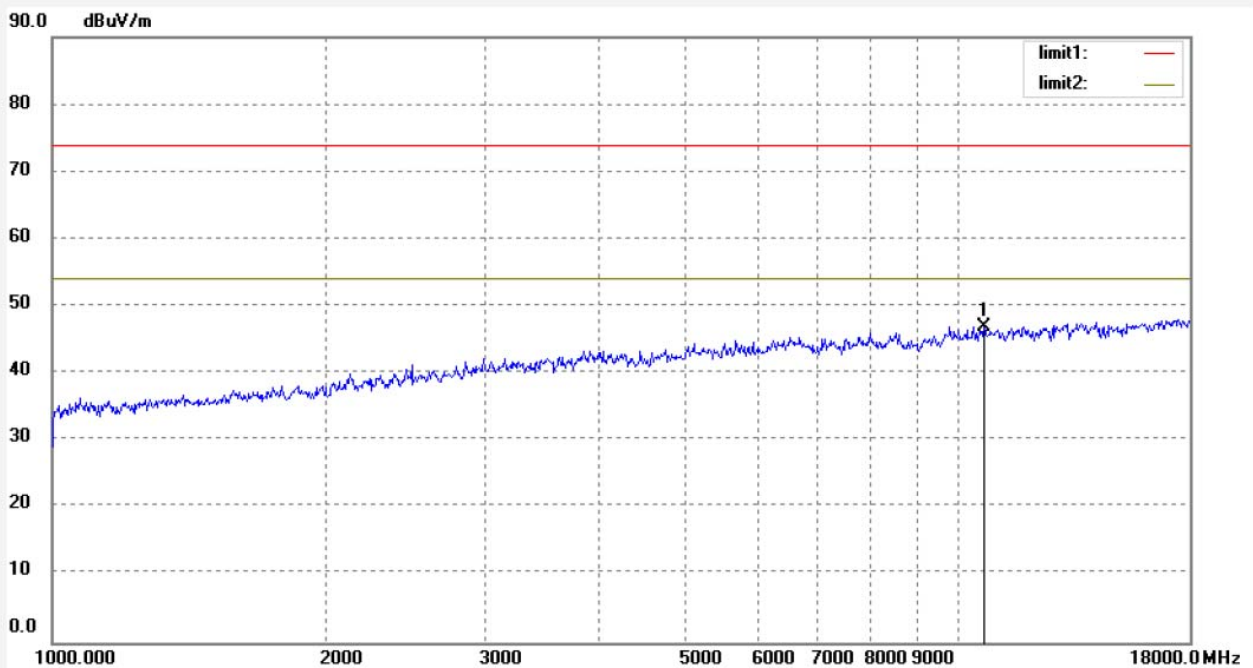

No.	Freq. (MHz)	Reading (dBuV/m)	Factor (dB)	Result (dBuV/m)	Limit (dBuV/m)	Margin (dB)	Detector	Height (cm)	Degree (deg.)	Remark
1	10667.636	-3.34	50.25	46.91	74.00	-27.09	peak	150	178	



**ACCURATE TECHNOLOGY CO., LTD.**

F1,Bldg,A,Changyuan New Material Port Keyuan Rd,  
Science & Industry Park,Nanshan Shenzhen,P.R.China

Site: 2# Chamber  
Tel:+86-0755-26503290  
Fax:+86-0755-26503396

Job No.: CLN65 XHUA #36  
Standard: FCC PK  
Test item: Radiation Test  
Temp.( C)/Hum.(%) 23 C / 48 %  
EUT: UP-Android 7 module  
Mode: TX 2462MHz (802.11N)  
Model: UPA000AN  
Manufacturer: CTOUCH Europe B.V.

Polarization: Vertical  
Power Source: DC 12V  
Date: 18/06/25/  
Time: 12/03/59  
Engineer Signature: WADE  
Distance: 3m

Note: Report NO.:ATE20180785

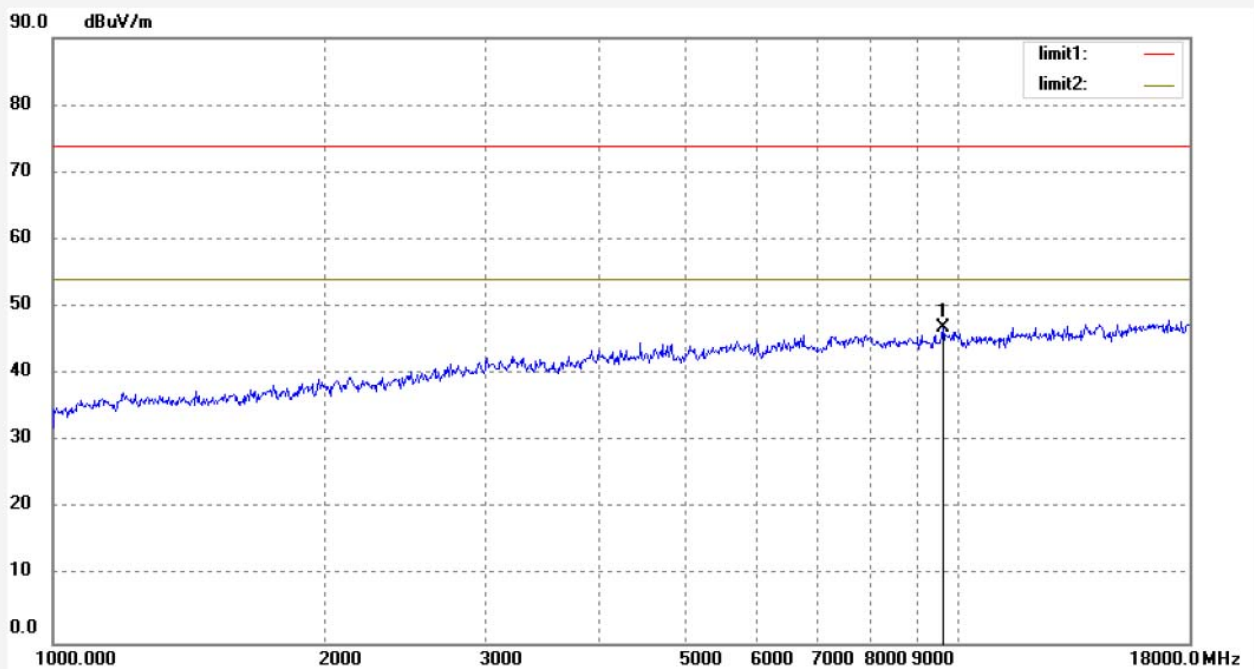

No.	Freq. (MHz)	Reading (dBuV/m)	Factor (dB)	Result (dBuV/m)	Limit (dBuV/m)	Margin (dB)	Detector	Height (cm)	Degree (deg.)	Remark
1	9613.430	-4.07	51.04	46.97	74.00	-27.03	peak	150	191	

## 11. BAND EDGE COMPLIANCE TEST

### 11.1. Block Diagram of Test Setup



### 11.2. The Requirement For Section 15.247(d)

Section 15.247(d): In any 100 kHz bandwidth outside the frequency band in which the spread spectrum or digitally modulated intentional radiator is operating, the radio frequency power that is produced by the intentional radiator shall be at least 20 dB below that in the 100 kHz bandwidth within the band that contains the highest level of the desired power, based on either an RF conducted or a radiated measurement, provided the transmitter demonstrates compliance with the peak conducted power limits. If the transmitter complies with the conducted power limits based on the use of RMS averaging over a time interval, as permitted under paragraph (b)(3) of this section, the attenuation required under this paragraph shall be 30 dB instead of 20 dB. Attenuation below the general limits specified in Section 15.209(a) is not required. In addition, radiated emissions which fall in the restricted bands, as defined in Section 15.205(a), must also comply with the radiated emission limits specified in Section 15.209(a).

### 11.3. EUT Configuration on Measurement

The equipment are installed on the emission Measurement to meet the commission requirements and operating regulations in a manner which tends to maximize its emission characteristics in normal application.

### 11.4. Operating Condition of EUT

11.4.1. Setup the EUT and simulator as shown as Section 11.1.

11.4.2. Turn on the power of all equipment.

11.4.3. Let the EUT work in TX modes measure it. The transmit frequency are 2412-2462MHz. We select 2412MHz and 2462MHz TX frequency to transmit.

### 11.5. Test Procedure

#### Conducted Band Edge:

11.5.1. The transmitter output was connected to the spectrum analyzer via a low loss cable.

11.5.2. Set RBW of spectrum analyzer to 100kHz and VBW to 300kHz.

#### Radiate Band Edge:

11.5.3. The EUT is placed on a turntable, which is 1.5m above the ground plane and worked at highest radiated power.

11.5.4. The turntable was rotated for 360 degrees to determine the position of maximum emission level.

11.5.5. EUT is set 3m away from the receiving antenna, which is varied from 1m to 4m to find out the highest emission.

11.5.6. Set the spectrum analyzer in the following setting in order to capture the lower and upper band-edges of the emission:

11.5.7. RBW=1MHz, VBW=1MHz

11.5.8. The band edges was measured and recorded.

### 11.6. Test Result

The test was performed with 802.11b			
Frequency (MHz)	Result of Band Edge ANT 1(dBc)	Result of Band Edge ANT 2 (dBc)	Limit of Band Edge (dBc)
2400	43.70	43.92	> 20dBc
2483.5	43.49	44.76	> 20dBc

The test was performed with 802.11g			
Frequency (MHz)	Result of Band Edge ANT 1(dBc)	Result of Band Edge ANT 2 (dBc)	Limit of Band Edge (dBc)
2400	36.97	37.47	> 20dBc
2483.5	38.10	41.00	> 20dBc

The test was performed with 802.11n (20MHz)			
Frequency (MHz)	Result of Band Edge ANT 1(dBc)	Result of Band Edge ANT 2 (dBc)	Limit of Band Edge (dBc)
2400	37.47	36.76	> 20dBc
2483.5	40.03	40.03	> 20dBc



ANT 1(802.11b)

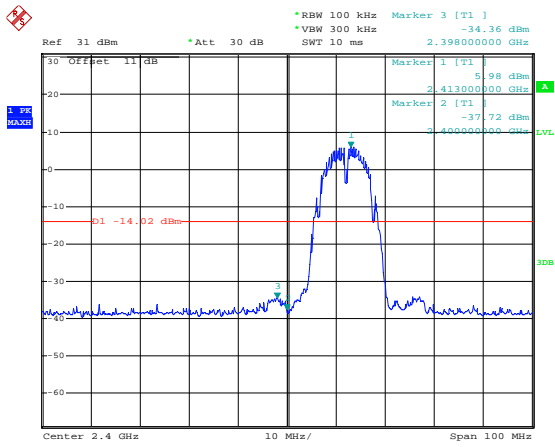

Date: 7.JUN.2018 15:27:17

ANT 2(802.11b)

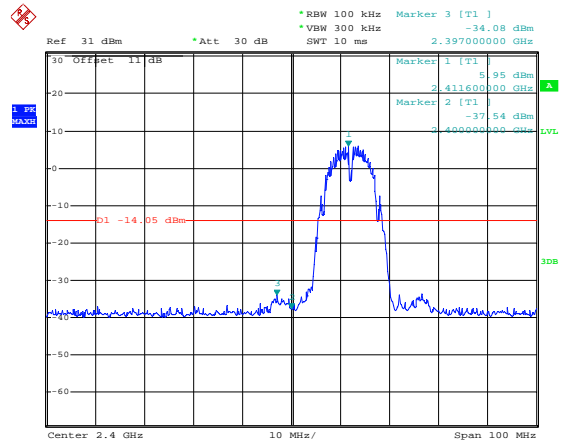

Date: 7.JUN.2018 15:28:36

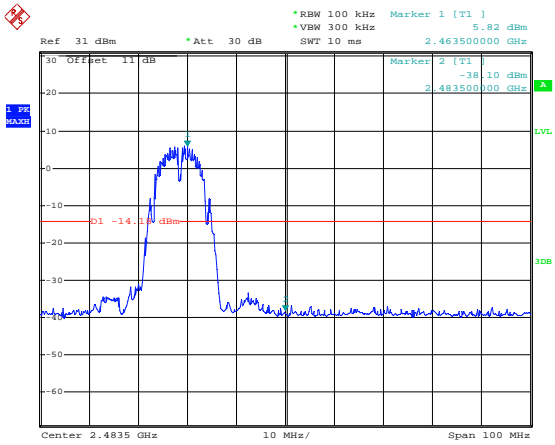

Date: 7.JUN.2018 15:41:07

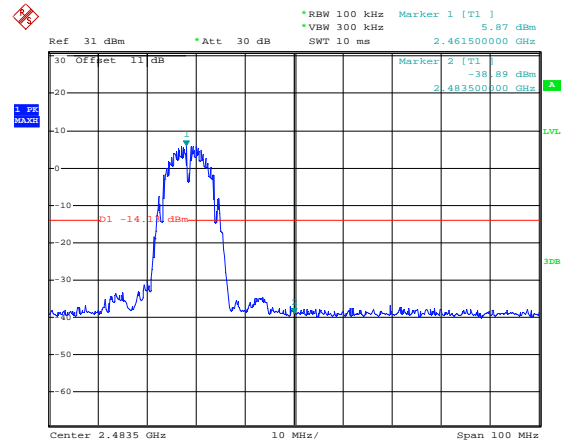

Date: 7.JUN.2018 15:40:06

## ANT 1(802.11g)

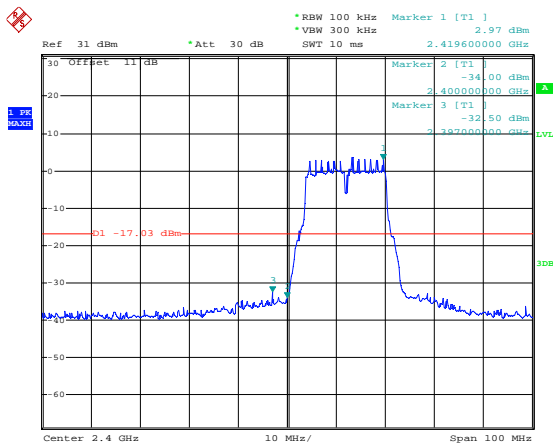

Date: 7.JUN.2018 15:29:52

## ANT 2(802.11g)

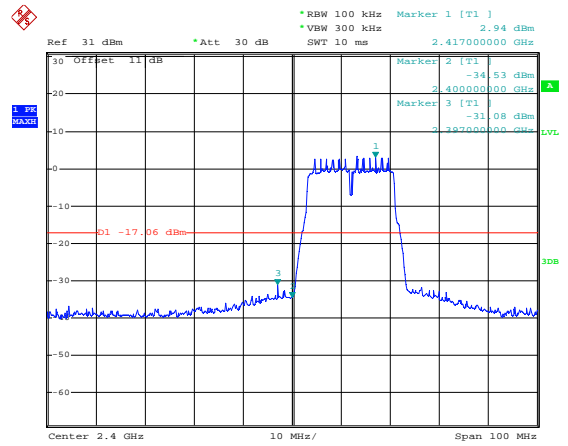

Date: 7.JUN.2018 15:32:44

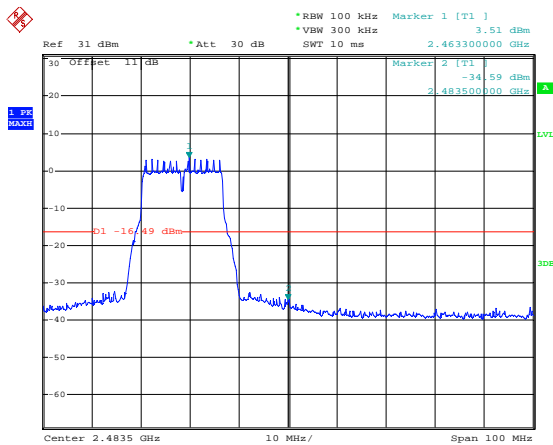

Date: 7.JUN.2018 15:38:12

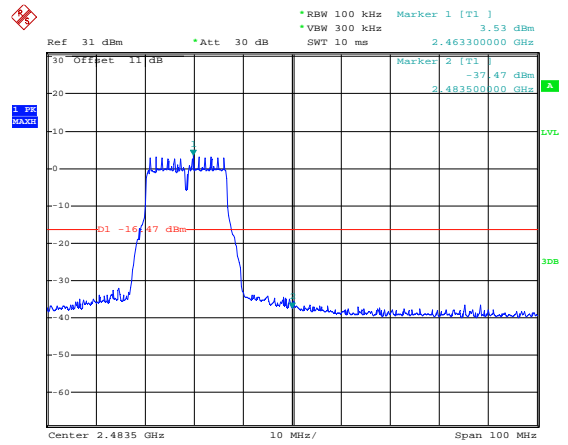

Date: 7.JUN.2018 15:39:01

## ANT 1(802.11n20)

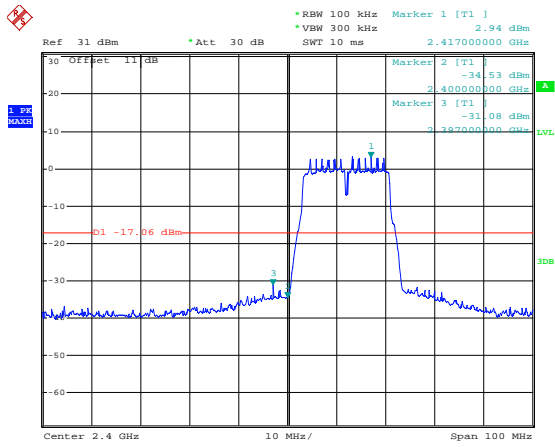

Date: 7.JUN.2018 15:32:44

## ANT 2(802.11 n20)

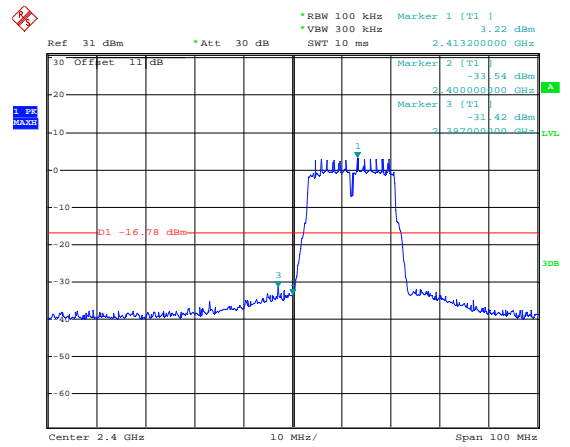

Date: 7.JUN.2018 15:33:54

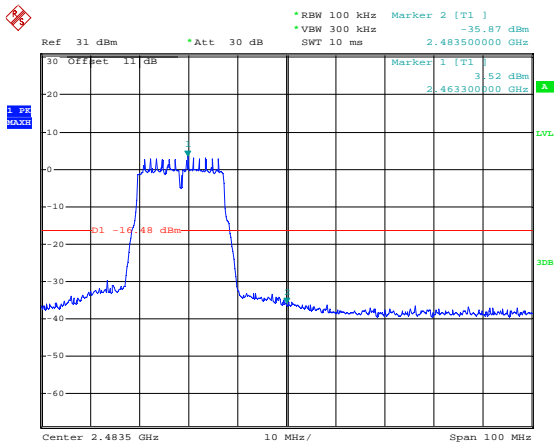

Date: 5.JUN.2018 16:14:51

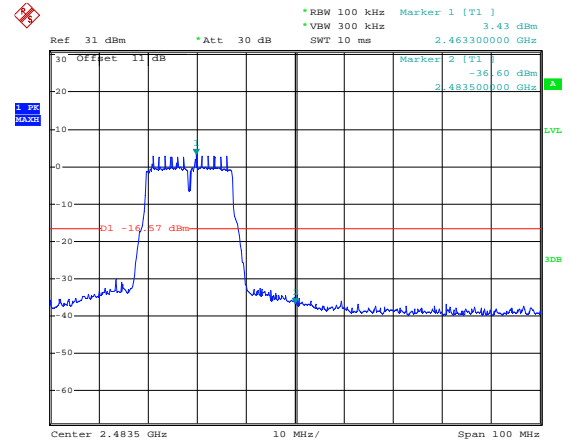

Date: 7.JUN.2018 15:36:28

## Radiated Band Edge Result

Note:

1. Emissions attenuated more than 20 dB below the permissible value are not reported.
2. The field strength is calculated by adding the antenna factor, high pass filter loss(if used) and cable loss, and subtracting the amplifier gain(if any)from the measured reading. The basic equation calculation is as follows:  
$$\text{Result} = \text{Reading} + \text{Corrected Factor}$$
3. Display the measurement of peak values.
4. The EUT is tested radiation emission at each test mode (802.11b/g/n) in three axes. Besides, We have tested the single antenna transmit mode and the dual antenna emission mode. The worst emissions are reflected in the following plots.
5. The average measurement was not performed when peak measured data under the limit of average detection.

Job No.: FRANK2018 #192	Polarization: Horizontal
Standard: FCC PK	Power Source: DC 12V
Test item: Radiation Test	Date: 18/06/27/
Temp.( C)/Hum.(%) 25 C / 55 %	Time: 15/57/44
EUT: UP-Android 7 module	Engineer Signature:
Mode: TX Channel 1(802.11B)	Distance: 3m
Model: UPA000AN	
Manufacturer: CTOUCH Europe B.V.	

Note: Report NO.:ATE20180785

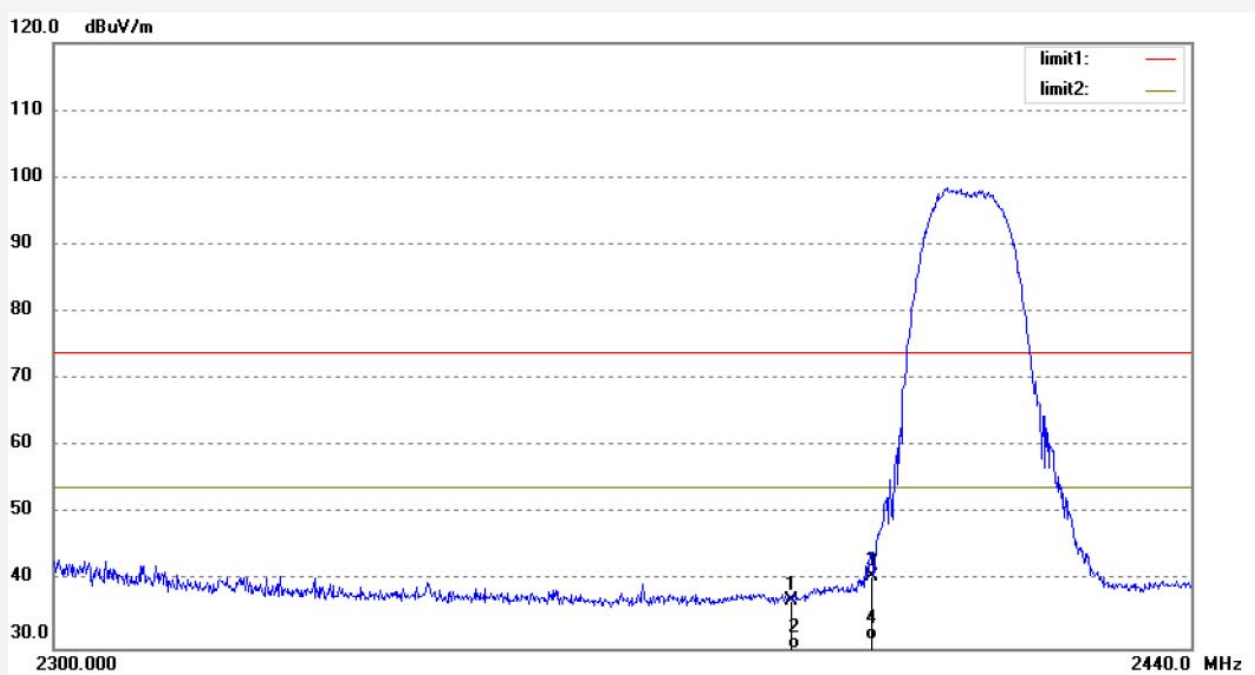

No.	Freq. (MHz)	Reading (dBuV/m)	Factor (dB)	Result (dBuV/m)	Limit (dBuV/m)	Margin (dB)	Detector	Height (cm)	Degree (deg.)	Remark
1	2390.000	41.50	-4.32	37.18	74.00	-36.82	peak	250	128	
2	2390.000	32.35	-4.32	28.03	54.00	-25.97	AVG	250	132	
3	2400.000	44.93	-4.27	40.66	74.00	-33.34	peak	250	109	
4	2400.000	35.46	-4.27	31.19	54.00	-22.81	AVG	250	84	

Job No.: FRANK2018 #193

Standard: FCC PK

Test item: Radiation Test

Temp.( C)/Hum.(%) 25 C / 55 %

EUT: UP-Android 7 module

Mode: TX Channel 1(802.11B)

Model: UPA000AN

Manufacturer: CTOUCH Europe B.V.

Polarization: Vertical

Power Source: DC 12V

Date: 18/06/27/

Time: 15/58/35

Engineer Signature:

Distance: 3m

Note: Report NO.:ATE20180785

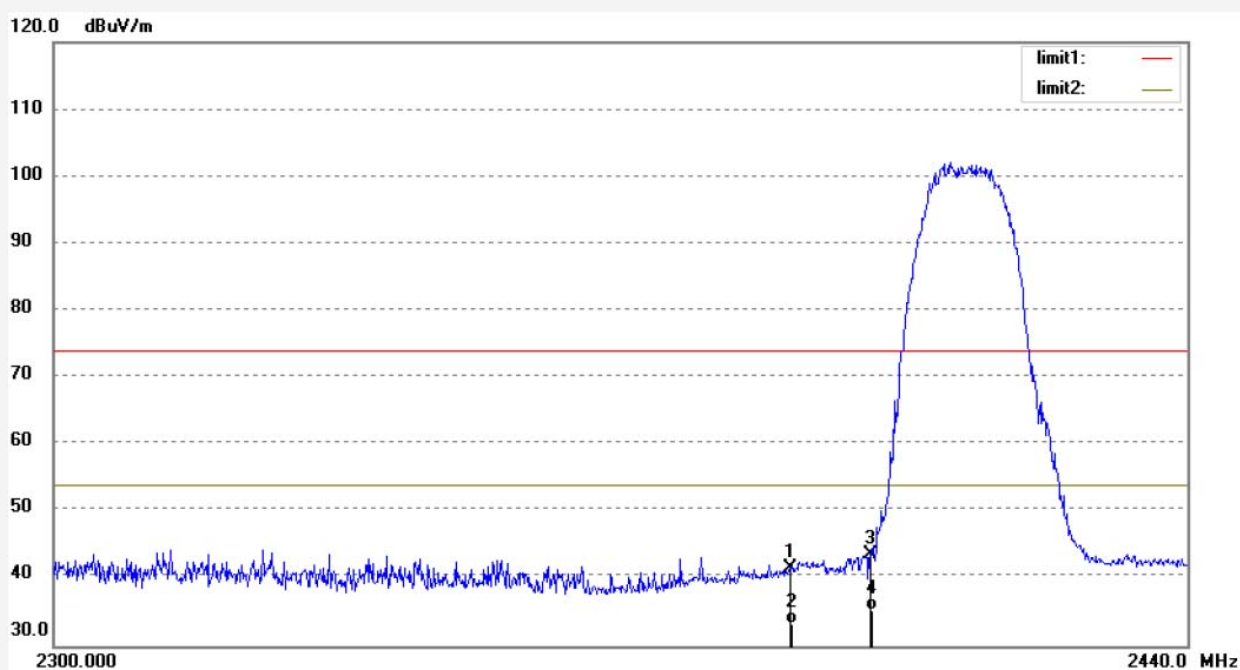

No.	Freq. (MHz)	Reading (dBuV/m)	Factor (dB)	Result (dBuV/m)	Limit (dBuV/m)	Margin (dB)	Detector	Height (cm)	Degree (deg.)	Remark
1	2390.000	45.87	-4.32	41.55	74.00	-32.45	peak	250	195	
2	2390.000	37.64	-4.32	33.32	54.00	-20.68	AVG	200	121	
3	2400.000	47.90	-4.27	43.63	74.00	-30.37	peak	200	230	
4	2400.000	39.45	-4.27	35.18	54.00	-18.82	AVG	200	187	

Job No.: FRANK2018 #207  
 Standard: FCC PK  
 Test item: Radiation Test  
 Temp.( C)/Hum.(%) 25 C / 55 %  
 EUT: UP-Android 7 module  
 Mode: TX Channel 11(802.11B)  
 Model: UPA000AN  
 Manufacturer: CTOUCH Europe B.V.

Polarization: Horizontal  
 Power Source: DC 12V  
 Date: 18/06/27/  
 Time: 16/18/49  
 Engineer Signature:  
 Distance: 3m

Note: Report NO.:ATE20180785

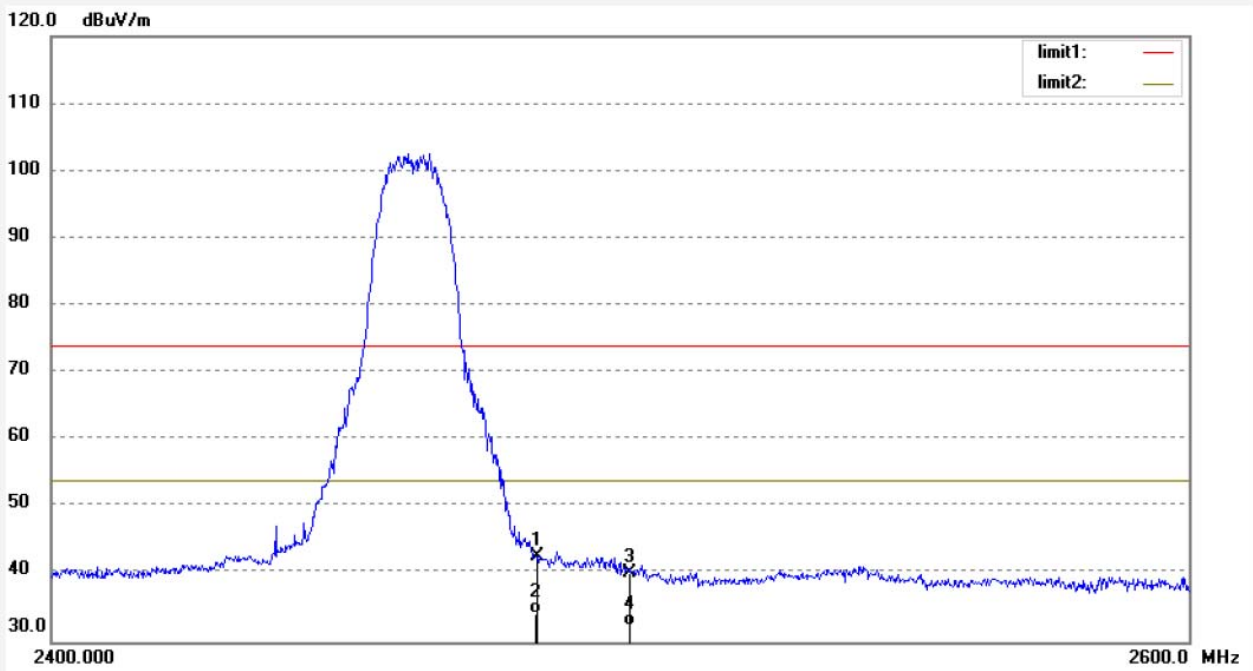

No.	Freq. (MHz)	Reading (dBuV/m)	Factor (dB)	Result (dBuV/m)	Limit (dBuV/m)	Margin (dB)	Detector	Height (cm)	Degree (deg.)	Remark
1	2483.500	46.52	-3.89	42.63	74.00	-31.37	peak	300	199	
2	2483.500	38.16	-3.89	34.27	54.00	-19.73	AVG	250	264	
3	2500.000	44.07	-3.81	40.26	74.00	-33.74	peak	250	162	
4	2500.000	36.20	-3.81	32.39	54.00	-21.61	AVG	250	102	

Job No.: FRANK2018 #206

Standard: FCC PK

Test item: Radiation Test

Temp.( C)/Hum.(%) 25 C / 55 %

EUT: UP-Android 7 module

Mode: TX Channel 11(802.11B)

Model: UPA000AN

Manufacturer: CTOUCH Europe B.V.

Polarization: Vertical

Power Source: DC 12V

Date: 18/06/27/

Time: 16/18/07

Engineer Signature:

Distance: 3m

Note: Report NO.:ATE20180785

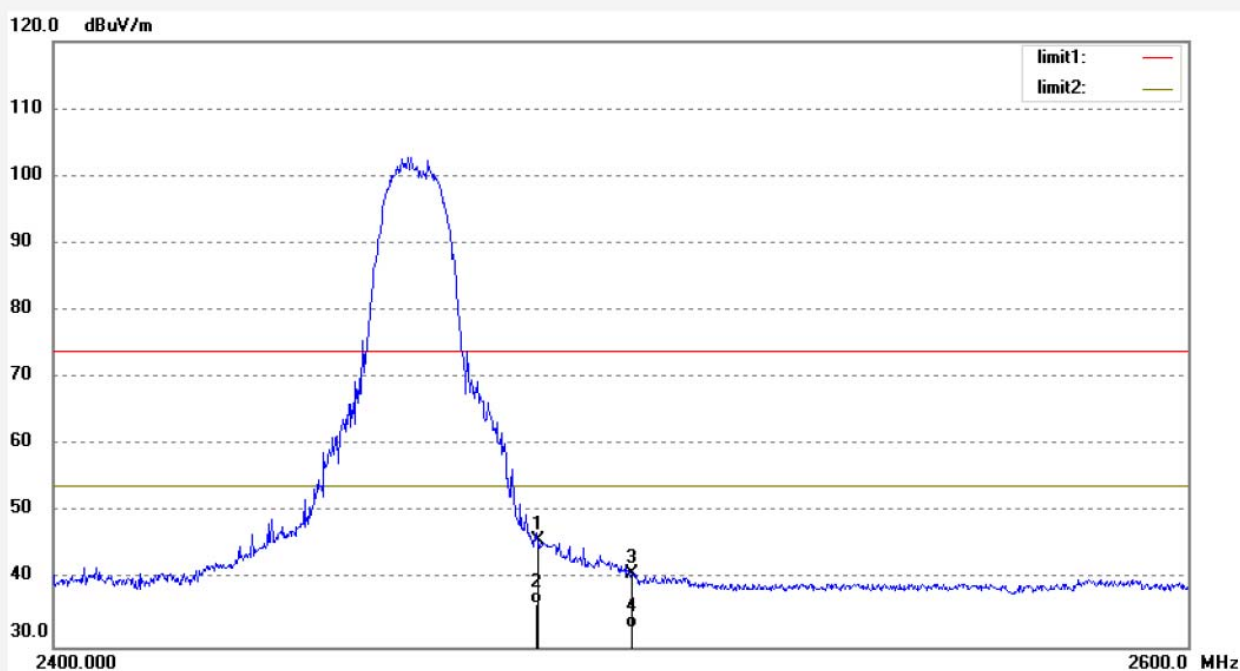

No.	Freq. (MHz)	Reading (dBuV/m)	Factor (dB)	Result (dBuV/m)	Limit (dBuV/m)	Margin (dB)	Detector	Height (cm)	Degree (deg.)	Remark
1	2483.500	49.71	-3.89	45.82	74.00	-28.18	peak	250	163	
2	2483.500	40.26	-3.89	36.37	54.00	-17.63	AVG	150	25	
3	2500.000	44.68	-3.81	40.87	74.00	-33.13	peak	250	232	
4	2500.000	36.69	-3.81	32.88	54.00	-21.12	AVG	150	196	



Job No.: FRANK2018 #195  
 Standard: FCC PK  
 Test item: Radiation Test  
 Temp.( C)/Hum.(%) 25 C / 55 %  
 EUT: UP-Android 7 module  
 Mode: TX Channel 1(802.11G)  
 Model: UPA000AN  
 Manufacturer: CTOUCH Europe B.V.

Polarization: Horizontal  
 Power Source: DC 12V  
 Date: 18/06/27/  
 Time: 16/00/42  
 Engineer Signature:  
 Distance: 3m

Note: Report NO.:ATE20180785

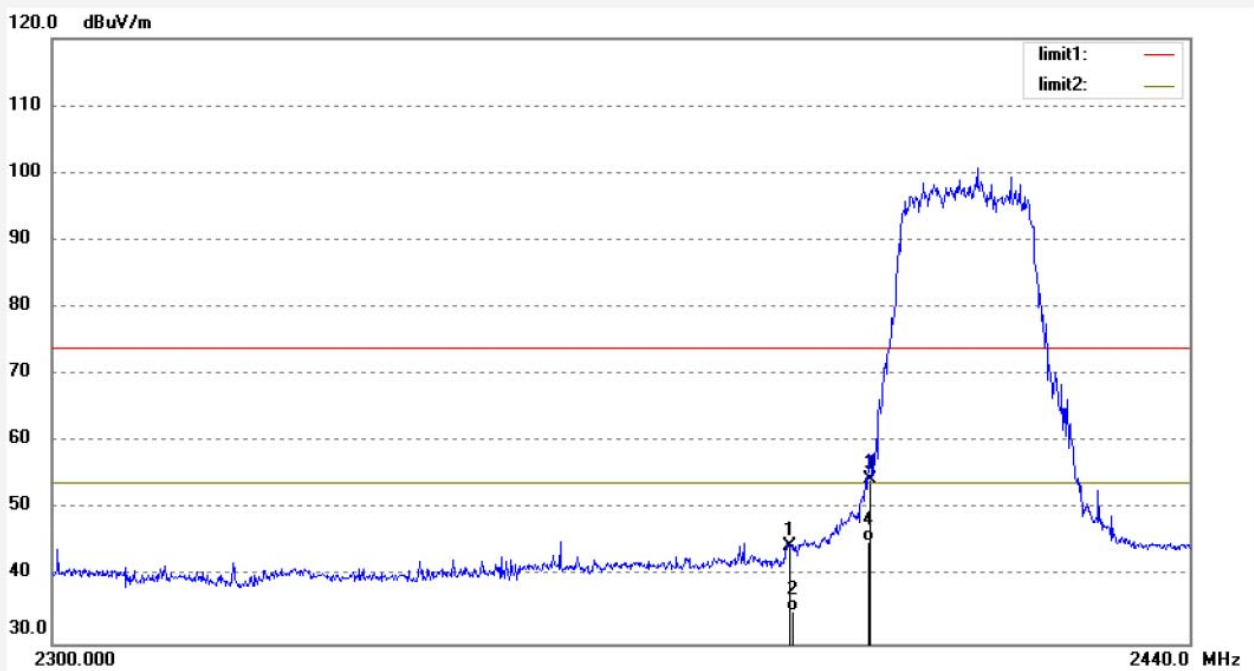

No.	Freq. (MHz)	Reading (dBuV/m)	Factor (dB)	Result (dBuV/m)	Limit (dBuV/m)	Margin (dB)	Detector	Height (cm)	Degree (deg.)	Remark
1	2390.000	48.81	-4.32	44.49	74.00	-29.51	peak	250	130	
2	2390.000	39.16	-4.32	34.84	54.00	-19.16	AVG	250	210	
3	2400.000	58.70	-4.27	54.43	74.00	-19.57	peak	250	95	
4	2400.000	49.56	-4.27	45.29	54.00	-8.71	AVG	250	64	

Job No.: FRANK2018 #194

Standard: FCC PK

Test item: Radiation Test

Temp.( C)/Hum.(%) 25 C / 55 %

EUT: UP-Android 7 module

Mode: TX Channel 1(802.11G)

Model: UPA000AN

Manufacturer: CTOUCH Europe B.V.

Polarization: Vertical

Power Source: DC 12V

Date: 18/06/27/

Time: 15/59/57

Engineer Signature:

Distance: 3m

Note: Report NO.:ATE20180785

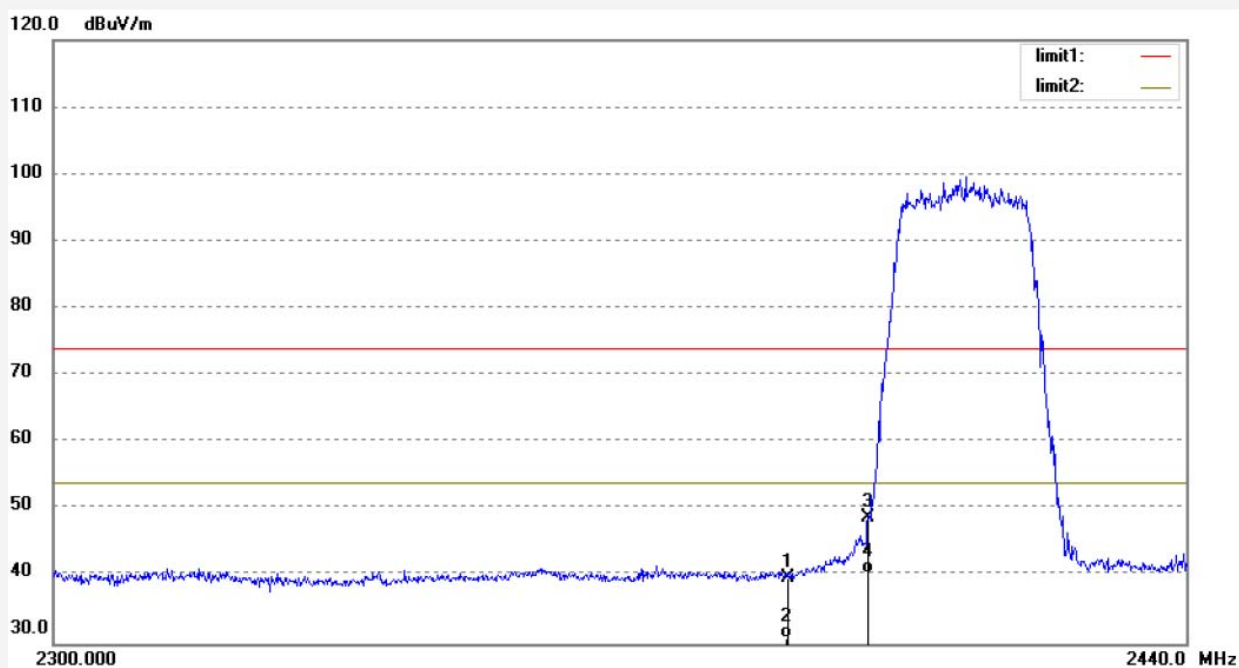

No.	Freq. (MHz)	Reading (dBuV/m)	Factor (dB)	Result (dBuV/m)	Limit (dBuV/m)	Margin (dB)	Detector	Height (cm)	Degree (deg.)	Remark
1	2390.000	44.12	-4.32	39.80	74.00	-34.20	peak	250	149	
2	2390.000	35.15	-4.32	30.83	54.00	-23.17	AVG	200	126	
3	2400.000	53.11	-4.27	48.84	74.00	-25.16	peak	250	94	
4	2400.000	44.64	-4.27	40.37	54.00	-13.63	AVG	250	50	

Job No.: FRANK2018 #204	Polarization: Horizontal
Standard: FCC PK	Power Source: DC 12V
Test item: Radiation Test	Date: 18/06/27/
Temp.( C)/Hum.(%) 25 C / 55 %	Time: 16/16/16
EUT: UP-Android 7 module	Engineer Signature:
Mode: TX Channel 11(802.11G)	Distance: 3m
Model: UPA000AN	
Manufacturer: CTOUCH Europe B.V.	

Note: Report NO.:ATE20180785

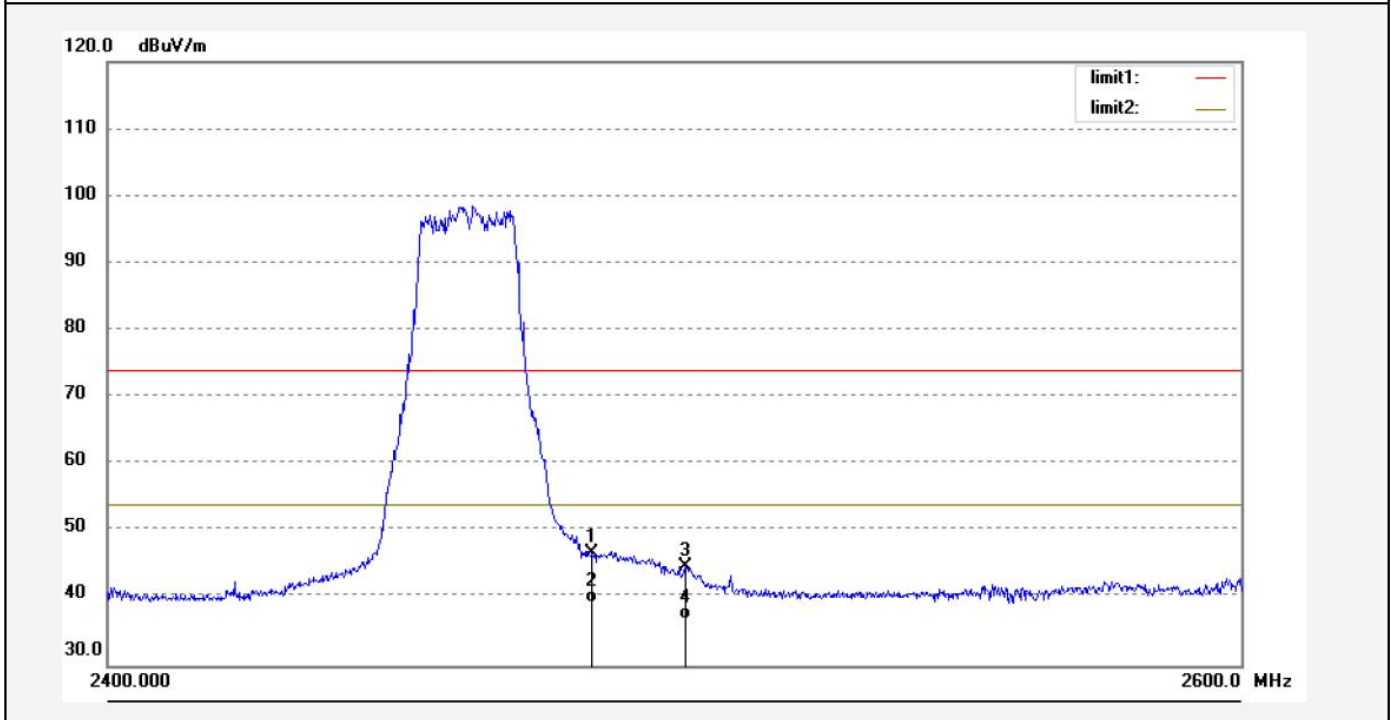

No.	Freq. (MHz)	Reading (dBuV/m)	Factor (dB)	Result (dBuV/m)	Limit (dBuV/m)	Margin (dB)	Detector	Height (cm)	Degree (deg.)	Remark
1	2483.500	50.73	-3.89	46.84	74.00	-27.16	peak	250	199	
2	2483.500	43.19	-3.89	39.30	54.00	-14.70	AVG	250	114	
3	2500.000	48.44	-3.81	44.63	74.00	-29.37	peak	250	62	
4	2500.000	40.69	-3.81	36.88	54.00	-17.12	AVG	250	160	



**ACCURATE TECHNOLOGY CO., LTD.**

F1,Bldg,A,Changyuan New Material Port Keyuan Rd,  
Science & Industry Park,Nanshan Shenzhen,P.R.China

Site: 1# Chamber

Tel:+86-0755-26503290

Fax:+86-0755-26503396

Job No.: FRANK2018 #205	Polarization: Vertical
Standard: FCC PK	Power Source: DC 12V
Test item: Radiation Test	Date: 18/06/27/
Temp.( C)/Hum.(%) 25 C / 55 %	Time: 16/17/05
EUT: UP-Android 7 module	Engineer Signature:
Mode: TX Channel 11(802.11G)	Distance: 3m
Model: UPA000AN	
Manufacturer: CTOUCH Europe B.V.	

Note: Report NO.:ATE20180785

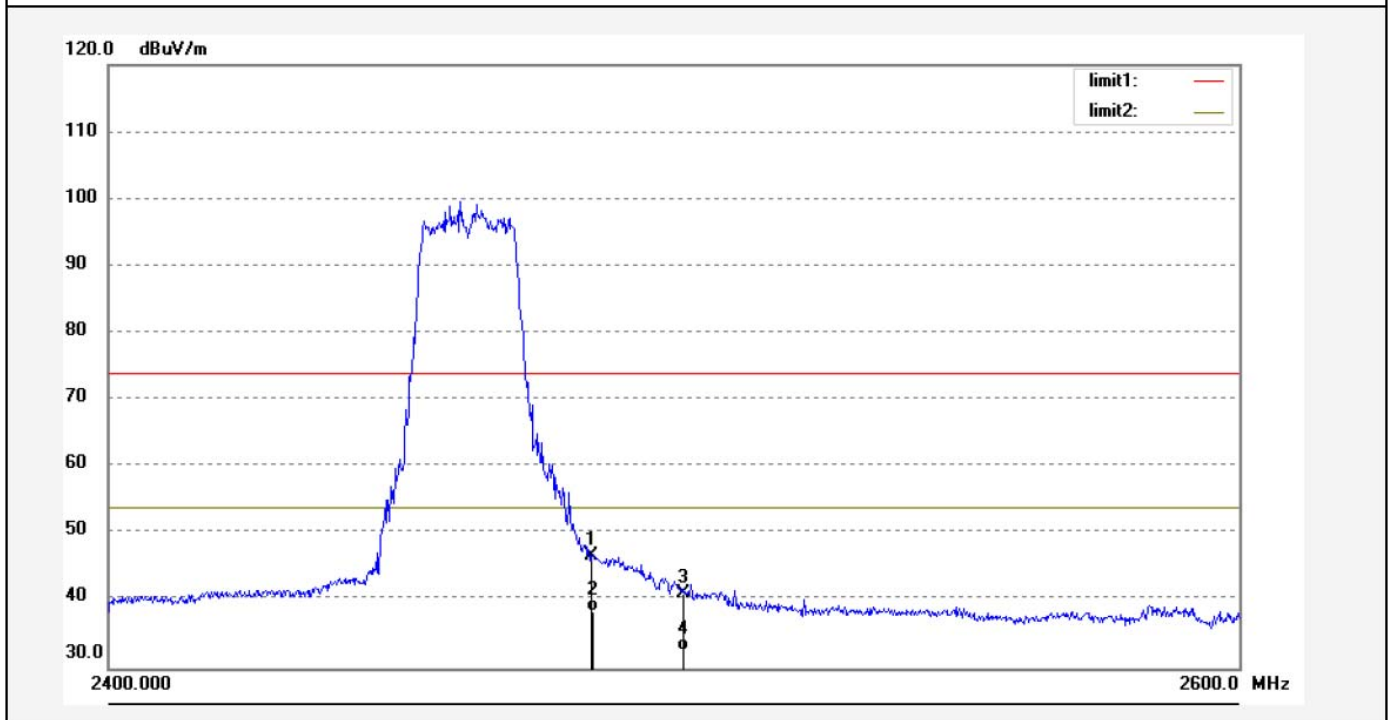

No.	Freq. (MHz)	Reading (dBuV/m)	Factor (dB)	Result (dBuV/m)	Limit (dBuV/m)	Margin (dB)	Detector	Height (cm)	Degree (deg.)	Remark
1	2483.500	50.61	-3.89	46.72	74.00	-27.28	peak	200	123	
2	2483.500	42.44	-3.89	38.55	54.00	-15.45	AVG	150	29	
3	2500.000	44.95	-3.81	41.14	74.00	-32.86	peak	250	61	
4	2500.000	36.49	-3.81	32.68	54.00	-21.32	AVG	150	160	

Job No.: FRANK2018 #196

Standard: FCC PK

Test item: Radiation Test

Temp.( C)/Hum.(%) 25 C / 55 %

EUT: UP-Android 7 module

Mode: TX Channel 1(802.11N20)

Model: UPA000AN

Manufacturer: CTOUCH Europe B.V.

Polarization: Horizontal

Power Source: DC 12V

Date: 18/06/27/

Time: 16/02/35

Engineer Signature:

Distance: 3m

Note: Report NO.:ATE20180785

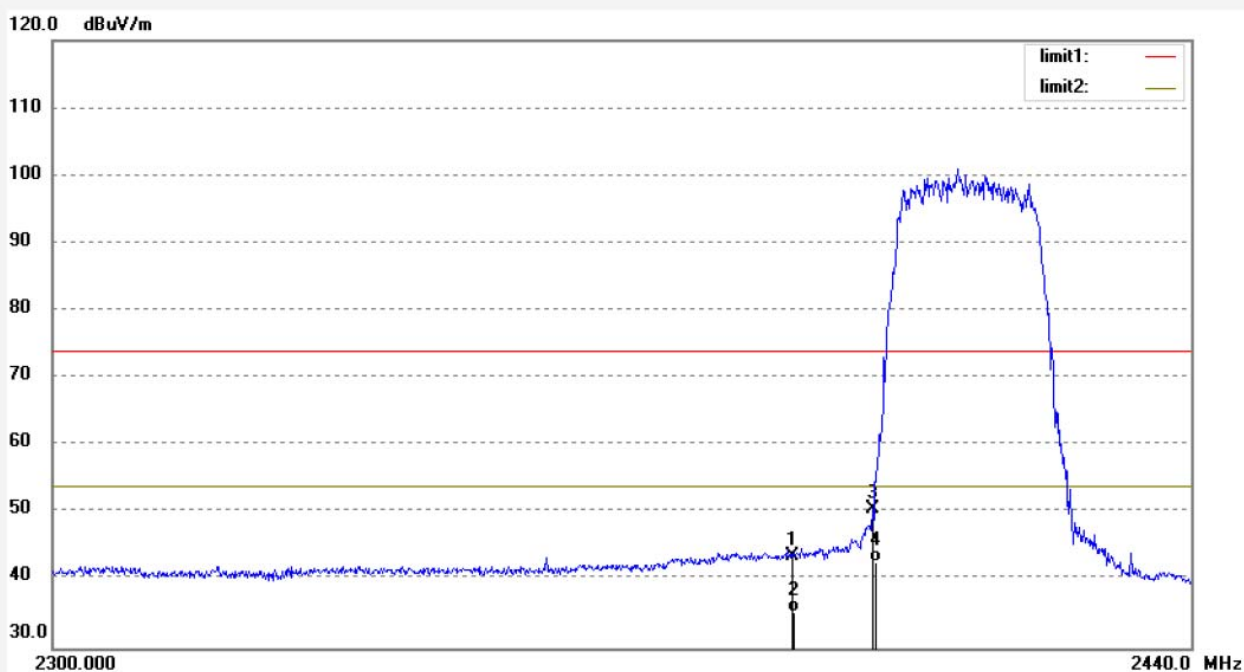

No.	Freq. (MHz)	Reading (dBuV/m)	Factor (dB)	Result (dBuV/m)	Limit (dBuV/m)	Margin (dB)	Detector	Height (cm)	Degree (deg.)	Remark
1	2390.000	47.94	-4.32	43.62	74.00	-30.38	peak	250	193	
2	2390.000	39.50	-4.32	35.18	54.00	-18.82	AVG	250	97	
3	2400.000	54.86	-4.27	50.59	74.00	-23.41	peak	250	13	
4	2400.000	46.98	-4.27	42.71	54.00	-11.29	AVG	250	125	

Job No.: FRANK2018 #197

Standard: FCC PK

Test item: Radiation Test

Temp.( C)/Hum.(%) 25 C / 55 %

EUT: UP-Android 7 module

Mode: TX Channel 1(802.11N20)

Model: UPA000AN

Manufacturer: CTOUCH Europe B.V.

Polarization: Vertical

Power Source: DC 12V

Date: 18/06/27/

Time: 16/03/57

Engineer Signature:

Distance: 3m

Note: Report NO.:ATE20180785

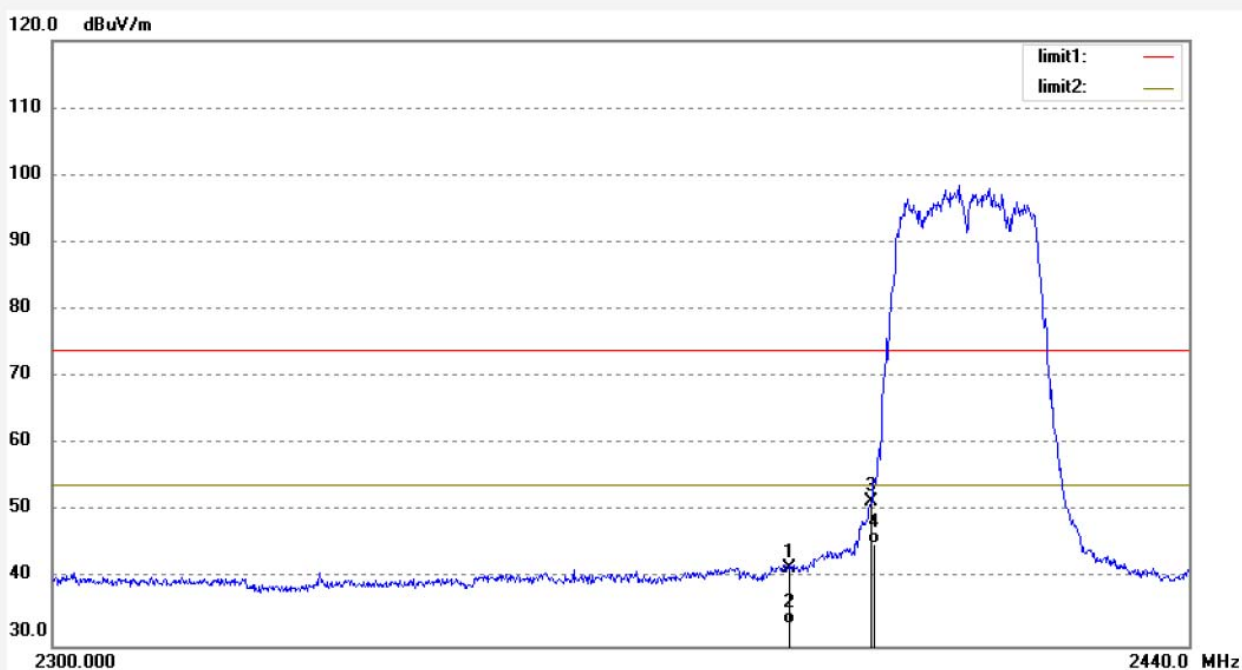

No.	Freq. (MHz)	Reading (dBuV/m)	Factor (dB)	Result (dBuV/m)	Limit (dBuV/m)	Margin (dB)	Detector	Height (cm)	Degree (deg.)	Remark
1	2390.000	45.91	-4.32	41.59	74.00	-32.41	peak	250	89	
2	2390.000	37.61	-4.32	33.29	54.00	-20.71	AVG	150	215	
3	2400.000	55.79	-4.27	51.52	74.00	-22.48	peak	300	197	
4	2400.000	49.46	-4.27	45.19	54.00	-8.81	AVG	150	51	

Job No.: FRANK2018 #203

Standard: FCC PK

Test item: Radiation Test

Temp.( C)/Hum.(%) 25 C / 55 %

EUT: UP-Android 7 module

Mode: TX Channel 11(802.11N20)

Model: UPA000AN

Manufacturer: CTOUCH Europe B.V.

Polarization: Horizontal

Power Source: DC 12V

Date: 18/06/27/

Time: 16/15/20

Engineer Signature:

Distance: 3m

Note: Report NO.:ATE20180785

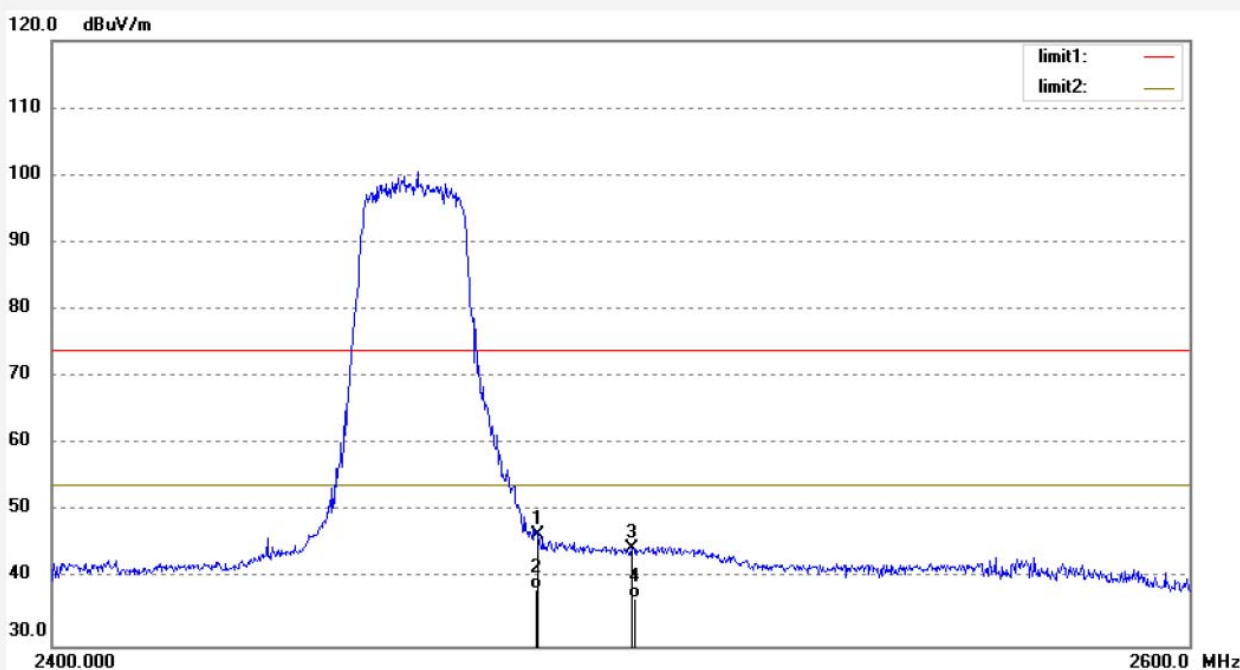

No.	Freq. (MHz)	Reading (dBuV/m)	Factor (dB)	Result (dBuV/m)	Limit (dBuV/m)	Margin (dB)	Detector	Height (cm)	Degree (deg.)	Remark
1	2483.500	50.53	-3.89	46.64	74.00	-27.36	peak	250	169	
2	2483.500	42.35	-3.89	38.46	54.00	-15.54	AVG	250	154	
3	2500.000	48.26	-3.81	44.45	74.00	-29.55	peak	250	45	
4	2500.000	40.91	-3.81	37.10	54.00	-16.90	AVG	250	135	

Job No.: FRANK2018 #202

Standard: FCC PK

Test item: Radiation Test

Temp.( C)/Hum.(%) 25 C / 55 %

EUT: UP-Android 7 module

Mode: TX Channel 11(802.11N20)

Model: UPA000AN

Manufacturer: CTOUCH Europe B.V.

Polarization: Vertical

Power Source: DC 12V

Date: 18/06/27/

Time: 16/13/27

Engineer Signature:

Distance: 3m

Note: Report NO.:ATE20180785

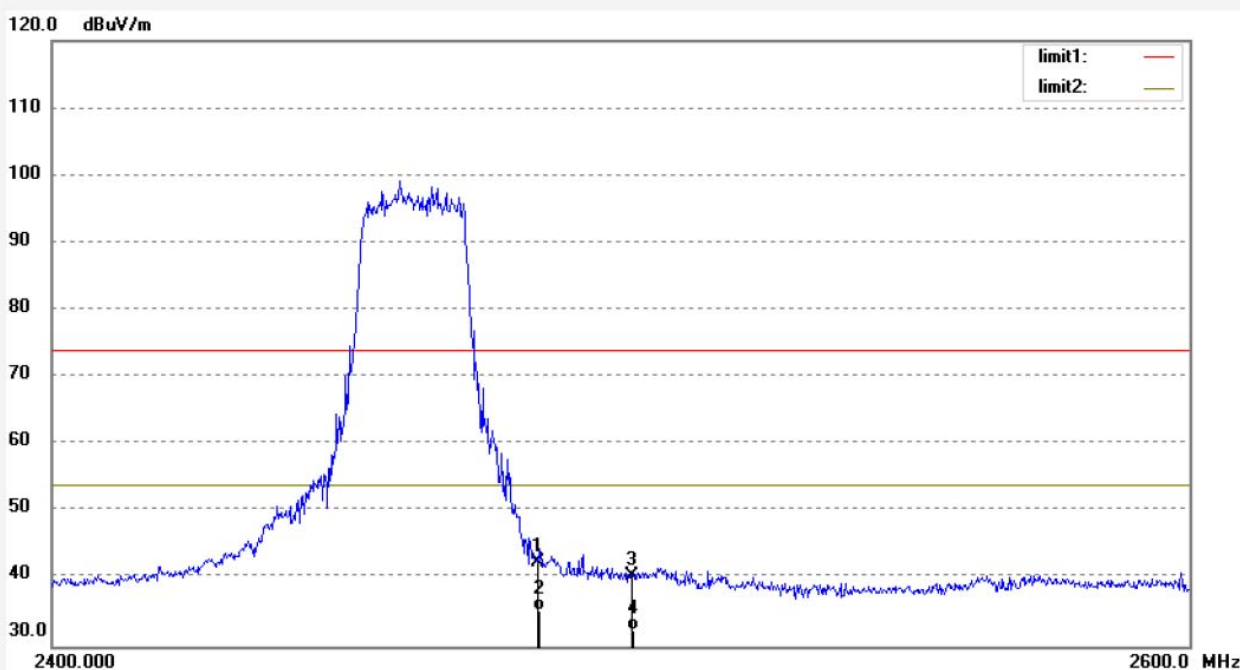

No.	Freq. (MHz)	Reading (dBuV/m)	Factor (dB)	Result (dBuV/m)	Limit (dBuV/m)	Margin (dB)	Detector	Height (cm)	Degree (deg.)	Remark
1	2483.500	46.47	-3.89	42.58	74.00	-31.42	peak	250	193	
2	2483.500	39.16	-3.89	35.27	54.00	-18.73	AVG	150	102	
3	2500.000	44.37	-3.81	40.56	74.00	-33.44	peak	200	79	
4	2500.000	36.20	-3.81	32.39	54.00	-21.61	AVG	150	260	



## 12.ANTENNA REQUIREMENT

### 12.1.The Requirement

According to Section 15.203, an intentional radiator shall be designed to ensure that no antenna other than that furnished by the responsible party shall be used with the device.

### 12.2.Antenna Construction

The module must contain a permanently attached antenna, or contain a unique antenna connector, and be marketed and operated only with specific antenna(s), per Sections 15.203, 15.204(b), 15.204(c), 15.212(a), 2.929(b); The Antenna gain of EUT is 2dBi. Therefore, the equipment complies with the antenna requirement.

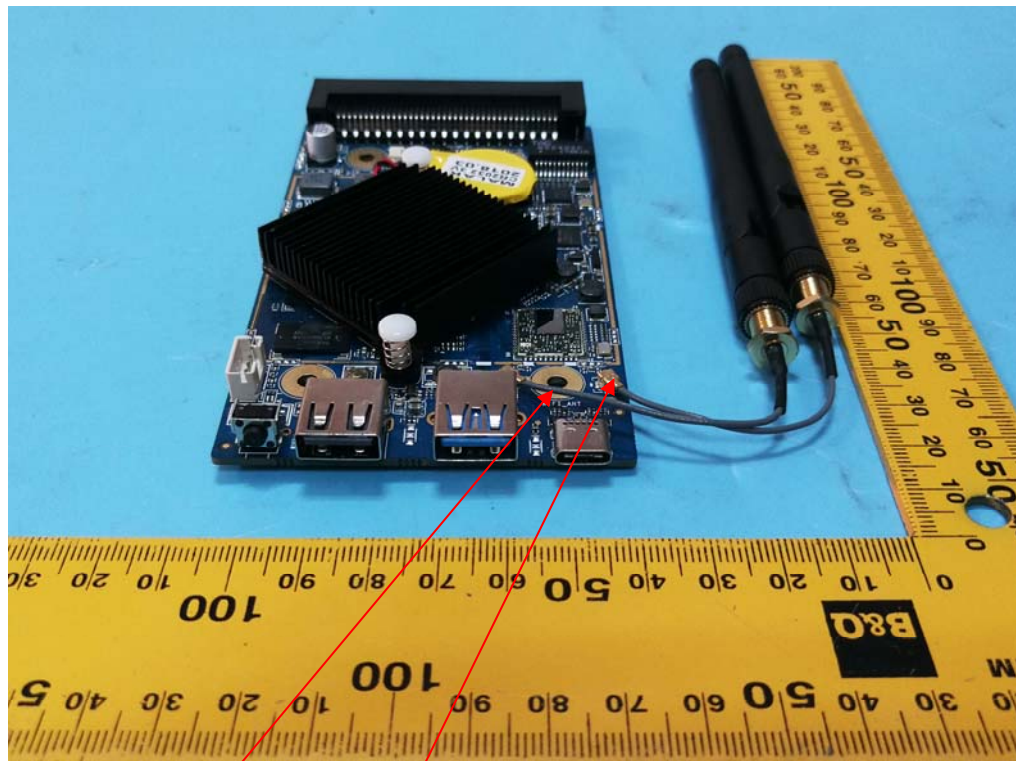

Antenna 1

Antenna 2