

APPLICATION CERTIFICATION FCC Part 15C

On Behalf of
CTOUCH Europe B.V.

UP-Android 7 module

Model No.: UPA000AN

FCC ID: 2APQQ-UPA000AN

Prepared for : CTOUCH Europe B.V.
Address : Achtseweg Zuid 153R, 5651 GW Eindhoven, The Netherlands

Prepared by : Shenzhen Accurate Technology Co., Ltd.
Address : 1/F., Building A, Changyuan New Material Port, Science & Industry Park, Nanshan District, Shenzhen, Guangdong, P.R. China.

Tel: (0755) 26503290
Fax: (0755) 26503396

Report No. : ATE20180783
Date of Test : June 01, 2018-June 28, 2018
Date of Report : June 29, 2018

TABLE OF CONTENTS

Description	Page
Test Report Certification	
1. GENERAL INFORMATION	5
1.1. Description of Device (EUT).....	5
1.2. Carrier Frequency of Channels	6
1.3. Special Accessory and Auxiliary Equipment	6
1.4. Description of Test Facility	7
1.5. Measurement Uncertainty	7
2. MEASURING DEVICE AND TEST EQUIPMENT	8
3. OPERATION OF EUT DURING TESTING	9
3.1. Operating Mode	9
3.2. Configuration and peripherals	9
4. TEST PROCEDURES AND RESULTS	10
5. 6DB BANDWIDTH MEASUREMENT	11
5.1. Block Diagram of Test Setup.....	11
5.2. The Requirement For Section 15.247(a)(2).....	11
5.3. EUT Configuration on Measurement	11
5.4. Operating Condition of EUT	11
5.5. Test Procedure	11
5.6. Test Result	12
6. MAXIMUM PEAK OUTPUT POWER	14
6.1. Block Diagram of Test Setup.....	14
6.2. The Requirement For Section 15.247(b)(3).....	14
6.3. EUT Configuration on Measurement	14
6.4. Operating Condition of EUT	14
6.5. Test Procedure	14
6.6. Test Result	15
7. POWER SPECTRAL DENSITY MEASUREMENT	17
7.1. Block Diagram of Test Setup.....	17
7.2. The Requirement For Section 15.247(e).....	17
7.3. EUT Configuration on Measurement	17
7.4. Operating Condition of EUT	17
7.5. Test Procedure	18
7.6. Test Result	19
8. BAND EDGE COMPLIANCE TEST	21
8.1. Block Diagram of Test Setup.....	21
8.2. The Requirement For Section 15.247(d)	21
8.3. EUT Configuration on Measurement	21
8.4. Operating Condition of EUT	21
8.5. Test Procedure	22
8.6. Test Result	22
9. RADIATED SPURIOUS EMISSION TEST	28
9.1. Block Diagram of Test Setup.....	28
9.2. The Limit For Section 15.247(d)	30
9.3. Restricted bands of operation	30
9.4. Configuration of EUT on Measurement	31

- 9.5. Operating Condition of EUT31
- 9.6. Test Procedure31
- 9.7. Data Sample.....32
- 9.8. The Field Strength of Radiation Emission Measurement Results32
- 10. ANTENNA REQUIREMENT.....45**
- 10.1. The Requirement45
- 10.2. Antenna Construction45

Test Report Certification

Applicant : CTOUCH Europe B.V.
Address : Achtseweg Zuid 153R, 5651 GW Eindhoven, The Netherlands
Manufacturer : CTOUCH Europe B.V.
Address : Achtseweg Zuid 153R, 5651 GW Eindhoven, The Netherlands
Product : UP-Android 7 module
Model No. : UPA000AN
Trade name : CTOUCH

Measurement Procedure Used:

FCC Rules and Regulations Part 15 Subpart C Section 15.247 ANSI C63.10: 2013

The EUT was tested according to DTS test procedure of Apr 05, 2017 KDB558074 D01 DTS Meas Guidance v04 for compliance to FCC 47CFR 15.247 requirements

The device described above is tested by SHENZHEN ACCURATE TECHNOLOGY CO. LTD to determine the maximum emission levels emanating from the device. The maximum emission levels are compared to the FCC Part 15 Subpart C Section 15.247 limits. The measurement results are contained in this test report and SHENZHEN ACCURATE TECHNOLOGY CO. LTD is assumed full responsibility for the accuracy and completeness of these measurements. Also, this report shows that the Equipment Under Test (EUT) is to be technically compliant with the FCC requirements.

This report applies to above tested sample only. This report shall not be reproduced in part without written approval of SHENZHEN ACCURATE TECHNOLOGY CO. LTD.

Date of Test : June 01, 2018-June 28, 2018

Date of Report: June 29, 2018

Prepared by :

(Tim Zhang, Engineer)

Approved & Authorized Signer :

(Sean Liu, Manager)

1. GENERAL INFORMATION

1.1. Description of Device (EUT)

EUT	:	UP-Android 7 module
Model Number	:	UPA000AN
Bluetooth version	:	BT V4.0 Dual Mode This report is for BT V4.0 LE mode
Frequency Range	:	2402MHz-2480MHz
Number of Channels	:	40
Antenna Gain	:	2dBi
Antenna type	:	External Antenna
Power Supply	:	DC 12~19V
Modulation mode	:	GFSK
Applicant	:	CTOUCH Europe B.V.
Address	:	Achtseweg Zuid 153R, 5651 GW Eindhoven, The Netherlands
Manufacturer	:	CTOUCH Europe B.V.
Address	:	Achtseweg Zuid 153R, 5651 GW Eindhoven, The Netherlands
Date of sample received	:	May 11, 2018
Date of Test	:	June 01, 2018-June 28, 2018

1.2.Carrier Frequency of Channels

Channel	Frequency (MHz)	Channel	Frequency (MHz)	Channel	Frequency (MHz)	Channel	Frequency (MHz)
0	2402	10	2422	20	2442	30	2462
1	2404	11	2424	21	2444	31	2464
2	2406	12	2426	22	2446	32	2466
3	2408	13	2428	23	2448	33	2468
4	2410	14	2430	24	2450	34	2470
5	2412	15	2432	25	2452	35	2472
6	2414	16	2434	26	2454	36	2474
7	2416	17	2436	27	2456	37	2476
8	2418	18	2438	28	2458	38	2478
9	2420	19	2440	29	2460	39	2480

1.3.Special Accessory and Auxiliary Equipment

PC

Manufacturer: LENOVO

M/N: 4290-RT8

S/N: R9-FW93G 11/08

Adapter

Manufacturer: N/A

INPUT: 100-240V 50/60Hz

OUTPUT: DC 12V 5A

1.4. Description of Test Facility

EMC Lab	:	Recognition of accreditation by Federal Communications Commission (FCC) The Designation Number is CN1189 The Registration Number is 708358
		Listed by Innovation, Science and Economic Development Canada (ISED) The Registration Number is 5077A-2
		Accredited by China National Accreditation Service for Conformity Assessment (CNAS) The Registration Number is CNAS L3193
		Accredited by American Association for Laboratory Accreditation (A2LA) The Certificate Number is 4297.01
Name of Firm	:	Shenzhen Accurate Technology Co., Ltd.
Site Location	:	1/F., Building A, Changyuan New Material Port, Science & Industry Park, Nanshan District, Shenzhen, Guangdong, P.R. China

1.5. Measurement Uncertainty

Conducted Emission Expanded Uncertainty	=	2.23dB, k=2
Radiated emission expanded uncertainty (9kHz-30MHz)	=	3.08dB, k=2
Radiated emission expanded uncertainty (30MHz-1000MHz)	=	4.42dB, k=2
Radiated emission expanded uncertainty (Above 1GHz)	=	4.06dB, k=2

2. MEASURING DEVICE AND TEST EQUIPMENT

Table 1: List of Test and Measurement Equipment

Kind of equipment	Manufacturer	Type	S/N	Calibrated dates	Calibrated until
EMI Test Receiver	Rohde&Schwarz	ESCS30	100307	Jan. 06, 2018	Jan. 05, 2019
EMI Test Receiver	Rohde&Schwarz	ESPI3	101526/003	Jan. 06, 2018	Jan. 05, 2019
Spectrum Analyzer	Rohde&Schwarz	FSV-40	101495	Jan. 06, 2018	Jan. 05, 2019
Spectrum Analyzer	Agilent	E7405A	MY45115511	Jan. 06, 2018	Jan. 05, 2019
Pre-Amplifier	Rohde&Schwarz	CBLU118354 0-01	3791	Jan. 06, 2018	Jan. 05, 2019
Loop Antenna	Schwarzbeck	FMZB1516	1516131	Jan. 06, 2018	Jan. 05, 2019
Bilog Antenna	Schwarzbeck	VULB9163	9163-323	Jan. 06, 2018	Jan. 05, 2019
Horn Antenna	Schwarzbeck	BBHA9120D	9120D-655	Jan. 06, 2018	Jan. 05, 2019
Horn Antenna	Schwarzbeck	BBHA9170	9170-359	Jan. 06, 2018	Jan. 05, 2019
Open Switch and Control Unit	Rohde&Schwarz	OSP120 + OSP-B157	101244 + 100866	Jan. 06, 2018	Jan. 05, 2019
LISN	Rohde&Schwarz	ESH3-Z5	100305	Jan. 06, 2018	Jan. 05, 2019
LISN	Schwarzbeck	NSLK8126	8126431	Jan. 06, 2018	Jan. 05, 2019
Highpass Filter	Wainwright Instruments	WHKX3.6/18 G-10SS	N/A	Jan. 06, 2018	Jan. 05, 2019
Band Reject Filter	Wainwright Instruments	WRCG2400/2 485-2375/2510 -60/11SS	N/A	Jan. 06, 2018	Jan. 05, 2019

3. OPERATION OF EUT DURING TESTING

3.1. Operating Mode

The mode is used: **BLE Transmitting mode**

Low Channel: 2402MHz

Middle Channel: 2440MHz

High Channel: 2480MHz

3.2. Configuration and peripherals

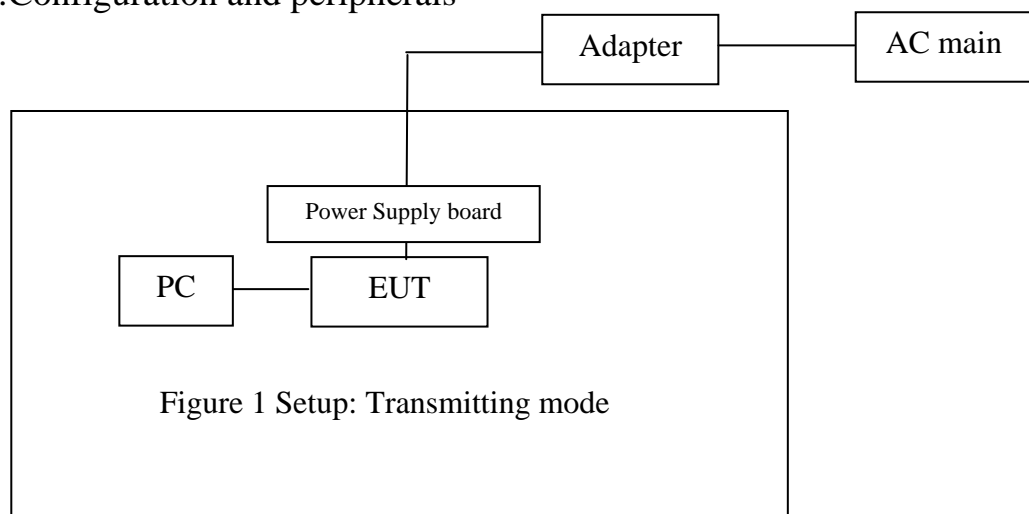

(EUT: UP-Android 7 module)

4. TEST PROCEDURES AND RESULTS

FCC Rules	Description of Test	Result
Section 15.247(a)(2)	6dB Bandwidth Test	Compliant
Section 15.247(e)	Power Spectral Density Test	Compliant
Section 15.247(b)(3)	Maximum Peak Output Power Test	Compliant
Section 15.247(d)	Band Edge Compliance Test	Compliant
Section 15.247(d) Section 15.209	Radiated Spurious Emission Test	Compliant
Section 15.247(d)	Conducted Spurious Emission Test	Compliant
Section 15.207	AC Power Line Conducted Emission Test	N/A
Section 15.203	Antenna Requirement	Compliant

Note: The power supply mode of the EUT is DC 12-19V, According to the FCC standard requirements, conducted emission is not applicable.

5. 6DB BANDWIDTH MEASUREMENT

5.1. Block Diagram of Test Setup



(EUT: UP-Android 7 module)

5.2. The Requirement For Section 15.247(a)(2)

Section 15.247(a)(2): Systems using digital modulation techniques may operate in the 902-928MHz, 2400-2483.5MHz, and 5725-5850MHz bands. The minimum 6 dB bandwidth shall be at least 500 kHz.

5.3. EUT Configuration on Measurement

The equipment is installed on the emission measurement to meet the commission requirements and operating regulations in a manner which tends to maximize its emission characteristics in normal application.

5.4. Operating Condition of EUT

5.4.1. Setup the EUT and simulator as shown as Section 5.1.

5.4.2. Turn on the power of all equipment.

5.4.3. Let the EUT work in TX modes measure it. The transmit frequency are 2402-2480MHz. We select 2402MHz, 2440MHz, and 2480MHz TX frequency to transmit.

5.5. Test Procedure

5.5.1. The transmitter output was connected to the spectrum analyzer through a low loss cable.

5.5.2. Set RBW of spectrum analyzer to 100 kHz and VBW to 300 kHz.

5.5.3. The 6dB bandwidth is defined as the total spectrum the power of which is higher than peak power minus 6dB.

5.6.Test Result

Channel	Frequency (MHz)	6 dB Bandwidth (MHz)	Minimum Limit(MHz)	PASS/FAIL
0	2402	0.720	0.5	PASS
19	2440	0.720	0.5	PASS
39	2480	0.720	0.5	PASS

The spectrum analyzer plots are attached as below.

channel 0

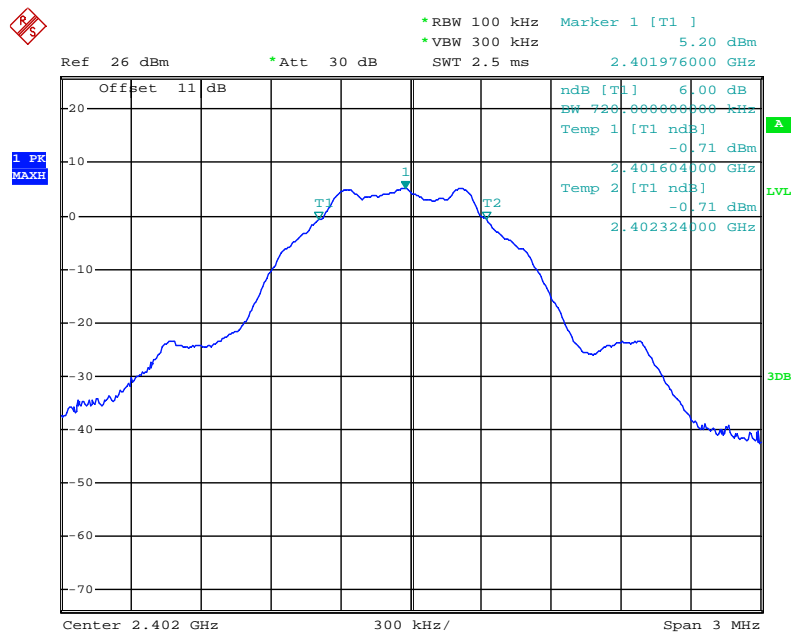

Date: 11.JUN.2018 15:19:47

channel 19

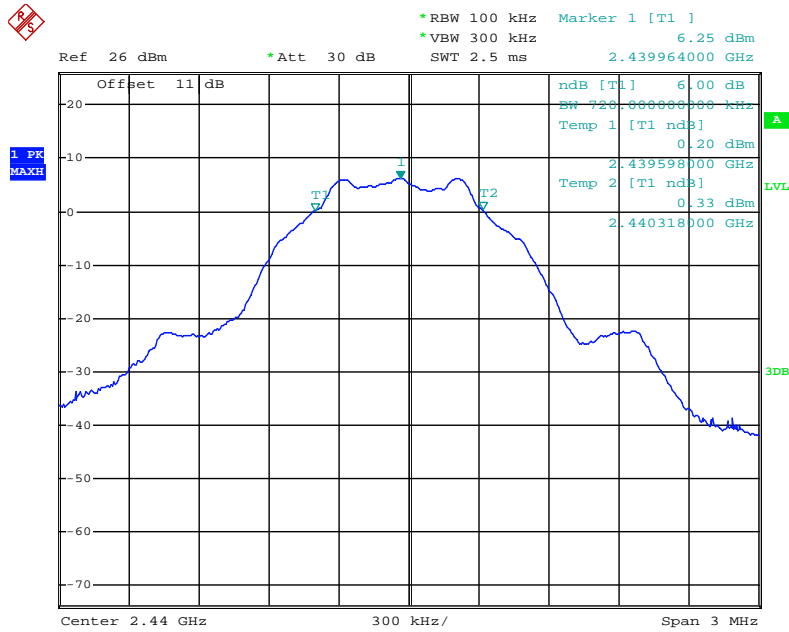

Date: 11.JUN.2018 15:21:16

channel 39

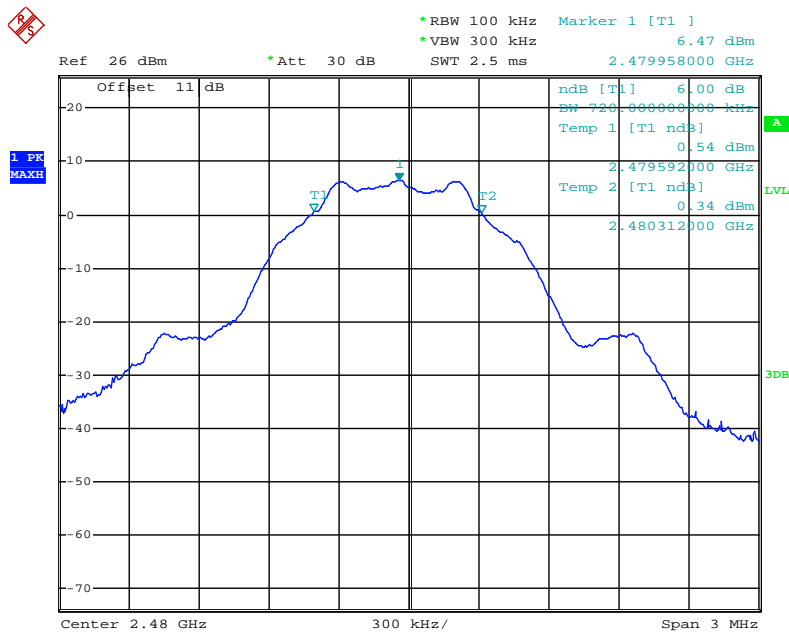

Date: 11.JUN.2018 15:21:53

6. MAXIMUM PEAK OUTPUT POWER

6.1. Block Diagram of Test Setup



(EUT: UP-Android 7 module)

6.2. The Requirement For Section 15.247(b)(3)

Section 15.247(b)(3): For systems using digital modulation in the 902-928MHz, 2400-2483.5MHz, and 5725-5850MHz bands: 1 Watt.

6.3. EUT Configuration on Measurement

The equipment are installed on the emission Measurement to meet the commission requirements and operating regulations in a manner which tends to maximize its emission characteristics in normal application.

6.4. Operating Condition of EUT

6.4.1. Setup the EUT and simulator as shown as Section 6.1.

6.4.2. Turn on the power of all equipment.

6.4.3. Let the EUT work in TX modes measure it. The transmit frequency are 2402-2480MHz. We select 2402MHz, 2440MHz, and 2480MHz TX frequency to transmit.

6.5. Test Procedure

6.5.1. The transmitter output was connected to the spectrum analyzer through a low loss cable.

6.5.2. Set RBW of spectrum analyzer to 1 MHz and VBW to 3 MHz.

6.5.3. Measurement the maximum peak output power.

6.6. Test Result

Channel	Frequency (MHz)	Peak Power Output (dBm)	Peak Power Limit (dBm)	Pass / Fail
0	2402	5.92	30	PASS
19	2440	6.93	30	PASS
39	2480	6.94	30	PASS

The spectrum analyzer plots are attached as below.

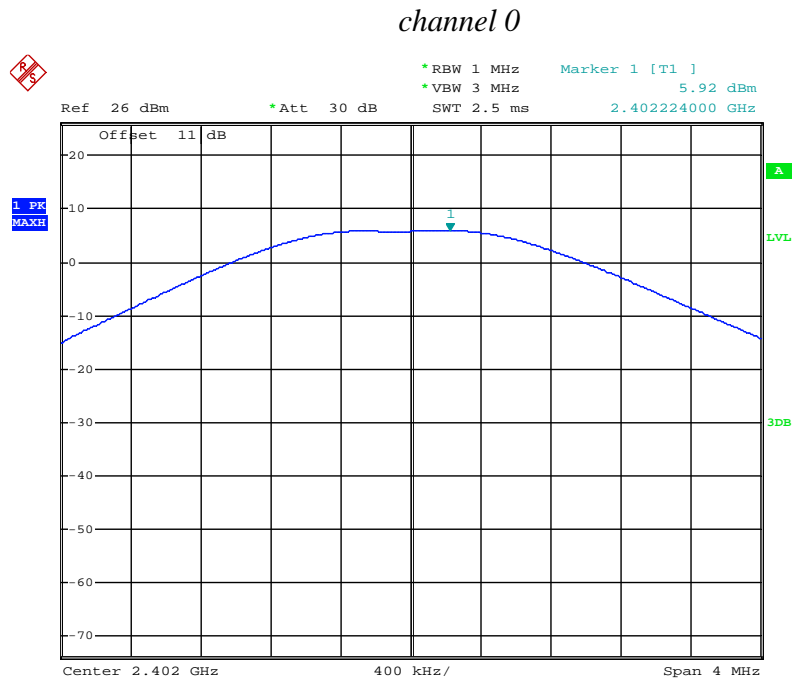

Date: 11.JUN.2018 15:24:08

channel 19

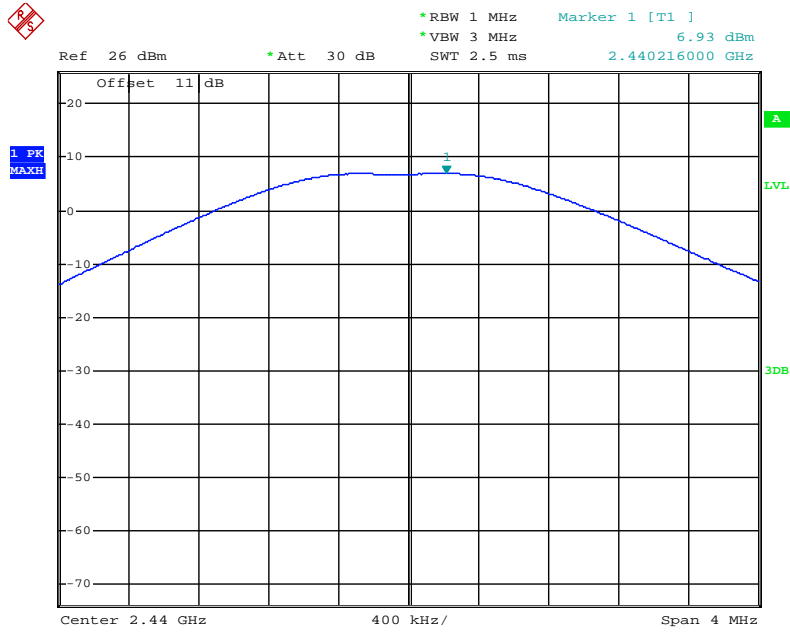

Date: 11.JUN.2018 15:24:42

channel 39

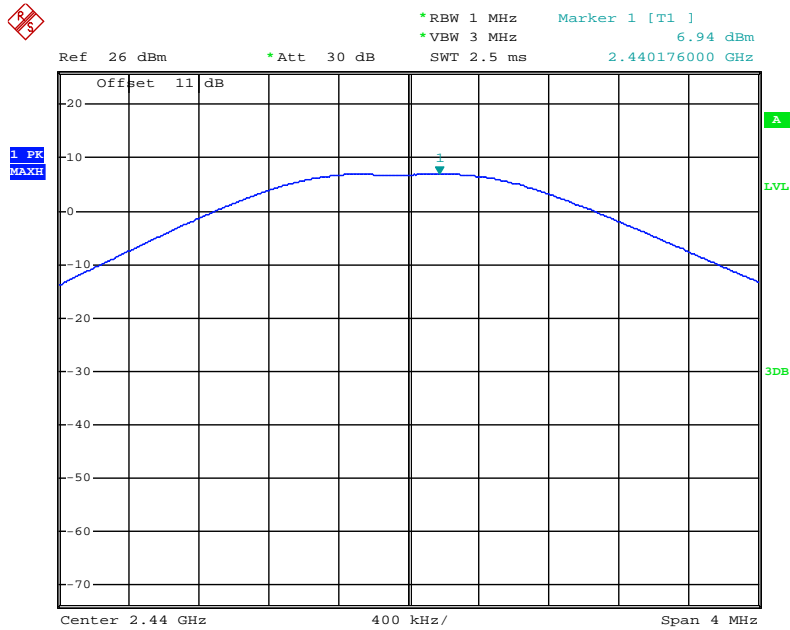

Date: 11.JUN.2018 15:23:22

7. POWER SPECTRAL DENSITY MEASUREMENT

7.1. Block Diagram of Test Setup

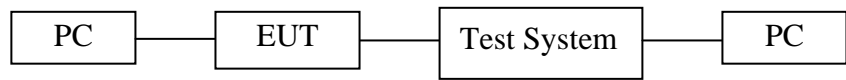

(EUT: UP-Android 7 module)

7.2. The Requirement For Section 15.247(e)

Section 15.247(e): For digitally modulated systems, the power spectral density conducted from the intentional radiator to the antenna shall not be greater than 8 dBm in any 3 kHz band during any time interval of continuous transmission.

7.3. EUT Configuration on Measurement

The equipment are installed on the emission Measurement to meet the commission requirements and operating regulations in a manner which tends to maximize its emission characteristics in normal application.

7.4. Operating Condition of EUT

7.4.1. Setup the EUT and simulator as shown as Section 7.1.

7.4.2. Turn on the power of all equipment.

7.4.3. Let the EUT work in TX modes measure it. The transmit frequency are 2402-2480MHz. We select 2402MHz, 2440MHz, and 2480MHz TX frequency to transmit.

7.5. Test Procedure

7.5.1. The transmitter output was connected to the spectrum analyzer through a low loss cable.

7.5.2. Measurement Procedure PKPSD:

7.5.3. This procedure must be used if maximum peak conducted output power was used to demonstrate compliance to the fundamental output power limit, and is optional if the maximum (average) conducted output power was used to demonstrate compliance.

1. Set analyzer center frequency to DTS channel center frequency.
2. Set the span to 1.5 times the DTS channel bandwidth.
3. Set the RBW to: $3 \text{ kHz} \leq \text{RBW} \leq 100 \text{ kHz}$.
4. Set the VBW $\geq 3 \times \text{RBW}$.
5. Detector = peak.
6. Sweep time = auto couple.
7. Trace mode = max hold.
8. Allow trace to fully stabilize.
9. Use the peak marker function to determine the maximum amplitude level.
10. If measured value exceeds limit, reduce RBW (no less than 3kHz) and repeat.

7.5.4. Measurement the maximum power spectral density.

7.6. Test Result

CHANNEL NUMBER	FREQUENCY (MHz)	PSD (dBm/3KHz)	LIMIT (dBm/3KHz)	PASS/FAIL
0	2402	-8.69	8	PASS
19	2440	-7.57	8	PASS
39	2480	-7.46	8	PASS

The spectrum analyzer plots are attached as below.

channel 0

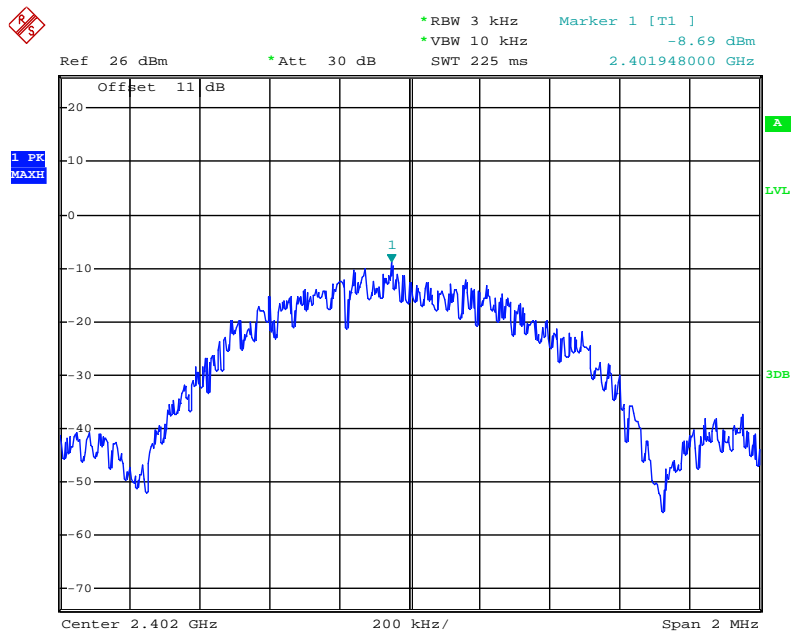

Date: 11.JUN.2018 15:26:13

channel 19

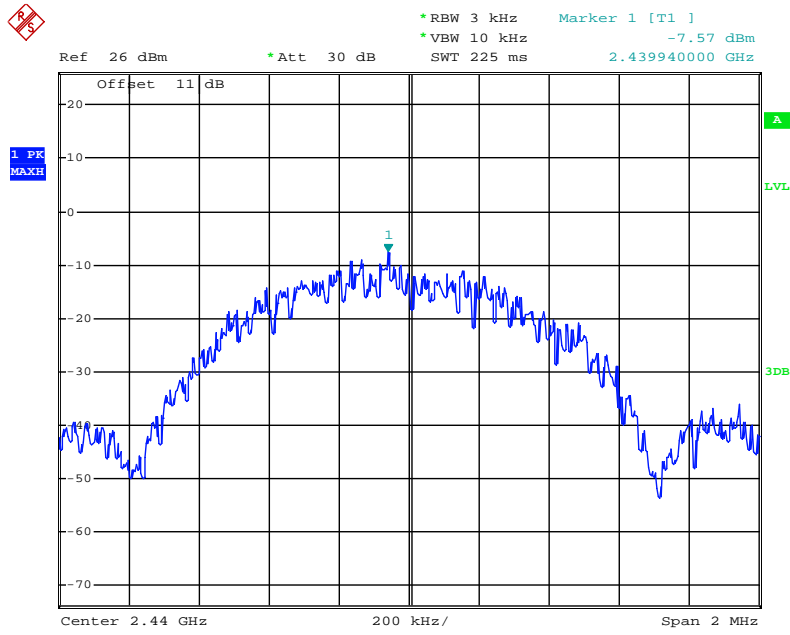

Date: 11.JUN.2018 15:25:41

channel 39

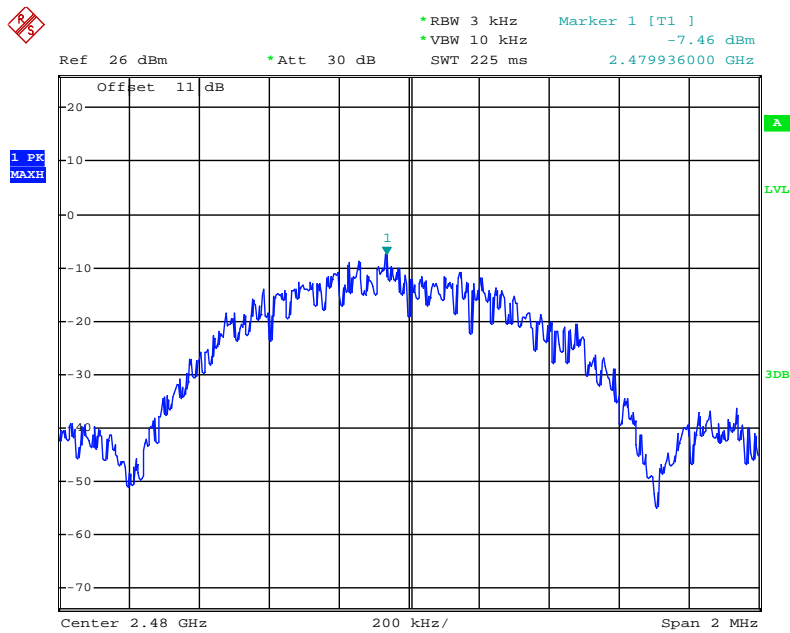

Date: 11.JUN.2018 15:26:39

8. BAND EDGE COMPLIANCE TEST

8.1. Block Diagram of Test Setup

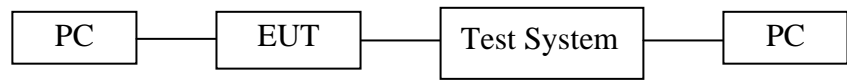

(EUT: UP-Android 7 module)

8.2. The Requirement For Section 15.247(d)

Section 15.247(d): In any 100 kHz bandwidth outside the frequency band in which the spread spectrum or digitally modulated intentional radiator is operating, the radio frequency power that is produced by the intentional radiator shall be at least 20 dB below that in the 100 kHz bandwidth within the band that contains the highest level of the desired power, based on either an RF conducted or a radiated measurement, provided the transmitter demonstrates compliance with the peak conducted power limits. If the transmitter complies with the conducted power limits based on the use of RMS averaging over a time interval, as permitted under paragraph (b)(3) of this section, the attenuation required under this paragraph shall be 30 dB instead of 20 dB. Attenuation below the general limits specified in Section 15.209(a) is not required. In addition, radiated emissions which fall in the restricted bands, as defined in Section 15.205(a), must also comply with the radiated emission limits specified in Section 15.209(a).

8.3. EUT Configuration on Measurement

The equipment are installed on the emission Measurement to meet the commission requirements and operating regulations in a manner which tends to maximize its emission characteristics in normal application.

8.4. Operating Condition of EUT

8.4.1. Setup the EUT and simulator as shown as Section 8.1.

8.4.2. Turn on the power of all equipment.

8.4.3. Let the EUT work in TX modes measure it. The transmit frequency are 2402-2480MHz. We select 2402MHz, 2480MHz TX frequency to transmit.

8.5. Test Procedure

Conducted Band Edge:

8.5.1. The transmitter output was connected to the spectrum analyzer via a low loss cable.

8.5.2. Set RBW of spectrum analyzer to 100 kHz and VBW to 300 kHz.

8.5.3. Radiate Band Edge:

8.5.4. The EUT is placed on a turntable, which is 0.1m above the ground plane and worked at highest radiated power.

8.5.5. The turntable was rotated for 360 degrees to determine the position of maximum emission level.

8.5.6. EUT is set 3m away from the receiving antenna, which is varied from 1m to 4m to find out the highest emission.

8.5.7. Set the spectrum analyzer in the following setting in order to capture the lower and upper band-edges of the emission:

8.5.8. RBW=1MHz, VBW=1MHz

8.5.9. The band edges was measured and recorded.

8.6. Test Result

Pass

Channel	Frequency	Delta peak to band emission	Limit(dBc)
0	2.4GHz	49.04	20
39	2.4835GHz	50.95	20

channel 0

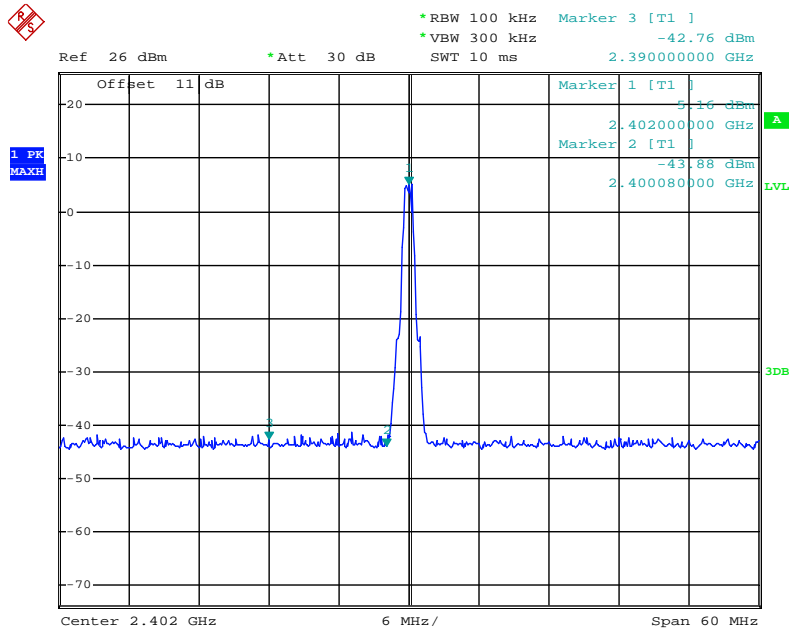

Date: 11.JUN.2018 15:29:30

channel 39

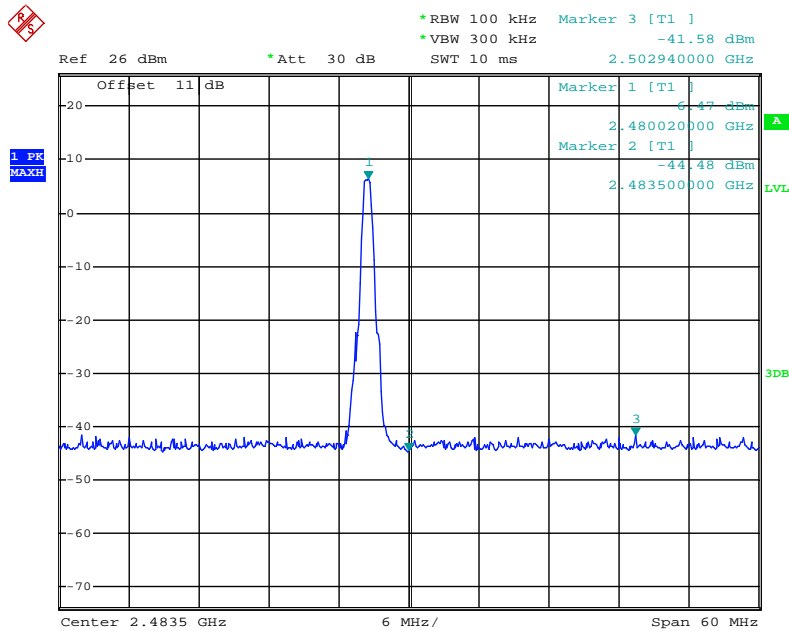

Date: 11.JUN.2018 15:28:08

Radiated Band Edge Result

ACCURATE TECHNOLOGY CO., LTD.

 F1,Bldg,A,Changyuan New Material Port Keyuan Rd,
 Science & Industry Park,Nanshan Shenzhen,P.R.China

Site: 2# Chamber

Tel:+86-0755-26503290

Fax:+86-0755-26503396

Job No.: CLN65 XHUA #62

Standard: FCC PK

Test item: Radiation Test

Temp.(C)/Hum.(%) 23 C / 48 %

EUT: UP-Android 7 module

Mode: TX 2402MHz

Model: UPA000AN

Manufacturer: CTOUCH Europe B.V.

Polarization: Horizontal

Power Source: DC 12V

Date: 18/06/25/

Time: 14/21/48

Engineer Signature: WADE

Distance: 3m

Note: Report No.: ATE20180783

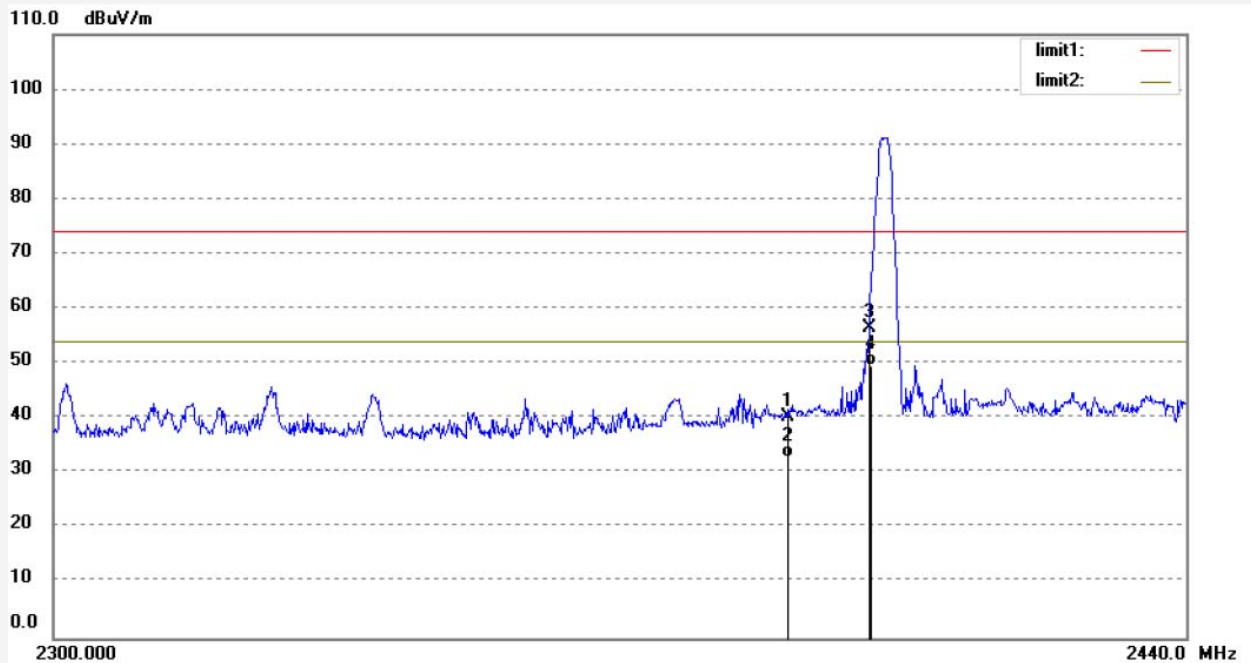

No.	Freq. (MHz)	Reading (dBuV/m)	Factor (dB)	Result (dBuV/m)	Limit (dBuV/m)	Margin (dB)	Detector	Height (cm)	Degree (deg.)	Remark
1	2390.000	39.44	0.79	40.23	74.00	-33.77	peak	150	318	
2	2390.000	32.14	0.79	32.93	54.00	-21.07	AVG	150	320	
3	2400.000	55.74	0.88	56.62	74.00	-17.38	peak	150	351	
4	2400.000	48.64	0.88	49.52	54.00	-4.48	AVG	150	355	

Job No.: CLN65 XHUA #63
 Standard: FCC PK
 Test item: Radiation Test
 Temp.(C)/Hum.(%) 23 C / 48 %
 EUT: UP-Android 7 module
 Mode: TX 2402MHz
 Model: UPA000AN
 Manufacturer: CTOUCH Europe B.V.

Polarization: Vertical
 Power Source: DC 12V
 Date: 18/06/25/
 Time: 14/22/45
 Engineer Signature: WADE
 Distance: 3m

Note: Report No.: ATE20180783

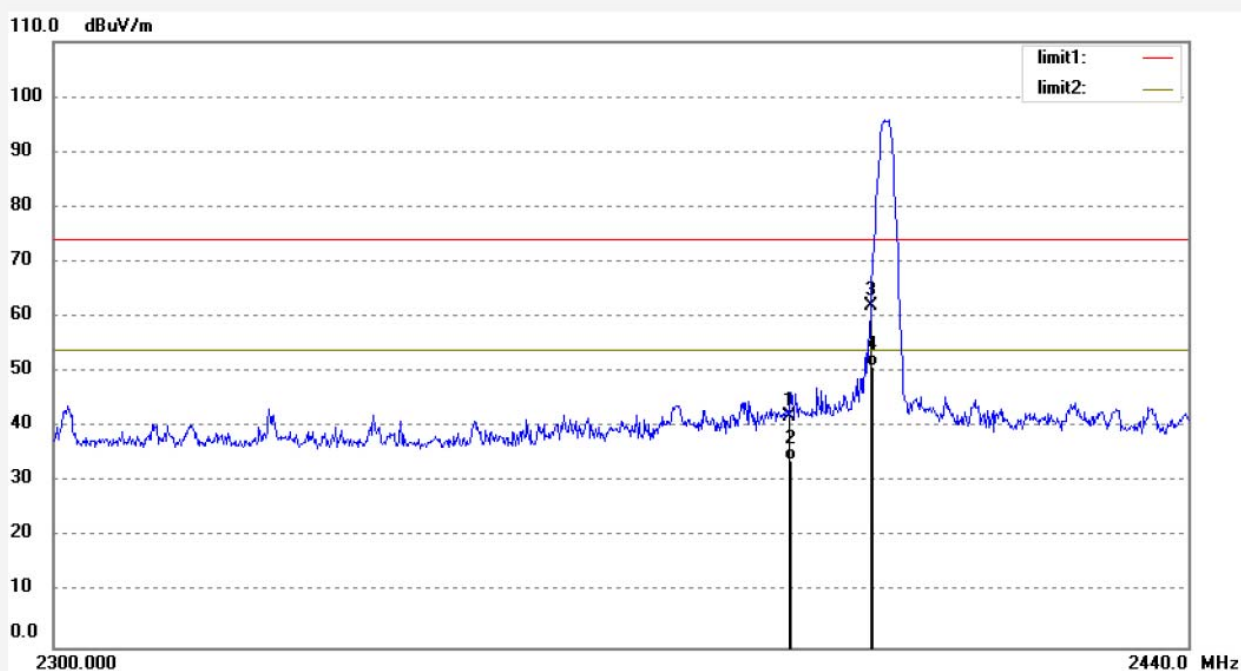

No.	Freq. (MHz)	Reading (dBuV/m)	Factor (dB)	Result (dBuV/m)	Limit (dBuV/m)	Margin (dB)	Detector	Height (cm)	Degree (deg.)	Remark
1	2390.000	41.18	0.79	41.97	74.00	-32.03	peak	150	193	
2	2390.000	33.12	0.79	33.91	54.00	-20.09	AVG	150	200	
3	2400.000	61.14	0.88	62.02	74.00	-11.98	peak	150	136	
4	2400.000	50.00	0.88	50.88	54.00	-3.12	AVG	150	140	

Job No.: CLN65 XHUA #61

Standard: FCC PK

Test item: Radiation Test

Temp.(C)/Hum.(%) 23 C / 48 %

EUT: UP-Android 7 module

Mode: TX 2480MHz

Model: UPA000AN

Manufacturer: CTOUCH Europe B.V.

Polarization: Horizontal

Power Source: DC 12V

Date: 18/06/25/

Time: 14/18/38

Engineer Signature: WADE

Distance: 3m

Note: Report No.: ATE20180783

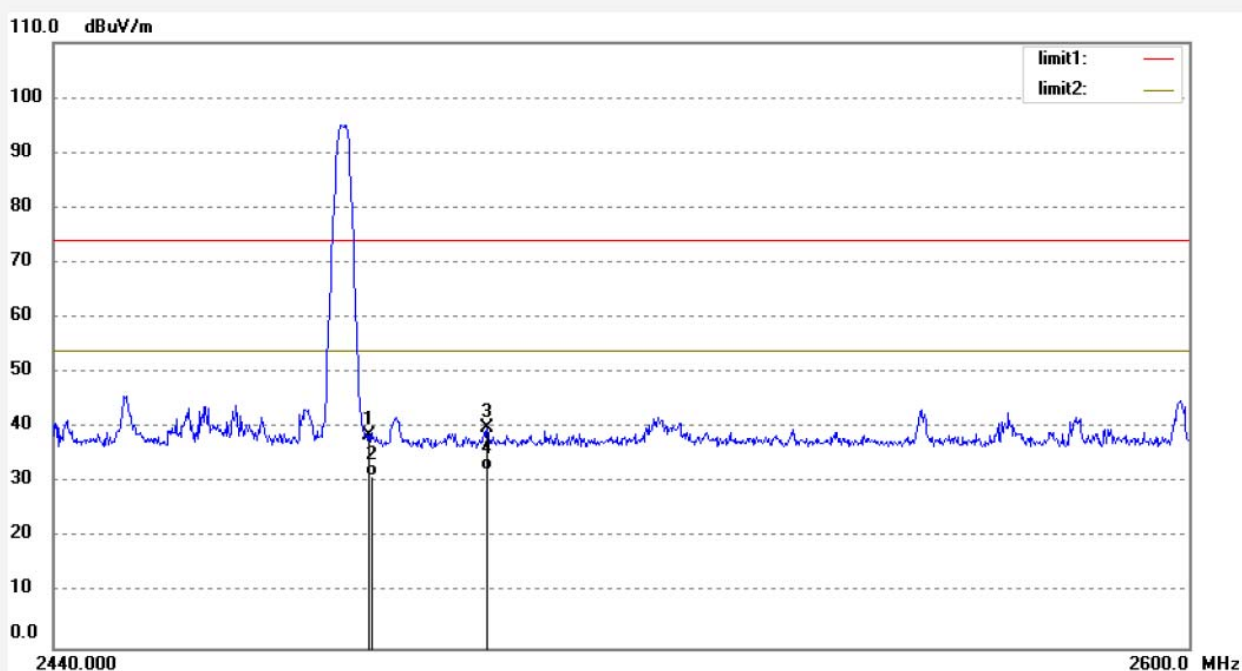

No.	Freq. (MHz)	Reading (dBuV/m)	Factor (dB)	Result (dBuV/m)	Limit (dBuV/m)	Margin (dB)	Detector	Height (cm)	Degree (deg.)	Remark
1	2483.500	37.50	1.10	38.60	74.00	-35.40	peak	150	126	
2	2483.500	30.12	1.10	31.22	54.00	-22.78	AVG	150	130	
3	2500.000	38.79	1.10	39.89	74.00	-34.11	peak	150	318	
4	2500.000	31.25	1.10	32.35	54.00	-21.65	AVG	150	320	

Job No.: CLN65 XHUA #60

Polarization: Vertical

Standard: FCC PK

Power Source: DC 12V

Test item: Radiation Test

Date: 18/06/25/

Temp.(C)/Hum.(%) 23 C / 48 %

Time: 14/14/54

EUT: UP-Android 7 module

Engineer Signature: WADE

Mode: TX 2480MHz

Distance: 3m

Model: UPA000AN

Manufacturer: CTOUCH Europe B.V.

Note: Report No.: ATE20180783

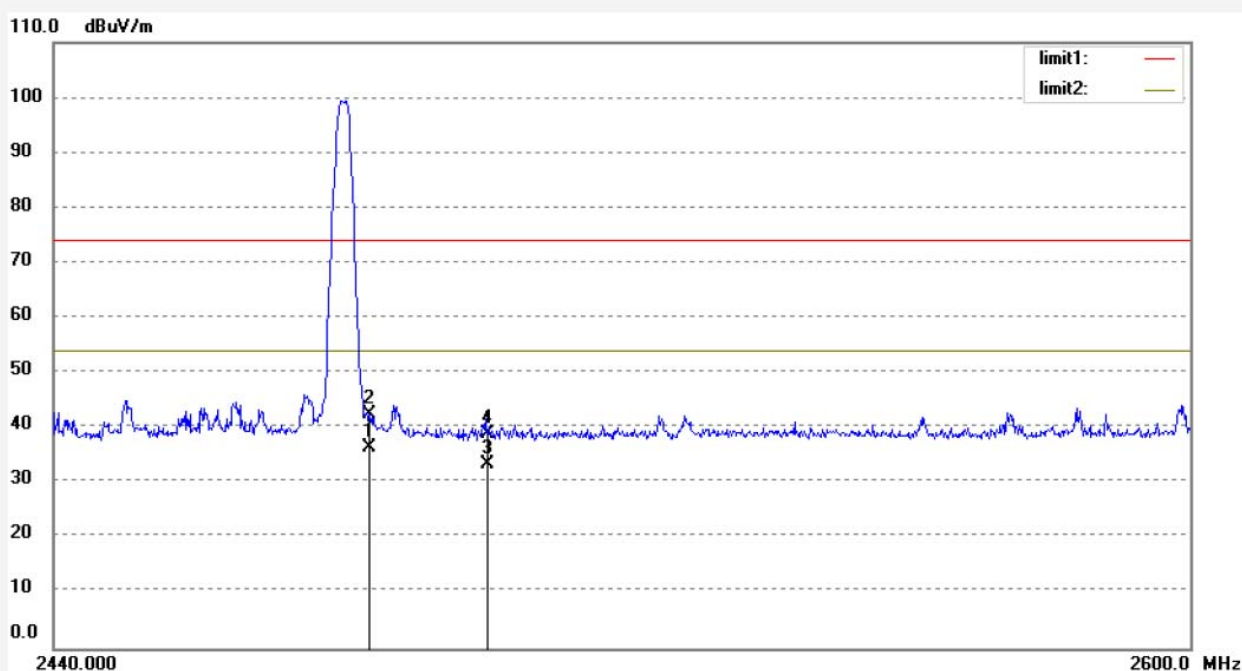

No.	Freq. (MHz)	Reading (dBuV/m)	Factor (dB)	Result (dBuV/m)	Limit (dBuV/m)	Margin (dB)	Detector	Height (cm)	Degree (deg.)	Remark
1	2483.500	-3.30	39.63	36.33	74.00	-37.67	peak	150	123	
2	2483.500	2.78	39.63	42.41	74.00	-31.59	peak	150	130	
3	2500.000	-6.20	39.70	33.50	74.00	-40.50	peak	150	146	
4	2500.000	-0.80	39.70	38.90	74.00	-35.10	peak	150	135	

Note:

1. Emissions attenuated more than 20 dB below the permissible value are not reported.
2. The field strength is calculated by adding the antenna factor, high pass filter loss(if used) and cable loss, and subtracting the amplifier gain(if any)from the measured reading. The basic equation calculation is as follows:

$$\text{Result} = \text{Reading} + \text{Corrected Factor}$$

9. RADIATED SPURIOUS EMISSION TEST

9.1. Block Diagram of Test Setup

9.1.1. Block diagram of connection between the EUT and peripherals

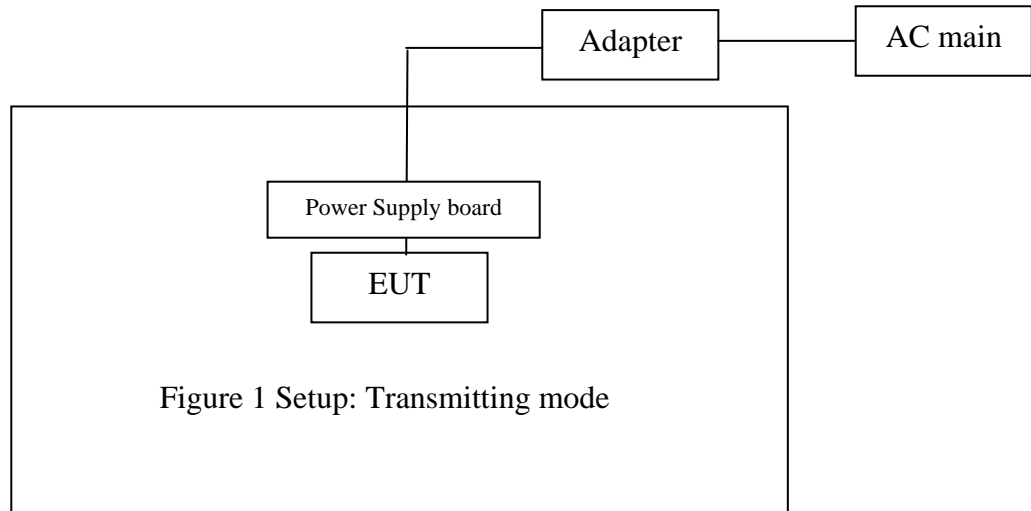

(EUT: UP-Android 7 module)

9.1.2. Semi-Anechoic Chamber Test Setup Diagram

(A) Radiated Emission Test Set-Up, Frequency below 30MHz

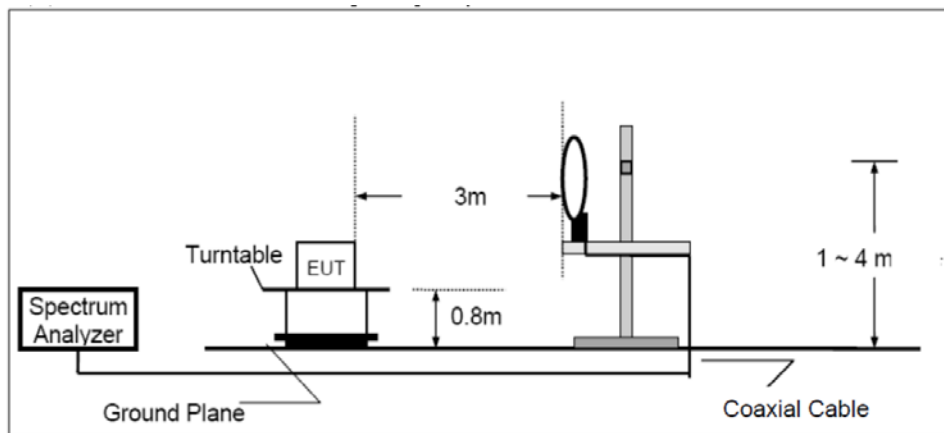

(B) Radiated Emission Test Set-Up, Frequency below 1GHz

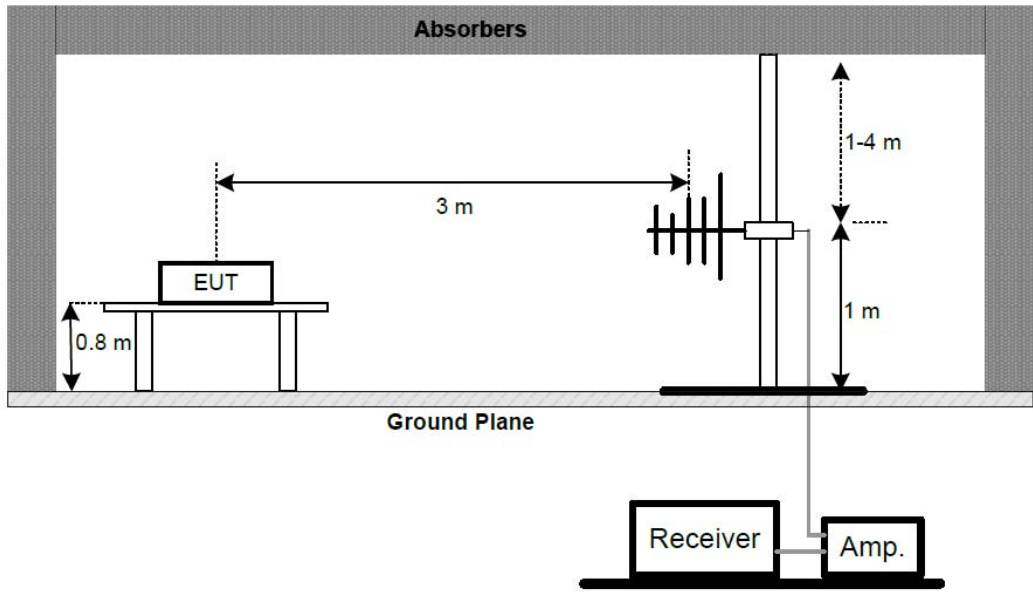

Above 1GHz:

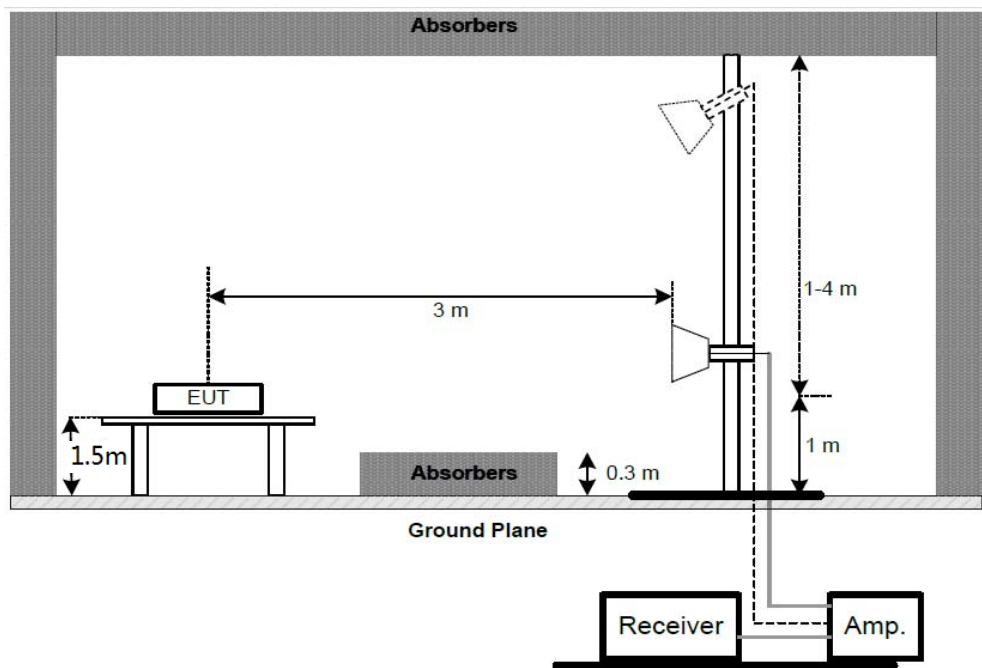

9.2.The Limit For Section 15.247(d)

Section 15.247(d): In any 100 kHz bandwidth outside the frequency band in which the spread spectrum or digitally modulated intentional radiator is operating, the radio frequency power that is produced by the intentional radiator shall be at least 20 dB below that in the 100 kHz bandwidth within the band that contains the highest level of the desired power, based on either an RF conducted or a radiated measurement, provided the transmitter demonstrates compliance with the peak conducted power limits. If the transmitter complies with the conducted power limits based on the use of RMS averaging over a time interval, as permitted under paragraph (b)(3) of this section, the attenuation required under this paragraph shall be 30 dB instead of 20 dB. Attenuation below the general limits specified in Section 15.209(a) is not required. In addition, radiated emissions which fall in the restricted bands, as defined in Section 15.205(a), must also comply with the radiated emission limits specified in Section 15.209(a).

9.3.Restricted bands of operation

9.3.1.FCC Part 15.205 Restricted bands of operation

(a) Except as shown in paragraph (d) of this section, Only spurious emissions are permitted in any of the frequency bands listed below:

MHz	MHz	MHz	GHz
0.090-0.110	16.42-16.423	399.9-410	4.5-5.15
¹ 0.495-0.505	16.69475-16.69525	608-614	5.35-5.46
2.1735-2.1905	16.80425-16.80475	960-1240	7.25-7.75
4.125-4.128	25.5-25.67	1300-1427	8.025-8.5
4.17725-4.17775	37.5-38.25	1435-1626.5	9.0-9.2
4.20725-4.20775	73-74.6	1645.5-1646.5	9.3-9.5
6.215-6.218	74.8-75.2	1660-1710	10.6-12.7
6.26775-6.26825	108-121.94	1718.8-1722.2	13.25-13.4
6.31175-6.31225	123-138	2200-2300	14.47-14.5
8.291-8.294	149.9-150.05	2310-2390	15.35-16.2
8.362-8.366	156.52475-156.52525	2483.5-2500	17.7-21.4
8.37625-8.38675	156.7-156.9	2690-2900	22.01-23.12
8.41425-8.41475	162.0125-167.17	3260-3267	23.6-24.0
12.29-12.293	167.72-173.2	3332-3339	31.2-31.8
12.51975-12.52025	240-285	3345.8-3358	36.43-36.5
12.57675-12.57725	322-335.4	3600-4400	(²)
13.36-13.41			

¹Until February 1, 1999, this restricted band shall be 0.490-0.510

²Above 38.6

(b) Except as provided in paragraphs (d) and (e), the field strength of emission appearing within these frequency bands shall not exceed the limits shown in Section 15.209. At frequencies equal to or less than 1000MHz, Compliance with the limits in Section 15.209 shall be demonstrated using measurement instrumentation employing a CISPR quasi-peak detector. Above 1000MHz, compliance with the emission limits in Section 15.209 shall be demonstrated based on the average value of the measured emissions. The provisions in Section 15.35 apply to these measurements.

9.4. Configuration of EUT on Measurement

The equipment are installed on Radiated Emission Measurement to meet the commission requirements and operating regulations in a manner which tends to maximize its emission characteristics in normal application.

9.5. Operating Condition of EUT

9.5.1. Setup the EUT and simulator as shown as Section 9.1.

9.5.2. Turn on the power of all equipment.

9.5.3. Let the EUT work in TX modes measure it. The transmit frequency are 2402-2480MHz. We select 2402MHz, 2440MHz, and 2480MHz TX frequency to transmit.

9.6. Test Procedure

The EUT and its simulators are placed on a turntable, which is 0.8 meter high above ground (Below 1GHz). The EUT and its simulators are placed on a turntable, which is 1.5 meter high above ground (Above 1GHz). The turntable can rotate 360 degrees to determine the position of the maximum emission level. EUT is set 3.0 meters away from the receiving antenna, which is mounted on an antenna tower. The antenna can be moved up and down between 1.0 meter and 4 meters to find out the maximum emission level. Broadband antenna (calibrated bi-log antenna) is used as receiving antenna. Both horizontal and vertical polarizations of the antenna are set on measurement. In order to find the maximum emission levels, all of the EUT location must be manipulated according to ANSI C63.10:2013 on radiated emission measurement. The EUT was tested in 3 orthogonal planes.

The bandwidth of test receiver is set at 9 kHz in below 30MHz. and set at 120 kHz in 30-1000MHz, and 1MHz in above 1000MHz.

The frequency range from 9 kHz to 25GHz is checked.

The final measurement in band 9-90 kHz, 110-490 kHz and above 1000MHz is performed with Average detector. Except those frequency bands mention above, the final measurement for frequencies below 1000MHz is performed with Quasi Peak detector.

The field strength is calculated by adding the antenna factor, and cable loss, and subtracting the amplifier gain from the measured reading. The basic equation calculation is as follows:

Result = Reading + Corrected Factor

Where Corrected Factor = Antenna Factor + Cable Loss – Amplifier Gain

9.7.Data Sample

Frequency (MHz)	Reading (dB μ v)	Factor (dB/m)	Result (dB μ v/m)	Limit (dB μ v/m)	Margin (dB)	Remark
X.XX	28.66	-15.19	13.47	40.0	-26.53	QP

Frequency(MHz) = Emission frequency in MHz

Reading(dB μ v) = Uncorrected Analyzer/Receiver reading

Factor (dB/m) = Antenna factor + Cable Loss – Amplifier gain

Result(dB μ v/m) = Reading(dB μ v) + Factor(dB/m)

Limit (dB μ v/m) = Limit stated in standard

Margin (dB) = Result(dB μ v/m) - Limit (dB μ v/m)

QP = Quasi-peak Reading

Calculation Formula:

Margin(dB) = Result (dB μ V/m)–Limit(dB μ V/m)

Result(dB μ V/m)= Reading(dB μ V)+ Factor(dB/m)

The “Margin” column of the following data tables indicates the degree of compliance with the applicable limit. For example, a margin of -7dB means the emission is 7dB below the limit.

9.8.The Field Strength of Radiation Emission Measurement Results

PASS.

Note: 1. Emissions attenuated more than 20 dB below the permissible value are not reported.

2. *: Denotes restricted band of operation.

3. The radiation emissions from 9kHz-30MHz and 18-25GHz are not reported, because the test values lower than the limits of 20dB.

Below 1GHz

ACCURATE TECHNOLOGY CO., LTD.

 F1,Bldg,A,Changyuan New Material Port Keyuan Rd,
 Science & Industry Park,Nanshan Shenzhen,P.R.China

Site: 2# Chamber

Tel:+86-0755-26503290

Fax:+86-0755-26503396

 Job No.: CLN65 XHUA #1
 Standard: FCC Class B 3M Radiated
 Test item: Radiation Test
 Temp.(C)/Hum.(%) 23 C / 48 %
 EUT: UP-Android 7 module
 Mode: TX 2402MHz
 Model: UPA000AN
 Manufacturer: CTOUCH Europe B.V.

 Polarization: Horizontal
 Power Source: DC 12V
 Date: 18/06/25/
 Time: 11/05/22
 Engineer Signature: WADE
 Distance: 3m

Note: Report NO.:ATE20180783

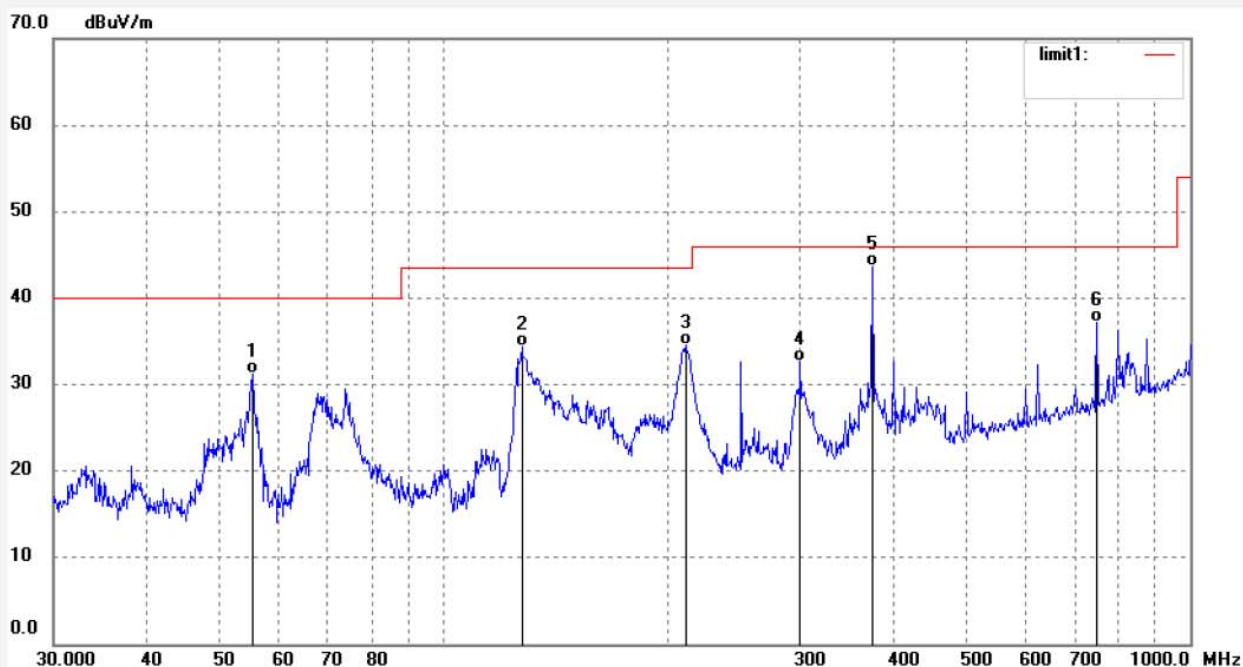

No.	Freq. (MHz)	Reading (dBuV/m)	Factor (dB)	Result (dBuV/m)	Limit (dBuV/m)	Margin (dB)	Detector	Height (cm)	Degree (deg.)	Remark
1	55.4147	44.19	-13.03	31.16	40.00	-8.84	QP	150	192	
2	127.2176	48.09	-13.69	34.40	43.50	-9.10	QP	150	218	
3	210.7860	46.42	-11.94	34.48	43.50	-9.02	QP	150	301	
4	300.3672	41.64	-9.01	32.63	46.00	-13.37	QP	150	319	
5	375.9384	50.73	-7.06	43.67	46.00	-2.33	QP	150	310	
6	750.1082	37.50	-0.29	37.21	46.00	-8.79	QP	150	238	

Job No.: CLN65 XHUA #2

Standard: FCC Class B 3M Radiated

Test item: Radiation Test

Temp.(C)/Hum.(%) 23 C / 48 %

EUT: UP-Android 7 module

Mode: TX 2402MHz

Model: UPA000AN

Manufacturer: CTOUCH Europe B.V.

Polarization: Vertical

Power Source: DC 12V

Date: 18/06/25/

Time: 11/06/21

Engineer Signature: WADE

Distance: 3m

Note: Report NO.:ATE20180783

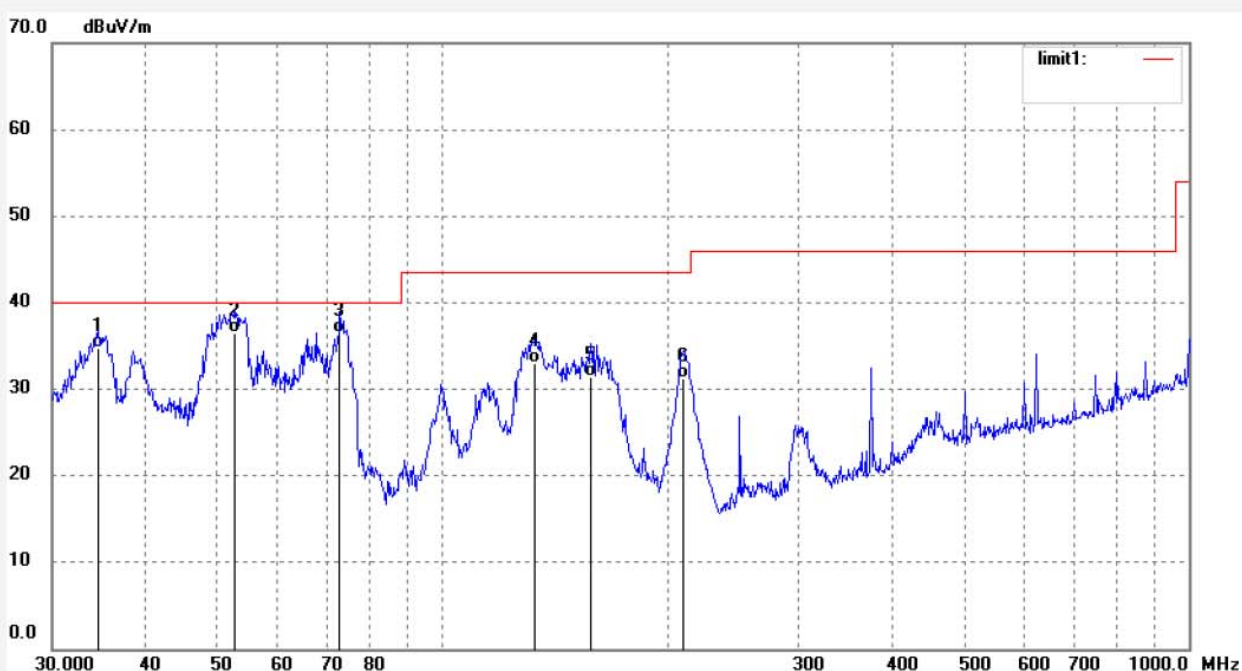

No.	Freq. (MHz)	Reading (dBuV/m)	Factor (dB)	Result (dBuV/m)	Limit (dBuV/m)	Margin (dB)	Detector	Height (cm)	Degree (deg.)	Remark
1	34.6385	45.10	-10.32	34.78	40.00	-5.22	QP	100	317	
2	52.7599	49.20	-12.79	36.41	40.00	-3.59	QP	100	319	
3	72.8465	52.88	-16.44	36.44	40.00	-3.56	QP	100	128	
4	133.1511	46.87	-13.89	32.98	43.50	-10.52	QP	100	129	
5	158.1123	46.00	-14.62	31.38	43.50	-12.12	QP	100	318	
6	210.0482	43.30	-11.99	31.31	43.50	-12.19	QP	100	128	

Job No.: CLN65 XHUA #4
 Standard: FCC Class B 3M Radiated
 Test item: Radiation Test
 Temp.(C)/Hum.(%) 23 C / 48 %
 EUT: UP-Android 7 module
 Mode: TX 2440MHz
 Model: UPA000AN
 Manufacturer: CTOUCH Europe B.V.

Polarization: Horizontal
 Power Source: DC 12V
 Date: 18/06/25/
 Time: 11/08/36
 Engineer Signature: WADE
 Distance: 3m

Note: Report NO.:ATE20180783

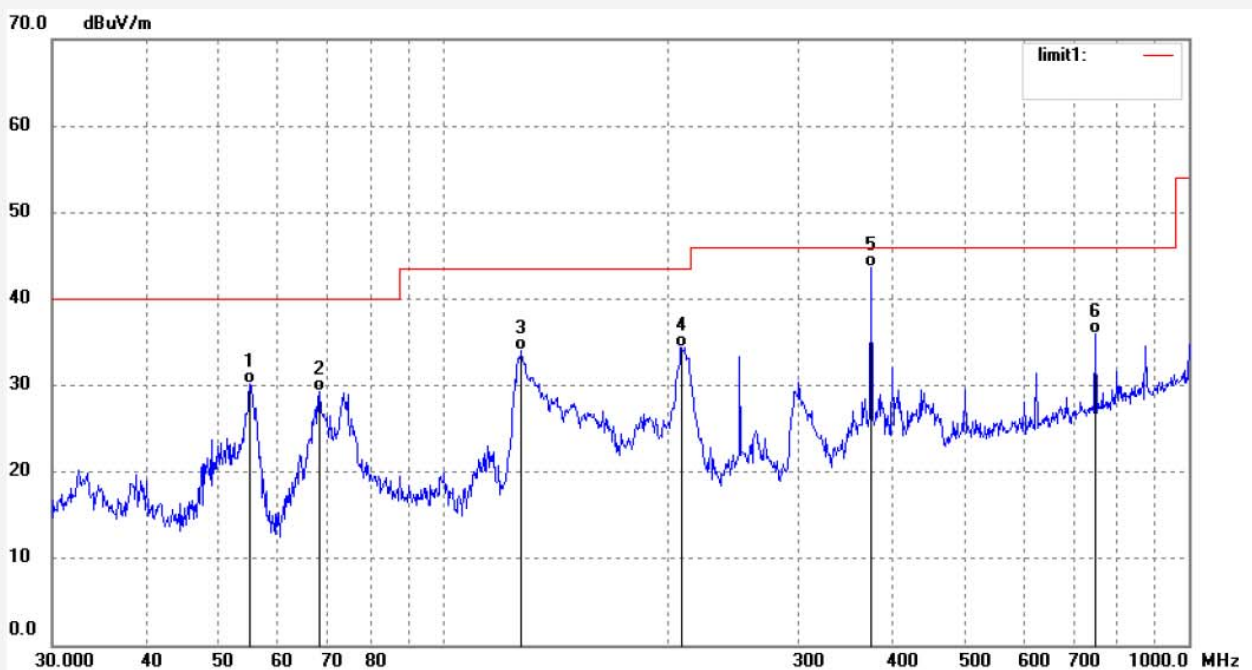

No.	Freq. (MHz)	Reading (dBuV/m)	Factor (dB)	Result (dBuV/m)	Limit (dBuV/m)	Margin (dB)	Detector	Height (cm)	Degree (deg.)	Remark
1	55.2207	43.13	-12.99	30.14	40.00	-9.86	QP	150	91	
2	68.3907	45.24	-15.95	29.29	40.00	-10.71	QP	150	325	
3	127.6645	47.68	-13.70	33.98	43.50	-9.52	QP	150	38	
4	209.3129	46.43	-12.02	34.41	43.50	-9.09	QP	150	216	
5	375.9384	50.78	-7.06	43.72	46.00	-2.28	QP	150	190	
6	750.1082	36.31	-0.29	36.02	46.00	-9.98	QP	150	281	

Job No.: CLN65 XHUA #3

Standard: FCC Class B 3M Radiated

Test item: Radiation Test

Temp.(C)/Hum.(%) 23 C / 48 %

EUT: UP-Android 7 module

Mode: TX 2440MHz

Model: UPA000AN

Manufacturer: CTOUCH Europe B.V.

Polarization: Vertical

Power Source: DC 12V

Date: 18/06/25/

Time: 11/07/32

Engineer Signature: WADE

Distance: 3m

Note: Report NO.:ATE20180783

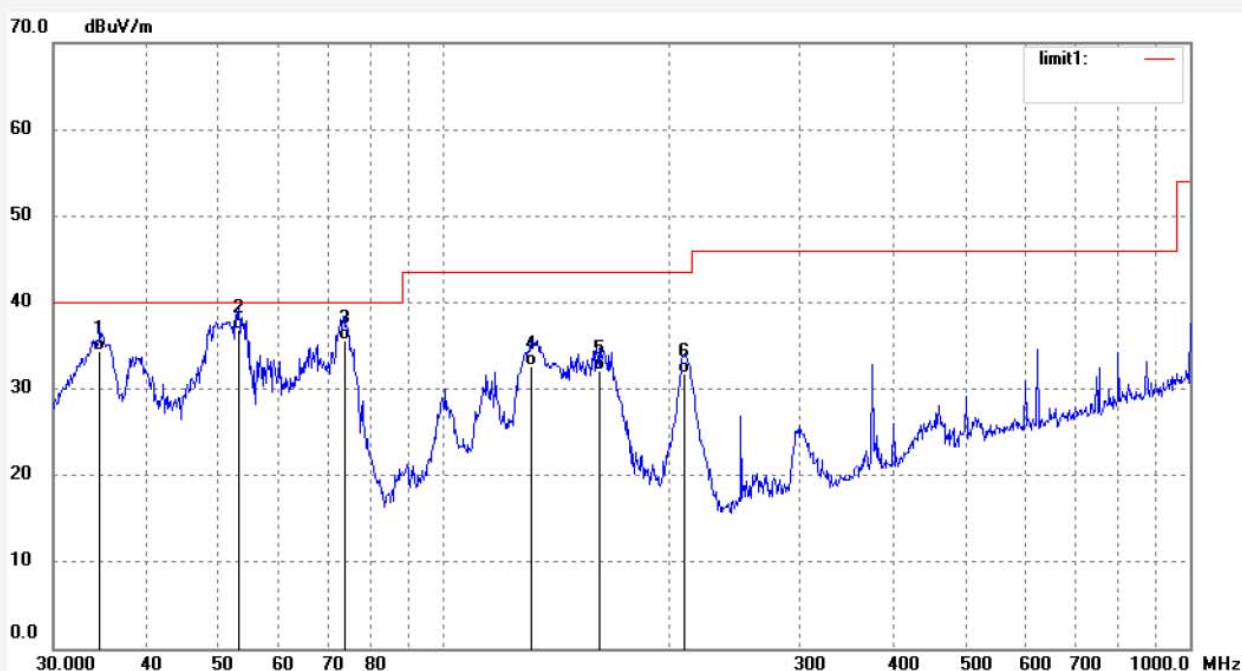

No.	Freq. (MHz)	Reading (dBuV/m)	Factor (dB)	Result (dBuV/m)	Limit (dBuV/m)	Margin (dB)	Detector	Height (cm)	Degree (deg.)	Remark
1	34.6385	44.63	-10.32	34.31	40.00	-5.69	QP	150	181	
2	53.1313	49.70	-12.81	36.89	40.00	-3.11	QP	150	112	
3	73.6170	52.10	-16.54	35.56	40.00	-4.44	QP	150	317	
4	130.8369	46.50	-13.80	32.70	43.50	-10.80	QP	150	91	
5	162.0414	46.55	-14.38	32.17	43.50	-11.33	QP	150	117	
6	210.0482	43.75	-11.99	31.76	43.50	-11.74	QP	150	318	

Job No.: CLN65 XHUA #5

Standard: FCC Class B 3M Radiated

Test item: Radiation Test

Temp.(C)/Hum.(%) 23 C / 48 %

EUT: UP-Android 7 module

Mode: TX 2480MHz

Model: UPA000AN

Manufacturer: CTOUCH Europe B.V.

Polarization: Horizontal

Power Source: DC 12V

Date: 18/06/25/

Time: 11/08/36

Engineer Signature: WADE

Distance: 3m

Note: Report NO.:ATE20180783

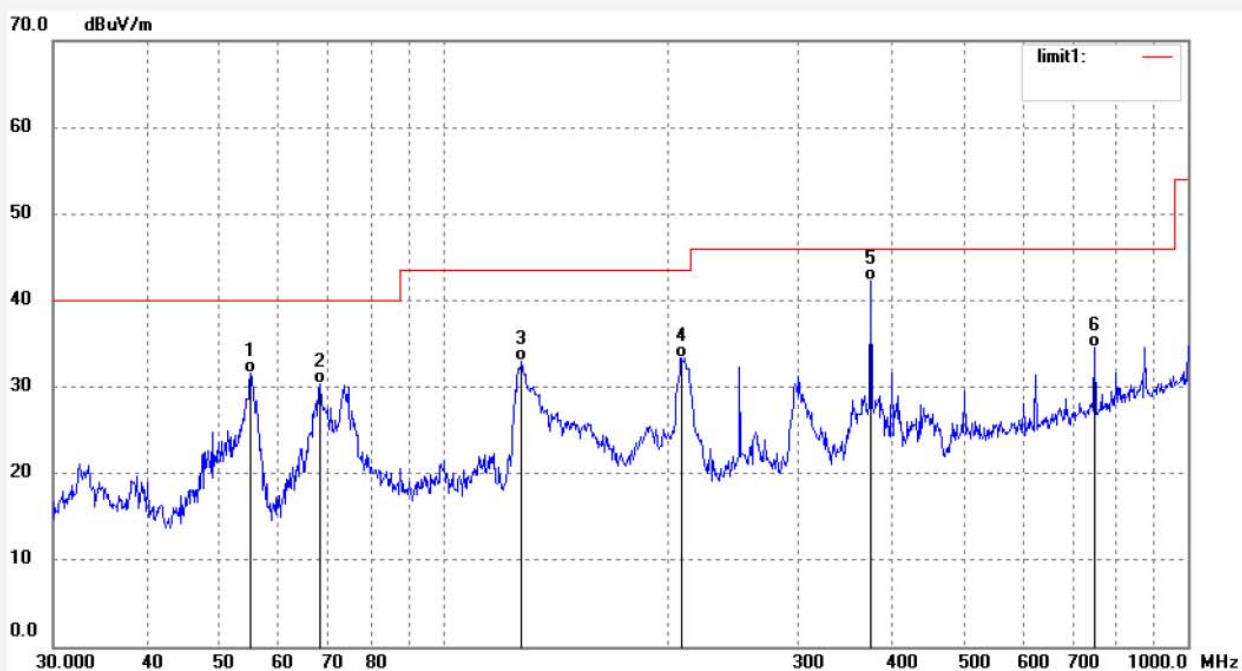

No.	Freq. (MHz)	Reading (dBuV/m)	Factor (dB)	Result (dBuV/m)	Limit (dBuV/m)	Margin (dB)	Detector	Height (cm)	Degree (deg.)	Remark
1	55.2207	44.63	-12.99	31.64	40.00	-8.36	QP	150	321	
2	68.3906	46.24	-15.95	30.29	40.00	-9.71	QP	150	317	
3	127.6645	46.68	-13.70	32.98	43.50	-10.52	QP	150	13	
4	209.3129	45.43	-12.02	33.41	43.50	-10.09	QP	150	128	
5	375.9384	49.28	-7.06	42.22	46.00	-3.78	QP	150	185	
6	750.1082	34.81	-0.29	34.52	46.00	-11.48	QP	150	189	

Job No.: CLN65 XHUA #6
 Standard: FCC Class B 3M Radiated
 Test item: Radiation Test
 Temp.(C)/Hum.(%) 23 C / 48 %
 EUT: UP-Android 7 module
 Mode: TX 2480MHz
 Model: UPA000AN
 Manufacturer: CTOUCH Europe B.V.

Polarization: Vertical
 Power Source: DC 12V
 Date: 18/06/25/
 Time: 11/10/00
 Engineer Signature: WADE
 Distance: 3m

Note: Report NO.:ATE20180783

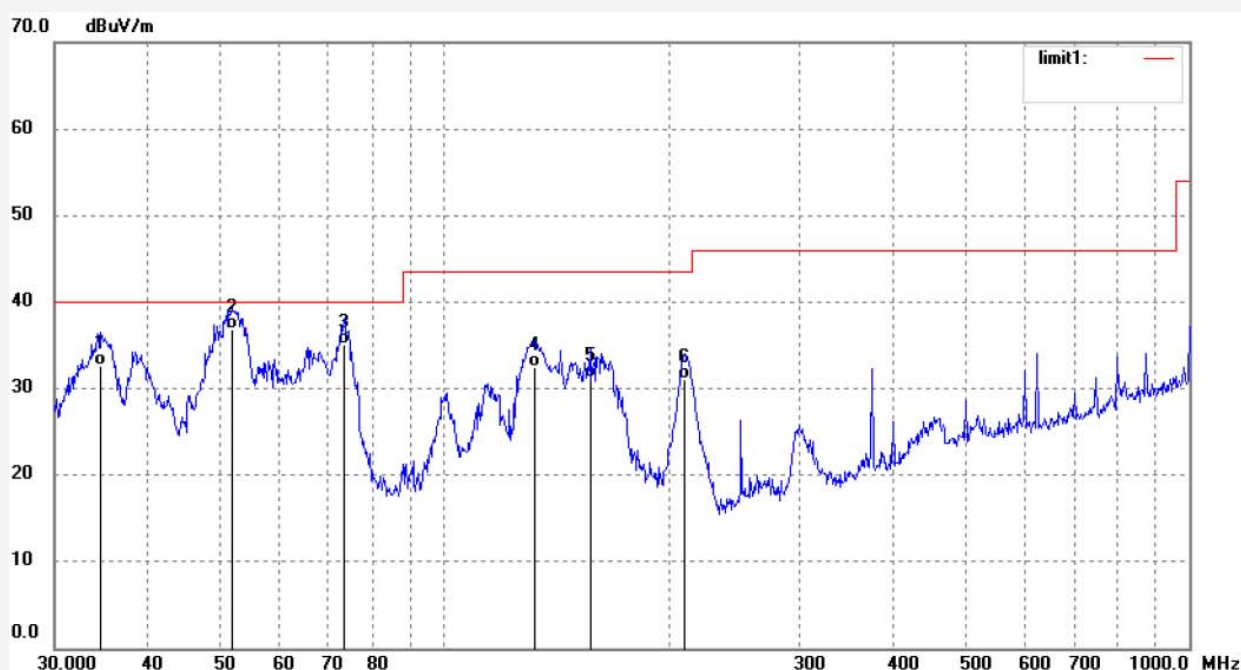

No.	Freq. (MHz)	Reading (dBuV/m)	Factor (dB)	Result (dBuV/m)	Limit (dBuV/m)	Margin (dB)	Detector	Height (cm)	Degree (deg.)	Remark
1	34.6385	43.10	-10.39	32.71	40.00	-7.29	QP	150	328	
2	52.0251	49.50	-12.73	36.77	40.00	-3.23	QP	150	176	
3	73.3593	51.64	-16.51	35.13	40.00	-4.87	QP	150	187	
4	132.2204	46.25	-13.84	32.41	43.50	-11.09	QP	150	192	
5	157.0072	46.00	-14.75	31.25	43.50	-12.25	QP	150	298	
6	210.0482	43.00	-11.99	31.01	43.50	-12.49	QP	150	312	

Above 1GHz



ACCURATE TECHNOLOGY CO., LTD.

F1,Bldg,A,Changyuan New Material Port Keyuan Rd,
Science & Industry Park,Nanshan Shenzhen,P.R.China

Site: 2# Chamber
Tel:+86-0755-26503290
Fax:+86-0755-26503396

Job No.: CLN65 XHUA #54	Polarization: Horizontal
Standard: FCC PK	Power Source: DC 12V
Test item: Radiation Test	Date: 18/06/25/
Temp.(C)/Hum.(%) 23 C / 48 %	Time: 14/05/35
EUT: UP-Android 7 module	Engineer Signature: WADE
Mode: TX 2402MHz	Distance: 3m
Model: UPA000AN	
Manufacturer: CTOUCH Europe B.V.	

Note: Report No.: ATE20180783

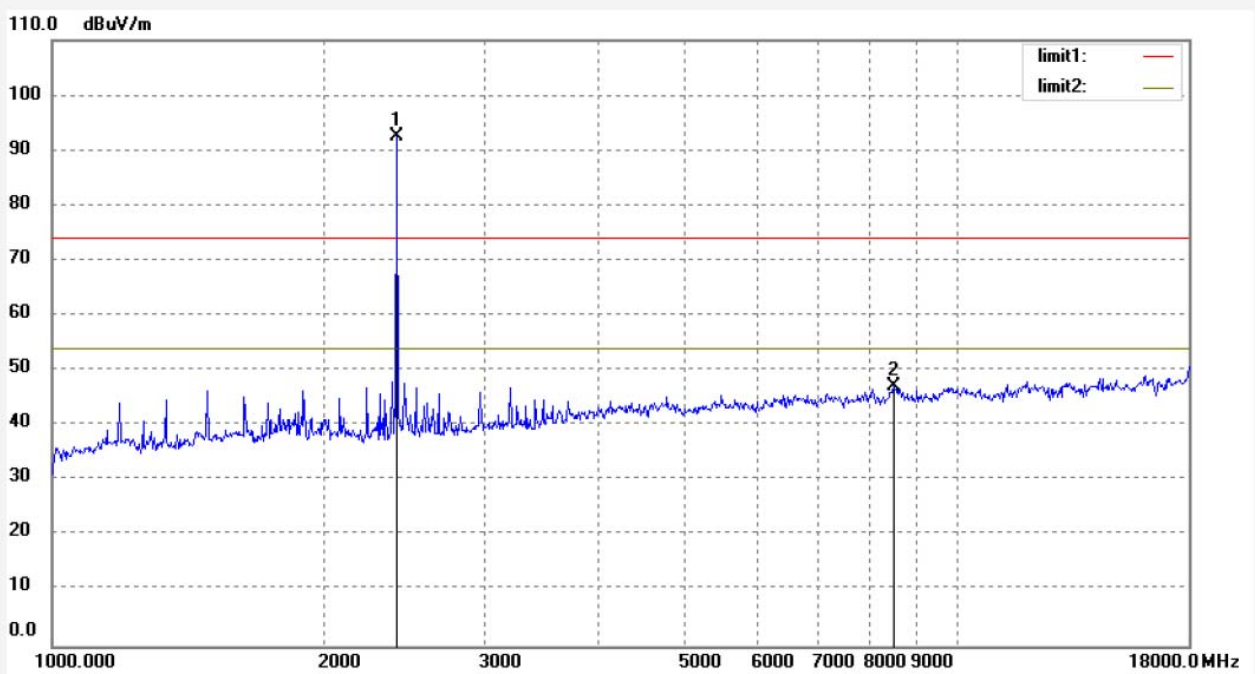

No.	Freq. (MHz)	Reading (dBuV/m)	Factor (dB)	Result (dBuV/m)	Limit (dBuV/m)	Margin (dB)	Detector	Height (cm)	Degree (deg.)	Remark
1	2402.153	53.19	39.28	92.47			peak	150	19	
2	8514.456	-2.26	49.40	47.14	74.00	-26.86	peak	200	186	

Job No.: CLN65 XHUA #55
Standard: FCC PK
Test item: Radiation Test
Temp.(C)/Hum.(%) 23 C / 48 %
EUT: UP-Android 7 module
Mode: TX 2402MHz
Model: UPA000AN
Manufacturer: CTOUCH Europe B.V.

Polarization: Vertical
Power Source: DC 12V
Date: 18/06/25/
Time: 14/06/36
Engineer Signature: WADE
Distance: 3m

Note: Report No.: ATE20180783

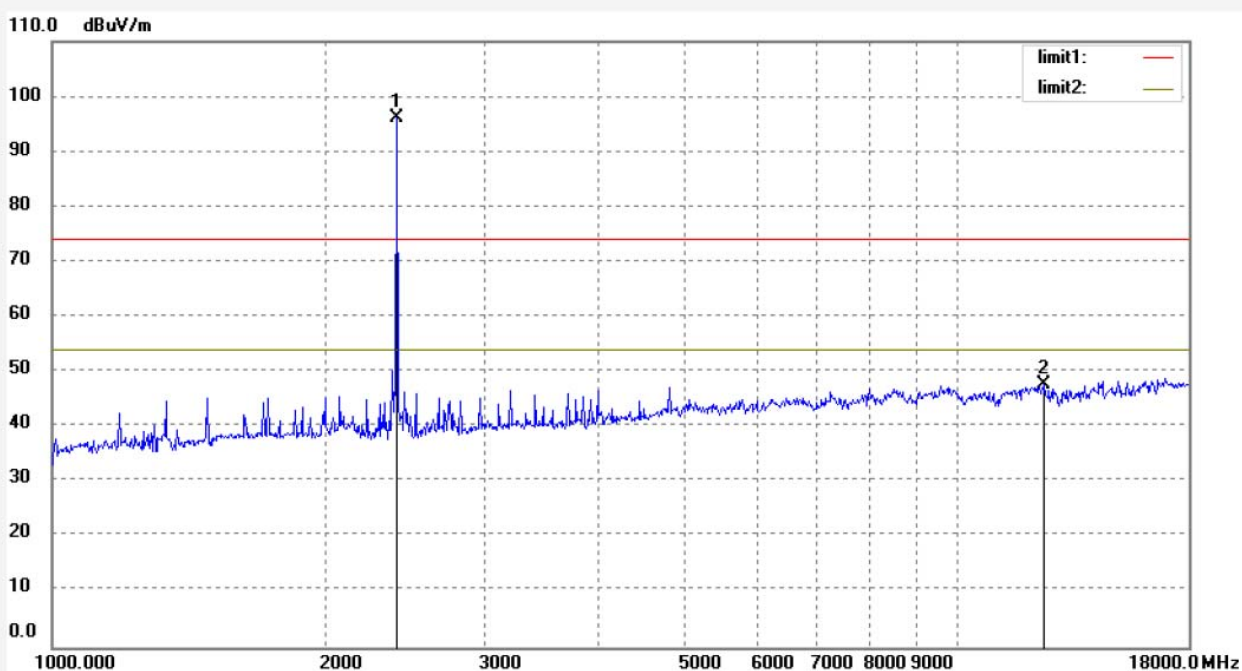

No.	Freq. (MHz)	Reading (dBuV/m)	Factor (dB)	Result (dBuV/m)	Limit (dBuV/m)	Margin (dB)	Detector	Height (cm)	Degree (deg.)	Remark
1	2402.153	56.80	39.28	96.08			peak	150	139	
2	12469.611	-7.27	54.88	47.61	74.00	-26.39	peak	200	198	

Job No.: CLN65 XHUA #57

Polarization: Horizontal

Standard: FCC PK

Power Source: DC 12V

Test item: Radiation Test

Date: 18/06/25/

Temp.(C)/Hum.(%) 23 C / 48 %

Time: 14/09/10

EUT: UP-Android 7 module

Engineer Signature: WADE

Mode: TX 2440MHz

Distance: 3m

Model: UPA000AN

Manufacturer: CTOUCH Europe B.V.

Note: Report No.: ATE20180783

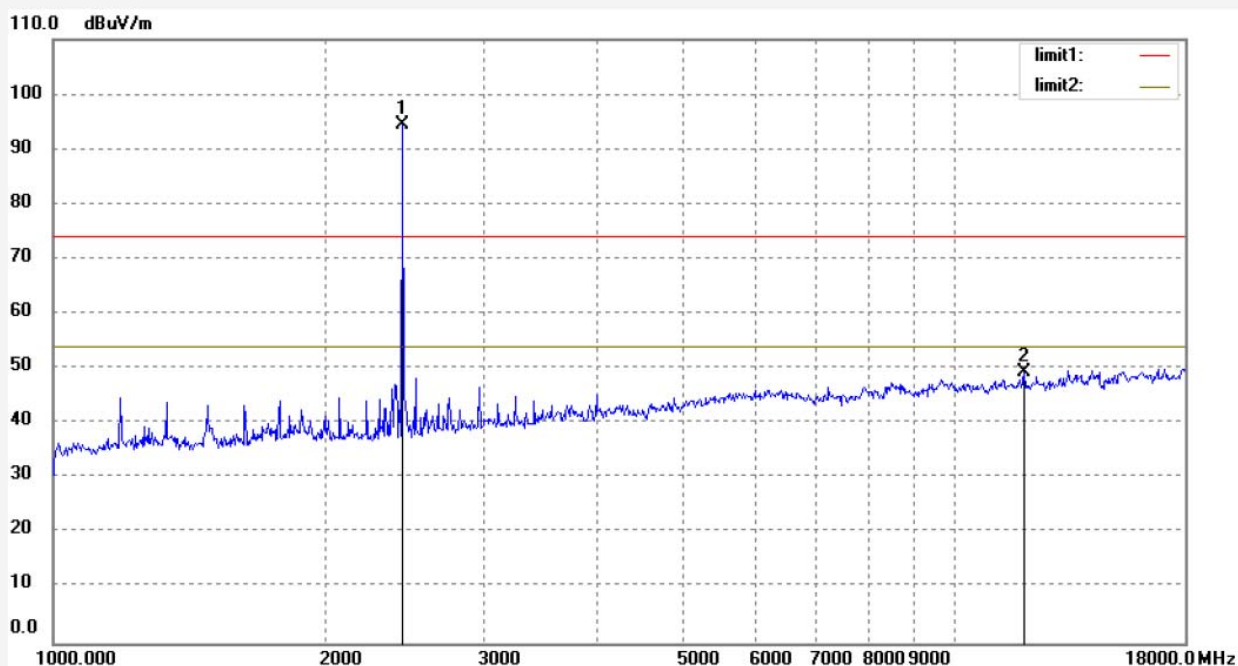

No.	Freq. (MHz)	Reading (dBuV/m)	Factor (dB)	Result (dBuV/m)	Limit (dBuV/m)	Margin (dB)	Detector	Height (cm)	Degree (deg.)	Remark
1	2440.101	55.14	39.43	94.57			peak	150	201	
2	11940.535	-4.48	53.85	49.37	74.00	-24.63	peak	200	122	

Job No.: CLN65 XHUA #56	Polarization: Vertical
Standard: FCC PK	Power Source: DC 12V
Test item: Radiation Test	Date: 18/06/25/
Temp.(C)/Hum.(%) 23 C / 48 %	Time: 14/08/08
EUT: UP-Android 7 module	Engineer Signature: WADE
Mode: TX 2440MHz	Distance: 3m
Model: UPA000AN	
Manufacturer: CTOUCH Europe B.V.	

Note: Report No.: ATE20180783

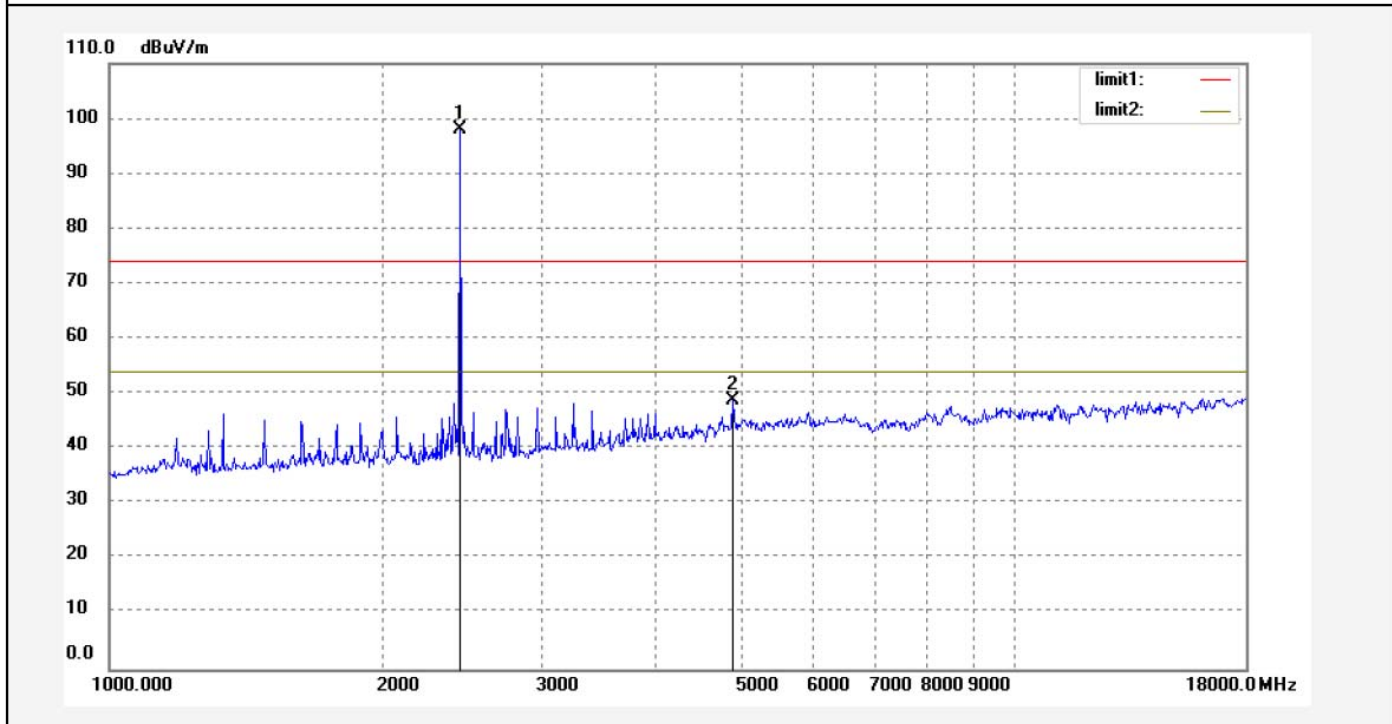

No.	Freq. (MHz)	Reading (dBuV/m)	Factor (dB)	Result (dBuV/m)	Limit (dBuV/m)	Margin (dB)	Detector	Height (cm)	Degree (deg.)	Remark
1	2440.101	58.66	39.43	98.09			peak	150	19	
2	4880.151	4.21	44.73	48.94	74.00	-25.06	peak	150	312	

Job No.: CLN65 XHUA #58	Polarization: Horizontal
Standard: FCC PK	Power Source: DC 12V
Test item: Radiation Test	Date: 18/06/25/
Temp.(C)/Hum.(%) 23 C / 48 %	Time: 14/11/09
EUT: UP-Android 7 module	Engineer Signature: WADE
Mode: TX 2480MHz	Distance: 3m
Model: UPA000AN	
Manufacturer: CTOUCH Europe B.V.	

Note: Report No.: ATE20180783

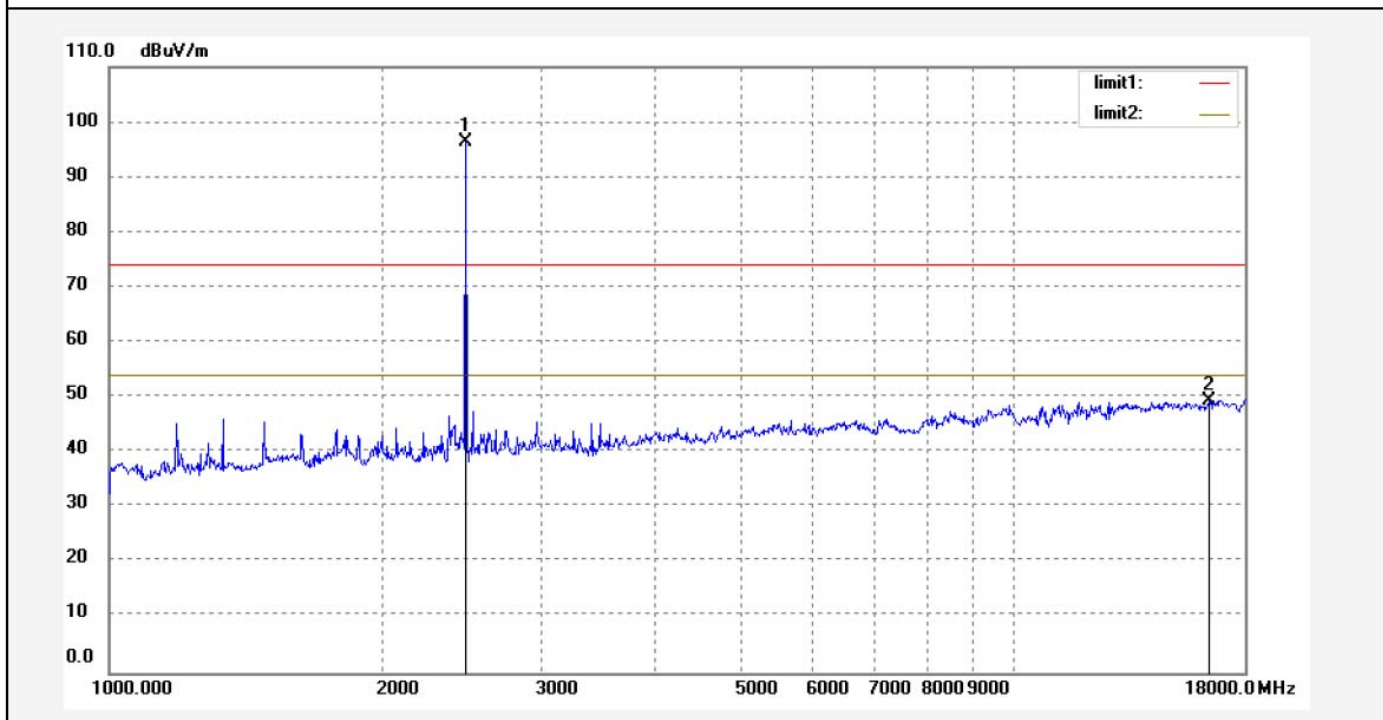

No.	Freq. (MHz)	Reading (dBuV/m)	Factor (dB)	Result (dBuV/m)	Limit (dBuV/m)	Margin (dB)	Detector	Height (cm)	Degree (deg.)	Remark
1	2480.310	56.76	39.61	96.37			peak	150	39	
2	16409.819	-9.85	59.18	49.33	74.00	-24.67	peak	200	123	

Job No.: CLN65 XHUA #59

Standard: FCC PK

Test item: Radiation Test

Temp.(C)/Hum.(%) 23 C / 48 %

EUT: UP-Android 7 module

Mode: TX 2480MHz

Model: UPA000AN

Manufacturer: CTOUCH Europe B.V.

Polarization: Vertical

Power Source: DC 12V

Date: 18/06/25/

Time: 14/12/43

Engineer Signature: WADE

Distance: 3m

Note: Report No.: ATE20180783

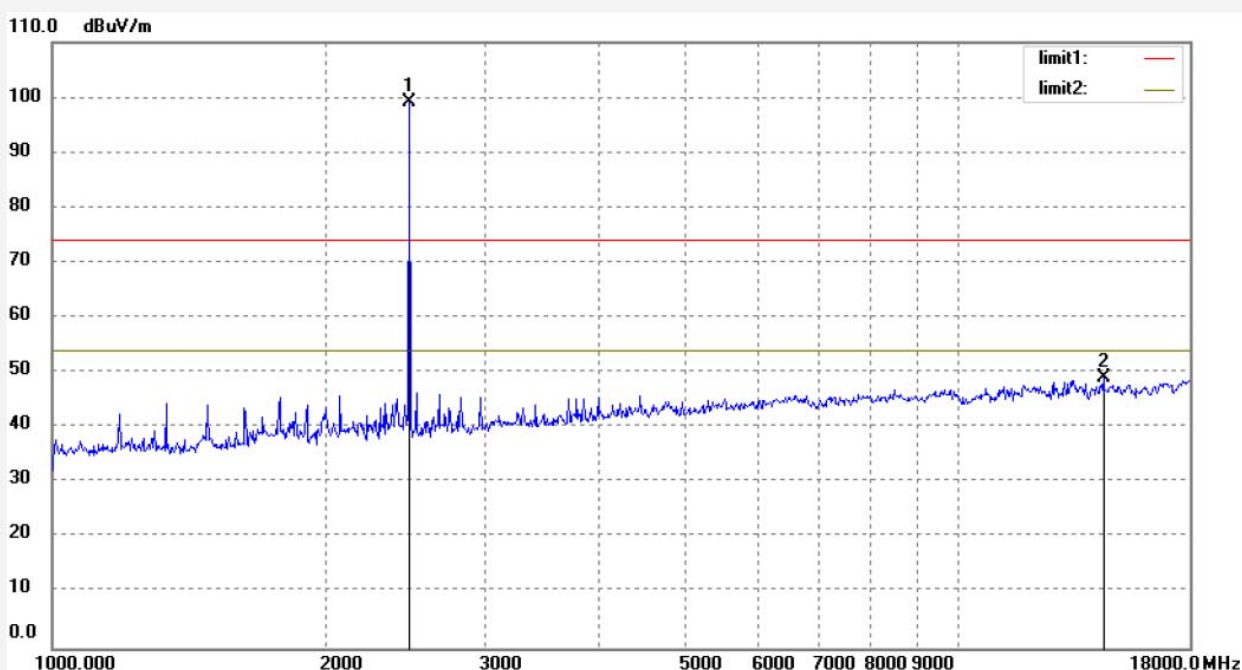

No.	Freq. (MHz)	Reading (dBuV/m)	Factor (dB)	Result (dBuV/m)	Limit (dBuV/m)	Margin (dB)	Detector	Height (cm)	Degree (deg.)	Remark
1	2480.310	59.50	39.61	99.11			peak	150	191	
2	14450.131	-11.16	60.27	49.11	74.00	-24.89	peak	200	310	

10. ANTENNA REQUIREMENT

10.1. The Requirement

According to Section 15.203, an intentional radiator shall be designed to ensure that no antenna other than that furnished by the responsible party shall be used with the device.

10.2. Antenna Construction

The module must contain a permanently attached antenna, or contain a unique antenna connector, and be marketed and operated only with specific antenna(s), per Sections 15.203, 15.204(b), 15.204(c), 15.212(a), 2.929(b); The Antenna gain of EUT is 2dBi. Therefore, the equipment complies with the antenna requirement.

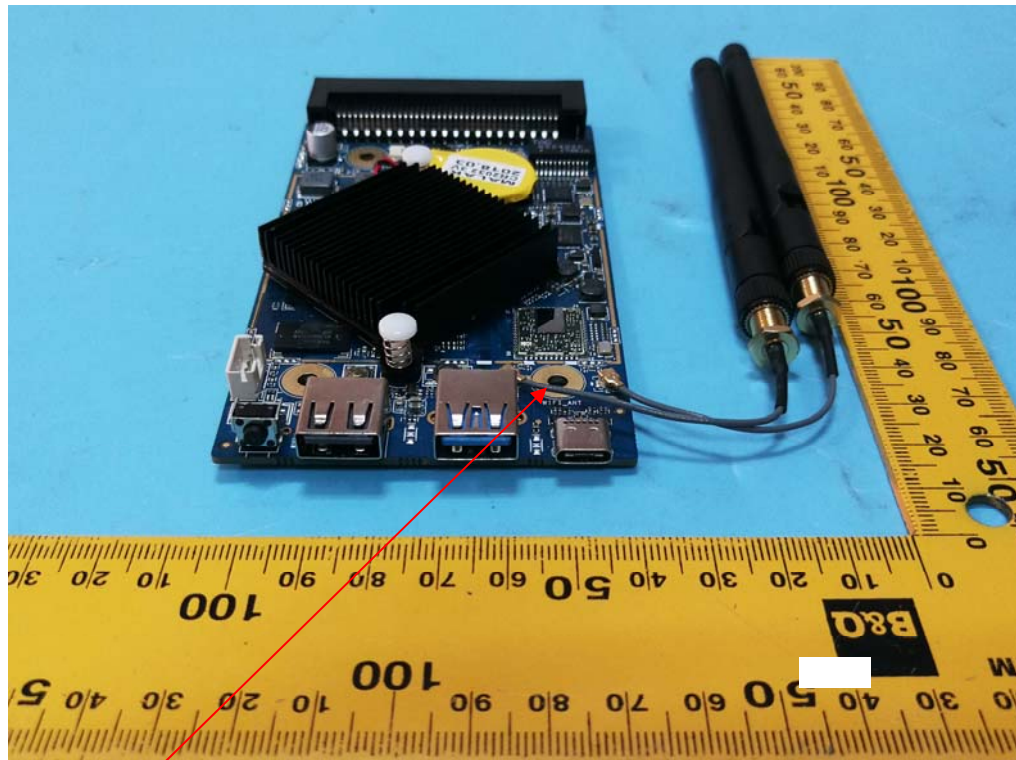

Antenna