

FCC TEST REPORT

Client Information:

Applicant: Shenzhen Aodehong Electronic Technology Co.,Ltd.
Room 501, Building 2, Gaoya industrial park, No. 8 Liuhe Road,
Applicant add.: Liuyue,Henggang Street, Longgang District, Shenzhen City, Guangdong
Province, China.
Manufacturer: Shenzhen Aodehong Electronic Technology Co.,Ltd.
Room 501, Building 2, Gaoya industrial park, No. 8 Liuhe Road,
Manufacturer add.: Liuyue,Henggang Street, Longgang District, Shenzhen City, Guangdong
Province, China.

Product Information:

Product Name: 3-in-1 Wireless Charger
Model No.: F15
Brand Name: NEWQI
FCC ID: 2APQD-F15

Applicable standards: FCC CFR Title 47 Part 15 Subpart C

Prepared By:

Guangdong Asia Hongke Test Technology Limited

B1/F, Building 11, Junfeng Industrial Park, Chongqing Road, Heping Community, Fuhai Street, Bao'an District,
Shenzhen, Guangdong, China

Tel.: +86 0755-230967639 Fax.: +86 0755-230967639

Date of Receipt: Jun. 06, 2024 Date of Test: Jun. 06, 2024 ~ Jun. 18, 2024

Date of Issue: Jun. 18, 2024 Test Result: Pass

This device described above has been tested by Guangdong Asia Hongke Test Technology Limited and the test results show that the equipment under test (EUT) is in compliance with the FCC requirements. And it is applicable only to the tested sample identified in the report.

Note: This report shall not be reproduced except in full, without the written approval of Guangdong Asia Hongke Test Technology Limited, this document may be altered or revised by Guangdong Asia Hongke Test Technology Limited, personal only, and shall be noted in the revision of the document. This test report must not be used by the client to claim product endorsement.

Reviewed by:

Leon Yi

Leon.yi

Approved by:

Sean She

Sean She



Guangdong Asia Hongke Test Technology Limited
B1/F, Building 11, Junfeng Industrial Park, Chongqing Road,
Heping Community, Fuhai Street, Bao'an District, Shenzhen,
Guangdong, China.

1 Contents

	Page
COVER PAGE	
1 CONTENTS	2
2 TEST SUMMARY	5
2.1 STATEMENT OF THE MEASUREMENT UNCERTAINTY	5
2.2 MEASUREMENT UNCERTAINTY	5
3 TEST FACILITY	6
3.1 DEVIATION FROM STANDARD	6
3.2 ABNORMALITIES FROM STANDARD CONDITIONS	6
3.3 TEST LOCATION	6
4 GENERAL INFORMATION	7
4.1 EUT TEST MODE	8
4.2 DESCRIPTION OF TEST SETUP	8
4.3 PERIPHERAL LIST	9
4.4 EUT PERIPHERAL LIST	9
5 EQUIPMENTS LIST FOR ALL TEST ITEMS	10
6 CONDUCTED EMISSION TEST	11
6.1 CONDUCTED EMISSION MEASUREMENT	11
6.2 POWER LINE CONDUCTED EMISSION LIMITS	11
6.3 TEST PROCEDURE	11
6.4 DEVIATION FROM TEST STANDARD	11
6.5 TEST SETUP	12
6.6 EUT OPERATING CONDITIONS	12
6.7 TEST RESULT	13
7 RADIATED EMISSION MEASUREMENT	15
7.1 RADIATED EMISSION LIMITS	15
7.2 ANECHOIC CHAMBER TEST SETUP DIAGRAM	16
7.3 TEST PROCEDURE	16
7.4 DEVIATION FROM TEST STANDARD	17
7.5 TEST RESULT	17
8 BANDWIDTH TEST	21
8.1 TEST PROCEDURE	21
8.2 TEST SETUP	21
9 ANTENNA REQUIREMENT:	24
10 TEST SETUP PHOTOGRAPHS OF EUT	25



11	EXTERNAL PHOTOGRAPHS OF EUT	25
12	INTERNAL PHOTOGRAPHS OF EUT	25

Revision History

Revision	Issue Date	Revisions	Revised By
00	Jun. 18, 2024	Initial Issue	Sean She

2 Test Summary

Test Item	Section in CFR 47	Result
Antenna requirement	15.203	Pass
AC Power Line Conducted Emission	15.207	Pass
Spurious Emission	15.209(a)(f)	Pass
20dB Bandwidth	15.215	Pass

Note

1. Test according to ANSI C63.10:2013.
2. The measurement uncertainty is not included in the test result.
3. Test results in other test report (RF Exposure Evaluation Report)

2.1 Statement of the Measurement Uncertainty

The data and results referenced in this document are true and accurate. The reader is cautioned that there may be errors within the calibration limits of the equipment and facilities. The measurement uncertainty was calculated for all measurements listed in this test report acc. To CISPR 16 – 4 “Specification for radio disturbance and immunity measuring apparatus and methods – Part 4: Uncertainty in EMC Measurements” and is documented in the AiT quality system acc. To DIN EN ISO/IEC 17025. Furthermore, component and process variability of devices similar to that tested may result in additional deviation. The manufacturer has the sole responsibility of continued compliance of the device.

2.2 Measurement Uncertainty

Test Item	Frequency Range	Measurement Uncertainty	Notes
Radiated Emission	0.009MHz-30MHz	3.10dB	(1)
Radiated Emission	30MHz-1GHz	3.75dB	(1)
Radiated Emission	1GHz-18GHz	3.88dB	(1)
Radiated Emission	18GHz-40GHz	3.88dB	(1)
AC Power Line Conducted Emission	0.15MHz ~ 30MHz	1.20dB	(1)

Note (1): The measurement uncertainty is for coverage factor of k=2 and a level of confidence of 95%.

3 Test Facility

The test facility is recognized, certified or accredited by the following organizations:

FCC-Registration No.: 251906 Designation Number: CN1376

Guangdong Asia Hongke Test Technology Limited has been registered and fully described in a report filed with the (FCC) Federal Communications Commission. The acceptance letter from the FCC is maintained in our files.

IC —Registration No.: 31737 CAB identifier: CN0165

The 3m Semi-anechoic chamber of Guangdong Asia Hongke Test Technology Limited has been registered by Certification and Engineering Bureau of Industry Canada for radio equipment testing with Registration No.: 31737

A2LA-Lab Cert. No.: 7133.01

Guangdong Asia Hongke Test Technology Limited has been accredited by A2LA for technical competence in the field of electrical testing, and proved to be in compliance with ISO/IEC 17025: 2017 General Requirements for the Competence of Testing and Calibration Laboratories and any additional program requirements in the identified field of testing.

3.1 Deviation from standard

None

3.2 Abnormalities from standard conditions

None

3.3 Test Location

Guangdong Asia Hongke Test Technology Limited

Address: B1/F, Building 11, Junfeng Industrial Park, Chongqing Road, Heping Community, Fuhai Street, Bao'an District, Shenzhen, Guangdong, China

Tel.: +86 0755-230967639 Fax.: +86 0755-230967639

4 General Information

EUT Name:	3-in-1 Wireless Charger
Model No:	F15
Serial Model:	N/A
Brand Name:	NEWQI
Test sample(s) ID:	AITSZ24052905-1
Sample(s) Status:	Engineer sample
Operation frequency:	Coil1: For Phone: 113kHz-205kHz Coil2: For Earphone: 113kHz-205kHz Coil3: Watch: 300kHz-350kHz
Modulation Technology:	ASK
Antenna Type:	Coil1/Coil2/Coil3: Loop coil Antenna
Antenna gain:	Coil1/Coil2/Coil3: 0dBi
Hardware version.:	N/A
Software version.:	N/A
Power Supply:	Input: 5V=3A/9V=3A/12V=2.5A Output: 5V=1A/9V=1.1A/9V=1.66A
Model different:	color varies
Note:	For a more detailed features description, please refer to the manufacturer's specifications or the User's Manual.

4.1 EUT Test Mode

Equipment under test was operated during the measurement under the following conditions:

Test Mode	Description	
Mode 1	AC Adapter + EUT + Phone + Earphone + Watch	Record
Mode 2	AC Adapter + EUT + Phone + Earphone	Pre-tested
Mode 3	AC Adapter + EUT + Phone + Watch	Pre-tested
Mode 4	AC Adapter + EUT + Phone	Pre-tested
Mode 5	AC Adapter + EUT + Earphone + Watch	Pre-tested
Mode 6	AC Adapter + EUT + Earphone	Pre-tested
Mode 7	AC Adapter + EUT + Watch	Pre-tested
Mode 8	Test the EUT in idle mode.	Pre-tested

Note: 1. All test modes were pre-tested, but we only recorded the worst case in this report.

4.2 Description of Test setup

EUT was tested in normal configuration (Please See following Block diagram)

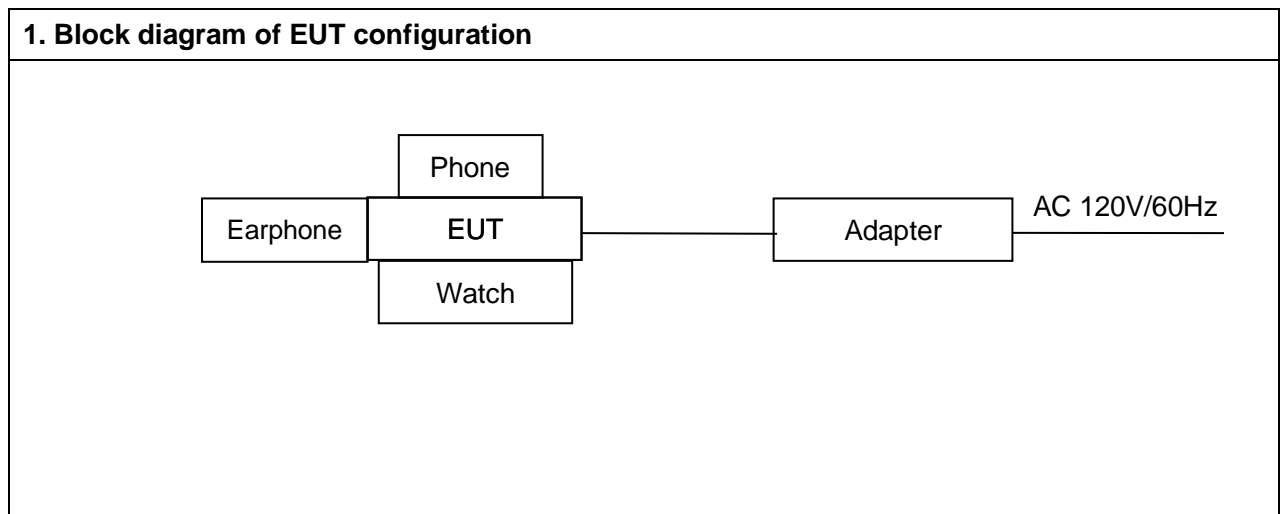

4.3 Peripheral List

No.	Equipment	Manufacturer	Model No.	Serial No.	Power cord	signal cable
1	Adapter	HNT	HNT-QC530	N/A	N/A	N/A
2	phone	OSCAL	PILOT2	N/A	N/A	N/A
3	Earphone	PocBuds	K6	N/A	N/A	N/A
4	Watch	Apple	S6	Watch	N/A	N/A

4.4 EUT Peripheral List

No.	Equipment	Manufacturer	Model No.	Serial No.	Power cord	signal cable
1	N/A	N/A	N/A	N/A	N/A	N/A

5 Equipments List for All Test Items

No	Test Equipment	Manufacturer	Model No	Serial No	Cal. Date	Cal. Due Date
1	Spectrum Analyzer	R&S	FSV40	101470	2023.09.08	2024.09.07
2	Spectrum Analyzer	Keysight	N9020A	MY51280643	2023.09.08	2024.09.07
3	EMI Measuring Receiver	R&S	ESR	101660	2023.09.08	2024.09.07
4	Low Noise Pre-Amplifier	HP	HP8447E	1937A01855	2023.09.08	2024.09.07
5	Low Noise Pre-Amplifier	Tsj	MLA-0120-A02-34	2648A04738	2023.09.08	2024.09.07
6	Passive Loop	ETS	6512	00165355	2022.09.04	2024.09.03
7	TRILOG Super Broadband test Antenna	SCHWARZBECK	VULB9160	9160-3206	2021.08.29	2024.08.28
8	Broadband Horn Antenna	SCHWARZBECK	BBHA9120D	452	2021.08.29	2024.08.28
9	SHF-EHF Horn Antenna 15-40GHz	SCHWARZBECK	BBHA9170	BBHA9170367d	2021.08.29	2024.08.28
10	EMI Measuring Receiver	R&S	ESR	101160	2023.09.13	2024.09.12
11	LISN	SCHWARZBECK	NNLK 8129	8130179	2023.10.29	2024.10.28
12	Pulse Limiter	R&S	ESH3-Z2	102789	2023.09.13	2024.09.12
13	Pro.Temp&Humi.chamber	MENTEK	MHP-150-1C	MAA08112501	2023.09.08	2024.09.07
14	RF Automatic Test system	MW	MW100-RFCB	21033016	2023.09.08	2024.09.07
15	Signal Generator	Agilent	N5182A	MY50143009	2023.09.08	2024.09.07
16	Wideband Radio communication tester	R&S	CMW500	1201.0002K50	2023.09.08	2024.09.07
17	RF Automatic Test system	MW	MW100-RFCB	21033016	2023.09.08	2024.09.07
18	DC power supply	ZHAOXIN	RXN-305D-2	28070002559	N/A	N/A
19	RE Software	EZ	EZ-EMC_RE	Ver.AIT-03A	N/A	N/A
20	CE Software	EZ	EZ-EMC_CE	Ver.AIT-03A	N/A	N/A
21	RF Software	MW	MTS 8310	2.0.0.0	N/A	N/A
22	temporary antenna connector(Note)	NTS	R001	N/A	N/A	N/A

Note: The temporary antenna connector is soldered on the PCB board in order to perform conducted tests and this temporary antenna connector is listed in the equipment list.

6 CONDUCTED EMISSION TEST

6.1 CONDUCTED EMISSION MEASUREMENT

Test Requirement:	FCC Part15 C Section 15.207
Test Method:	ANSI C63.10:2013
Test Frequency Range:	150KHz to 30MHz
Receiver setup:	RBW=9KHz, VBW=30KHz, Sweep time=auto

6.2 POWER LINE CONDUCTED EMISSION Limits

FREQUENCY (MHz)	Limit (dBuV)		Standard
	Quas -peak	Average	
0.15 -0.5	66 - 56 *	56 - 46 *	FCC
0.50 -5.0	56.00	46.00	FCC
5.0 -30.0	60.00	50.00	FCC

Note:

(1) *Decreases with the logarithm of the frequency.

6.3 TEST PROCEDURE

- a. The EUT was placed 0.8 meters from the horizontal ground plane with EUT being connected to the power mains through a line impedance stabilization network (LISN). All other support equipments powered from additional LISN(s). The LISN provide 50 Ohm/ 50uH of coupling impedance for the measuring instrument.
- b. Interconnecting cables that hang closer than 40 cm to the ground plane shall be folded back and forth in the center forming a bundle 30 to 40 cm long.
- c. I/O cables that are not connected to a peripheral shall be bundled in the center. The end of the cable may be terminated, if required, using the correct terminating impedance. The overall length shall not exceed 1 m.
- d. LISN at least 80 cm from nearest part of EUT chassis.
- e. For the actual test configuration, please refer to the related Item –EUT Test Photos.

6.4 DEVIATION FROM TEST STANDARD

No deviation

6.5 TEST SETUP

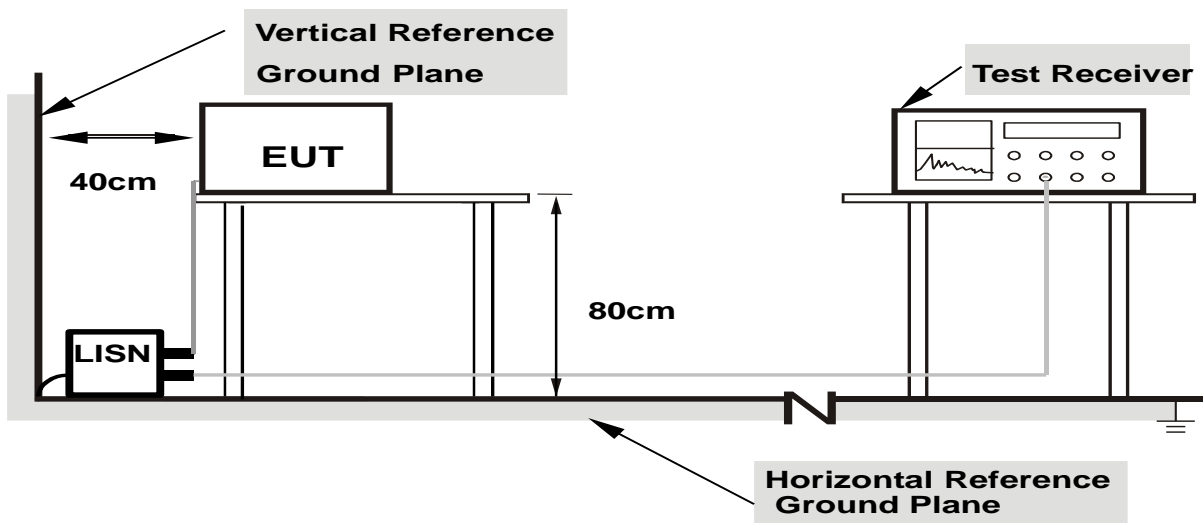

- Note: 1.Support units were connected to second LISN.**
2.Both of LISNs (AMN) are 80 cm from EUT and at least 80 from other units and other metal planes

6.6 EUT OPERATING CONDITIONS

The EUT was configured for testing in a typical fashion (as a customer would normally use it). The EUT has been programmed to continuously transmit during test. This operating condition was tested and used to collect the included data.

We pretest AC 120V and AC 230V, the worst voltage was AC 120V and the data recording in the report.

6.7 Test Result

Temperature:	26°C	Relative Humidity:	54%
Pressure:	101kPa	Phase :	L
Test Voltage :	AC 120V/60Hz		

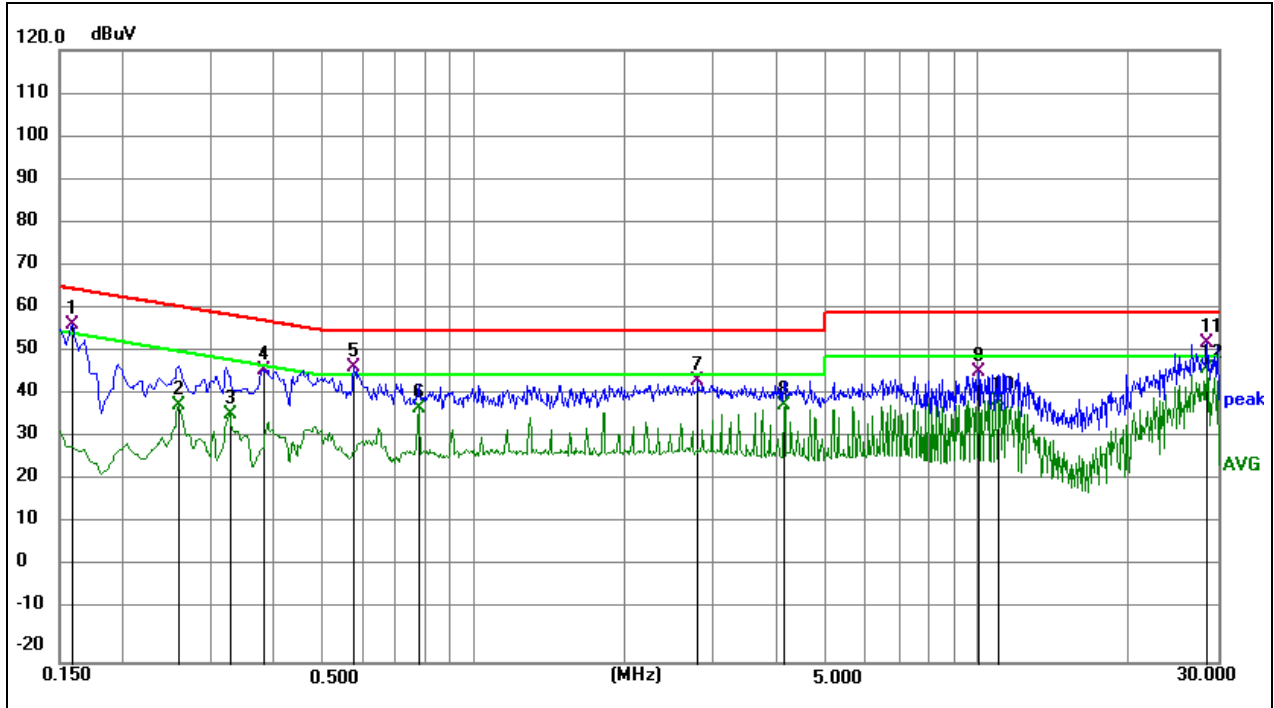

No.	Frequency (MHz)	Reading (dBuV)	Correct (dB)	Result (dBuV)	Limit (dBuV)	Margin (dB)	Remark
1	0.1590	46.58	10.78	57.36	65.52	-8.16	QP
2	0.2580	28.16	10.70	38.86	51.50	-12.64	AVG
3	0.3255	26.14	10.70	36.84	49.57	-12.73	AVG
4	0.3795	36.21	10.69	46.90	58.29	-11.39	QP
5	0.5775	36.75	10.69	47.44	56.00	-8.56	QP
6	0.7755	27.49	10.67	38.16	46.00	-7.84	AVG
7	2.7869	33.61	10.80	44.41	56.00	-11.59	QP
8	4.1369	27.86	11.00	38.86	46.00	-7.14	AVG
9	10.0635	35.46	11.02	46.48	60.00	-13.52	QP
10	10.9995	28.83	11.18	40.01	50.00	-9.99	AVG
11	28.5630	41.43	11.66	53.09	60.00	-6.91	QP
12	28.5630	35.60	11.66	47.26	50.00	-2.74	AVG

Temperature:	26°C	Relative Humidity:	54%
Pressure:	101kPa	Phase :	N
Test Voltage :	AC 120V/60Hz		

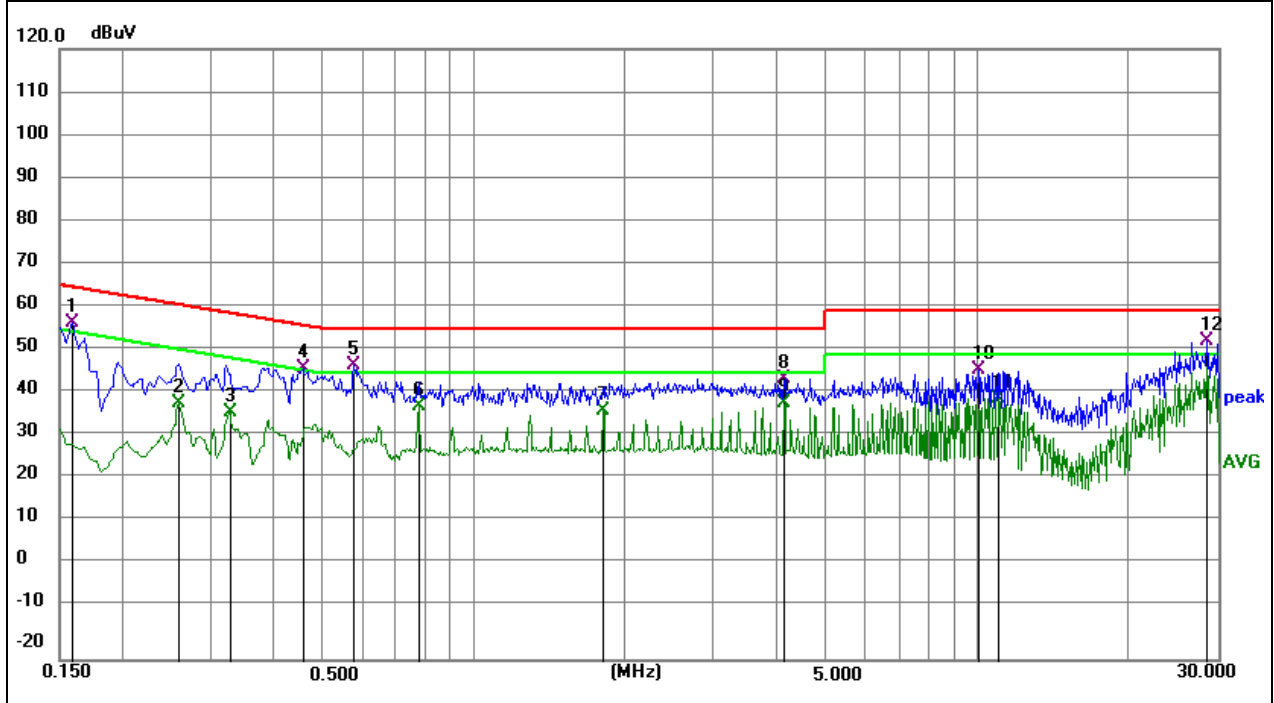

No.	Frequency (MHz)	Reading (dBuV)	Correct (dB)	Result (dBuV)	Limit (dBuV)	Margin (dB)	Remark
1	0.1590	46.58	10.78	57.36	65.52	-8.16	QP
2	0.2580	28.17	10.69	38.86	51.50	-12.64	AVG
3	0.3255	26.15	10.69	36.84	49.57	-12.73	AVG
4	0.4560	36.03	10.69	46.72	56.77	-10.05	QP
5	0.5775	36.76	10.68	47.44	56.00	-8.56	QP
6	0.7755	27.50	10.66	38.16	46.00	-7.84	AVG
7	1.8060	26.28	10.75	37.03	46.00	-8.97	AVG
8	4.1369	33.53	11.00	44.53	56.00	-11.47	QP
9	4.1369	27.86	11.00	38.86	46.00	-7.14	AVG
10	10.0635	35.48	11.00	46.48	60.00	-13.52	QP
11	10.9995	28.86	11.15	40.01	50.00	-9.99	AVG
12	28.5630	41.52	11.57	53.09	60.00	-6.91	QP

Remark: Correct Factor = Insertion loss of LISN + Cable loss + Insertion loss of Pulse Limiter;
 Measurement Result = Reading Level + Correct Factor;
 Margin = Measurement Result - Limit;

7 RADIATED EMISSION MEASUREMENT

Test Requirement:	FCC Part15 C Section 15.209				
Test Method:	ANSI C63.10:2013				
Test Frequency Range:	9kHz to 1GHz				
Test site:	Measurement Distance: 3m				
Receiver setup:	Frequency	Detector	RBW	VBW	Value
	9KHz-150KHz	Quasi-peak	200Hz	600Hz	Quasi-peak
	150KHz-30MHz	Quasi-peak	9KHz	30KHz	Quasi-peak
	30MHz-1GHz	Quasi-peak	100KHz	300KHz	Quasi-peak
	Above 1GHz	Peak	1MHz	3MHz	Peak
		Peak	1MHz	10Hz	Average

7.1 Radiated Emission Limits

Limits for frequency below 30MHz

Frequency	Limit (uV/m)	Measurement Distance(m)	Remark
0.009-0.490	2400/F(kHz)	300	Quasi-peak Value
0.490-1.705	24000/F(kHz)	30	Quasi-peak Value
1.705-30	30	30	Quasi-peak Value

Limits for frequency Above 30MHz

Frequency	Limit (dBuV/m @3m)	Remark
30MHz-88MHz	40.00	Quasi-peak Value
88MHz-216MHz	43.50	Quasi-peak Value
216MHz-960MHz	46.00	Quasi-peak Value
960MHz-1GHz	54.00	Quasi-peak Value
Above 1GHz	54.00	Average Value
	74.00	Peak Value

7.2 Anechoic Chamber Test Setup Diagram

(A) Radiated Emission Test-Up Frequency Below 30MHz

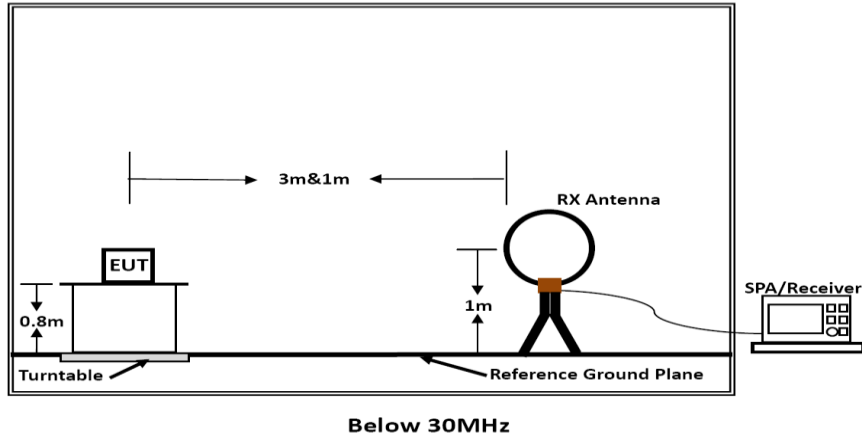

(B) Radiated Emission Test-Up Frequency 30MHz~1GHz

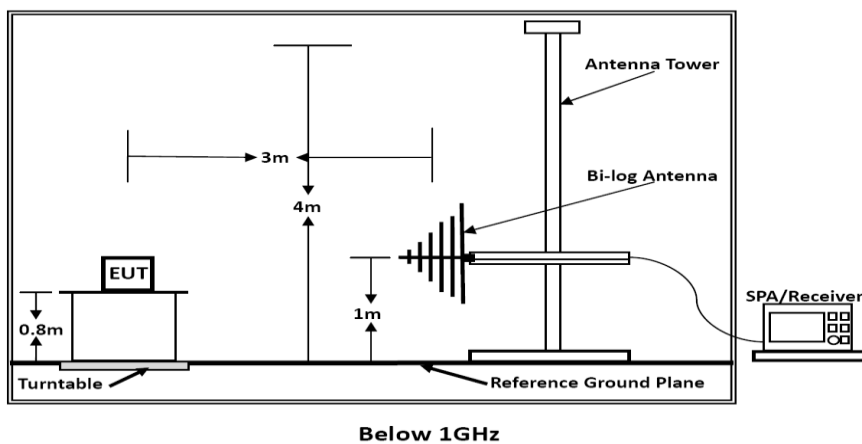

The radiated emission tests were performed in the 3 meters chamber test site, using the setup accordance with the ANSI C63.10-2013. The specification used was the FCC 15.209 and FCC 15.205 limits.

7.3 Test Procedure

The EUT is placed on a turn table which is 0.8 meter above ground. The turn table can rotate 360 degrees to determine the position of the maximum emission level. The EUT is set 3 meters away from the receiving antenna which is mounted on a antenna tower. The antenna can move up and down between 1 to 4 meters to find out the maximum emission level. Broadband antenna (calibrated by dipole antenna) are used as a receiving antenna. Both horizontal and vertical polarization of the antenna are set on measurement.

7.4 DEVIATION FROM TEST STANDARD

No deviation

7.5 Test Result

We pretest AC 120V and AC 230V in full load, half load and no load, the worst voltage was AC 120V in full load and the data recording in the report.

Mode1 :

9KHz-150KHz

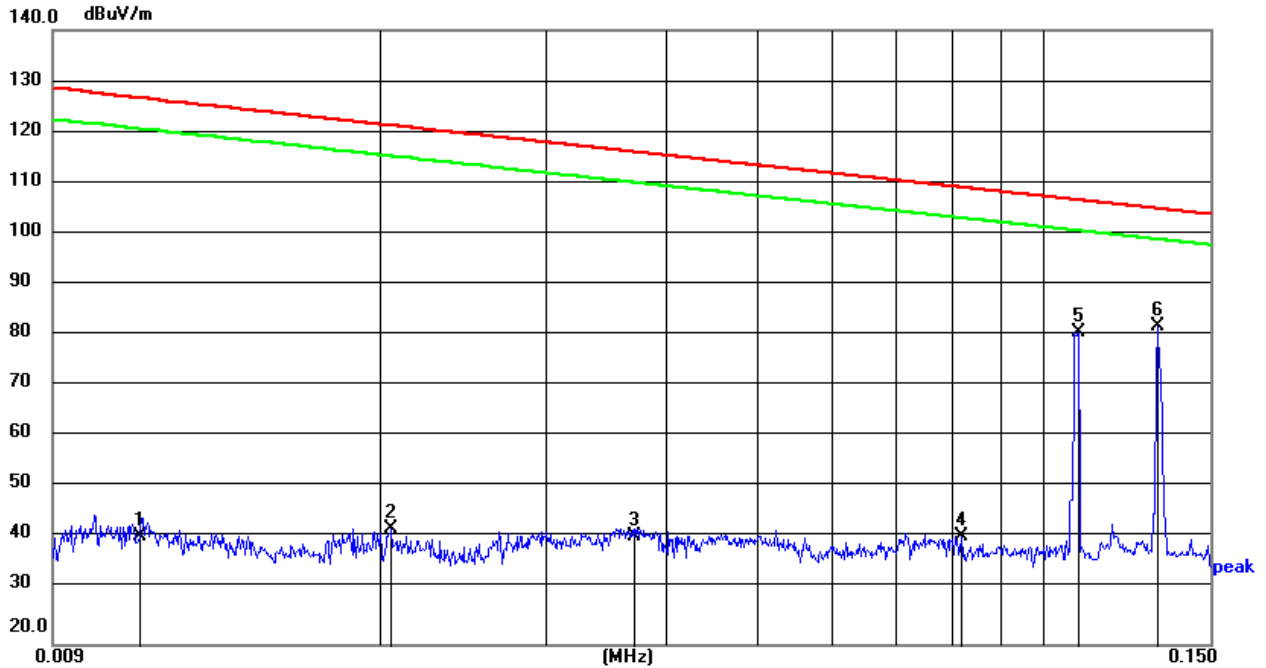

No.	Frequency (MHz)	Reading (dBuV)	Factor (dB/m)	Level (dBuV/m)	Limit (dBuV/m)	Margin (dB)	Det.
1	0.0111	19.75	21.36	41.11	126.70	-85.59	peak
2	0.0205	21.77	20.83	42.60	121.37	-78.77	peak
3	0.0370	19.49	21.82	41.31	116.24	-74.93	peak
4	0.0820	18.52	22.67	41.19	109.33	-68.14	peak
5	0.1087	58.82	22.31	81.13	106.88	-25.75	peak
6 *	0.1320	60.29	22.08	82.37	105.19	-22.82	peak

150KHz-30MHz

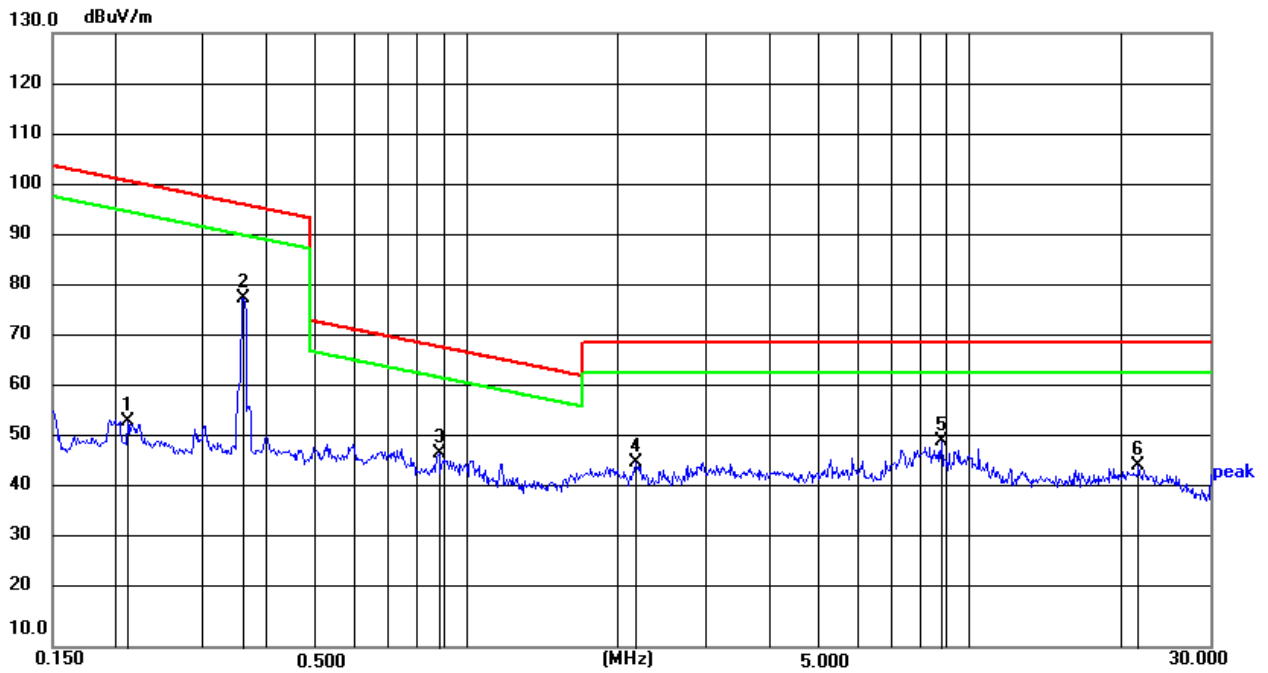

No.	Frequency (MHz)	Reading (dBuV)	Factor (dB/m)	Level (dBuV/m)	Limit (dBuV/m)	Margin (dB)	Det.
1	0.2116	32.49	21.59	54.08	101.09	-47.01	peak
2 *	0.3593	56.50	21.57	78.07	96.49	-18.42	peak
3	0.8800	25.27	22.55	47.82	68.71	-20.89	peak
4	2.1667	23.56	22.43	45.99	69.54	-23.55	peak
5	8.7757	27.49	22.77	50.26	69.54	-19.28	peak
6	21.6001	12.68	32.71	45.39	69.54	-24.15	peak

Note:

Pre-scan in the all of mode, the worst case in of was recorded.

30MHz-1GHz

Temperature:	26°C	Relative Humidity:	54%
Pressure:	101 kPa	Polarization:	Horizontal
Test Voltage:	AC 120V/60Hz		

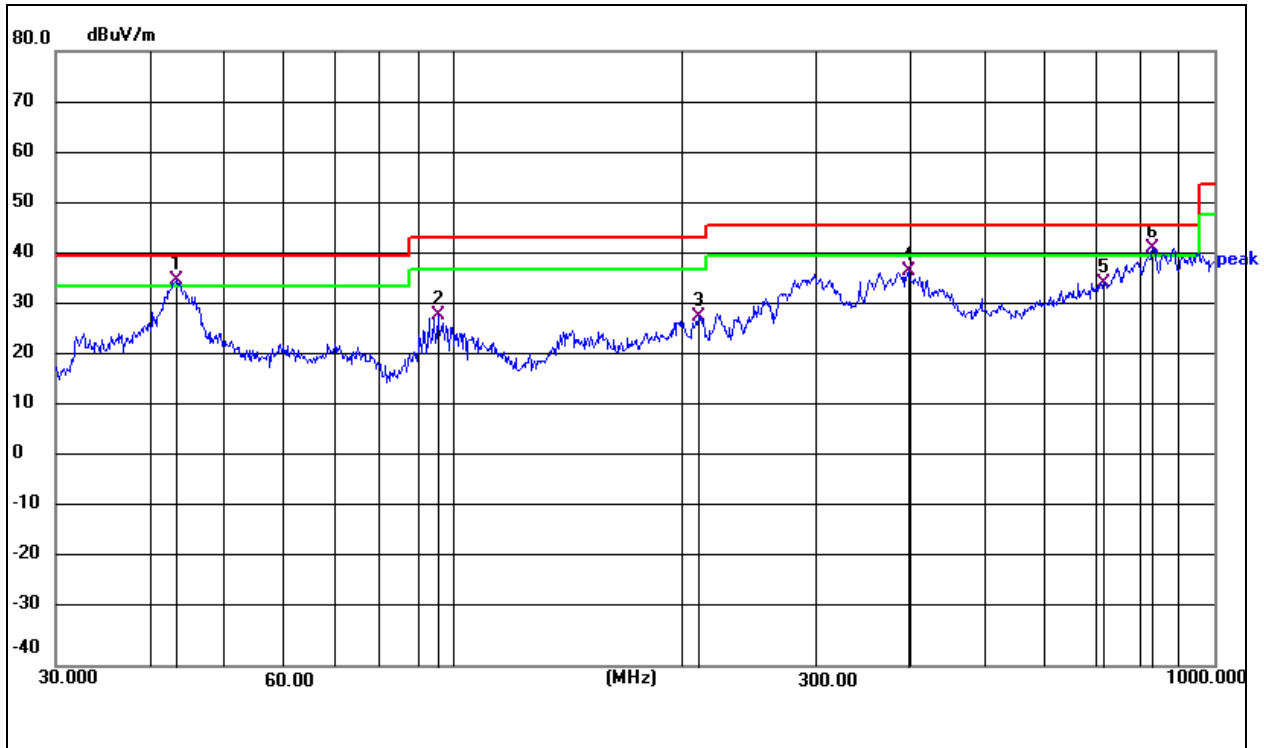

No.	Frequency (MHz)	Reading (dBuV)	Factor (dB/m)	Level (dBuV/m)	Limit (dBuV/m)	Margin (dB)	Det.
1 !	43.3534	48.84	-13.43	35.41	40.00	-4.59	QP
2	95.4270	44.59	-16.18	28.41	43.50	-15.09	QP
3	210.0482	40.50	-12.39	28.11	43.50	-15.39	QP
4	396.2415	51.10	-14.01	37.09	46.00	-8.91	QP
5	716.6820	36.08	-1.33	34.75	46.00	-11.25	QP
6 *	830.4002	41.26	0.38	41.64	46.00	-4.36	QP

Temperature:	26°C	Relative Humidity:	54%
Pressure:	101kPa	Polarization:	Vertical
Test Voltage:	AC 120V/60Hz		

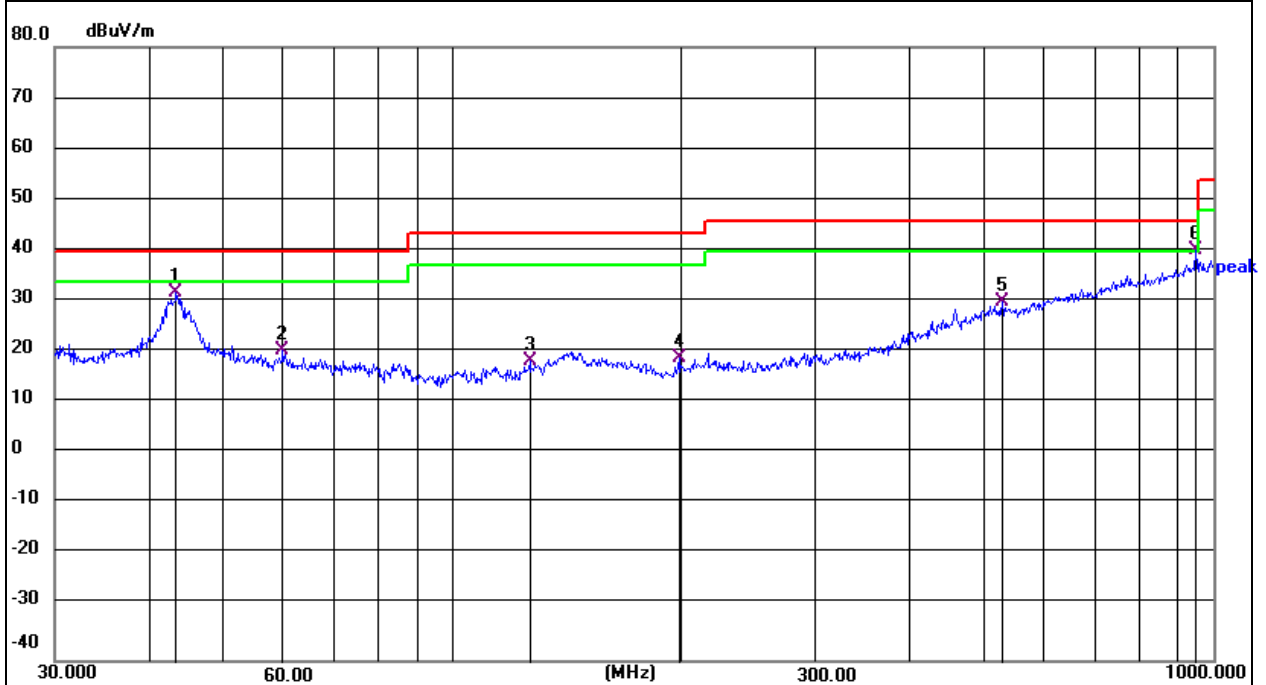

No.	Frequency (MHz)	Reading (dBuV)	Factor (dB/m)	Level (dBuV/m)	Limit (dBuV/m)	Margin (dB)	Det.
1	43.3534	44.87	-12.73	32.14	40.00	-7.86	QP
2	59.8588	35.79	-15.02	20.77	40.00	-19.23	QP
3	126.3286	35.12	-16.57	18.55	43.50	-24.95	QP
4	198.5880	35.27	-16.11	19.16	43.50	-24.34	QP
5	528.2458	35.99	-5.78	30.21	46.00	-15.79	QP
6 *	948.7610	38.92	1.48	40.40	46.00	-5.60	QP

Remarks:

- 1.Emission Level = Reading + Factor;
- 2.Factor = Antenna Factor + Cable Loss – Pre-amplifier;
- 3.Margin= Emission Level - Limit.
- 4.The emission levels of other frequencies are very lower than the limit and not show in test report.

8 BANDWIDTH TEST

8.1 Test Procedure

1. Set RBW = 30Hz.
2. Set the video bandwidth (VBW) $\geq 3 \times$ RBW.
3. Detector = Peak.
4. Trace mode = max hold.
5. Sweep = auto couple.
6. Allow the trace to stabilize.
7. Measure the maximum width of the emission that is constrained by the frequencies associated with the two outermost amplitude points (upper and lower frequencies) that are attenuated by 20 dB relative to the maximum level measured in the fundamental emission.

8.2 Test setup

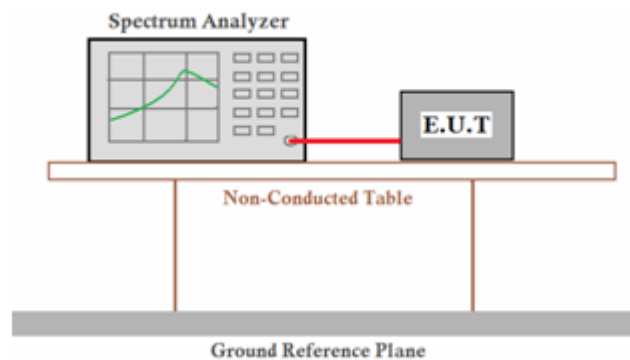

Temperature:	20 °C	Relative Humidity:	44%
Pressure:	101kPa		

Frequency (KHz)	20dB bandwidth (KHz)	99% bandwidth (KHz)	Result
108.7	0.099	-	Pass
132.0	0.088	-	Pass
359.3	0.090	-	Pass

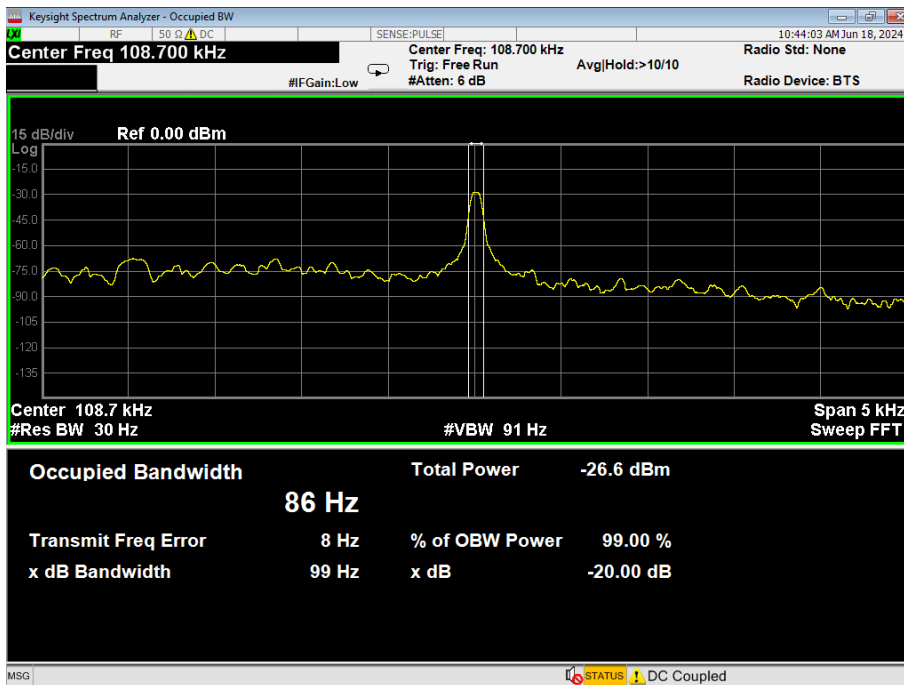

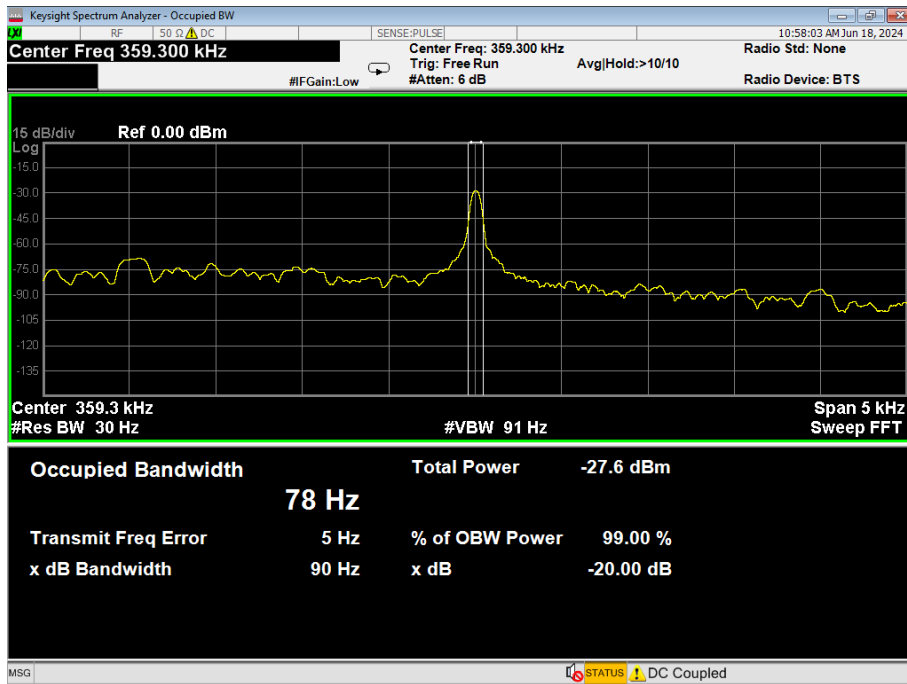
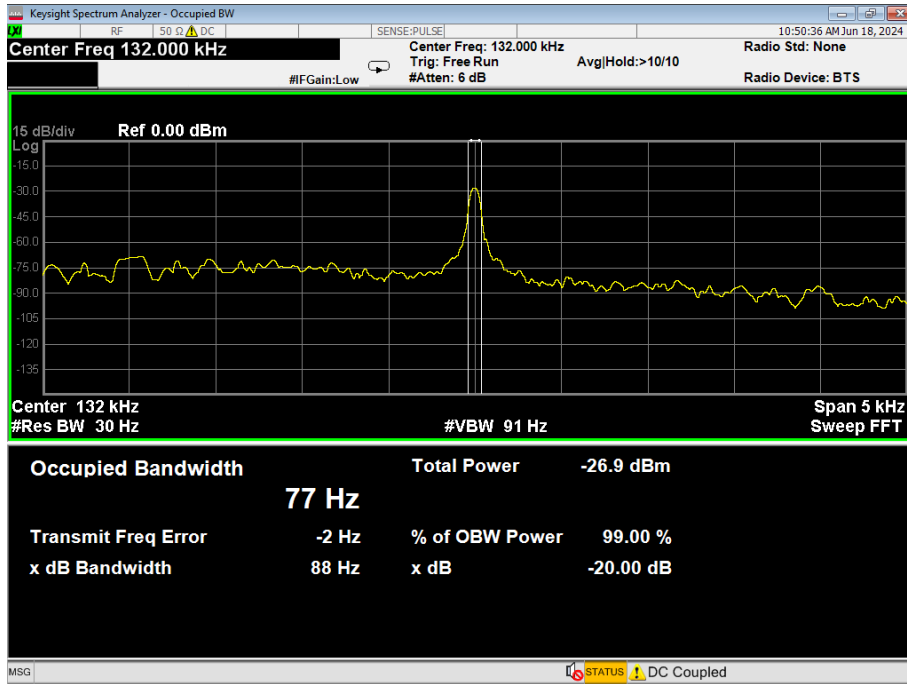

9 ANTENNA REQUIREMENT:

Standard requirement: FCC Part15 C Section 15.203

An intentional radiator shall be designed to ensure that no antenna other than that furnished by the responsible party shall be used with the device. The use of a permanently attached antenna or of an antenna that uses a unique coupling to the intentional radiator, the manufacturer may design the unit so that a broken antenna can be replaced by the user, but the use of a standard antenna jack or electrical connector is prohibited.

EUT Antenna:

The antenna is Inductive loop coil Antenna, the best case gain of the antenna is 0dBi, reference to the appendix for details.

10 Test Setup Photographs of EUT

Please refer to separated files for Test Setup Photos of the EUT.

11 External Photographs of EUT

Please refer to separated files for External Photos of the EUT.

12 Internal Photographs of EUT

Please refer to separated files for Internal Photos of the EUT.

**** End of report ****