



# CTC Laboratories, Inc.

1-2/F., Building 2, Jiaquan Building, Guanlan High-Tech Park, Shenzhen, Guangdong, China  
Tel: +86-755- 27521059 Fax: +86-755- 27521011 Http://www.sz-ctc.org.cn

## TEST REPORT

**Report No.** .....: **CTC20221183E01**

**FCC ID**.....: **2APPZ-X7V2**

**Applicant**.....: **Fanvil Technology Co., LTD.**

Address.....: 10/F Block A, Dualshine Global Science Innovation, Honglang North 2nd Road, Bao'an District, Shenzhen, 518101, China

Manufacturer.....: Fanvil Technology Co., LTD.

Address.....: 10/F Block A, Dualshine Global Science Innovation, Honglang North 2nd Road, Bao'an District, Shenzhen, 518101, China

**Product Name**.....: **IP Phone**

Trade Mark.....: 

Model/Type reference.....: X7 V2

Listed Model(s) .....: X7C V2, X7C, X7

**Standard**.....: **FCC CFR Title 47 Part 15 Subpart C Section 15.247**

Date of receipt of test sample...: Jun. 07, 2022

Date of testing.....: Jun. 08, 2022 ~ Jun. 24, 2022

Date of issue.....: Jun. 25, 2022

**Result**.....: **PASS**

Compiled by:		
(Printed name+signature)	Terry Su	
Supervised by:		
(Printed name+signature)	Eric Zhang	
Approved by:		
(Printed name+signature)	Totti Zhao	

**Testing Laboratory Name**.....: **CTC Laboratories, Inc.**

Address.....: 1-2/F., Building 2, Jiaquan Building, Guanlan High-Tech Park, Shenzhen, Guangdong, China

This test report may be duplicated completely for legal use with the approval of the applicant. It should not be reproduced except in full, without the written approval of our laboratory. The client should not use it to claim product endorsement by CTC. The test results in the report only apply to the tested sample. The test report shall be invalid without all the signatures of testing engineers, reviewer and approver. Any objections must be raised to CTC within 15 days since the date when the report is received. It will not be taken into consideration beyond this limit. The test report merely correspond to the test sample.



Table of Contents

Page

<b>1. TEST SUMMARY</b> .....	<b>3</b>
1.1. TEST STANDARDS .....	3
1.2. REPORT VERSION .....	3
1.3. TEST DESCRIPTION .....	4
1.4. TEST FACILITY .....	5
1.5. MEASUREMENT UNCERTAINTY .....	5
1.6. ENVIRONMENTAL CONDITIONS .....	6
<b>2. GENERAL INFORMATION</b> .....	<b>7</b>
2.1. CLIENT INFORMATION .....	7
2.2. GENERAL DESCRIPTION OF EUT .....	7
2.3. ACCESSORY EQUIPMENT INFORMATION.....	8
2.4. OPERATION STATE .....	9
2.5. MEASUREMENT INSTRUMENTS LIST .....	10
<b>3. TEST ITEM AND RESULTS</b> .....	<b>12</b>
3.1. CONDUCTED EMISSION .....	12
3.2. RADIATED EMISSION.....	15
3.3. BAND EDGE EMISSIONS (RADIATED).....	37
3.4. BAND EDGE AND SPURIOUS EMISSIONS (CONDUCTED) .....	50
3.5. 20DB BANDWIDTH .....	65
3.6. CHANNEL SEPARATION .....	69
3.7. NUMBER OF HOPPING CHANNEL .....	72
3.8. DWELL TIME .....	74
3.9. PEAK OUTPUT POWER.....	79
3.10. DUTY CYCLE.....	83
3.11. ANTENNA REQUIREMENT .....	87



# 1. TEST SUMMARY

## 1.1. Test Standards

The tests were performed according to following standards:

[FCC Rules Part 15.247](#): Operation within the bands of 902-928MHz, 2400-2483.5MHz, and 5725-5850MHz.

[RSS 247 Issue 2](#): Standard Specifications for Frequency Hopping Systems (FHSs) and Digital Transmission Systems (DTSs) Operating in the Bands 902-928MHz, 2400-2483.5MHz and 5725-5850MHz.

[ANSI C63.10-2013](#): American National Standard for Testing Unlicensed Wireless Devices.

## 1.2. Report version

Revised No.	Date of issue	Description
01	Jun. 25, 2022	Original



### 1.3. Test Description

FCC Part 15 Subpart C (15.247)/ RSS 247 Issue 2				
Test Item	Standard Section		Result	Test Engineer
	FCC	IC		
Antenna Requirement	15.203	/	Pass	Alicia Liu
Conducted Emission	15.207	RSS-Gen 8.8	Pass	Ice Lu
Restricted Bands	15.205	RSS-Gen 8.10	Pass	Alicia Liu
Hopping Channel Separation	15.247(a)(1)	RSS 247 5.1 (b)	Pass	Alicia Liu
Dwell Time	15.247(a)(iii)	RSS 247 5.1 (d)	Pass	Alicia Liu
Peak Output Power	15.247(b)(1)	RSS 247 5.4 (b)	Pass	Alicia Liu
Number of Hopping Frequency	15.247(a)(iii)	RSS 247 5.1 (d)	Pass	Alicia Liu
Conducted Band Edge and Spurious Emissions	15.247(d)	RSS 247 5.5	Pass	Alicia Liu
Radiated Band Edge and Spurious Emissions	15.205&15.209&15.247(d)	RSS 247 5.5	Pass	Alicia Liu
Radiated Spurious Emission	15.247(d)&15.209	RSS 247 5.5&RSS-Gen 8.9	Pass	Alicia Liu
20dB Bandwidth	15.247(a)	RSS 247 5.1 (b)	Pass	Alicia Liu

Note: The measurement uncertainty is not included in the test result.



## 1.4. Test Facility

### CTC Laboratories, Inc.

Add: 1-2/F., Building 2, Jiaquan Building, Guanlan High-Tech Park, Shenzhen, Guangdong, China

### Laboratory accreditation

The test facility is recognized, certified, or accredited by the following organizations:

#### **A2LA-Lab Cert. No.: 4340.01**

CTC Laboratories, Inc. EMC Laboratory has been accredited by A2LA for technical competence in the field of electrical testing, and proved to be in compliance with ISO/IEC 17025:2017 General Requirements for the Competence of Testing and Calibration Laboratories and any additional program requirements in the identified field of testing.

#### **Industry Canada (Registration No.: 9783A, CAB Identifier: CN0029)**

CTC Laboratories, Inc. EMC Laboratory has been registered by Certification and Engineer Bureau of Industry Canada for the performance of with Registration NO.: 9783A on Jan, 2016.

#### **FCC (Registration No.: 951311, Designation Number CN1208)**

CTC Laboratories, Inc. EMC Laboratory has been registered and fully described in a report filed with the (FCC) Federal Communications Commission. The acceptance letter from the FCC is maintained in our files. Registration 951311, Aug 26, 2017.

## 1.5. Measurement Uncertainty

The data and results referenced in this document are true and accurate. The reader is cautioned that there may be errors within the calibration limits of the equipment and facilities. The measurement uncertainty was calculated for all measurements listed in this test report acc. to TR-100028-01 "Electromagnetic compatibility and Radio spectrum Matters (ERM); Uncertainties in the measurement of mobile radio equipment characteristics; Part 1" and TR-100028-02 "Electromagnetic compatibility and Radio spectrum Matters (ERM); Uncertainties in the measurement of mobile radio equipment characteristics; Part 2" and is documented in the CTC Laboratories, Inc. quality system acc. to DIN EN ISO/IEC 17025. Furthermore, component and process variability of devices similar to that tested may result in additional deviation. The manufacturer has the sole responsibility of continued compliance of the device.

Below is the best measurement capability for CTC Laboratories, Inc.



Test Items	Measurement Uncertainty	Notes
Transmitter power conducted	0.42 dB	(1)
Transmitter power Radiated	2.14 dB	(1)
Conducted spurious emissions 9kHz~40GHz	1.60 dB	(1)
Radiated spurious emissions 9kHz~40GHz	2.20 dB	(1)
Conducted Emissions 9kHz~30MHz	3.08 dB	(1)
Radiated Emissions 30~1000MHz	4.51 dB	(1)
Radiated Emissions 1~18GHz	5.84 dB	(1)
Radiated Emissions 18~40GHz	6.12 dB	(1)
Occupied Bandwidth	-----	(1)

**Note (1):** This uncertainty represents an expanded uncertainty expressed at approximately the 95% confidence level using a coverage factor of  $k=1.96$ .

## 1.6. Environmental conditions

During the measurement the environmental conditions were within the listed ranges:

Temperature:	21°C ~ 27°C
Relative Humidity:	40% ~ 60%
Air Pressure:	101kPa



## 2. GENERAL INFORMATION

### 2.1. Client Information

Applicant:	Fanvil Technology Co., LTD.
Address:	10/F Block A, Dualshine Global Science Innovation, Honglang North 2nd Road, Bao'an District, Shenzhen, 518101, China
Manufacturer:	Fanvil Technology Co., LTD.
Address:	10/F Block A, Dualshine Global Science Innovation, Honglang North 2nd Road, Bao'an District, Shenzhen, 518101, China

### 2.2. General Description of EUT

Product Name:	IP Phone
Trade Mark:	
Model/Type reference:	X7 V2
Listed Model(s):	X7C V2, X7C, X7
Model Difference:	All these models are identical in the same PCB, Layout and electrical circuit, The only difference is screen size and model name.
Power supply:	5Vdc/2A from external power supply 48Vdc/0.3A from POE
Hardware version:	2.0
Software version:	2.12.1.3
Test sample NO.:	CTC220422-058
<b>Bluetooth 5.0/EDR</b>	
Modulation:	GFSK, $\pi/4$ -DQPSK, 8-DPSK
Operation frequency:	2402MHz~2480MHz
Channel number:	79
Channel separation:	1MHz
Antenna type:	FPC Antenna
Antenna gain:	2.6dBi



## 2.3. Accessory Equipment information

Equipment Information			
Name	Model	S/N	Manufacturer
Notebook	ThinkBook 14G3 ACL	MP246QDR	Lenovo
AC/DC Adapter	F12W8-050200SPAU	/	FRECOM

Cable Information			
Name	Shielded Type	Ferrite Core	Length
DC Out Cable	Without	Without	1.5M

Test Software Information			
Name			
SecureCRT.exe	8.7.1	/	/





### 2.4. Operation state

Operation Frequency List: The EUT has been tested under typical operating condition. The Applicant provides communication tools software to control the EUT for staying in continuous transmitting and receiving mode for testing. BT EDR, 79 channels are provided to the EUT. Channels 00/39/78 were selected for testing.

Operation Frequency List:

Channel	Frequency (MHz)
<b>00</b>	<b>2402</b>
01	2403
⋮	⋮
38	2440
<b>39</b>	<b>2441</b>
40	2442
⋮	⋮
77	2479
<b>78</b>	<b>2480</b>

Note: The display in grey were the channel selected for testing.

#### Test mode

For RF test items:
The engineering test program was provided and enabled to make EUT continuous transmit
For AC power line conducted emissions:
The EUT was set to connect with the Bluetooth instrument under large package sizes transmission.
For Radiated spurious emissions test item:
The engineering test program was provided and enabled to make EUT continuous transmit. The EUT in each of three orthogonal axis emissions had been tested, but only the worst case (X axis) data recorded in the report.



## 2.5. Measurement Instruments List

Tonscend JS0806-2 Test system					
Item	Test Equipment	Manufacturer	Model No.	Serial No.	Calibrated until
1	Spectrum Analyzer	Rohde & Schwarz	FSU26	100105	Dec. 23, 2022
2	Spectrum Analyzer	Rohde & Schwarz	FUV40-N	101331	Mar. 15, 2023
3	MXG Vector Signal Generator	Agilent	N5182A	MY47420864	Dec. 23, 2022
4	Signal Generator	Agilent	E8257D	MY46521908	Dec. 23, 2022
5	Power Sensor	Agilent	U2021XA	MY5365004	Mar. 15, 2023
6	Power Sensor	Agilent	U2021XA	MY5365006	Mar. 15, 2023
7	High and low temperature box	ESPEC	MT3035	N/A	Mar. 15, 2023
8	Wideband Radio Communication Tester	Rohde & Schwarz	CMW500	102414	Dec. 23, 2022
9	300328 v2.2.2 test system	TONSCEND	v2.6	/	/

Radiated emission(3m chamber 2)					
Item	Test Equipment	Manufacturer	Model No.	Serial No.	Calibrated Until
1	Trilog-Broadband Antenna	Schwarzbeck	VULB 9168	9168-1013	Jan. 12, 2023
2	Horn Antenna	Schwarzbeck	BBHA 9120D	9120D-647	Dec. 23, 2022
3	Loop Antenna	LAPLAC	RF300	9138	Dec. 23, 2022
4	Spectrum Analyzer	R&S	FSU26	100105	Dec. 23, 2022
5	Spectrum Analyzer	R&S	FSV40-N	101331	Mar. 15, 2023
6	Pre-Amplifier	SONOMA	310	186194	Dec. 23, 2022
7	Low Noise Pre-Amplifier	EMCI	EMC051835	980075	Dec. 23, 2022
8	Test Receiver	R&S	ESCI7	100967	Dec. 23, 2022
9	3m chamber 2	Frankonia	EE025	/	Oct. 23, 2024

Radiated emission(3m chamber 3)					
Item	Test Equipment	Manufacturer	Model No.	Serial No.	Calibrated Until
1	Trilog-Broadband Antenna	Schwarzbeck	VULB 9168	9168-759	Nov. 09, 2022
2	Horn Antenna	Schwarzbeck	BBHA 9120D	9120D-647	Dec. 23, 2022
3	Test Receiver	Keysight	N9038A	MY56400071	Dec. 23, 2022
4	Broadband Premplifier	SCHWARZBECK	BBV9743B	259	Dec. 23, 2022
5	Mirowave Broadband Amplifier	SCHWARZBECK	BBV9718C	111	Dec. 23, 2022
6	3m chamber 3	YIHENG	EE106	/	Sep. 09, 2023

CTC Laboratories, Inc.

1-2/F., Building 2, Jiaquan Building, Guanlan High-Tech Park, Shenzhen, Guangdong, China

Tel.: (86)755-27521059

Fax: (86)755-27521011

Http://www.sz-ctc.org.cn



For anti-fake verification, please visit the official website of Certification and Accreditation Administration of the People's Republic of China : [yz.cnca.cn](http://yz.cnca.cn)



Conducted Emission					
Item	Test Equipment	Manufacturer	Model No.	Serial No.	Calibrated until
1	LISN	R&S	ENV216	101112	Dec. 23, 2022
2	LISN	R&S	ENV216	101113	Dec. 23, 2022
3	EMI Test Receiver	R&S	ESCS30	100353	Dec. 23, 2022

Note: 1. The Cal. Interval was one year.

2. The Cal. Interval was three year of the chamber

3. The cable loss has calculated in test result which connection between each test instruments.

### 3. TEST ITEM AND RESULTS

#### 3.1. Conducted Emission

**Limit**

FCC CFR Title 47 Part 15 Subpart C Section 15.207/ RSS – Gen 8.8

Frequency range (MHz)	Limit (dBuV)	
	Quasi-peak	Average
0.15-0.5	66 to 56*	56 to 46*
0.5-5	56	46
5-30	60	50

\* Decreases with the logarithm of the frequency.

**Test Configuration**

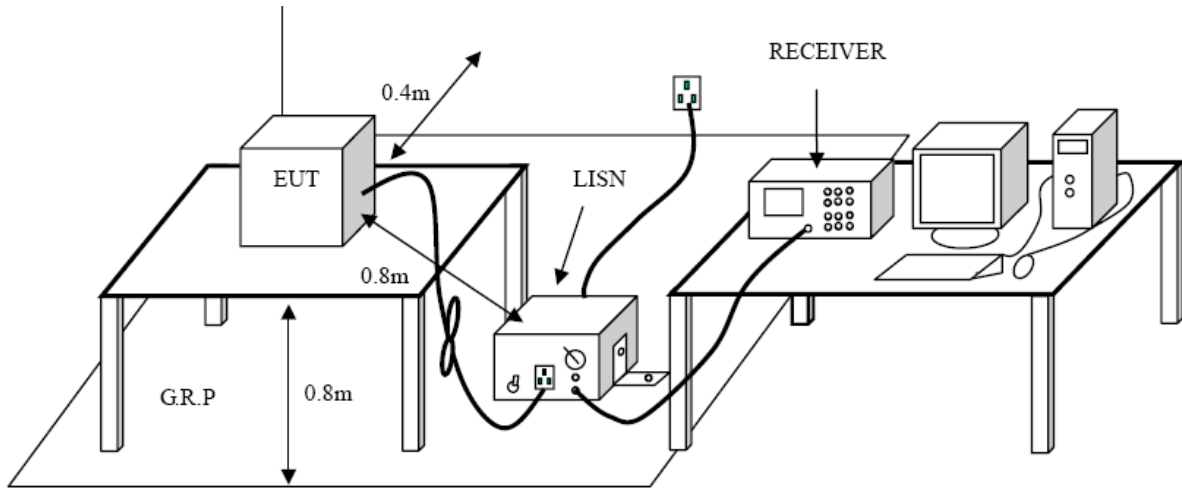

**Test Procedure**

1. The EUT was setup according to ANSI C63.10:2013 requirements.
2. The EUT was placed on a platform of nominal size, 1 m by 1.5 m, raised 80 cm above the conducting ground plane. The vertical conducting plane was located 40 cm to the rear of the EUT. All other surfaces of EUT were at least 80 cm from any other grounded conducting surface.
3. The EUT and simulators are connected to the main power through a line impedances stabilization network (LISN). The LISN provides a 50ohm /50uH coupling impedance for the measuring equipment. The peripheral devices are also connected to the main power through a LISN. (Please refer to the block diagram of the test setup and photographs)
4. Each current-carrying conductor of the EUT power cord, except the ground (safety) conductor, was individually connected through a LISN to the input power source.
5. The excess length of the power cord between the EUT and the LISN receptacle were folded back and forth at the center of the lead to form a bundle not exceeding 40 cm in length.
6. Conducted Emissions were investigated over the frequency range from 0.15MHz to 30MHz using a receiver bandwidth of 9 kHz.
7. During the above scans, the emissions were maximized by cable manipulation.

**Test Mode**

Please refer to the clause 2.4.



**Test Results**

<b>Test Voltage:</b>	AC 120V/60 Hz
<b>Terminal:</b>	Line

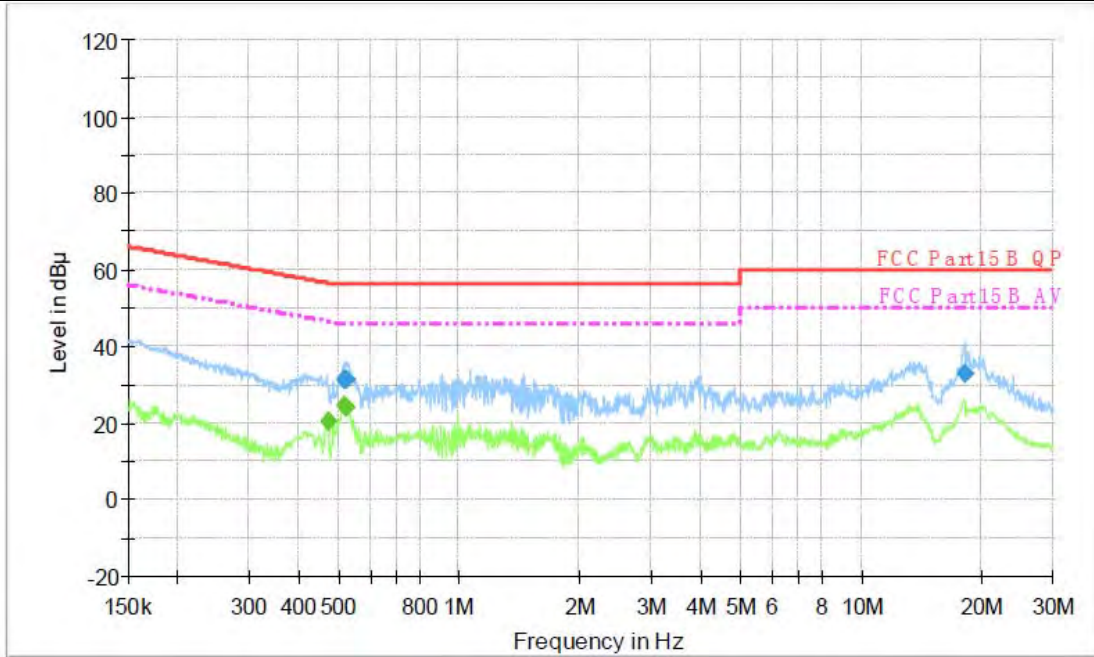

**Final Measurement Detector 1**

Frequency (MHz)	QuasiPeak (dBu V)	Meas. Time (ms)	Bandwidth (kHz)	Filter	Line	Corr. (dB)	Margin (dB)	Limit (dBu V)	Comment
0.517060	31.1	1000.00	9.000	On	L1	9.7	24.9	56.0	
0.525380	31.5	1000.00	9.000	On	L1	9.7	24.5	56.0	
18.197610	32.9	1000.00	9.000	On	L1	9.9	27.1	60.0	

**Final Measurement Detector 2**

Frequency (MHz)	Average (dBu V)	Meas. Time (ms)	Bandwidth (kHz)	Filter	Line	Corr. (dB)	Margin (dB)	Limit (dBu V)	Comment
0.471700	20.6	1000.00	9.000	On	L1	9.7	25.9	46.5	
0.517060	24.5	1000.00	9.000	On	L1	9.7	21.5	46.0	
0.525380	24.3	1000.00	9.000	On	L1	9.7	21.7	46.0	

Emission Level= Read Level+ Correct Factor





<b>Test Voltage:</b>	AC 120V/60 Hz
<b>Terminal:</b>	Neutral

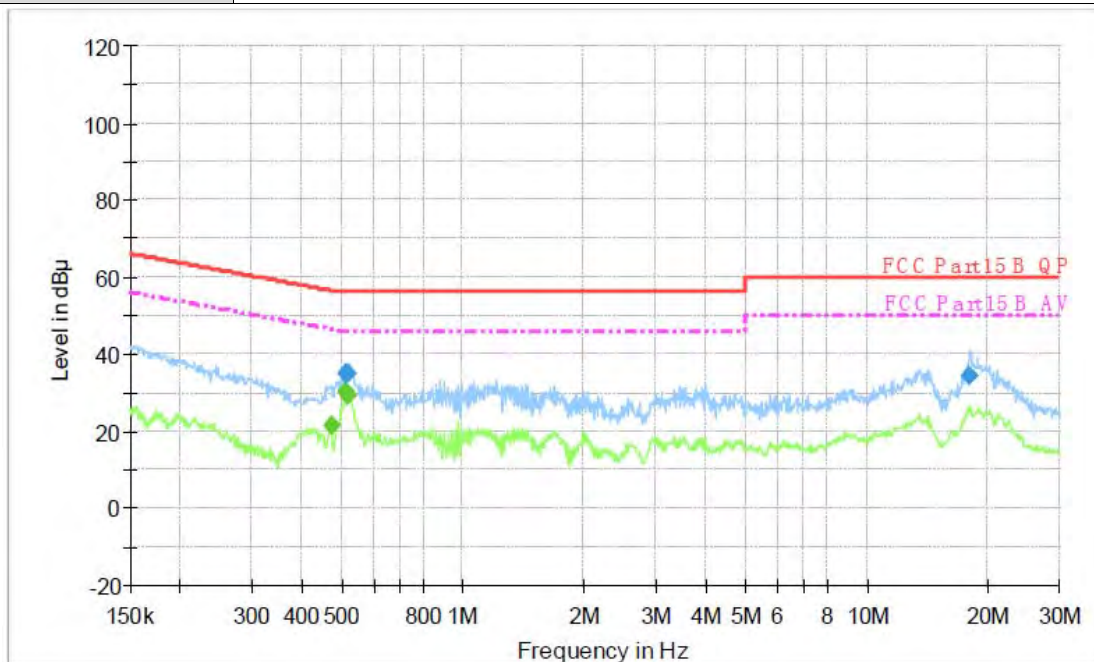

### Final Measurement Detector 1

Frequency (MHz)	QuasiPeak (dBµ V)	Meas. Time (ms)	Bandwidth (kHz)	Filter	Line	Corr. (dB)	Margin (dB)	Limit (dBµ V)	Comment
0.515000	35.0	1000.00	9.000	On	N	10.0	21.0	56.0	
0.521210	34.8	1000.00	9.000	On	N	10.0	21.2	56.0	
18.052900	34.2	1000.00	9.000	On	N	10.0	25.8	60.0	

### Final Measurement Detector 2

Frequency (MHz)	Average (dBµ V)	Meas. Time (ms)	Bandwidth (kHz)	Filter	Line	Corr. (dB)	Margin (dB)	Limit (dBµ V)	Comment
0.471700	21.4	1000.00	9.000	On	N	10.0	25.1	46.5	
0.515000	30.0	1000.00	9.000	On	N	10.0	16.0	46.0	
0.521210	29.5	1000.00	9.000	On	N	10.0	16.5	46.0	

Emission Level= Read Level+ Correct Factor



### 3.2. Radiated Emission

**Limit**

FCC CFR Title 47 Part 15 Subpart C Section 15.209/ RSS – Gen 8.9

Frequency	Limit (dBuV/m @3m)	Value
30 MHz ~ 88 MHz	40.00	Quasi-peak
88 MHz ~ 216 MHz	43.50	Quasi-peak
216 MHz ~ 960 MHz	46.00	Quasi-peak
960 MHz ~ 1 GHz	54.00	Quasi-peak
Above 1 GHz	54.00	Average
	74.00	Peak

**Note:**

- (1) The tighter limit applies at the band edges.
- (2) Emission Level (dBuV/m)=20log Emission Level (uV/m).

**Test Configuration**

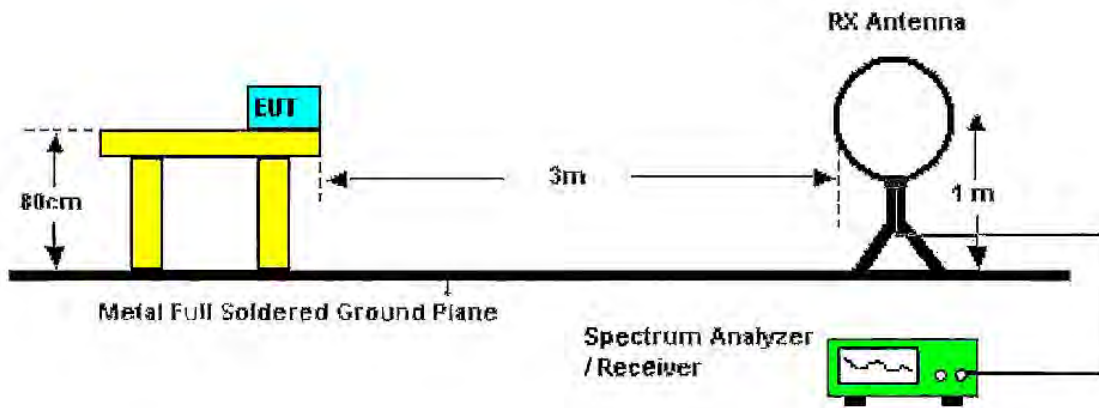

Below 30MHz Test Setup

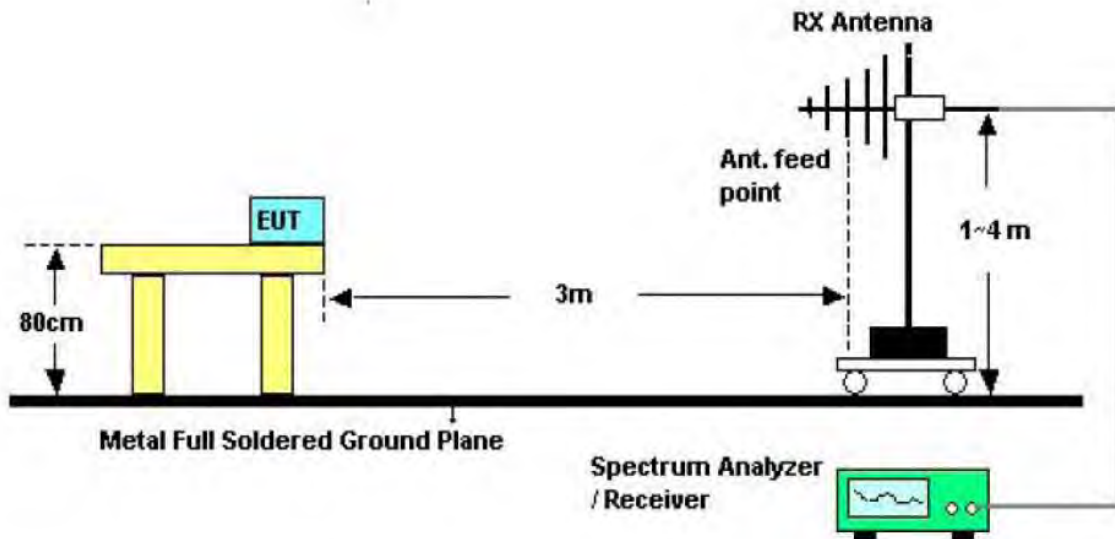

Below 1000MHz Test Setup

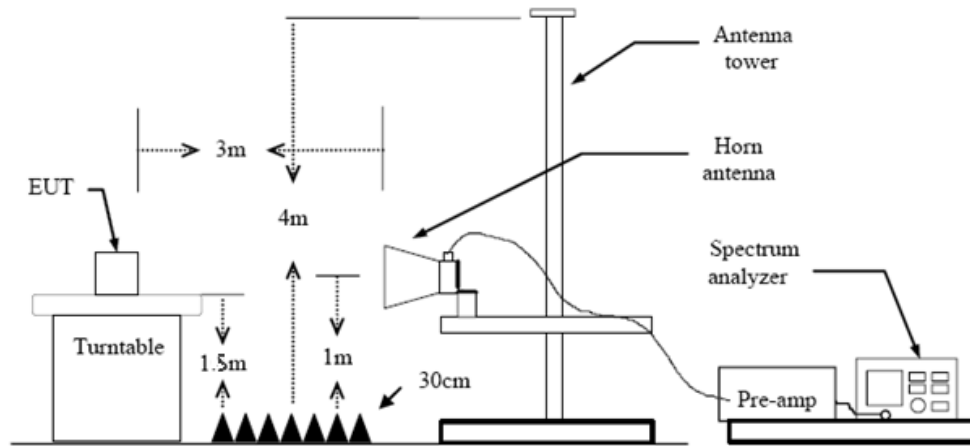

Above 1GHz Test Setup

### Test Procedure

1. The EUT was setup and tested according to ANSI C63.10:2013
2. The EUT is placed on a turn table which is 0.8 meter above ground for below 1 GHz, and 1.5 m for above 1 GHz. The turn table is rotated 360 degrees to determine the position of the maximum emission level.
3. The EUT was set 3 meters from the receiving antenna, which was mounted on the top of a variable height antenna tower.
4. For each suspected emission, the EUT was arranged to its worst case and then tune the Antenna tower (from 1 m to 4 m) and turntable (from 0 degree to 360 degrees) to find the maximum reading. A pre-amp and a high pass filter are used for the test in order to get better signal level to comply with the guidelines.
5. Set to the maximum power setting and enable the EUT transmit continuously.
6. Use the following spectrum analyzer settings
  - (1) Span shall wide enough to fully capture the emission being measured;
  - (2) Below 1 GHz:  
RBW=120 kHz, VBW=300 kHz, Sweep=auto, Detector function=peak, Trace=max hold;  
If the emission level of the EUT measured by the peak detector is 3 dB lower than the applicable limit, the peak emission level will be reported. Otherwise, the emission measurement will be repeated using the quasi-peak detector and reported.
  - (3) From 1 GHz to 10<sup>th</sup> harmonic:  
RBW=1MHz, VBW=3MHz Peak detector for Peak value.  
RBW=1MHz, VBW $\geq$ 1/T Peak detector for Average value.Note 1: For the 1/T & Duty Cycle please refer to clause 3.10 Duty Cycle.

### Test Mode

Please refer to the clause 2.4.

### Test Result

#### **9 KHz~30 MHz**

From 9 KHz to 30 MHz: Conclusion: PASS

Note: The amplitude of spurious emissions which are attenuated by more than 20dB below the permissible value has no need to be reported.





30MHz-1GHz

<b>Ant. Pol.</b>	Horizontal
<b>Test Mode:</b>	TX GFSK Mode 2402MHz
<b>Remark:</b>	Only worse case is reported

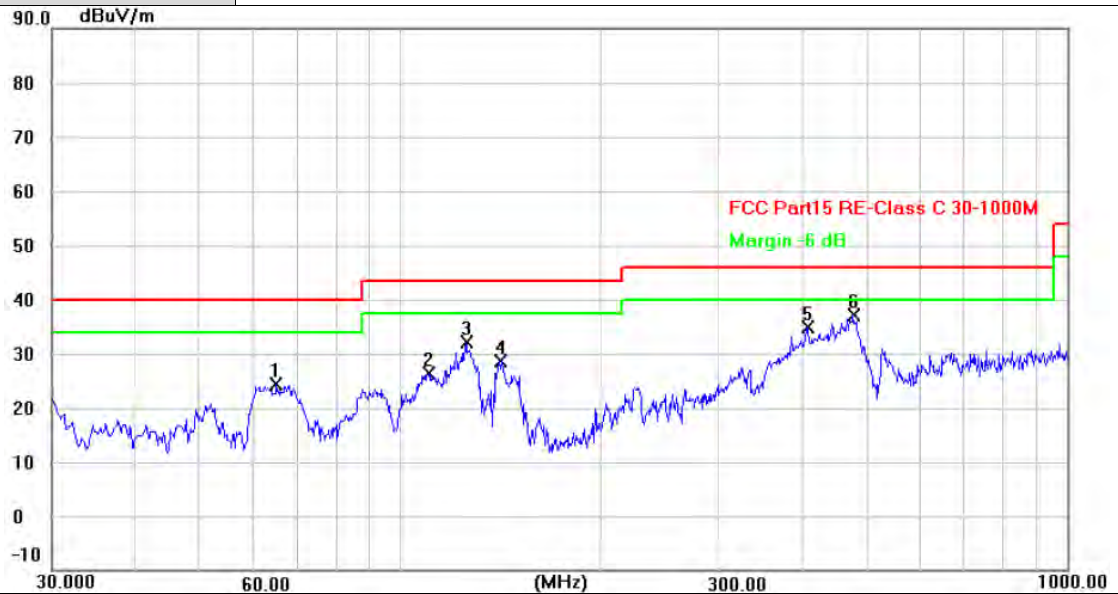

No.	Frequency (MHz)	Reading (dBuV)	Factor (dB/m)	Level (dBuV/m)	Limit (dBuV/m)	Margin (dB)	Detector
1	65.2433	41.54	-17.25	24.29	40.00	-15.71	peak
2	110.5100	42.81	-16.51	26.30	43.50	-17.20	peak
3	125.7066	51.01	-18.92	32.09	43.50	-11.41	peak
4	141.2266	48.55	-19.95	28.60	43.50	-14.90	peak
5	407.9766	45.78	-10.91	34.87	46.00	-11.13	peak
6 *	477.8166	46.72	-9.60	37.12	46.00	-8.88	peak

Remarks:  
 1. Factor (dB/m) = Antenna Factor (dB/m)+Cable Factor (dB)-Pre-amplifier Factor  
 2. Margin value = Level -Limit value



Ant. Pol.	Vertical
Test Mode:	TX GFSK Mode 2402MHz
Remark:	Only worse case is reported



No.	Frequency (MHz)	Reading (dBuV)	Factor (dB/m)	Level (dBuV/m)	Limit (dBuV/m)	Margin (dB)	Detector
1	38.0833	45.01	-15.23	29.78	40.00	-10.22	peak
2	52.3100	44.73	-14.68	30.05	40.00	-9.95	peak
3	65.5667	49.89	-17.34	32.55	40.00	-7.45	peak
4 *	85.9367	51.82	-18.97	32.85	40.00	-7.15	peak
5	426.7300	46.47	-10.56	35.91	46.00	-10.09	peak
6	446.1300	48.01	-10.19	37.82	46.00	-8.18	peak

Remarks:

- Factor (dB/m) = Antenna Factor (dB/m)+Cable Factor (dB)-Pre-amplifier Factor
- Margin value = Level -Limit value



Above 1GHz

<b>Ant. Pol.</b>	Horizontal
<b>Test Mode:</b>	TX GFSK Mode 2402MHz
<b>Remark:</b>	No report for the emission which more than 10 dB below the pre-scribed limit.

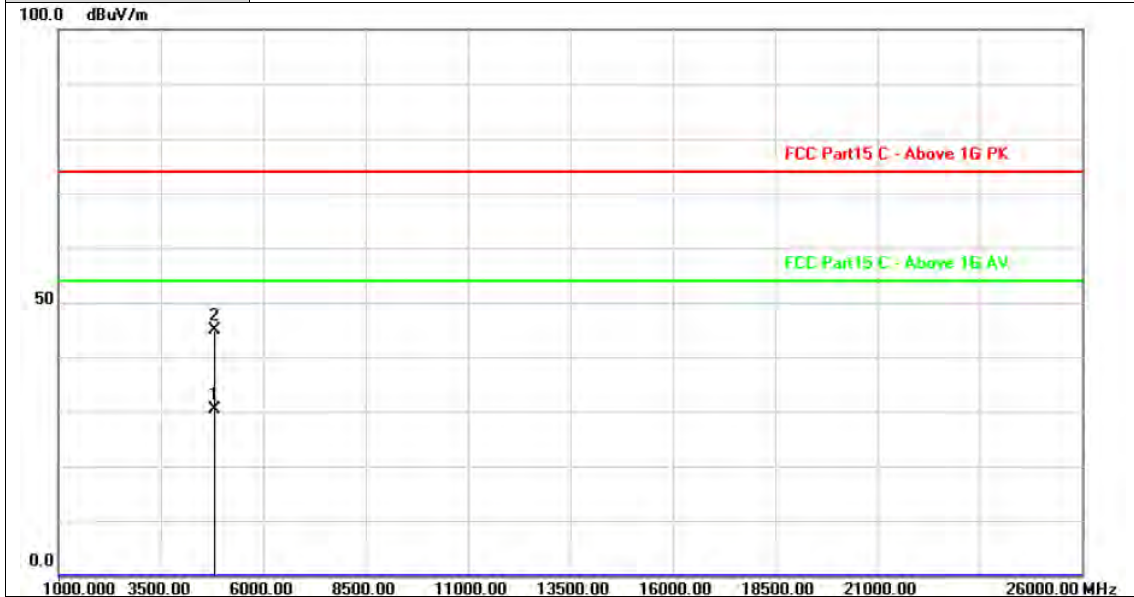

No.	Frequency (MHz)	Factor (dB/m)	Reading (dBuV)	Level (dBuV/m)	Limit (dBuV/m)	Margin (dB)	Detector
1	4804.035	2.56	27.91	30.47	54.00	-23.53	AVG
2	4804.326	2.56	42.21	44.77	74.00	-29.23	peak

Remarks:  
 1. Factor (dB/m) = Antenna Factor (dB/m)+Cable Factor (dB)-Pre-amplifier Factor  
 2. Margin value = Level -Limit value



<b>Ant. Pol.</b>	Vertical
<b>Test Mode:</b>	TX GFSK Mode 2402MHz
<b>Remark:</b>	No report for the emission which more than 10 dB below the pre-scribed limit.

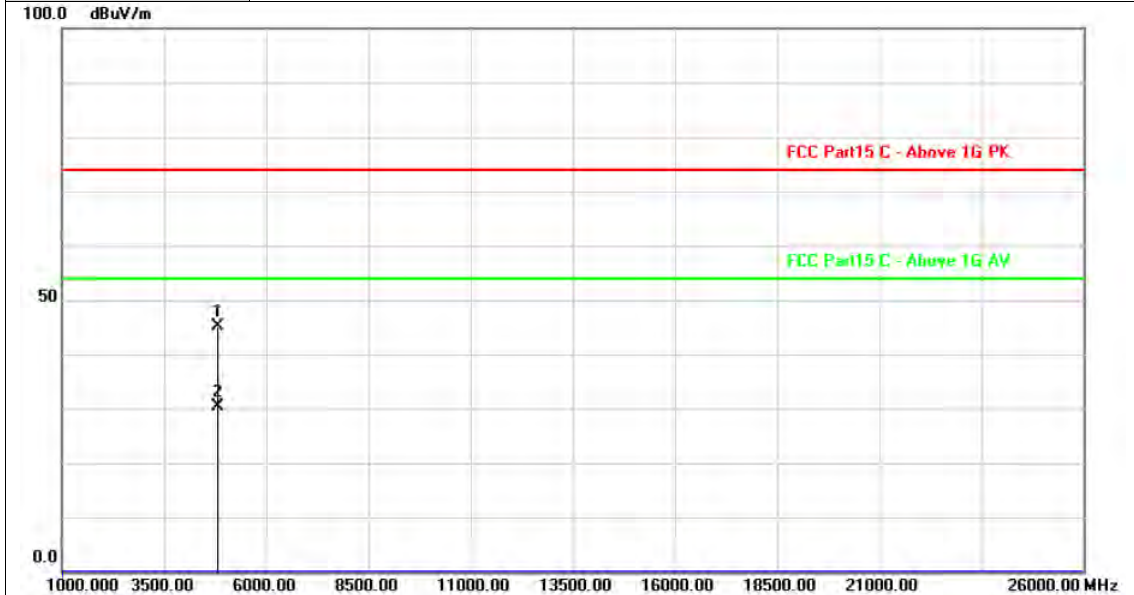

No.	Frequency (MHz)	Factor (dB/m)	Reading (dBuV)	Level (dBuV/m)	Limit (dBuV/m)	Margin (dB)	Detector
1	4804.032	2.56	42.61	45.17	74.00	-28.83	peak
2	4804.068	2.56	27.88	30.44	54.00	-23.56	AVG

Remarks:  
 1. Factor (dB/m) = Antenna Factor (dB/m)+Cable Factor (dB)-Pre-amplifier Factor  
 2. Margin value = Level -Limit value



<b>Ant. Pol.</b>	Horizontal
<b>Test Mode:</b>	TX GFSK Mode 2441MHz
<b>Remark:</b>	No report for the emission which more than 10 dB below the pre-scribed limit.

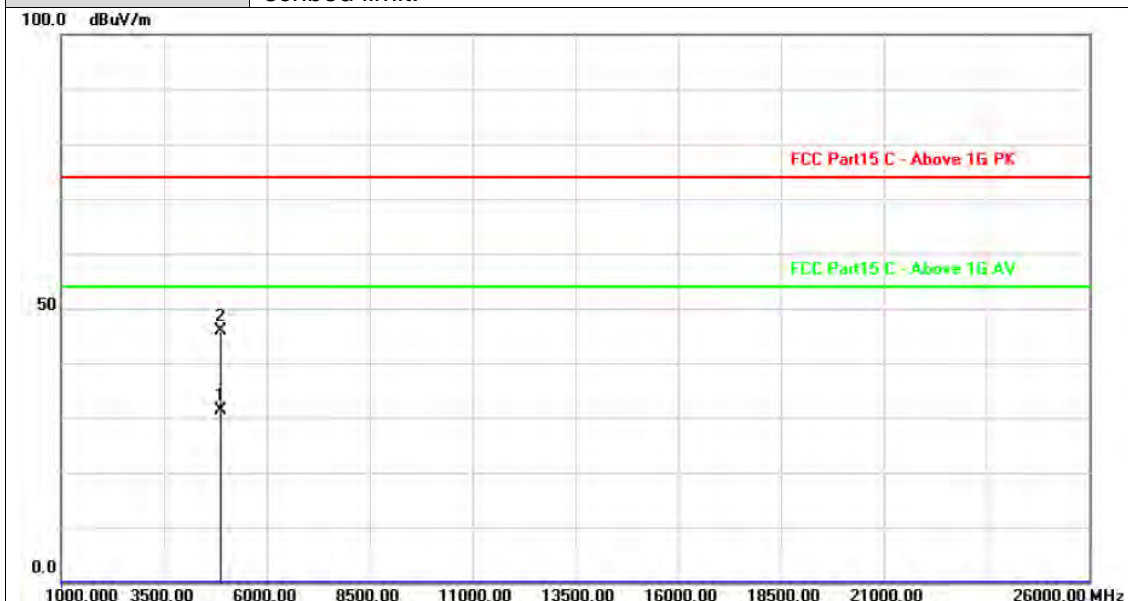

No.	Frequency (MHz)	Factor (dB/m)	Reading (dBuV)	Level (dBuV/m)	Limit (dBuV/m)	Margin (dB)	Detector
1	4881.999	2.79	28.68	31.47	54.00	-22.53	AVG
2	4882.003	2.79	43.05	45.84	74.00	-28.16	peak

Remarks:

- Factor (dB/m) = Antenna Factor (dB/m)+Cable Factor (dB)-Pre-amplifier Factor
- Margin value = Level -Limit value



<b>Ant. Pol.</b>	Vertical
<b>Test Mode:</b>	TX GFSK Mode 2441MHz
<b>Remark:</b>	No report for the emission which more than 10 dB below the pre-scribed limit.

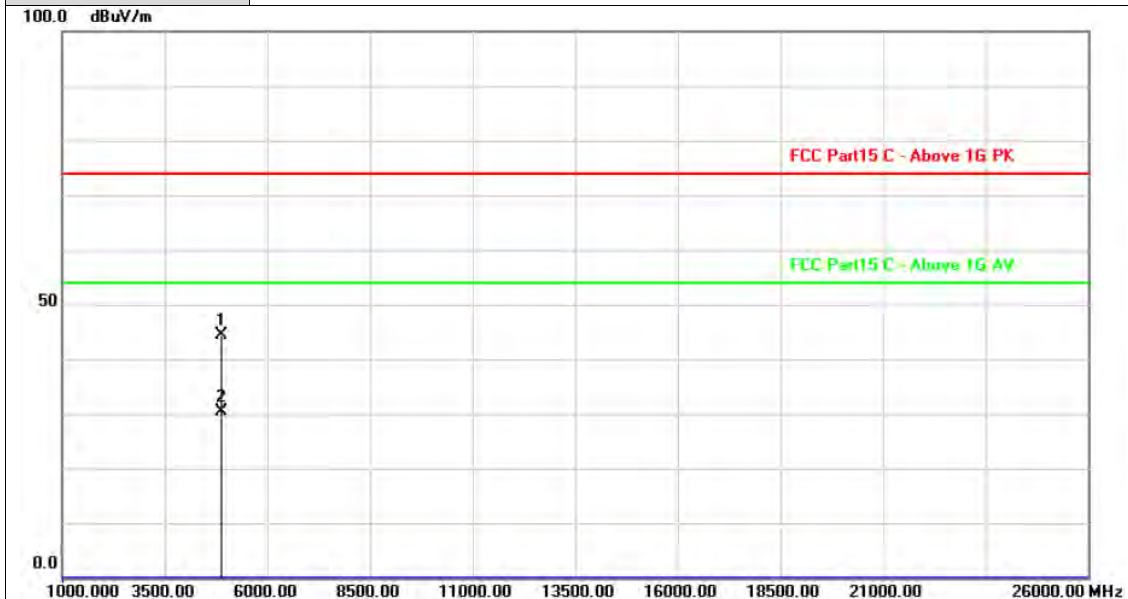

No.	Frequency (MHz)	Factor (dB/m)	Reading (dBuV)	Level (dBuV/m)	Limit (dBuV/m)	Margin (dB)	Detector
1	4881.752	2.79	41.52	44.31	74.00	-29.69	peak
2	4882.361	2.79	27.68	30.47	54.00	-23.53	AVG

Remarks:  
 1. Factor (dB/m) = Antenna Factor (dB/m)+Cable Factor (dB)-Pre-amplifier Factor  
 2. Margin value = Level -Limit value





<b>Ant. Pol.</b>	Horizontal
<b>Test Mode:</b>	TX GFSK Mode 2480MHz
<b>Remark:</b>	No report for the emission which more than 10 dB below the pre-scribed limit.

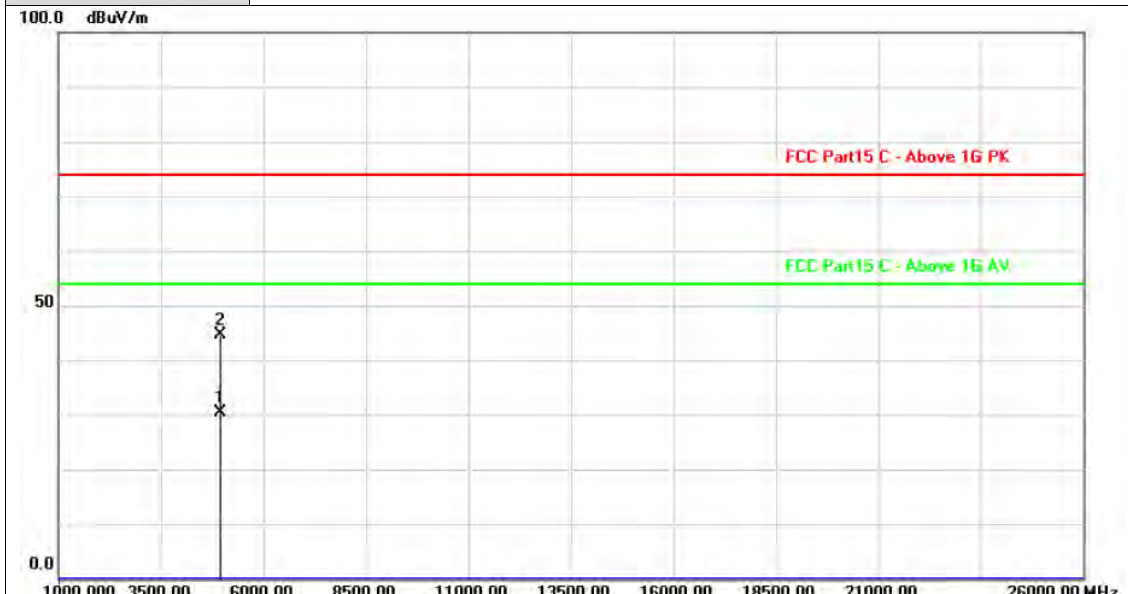

No.	Frequency (MHz)	Factor (dB/m)	Reading (dBuV)	Level (dBuV/m)	Limit (dBuV/m)	Margin (dB)	Detector
1	4959.969	3.04	27.40	30.44	54.00	-23.56	AVG
2	4960.030	3.04	41.70	44.74	74.00	-29.26	peak

Remarks:  
 1. Factor (dB/m) = Antenna Factor (dB/m)+Cable Factor (dB)-Pre-amplifier Factor  
 2. Margin value = Level -Limit value



<b>Ant. Pol.</b>	Vertical
<b>Test Mode:</b>	TX GFSK Mode 2480MHz
<b>Remark:</b>	No report for the emission which more than 10 dB below the pre-scribed limit.

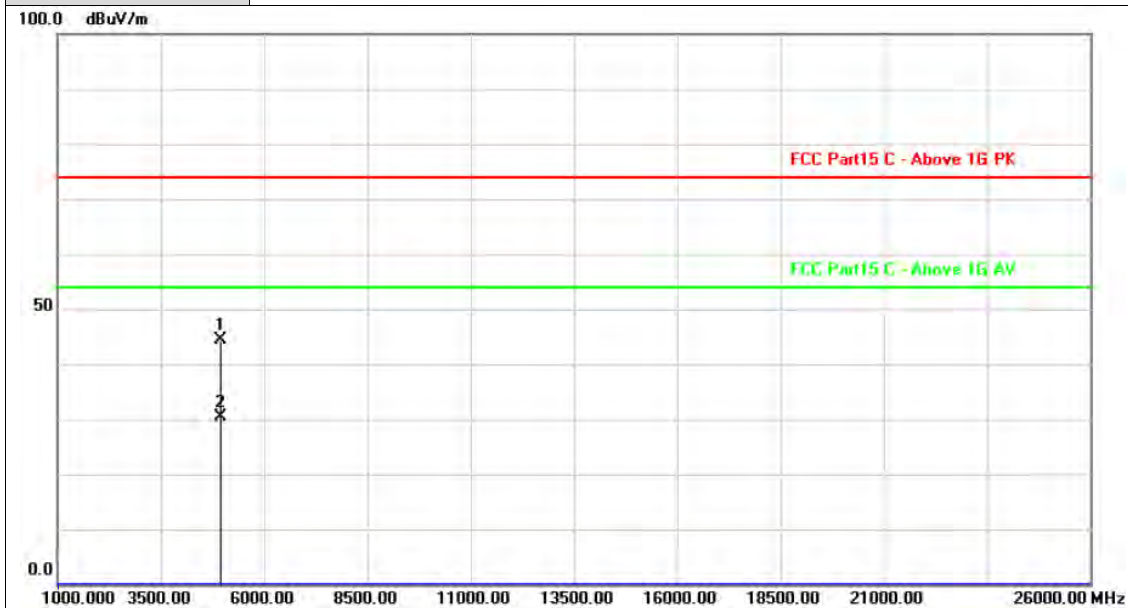

No.	Frequency (MHz)	Factor (dB/m)	Reading (dBuV)	Level (dBuV/m)	Limit (dBuV/m)	Margin (dB)	Detector
1	4959.695	3.04	41.43	44.47	74.00	-29.53	peak
2	4960.036	3.04	27.43	30.47	54.00	-23.53	AVG

Remarks:  
 1. Factor (dB/m) = Antenna Factor (dB/m)+Cable Factor (dB)-Pre-amplifier Factor  
 2. Margin value = Level -Limit value





<b>Ant. Pol.</b>	Horizontal
<b>Test Mode:</b>	TX $\pi/4$ -DQPSK Mode 2402MHz
<b>Remark:</b>	No report for the emission which more than 10 dB below the pre-scribed limit.

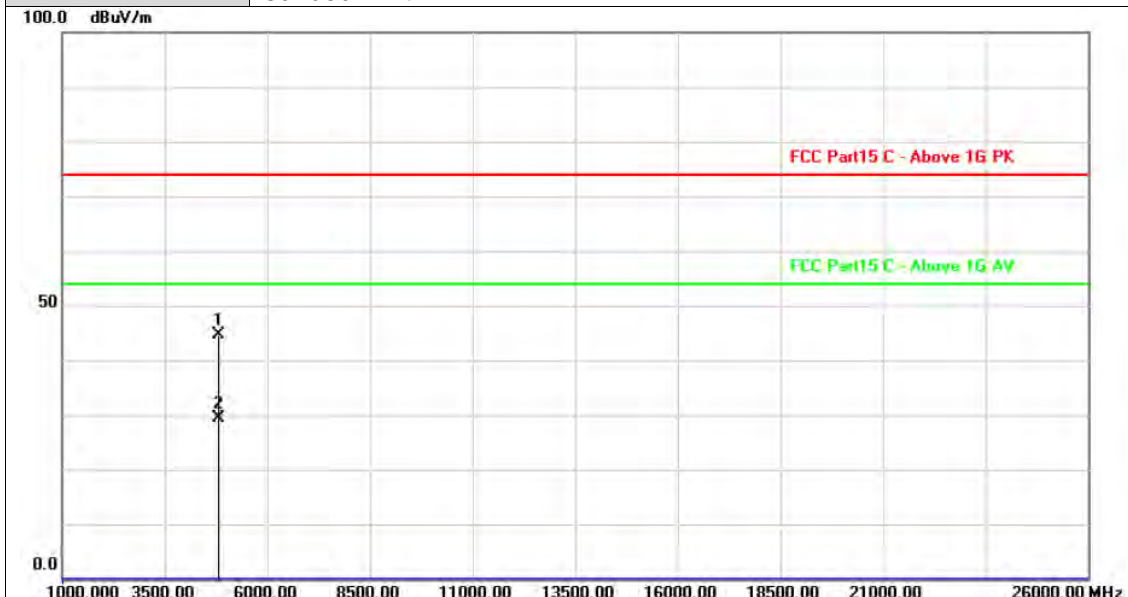

No.	Frequency (MHz)	Factor (dB/m)	Reading (dBuV)	Level (dBuV/m)	Limit (dBuV/m)	Margin (dB)	Detector
1	4803.745	2.56	42.12	44.68	74.00	-29.32	peak
2	4803.865	2.56	26.91	29.47	54.00	-24.53	AVG

Remarks:  
 1. Factor (dB/m) = Antenna Factor (dB/m)+Cable Factor (dB)-Pre-amplifier Factor  
 2. Margin value = Level -Limit value



<b>Ant. Pol.</b>	Vertical
<b>Test Mode:</b>	TX $\pi/4$ -DQPSK Mode 2402MHz
<b>Remark:</b>	No report for the emission which more than 10 dB below the prescribed limit.

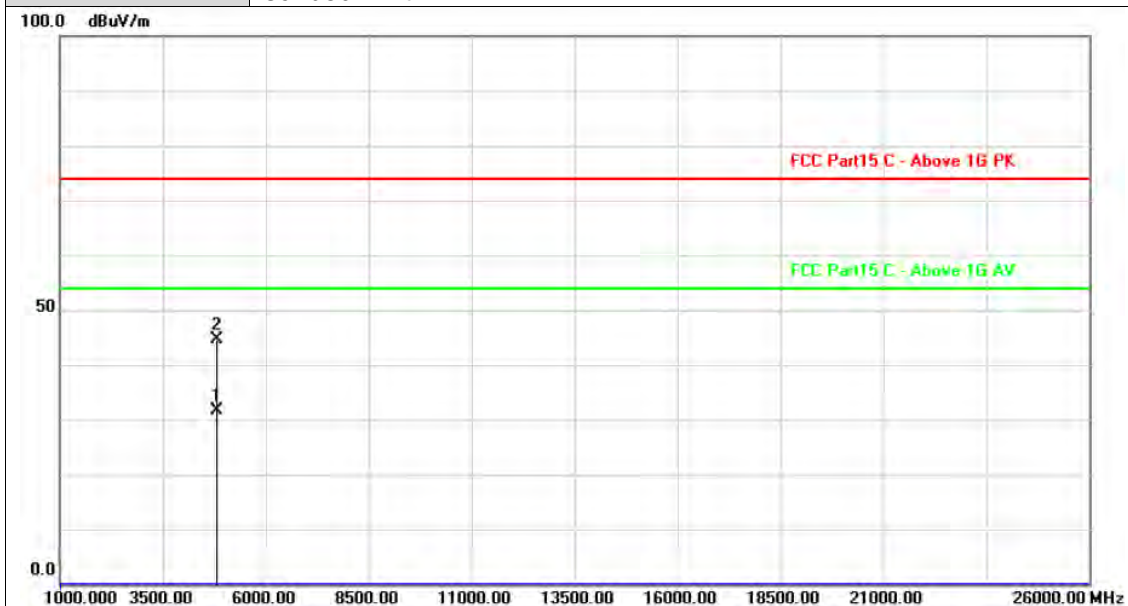

No.	Frequency (MHz)	Factor (dB/m)	Reading (dBuV)	Level (dBuV/m)	Limit (dBuV/m)	Margin (dB)	Detector
1	4803.635	2.56	29.19	31.75	54.00	-22.25	AVG
2	4803.690	2.56	42.19	44.75	74.00	-29.25	peak

Remarks:  
 1. Factor (dB/m) = Antenna Factor (dB/m)+Cable Factor (dB)-Pre-amplifier Factor  
 2. Margin value = Level -Limit value



<b>Ant. Pol.</b>	Horizontal
<b>Test Mode:</b>	TX $\pi/4$ -DQPSK Mode 2441MHz
<b>Remark:</b>	No report for the emission which more than 10 dB below the pre-scribed limit.

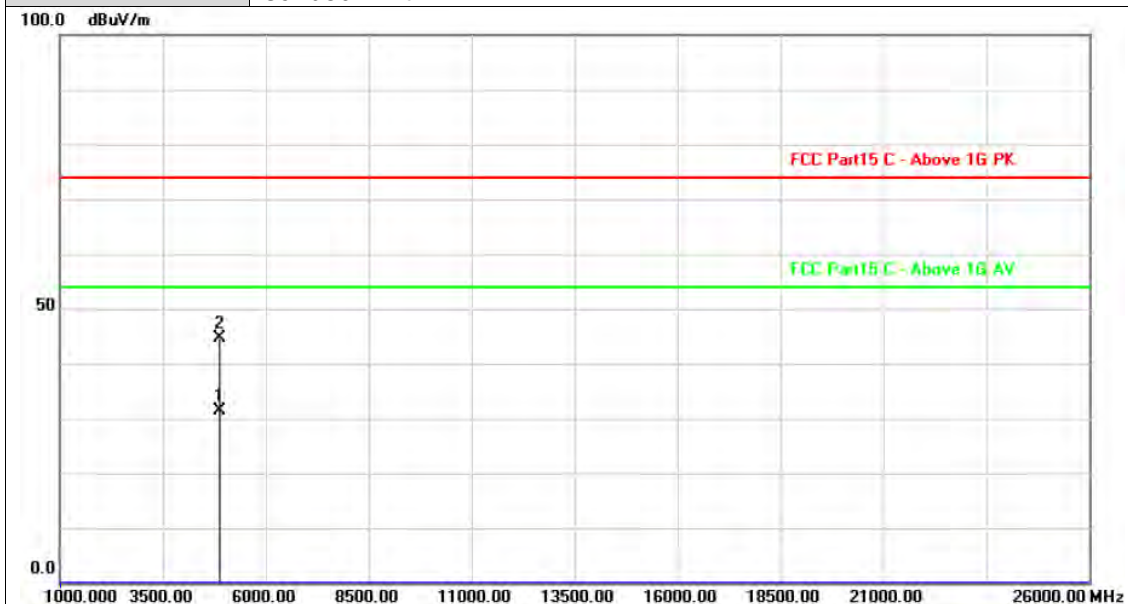

No.	Frequency (MHz)	Factor (dB/m)	Reading (dBuV)	Level (dBuV/m)	Limit (dBuV/m)	Margin (dB)	Detector
1	4882.065	2.79	28.66	31.45	54.00	-22.55	AVG
2	4882.635	2.80	41.94	44.74	74.00	-29.26	peak

Remarks:  
 1. Factor (dB/m) = Antenna Factor (dB/m)+Cable Factor (dB)-Pre-amplifier Factor  
 2. Margin value = Level -Limit value



<b>Ant. Pol.</b>	Vertical
<b>Test Mode:</b>	TX $\pi/4$ -DQPSK Mode 2441MHz
<b>Remark:</b>	No report for the emission which more than 10 dB below the pre-scribed limit.

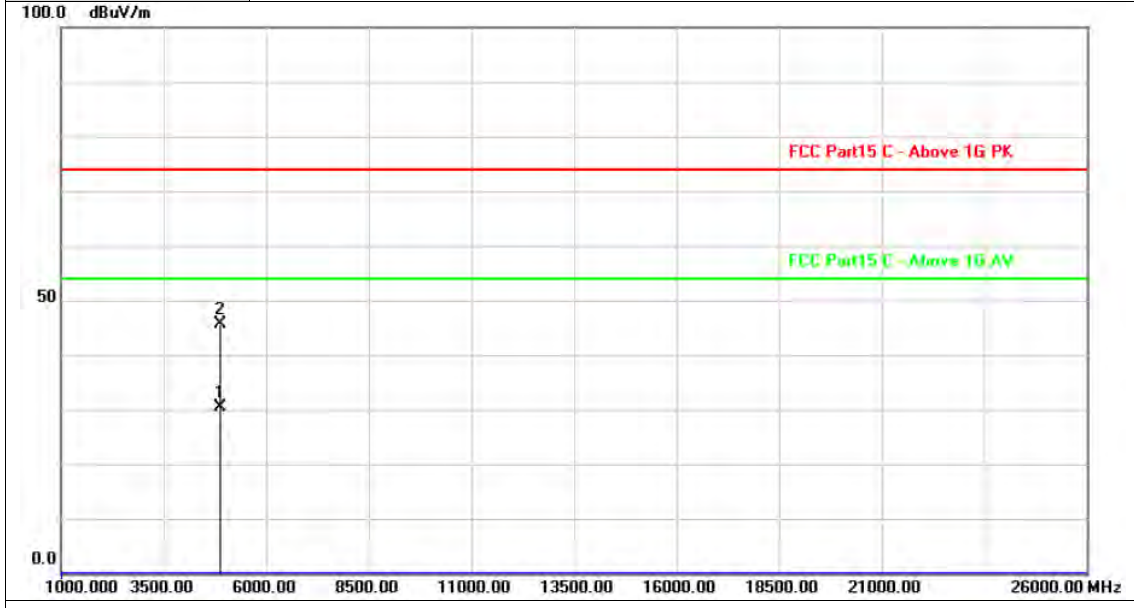

No.	Frequency (MHz)	Factor (dB/m)	Reading (dBuV)	Level (dBuV/m)	Limit (dBuV/m)	Margin (dB)	Detector
1	4882.263	2.79	27.63	30.42	54.00	-23.58	AVG
2	4882.352	2.79	42.92	45.71	74.00	-28.29	peak

Remarks:  
 1. Factor (dB/m) = Antenna Factor (dB/m)+Cable Factor (dB)-Pre-amplifier Factor  
 2. Margin value = Level -Limit value



<b>Ant. Pol.</b>	Horizontal
<b>Test Mode:</b>	TX $\pi/4$ -DQPSK Mode 2480MHz
<b>Remark:</b>	No report for the emission which more than 10 dB below the prescribed limit.

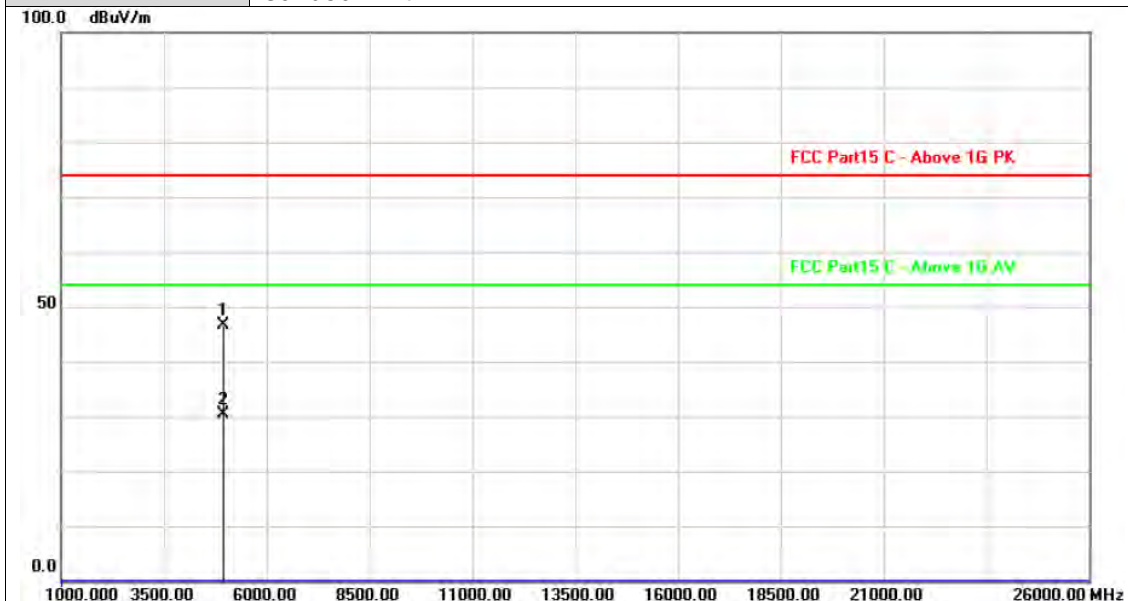

No.	Frequency (MHz)	Factor (dB/m)	Reading (dBuV)	Level (dBuV/m)	Limit (dBuV/m)	Margin (dB)	Detector
1	4959.951	3.04	43.70	46.74	74.00	-27.26	peak
2	4960.030	3.04	27.43	30.47	54.00	-23.53	AVG

Remarks:  
 1. Factor (dB/m) = Antenna Factor (dB/m)+Cable Factor (dB)-Pre-amplifier Factor  
 2. Margin value = Level -Limit value



<b>Ant. Pol.</b>	Vertical
<b>Test Mode:</b>	TX $\pi/4$ -DQPSK Mode 2480MHz
<b>Remark:</b>	No report for the emission which more than 10 dB below the pre-scribed limit.

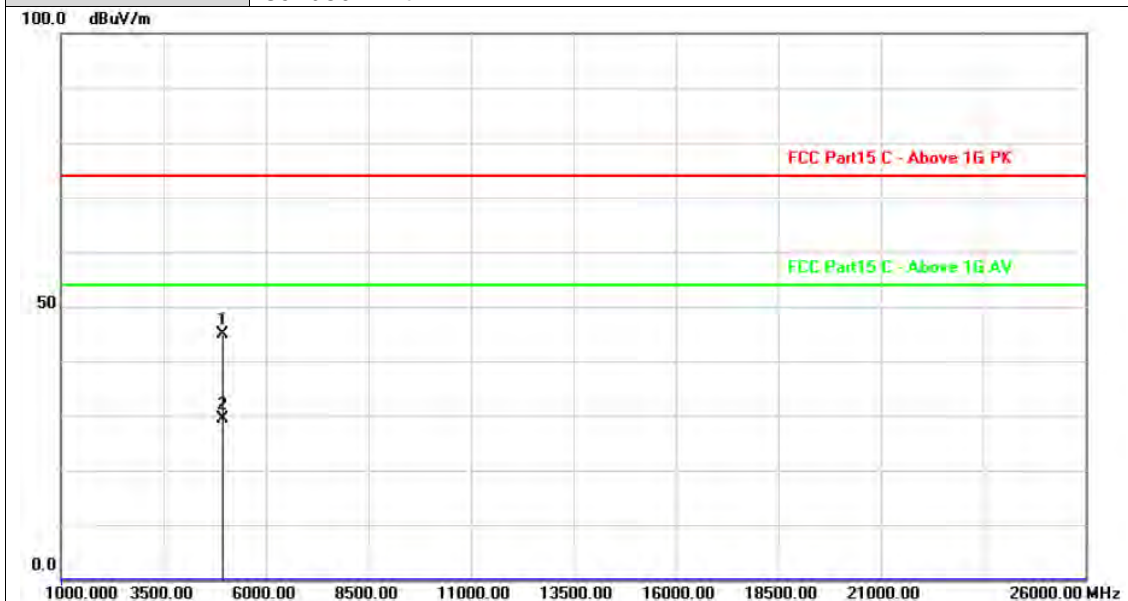

No.	Frequency (MHz)	Factor (dB/m)	Reading (dBuV)	Level (dBuV/m)	Limit (dBuV/m)	Margin (dB)	Detector
1	4959.365	3.04	41.73	44.77	74.00	-29.23	peak
2	4960.003	3.04	26.41	29.45	54.00	-24.55	AVG

Remarks:  
 1. Factor (dB/m) = Antenna Factor (dB/m)+Cable Factor (dB)-Pre-amplifier Factor  
 2. Margin value = Level -Limit value



<b>Ant. Pol.</b>	Horizontal
<b>Test Mode:</b>	TX 8-DPSK Mode 2402MHz
<b>Remark:</b>	No report for the emission which more than 10 dB below the pre-scribed limit.

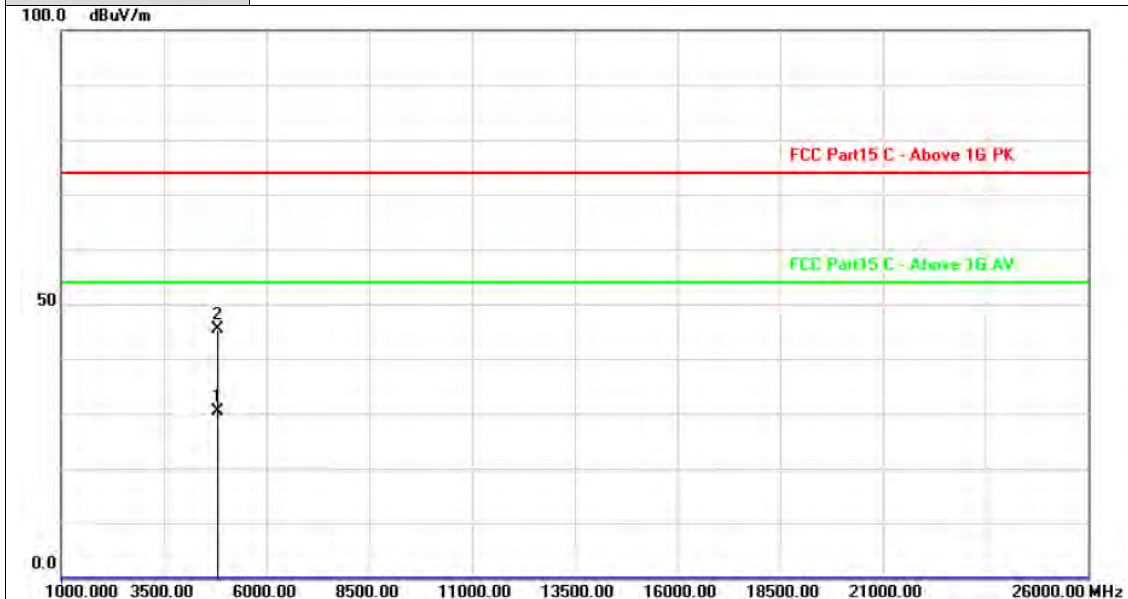

No.	Frequency (MHz)	Factor (dB/m)	Reading (dBuV)	Level (dBuV/m)	Limit (dBuV/m)	Margin (dB)	Detector
1	4803.651	2.56	27.88	30.44	54.00	-23.56	AVG
2	4804.352	2.56	42.91	45.47	74.00	-28.53	peak

Remarks:

- Factor (dB/m) = Antenna Factor (dB/m)+Cable Factor (dB)-Pre-amplifier Factor
- Margin value = Level -Limit value





<b>Ant. Pol.</b>	Vertical
<b>Test Mode:</b>	TX 8-DPSK Mode 2402MHz
<b>Remark:</b>	No report for the emission which more than 10 dB below the pre-scribed limit.



No.	Frequency (MHz)	Factor (dB/m)	Reading (dBuV)	Level (dBuV/m)	Limit (dBuV/m)	Margin (dB)	Detector
1	4803.694	2.56	27.85	30.41	54.00	-23.59	AVG
2	4804.063	2.56	42.61	45.17	74.00	-28.83	peak

Remarks:

- 1. Factor (dB/m) = Antenna Factor (dB/m) + Cable Factor (dB) - Pre-amplifier Factor
- 2. Margin value = Level - Limit value





<b>Ant. Pol.</b>	Horizontal
<b>Test Mode:</b>	TX 8-DPSK Mode 2441MHz
<b>Remark:</b>	No report for the emission which more than 10 dB below the pre-scribed limit.



No.	Frequency (MHz)	Factor (dB/m)	Reading (dBuV)	Level (dBuV/m)	Limit (dBuV/m)	Margin (dB)	Detector
1	4881.814	2.79	41.57	44.36	74.00	-29.64	peak
2	4881.888	2.79	27.90	30.69	54.00	-23.31	AVG

Remarks:

- Factor (dB/m) = Antenna Factor (dB/m)+Cable Factor (dB)-Pre-amplifier Factor
- Margin value = Level -Limit value



<b>Ant. Pol.</b>	Vertical
<b>Test Mode:</b>	TX 8-DPSK Mode 2441MHz
<b>Remark:</b>	No report for the emission which more than 10 dB below the prescribed limit.

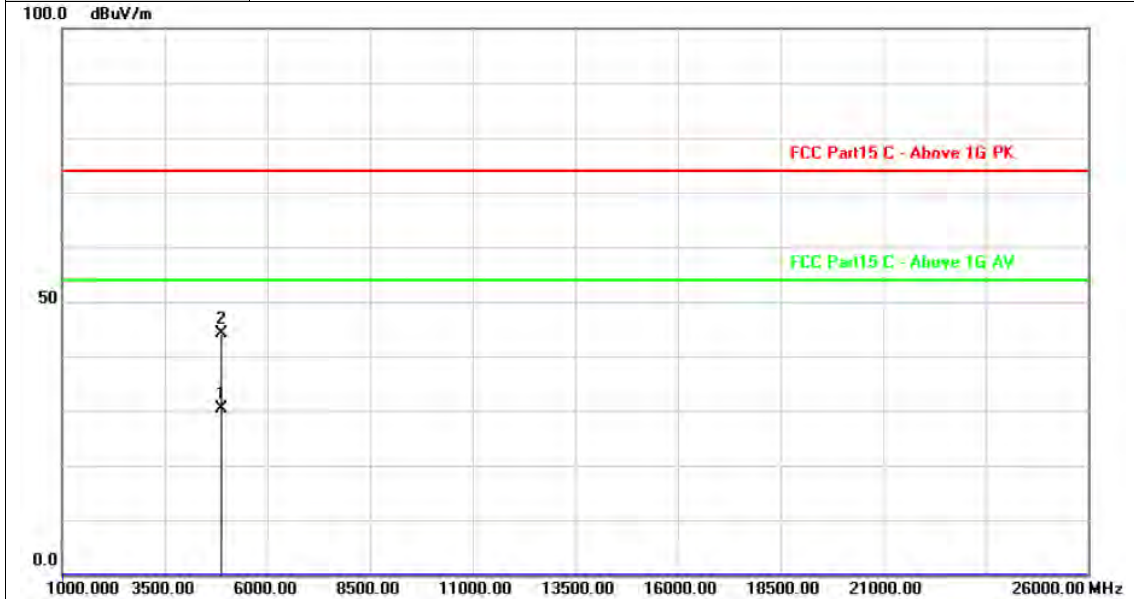

No.	Frequency (MHz)	Factor (dB/m)	Reading (dBuV)	Level (dBuV/m)	Limit (dBuV/m)	Margin (dB)	Detector
1	4881.684	2.79	27.68	30.47	54.00	-23.53	AVG
2	4881.757	2.79	41.40	44.19	74.00	-29.81	peak

Remarks:  
 1. Factor (dB/m) = Antenna Factor (dB/m)+Cable Factor (dB)-Pre-amplifier Factor  
 2. Margin value = Level -Limit value



<b>Ant. Pol.</b>	Horizontal
<b>Test Mode:</b>	TX 8-DPSK Mode 2480MHz
<b>Remark:</b>	No report for the emission which more than 10 dB below the pre-scribed limit.

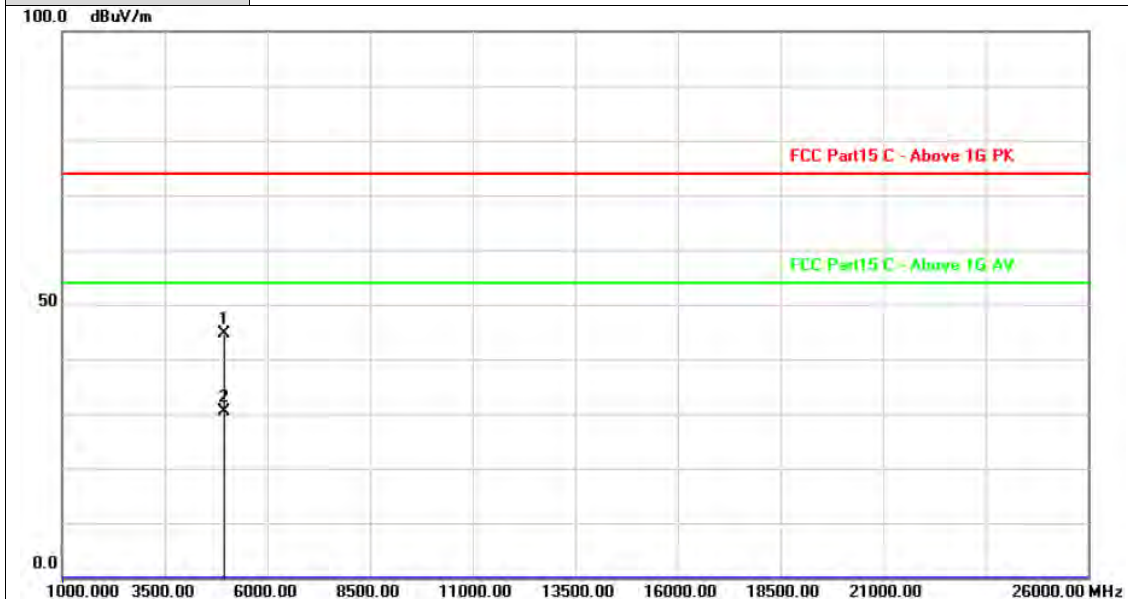

No.	Frequency (MHz)	Factor (dB/m)	Reading (dBuV)	Level (dBuV/m)	Limit (dBuV/m)	Margin (dB)	Detector
1	4959.654	3.04	41.51	44.55	74.00	-29.45	peak
2	4960.036	3.04	27.43	30.47	54.00	-23.53	AVG

Remarks:  
 1. Factor (dB/m) = Antenna Factor (dB/m)+Cable Factor (dB)-Pre-amplifier Factor  
 2. Margin value = Level -Limit value



<b>Ant. Pol.</b>	Vertical
<b>Test Mode:</b>	TX 8-DPSK Mode 2480MHz
<b>Remark:</b>	No report for the emission which more than 10 dB below the pre-scribed limit.

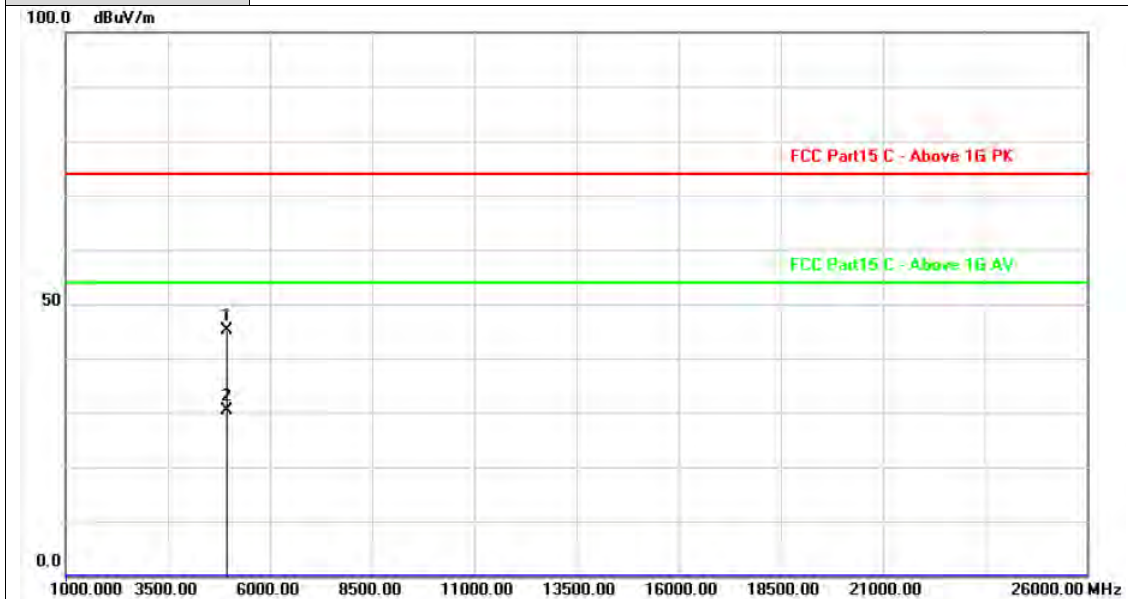

No.	Frequency (MHz)	Factor (dB/m)	Reading (dBuV)	Level (dBuV/m)	Limit (dBuV/m)	Margin (dB)	Detector
1	4960.103	3.04	42.13	45.17	74.00	-28.83	peak
2	4960.656	3.04	27.43	30.47	54.00	-23.53	AVG

Remarks:  
 1. Factor (dB/m) = Antenna Factor (dB/m)+Cable Factor (dB)-Pre-amplifier Factor  
 2. Margin value = Level -Limit value

### 3.3. Band Edge Emissions (Radiated)

**Limit**

FCC CFR Title 47 Part 15 Subpart C Section 15.247 (d):

Restricted Frequency Band (MHz)	(dBuV/m)(at 3m)	
	Peak	Average
2310 ~ 2390	74	54
2483.5 ~ 2500	74	54

**Test Configuration**

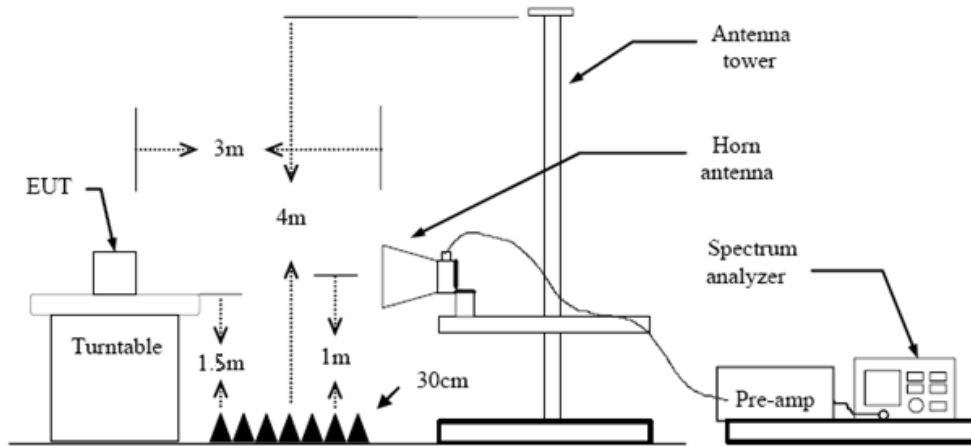

**Test Procedure**

1. The EUT was setup and tested according to ANSI C63.10:2013 requirements.
2. The EUT is placed on a turn table which is 1.5 meter above ground. The turn table is rotated 360 degrees to determine the position of the maximum emission level.
3. The EUT was positioned such that the distance from antenna to the EUT was 3 meters.
4. The antenna is scanned from 1 meter to 4 meters to find out the maximum emission level. This is repeated for both horizontal and vertical polarization of the antenna. In order to find the maximum emission, all of the interface cables were manipulated according to ANSI C63.10:2013 on radiated measurement.
5. The receiver set as follow:  
 RBW=1MHz, VBW=3MHz Peak detector for Peak value.  
 RBW=1MHz, VBW see note 1 with Peak Detector for Average Value.

Note 1: For measurements above 1 GHz the resolution bandwidth is set to 1 MHz, then the video bandwidth is set to 3 MHz for peak measurements and 1 MHz resolution bandwidth with 1/T video bandwidth with peak detector for average measurements. For the Duty Cycle please refer to clause 3.10 Duty Cycle.

**Test Mode**

Please refer to the clause 2.4.



**Test Results**

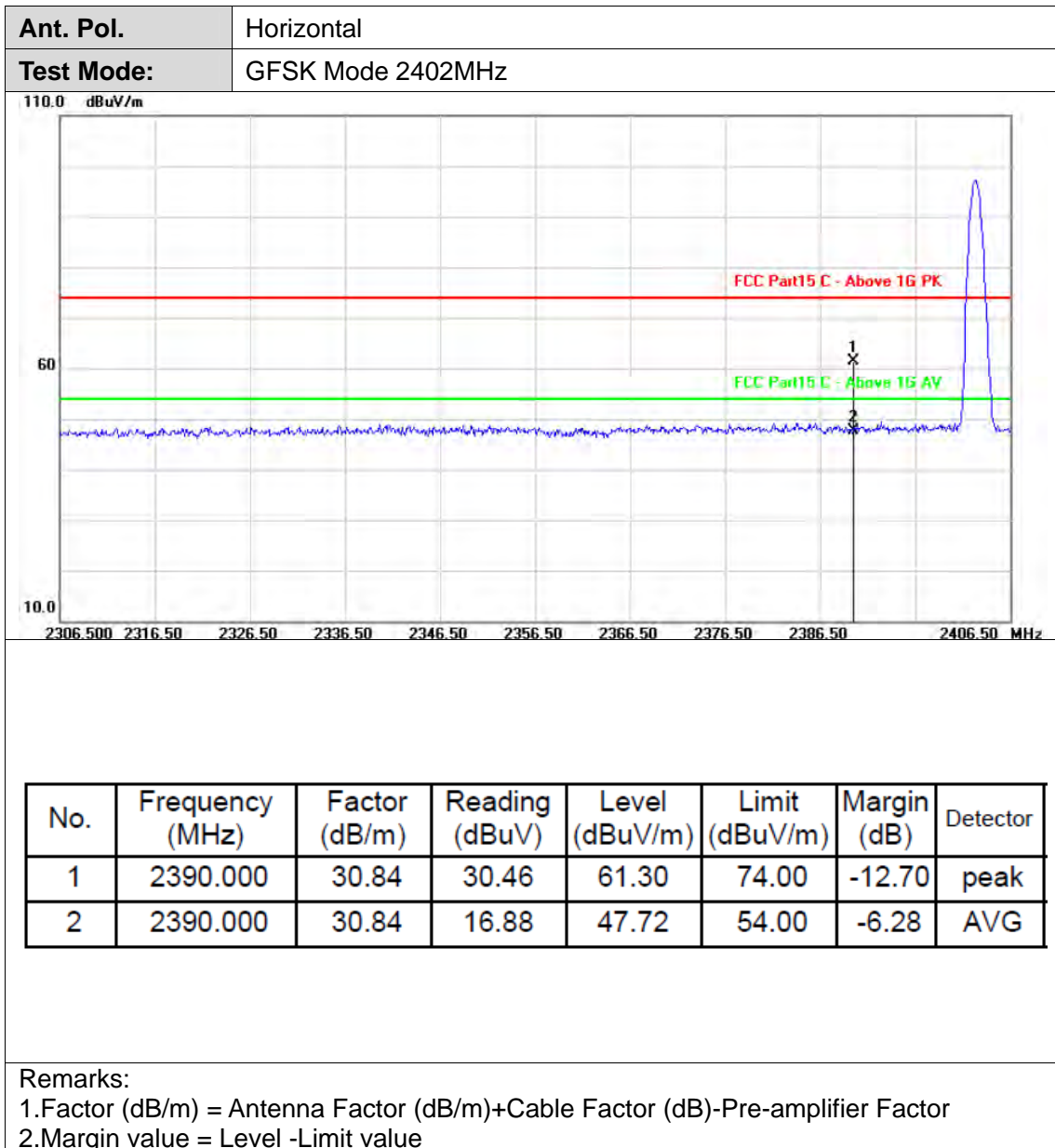



<b>Ant. Pol.</b>	Vertical
<b>Test Mode:</b>	GFSK Mode 2402MHz

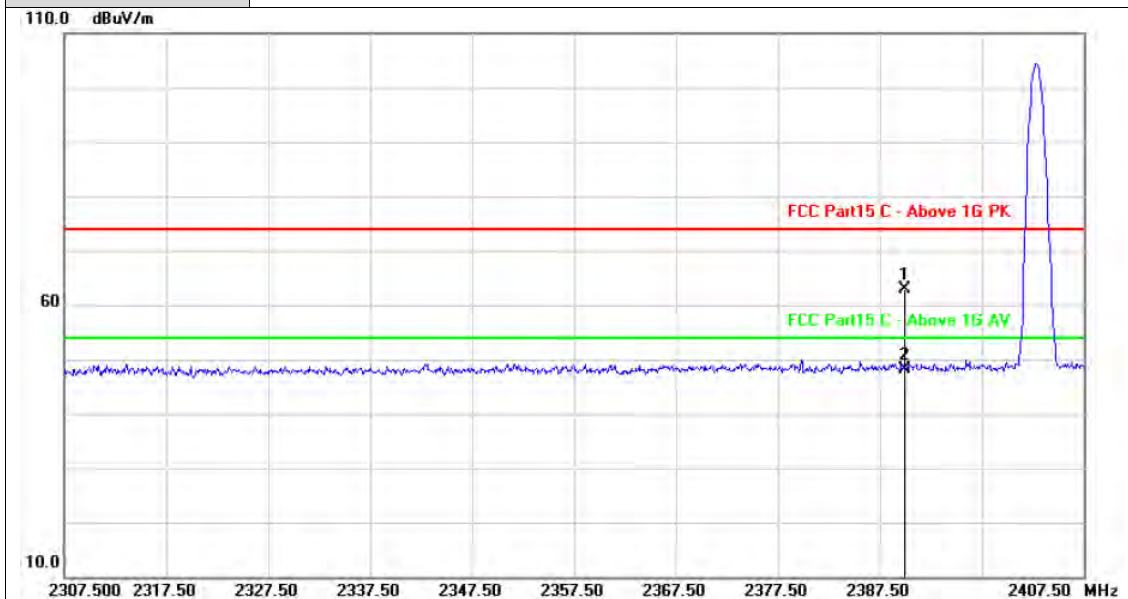

No.	Frequency (MHz)	Factor (dB/m)	Reading (dBuV)	Level (dBuV/m)	Limit (dBuV/m)	Margin (dB)	Detector
1	2390.000	30.84	31.99	62.83	74.00	-11.17	peak
2	2390.000	30.84	17.35	48.19	54.00	-5.81	AVG

Remarks:

- Factor (dB/m) = Antenna Factor (dB/m)+Cable Factor (dB)-Pre-amplifier Factor
- Margin value = Level -Limit value





<b>Ant. Pol.</b>	Horizontal
<b>Test Mode:</b>	GFSK Mode 2480 MHz

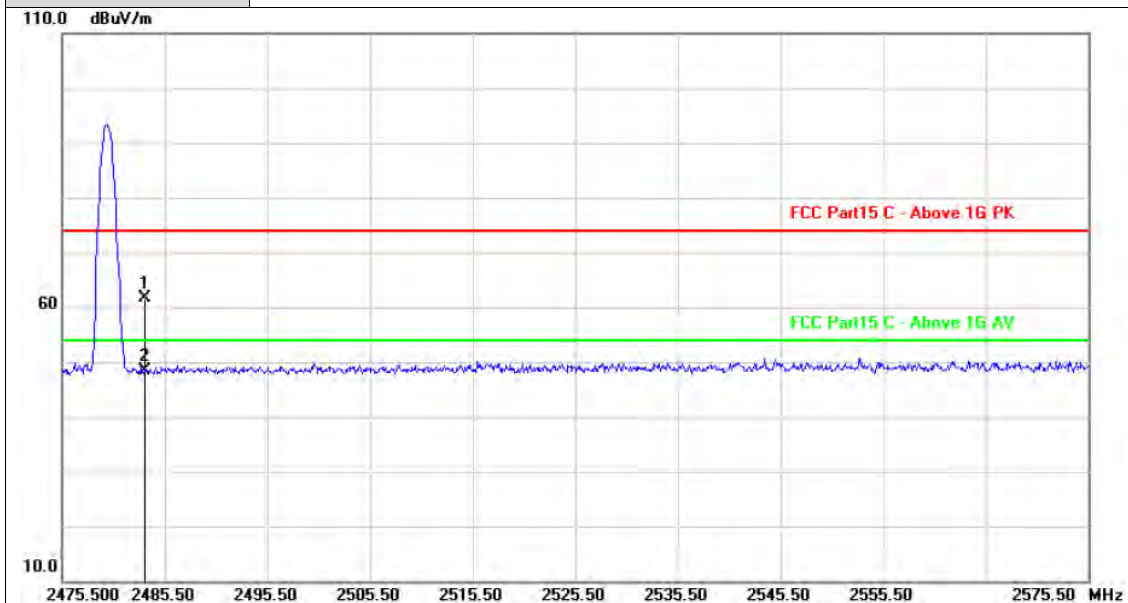

No.	Frequency (MHz)	Factor (dB/m)	Reading (dBuV)	Level (dBuV/m)	Limit (dBuV/m)	Margin (dB)	Detector
1	2483.500	31.24	30.33	61.57	74.00	-12.43	peak
2	2483.500	31.24	17.24	48.48	54.00	-5.52	AVG

Remarks:

- Factor (dB/m) = Antenna Factor (dB/m)+Cable Factor (dB)-Pre-amplifier Factor
- Margin value = Level -Limit value





<b>Ant. Pol.</b>	Vertical
<b>Test Mode:</b>	GFSK Mode 2480 MHz

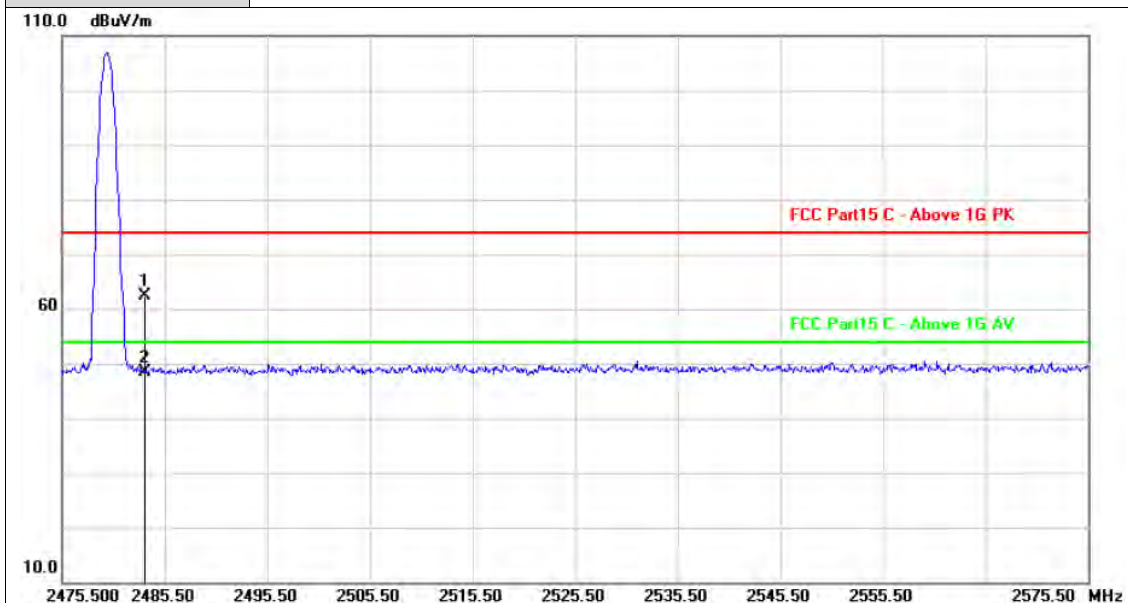

No.	Frequency (MHz)	Factor (dB/m)	Reading (dBuV)	Level (dBuV/m)	Limit (dBuV/m)	Margin (dB)	Detector
1	2483.500	31.24	31.21	62.45	74.00	-11.55	peak
2	2483.540	31.24	17.05	48.29	54.00	-5.71	AVG

Remarks:  
 1. Factor (dB/m) = Antenna Factor (dB/m)+Cable Factor (dB)-Pre-amplifier Factor  
 2. Margin value = Level -Limit value



<b>Ant. Pol.</b>	Horizontal
<b>Test Mode:</b>	$\pi/4$ -DQPSK Mode 2402MHz

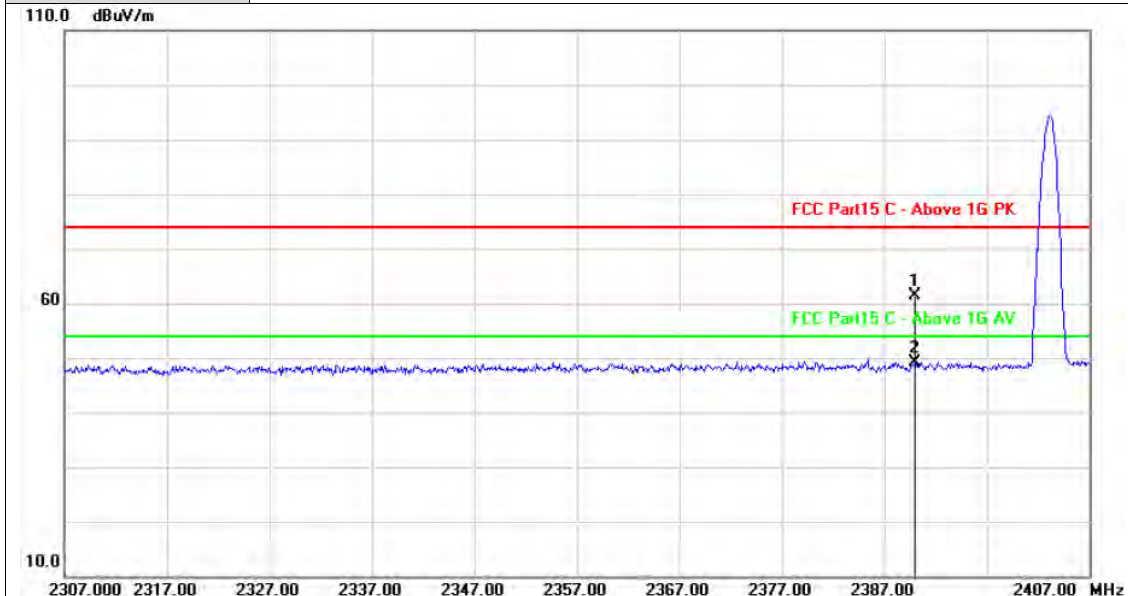

No.	Frequency (MHz)	Factor (dB/m)	Reading (dBuV)	Level (dBuV/m)	Limit (dBuV/m)	Margin (dB)	Detector
1	2390.000	30.84	30.63	61.47	74.00	-12.53	peak
2	2390.000	30.84	18.18	49.02	54.00	-4.98	AVG

Remarks:

- Factor (dB/m) = Antenna Factor (dB/m)+Cable Factor (dB)-Pre-amplifier Factor
- Margin value = Level -Limit value



Ant. Pol.	Vertical
Test Mode:	$\pi/4$ -DQPSK Mode 2402MHz

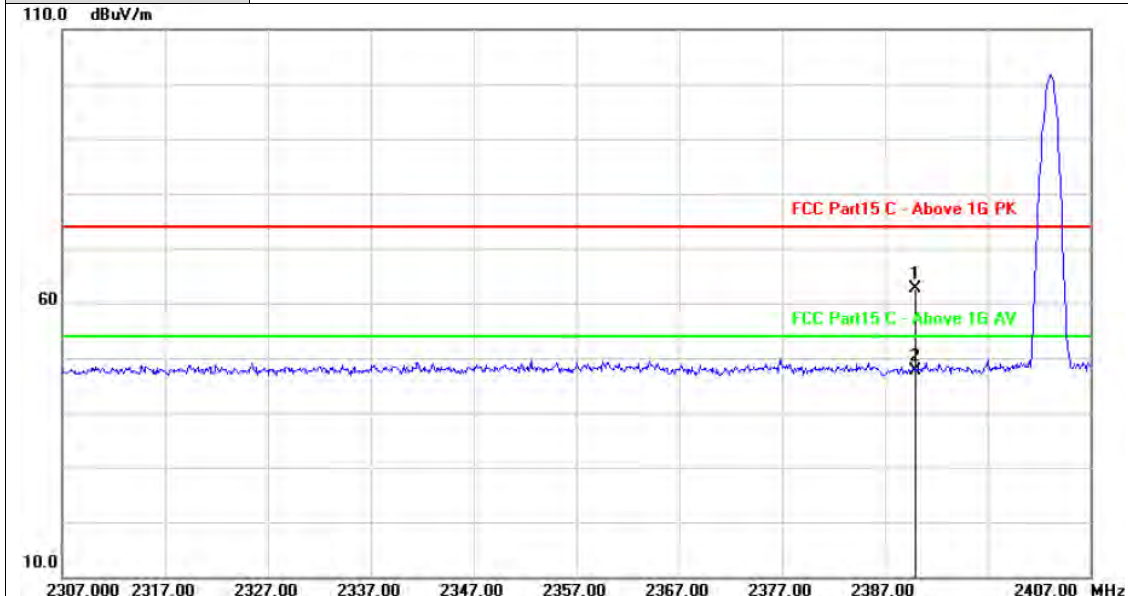

No.	Frequency (MHz)	Factor (dB/m)	Reading (dBuV)	Level (dBuV/m)	Limit (dBuV/m)	Margin (dB)	Detector
1	2390.000	30.84	31.75	62.59	74.00	-11.41	peak
2	2390.000	30.84	16.67	47.51	54.00	-6.49	AVG

Remarks:

- Factor (dB/m) = Antenna Factor (dB/m)+Cable Factor (dB)-Pre-amplifier Factor
- Margin value = Level -Limit value



<b>Ant. Pol.</b>	Horizontal
<b>Test Mode:</b>	$\pi/4$ -DQPSK Mode 2480MHz

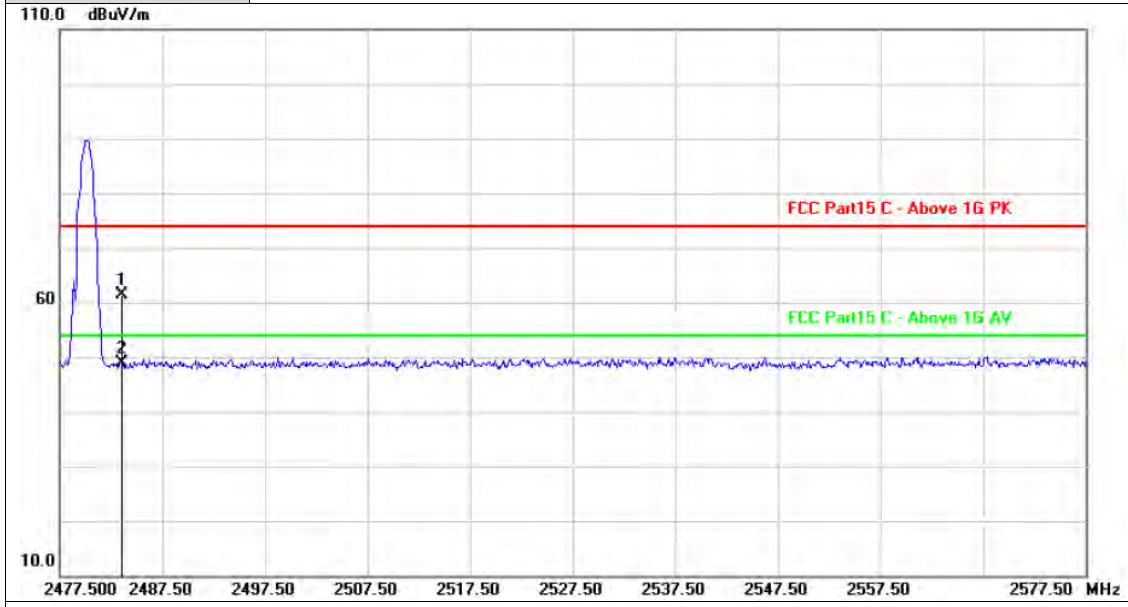

No.	Frequency (MHz)	Factor (dB/m)	Reading (dBuV)	Level (dBuV/m)	Limit (dBuV/m)	Margin (dB)	Detector
1	2483.500	31.24	30.02	61.26	74.00	-12.74	peak
2	2483.500	31.24	17.56	48.80	54.00	-5.20	AVG

Remarks:

- 1. Factor (dB/m) = Antenna Factor (dB/m)+Cable Factor (dB)-Pre-amplifier Factor
- 2. Margin value = Level -Limit value





<b>Ant. Pol.</b>	Vertical
<b>Test Mode:</b>	$\pi/4$ -DQPSK Mode 2480MHz

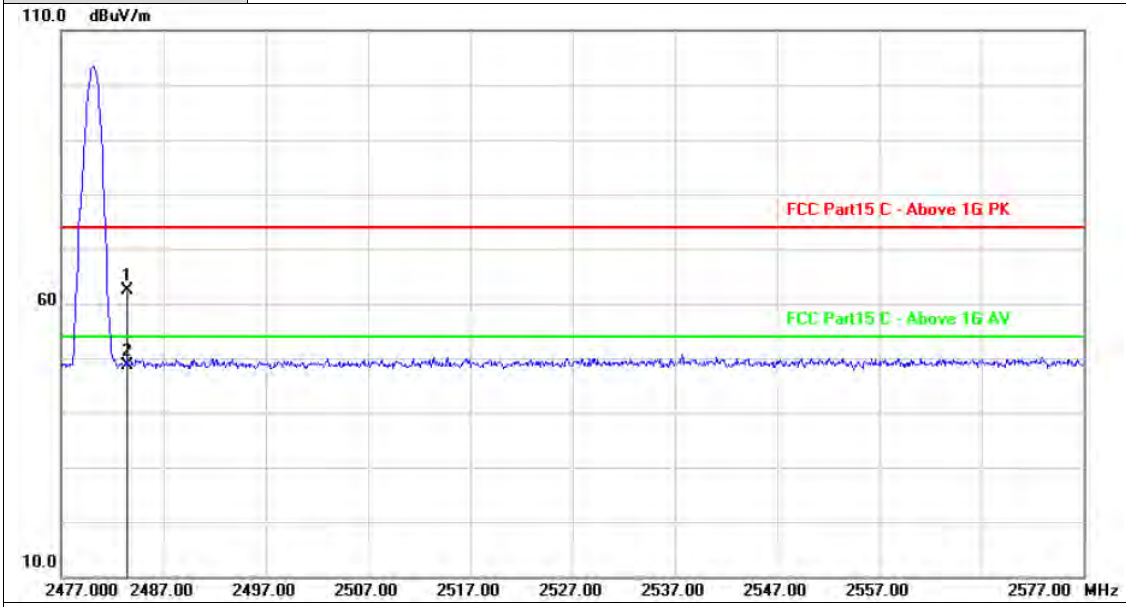

No.	Frequency (MHz)	Factor (dB/m)	Reading (dBuV)	Level (dBuV/m)	Limit (dBuV/m)	Margin (dB)	Detector
1	2483.500	31.24	31.21	62.45	74.00	-11.55	peak
2	2483.500	31.24	17.38	48.62	54.00	-5.38	AVG

Remarks:  
 1. Factor (dB/m) = Antenna Factor (dB/m)+Cable Factor (dB)-Pre-amplifier Factor  
 2. Margin value = Level -Limit value



<b>Ant. Pol.</b>	Horizontal
<b>Test Mode:</b>	8-DPSK Mode 2402MHz

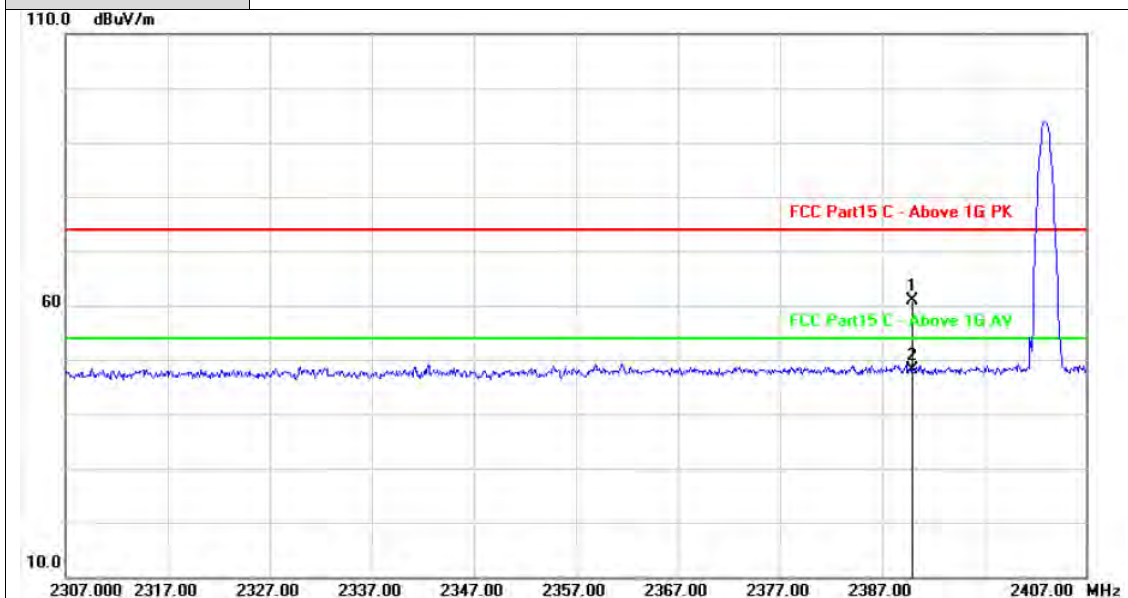

No.	Frequency (MHz)	Factor (dB/m)	Reading (dBuV)	Level (dBuV/m)	Limit (dBuV/m)	Margin (dB)	Detector
1	2390.000	30.84	30.11	60.95	74.00	-13.05	peak
2	2390.000	30.84	17.38	48.22	54.00	-5.78	AVG

Remarks:

- 1. Factor (dB/m) = Antenna Factor (dB/m)+Cable Factor (dB)-Pre-amplifier Factor
- 2. Margin value = Level -Limit value





<b>Ant. Pol.</b>	Vertical
<b>Test Mode:</b>	8-DPSK Mode 2402MHz

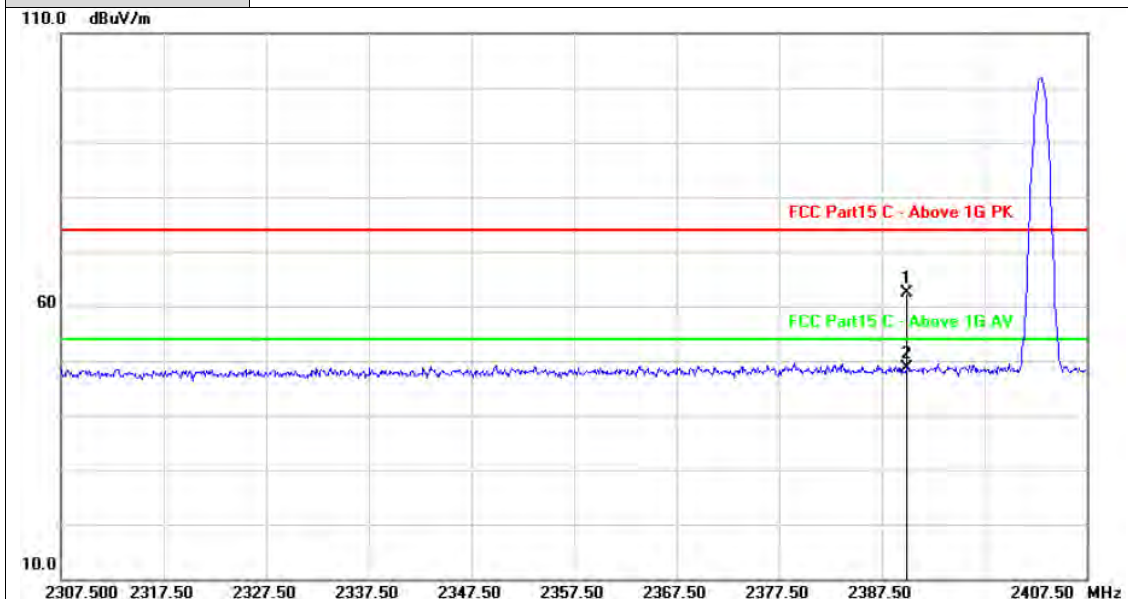

No.	Frequency (MHz)	Factor (dB/m)	Reading (dBuV)	Level (dBuV/m)	Limit (dBuV/m)	Margin (dB)	Detector
1	2390.000	30.84	31.63	62.47	74.00	-11.53	peak
2	2390.000	30.84	17.67	48.51	54.00	-5.49	AVG

Remarks:  
 1. Factor (dB/m) = Antenna Factor (dB/m)+Cable Factor (dB)-Pre-amplifier Factor  
 2. Margin value = Level -Limit value





<b>Ant. Pol.</b>	Horizontal
<b>Test Mode:</b>	8-DPSK Mode 2480MHz

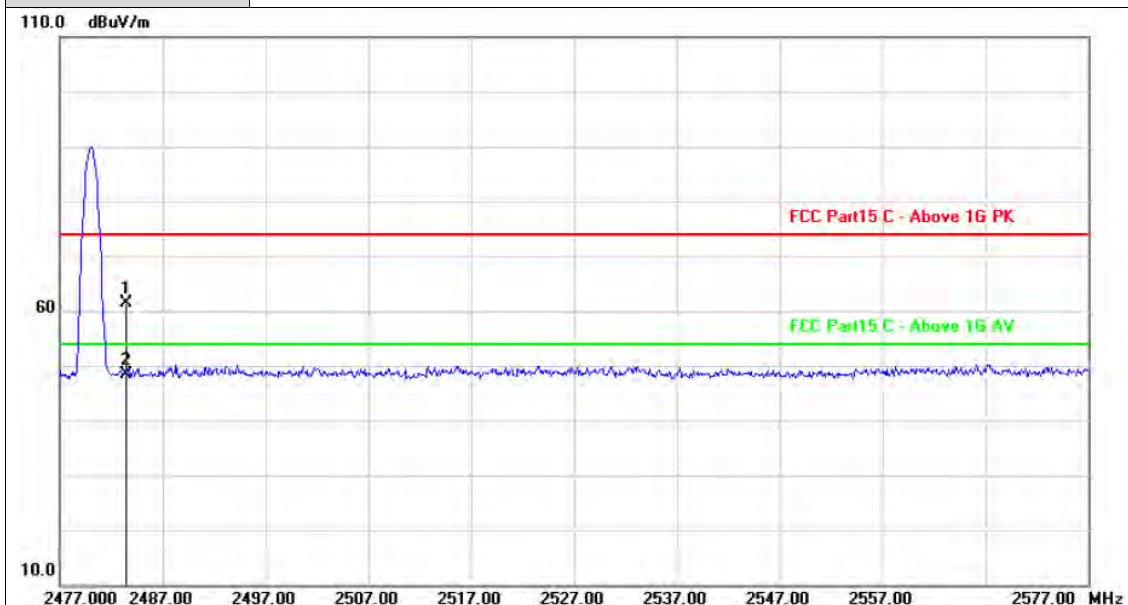

No.	Frequency (MHz)	Factor (dB/m)	Reading (dBuV)	Level (dBuV/m)	Limit (dBuV/m)	Margin (dB)	Detector
1	2483.500	31.24	30.20	61.44	74.00	-12.56	peak
2	2483.500	31.24	17.12	48.36	54.00	-5.64	AVG

Remarks:

1. Factor (dB/m) = Antenna Factor (dB/m) + Cable Factor (dB) - Pre-amplifier Factor
2. Margin value = Level - Limit value



<b>Ant. Pol.</b>	Vertical
<b>Test Mode:</b>	8-DPSK Mode 2480MHz

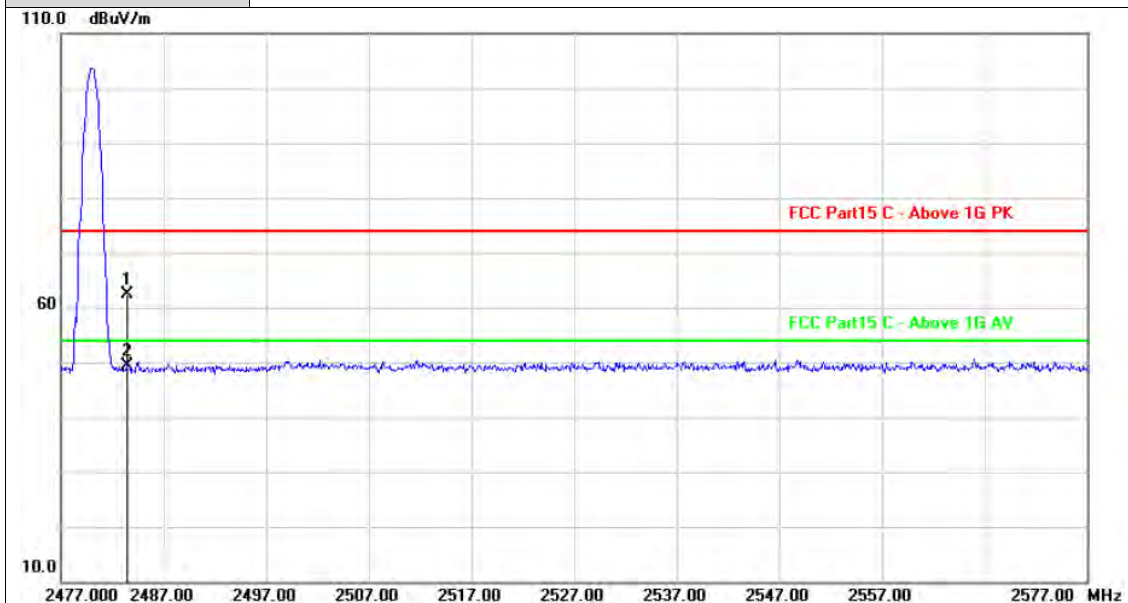

No.	Frequency (MHz)	Factor (dB/m)	Reading (dBuV)	Level (dBuV/m)	Limit (dBuV/m)	Margin (dB)	Detector
1	2483.500	31.24	31.21	62.45	74.00	-11.55	peak
2	2483.500	31.24	18.10	49.34	54.00	-4.66	AVG

Remarks:

- Factor (dB/m) = Antenna Factor (dB/m)+Cable Factor (dB)-Pre-amplifier Factor
- Margin value = Level -Limit value



### 3.4. Band edge and Spurious Emissions (Conducted)

#### Limit

FCC CFR Title 47 Part 15 Subpart C Section 15.247 (d): In any 100 kHz bandwidth outside the frequency band in which the spread spectrum intentional radiator is operating, the radio frequency power that is produced by the intentional radiator shall be at least 20 dB below that in the 100 kHz bandwidth within the band that contains the highest level of the desired power, based on either an RF conducted or a radiated measurement.

#### Test Configuration

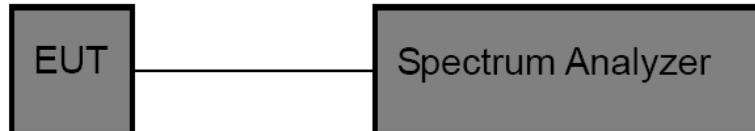

#### Test Procedure

1. The transmitter output was connected to the spectrum analyzer through an attenuator, the path loss was compensated to the results for each measurement.
2. Set to the maximum power setting and enable the EUT transmit continuously
3. Use the following spectrum analyzer settings:  
RBW = 100 kHz, VBW ≥ RBW, scan up through 10<sup>th</sup> harmonic.  
Sweep = auto, Detector function = peak, Trace = max hold
4. Measure and record the results in the test report.

#### Test Mode

Please refer to the clause 2.4.

#### Test Results

##### (1) Band edge Conducted Test

Test Mode	Frequency[MHz]	Ref Level[dBm]	Result[dBm]	Limit[dBm]	Verdict
GFSK	2402	4.66	-54.78	<=-15.34	PASS
	2480	6.67	-57.72	<=-13.33	PASS
	Hop_2402	4.26	-58.72	<=-15.74	PASS
	Hop_2480	7.07	-58.89	<=-12.93	PASS
π/4-DQPSK	2402	5.33	-52.59	<=-14.67	PASS
	2480	7.60	-57.61	<=-12.40	PASS
	Hop_2402	1.86	-58.22	<=-18.14	PASS
	Hop_2480	5.97	-58.47	<=-14.03	PASS
8-DPSK	2402	5.64	-51.45	<=-14.36	PASS
	2480	8.00	-56.46	<=-12.00	PASS
	Hop_2402	1.80	-58.81	<=-18.20	PASS
	Hop_2480	5.93	-58.82	<=-14.07	PASS



GFSK\_2402

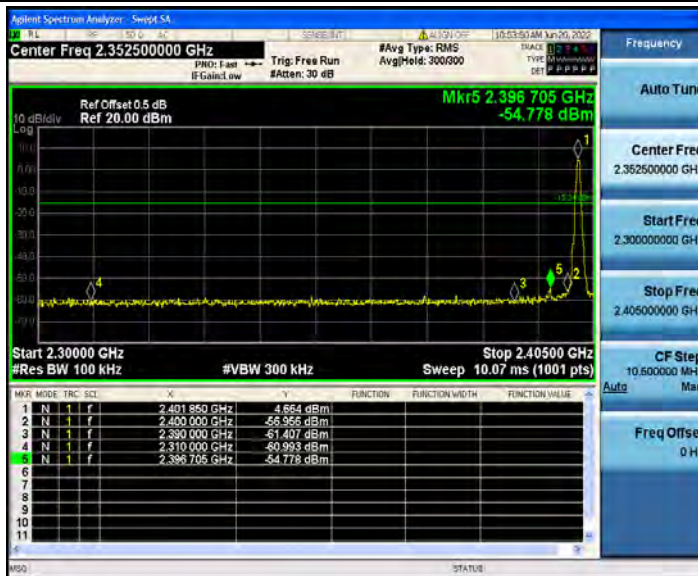

GFSK\_2480

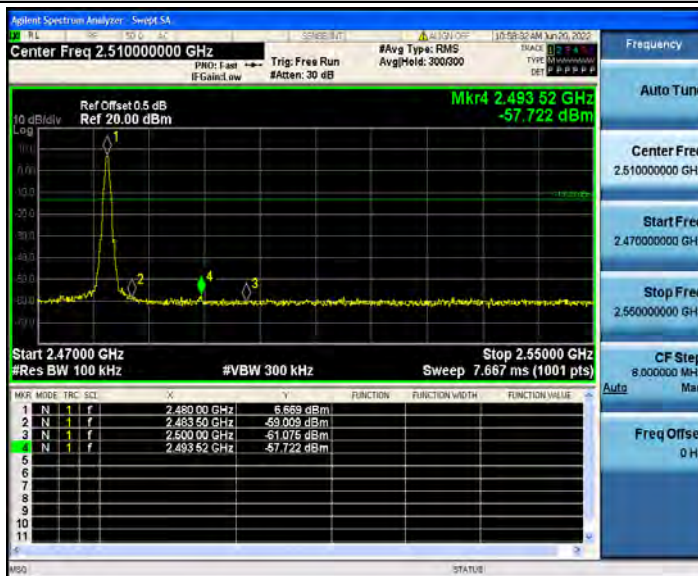

GFSK\_Hop\_2402

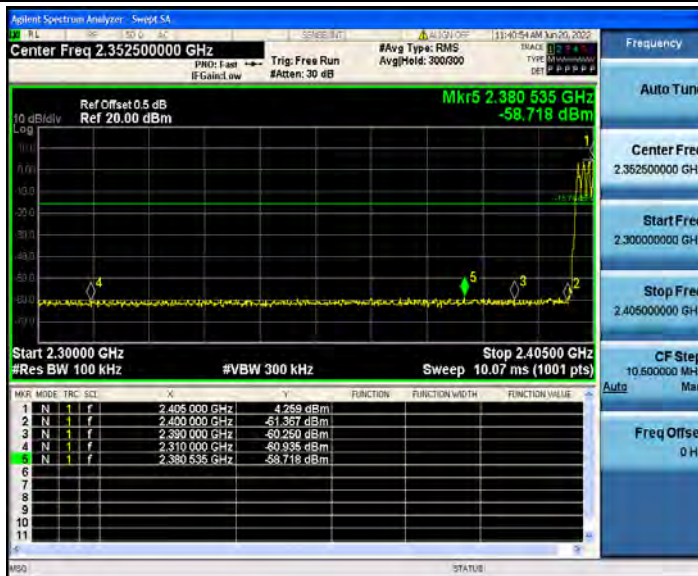

CTC Laboratories, Inc.

1-2/F., Building 2, Jiaquan Building, Guanlan High-Tech Park, Shenzhen, Guangdong, China  
Tel.: (86)755-27521059

Fax: (86)755-27521011 Http://www.sz-ctc.org.cn  
For anti-fake verification, please visit the official website of Certification and Accreditation Administration of the People's Republic of China : [yz.cnca.cn](http://yz.cnca.cn)







GFSK\_Hop\_2480



$\pi/4$ -DQPSK\_2402

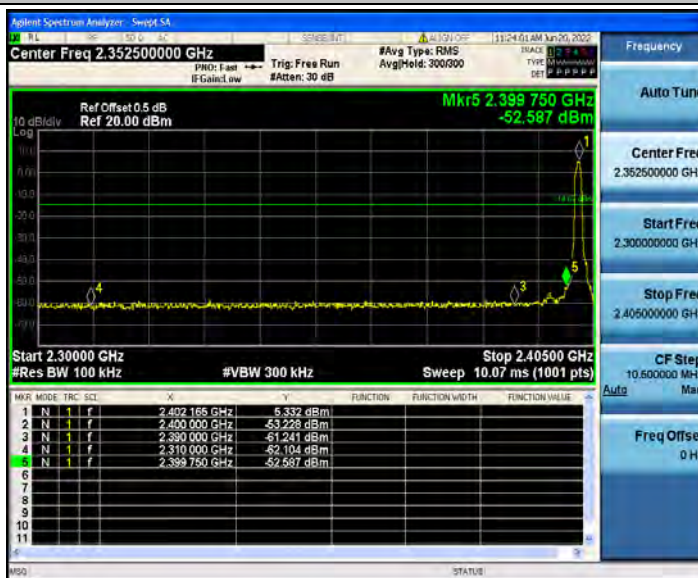

$\pi/4$ -DQPSK\_2480

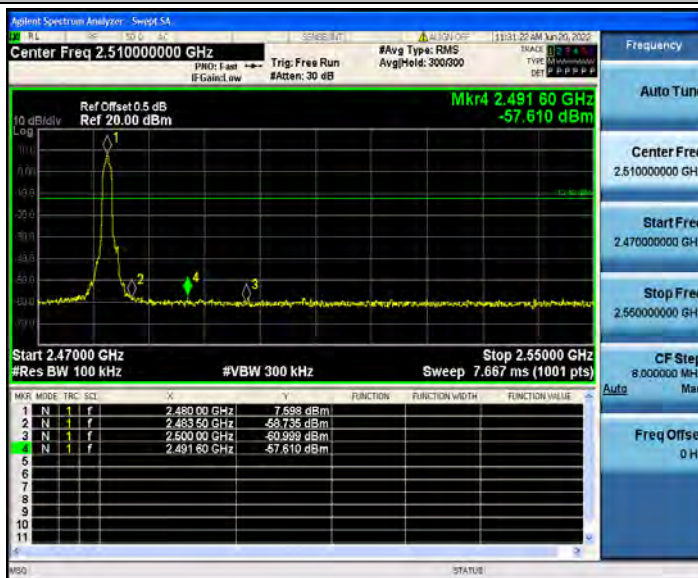

$\pi/4$ -DQPSK\_Hop\_2402

CTC Laboratories, Inc.

1-2/F., Building 2, Jiaquan Building, Guanlan High-Tech Park, Shenzhen, Guangdong, China  
Tel.: (86)755-27521059 Fax: (86)755-27521011 Http://www.sz-ctc.org.cn



For anti-fake verification, please visit the official website of Certification and Accreditation Administration of the People's Republic of China : [yz.cnca.cn](http://yz.cnca.cn)

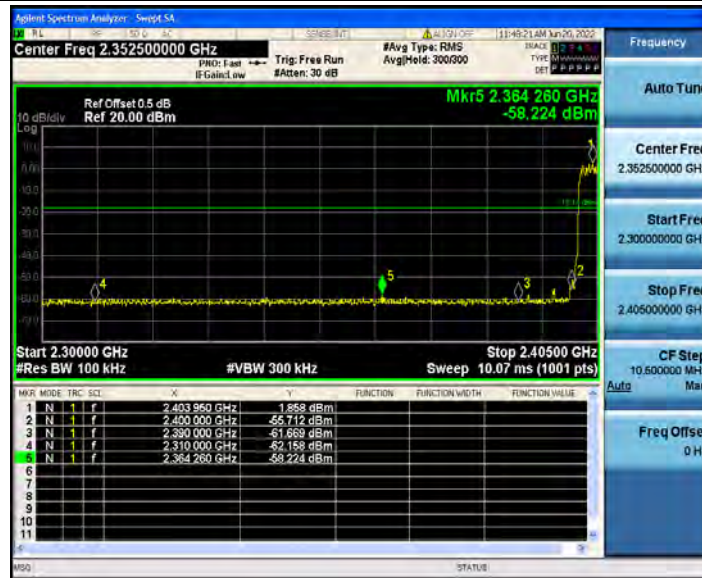

π/4-DQPSK\_Hop\_2480

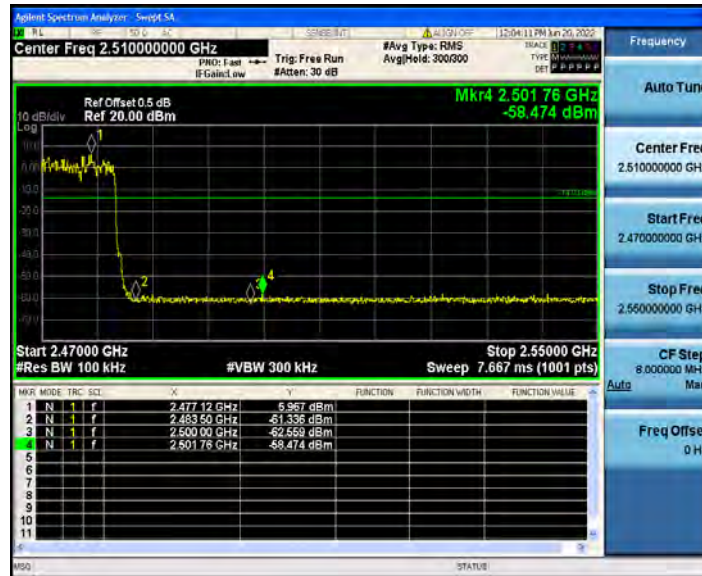

8-DPSK\_2402

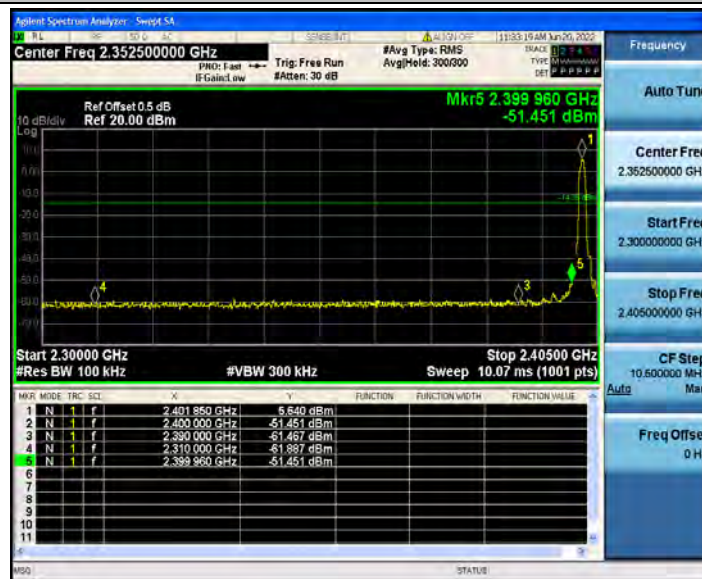

8-DPSK\_2480

CTC Laboratories, Inc.

1-2/F., Building 2, Jiaquan Building, Guanlan High-Tech Park, Shenzhen, Guangdong, China  
Tel.: (86)755-27521059

Fax: (86)755-27521011 Http://www.sz-ctc.org.cn  
For anti-fake verification, please visit the official website of Certification and Accreditation Administration of the People's Republic of China : [yz.cnca.cn](http://yz.cnca.cn)





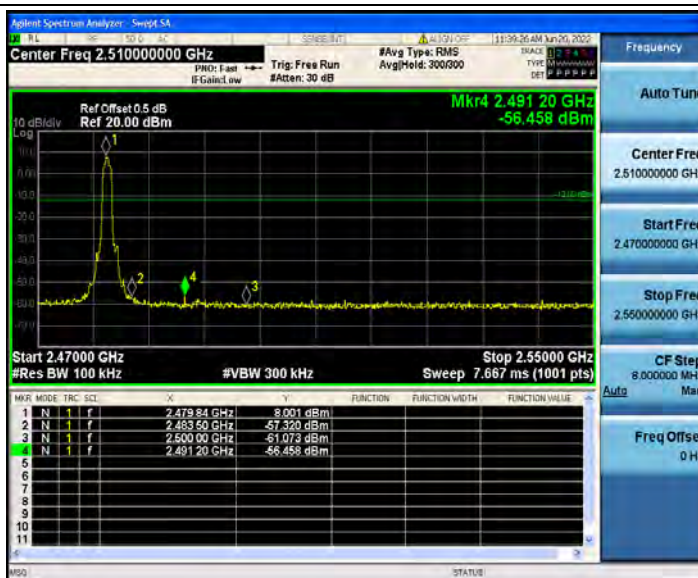

8-DPSK\_Hop\_2402



8-DPSK\_Hop\_2480

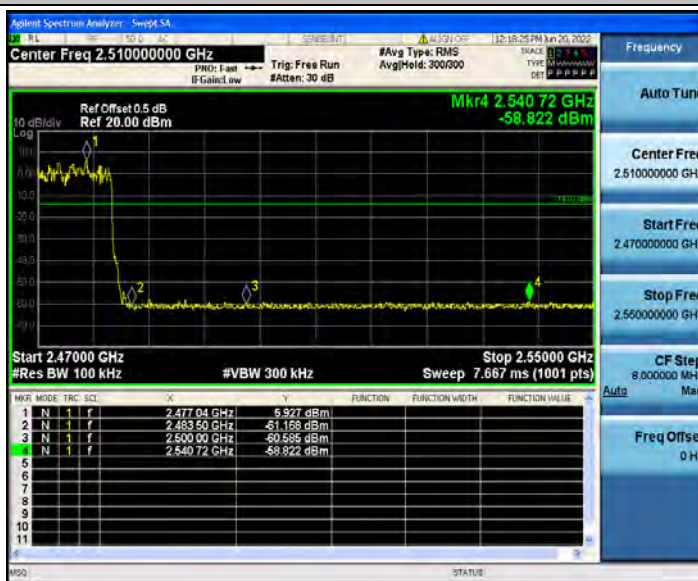





## (2) Conducted Spurious Emissions Test

Test Mode	Frequency[MHz]	Freq Range [MHz]	Ref Level [dBm]	Result [dBm]	Limit [dBm]	Verdict
GFSK	2402	Reference	4.68	4.68	---	PASS
		30~1000	4.68	-58.84	<=-15.32	PASS
		1000~26500	4.68	-39.23	<=-15.32	PASS
	2441	Reference	5.06	5.06	---	PASS
		30~1000	5.06	-59.87	<=-14.94	PASS
		1000~26500	5.06	-43.55	<=-14.94	PASS
	2480	Reference	6.39	6.39	---	PASS
		30~1000	6.39	-59.46	<=-13.62	PASS
		1000~26500	6.39	-44.62	<=-13.62	PASS
$\pi/4$ -DQPSK	2402	Reference	5.55	5.55	---	PASS
		30~1000	5.55	-59.73	<=-14.45	PASS
		1000~26500	5.55	-40.17	<=-14.45	PASS
	2441	Reference	6.24	6.24	---	PASS
		30~1000	6.24	-60.07	<=-13.76	PASS
		1000~26500	6.24	-44.78	<=-13.76	PASS
	2480	Reference	7.44	7.44	---	PASS
		30~1000	7.44	-59.68	<=-12.56	PASS
		1000~26500	7.44	-43.38	<=-12.56	PASS
8-DPSK	2402	Reference	5.43	5.43	---	PASS
		30~1000	5.43	-59.75	<=-14.57	PASS
		1000~26500	5.43	-42.07	<=-14.57	PASS
	2441	Reference	5.69	5.69	---	PASS
		30~1000	5.69	-59.11	<=-14.31	PASS
		1000~26500	5.69	-41.62	<=-14.31	PASS
	2480	Reference	7.32	7.32	---	PASS
		30~1000	7.32	-59.90	<=-12.68	PASS
		1000~26500	7.32	-45.54	<=-12.68	PASS



GFSK\_2402\_0~Reference



GFSK\_2402\_30~1000

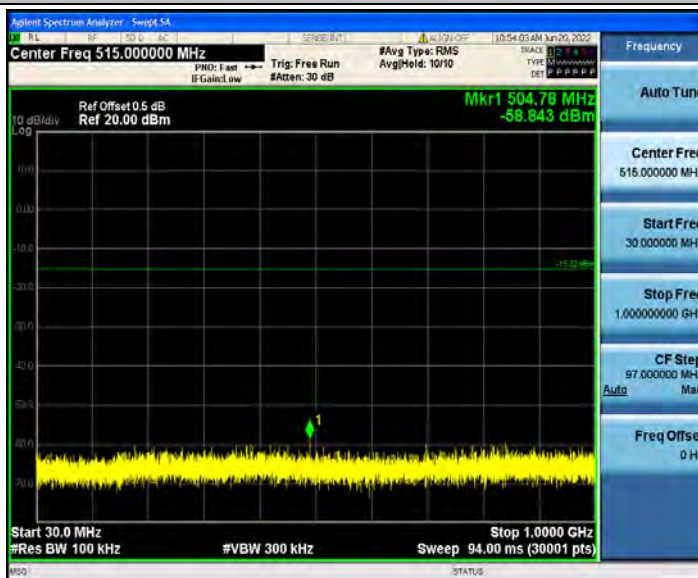

GFSK\_2402\_1000~26500

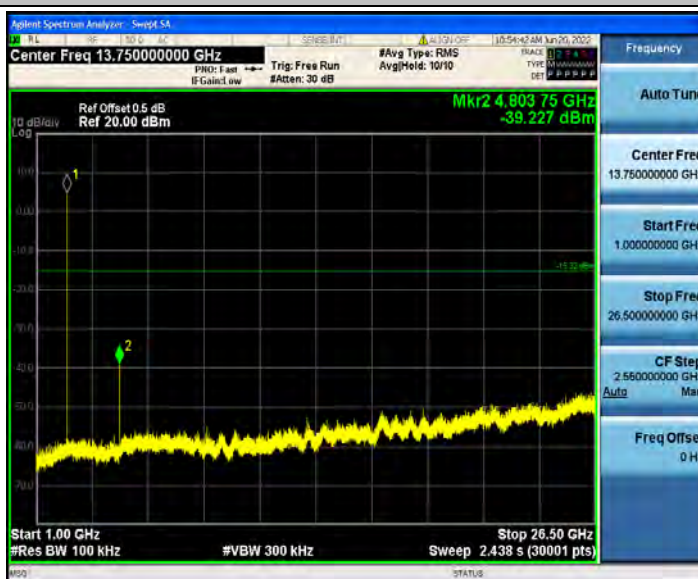

CTC Laboratories, Inc.

1-2/F., Building 2, Jiaquan Building, Guanlan High-Tech Park, Shenzhen, Guangdong, China  
 Tel.: (86)755-27521059 Fax: (86)755-27521011 Http://www.sz-ctc.org.cn



For anti-fake verification, please visit the official website of Certification and Accreditation Administration of the People's Republic of China : [yz.cnca.cn](http://yz.cnca.cn)



GFSK\_2441\_0~Reference



GFSK\_2441\_30~1000

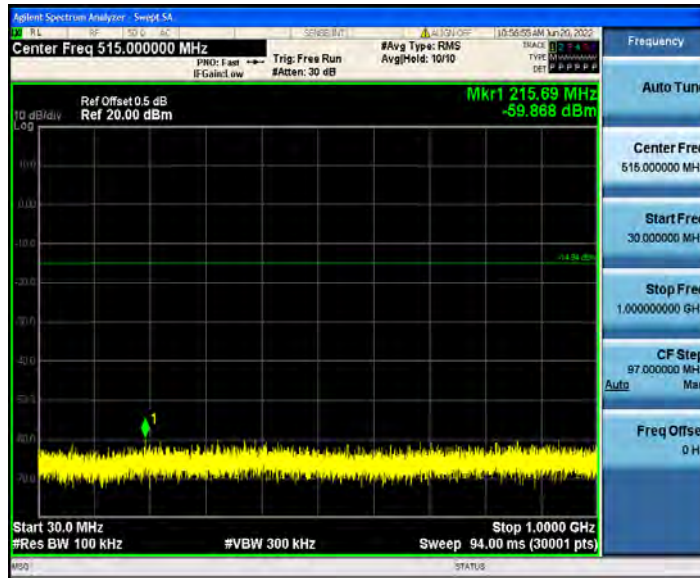

GFSK\_2441\_1000~26500



GFSK\_2480\_0~Reference

CTC Laboratories, Inc.

1-2/F., Building 2, Jiaquan Building, Guanlan High-Tech Park, Shenzhen, Guangdong, China

Tel.: (86)755-27521059

Fax: (86)755-27521011

Http://www.sz-ctc.org.cn



For anti-fake verification, please visit the official website of Certification and Accreditation Administration of the People's Republic of China : [yz.cnca.cn](http://yz.cnca.cn)





GFSK\_2480\_30~1000

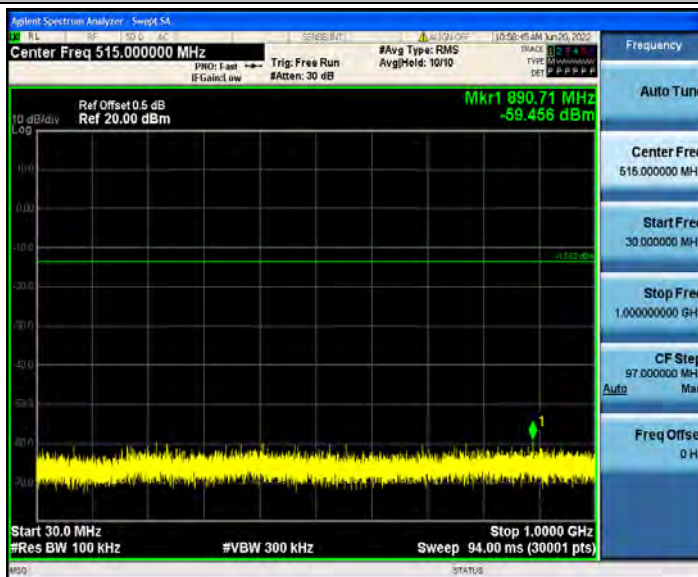

GFSK\_2480\_1000~26500



$\pi/4$ -DQPSK\_2402\_0~Reference

CTC Laboratories, Inc.

1-2/F., Building 2, Jiaquan Building, Guanlan High-Tech Park, Shenzhen, Guangdong, China  
Tel.: (86)755-27521059

Fax: (86)755-27521011 Http://www.sz-ctc.org.cn  
For anti-fake verification, please visit the official website of Certification and Accreditation Administration of the People's Republic of China : [yz.cnca.cn](http://yz.cnca.cn)





$\pi/4$ -DQPSK\_2402\_30~1000

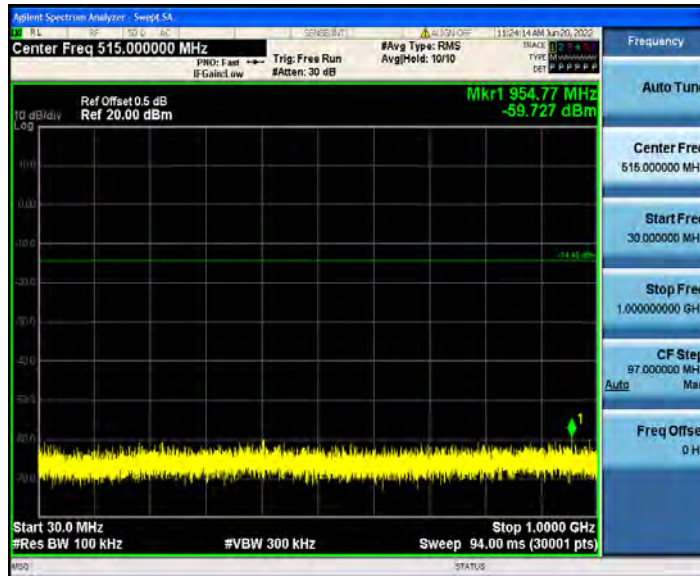

$\pi/4$ -DQPSK\_2402\_1000~26500

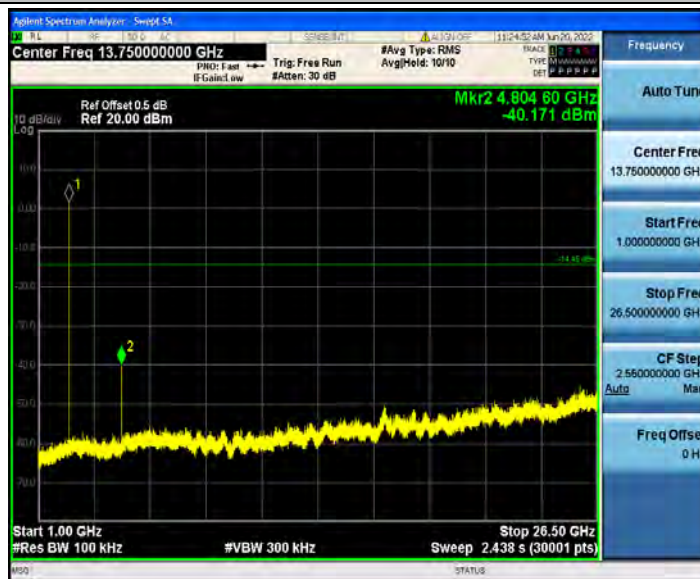

$\pi/4$ -DQPSK\_2441\_0~Reference

CTC Laboratories, Inc.

1-2/F., Building 2, Jiaquan Building, Guanlan High-Tech Park, Shenzhen, Guangdong, China  
 Tel.: (86)755-27521059

Fax: (86)755-27521011 Http://www.sz-ctc.org.cn  
 For anti-fake verification, please visit the official website of Certification and Accreditation Administration of the People's Republic of China : [yz.cnca.cn](http://yz.cnca.cn)





$\pi/4$ -DQPSK\_2441\_30~1000



$\pi/4$ -DQPSK\_2441\_1000~26500



$\pi/4$ -DQPSK\_2480\_0~Reference

CTC Laboratories, Inc.

1-2/F., Building 2, Jiaquan Building, Guanlan High-Tech Park, Shenzhen, Guangdong, China  
Tel.: (86)755-27521059

Fax: (86)755-27521011 Http://www.sz-ctc.org.cn  
For anti-fake verification, please visit the official website of Certification and Accreditation Administration of the People's Republic of China : [yz.cnca.cn](http://yz.cnca.cn)







$\pi/4$ -DQPSK\_2480\_30~1000



$\pi/4$ -DQPSK\_2480\_1000~26500

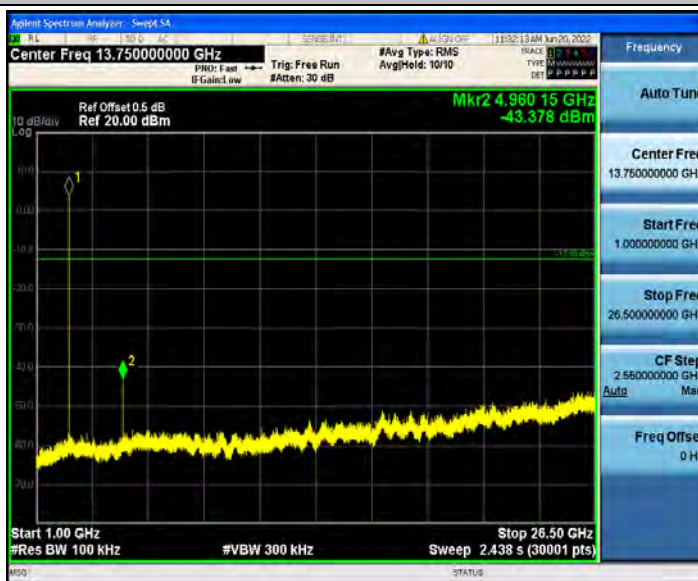

8-DPSK\_2402\_0~Reference

CTC Laboratories, Inc.

1-2/F., Building 2, Jiaquan Building, Guanlan High-Tech Park, Shenzhen, Guangdong, China  
 Tel.: (86)755-27521059

Fax: (86)755-27521011 Http://www.sz-ctc.org.cn  
 For anti-fake verification, please visit the official website of Certification and Accreditation Administration of the People's Republic of China : [yz.cnca.cn](http://yz.cnca.cn)







8-DPSK\_2402\_30~1000



8-DPSK\_2402\_1000~26500



8-DPSK\_2441\_0~Reference

CTC Laboratories, Inc.

1-2/F., Building 2, Jiaquan Building, Guanlan High-Tech Park, Shenzhen, Guangdong, China  
Tel.: (86)755-27521059

Fax: (86)755-27521011 Http://www.sz-ctc.org.cn  
For anti-fake verification, please visit the official website of Certification and Accreditation Administration of the People's Republic of China : [yz.cnca.cn](http://yz.cnca.cn)





8-DPSK\_2441\_30~1000



8-DPSK\_2441\_1000~26500



8-DPSK\_2480\_0~Reference

CTC Laboratories, Inc.

1-2/F., Building 2, Jiaquan Building, Guanlan High-Tech Park, Shenzhen, Guangdong, China  
Tel.: (86)755-27521059

Fax: (86)755-27521011 Http://www.sz-ctc.org.cn



For anti-fake verification, please visit the official website of Certification and Accreditation Administration of the People's Republic of China : [yz.cnca.cn](http://yz.cnca.cn)



8-DPSK\_2480\_30~1000

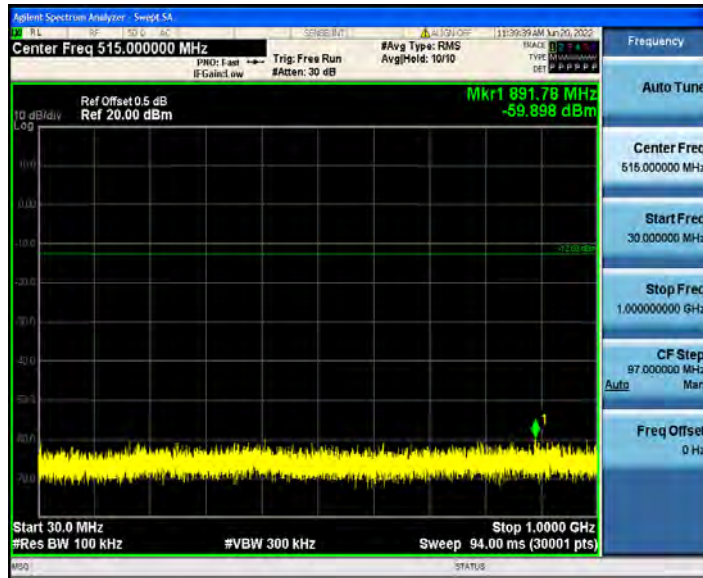

8-DPSK\_2480\_1000~26500

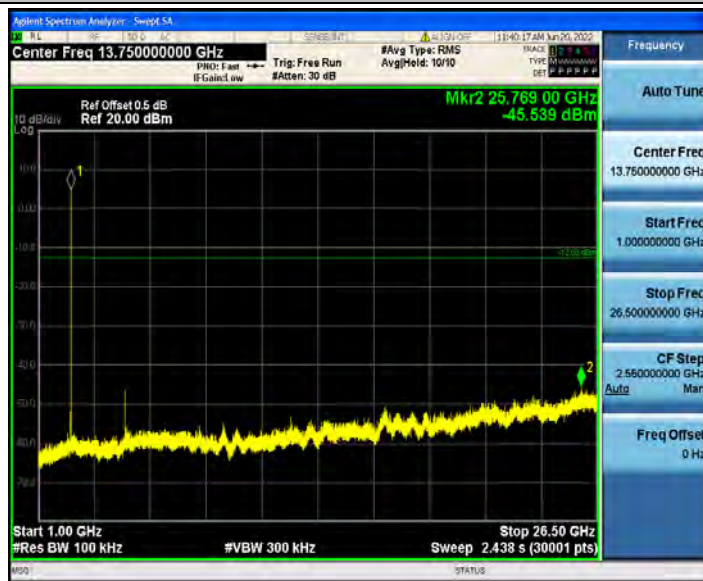





### 3.5. 20DB Bandwidth

#### Limit

N/A

#### Test Configuration

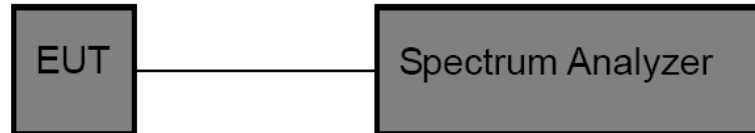

#### Test Procedure

5. The EUT was directly connected to the spectrum analyzer and antenna output port as show in the block diagram above.
6. OCB and 20dB Spectrum Setting:
  - (1) Set RBW = 1% ~ 5% occupied bandwidth.
  - (2) Set the video bandwidth (VBW)  $\geq 3$  RBW.
  - (3) Detector = Peak.
  - (4) Trace mode = Max hold.
  - (5) Sweep = Auto couple.

Note: The EUT was set to continuously transmitting in each mode and low, Middle and high channel for the test.

#### Test Mode

Please refer to the clause 2.4.

#### Test Results

Test Mode	Frequency[MHz]	20db EBW[MHz]	20dB Bandwidth *2/3 (kHz)	Verdict
GFSK	2402	0.948	632.00	PASS
	2441	0.942	628.00	PASS
	2480	0.945	630.00	PASS
$\pi/4$ -DQPSK	2402	1.323	882.00	PASS
	2441	1.314	876.00	PASS
	2480	1.317	878.00	PASS
8-DPSK	2402	1.296	864.00	PASS
	2441	1.266	844.00	PASS
	2480	1.317	878.00	PASS



GFSK\_2402



GFSK\_2441



GFSK\_2480



CTC Laboratories, Inc.

1-2/F., Building 2, Jiaquan Building, Guanlan High-Tech Park, Shenzhen, Guangdong, China  
Tel.: (86)755-27521059

Fax: (86)755-27521011 Http://www.sz-ctc.org.cn  
For anti-fake verification, please visit the official website of Certification and Accreditation Administration of the People's Republic of China : [yz.cnca.cn](http://yz.cnca.cn)





$\pi/4$ -DQPSK\_2402



$\pi/4$ -DQPSK\_2441



$\pi/4$ -DQPSK\_2480



8-DPSK\_2402

CTC Laboratories, Inc.

1-2/F., Building 2, Jiaquan Building, Guanlan High-Tech Park, Shenzhen, Guangdong, China  
Tel.: (86)755-27521059

Fax: (86)755-27521011 Http://www.sz-ctc.org.cn  
For anti-fake verification, please visit the official website of Certification and Accreditation Administration of the People's Republic of China : [yz.cnca.cn](http://yz.cnca.cn)







8-DPSK\_2441



8-DPSK\_2480







### 3.6. Channel Separation

#### Limit

FCC CFR Title 47 Part 15 Subpart C Section 15.247 (a)(1)/ RSS-247 5.1 b :

Test Item	Limit	Frequency Range(MHz)
Channel Separation	>25KHz or >two-thirds of the 20 dB bandwidth Which is greater	2400~2483.5

#### Test Configuration

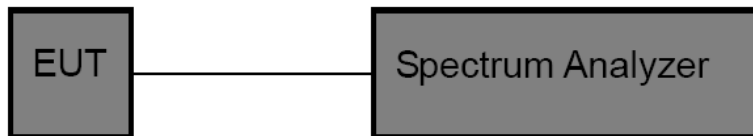

#### Test Procedure

7. The EUT was directly connected to the spectrum analyzer and antenna output port as show in the block diagram above.
8. Spectrum Setting:
  - (1) Set RBW = 100 kHz.
  - (2) Set the video bandwidth (VBW) ≥ 3 RBW.
  - (3) Detector = Peak.
  - (4) Trace mode = Max hold.
  - (5) Sweep = Auto couple.

#### Test Mode

Please refer to the clause 2.4.

**Test Results**

Test Mode	Frequency[MHz]	Result[MHz]	Limit[kHz]	Verdict
GFSK	Hop_2441	0.982	>628.00	PASS
$\pi/4$ -DQPSK	Hop_2441	0.996	>876.00	PASS
8-DPSK	Hop_2441	1.026	>844.00	PASS



### GFSK\_Hop\_2441



### $\pi/4$ -DQPSK\_Hop\_2441



### 8-DPSK\_Hop\_2441



CTC Laboratories, Inc.

1-2/F., Building 2, Jiaquan Building, Guanlan High-Tech Park, Shenzhen, Guangdong, China  
Tel.: (86)755-27521059

Fax: (86)755-27521011 Http://www.sz-ctc.org.cn  
For anti-fake verification, please visit the official website of Certification and Accreditation Administration of the People's Republic of China : [yz.cnca.cn](http://yz.cnca.cn)





### 3.7. Number of Hopping Channel

#### Limit

FCC CFR Title 47 Part 15 Subpart C Section 15.247 (a)(iii)/ RSS-247 5.1 d:

Section	Test Item	Limit
15.247 (a)(iii)/ RSS-247 5.1 d:	Number of Hopping Channel	>15

#### Test Configuration

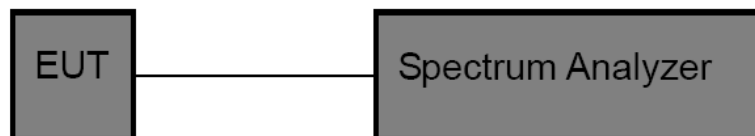

#### Test Procedure

- The EUT was directly connected to the spectrum analyzer and antenna output port as show in the block diagram above.
- Spectrum Setting:
  - Peak Detector: RBW=100 kHz, VBW $\geq$ RBW, Sweep time= Auto.

#### Test Mode

Please refer to the clause 2.4.

#### Test Result

Modulation type	Channel number	Limit	Result
GFSK	79	$\geq 15.00$	Pass
$\pi/4$ -DQPSK	79		
8DPSK	79		



### GFSK



### $\pi/4$ -DQPSK

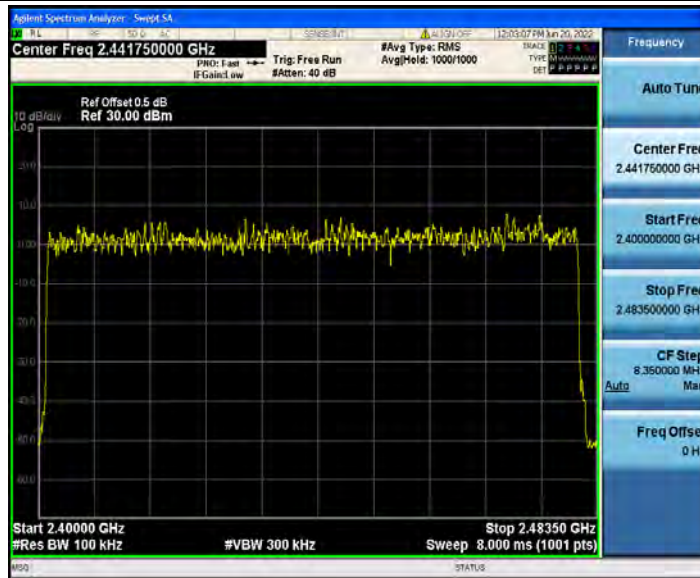

### 8-DPSK



CTC Laboratories, Inc.

1-2/F., Building 2, Jiaquan Building, Guanlan High-Tech Park, Shenzhen, Guangdong, China  
 Tel.: (86)755-27521059

Fax: (86)755-27521011 Http://www.sz-ctc.org.cn  
 For anti-fake verification, please visit the official website of Certification and Accreditation Administration of the People's Republic of China : [yz.cnca.cn](http://yz.cnca.cn)





### 3.8. Dwell Time

#### Limit

Section	Test Item	Limit
15.247(a)(iii)/ RSS-247 5.1 d	Average Time of Occupancy	0.4 sec

#### Test Configuration

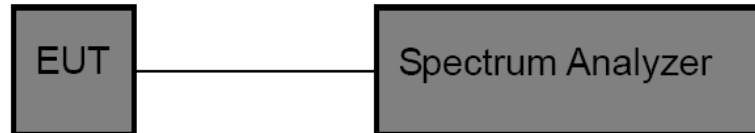

#### Test Procedure

1. The EUT was directly connected to the spectrum analyzer and antenna output port as show in the block diagram above.
2. Spectrum Setting:
  - (1) Spectrum Setting: RBW=1MHz, VBW $\geq$ RBW.
  - (2) Use video trigger with the trigger level set to enable triggering only on full pulses.
  - (3) Sweep Time is more than once pulse time.
  - (4) Set the center frequency on any frequency would be measure and set the frequency span to zero.
  - (5) Measure the maximum time duration of one single pulse.
  - (6) Set the EUT for packet transmitting.

#### Test Mode

Please refer to the clause 2.4.

**Test Result**

Modulation type	Channel	Frequency [MHz]	Pulse Time (ms)	Total of Dwell (ms)	Period Time (ms)	Limit (Second)	Result
GFSK	DH1	2441	0.38	121.60	31.60	≤ 0.40	Pass
	DH3	2441	1.64	262.40	31.60		
	DH5	2441	2.88	307.20	31.60		
π/4-DQPSK	2DH1	2441	0.39	124.80	31.60	≤ 0.40	Pass
	2DH3	2441	1.64	262.40	31.60		
	2DH5	2441	2.89	308.27	31.60		
8-DPSK	3DH1	2441	0.39	124.80	31.60	≤ 0.40	Pass
	3DH3	2441	1.64	262.40	31.60		
	3DH5	2441	2.89	308.27	31.60		

Note: 1DH1/2DH1/3DH1 Total of Dwell= Pulse Time\*(1600/2)\*31.6/79

1DH3/2DH3/3DH3 Total of Dwell= Pulse Time\*(1600/4)\*31.6/79

1DH5/2DH5/3DH5 Total of Dwell= Pulse Time\*(1600/6)\*31.6/79





GFSK\_2402

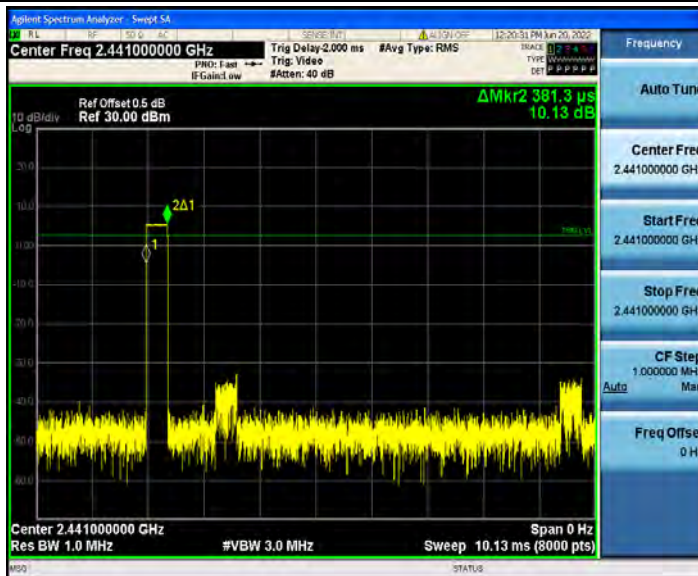

GFSK\_2441



GFSK\_2480



CTC Laboratories, Inc.

1-2/F., Building 2, Jiaquan Building, Guanlan High-Tech Park, Shenzhen, Guangdong, China  
Tel.: (86)755-27521059 Fax: (86)755-27521011 Http://www.sz-ctc.org.cn



For anti-fake verification, please visit the official website of Certification and Accreditation Administration of the People's Republic of China : [yz.cnca.cn](http://yz.cnca.cn)



$\pi/4$ -DQPSK\_2402

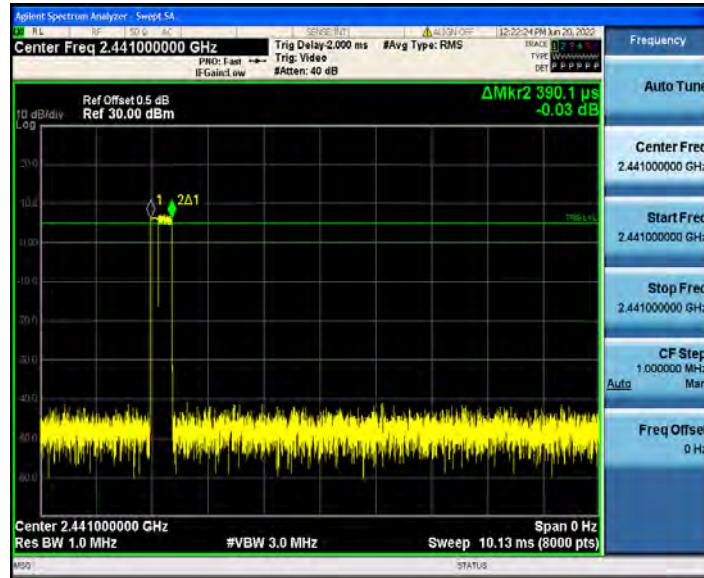

$\pi/4$ -DQPSK\_2441

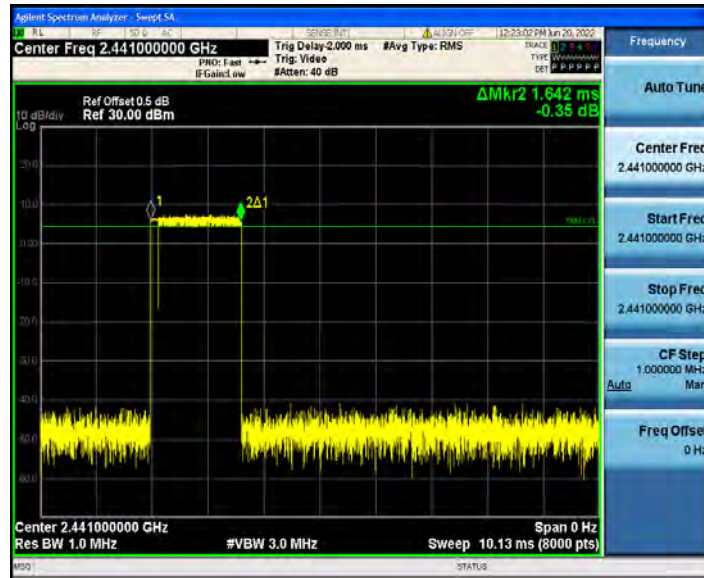

$\pi/4$ -DQPSK\_2480

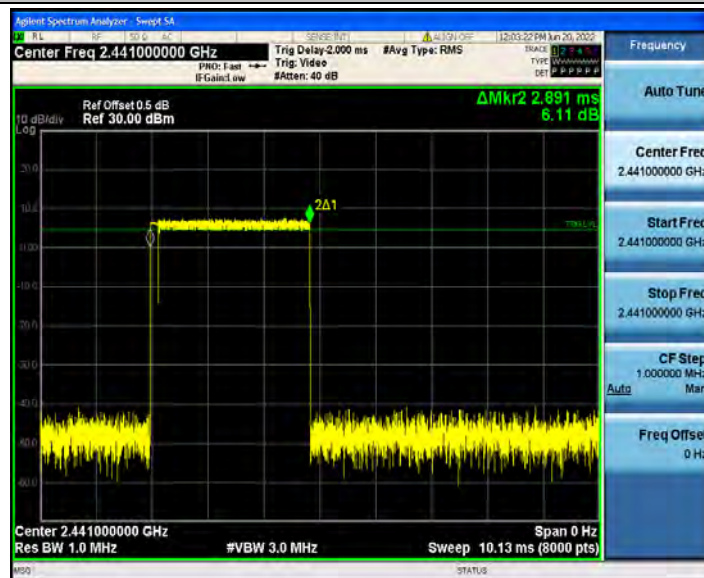

8-DPSK\_2402

CTC Laboratories, Inc.

1-2/F., Building 2, Jiaquan Building, Guanlan High-Tech Park, Shenzhen, Guangdong, China  
Tel.: (86)755-27521059

Fax: (86)755-27521011 Http://www.sz-ctc.org.cn  
For anti-fake verification, please visit the official website of Certification and Accreditation Administration of the People's Republic of China : [yz.cnca.cn](http://yz.cnca.cn)





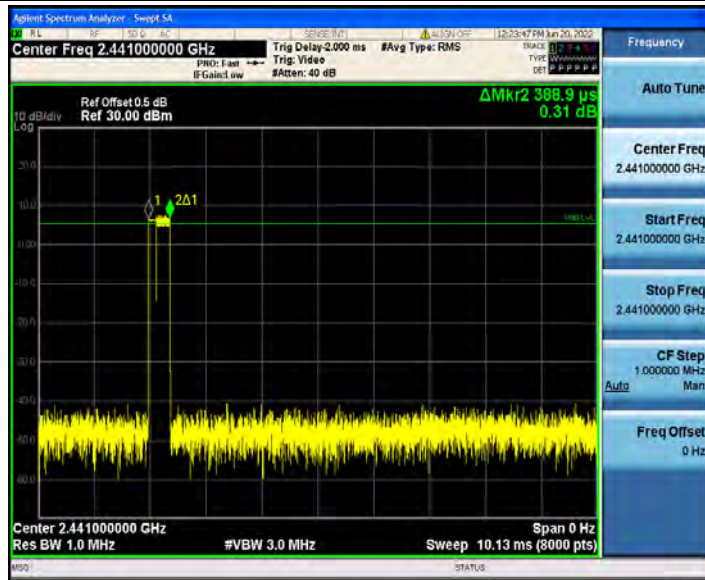

8-DPSK\_2441

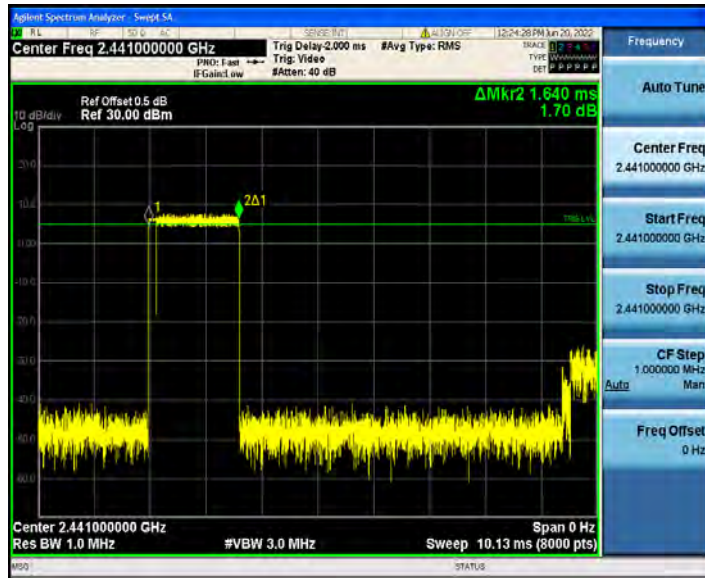

8-DPSK\_2480

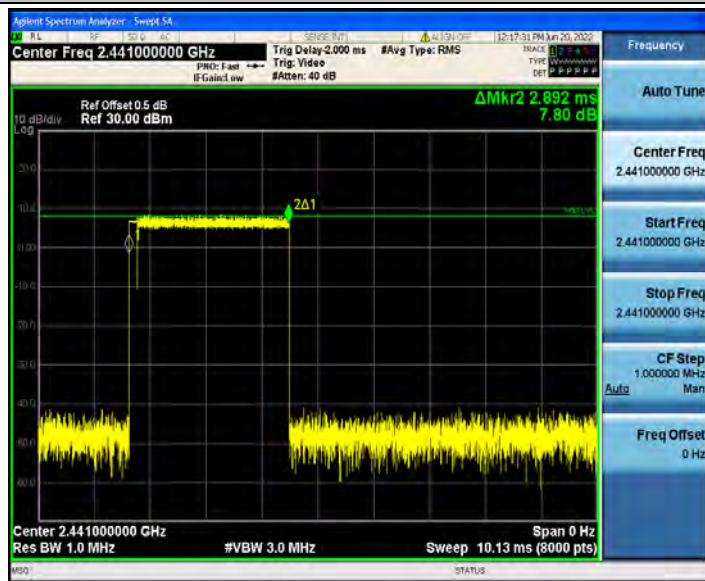

CTC Laboratories, Inc.

1-2/F., Building 2, Jiaquan Building, Guanlan High-Tech Park, Shenzhen, Guangdong, China  
Tel.: (86)755-27521059 Fax: (86)755-27521011 Http://www.sz-ctc.org.cn



For anti-fake verification, please visit the official website of Certification and Accreditation Administration of the People's Republic of China : [yz.cnca.cn](http://yz.cnca.cn)



### 3.9. Peak Output Power

#### Limit

FCC CFR Title 47 Part 15 Subpart C Section 15.247 (b)(1) / RSS-247 5.4 b:

Test Item	Limit	Frequency Range(MHz)
Maximum Conducted Peak Output Power	Hopping Channels>75 Power<1W(30dBm) Other <125mW(21dBm)	2400~2483.5
E.I.R.P	4 Watt or 36dBm	2400~2483.5

#### Test Configuration

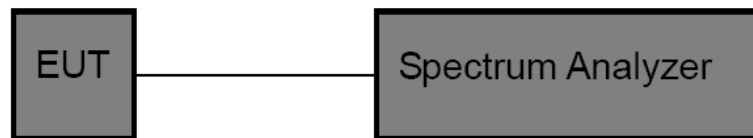

#### Test Procedure

- The EUT was directly connected to the spectrum analyzer and antenna output port as show in the block diagram above.
- Spectrum Setting:
  - Set RBW> 20DB Bandwidth.
  - Set the video bandwidth (VBW) ≥ RBW.
  - Detector = Peak.
  - Trace mode = Max hold.
  - Sweep = Auto couple.

#### Test Mode

Please refer to the clause 2.4.

#### Test Result

Test Mode	Frequency[MHz]	Conducted Result[dBm]	Limit[dBm]	Verdict
GFSK	2402	4.78	≤30	PASS
	2441	5.32	≤30	PASS
	2480	6.98	≤30	PASS
π/4-DQPSK	2402	6.97	≤30	PASS
	2441	7.67	≤30	PASS
	2480	8.94	≤30	PASS
8-DPSK	2402	7.46	≤30	PASS
	2441	8.16	≤30	PASS
	2480	9.85	≤30	PASS



GFSK\_2402



GFSK\_2441



GFSK\_2480



CTC Laboratories, Inc.

1-2/F., Building 2, Jiaquan Building, Guanlan High-Tech Park, Shenzhen, Guangdong, China  
 Tel.: (86)755-27521059 Fax: (86)755-27521011 Http://www.sz-ctc.org.cn



For anti-fake verification, please visit the official website of Certification and Accreditation Administration of the People's Republic of China : [yz.cnca.cn](http://yz.cnca.cn)





$\pi/4$ -DQPSK\_2402



$\pi/4$ -DQPSK\_2441



$\pi/4$ -DQPSK\_2480



8-DPSK\_2402

CTC Laboratories, Inc.

1-2/F., Building 2, Jiaquan Building, Guanlan High-Tech Park, Shenzhen, Guangdong, China  
 Tel.: (86)755-27521059

Fax: (86)755-27521011 Http://www.sz-ctc.org.cn  
 For anti-fake verification, please visit the official website of Certification and Accreditation Administration of the People's Republic of China : [yz.cnca.cn](http://yz.cnca.cn)







8-DPSK\_2441



8-DPSK\_2480

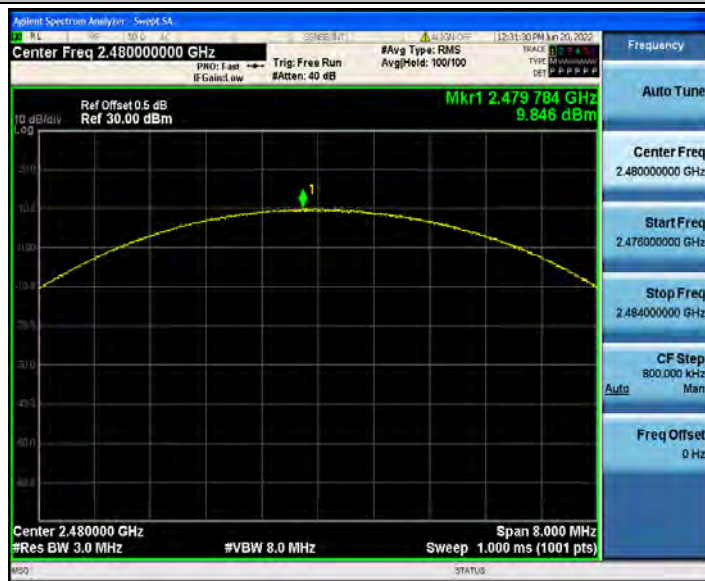

CTC Laboratories, Inc.

1-2/F., Building 2, Jiaquan Building, Guanlan High-Tech Park, Shenzhen, Guangdong, China  
 Tel.: (86)755-27521059

Fax: (86)755-27521011 Http://www.sz-ctc.org.cn  
 For anti-fake verification, please visit the official website of Certification and Accreditation Administration of the People's Republic of China : [yz.cnca.cn](http://yz.cnca.cn)





### 3.10. Duty Cycle

#### Limit

None, for report purposes only.

#### Test Configuration

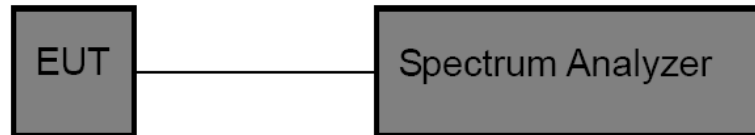

#### Test Procedure

1. The EUT was directly connected to the spectrum analyzer and antenna output port as show in the block diagram above.
2. The EUT was directly connected to the Spectrum Analyzer and antenna output port as show in the block diagram above. The measurement according to section 10.2 of KDB 558074 D01 DTS Meas Guidance v05r02.
3. Spectrum Setting:  
Set analyzer center frequency to test channel center frequency.  
Set the span to 0Hz  
Set the RBW to 10MHz  
Set the VBW to 10MHz  
Detector: Peak  
Sweep time: Auto  
Allow trace to fully stabilize. Then use the peak marker function to determine the maximum amplitude level.

#### Test Mode

Please refer to the clause 2.4.

#### Test Result

Test Mode	Frequency [MHz]	Transmission Duration [ms]	Transmission Period [ms]	Duty Cycle [%]	1/T Minimum VBW (kHz)	Final setting For VBW (kHz)
GFSK	2402	2.88	3.73	77.21	0.35	1
	2441	2.88	3.73	77.21	0.35	1
	2480	2.88	3.73	77.21	0.35	1
$\pi/4$ -DQPSK	2402	2.89	3.73	77.48	0.35	1
	2441	2.89	3.73	77.48	0.35	1
	2480	2.89	3.73	77.48	0.35	1
8-DPSK	2402	2.89	3.74	77.27	0.35	1
	2441	2.89	3.74	77.27	0.35	1
	2480	2.89	3.74	77.27	0.35	1



GFSK\_2402

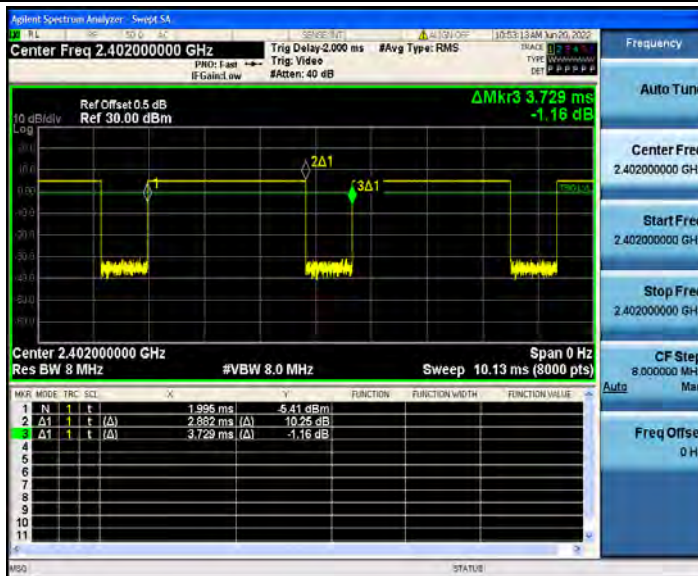

GFSK\_2441

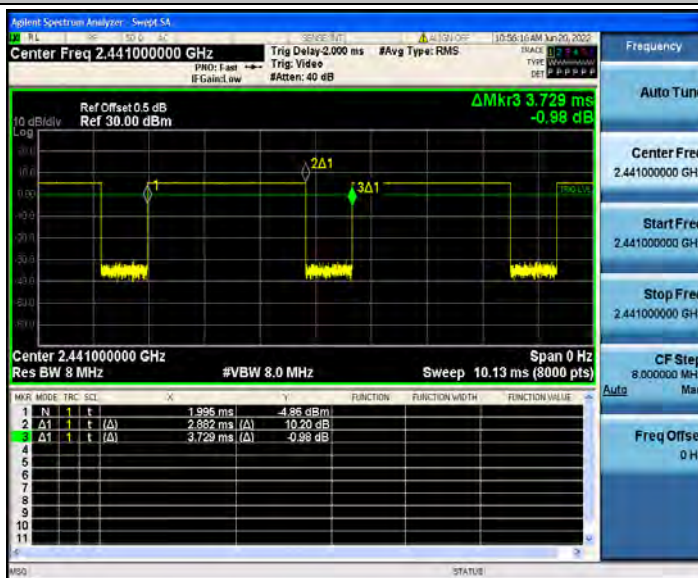

GFSK\_2480

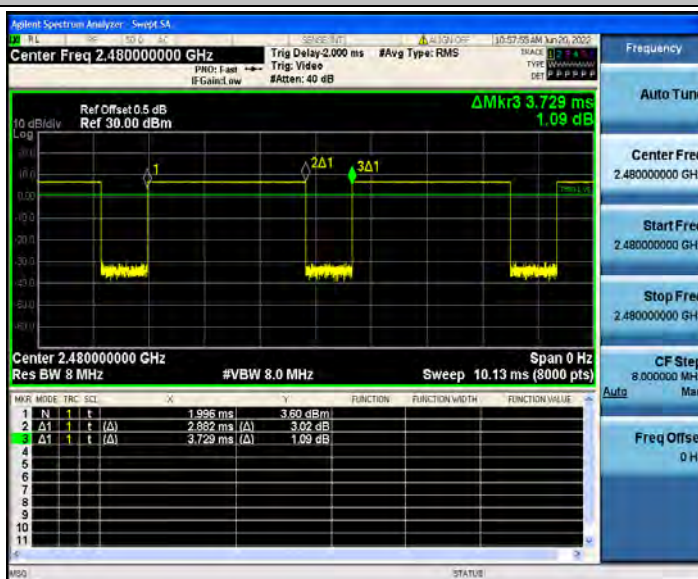

CTC Laboratories, Inc.

1-2/F., Building 2, Jiaquan Building, Guanlan High-Tech Park, Shenzhen, Guangdong, China  
Tel.: (86)755-27521059

Fax: (86)755-27521011 Http://www.sz-ctc.org.cn  
For anti-fake verification, please visit the official website of Certification and Accreditation Administration of the People's Republic of China : [yz.cnca.cn](http://yz.cnca.cn)







$\pi/4$ -DQPSK\_2402

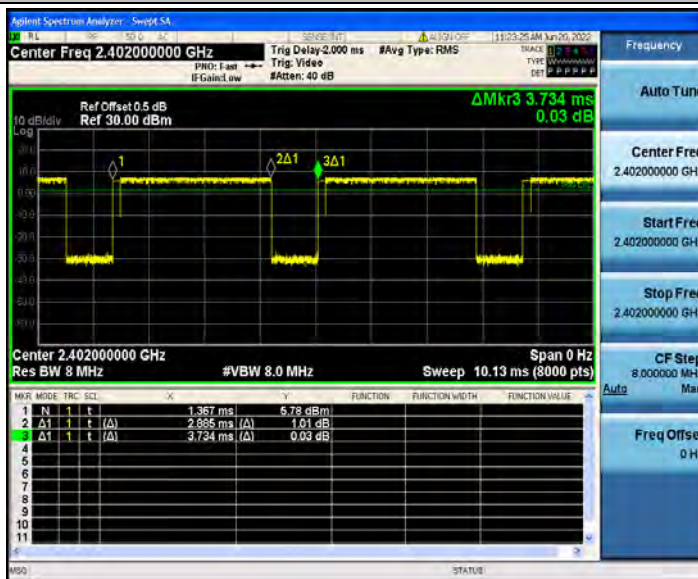

$\pi/4$ -DQPSK\_2441

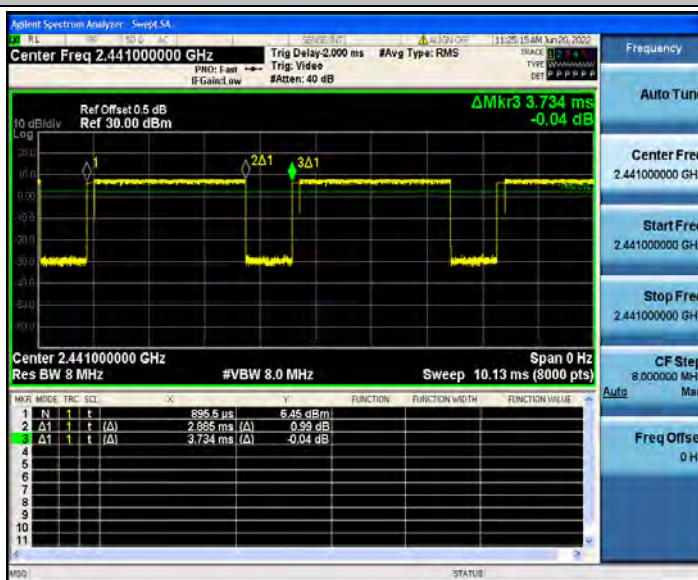

$\pi/4$ -DQPSK\_2480

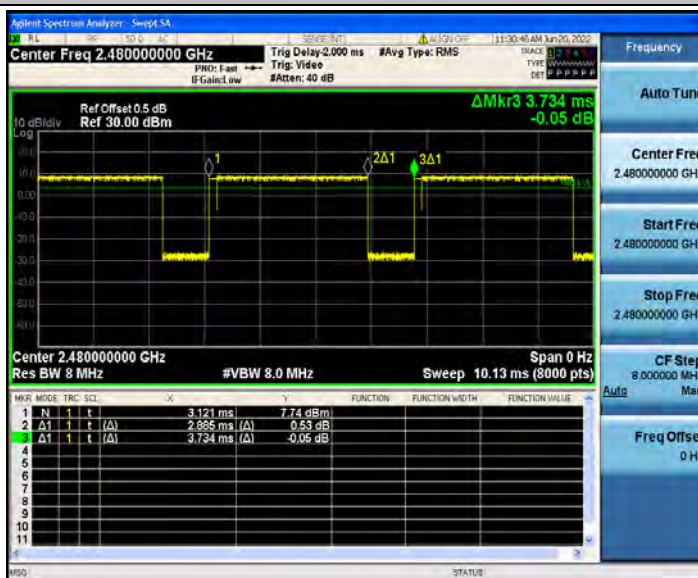

8-DPSK\_2402

CTC Laboratories, Inc.

1-2/F., Building 2, Jiaquan Building, Guanlan High-Tech Park, Shenzhen, Guangdong, China  
Tel.: (86)755-27521059

Fax: (86)755-27521011 Http://www.sz-ctc.org.cn  
For anti-fake verification, please visit the official website of Certification and Accreditation Administration of the People's Republic of China : [yz.cnca.cn](http://yz.cnca.cn)





8-DPSK\_2441

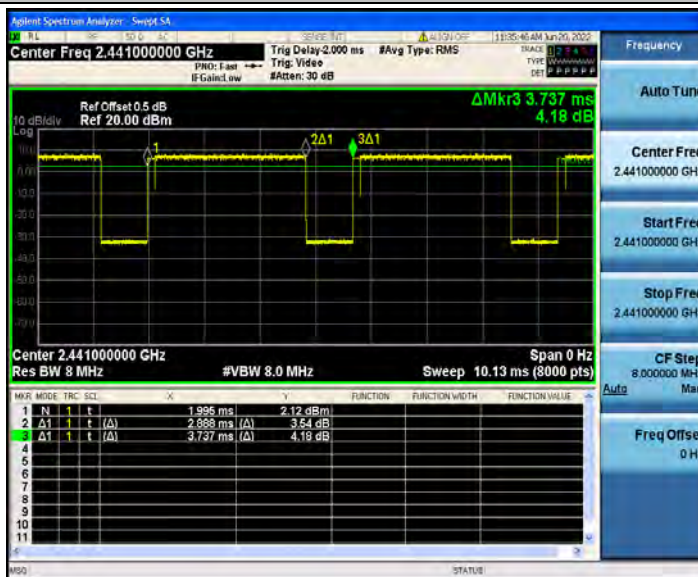

8-DPSK\_2480

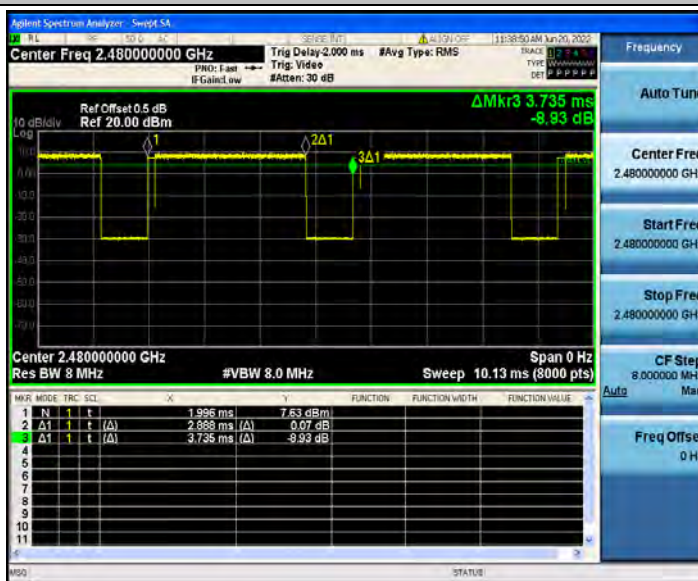





### 3.11. Antenna requirement

#### Requirement

##### **FCC CFR Title 47 Part 15 Subpart C Section 15.203:**

An intentional radiator shall be designed to ensure that no antenna other than that furnished by the responsible party shall be used with the device. The use of a permanently attached antenna or of antenna that uses a unique coupling to the intentional radiator, the manufacturer may design the unit so that a broken antenna can be replaced by the user, but the use of a standard antenna jack or electrical connector is prohibited.

##### **FCC CFR Title 47 Part 15 Subpart C Section 15.247(c) (1)(i):**

(i) Systems operating in the 2400~2483.5 MHz band that is used exclusively for fixed. Point-to-point operations may employ transmitting antennas with directional gain greater than 6dBi provided the maximum conducted output power of the intentional radiator is reduced by 1 dB for every 3 dB that the directional gain of the antenna exceeds 6dBi.

#### Test Result

The directional gain of the antenna less than 6dBi, please refer to the EUT internal photographs antenna photo.

\*\*\*\*\*THE END\*\*\*\*\*