



# CTC Laboratories, Inc.

2/F., Building 1 and 1-2/F., Building 2, Jiaquan Building, Guanlan High-Tech Park, Longhua District, Shenzhen, Guangdong, China

Tel: +86-755- 27521059 Fax: +86-755- 27521011 Http://www.sz-ctc.com.cn

## TEST REPORT

**Report No.** .....: **CTC20192369E06**

**FCC ID**.....: **2APPZ-J4G**

**Applicant**.....: **Fanvil Technology Co., Ltd**

Address.....: 4F, Block A, Building 1#, GaoXinQi Hi-Tech Park (Phase-II), 67th District, Bao'An, Shenzhen, China

Manufacturer.....: Fanvil Technology Co., Ltd

Address.....: 4F, Block A, Building 1#, GaoXinQi Hi-Tech Park (Phase-II), 67th District, Bao'An, Shenzhen, China

**Product Name**.....: **IP Phone**

Trade Mark.....: Fanvil

Model/Type reference.....: J4G

Listed Model(s) .....: N/A

**Standard**.....: **FCC CFR Title 47 Part 15 Subpart C Section 15.247**

Date of receipt of test sample....: Dec. 30, 2019

Date of testing.....: Dec. 31, 2019 to Jan. 13, 2020

Date of issue.....: Jan. 14, 2020

**Result**.....: **PASS**

Compiled by:		
(Printed name+signature)	Terry Su	
Supervised by:		
(Printed name+signature)	Miller Ma	
Approved by:		
(Printed name+signature)	Walter Chen	

**Testing Laboratory Name**..... **CTC Laboratories, Inc.**

Address ..... 2/F., Building 1 and 1-2/F., Building 2, Jiaquan Building, Guanlan High-Tech Park, Longhua District, Shenzhen, Guangdong, China

This test report may be duplicated completely for legal use with the approval of the applicant. It should not be reproduced except in full, without the written approval of our laboratory. The client should not use it to claim product endorsement by CTC. The test results in the report only apply to the tested sample. The test report shall be invalid without all the signatures of testing engineers, reviewer and approver. Any objections must be raised to CTC within 15 days since the date when the report is received. It will not be taken into consideration beyond this limit. The test report merely correspond to the test sample.



Table of Contents

Page

**1. TEST SUMMARY..... 3**

1.1. TEST STANDARDS.....3

1.2. REPORT VERSION.....3

1.3. TEST DESCRIPTION.....4

1.4. TEST FACILITY .....5

1.5. MEASUREMENT UNCERTAINTY .....5

1.6. ENVIRONMENTAL CONDITIONS .....6

**2. GENERAL INFORMATION..... 7**

2.1. CLIENT INFORMATION .....7

2.2. GENERAL DESCRIPTION OF EUT .....7

2.3. OPERATION STATE.....8

2.4. MEASUREMENT INSTRUMENTS LIST .....9

**3. TEST ITEM AND RESULTS..... 11**

3.1. CONDUCTED EMISSION.....11

3.2. RADIATED EMISSION .....14

3.3. BAND EDGE EMISSIONS.....36

3.4. OCCUPIED CHANNEL BANDWIDTH AND 20DB BANDWIDTH.....55

3.5. CHANNEL SEPARATION.....62

3.6. NUMBER OF HOPPING CHANNEL.....67

3.7. DWELL TIME .....69

3.8. PEAK OUTPUT POWER .....74

3.9. ANTENNA REQUIREMENT .....78

**4. LABEL AND LABEL LOCATION ..... 79**

**5. EUT TEST PHOTOS..... 80**

**6. PHOTOGRAPHS OF EUT CONSTRUCTIONAL ..... 82**



# 1. TEST SUMMARY

## 1.1. Test Standards

The tests were performed according to following standards:

[FCC Rules Part 15.247](#): Operation within the bands of 902-928MHz, 2400-2483.5MHz, and 5725-5850MHz.

[RSS 247 Issue 2](#): Standard Specifications for Frequency Hopping Systems (FHSs) and Digital Transmission Systems (DTSS) Operating in the Bands 902-928MHz, 2400-2483.5MHz and 5725-5850MHz.

[ANSI C63.10-2013](#): American National Standard for Testing Unlicensed Wireless Devices.

## 1.2. Report version

Revised No.	Date of issue	Description
01	Jan. 14, 2020	Original



### 1.3. Test Description

FCC Part 15 Subpart C (15.247)/ RSS 247 Issue 2				
Test Item	Standard Section		Result	Test Engineer
	FCC	IC		
Antenna Requirement	15.203	/	Pass	Lucy Lan
Conducted Emission	15.207	RSS-Gen 8.8	Pass	Jon Huang
Restricted Bands	15.205	RSS-Gen 8.10	Pass	Lucy Lan
Hopping Channel Separation	15.247(a)(1)	RSS 247 5.1 (b)	Pass	Lucy Lan
Dwell Time	15.247(a)(iii)	RSS 247 5.1 (d)	Pass	Lucy Lan
Peak Output Power	15.247(b)(1)	RSS 247 5.4 (b)	Pass	Lucy Lan
Number of Hopping Frequency	15.247(a)(iii)	RSS 247 5.1 (d)	Pass	Lucy Lan
Band Edge Emissions	15.247(d)	RSS 247 5.5	Pass	Lucy Lan
Radiated Spurious Emission	15.247(d)&15.209	RSS 247 5.5& RSS-Gen 8.9	Pass	Terry Su
99% Occupied Bandwidth & 20dB Bandwidth	15.247(a)	RSS 247 5.1 (b)	Pass	Lucy Lan

Note: The measurement uncertainty is not included in the test result.



## 1.4. Test Facility

### Address of the report laboratory

#### CTC Laboratories, Inc.

Add: 2/F., Building 1 and 1-2/F., Building 2, Jiaquan Building, Guanlan High-Tech Park, Longhua District, Shenzhen, Guangdong, China

### Laboratory accreditation

The test facility is recognized, certified, or accredited by the following organizations:

#### CNAS-Lab Code: L5365

CTC Laboratories, Inc. has been assessed and proved to be in compliance with CNAS-CL01 Accreditation. Criteria for Testing and Calibration Laboratories (identical to ISO/IEC17025: 2005 General Requirements) for the Competence of Testing and Calibration Laboratories.

#### A2LA-Lab Cert. No.: 4340.01

CTC Laboratories, Inc. EMC Laboratory has been accredited by A2LA for technical competence in the field of electrical testing, and proved to be in compliance with ISO/IEC 17025:2017 General Requirements for the Competence of Testing and Calibration Laboratories and any additional program requirements in the identified field of testing.

#### Industry Canada (Registration No.: 9783A, CAB Identifier: CN0029)

CTC Laboratories, Inc. EMC Laboratory has been registered by Certification and Engineer Bureau of Industry Canada for the performance of with Registration NO.: 9783A on Jan, 2016.

#### FCC (Registration No.: 951311, Designation Number CN1208)

CTC Laboratories, Inc. EMC Laboratory has been registered and fully described in a report filed with the (FCC) Federal Communications Commission. The acceptance letter from the FCC is maintained in our files. Registration 951311, Aug 26, 2017.

## 1.5. Measurement Uncertainty

The data and results referenced in this document are true and accurate. The reader is cautioned that there may be errors within the calibration limits of the equipment and facilities. The measurement uncertainty was calculated for all measurements listed in this test report acc. to TR-100028-01 "Electromagnetic compatibility and Radio spectrum Matters (ERM); Uncertainties in the measurement of mobile radio equipment characteristics; Part 1" and TR-100028-02 "Electromagnetic compatibility and Radio spectrum Matters (ERM); Uncertainties in the measurement of mobile radio equipment characteristics; Part 2" and is documented in the CTC Laboratories, Inc. quality system acc. to DIN EN ISO/IEC 17025. Furthermore, component and process variability of devices similar to that tested may result in additional deviation. The manufacturer has the sole responsibility of continued compliance of the device.

Below is the best measurement capability for CTC Laboratories, Inc.



Test Items	Measurement Uncertainty	Notes
Transmitter power conducted	0.42 dB	(1)
Transmitter power Radiated	2.14 dB	(1)
Conducted spurious emissions 9kHz~40GHz	1.60 dB	(1)
Radiated spurious emissions 9kHz~40GHz	2.20 dB	(1)
Conducted Emissions 9kHz~30MHz	3.20 dB	(1)
Radiated Emissions 30~1000MHz	4.70 dB	(1)
Radiated Emissions 1~18GHz	5.00 dB	(1)
Radiated Emissions 18~40GHz	5.54 dB	(1)
Occupied Bandwidth	-----	(1)

**Note (1):** This uncertainty represents an expanded uncertainty expressed at approximately the 95% confidence level using a coverage factor of  $k=1.96$ .

## 1.6. Environmental conditions

During the measurement the environmental conditions were within the listed ranges:

Temperature:	25°C
Relative Humidity:	40%
Air Pressure:	101kPa

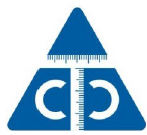

## 2. GENERAL INFORMATION

### 2.1. Client Information

Applicant:	Fanvil Technology Co., Ltd
Address:	4F, Block A, Building 1#, GaoXinQi Hi-Tech Park (Phase-II), 67th District, Bao'An, Shenzhen, China
Manufacturer:	Fanvil Technology Co., Ltd
Address:	4F, Block A, Building 1#, GaoXinQi Hi-Tech Park (Phase-II), 67th District, Bao'An, Shenzhen, China

### 2.2. General Description of EUT

Product Name:	IP Phone
Trade Mark:	Fanvil
Model/Type reference:	J4G
Listed Model(s):	N/A
Power supply:	Supplied from POE 5Vdc/2A from AC/DC Adapter
Adapter Model:	F12W8-050200SPAU Input: AC100-240V 50/60Hz 0.3A Output:5V/2A
Hardware version:	N/A
Software version:	N/A
<b>Bluetooth 2.1+EDR</b>	
Modulation:	GFSK, $\pi/4$ -DQPSK, 8-DPSK
Operation frequency:	2402MHz~2480MHz
Channel number:	79
Channel separation:	1MHz
Antenna type:	FPC Antenna
Antenna gain:	2.8dBi



### 2.3. Operation state

Operation Frequency List: The EUT has been tested under typical operating condition. The Applicant provides communication tools software to control the EUT for staying in continuous transmitting and receiving mode for testing. BT EDR, 79 channels are provided to the EUT. Channels 00/39/78 were selected for testing.

Operation Frequency List:

Channel	Frequency (MHz)
<b>00</b>	<b>2402</b>
01	2403
:	:
38	2440
<b>39</b>	<b>2441</b>
40	2442
:	:
77	2479
<b>78</b>	<b>2480</b>

Note: The display in grey were the channel selected for testing.

Test mode

For RF test items:
The engineering test program was provided and enabled to make EUT continuous transmit
For AC power line conducted emissions:
The EUT was set to connect with the Bluetooth instrument under large package sizes transmission.
For Radiated spurious emissions test item:
The engineering test program was provided and enabled to make EUT continuous transmit. The EUT in each of three orthogonal axis emissions had been tested, but only the worst case (X axis) data recorded in the report.



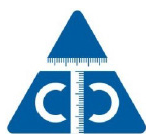

## 2.4. Measurement Instruments List

Tonscend JS0806-2 Test system					
Item	Test Equipment	Manufacturer	Model No.	Serial No.	Calibrated until
1	Spectrum Analyzer	Rohde & Schwarz	FSU26	100105	Dec. 28, 2020
2	Spectrum Analyzer	Rohde & Schwarz	FUV40-N	101331	Mar. 13, 2020
3	MXG Vector Signal Generator	Agilent	N5182A	MY47420864	Dec. 28, 2020
4	Signal Generator	Agilent	E8257D	MY46521908	Dec. 28, 2020
5	Power Sensor	Agilent	U2021XA	MY5365004	Dec. 28, 2020
6	Power Sensor	Agilent	U2021XA	MY5365006	Dec. 28, 2020
7	Simultaneous Sampling DAQ	Agilent	U2531A	TW54493510	Dec. 28, 2020
8	Climate Chamber	TABAI	PR-4G	A8708055	Dec. 28, 2020
9	Wideband Radio Communication Tester	Rohde & Schwarz	CMW500	116410	Dec. 28, 2020
10	Climate Chamber	ESPEC	MT3065	/	Dec. 28, 2020
11	Wideband Radio Communication Tester	Rohde & Schwarz	CMW500	116410	Dec. 28, 2020
12	300328 v2.1.1 test system	TONSCEND	v2.6	/	/

Radiated Emission and Transmitter spurious emissions					
Item	Test Equipment	Manufacturer	Model No.	Serial No.	Calibrated until
1	EMI Test Receiver	Rohde & Schwarz	ESCI	100658	Dec. 28, 2020
2	High pass filter	micro-tranics	HPM50111	142	Dec. 28, 2020
3	Log-Bicon Antenna	Schwarzbeck	CBL6141A	4180	Dec. 28, 2020
4	Ultra-Broadband Antenna	ShwarzBeck	BBHA9170	25841	Dec. 28, 2020
5	Loop Antenna	LAPLAC	RF300	9138	Dec. 28, 2020
6	Spectrum Analyzer	Rohde & Schwarz	FSU26	100105	Dec. 28, 2020
7	Horn Antenna	Schwarzbeck	BBHA 9120D	647	Dec. 28, 2020
8	Pre-Amplifier	HP	8447D	1937A03050	Dec. 28, 2020
9	Pre-Amplifier	EMCI	EMC051835	980075	Dec. 28, 2020
10	Antenna Mast	UC	UC3000	N/A	N/A
11	Turn Table	UC	UC3000	N/A	N/A
12	Cable Below 1GHz	Schwarzbeck	AK9515E	33155	Dec. 28, 2020
13	Cable Above 1GHz	Hubersuhner	SUCOFLEX102	DA1580	Dec. 28, 2020
14	Splitter	Mini-Circuit	ZAPD-4	400059	Dec. 28, 2020
15	RF Connection Cable	HUBER+SUHNER	RE-7-FL	N/A	Dec. 28, 2020

CTC Laboratories, Inc.

2/F., Building 1 and 1-2/F., Building 2, Jiaquan Building, Guanlan High-Tech Park, Longhua District, Shenzhen, Guangdong, China

Tel.: (86)755-27521059

Fax: (86)755-27521011

Http://www.sz-ctc.org.cn

中国国家认证认可监督管理委员会  
Certification and Accreditation Administration of the People's Republic of ChinaFor anti-fake verification, please visit the official website of Certification and Accreditation Administration of the People's Republic of China : [yz.cnca.cn](http://yz.cnca.cn)



16	RF Connection Cable	Chengdu E-Microwave	---	---	Dec. 28, 2020
17	High pass filter	Compliance Direction systems	BSU-6	34202	Dec. 28, 2020
18	Attenuator	Chengdu E-Microwave	EMCAXX-10R NZ-3	---	Dec. 28, 2020
19	High and low temperature box	ESPEC	MT3065	12114019	Dec. 28, 2020

Conducted Emission					
Item	Test Equipment	Manufacturer	Model No.	Serial No.	Calibrated until
1	LISN	Rohde & Schwarz	ENV216	101112	Dec. 28, 2020
2	LISN	Rohde & Schwarz	ENV216	101113	Dec. 28, 2020
3	EMI Test Receiver	Rohde & Schwarz	ESCI	100658	Dec. 28, 2020

Note:1. The Cal. Interval was one year.

2. The cable loss has calculated in test result which connection between each test instruments.

### 3. TEST ITEM AND RESULTS

#### 3.1. Conducted Emission

**Limit**

FCC CFR Title 47 Part 15 Subpart C Section 15.207/ RSS – Gen 8.8

Frequency range (MHz)	Limit (dBuV)	
	Quasi-peak	Average
0.15-0.5	66 to 56*	56 to 46*
0.5-5	56	46
5-30	60	50

\* Decreases with the logarithm of the frequency.

**Test Configuration**

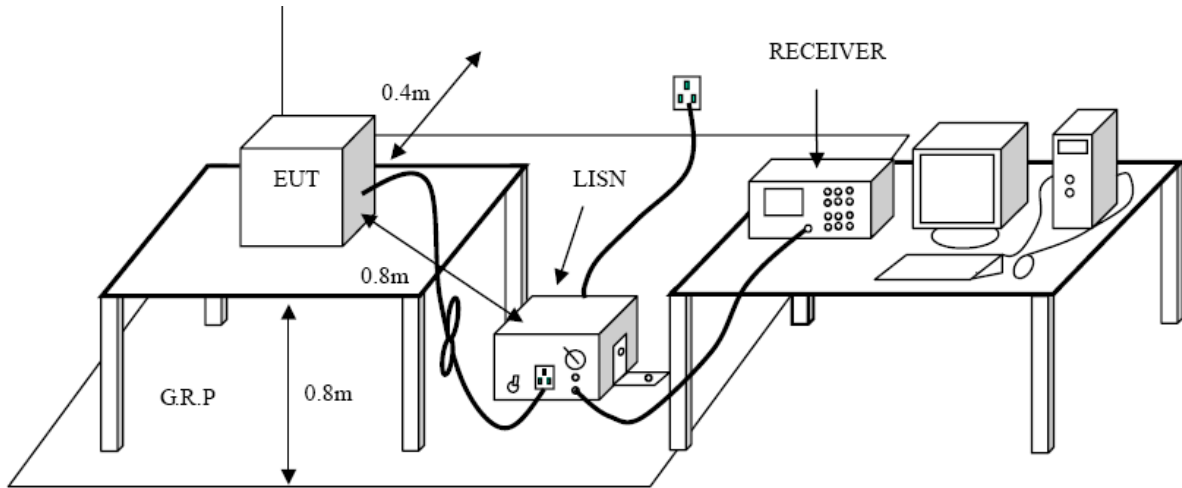

**Test Procedure**

1. The EUT was setup according to ANSI C63.10:2013 requirements.
2. The EUT was placed on a platform of nominal size, 1 m by 1.5 m, raised 80 cm above the conducting ground plane. The vertical conducting plane was located 40 cm to the rear of the EUT. All other surfaces of EUT were at least 80 cm from any other grounded conducting surface.
3. The EUT and simulators are connected to the main power through a line impedances stabilization network (LISN). The LISN provides a 50ohm /50uH coupling impedance for the measuring equipment. The peripheral devices are also connected to the main power through a LISN. (Please refer to the block diagram of the test setup and photographs)
4. Each current-carrying conductor of the EUT power cord, except the ground (safety) conductor, was individually connected through a LISN to the input power source.
5. The excess length of the power cord between the EUT and the LISN receptacle were folded back and forth at the center of the lead to form a bundle not exceeding 40 cm in length.
6. Conducted Emissions were investigated over the frequency range from 0.15MHz to 30MHz using a receiver bandwidth of 9 kHz.
7. During the above scans, the emissions were maximized by cable manipulation.

**Test Mode**

Please refer to the clause 2.3.



**Test Results**

<b>Test Voltage:</b>	AC 120V/60 Hz
<b>Terminal:</b>	Line

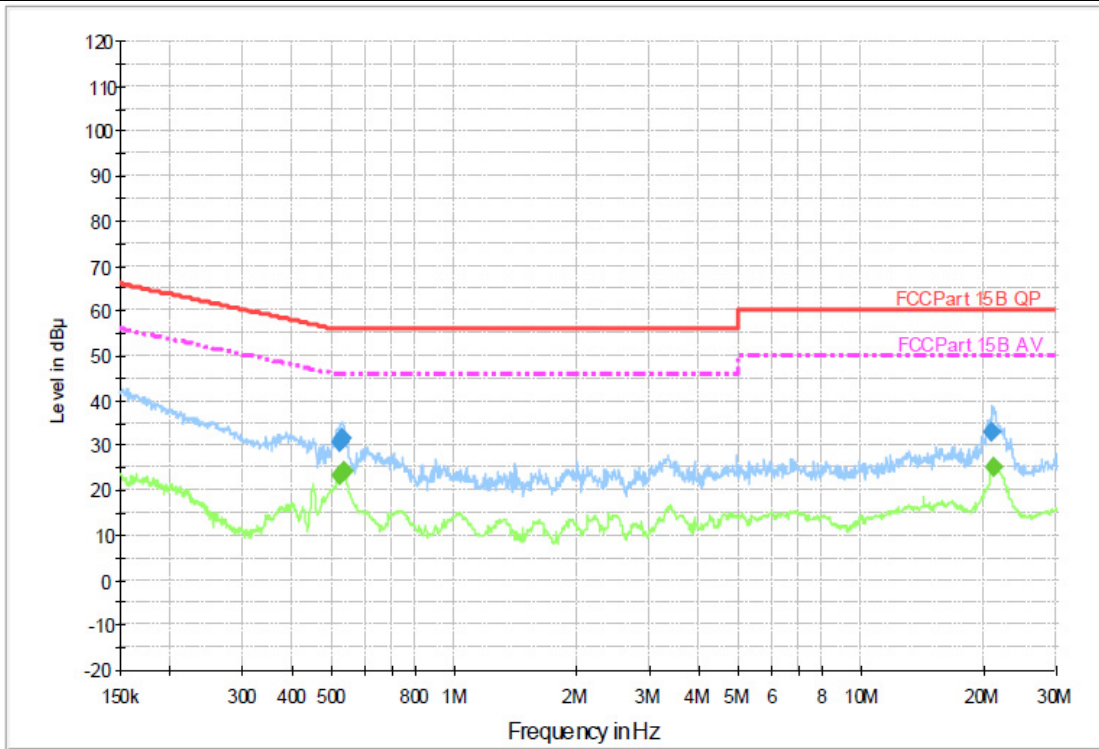

**Final Measurement Detector 1**

Frequency (MHz)	QuasiPeak (dBμ V)	Meas. Time (ms)	Bandwidth (kHz)	Filter	Line	Corr. (dB)	Margin (dB)	Limit (dBμ V)	Comment
0.519130	30.7	1000.00	9.000	On	L1	9.4	25.3	56.0	
0.529600	31.4	1000.00	9.000	On	L1	9.4	24.6	56.0	
20.926390	32.9	1000.00	9.000	On	L1	9.8	27.1	60.0	

**Final Measurement Detector 2**

Frequency (MHz)	Average (dBμ V)	Meas. Time (ms)	Bandwidth (kHz)	Filter	Line	Corr. (dB)	Margin (dB)	Limit (dBμ V)	Comment
0.519130	23.1	1000.00	9.000	On	L1	9.4	22.9	46.0	
0.531710	24.2	1000.00	9.000	On	L1	9.4	21.8	46.0	
21.094130	24.9	1000.00	9.000	On	L1	9.8	25.1	50.0	

**Emission Level= Read Level+ Correct Factor**



<b>Test Voltage:</b>	AC 120V/60 Hz
<b>Terminal:</b>	Neutral

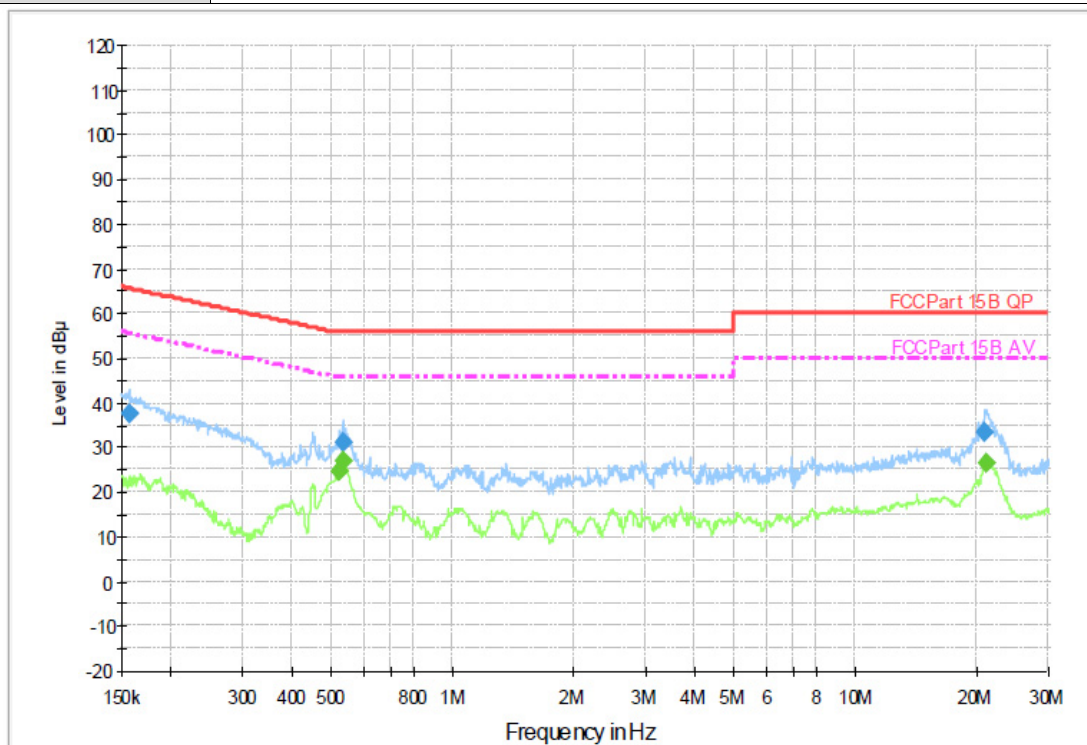

### Final Measurement Detector 1

Frequency (MHz)	QuasiPeak (dBμ V)	Meas. Time (ms)	Bandwidth (kHz)	Filter	Line	Corr. (dB)	Margin (dB)	Limit (dBμ V)	Comment
0.156730	37.6	1000.00	9.000	On	N	9.4	28.0	65.6	
0.531710	31.2	1000.00	9.000	On	N	9.4	24.8	56.0	
20.926390	33.2	1000.00	9.000	On	N	9.7	26.8	60.0	

### Final Measurement Detector 2

Frequency (MHz)	Average (dBμ V)	Meas. Time (ms)	Bandwidth (kHz)	Filter	Line	Corr. (dB)	Margin (dB)	Limit (dBμ V)	Comment
0.519130	24.9	1000.00	9.000	On	N	9.4	21.1	46.0	
0.533840	27.1	1000.00	9.000	On	N	9.4	18.9	46.0	
21.178510	26.4	1000.00	9.000	On	N	9.7	23.6	50.0	

**Emission Level= Read Level+ Correct Factor**

### 3.2. Radiated Emission

**Limit**

FCC CFR Title 47 Part 15 Subpart C Section 15.209/ RSS – Gen 8.9

Frequency	Limit (dBuV/m @3m)	Value
30 MHz ~ 88 MHz	40.00	Quasi-peak
88 MHz ~ 216 MHz	43.50	Quasi-peak
216 MHz ~ 960 MHz	46.00	Quasi-peak
960 MHz ~ 1 GHz	54.00	Quasi-peak
Above 1 GHz	54.00	Average
	74.00	Peak

**Note:**

- (1) The tighter limit applies at the band edges.
- (2) Emission Level (dBuV/m)=20log Emission Level (uV/m).

**Test Configuration**

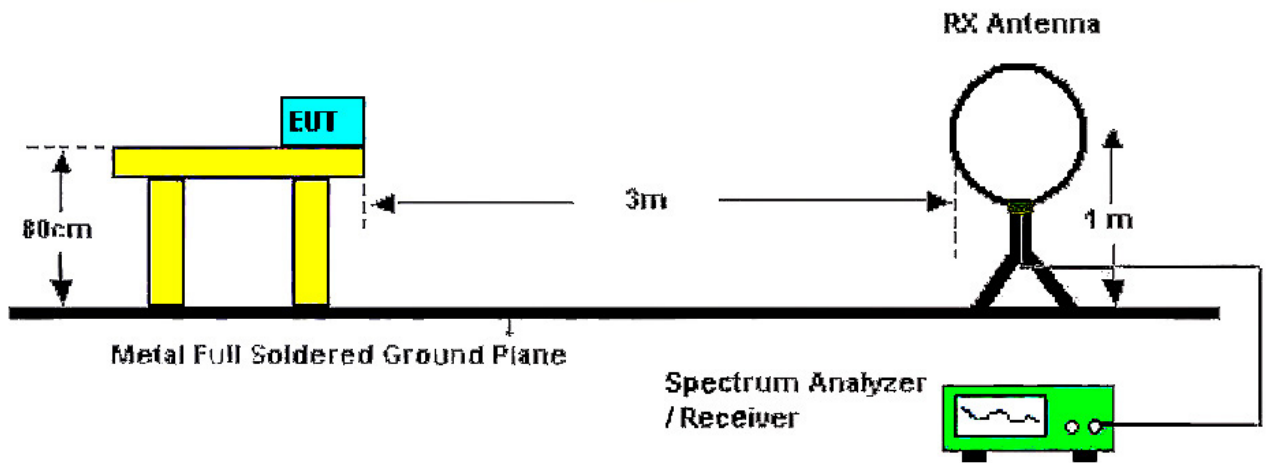

Below 30MHz Test Setup

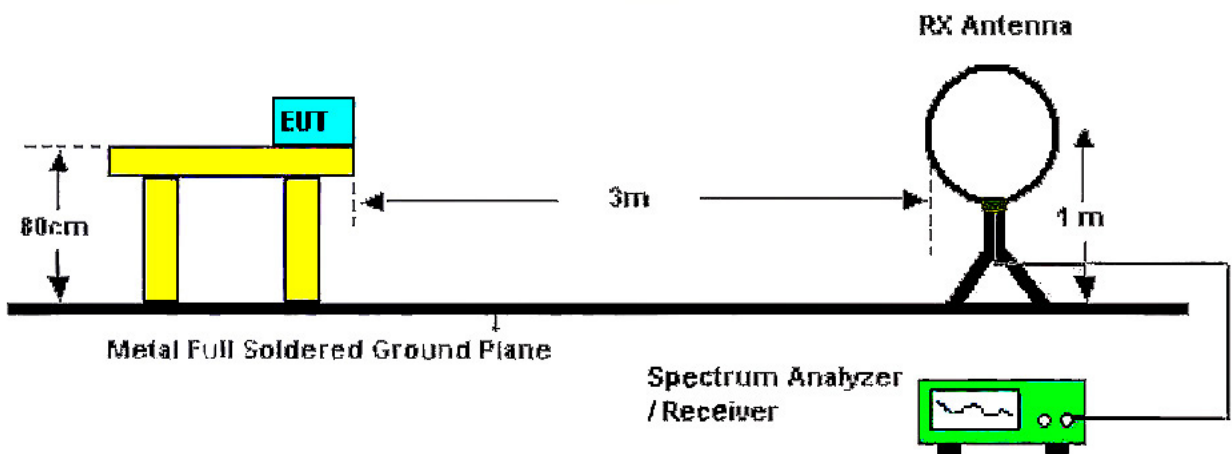

Below 1000MHz Test Setup



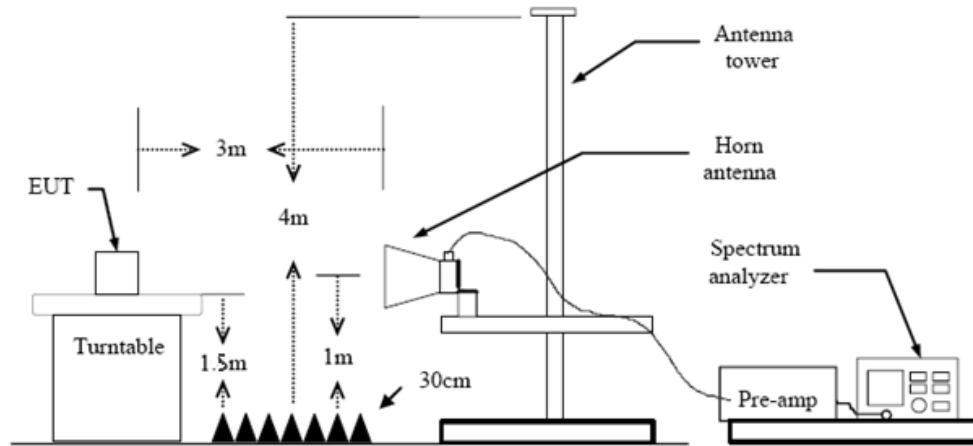

Above 1GHz Test Setup

### Test Procedure

1. The EUT was setup and tested according to ANSI C63.10:2013
2. The EUT is placed on a turn table which is 0.8 meter above ground for below 1 GHz, and 1.5 m for above 1 GHz. The turn table is rotated 360 degrees to determine the position of the maximum emission level.
3. The EUT was set 3 meters from the receiving antenna, which was mounted on the top of a variable height antenna tower.
4. For each suspected emission, the EUT was arranged to its worst case and then tune the Antenna tower (from 1 m to 4 m) and turntable (from 0 degree to 360 degrees) to find the maximum reading. A pre-amp and a high pass filter are used for the test in order to get better signal level to comply with the guidelines.
5. Set to the maximum power setting and enable the EUT transmit continuously.
6. Use the following spectrum analyzer settings
  - (1) Span shall wide enough to fully capture the emission being measured;
  - (2) Below 1 GHz:  
RBW=120 kHz, VBW=300 kHz, Sweep=auto, Detector function=peak, Trace=max hold;  
If the emission level of the EUT measured by the peak detector is 3 dB lower than the applicable limit, the peak emission level will be reported. Otherwise, the emission measurement will be repeated using the quasi-peak detector and reported.
  - (3) From 1 GHz to 10<sup>th</sup> harmonic:  
RBW=1MHz, VBW=3MHz Peak detector for Peak value.  
RBW=1MHz, VBW=3MHz RMS detector for Average value.

### Test Mode

Please refer to the clause 2.3.

### Test Result

#### **9 KHz~30 MHz**

From 9 KHz to 30 MHz: Conclusion: PASS

Note: The amplitude of spurious emissions which are attenuated by more than 20dB below the permissible value has no need to be reported.

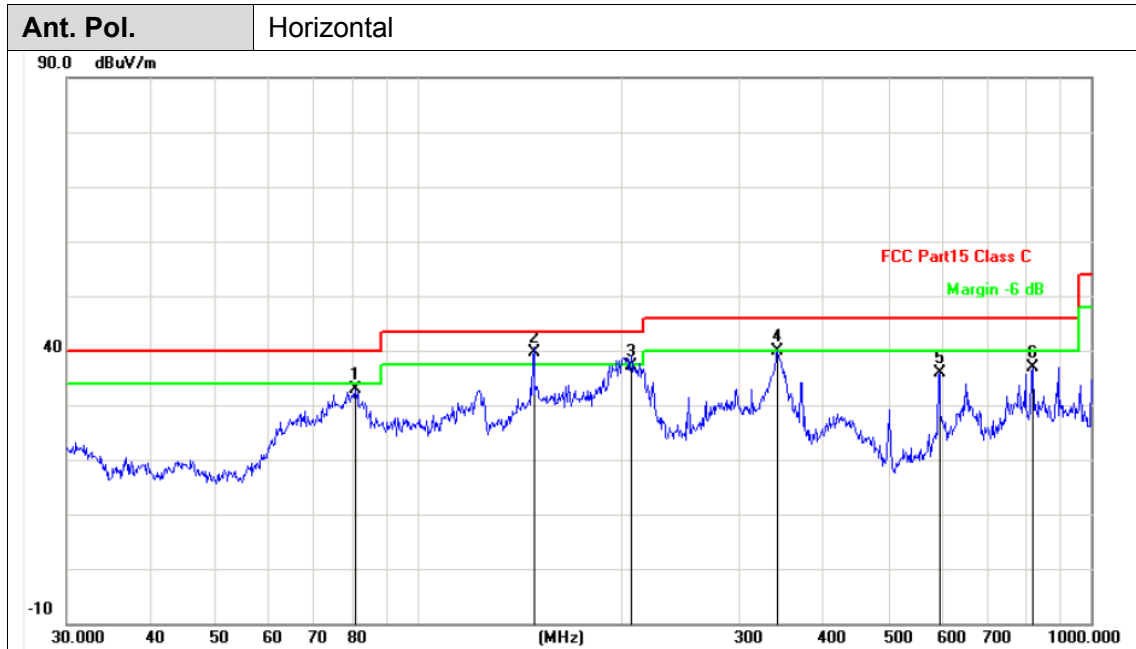

No.	Frequency (MHz)	Factor (dB/m)	Reading (dBuV)	Level (dBuV/m)	Limit (dBuV/m)	Margin (dB)	Detector
1	80.6441	-21.91	54.79	32.88	40.00	-7.12	QP
2	148.4410	-16.91	56.51	39.60	43.50	-3.90	QP
3	207.1225	-20.64	57.74	37.10	43.50	-6.40	QP
4	341.9786	-16.89	56.71	39.82	46.00	-6.18	QP
5	595.1327	-12.31	48.26	35.95	46.00	-10.05	QP
6	818.8340	-9.26	46.06	36.80	46.00	-9.20	QP

**Remarks:**

1. Factor (dB/m) = Antenna Factor (dB/m)+Cable Factor (dB)-Pre-amplifier Factor
2. Margin value = Level -Limit value



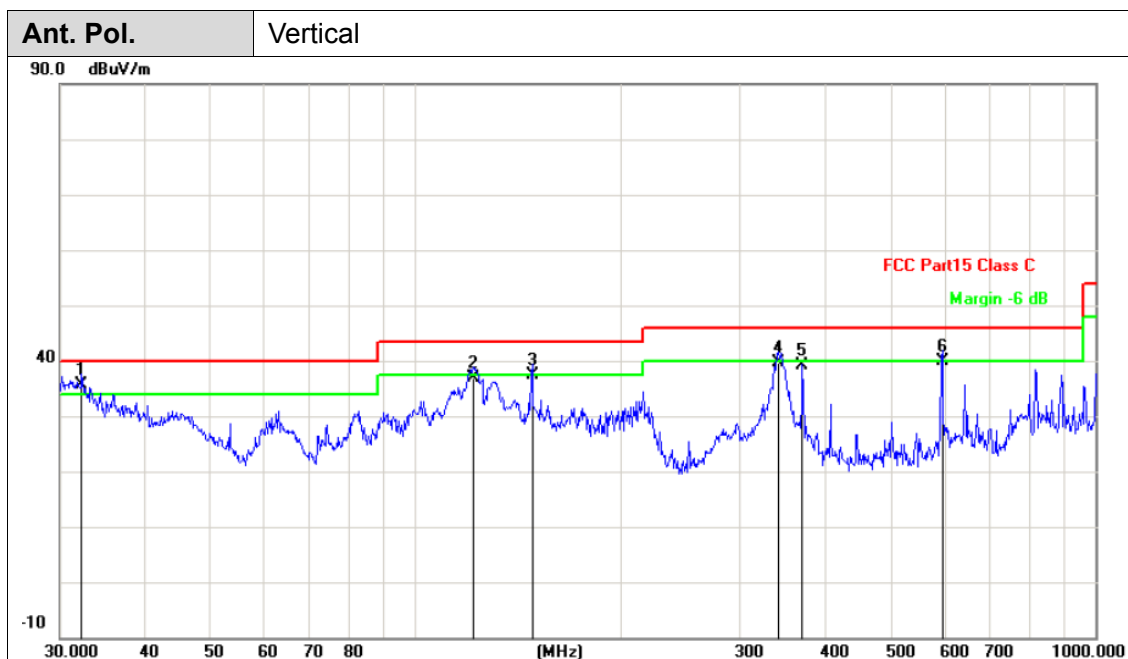

No.	Frequency (MHz)	Factor (dB/m)	Reading (dBuV)	Level (dBuV/m)	Limit (dBuV/m)	Margin (dB)	Detector
1	32.2925	-18.09	53.69	35.60	40.00	-4.40	QP
2	121.5486	-19.16	55.96	36.80	43.50	-6.70	QP
3	148.4410	-16.90	54.30	37.40	43.50	-6.10	QP
4	341.9786	-16.89	56.59	39.70	46.00	-6.30	QP
5	370.7023	-16.34	55.59	39.25	46.00	-6.75	QP
6	595.1329	-12.31	52.11	39.80	46.00	-6.20	QP

Remarks:

- Factor (dB/m) = Antenna Factor (dB/m)+Cable Factor (dB)-Pre-amplifier Factor
- Margin value = Level -Limit value



Above 1GHz

<b>Ant. Pol.</b>	Horizontal
<b>Test Mode:</b>	TX GFSK Mode 2402MHz
<b>Remark:</b>	No report for the emission which more than 10 dB below the prescribed limit.

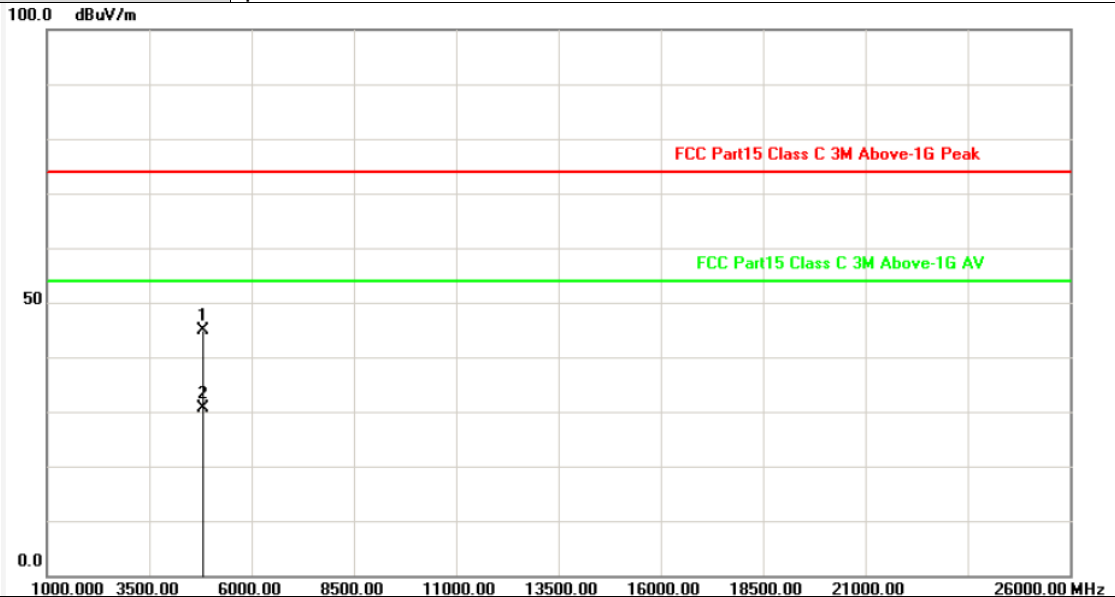

No.	Frequency (MHz)	Factor (dB/m)	Reading (dBuV)	Level (dBuV/m)	Limit (dBuV/m)	Margin (dB)	Detector
1	4803.670	-2.82	47.70	44.88	74.00	-29.12	peak
2	4804.494	-2.82	33.45	30.63	54.00	-23.37	AVG

Remarks:

- 1. Factor (dB/m) = Antenna Factor (dB/m)+Cable Factor (dB)-Pre-amplifier Factor
- 2. Margin value = Level -Limit value



<b>Ant. Pol.</b>	Vertical
<b>Test Mode:</b>	TX GFSK Mode 2402MHz
<b>Remark:</b>	No report for the emission which more than 10 dB below the prescribed limit.

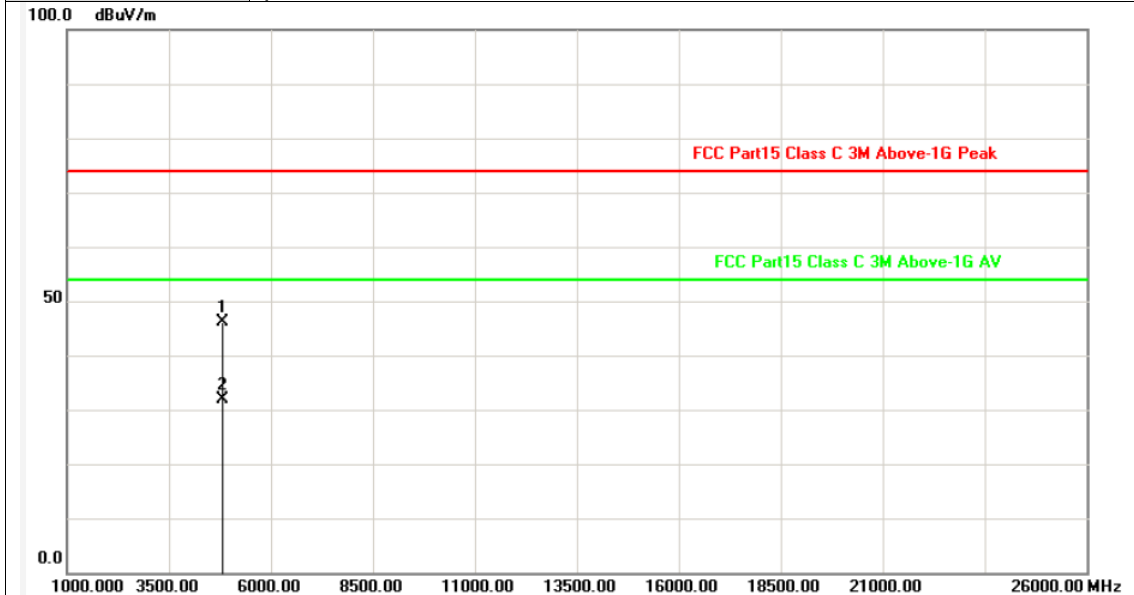

No.	Frequency (MHz)	Factor (dB/m)	Reading (dBuV)	Level (dBuV/m)	Limit (dBuV/m)	Margin (dB)	Detector
1	4803.756	-2.82	48.88	46.06	74.00	-27.94	peak
2	4803.746	-2.82	34.60	31.78	54.00	-22.22	AVG

Remarks:  
 1. Factor (dB/m) = Antenna Factor (dB/m)+Cable Factor (dB)-Pre-amplifier Factor  
 2. Margin value = Level -Limit value



<b>Ant. Pol.</b>	Horizontal
<b>Test Mode:</b>	TX GFSK Mode 2441MHz
<b>Remark:</b>	No report for the emission which more than 10 dB below the prescribed limit.

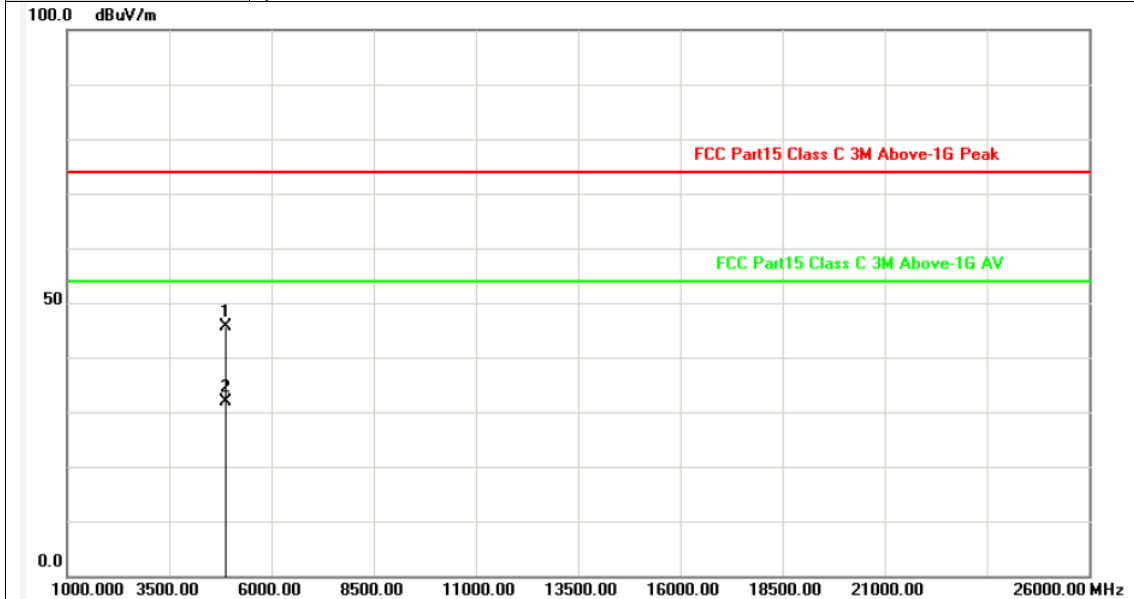

No.	Frequency (MHz)	Factor (dB/m)	Reading (dBuV)	Level (dBuV/m)	Limit (dBuV/m)	Margin (dB)	Detector
1	4881.180	-2.60	48.31	45.71	74.00	-28.29	peak
2	4881.404	-2.60	34.48	31.88	54.00	-22.12	AVG

Remarks:  
 1. Factor (dB/m) = Antenna Factor (dB/m)+Cable Factor (dB)-Pre-amplifier Factor  
 2. Margin value = Level -Limit value



<b>Ant. Pol.</b>	Vertical
<b>Test Mode:</b>	TX GFSK Mode 2441MHz
<b>Remark:</b>	No report for the emission which more than 10 dB below the prescribed limit.

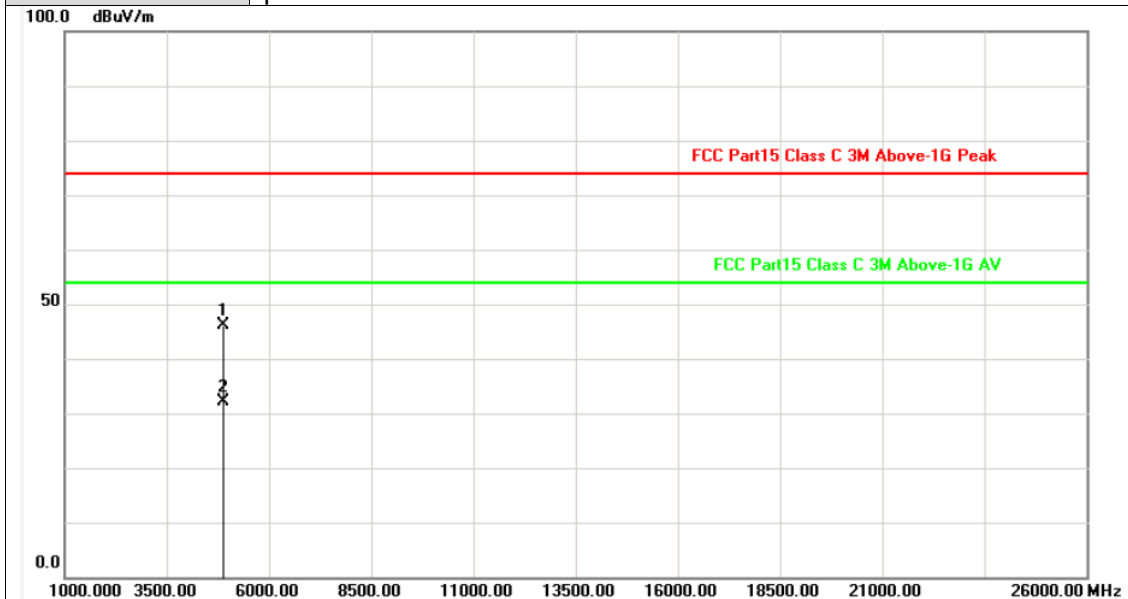

No.	Frequency (MHz)	Factor (dB/m)	Reading (dBuV)	Level (dBuV/m)	Limit (dBuV/m)	Margin (dB)	Detector
1	4881.442	-2.60	48.75	46.15	74.00	-27.85	peak
2	4882.374	-2.60	34.77	32.17	54.00	-21.83	AVG

Remarks:  
 1. Factor (dB/m) = Antenna Factor (dB/m)+Cable Factor (dB)-Pre-amplifier Factor  
 2. Margin value = Level -Limit value



<b>Ant. Pol.</b>	Horizontal
<b>Test Mode:</b>	TX GFSK Mode 2480MHz
<b>Remark:</b>	No report for the emission which more than 10 dB below the prescribed limit.

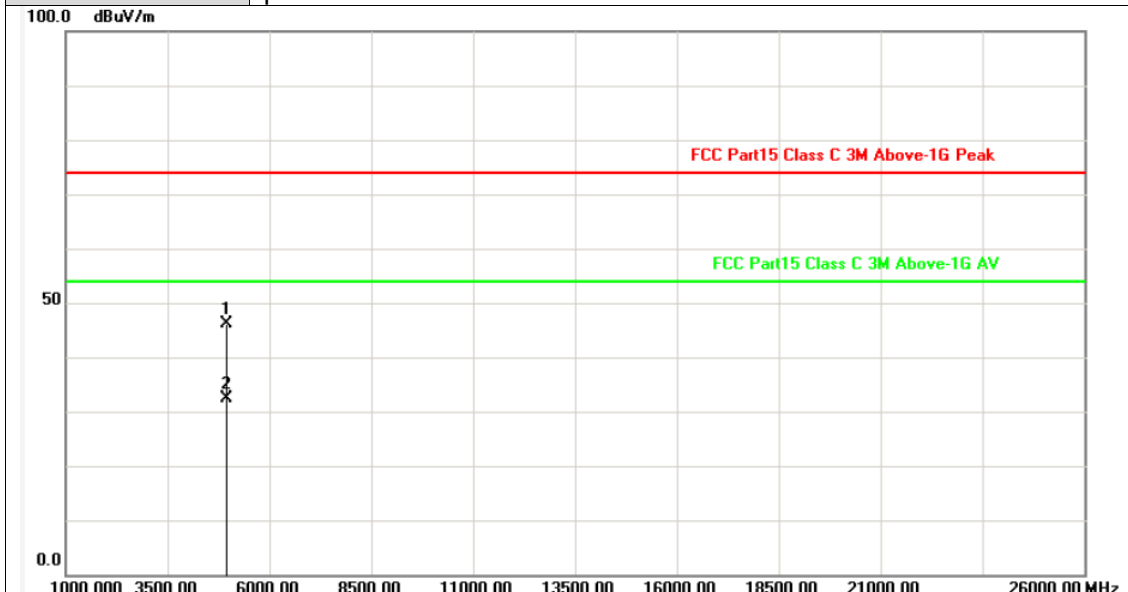

No.	Frequency (MHz)	Factor (dB/m)	Reading (dBuV)	Level (dBuV/m)	Limit (dBuV/m)	Margin (dB)	Detector
1	4960.412	-2.38	48.46	46.08	74.00	-27.92	peak
2	4959.384	-2.38	34.73	32.35	54.00	-21.65	AVG

Remarks:  
 1. Factor (dB/m) = Antenna Factor (dB/m)+Cable Factor (dB)-Pre-amplifier Factor  
 2. Margin value = Level -Limit value



<b>Ant. Pol.</b>	Vertical
<b>Test Mode:</b>	TX GFSK Mode 2480MHz
<b>Remark:</b>	No report for the emission which more than 10 dB below the prescribed limit.

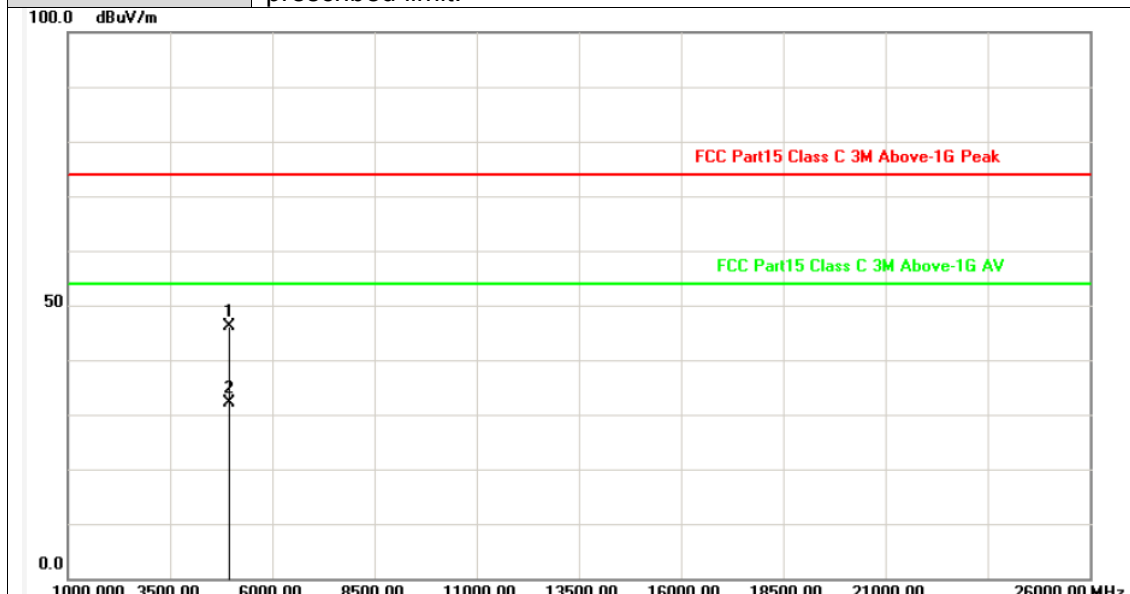

No.	Frequency (MHz)	Factor (dB/m)	Reading (dBuV)	Level (dBuV/m)	Limit (dBuV/m)	Margin (dB)	Detector
1	4959.872	-2.38	48.49	46.11	74.00	-27.89	peak
2	4960.678	-2.38	34.57	32.19	54.00	-21.81	AVG

Remarks:  
 1. Factor (dB/m) = Antenna Factor (dB/m)+Cable Factor (dB)-Pre-amplifier Factor  
 2. Margin value = Level -Limit value



<b>Ant. Pol.</b>	Horizontal
<b>Test Mode:</b>	TX $\pi/4$ -DQPSK Mode 2402MHz
<b>Remark:</b>	No report for the emission which more than 10 dB below the prescribed limit.

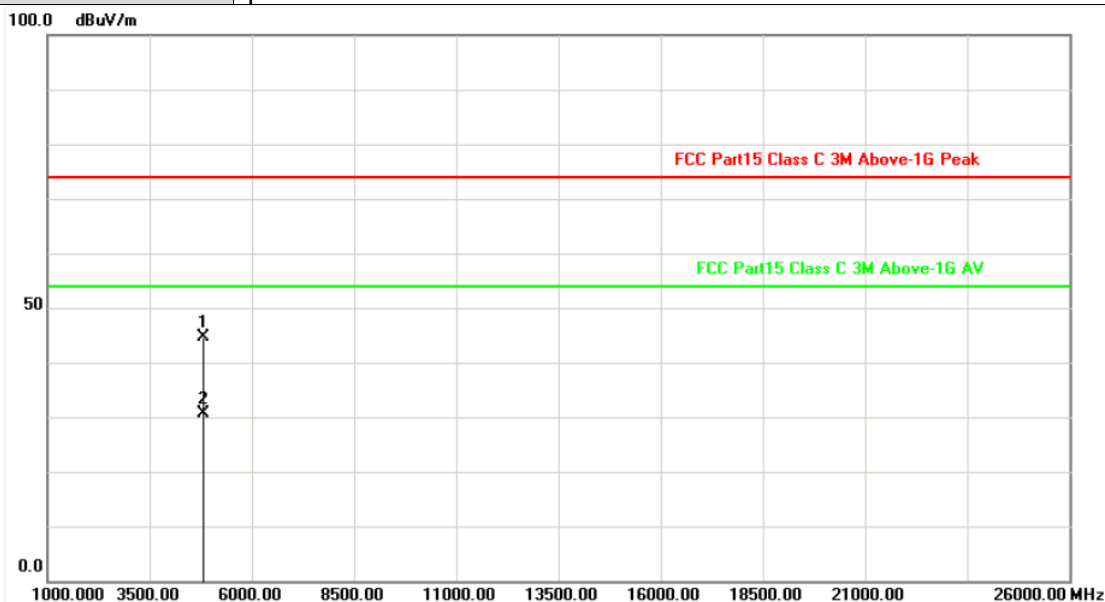

No.	Frequency (MHz)	Factor (dB/m)	Reading (dBuV)	Level (dBuV/m)	Limit (dBuV/m)	Margin (dB)	Detector
1	4803.546	-2.82	47.55	44.73	74.00	-29.27	peak
2	4803.506	-2.82	33.40	30.58	54.00	-23.42	AVG

Remarks:

- 1. Factor (dB/m) = Antenna Factor (dB/m)+Cable Factor (dB)-Pre-amplifier Factor
- 2. Margin value = Level -Limit value





<b>Ant. Pol.</b>	Vertical
<b>Test Mode:</b>	TX $\pi/4$ -DQPSK Mode 2402MHz
<b>Remark:</b>	No report for the emission which more than 10 dB below the prescribed limit.

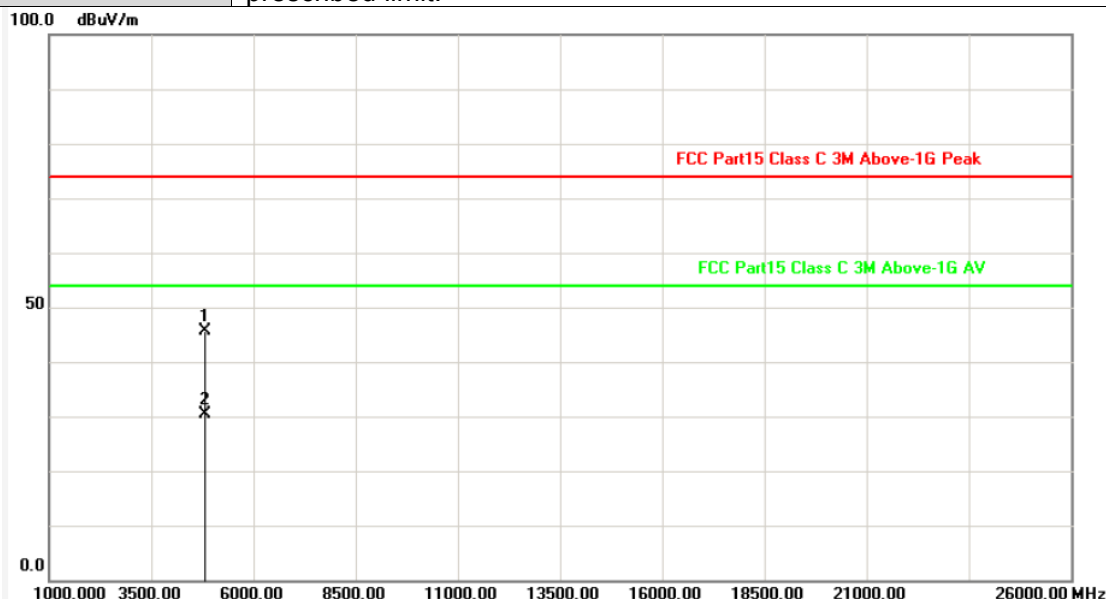

No.	Frequency (MHz)	Factor (dB/m)	Reading (dBuV)	Level (dBuV/m)	Limit (dBuV/m)	Margin (dB)	Detector
1	4803.264	-2.82	48.43	45.61	74.00	-28.39	peak
2	4804.534	-2.82	33.28	30.46	54.00	-23.54	AVG

Remarks:

- 1.Factor (dB/m) = Antenna Factor (dB/m)+Cable Factor (dB)-Pre-amplifier Factor
- 2.Margin value = Level -Limit value



<b>Ant. Pol.</b>	Horizontal
<b>Test Mode:</b>	TX $\pi/4$ -DQPSK Mode 2441MHz
<b>Remark:</b>	No report for the emission which more than 10 dB below the prescribed limit.

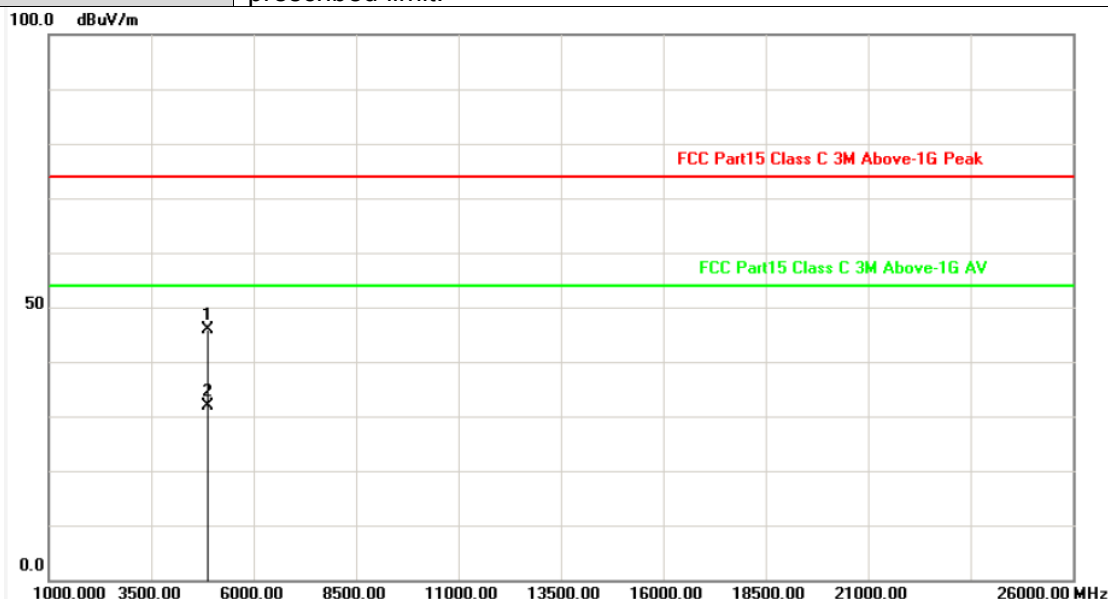

No.	Frequency (MHz)	Factor (dB/m)	Reading (dBuV)	Level (dBuV/m)	Limit (dBuV/m)	Margin (dB)	Detector
1	4881.052	-2.60	48.57	45.97	74.00	-28.03	peak
2	4882.878	-2.59	34.45	31.86	54.00	-22.14	AVG

Remarks:  
 1. Factor (dB/m) = Antenna Factor (dB/m)+Cable Factor (dB)-Pre-amplifier Factor  
 2. Margin value = Level -Limit value



<b>Ant. Pol.</b>	Vertical
<b>Test Mode:</b>	TX $\pi/4$ -DQPSK Mode 2441MHz
<b>Remark:</b>	No report for the emission which more than 10 dB below the prescribed limit.

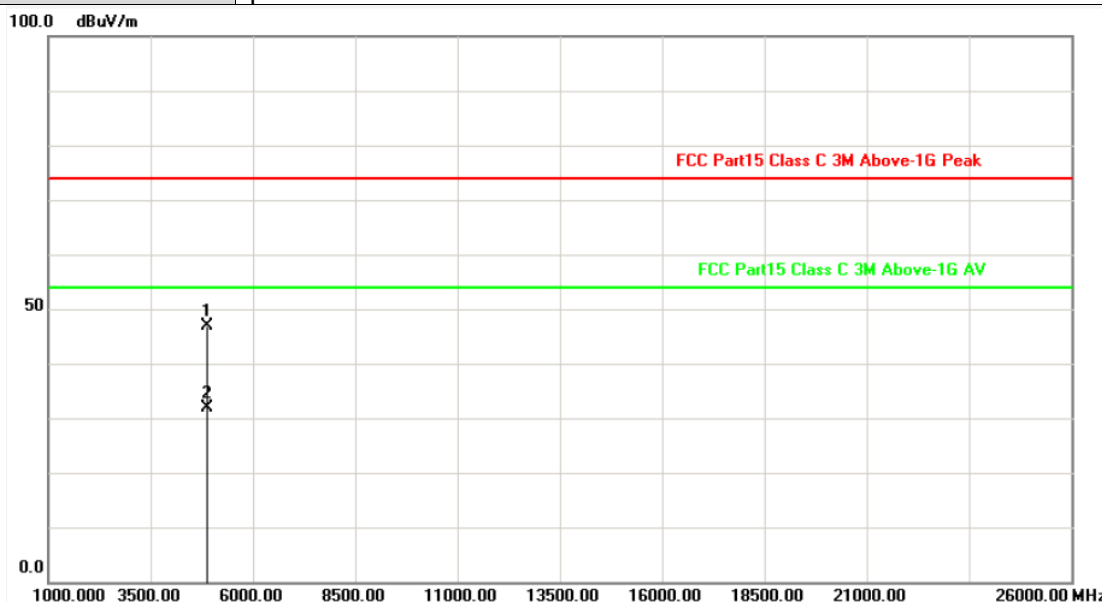

No.	Frequency (MHz)	Factor (dB/m)	Reading (dBuV)	Level (dBuV/m)	Limit (dBuV/m)	Margin (dB)	Detector
1	4881.864	-2.60	49.38	46.78	74.00	-27.22	peak
2	4881.222	-2.60	34.39	31.79	54.00	-22.21	AVG

Remarks:

- 1. Factor (dB/m) = Antenna Factor (dB/m)+Cable Factor (dB)-Pre-amplifier Factor
- 2. Margin value = Level -Limit value



<b>Ant. Pol.</b>	Horizontal
<b>Test Mode:</b>	TX $\pi/4$ -DQPSK Mode 2480MHz
<b>Remark:</b>	No report for the emission which more than 10 dB below the prescribed limit.

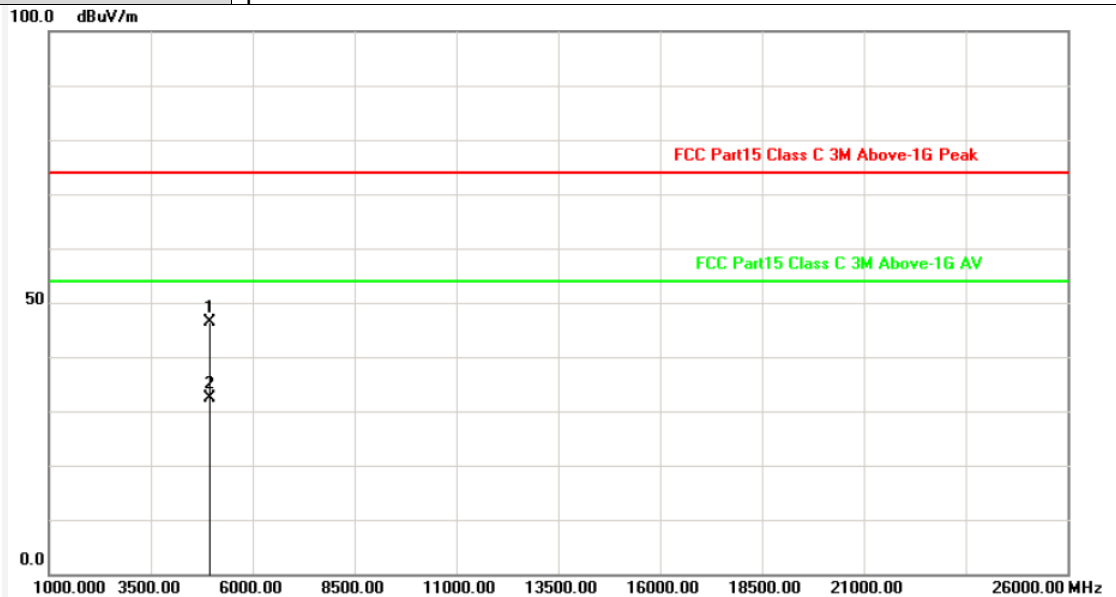

No.	Frequency (MHz)	Factor (dB/m)	Reading (dBuV)	Level (dBuV/m)	Limit (dBuV/m)	Margin (dB)	Detector
1	4959.152	-2.38	48.87	46.49	74.00	-27.51	peak
2	4960.696	-2.38	34.73	32.35	54.00	-21.65	AVG

Remarks:

1. Factor (dB/m) = Antenna Factor (dB/m)+Cable Factor (dB)-Pre-amplifier Factor
2. Margin value = Level -Limit value



<b>Ant. Pol.</b>	Vertical
<b>Test Mode:</b>	TX $\pi/4$ -DQPSK Mode 2480MHz
<b>Remark:</b>	No report for the emission which more than 10 dB below the prescribed limit.

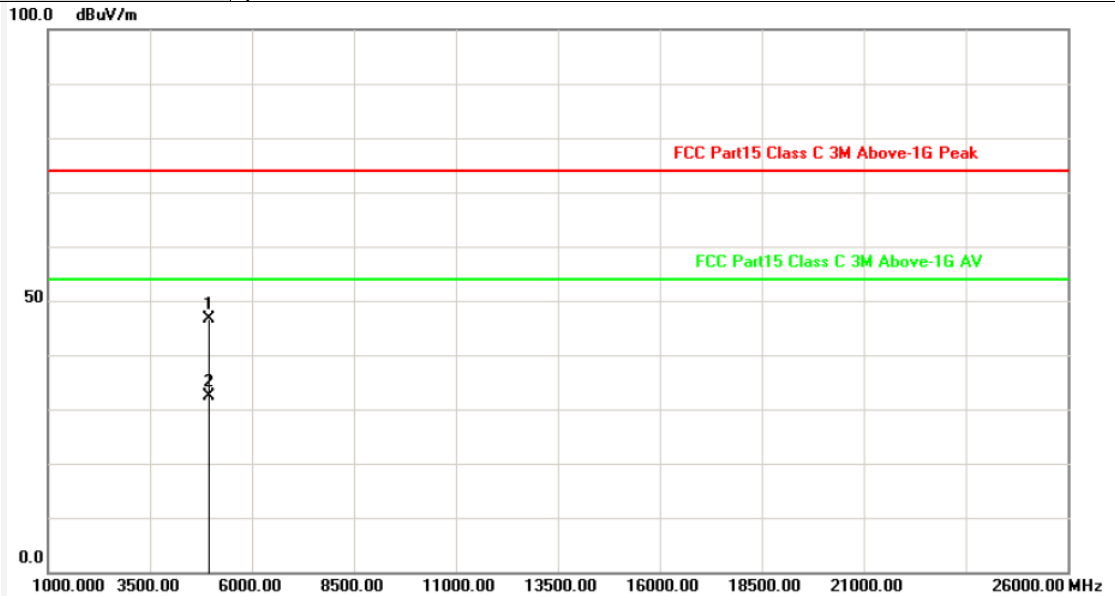

No.	Frequency (MHz)	Factor (dB/m)	Reading (dBuV)	Level (dBuV/m)	Limit (dBuV/m)	Margin (dB)	Detector
1	4960.850	-2.38	49.06	46.68	74.00	-27.32	peak
2	4959.890	-2.38	34.65	32.27	54.00	-21.73	AVG

Remarks:  
 1. Factor (dB/m) = Antenna Factor (dB/m)+Cable Factor (dB)-Pre-amplifier Factor  
 2. Margin value = Level -Limit value



<b>Ant. Pol.</b>	Horizontal
<b>Test Mode:</b>	TX 8-DPSK Mode 2402MHz
<b>Remark:</b>	No report for the emission which more than 10 dB below the prescribed limit.

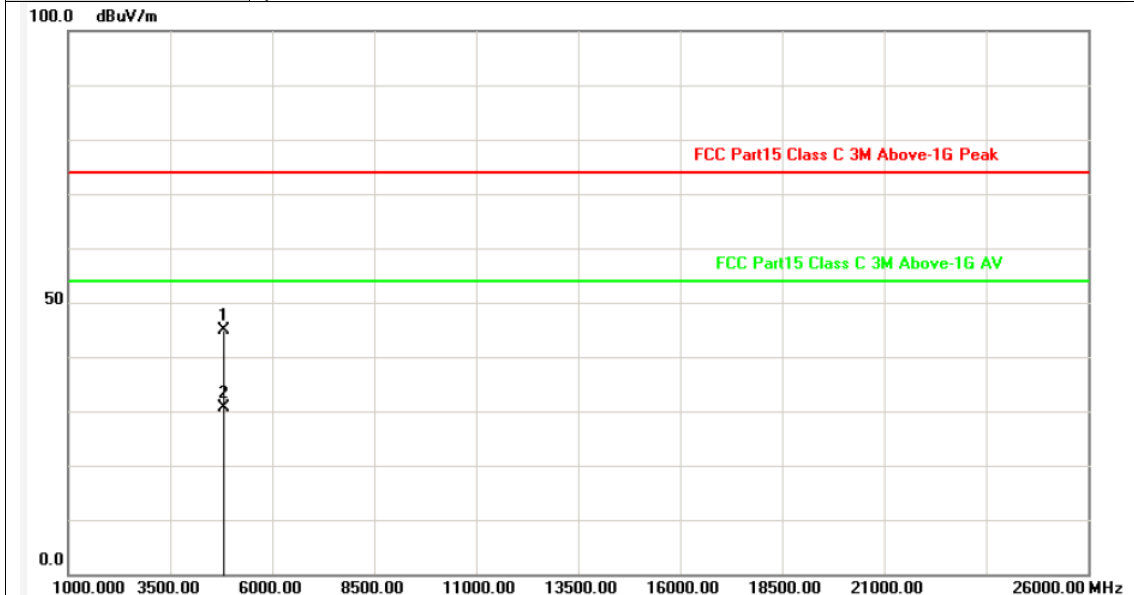

No.	Frequency (MHz)	Factor (dB/m)	Reading (dBuV)	Level (dBuV/m)	Limit (dBuV/m)	Margin (dB)	Detector
1	4803.664	-2.82	47.60	44.78	74.00	-29.22	peak
2	4804.454	-2.82	33.49	30.67	54.00	-23.33	AVG

Remarks:

1. Factor (dB/m) = Antenna Factor (dB/m)+Cable Factor (dB)-Pre-amplifier Factor
2. Margin value = Level -Limit value



<b>Ant. Pol.</b>	Vertical
<b>Test Mode:</b>	TX 8-DPSK Mode 2402MHz
<b>Remark:</b>	No report for the emission which more than 10 dB below the prescribed limit.

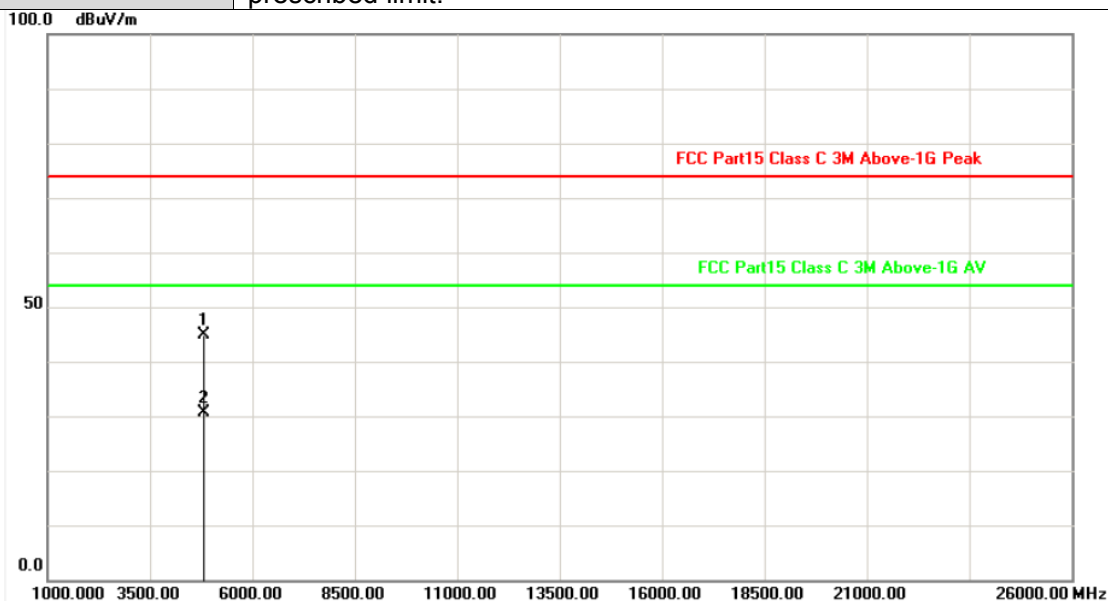

No.	Frequency (MHz)	Factor (dB/m)	Reading (dBuV)	Level (dBuV/m)	Limit (dBuV/m)	Margin (dB)	Detector
1	4803.230	-2.82	47.75	44.93	74.00	-29.07	peak
2	4803.000	-2.82	33.47	30.65	54.00	-23.35	AVG

Remarks:

- Factor (dB/m) = Antenna Factor (dB/m)+Cable Factor (dB)-Pre-amplifier Factor
- Margin value = Level -Limit value



<b>Ant. Pol.</b>	Horizontal
<b>Test Mode:</b>	TX 8-DPSK Mode 2441MHz
<b>Remark:</b>	No report for the emission which more than 10 dB below the prescribed limit.

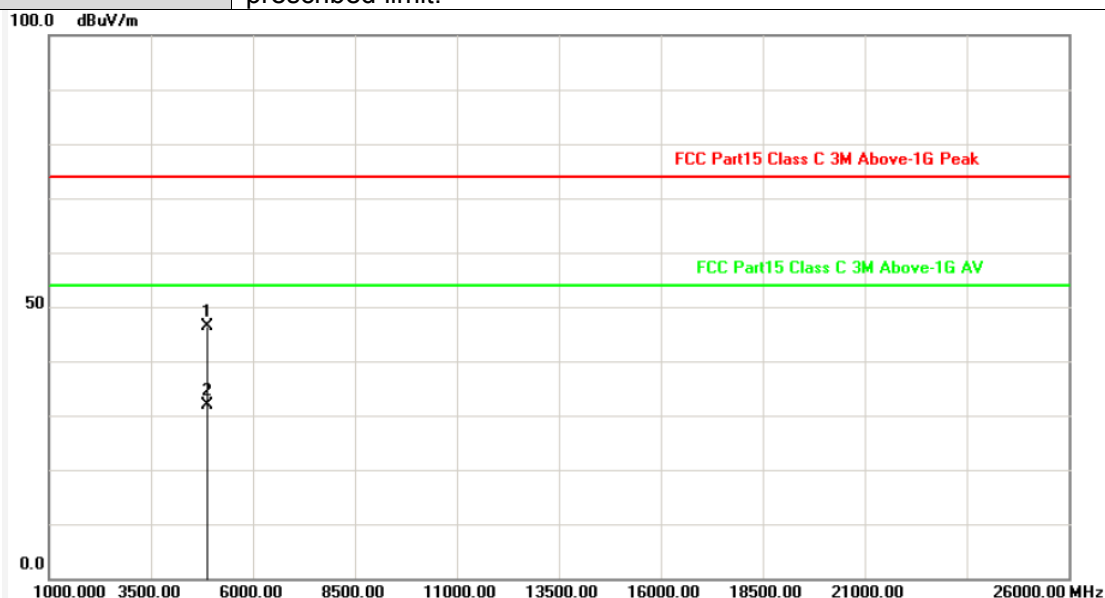

No.	Frequency (MHz)	Factor (dB/m)	Reading (dBuV)	Level (dBuV/m)	Limit (dBuV/m)	Margin (dB)	Detector
1	4882.156	-2.60	49.05	46.45	74.00	-27.55	peak
2	4882.920	-2.59	34.53	31.94	54.00	-22.06	AVG

**Remarks:**

- Factor (dB/m) = Antenna Factor (dB/m)+Cable Factor (dB)-Pre-amplifier Factor
- Margin value = Level -Limit value





<b>Ant. Pol.</b>	Vertical
<b>Test Mode:</b>	TX 8-DPSK Mode 2441MHz
<b>Remark:</b>	No report for the emission which more than 10 dB below the prescribed limit.

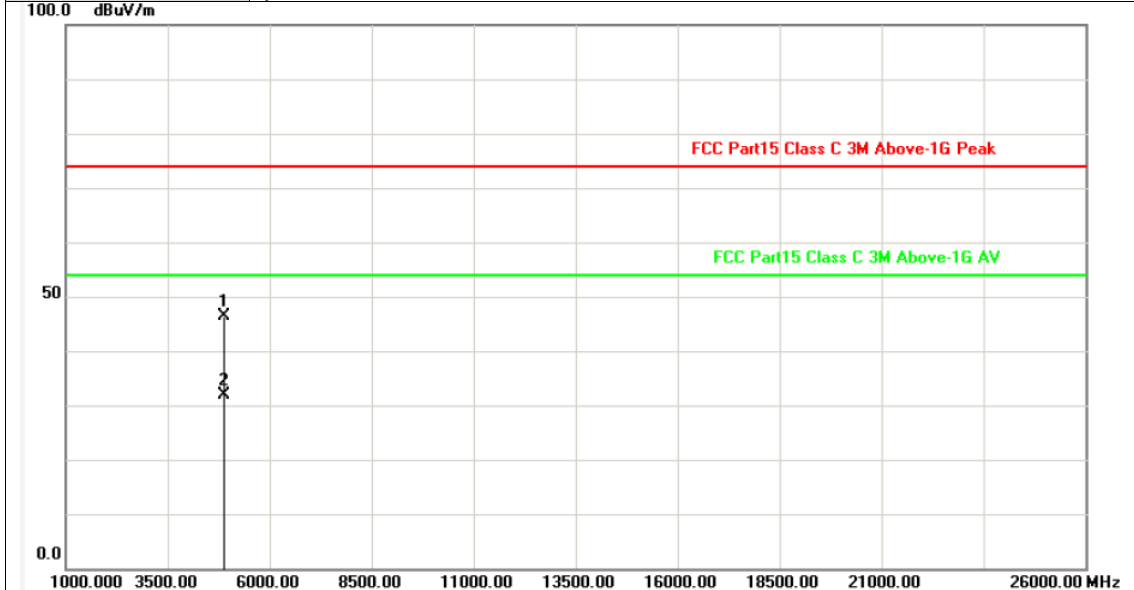

No.	Frequency (MHz)	Factor (dB/m)	Reading (dBuV)	Level (dBuV/m)	Limit (dBuV/m)	Margin (dB)	Detector
1	4881.124	-2.60	49.03	46.43	74.00	-27.57	peak
2	4882.394	-2.60	34.38	31.78	54.00	-22.22	AVG

Remarks:  
 1. Factor (dB/m) = Antenna Factor (dB/m)+Cable Factor (dB)-Pre-amplifier Factor  
 2. Margin value = Level -Limit value



<b>Ant. Pol.</b>	Horizontal
<b>Test Mode:</b>	TX 8-DPSK Mode 2480MHz
<b>Remark:</b>	No report for the emission which more than 10 dB below the prescribed limit.

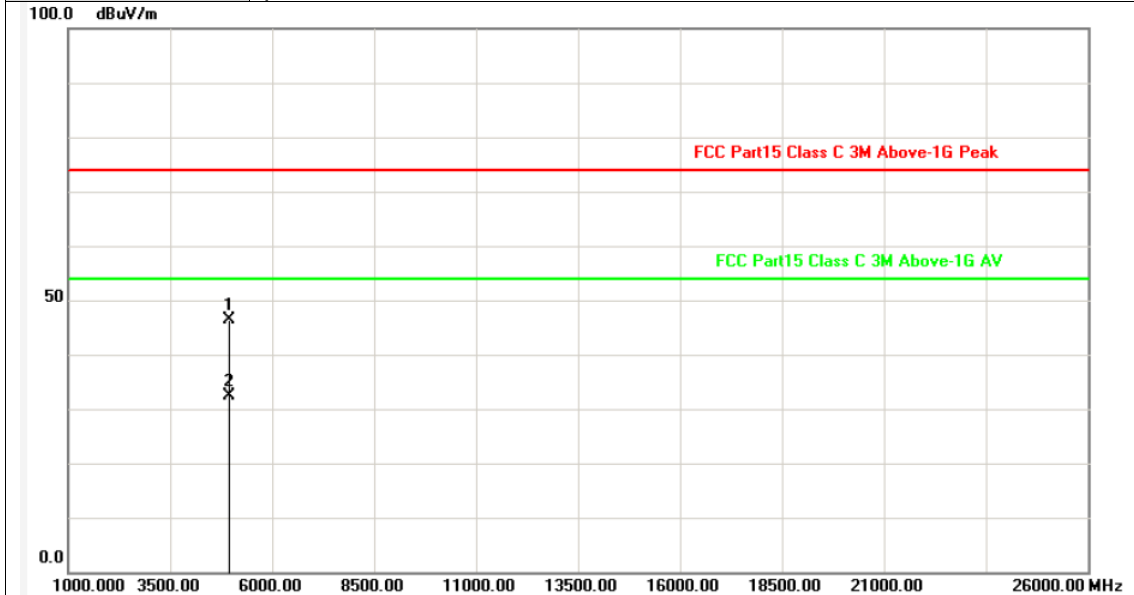

No.	Frequency (MHz)	Factor (dB/m)	Reading (dBuV)	Level (dBuV/m)	Limit (dBuV/m)	Margin (dB)	Detector
1	4959.698	-2.38	48.84	46.46	74.00	-27.54	peak
2	4959.484	-2.38	34.79	32.41	54.00	-21.59	AVG

Remarks:  
 1. Factor (dB/m) = Antenna Factor (dB/m)+Cable Factor (dB)-Pre-amplifier Factor  
 2. Margin value = Level -Limit value



<b>Ant. Pol.</b>	Vertical
<b>Test Mode:</b>	TX 8-DPSK Mode 2480MHz
<b>Remark:</b>	No report for the emission which more than 10 dB below the prescribed limit.

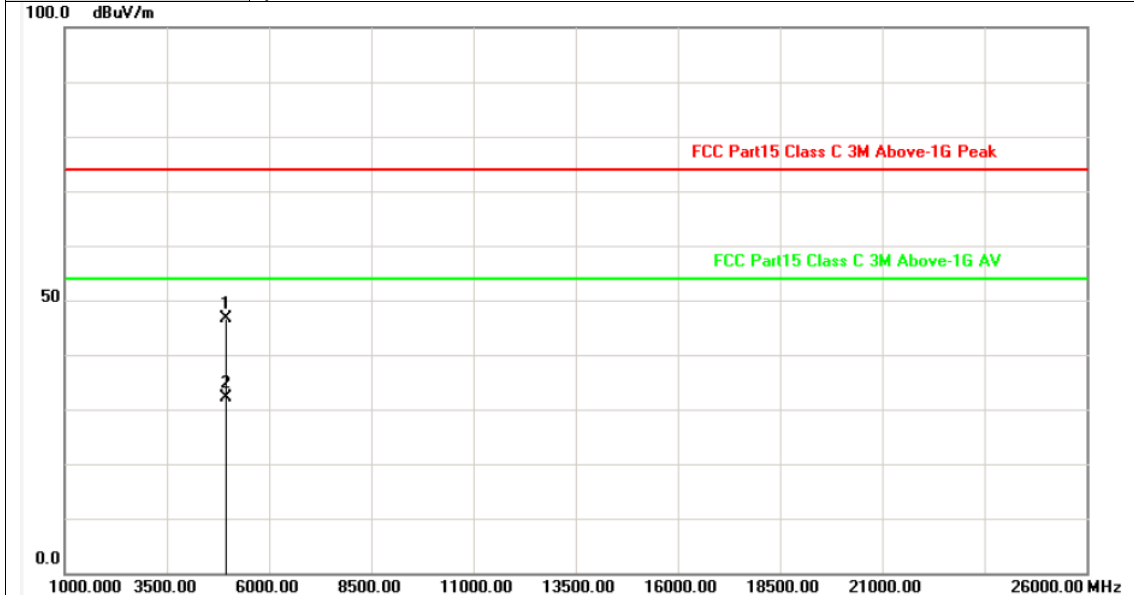

No.	Frequency (MHz)	Factor (dB/m)	Reading (dBuV)	Level (dBuV/m)	Limit (dBuV/m)	Margin (dB)	Detector
1	4959.430	-2.38	49.11	46.73	74.00	-27.27	peak
2	4960.274	-2.38	34.60	32.22	54.00	-21.78	AVG

Remarks:  
 1. Factor (dB/m) = Antenna Factor (dB/m)+Cable Factor (dB)-Pre-amplifier Factor  
 2. Margin value = Level -Limit value

### 3.3. Band Edge Emissions

#### Limit

FCC CFR Title 47 Part 15 Subpart C Section 15.247 (d):

Restricted Frequency Band (MHz)	(dBuV/m)(at 3m)	
	Peak	Average
2310 ~2390	74	54
2483.5 ~2500	74	54

Conducted band edge limit: The highest point of the operating frequency waveform down 20dB

#### Test Configuration

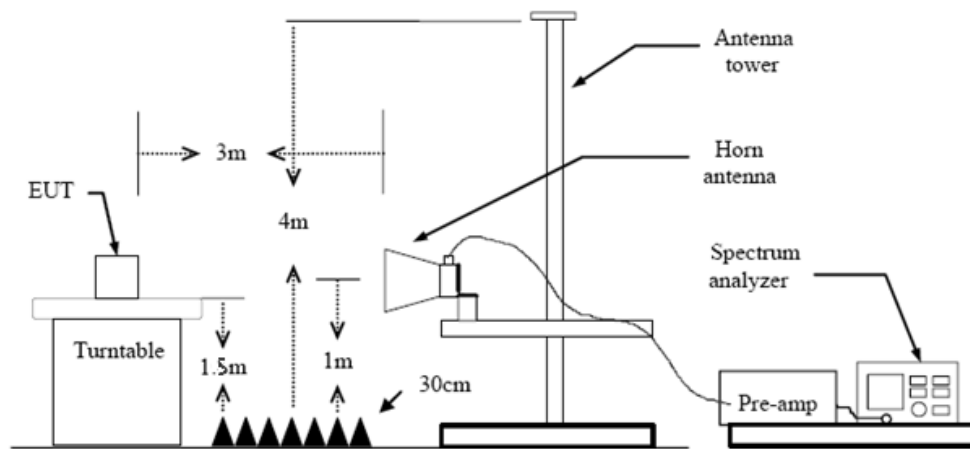

#### Test Procedure

1. The EUT was setup and tested according to ANSI C63.10:2013 requirements.
2. The EUT is placed on a turn table which is 1.5 meter above ground. The turn table is rotated 360 degrees to determine the position of the maximum emission level.
3. The EUT was positioned such that the distance from antenna to the EUT was 3 meters.
4. The antenna is scanned from 1 meter to 4 meters to find out the maximum emission level. This is repeated for both horizontal and vertical polarization of the antenna. In order to find the maximum emission, all of the interface cables were manipulated according to ANSI C63.10:2013 on radiated measurement.
5. The receiver set as follow:  
 RBW=1MHz, VBW=3MHz PEAK detector for Peak value.  
 RBW=1MHz, VBW=10Hz with PEAK Detector for Average Value.

#### Test Mode

Please refer to the clause 2.3.



**Test Results**

**(1) Radiation Test**

<b>Ant. Pol.</b>	Horizontal																														
<b>Test Mode:</b>	GFSK Mode 2402MHz																														
<table border="1"> <thead> <tr> <th>No.</th> <th>Frequency (MHz)</th> <th>Factor (dB/m)</th> <th>Reading (dBuV)</th> <th>Level (dBuV/m)</th> <th>Limit (dBuV/m)</th> <th>Margin (dB)</th> <th>Detector</th> </tr> </thead> <tbody> <tr> <td>1</td> <td>2390.000</td> <td>-8.10</td> <td>37.04</td> <td>28.94</td> <td>54.00</td> <td>-25.06</td> <td>AVG</td> </tr> <tr> <td>2</td> <td>2390.000</td> <td>-8.10</td> <td>49.02</td> <td>40.92</td> <td>74.00</td> <td>-33.08</td> <td>peak</td> </tr> </tbody> </table>								No.	Frequency (MHz)	Factor (dB/m)	Reading (dBuV)	Level (dBuV/m)	Limit (dBuV/m)	Margin (dB)	Detector	1	2390.000	-8.10	37.04	28.94	54.00	-25.06	AVG	2	2390.000	-8.10	49.02	40.92	74.00	-33.08	peak
No.	Frequency (MHz)	Factor (dB/m)	Reading (dBuV)	Level (dBuV/m)	Limit (dBuV/m)	Margin (dB)	Detector																								
1	2390.000	-8.10	37.04	28.94	54.00	-25.06	AVG																								
2	2390.000	-8.10	49.02	40.92	74.00	-33.08	peak																								
<p>Remarks:</p> <p>1. Factor (dB/m) = Antenna Factor (dB/m)+Cable Factor (dB)-Pre-amplifier Factor</p> <p>2. Margin value = Level -Limit value</p>																															



Ant. Pol.	Vertical
Test Mode:	GFSK Mode 2402MHz

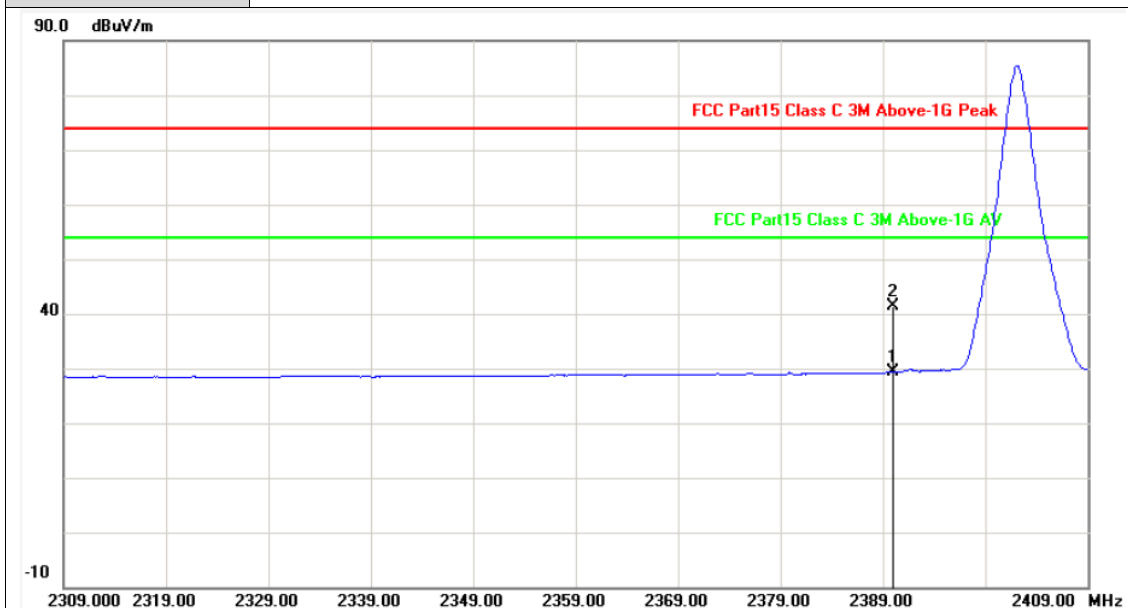

No.	Frequency (MHz)	Factor (dB/m)	Reading (dBuV)	Level (dBuV/m)	Limit (dBuV/m)	Margin (dB)	Detector
1	2390.000	-8.10	37.45	29.35	54.00	-24.65	AVG
2	2390.000	-8.10	49.44	41.34	74.00	-32.66	peak

Remarks:  
 1. Factor (dB/m) = Antenna Factor (dB/m)+Cable Factor (dB)-Pre-amplifier Factor  
 2. Margin value = Level -Limit value



<b>Ant. Pol.</b>	Horizontal
<b>Test Mode:</b>	GFSK Mode 2480 MHz

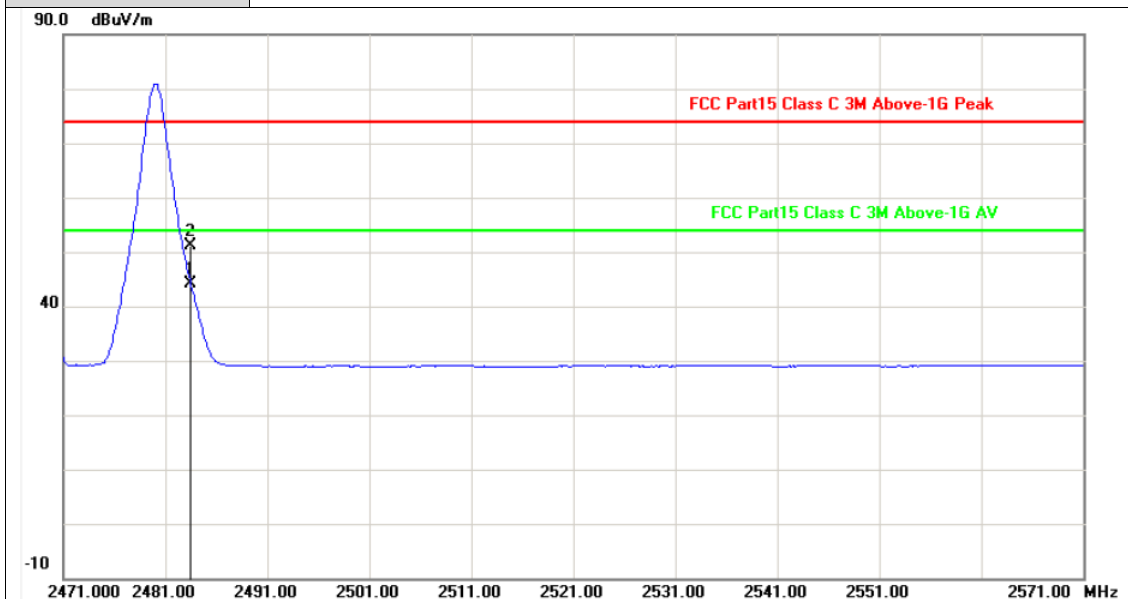

No.	Frequency (MHz)	Factor (dB/m)	Reading (dBuV)	Level (dBuV/m)	Limit (dBuV/m)	Margin (dB)	Detector
1	2483.500	-7.68	51.71	44.03	54.00	-9.97	AVG
2	2483.500	-7.68	58.77	51.09	74.00	-22.91	peak

Remarks:

- 1.Factor (dB/m) = Antenna Factor (dB/m)+Cable Factor (dB)-Pre-amplifier Factor
- 2.Margin value = Level -Limit value



<b>Ant. Pol.</b>	Vertical
<b>Test Mode:</b>	GFSK Mode 2480 MHz

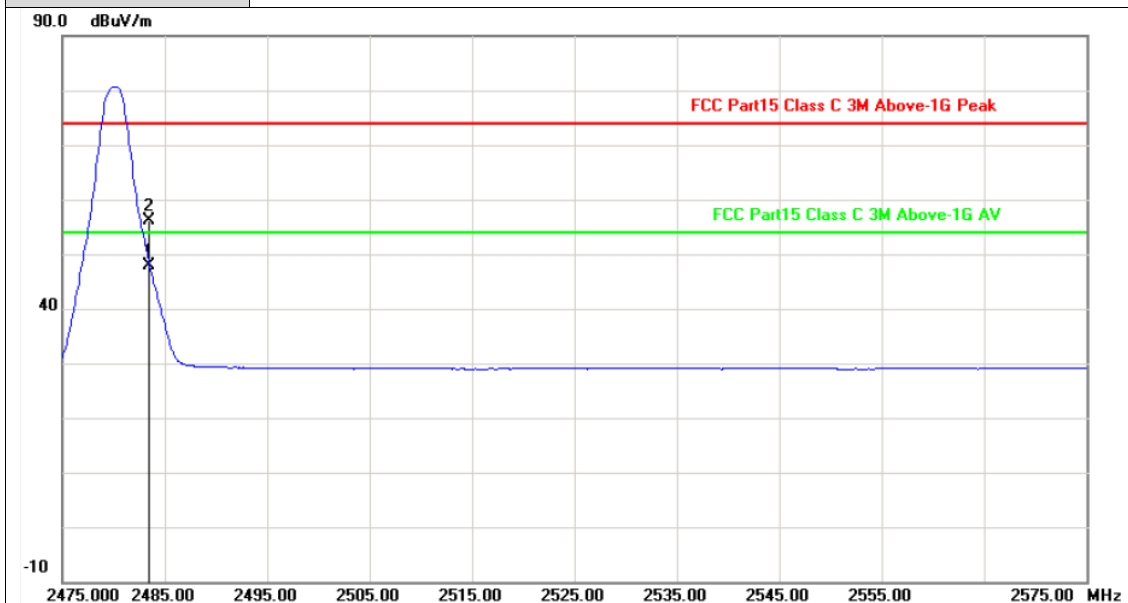

No.	Frequency (MHz)	Factor (dB/m)	Reading (dBuV)	Level (dBuV/m)	Limit (dBuV/m)	Margin (dB)	Detector
1	2483.500	-7.68	55.66	47.98	54.00	-6.02	AVG
2	2483.500	-7.68	63.79	56.11	74.00	-17.89	peak

Remarks:

- Factor (dB/m) = Antenna Factor (dB/m)+Cable Factor (dB)-Pre-amplifier Factor
- Margin value = Level -Limit value





<b>Ant. Pol.</b>	Horizontal
<b>Test Mode:</b>	$\pi/4$ -DQPSK Mode 2402MHz

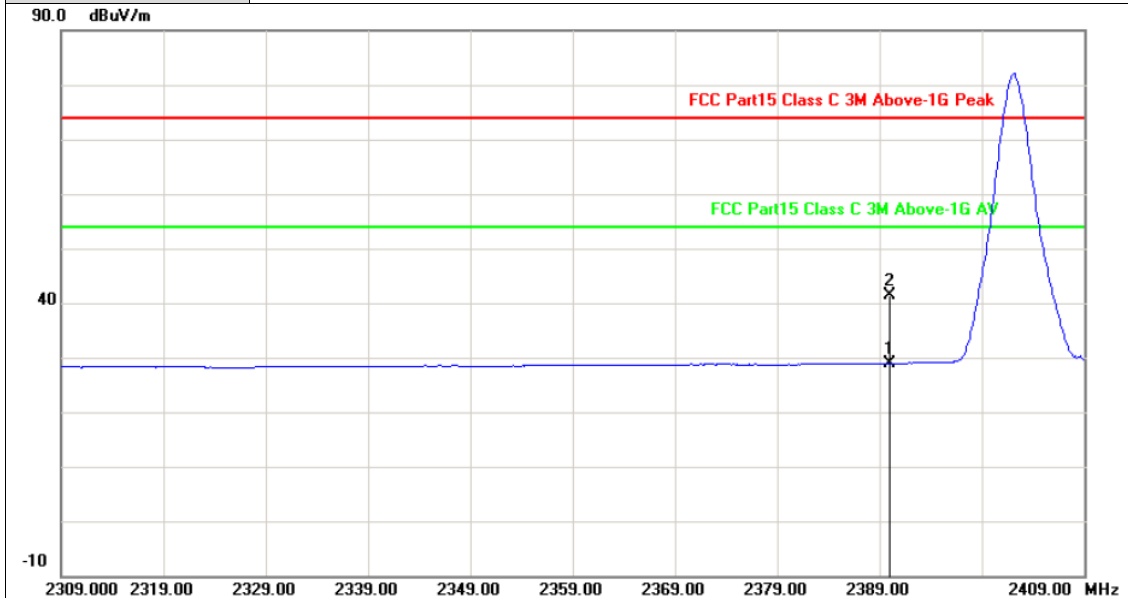

No.	Frequency (MHz)	Factor (dB/m)	Reading (dBuV)	Level (dBuV/m)	Limit (dBuV/m)	Margin (dB)	Detector
1	2390.000	-8.10	37.02	28.92	54.00	-25.08	AVG
2	2390.000	-8.10	49.53	41.43	74.00	-32.57	peak

Remarks:

1. Factor (dB/m) = Antenna Factor (dB/m)+Cable Factor (dB)-Pre-amplifier Factor
2. Margin value = Level -Limit value



Ant. Pol.	Vertical
Test Mode:	$\pi/4$ -DQPSK Mode 2402MHz

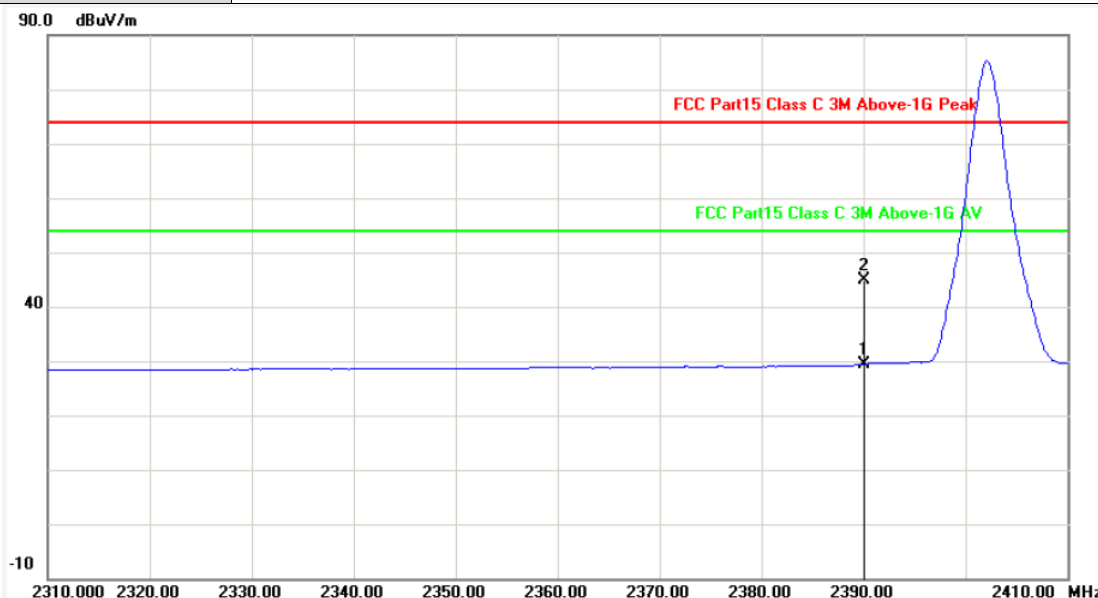

No.	Frequency (MHz)	Factor (dB/m)	Reading (dBuV)	Level (dBuV/m)	Limit (dBuV/m)	Margin (dB)	Detector
1	2390.000	-8.10	37.44	29.34	54.00	-24.66	AVG
2	2390.000	-8.10	52.87	44.77	74.00	-29.23	peak

Remarks:

- Factor (dB/m) = Antenna Factor (dB/m)+Cable Factor (dB)-Pre-amplifier Factor
- Margin value = Level -Limit value



Ant. Pol.	Horizontal
Test Mode:	$\pi/4$ -DQPSK Mode 2480MHz

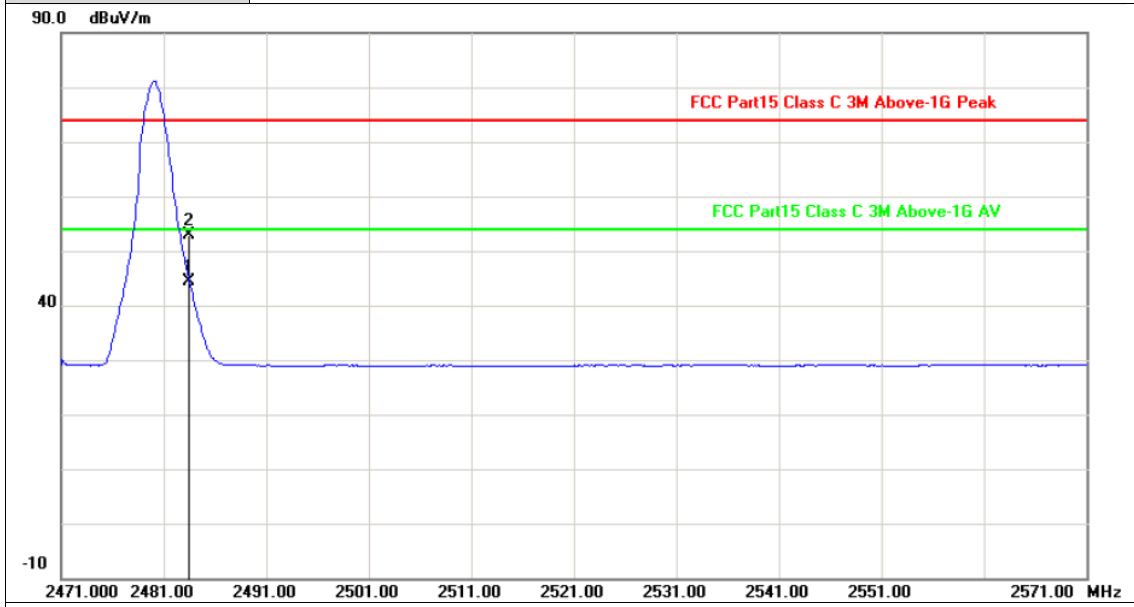

No.	Frequency (MHz)	Factor (dB/m)	Reading (dBuV)	Level (dBuV/m)	Limit (dBuV/m)	Margin (dB)	Detector
1	2483.500	-7.68	52.03	44.35	54.00	-9.65	AVG
2	2483.500	-7.68	60.60	52.92	74.00	-21.08	peak

Remarks:

- Factor (dB/m) = Antenna Factor (dB/m)+Cable Factor (dB)-Pre-amplifier Factor
- Margin value = Level -Limit value

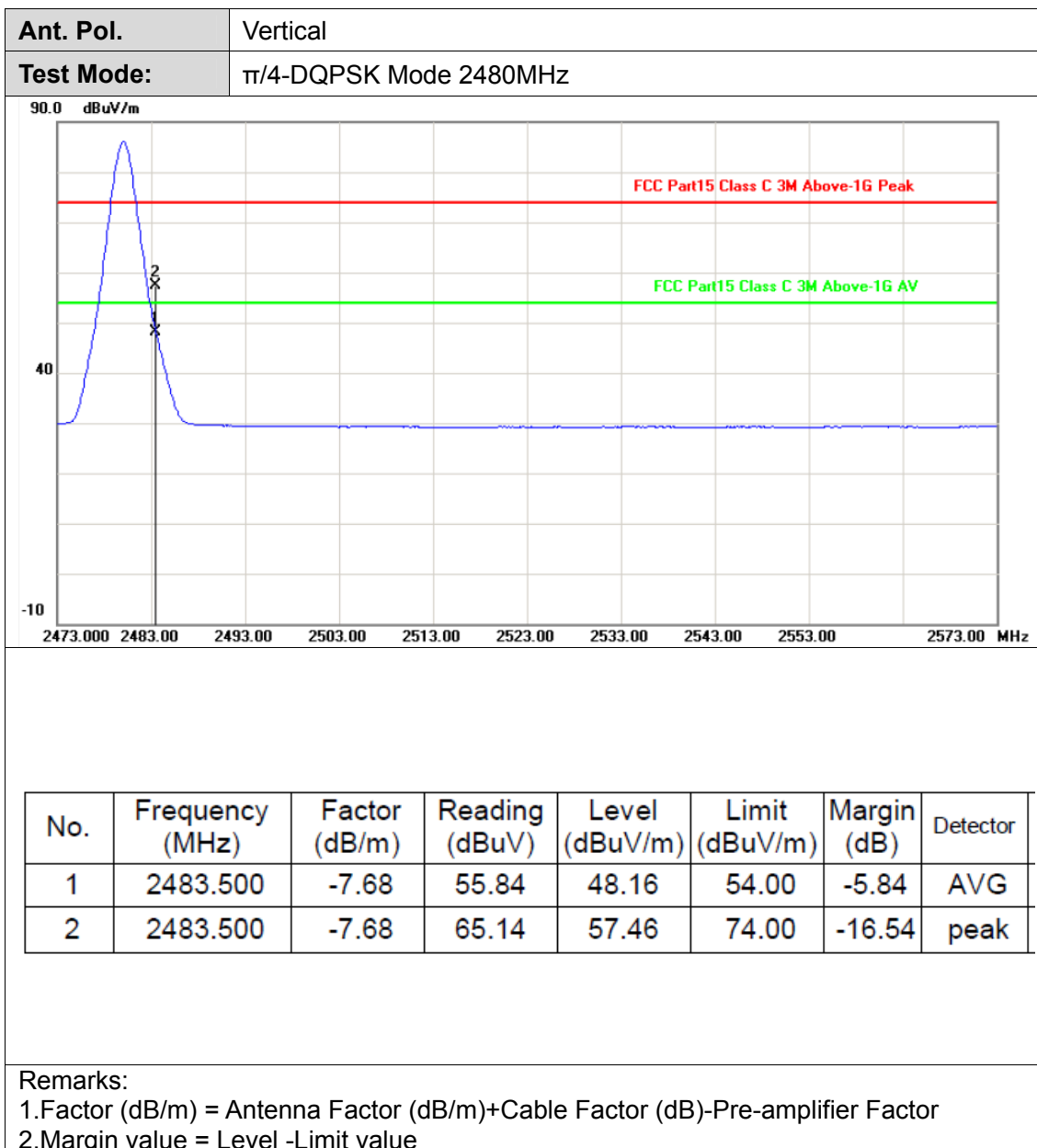



Ant. Pol.	Horizontal
Test Mode:	8-DPSK Mode 2402MHz

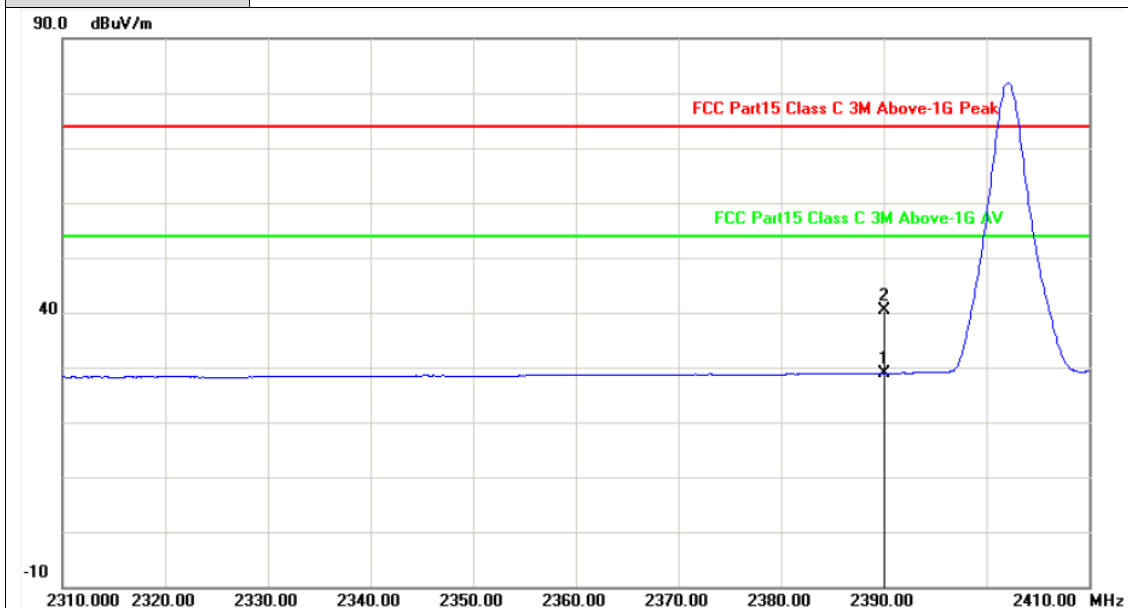

No.	Frequency (MHz)	Factor (dB/m)	Reading (dBuV)	Level (dBuV/m)	Limit (dBuV/m)	Margin (dB)	Detector
1	2390.000	-8.10	36.99	28.89	54.00	-25.11	AVG
2	2390.000	-8.10	48.45	40.35	74.00	-33.65	peak

Remarks:  
 1. Factor (dB/m) = Antenna Factor (dB/m)+Cable Factor (dB)-Pre-amplifier Factor  
 2. Margin value = Level -Limit value



Ant. Pol.	Vertical
Test Mode:	8-DPSK Mode 2402MHz

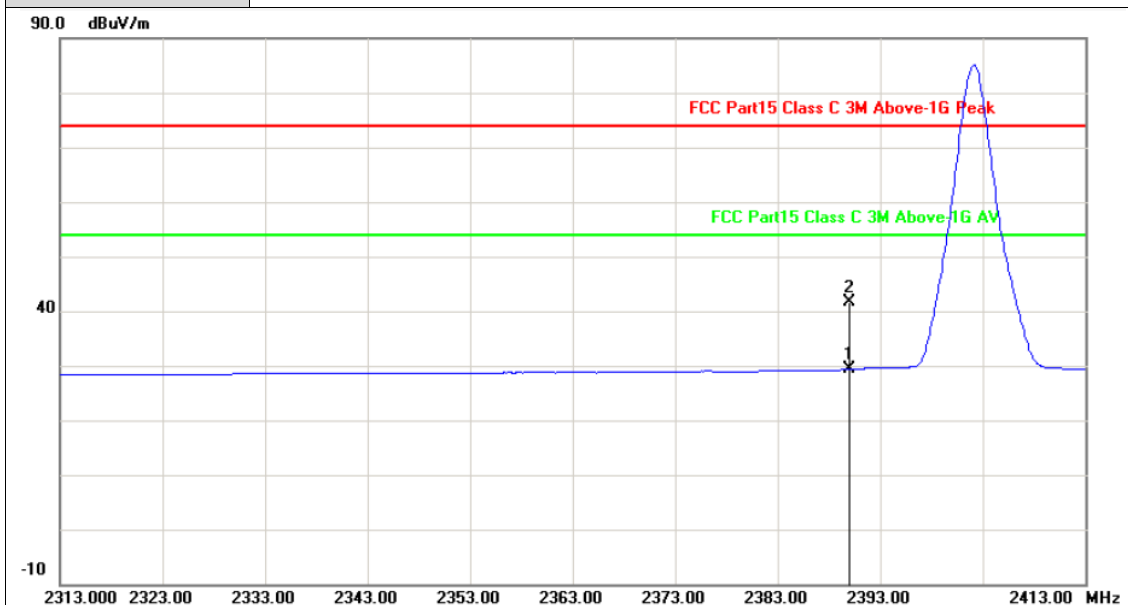

No.	Frequency (MHz)	Factor (dB/m)	Reading (dBuV)	Level (dBuV/m)	Limit (dBuV/m)	Margin (dB)	Detector
1	2390.000	-8.10	37.50	29.40	54.00	-24.60	AVG
2	2390.000	-8.10	49.67	41.57	74.00	-32.43	peak

Remarks:

1. Factor (dB/m) = Antenna Factor (dB/m)+Cable Factor (dB)-Pre-amplifier Factor
2. Margin value = Level -Limit value



Ant. Pol.	Horizontal
Test Mode:	8-DPSK Mode 2480MHz

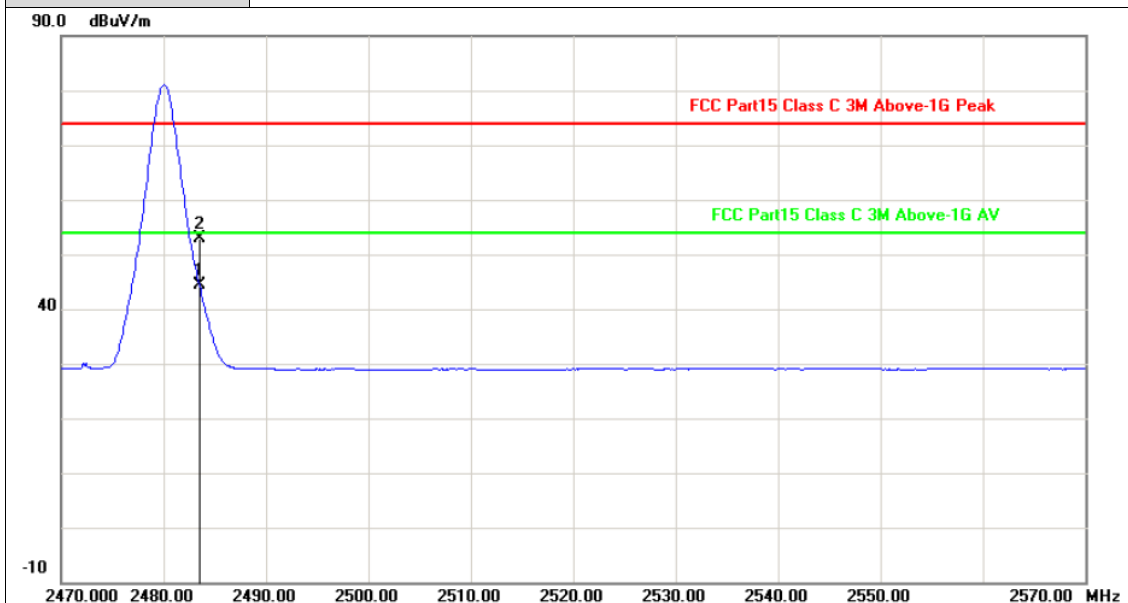

No.	Frequency (MHz)	Factor (dB/m)	Reading (dBuV)	Level (dBuV/m)	Limit (dBuV/m)	Margin (dB)	Detector
1	2483.500	-7.68	51.98	44.30	54.00	-9.70	AVG
2	2483.500	-7.68	60.64	52.96	74.00	-21.04	peak

Remarks:

- Factor (dB/m) = Antenna Factor (dB/m)+Cable Factor (dB)-Pre-amplifier Factor
- Margin value = Level -Limit value

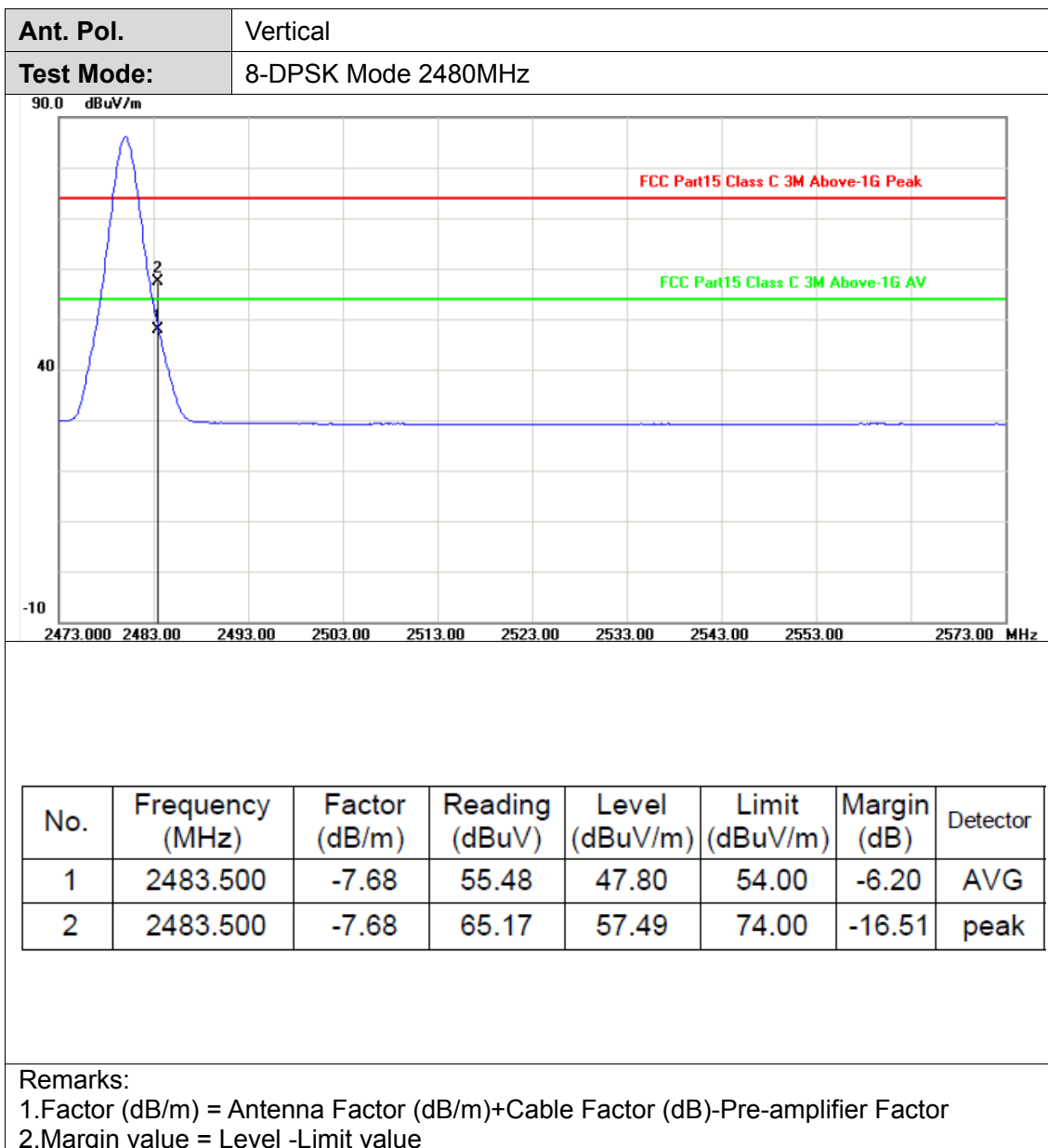





(2) Conducted Test

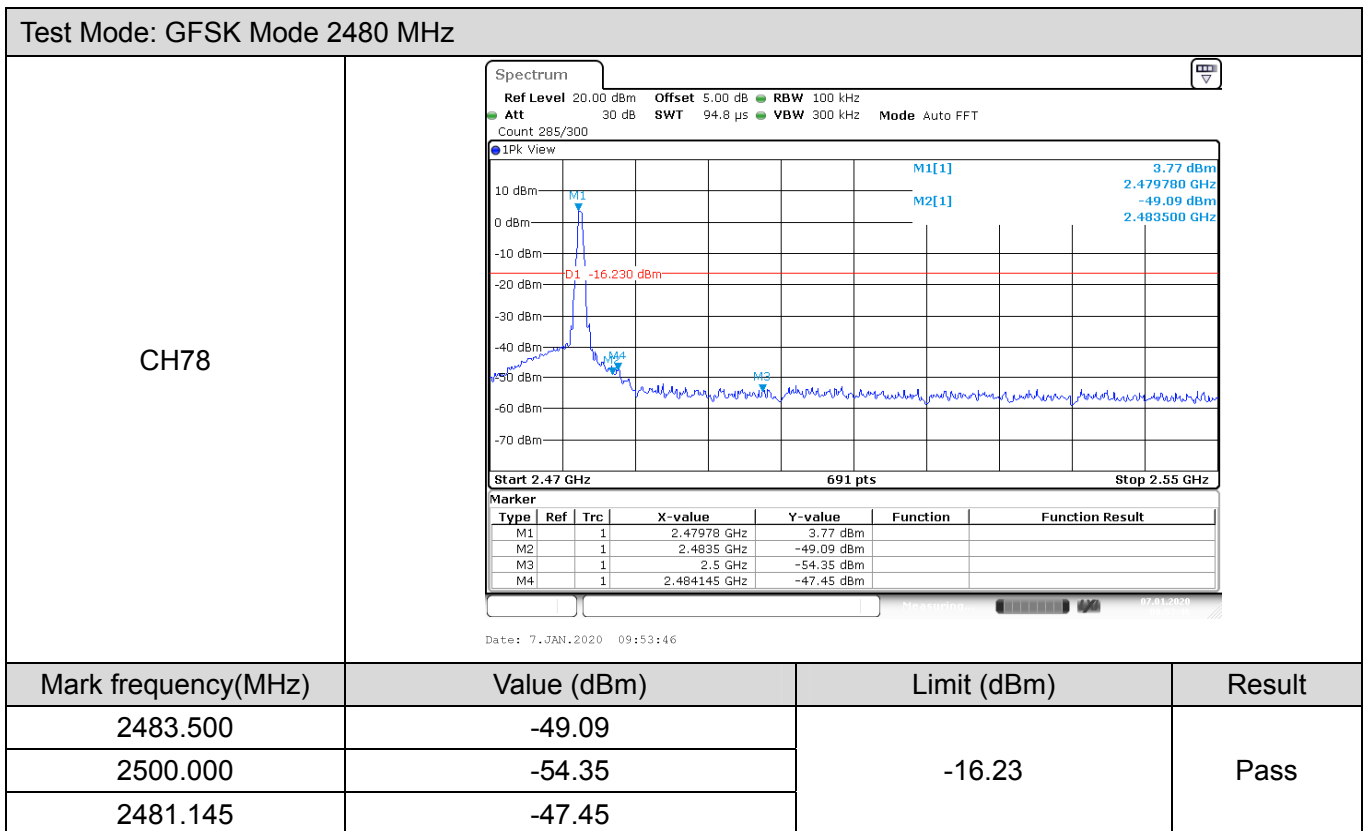
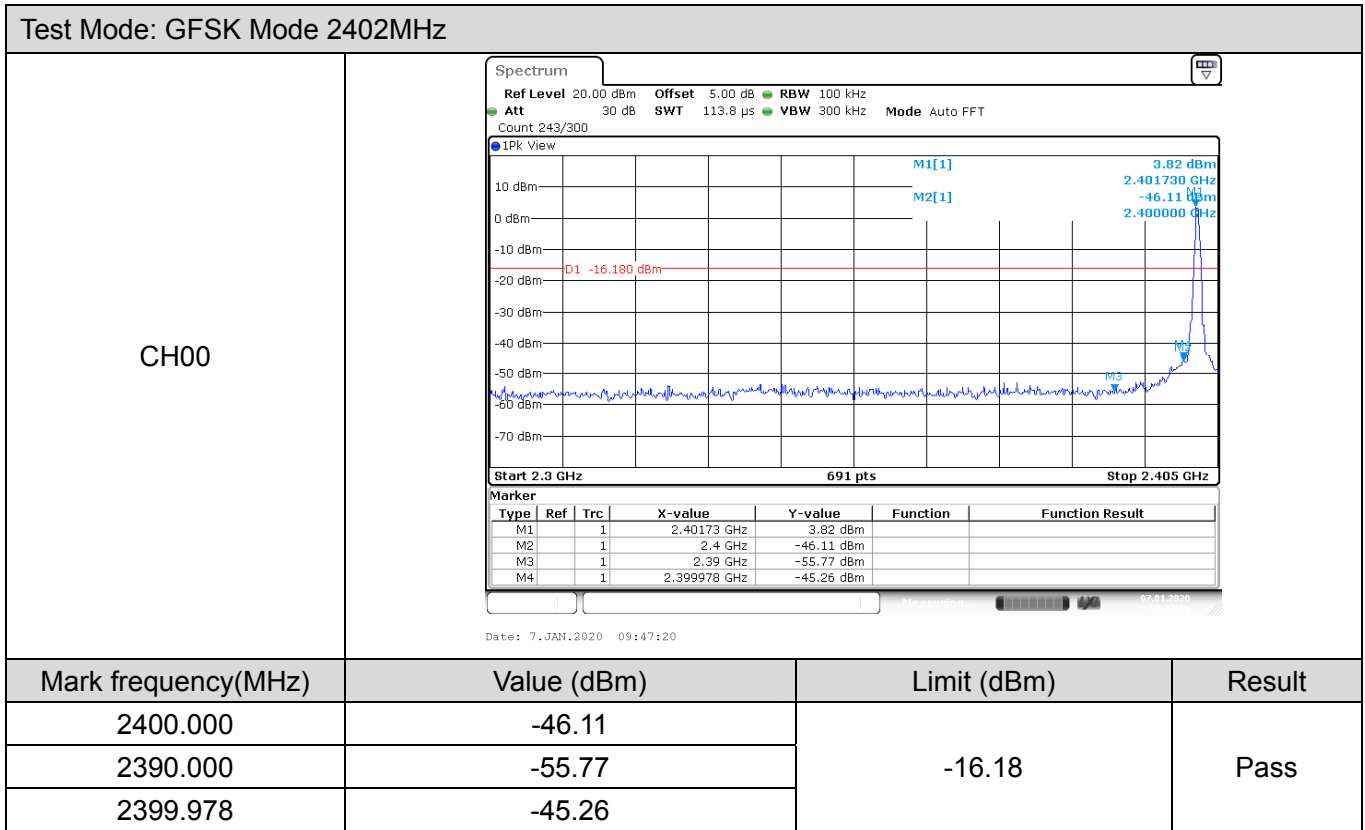

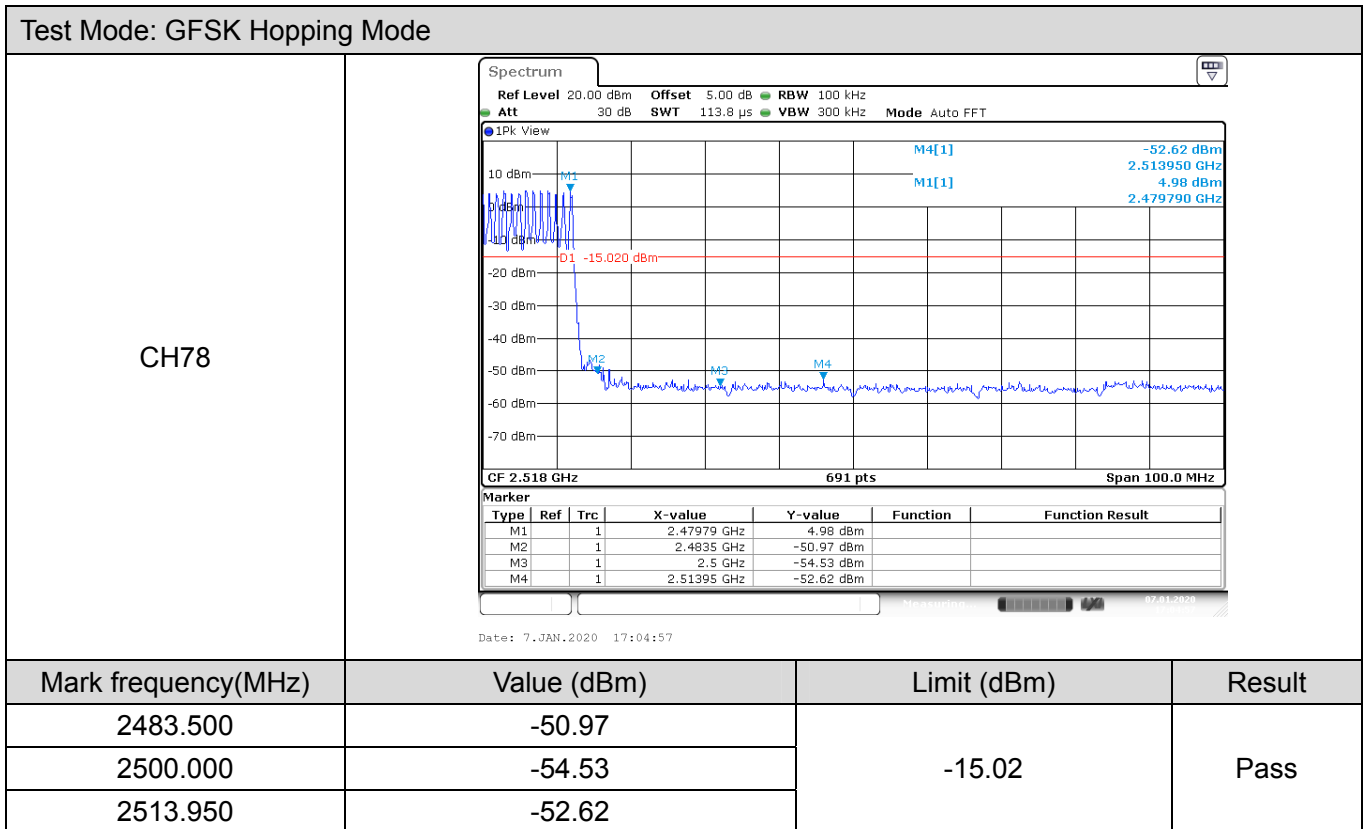
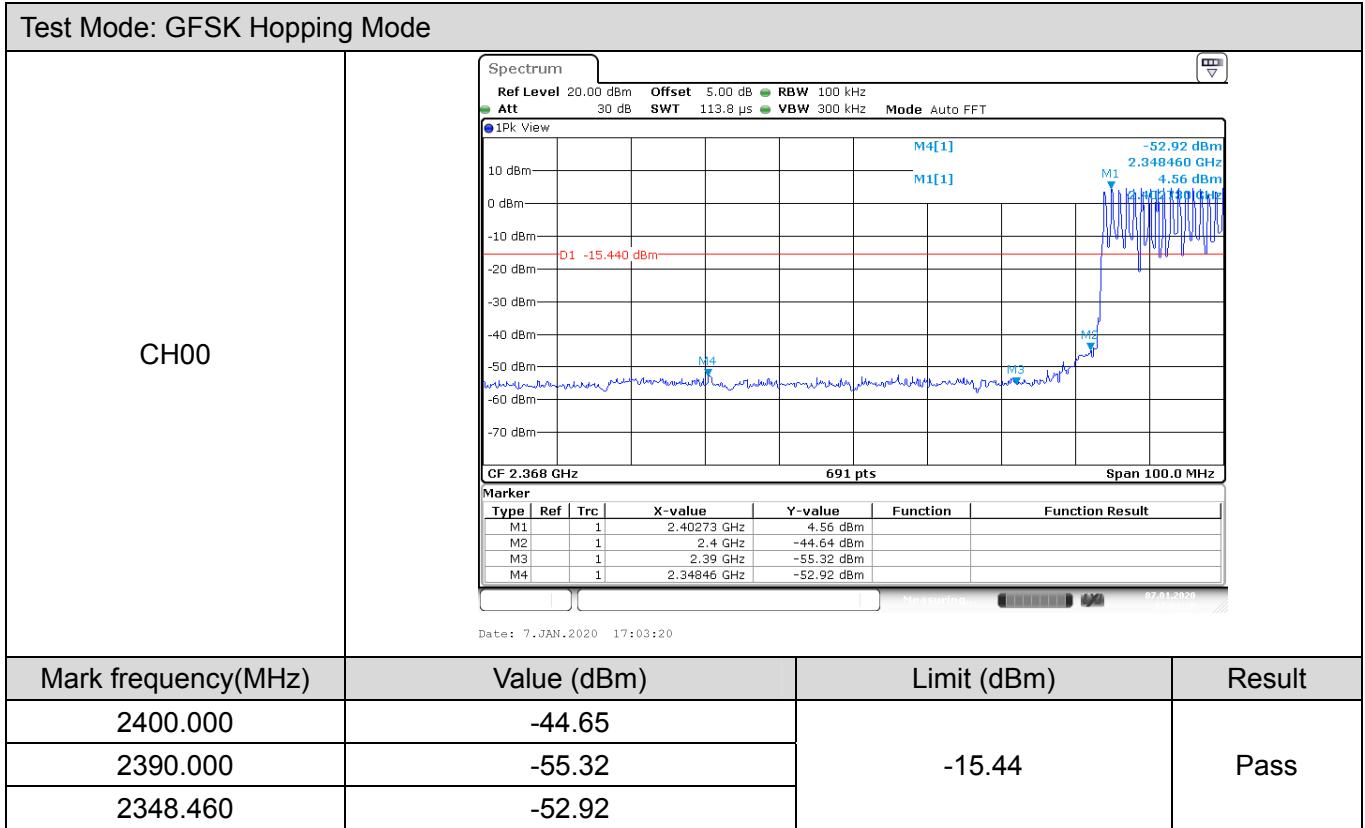



Test Mode:π/4-DQPSK Mode 2402MHz

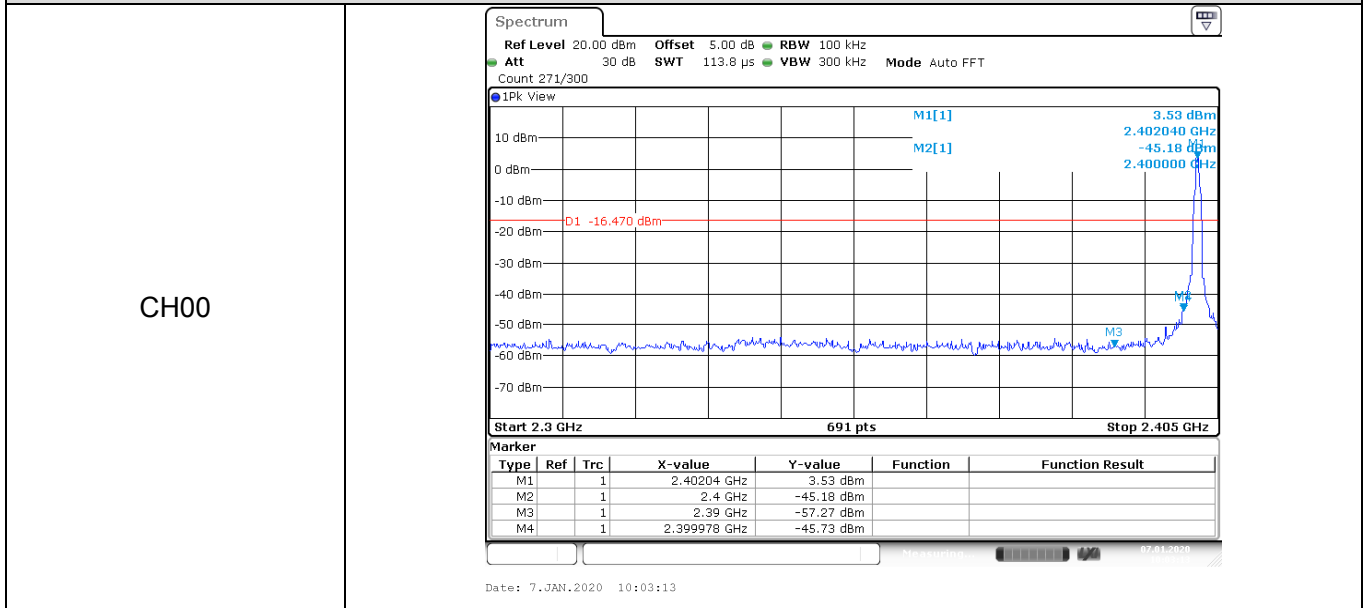

Mark frequency(MHz)	Value (dBm)	Limit (dBm)	Result
2400.000	-45.18	-16.47	Pass
2390.000	-57.27		
2399.978	-45.73		

Test Mode:π/4-DQPSK Mode 2480 MHz

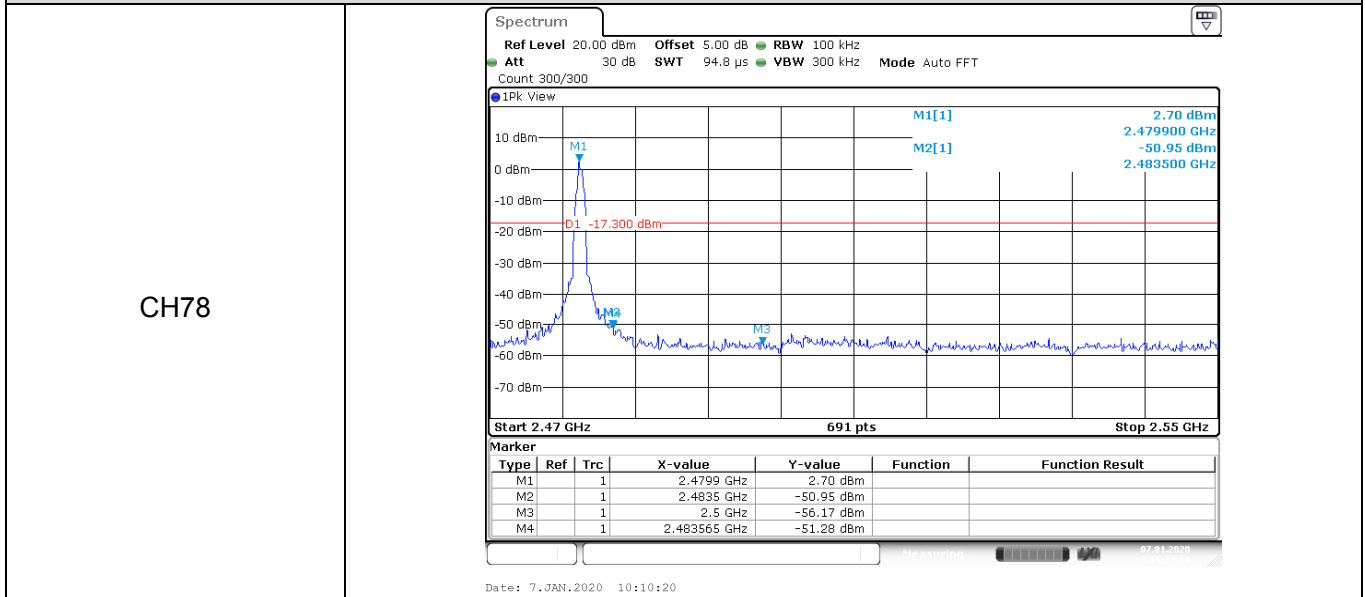

Mark frequency(MHz)	Value (dBm)	Limit (dBm)	Result
2483.500	-50.95	-17.30	Pass
2500.000	-56.17		
2533.090	-51.28		

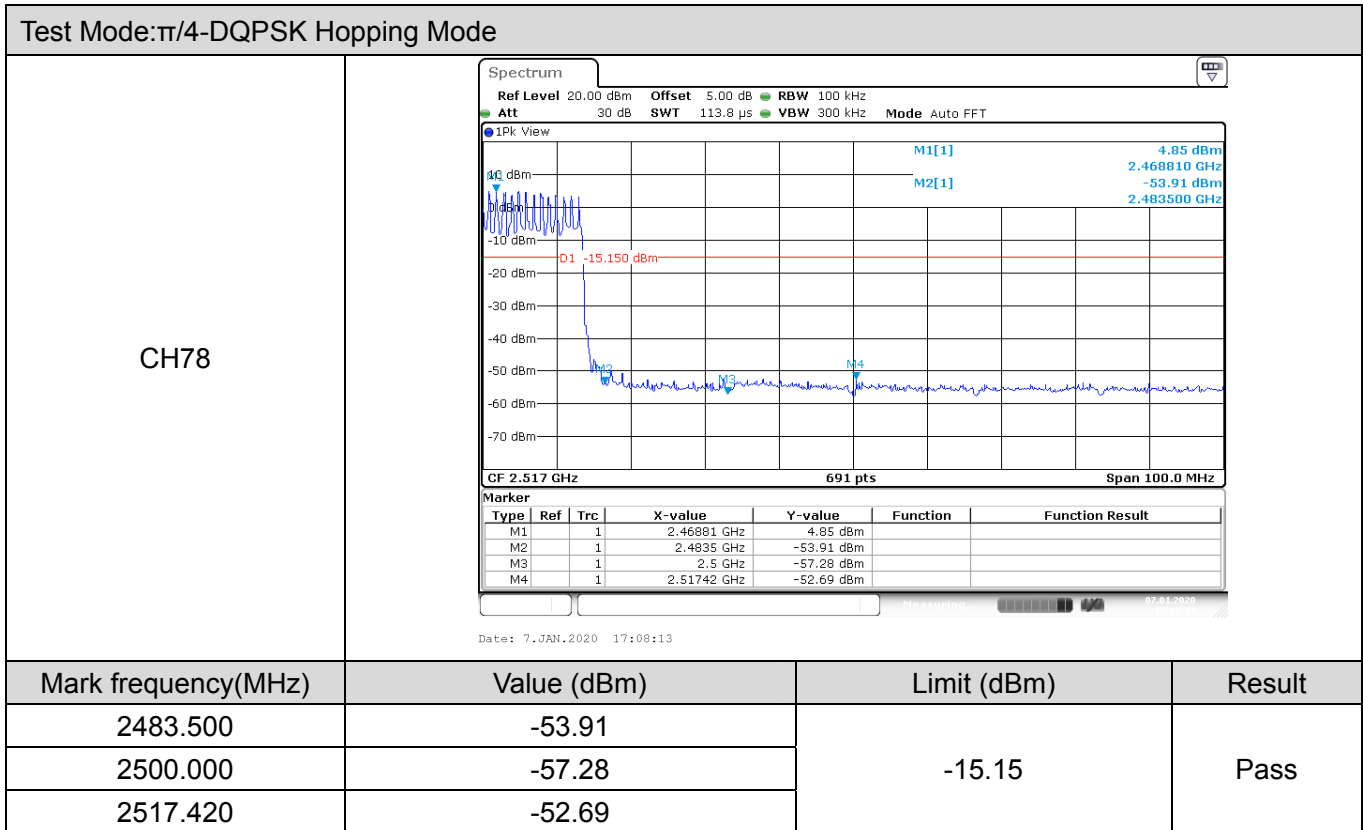
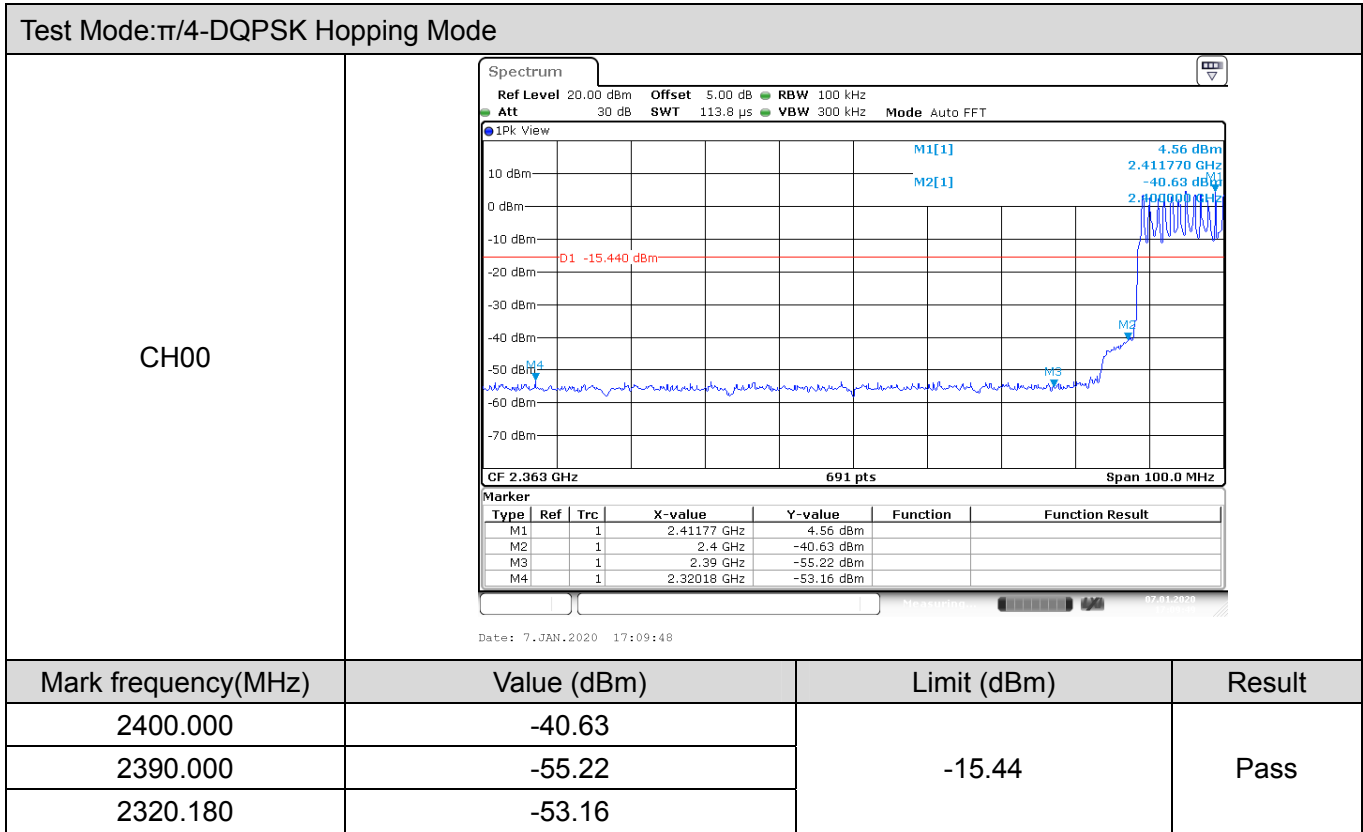



Test Mode: 8-DPSK Mode 2402MHz

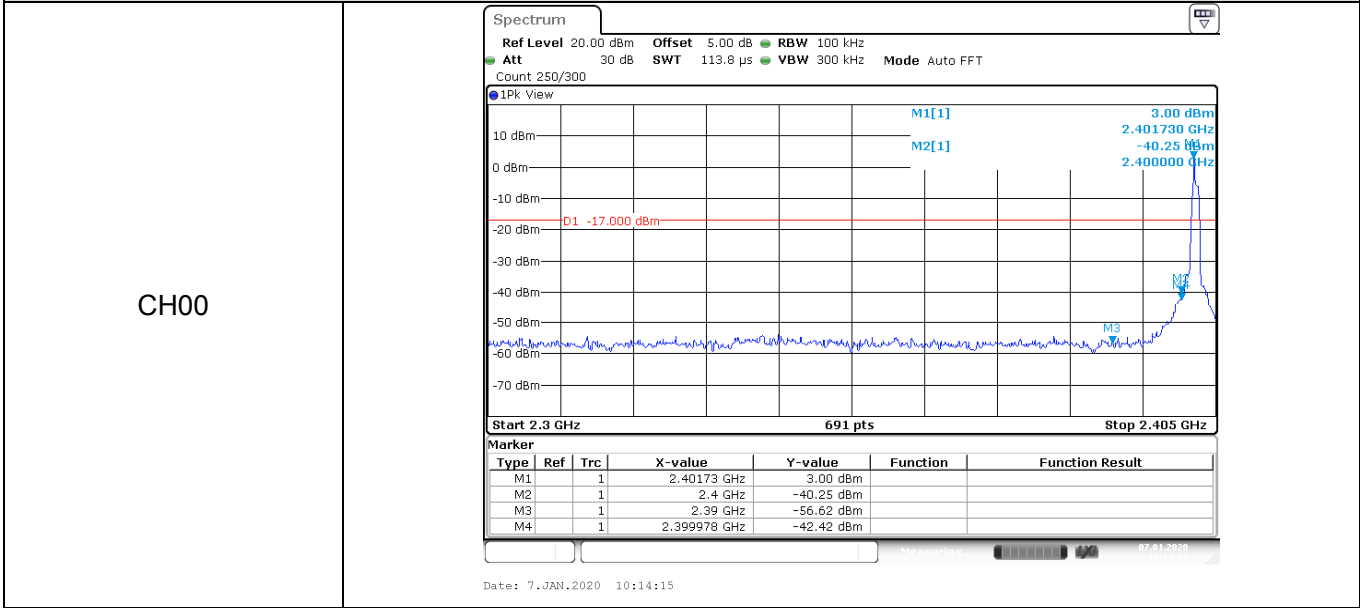

Mark frequency(MHz)	Value (dBm)	Limit (dBm)	Result
2400.000	-40.25	-17.00	Pass
2390.000	-56.62		
2399.978	-42.42		

Test Mode: 8-DPSK Mode 2480 MHz

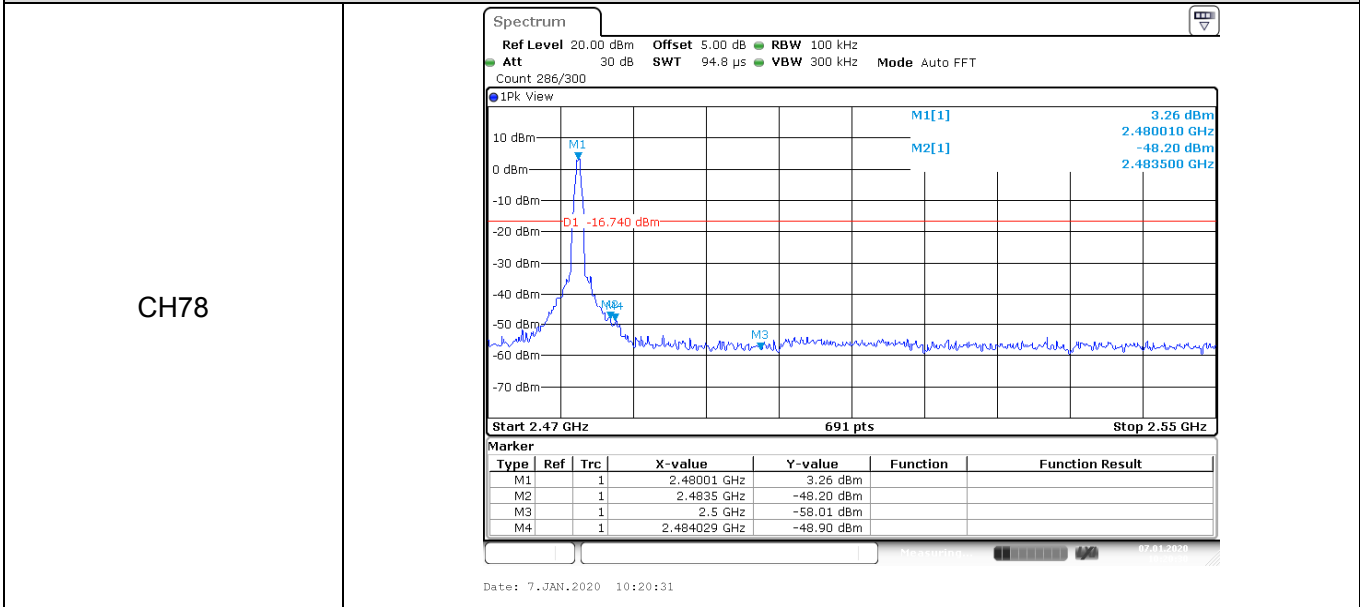

Mark frequency(MHz)	Value (dBm)	Limit (dBm)	Result
2483.500	-48.20	-16.74	Pass
2500.000	-58.01		
2484.029	-48.90		



Test Mode: 8-DPSK Hopping Mode

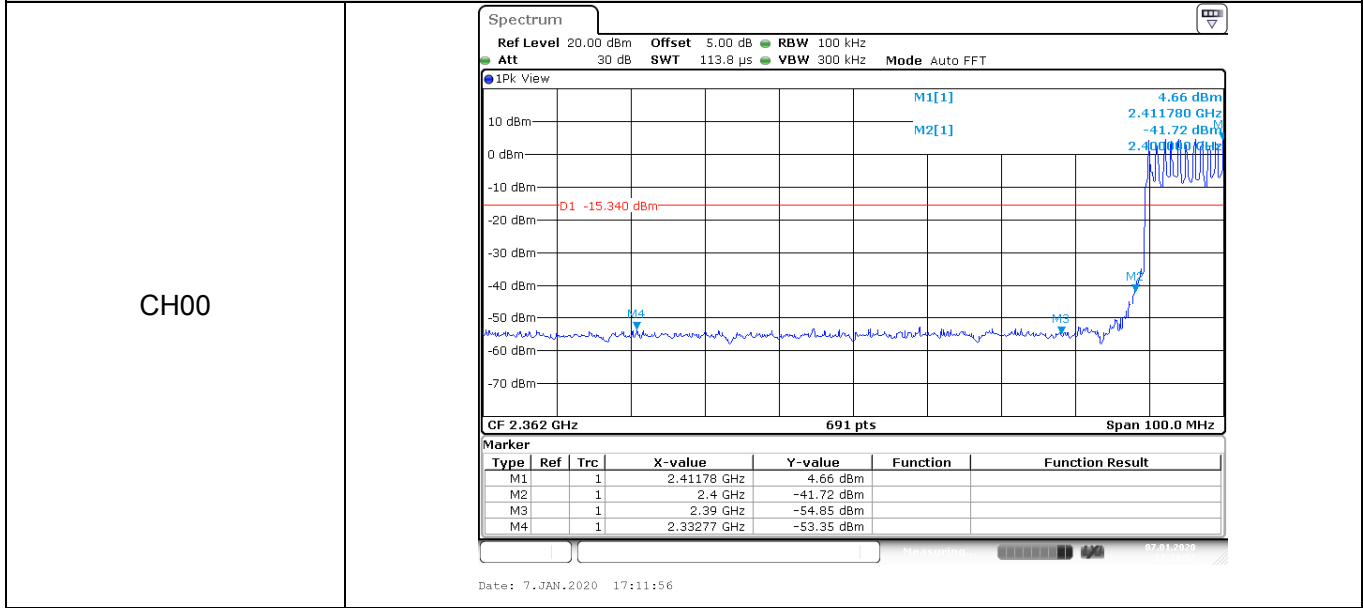

Mark frequency(MHz)	Value (dBm)	Limit (dBm)	Result
2400.000	-41.72	-15.34	Pass
2390.000	-54.85		
2332.770	-53.35		

Test Mode: 8-DPSK Hopping Mode

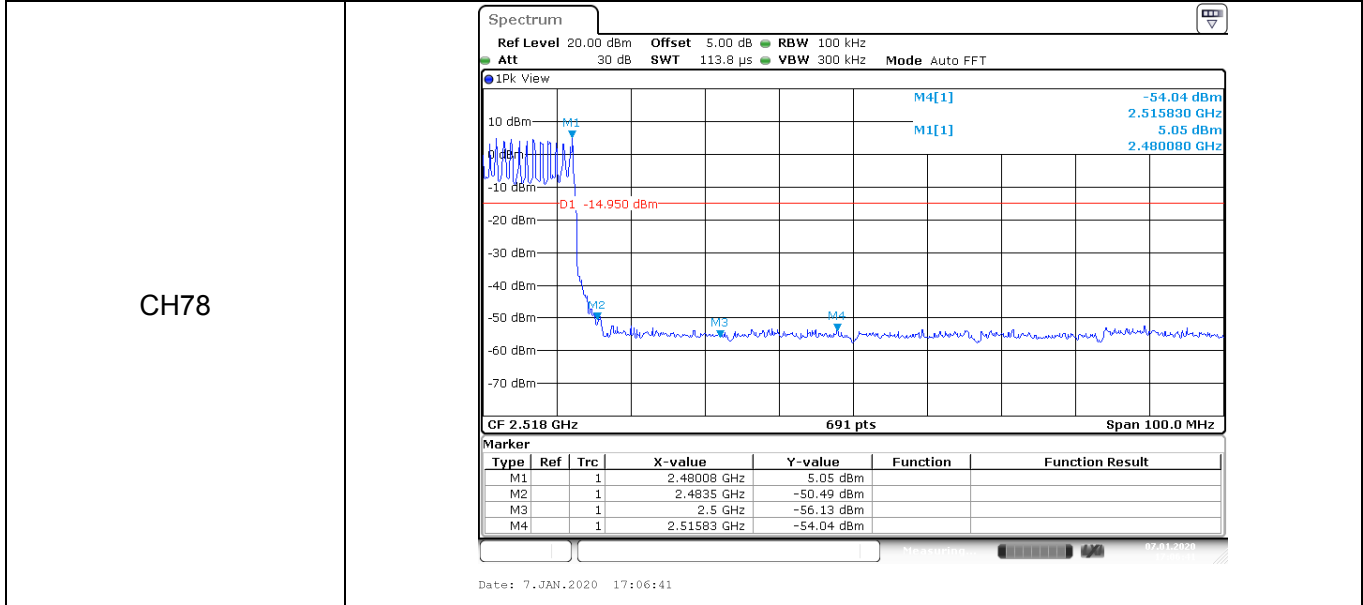

Mark frequency(MHz)	Value (dBm)	Limit (dBm)	Result
2483.500	-50.49	-14.95	Pass
2500.000	-56.13		
2515.830	-54.04		



### 3.4. Occupied Channel Bandwidth and 20DB Bandwidth

#### Limit

N/A

#### Test Configuration

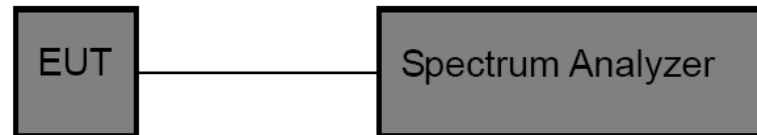

#### Test Procedure

1. The EUT was directly connected to the spectrum analyzer and antenna output port as show in the block diagram above.
2. Spectrum Setting:
  - (1) Set RBW = 100 kHz.
  - (2) Set the video bandwidth (VBW)  $\geq 3$  RBW.
  - (3) Detector = Peak.
  - (4) Trace mode = Max hold.
  - (5) Sweep = Auto couple.

Note: The EUT was set to continuously transmitting in each mode and low, Middle and high channel for the test.

#### Test Mode

Please refer to the clause 2.3.

#### Test Results

Modulation type	Channel	99% Bandwidth (kHz)	20dB Bandwidth (kHz)	20dB Bandwidth *2/3 (kHz)
GFSK	00	962	1116	744.00
	39	965	1116	744.00
	78	965	1116	744.00
$\pi/4$ -DQPSK	00	1109	1251	834.00
	39	1115	1257	838.00
	78	1109	1254	836.00
8-DPSK	00	1118	1254	836.00
	39	1118	1260	840.00
	78	1121	1260	840.00



20dB Bandwidth																																	
Modulation Type: GFSK																																	
CH00	<p><b>Spectrum</b>  Ref Level 30.00 dBm Offset 5.00 dB RBW 100 kHz  Att 40 dB SWT 18.9 μs VBW 300 kHz Mode Auto FFT  Count 100/100</p> <p>IPk View</p> <table border="1"> <thead> <tr> <th>Marker</th> <th>Type</th> <th>Ref</th> <th>Trc</th> <th>X-value</th> <th>Y-value</th> <th>Function</th> <th>Function Result</th> </tr> </thead> <tbody> <tr> <td>M1</td> <td>1</td> <td></td> <td>1</td> <td>2.401394 GHz</td> <td>-16.45 dBm</td> <td></td> <td></td> </tr> <tr> <td>M2</td> <td>1</td> <td></td> <td>1</td> <td>2.401787 GHz</td> <td>3.69 dBm</td> <td></td> <td></td> </tr> <tr> <td>D3</td> <td>M1</td> <td>1</td> <td>1</td> <td>1.116 MHz</td> <td>-0.01 dB</td> <td></td> <td></td> </tr> </tbody> </table> <p>CF 2.402 GHz 1001 pts Span 3.0 MHz</p> <p>Date: 7. JAN. 2020 09:46:47</p>	Marker	Type	Ref	Trc	X-value	Y-value	Function	Function Result	M1	1		1	2.401394 GHz	-16.45 dBm			M2	1		1	2.401787 GHz	3.69 dBm			D3	M1	1	1	1.116 MHz	-0.01 dB		
Marker	Type	Ref	Trc	X-value	Y-value	Function	Function Result																										
M1	1		1	2.401394 GHz	-16.45 dBm																												
M2	1		1	2.401787 GHz	3.69 dBm																												
D3	M1	1	1	1.116 MHz	-0.01 dB																												
CH39	<p><b>Spectrum</b>  Ref Level 30.00 dBm Offset 5.00 dB RBW 100 kHz  Att 40 dB SWT 18.9 μs VBW 300 kHz Mode Auto FFT  Count 100/100</p> <p>IPk View</p> <table border="1"> <thead> <tr> <th>Marker</th> <th>Type</th> <th>Ref</th> <th>Trc</th> <th>X-value</th> <th>Y-value</th> <th>Function</th> <th>Function Result</th> </tr> </thead> <tbody> <tr> <td>M1</td> <td>1</td> <td></td> <td>1</td> <td>2.440394 GHz</td> <td>-16.36 dBm</td> <td></td> <td></td> </tr> <tr> <td>M2</td> <td>1</td> <td></td> <td>1</td> <td>2.441117 GHz</td> <td>3.80 dBm</td> <td></td> <td></td> </tr> <tr> <td>D3</td> <td>M1</td> <td>1</td> <td>1</td> <td>1.116 MHz</td> <td>-0.02 dB</td> <td></td> <td></td> </tr> </tbody> </table> <p>CF 2.441 GHz 1001 pts Span 3.0 MHz</p> <p>Date: 7. JAN. 2020 09:50:21</p>	Marker	Type	Ref	Trc	X-value	Y-value	Function	Function Result	M1	1		1	2.440394 GHz	-16.36 dBm			M2	1		1	2.441117 GHz	3.80 dBm			D3	M1	1	1	1.116 MHz	-0.02 dB		
Marker	Type	Ref	Trc	X-value	Y-value	Function	Function Result																										
M1	1		1	2.440394 GHz	-16.36 dBm																												
M2	1		1	2.441117 GHz	3.80 dBm																												
D3	M1	1	1	1.116 MHz	-0.02 dB																												
CH78	<p><b>Spectrum</b>  Ref Level 30.00 dBm Offset 5.00 dB RBW 100 kHz  Att 40 dB SWT 18.9 μs VBW 300 kHz Mode Auto FFT  Count 100/100</p> <p>IPk View</p> <table border="1"> <thead> <tr> <th>Marker</th> <th>Type</th> <th>Ref</th> <th>Trc</th> <th>X-value</th> <th>Y-value</th> <th>Function</th> <th>Function Result</th> </tr> </thead> <tbody> <tr> <td>M1</td> <td>1</td> <td></td> <td>1</td> <td>2.479394 GHz</td> <td>-15.78 dBm</td> <td></td> <td></td> </tr> <tr> <td>M2</td> <td>1</td> <td></td> <td>1</td> <td>2.479787 GHz</td> <td>4.25 dBm</td> <td></td> <td></td> </tr> <tr> <td>D3</td> <td>M1</td> <td>1</td> <td>1</td> <td>1.116 MHz</td> <td>-0.01 dB</td> <td></td> <td></td> </tr> </tbody> </table> <p>CF 2.48 GHz 1001 pts Span 3.0 MHz</p> <p>Date: 7. JAN. 2020 09:53:13</p>	Marker	Type	Ref	Trc	X-value	Y-value	Function	Function Result	M1	1		1	2.479394 GHz	-15.78 dBm			M2	1		1	2.479787 GHz	4.25 dBm			D3	M1	1	1	1.116 MHz	-0.01 dB		
Marker	Type	Ref	Trc	X-value	Y-value	Function	Function Result																										
M1	1		1	2.479394 GHz	-15.78 dBm																												
M2	1		1	2.479787 GHz	4.25 dBm																												
D3	M1	1	1	1.116 MHz	-0.01 dB																												

CTC Laboratories, Inc.

2/F., Building 1 and 1-2/F., Building 2, Jiaquan Building, Guanlan High-Tech Park, Longhua District, Shenzhen, Guangdong, China  
Tel.: (86)755-27521059 Fax: (86)755-27521011 Http://www.sz-ctc.org.cn



For anti-fake verification, please visit the official website of Certification and Accreditation Administration of the People's Republic of China : [yz.cnca.cn](http://yz.cnca.cn)





Modulation Type:		$\pi/4$ -DQPSK																												
CH00	<p>Spectrum</p> <p>Ref Level 30.00 dBm Offset 5.00 dB RBW 100 kHz Att 40 dB SWT 18.9 <math>\mu</math>s VBW 300 kHz Mode Auto FFT Count 100/100</p> <p>IPk View</p> <p>CF 2.402 GHz 1001 pts Span 3.0 MHz</p> <table border="1"> <thead> <tr> <th>Type</th> <th>Ref</th> <th>Trc</th> <th>X-value</th> <th>Y-value</th> <th>Function</th> <th>Function Result</th> </tr> </thead> <tbody> <tr> <td>M1</td> <td></td> <td>1</td> <td>2.401322 GHz</td> <td>-16.37 dBm</td> <td></td> <td></td> </tr> <tr> <td>M2</td> <td></td> <td>1</td> <td>2.402117 GHz</td> <td>3.70 dBm</td> <td></td> <td></td> </tr> <tr> <td>D3</td> <td>M1</td> <td>1</td> <td>1.251 MHz</td> <td>-0.03 dB</td> <td></td> <td></td> </tr> </tbody> </table> <p>Date: 7.JAN.2020 10:02:41</p>		Type	Ref	Trc	X-value	Y-value	Function	Function Result	M1		1	2.401322 GHz	-16.37 dBm			M2		1	2.402117 GHz	3.70 dBm			D3	M1	1	1.251 MHz	-0.03 dB		
Type	Ref	Trc	X-value	Y-value	Function	Function Result																								
M1		1	2.401322 GHz	-16.37 dBm																										
M2		1	2.402117 GHz	3.70 dBm																										
D3	M1	1	1.251 MHz	-0.03 dB																										
CH39	<p>Spectrum</p> <p>Ref Level 30.00 dBm Offset 5.00 dB RBW 100 kHz Att 40 dB SWT 18.9 <math>\mu</math>s VBW 300 kHz Mode Auto FFT Count 100/100</p> <p>IPk View</p> <p>CF 2.441 GHz 1001 pts Span 3.0 MHz</p> <table border="1"> <thead> <tr> <th>Type</th> <th>Ref</th> <th>Trc</th> <th>X-value</th> <th>Y-value</th> <th>Function</th> <th>Function Result</th> </tr> </thead> <tbody> <tr> <td>M1</td> <td></td> <td>1</td> <td>2.440319 GHz</td> <td>-16.40 dBm</td> <td></td> <td></td> </tr> <tr> <td>M2</td> <td></td> <td>1</td> <td>2.441117 GHz</td> <td>3.80 dBm</td> <td></td> <td></td> </tr> <tr> <td>D3</td> <td>M1</td> <td>1</td> <td>1.257 MHz</td> <td>-0.10 dB</td> <td></td> <td></td> </tr> </tbody> </table> <p>Date: 7.JAN.2020 10:06:28</p>		Type	Ref	Trc	X-value	Y-value	Function	Function Result	M1		1	2.440319 GHz	-16.40 dBm			M2		1	2.441117 GHz	3.80 dBm			D3	M1	1	1.257 MHz	-0.10 dB		
Type	Ref	Trc	X-value	Y-value	Function	Function Result																								
M1		1	2.440319 GHz	-16.40 dBm																										
M2		1	2.441117 GHz	3.80 dBm																										
D3	M1	1	1.257 MHz	-0.10 dB																										
CH78	<p>Spectrum</p> <p>Ref Level 30.00 dBm Offset 5.00 dB RBW 100 kHz Att 40 dB SWT 18.9 <math>\mu</math>s VBW 300 kHz Mode Auto FFT Count 100/100</p> <p>IPk View</p> <p>CF 2.48 GHz 1001 pts Span 3.0 MHz</p> <table border="1"> <thead> <tr> <th>Type</th> <th>Ref</th> <th>Trc</th> <th>X-value</th> <th>Y-value</th> <th>Function</th> <th>Function Result</th> </tr> </thead> <tbody> <tr> <td>M1</td> <td></td> <td>1</td> <td>2.479319 GHz</td> <td>-15.92 dBm</td> <td></td> <td></td> </tr> <tr> <td>M2</td> <td></td> <td>1</td> <td>2.480117 GHz</td> <td>4.25 dBm</td> <td></td> <td></td> </tr> <tr> <td>D3</td> <td>M1</td> <td>1</td> <td>1.254 MHz</td> <td>-0.04 dB</td> <td></td> <td></td> </tr> </tbody> </table> <p>Date: 7.JAN.2020 10:09:47</p>		Type	Ref	Trc	X-value	Y-value	Function	Function Result	M1		1	2.479319 GHz	-15.92 dBm			M2		1	2.480117 GHz	4.25 dBm			D3	M1	1	1.254 MHz	-0.04 dB		
Type	Ref	Trc	X-value	Y-value	Function	Function Result																								
M1		1	2.479319 GHz	-15.92 dBm																										
M2		1	2.480117 GHz	4.25 dBm																										
D3	M1	1	1.254 MHz	-0.04 dB																										

CTC Laboratories, Inc.

2/F., Building 1 and 1-2/F., Building 2, Jiaquan Building, Guanlan High-Tech Park, Longhua District, Shenzhen, Guangdong, China  
Tel.: (86)755-27521059 Fax: (86)755-27521011 Http://www.sz-ctc.org.cn



For anti-fake verification, please visit the official website of Certification and Accreditation Administration of the People's Republic of China : [yz.cnca.cn](http://yz.cnca.cn)



Modulation Type: 8-DPSK

CH00

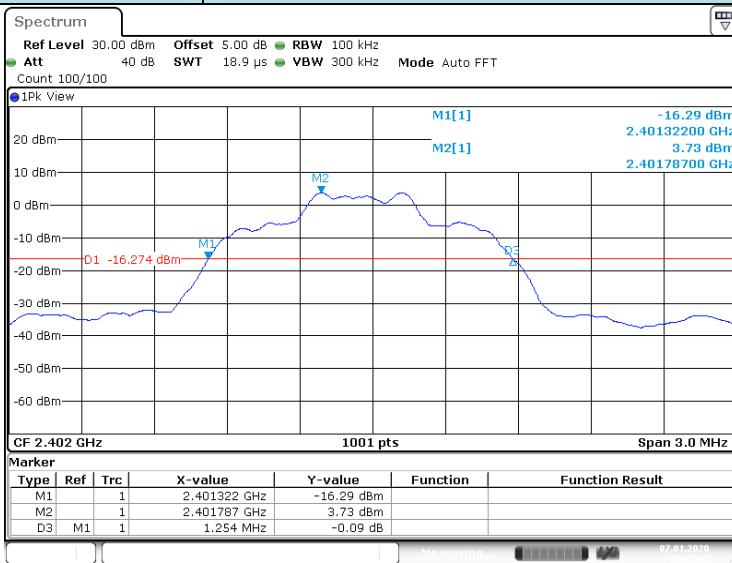

Date: 7.JAN.2020 10:13:42

CH39

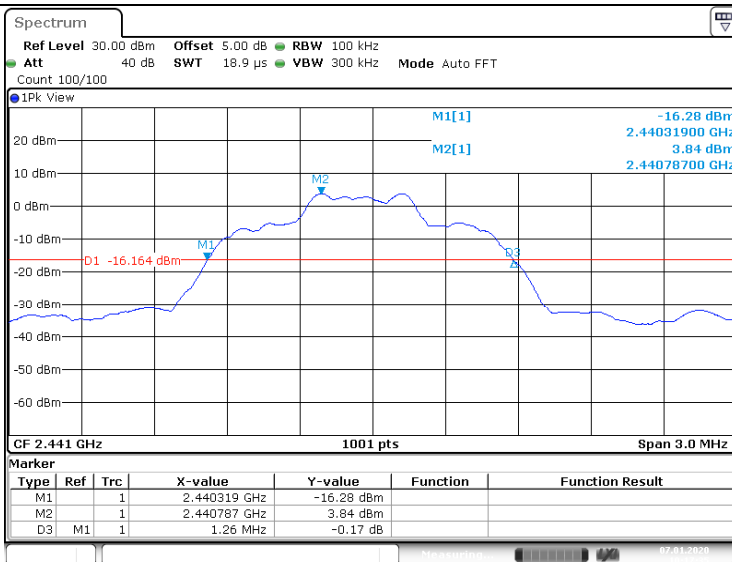

Date: 7.JAN.2020 10:17:35

CH78

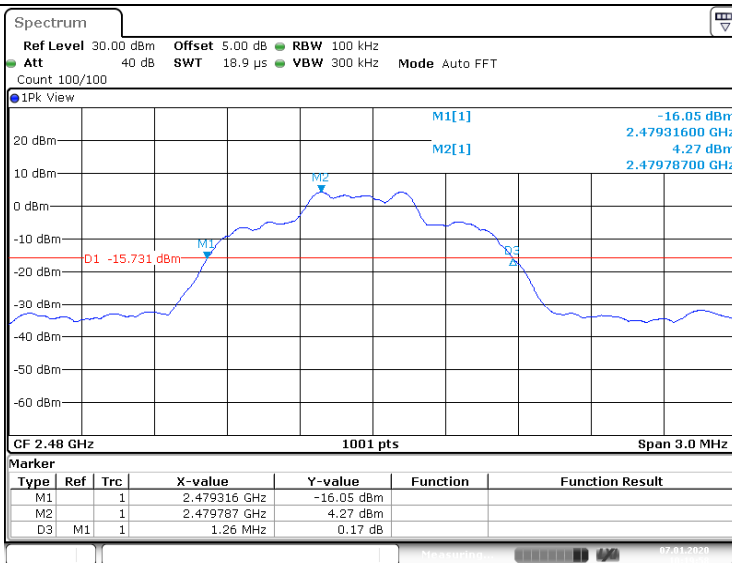

Date: 7.JAN.2020 10:19:58

CTC Laboratories, Inc.

2/F., Building 1 and 1-2/F., Building 2, Jiaquan Building, Guanlan High-Tech Park, Longhua District, Shenzhen, Guangdong, China  
Tel.: (86)755-27521059 Fax: (86)755-27521011 Http://www.sz-ctc.org.cn



For anti-fake verification, please visit the official website of Certification and Accreditation Administration of the People's Republic of China : [yz.cnca.cn](http://yz.cnca.cn)



99% Bandwidth

Modulation Type: GFSK

CH00

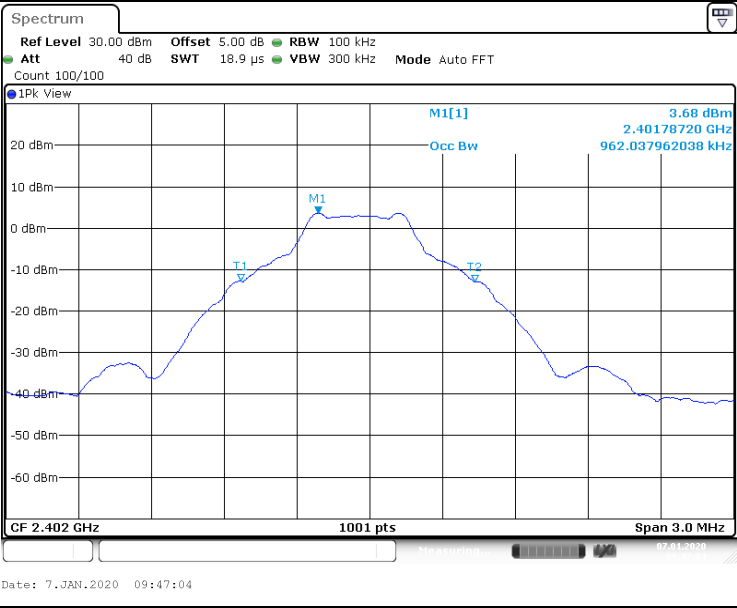

CH39

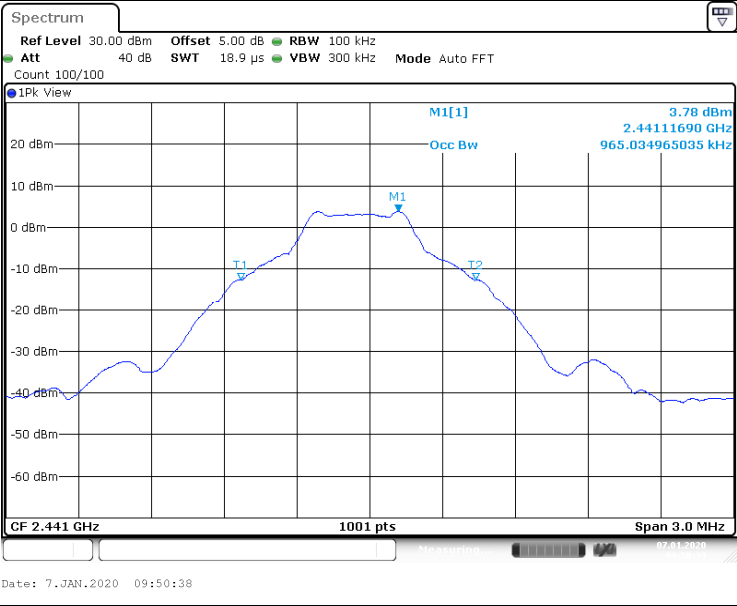

CH78

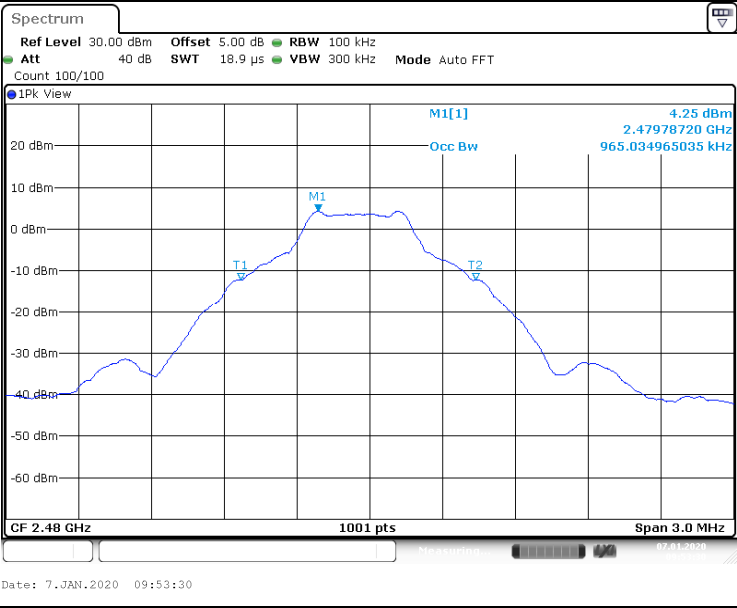

CTC Laboratories, Inc.

2/F., Building 1 and 1-2/F., Building 2, Jiaquan Building, Guanlan High-Tech Park, Longhua District, Shenzhen, Guangdong, China  
 Tel.: (86)755-27521059 Fax: (86)755-27521011 Http://www.sz-ctc.org.cn



For anti-fake verification, please visit the official website of Certification and Accreditation Administration of the People's Republic of China : [yz.cnca.cn](http://yz.cnca.cn)



Modulation Type:		$\pi/4$ -DQPSK
CH00	<p>Ref Level 30.00 dBm Offset 5.00 dB RBW 100 kHz Att 40 dB SWT 18.9 <math>\mu</math>s VBW 300 kHz Mode Auto FFT Count 100/100</p> <p>M1[1] 3.69 dBm 2.40211690 GHz 1.108891109 MHz</p> <p>CF 2.402 GHz 1001 pts Span 3.0 MHz</p> <p>Date: 7. JAN. 2020 10:02:58</p>	
CH39	<p>Ref Level 30.00 dBm Offset 5.00 dB RBW 100 kHz Att 40 dB SWT 18.9 <math>\mu</math>s VBW 300 kHz Mode Auto FFT Count 100/100</p> <p>M1[1] 3.71 dBm 2.44078720 GHz 1.114885115 MHz</p> <p>CF 2.441 GHz 1001 pts Span 3.0 MHz</p> <p>Date: 7. JAN. 2020 10:06:45</p>	
CH78	<p>Ref Level 30.00 dBm Offset 5.00 dB RBW 100 kHz Att 40 dB SWT 18.9 <math>\mu</math>s VBW 300 kHz Mode Auto FFT Count 100/100</p> <p>M1[1] 4.26 dBm 2.48011690 GHz 1.108891109 MHz</p> <p>CF 2.48 GHz 1001 pts Span 3.0 MHz</p> <p>Date: 7. JAN. 2020 10:10:04</p>	

CTC Laboratories, Inc.

2/F., Building 1 and 1-2/F., Building 2, Jiaquan Building, Guanlan High-Tech Park, Longhua District, Shenzhen, Guangdong, China  
Tel.: (86)755-27521059 Fax: (86)755-27521011 Http://www.sz-ctc.org.cn



For anti-fake verification, please visit the official website of Certification and Accreditation Administration of the People's Republic of China : [yz.cnca.cn](http://yz.cnca.cn)



Modulation Type: 8-DPSK	
CH00	<p>Ref Level 30.00 dBm Offset 5.00 dB RBW 100 kHz Att 40 dB SWT 18.9 μs VBW 300 kHz Mode Auto FFT Count 100/100</p> <p>3.69 dBm 2.40211690 GHz 1.117882118 MHz</p> <p>CF 2.402 GHz 1001 pts Span 3.0 MHz</p> <p>Date: 7. JAN. 2020 10:13:59</p>
CH39	<p>Ref Level 30.00 dBm Offset 5.00 dB RBW 100 kHz Att 40 dB SWT 18.9 μs VBW 300 kHz Mode Auto FFT Count 100/100</p> <p>3.80 dBm 2.44078720 GHz 1.117882118 MHz</p> <p>CF 2.441 GHz 1001 pts Span 3.0 MHz</p> <p>Date: 7. JAN. 2020 10:17:52</p>
CH78	<p>Ref Level 30.00 dBm Offset 5.00 dB RBW 100 kHz Att 40 dB SWT 18.9 μs VBW 300 kHz Mode Auto FFT Count 100/100</p> <p>4.27 dBm 2.47978720 GHz 1.120879121 MHz</p> <p>CF 2.48 GHz 1001 pts Span 3.0 MHz</p> <p>Date: 7. JAN. 2020 10:20:15</p>



### 3.5. Channel Separation

#### Limit

FCC CFR Title 47 Part 15 Subpart C Section 15.247 (a)(1)/ RSS-247 5.1 b :

Test Item	Limit	Frequency Range(MHz)
Channel Separation	>25KHz or >two-thirds of the 20 dB bandwidth Which is greater	2400~2483.5

#### Test Configuration

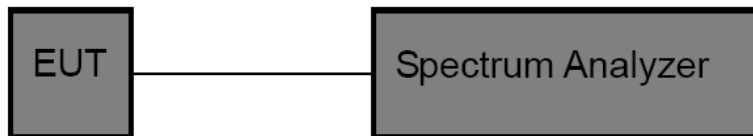

#### Test Procedure

3. The EUT was directly connected to the spectrum analyzer and antenna output port as show in the block diagram above.
4. Spectrum Setting:
  - (1) Set RBW = 100 kHz.
  - (2) Set the video bandwidth (VBW) ≥ 3 RBW.
  - (3) Detector = Peak.
  - (4) Trace mode = Max hold.
  - (5) Sweep = Auto couple.

#### Test Mode

Please refer to the clause 2.3.

**Test Results**

Modulation type	Channel	Carrier Frequencies Separation (MHz)	Limit (kHz)	Result
GFSK	00	1.003	744.00	Pass
	39	0.999	744.00	
	78	0.999	744.00	
$\pi/4$ -DQPSK	00	1.003	834.00	Pass
	39	0.999	838.00	
	78	0.999	836.00	
8-DPSK	00	1.003	836.00	Pass
	39	0.999	840.00	
	78	0.999	840.00	



Modulation Type: GFSK	
CH00	<p>Spectrum</p> <p>Ref Level 20.00 dBm Offset 5.00 dB RBW 100 kHz Att 35 dB SWT 19 <math>\mu</math>s VBW 300 kHz Mode Auto FFT</p> <p>1Pk View</p> <p>D1[1] -0.04 dB 1.00290 MHz 4.62 dBm 2.40178800 GHz</p> <p>M1</p> <p>Start 2.401 GHz 691 pts Stop 2.404 GHz</p> <p>Date: 7.JAN.2020 17:13:54</p>
CH39	<p>Spectrum</p> <p>Ref Level 20.00 dBm Offset 5.00 dB RBW 100 kHz Att 35 dB SWT 19 <math>\mu</math>s VBW 300 kHz Mode Auto FFT</p> <p>1Pk View</p> <p>D1[1] -0.01 dB 998.60 kHz 4.43 dBm 2.44078800 GHz</p> <p>M1</p> <p>Start 2.44 GHz 691 pts Stop 2.443 GHz</p> <p>Date: 7.JAN.2020 16:55:52</p>
CH78	<p>Spectrum</p> <p>Ref Level 20.00 dBm Offset 5.00 dB RBW 100 kHz Att 35 dB SWT 19 <math>\mu</math>s VBW 300 kHz Mode Auto FFT</p> <p>1Pk View</p> <p>D1[1] -0.02 dB 998.60 kHz 4.95 dBm 2.47878800 GHz</p> <p>M1</p> <p>Start 2.478 GHz 691 pts Stop 2.481 GHz</p> <p>Date: 7.JAN.2020 16:54:43</p>

CTC Laboratories, Inc.

2/F., Building 1 and 1-2/F., Building 2, Jiaquan Building, Guanlan High-Tech Park, Longhua District, Shenzhen, Guangdong, China  
Tel.: (86)755-27521059 Fax: (86)755-27521011 Http://www.sz-ctc.org.cn



For anti-fake verification, please visit the official website of Certification and Accreditation Administration of the People's Republic of China : [yz.cnca.cn](http://yz.cnca.cn)





Modulation Type:		$\pi/4$ -DQPSK
CH00		<p>Ref Level 20.00 dBm Offset 5.00 dB RBW 100 kHz Att 35 dB SWT 19 <math>\mu</math>s VBW 300 kHz Mode Auto FFT</p> <p>1Pk View</p> <p>M1</p> <p>D1[1]</p> <p>M1[1]</p> <p>D1</p> <p>-0.03 dB 1.00290 MHz 4.55 dBm 2.40178800 GHz</p> <p>Start 2.401 GHz 691 pts Stop 2.404 GHz</p> <p>Date: 7.JAN.2020 16:48:55</p>
CH39		<p>Ref Level 20.00 dBm Offset 5.00 dB RBW 100 kHz Att 35 dB SWT 19 <math>\mu</math>s VBW 300 kHz Mode Auto FFT</p> <p>1Pk View</p> <p>M1</p> <p>D1[1]</p> <p>M1[1]</p> <p>D1</p> <p>-0.01 dB 998.60 kHz 4.43 dBm 2.44078800 GHz</p> <p>Start 2.44 GHz 691 pts Stop 2.443 GHz</p> <p>Date: 7.JAN.2020 16:51:15</p>
CH78		<p>Ref Level 20.00 dBm Offset 5.00 dB RBW 100 kHz Att 35 dB SWT 19 <math>\mu</math>s VBW 300 kHz Mode Auto FFT</p> <p>1Pk View</p> <p>M1</p> <p>D1[1]</p> <p>M1[1]</p> <p>D1</p> <p>-0.02 dB 998.60 kHz 4.95 dBm 2.47878800 GHz</p> <p>Start 2.478 GHz 691 pts Stop 2.481 GHz</p> <p>Date: 7.JAN.2020 16:52:44</p>

CTC Laboratories, Inc.

2/F., Building 1 and 1-2/F., Building 2, Jiaquan Building, Guanlan High-Tech Park, Longhua District, Shenzhen, Guangdong, China  
Tel.: (86)755-27521059 Fax: (86)755-27521011 Http://www.sz-ctc.org.cn



For anti-fake verification, please visit the official website of Certification and Accreditation Administration of the People's Republic of China : [yz.cnca.cn](http://yz.cnca.cn)



Modulation Type: 8-DPSK

CH00

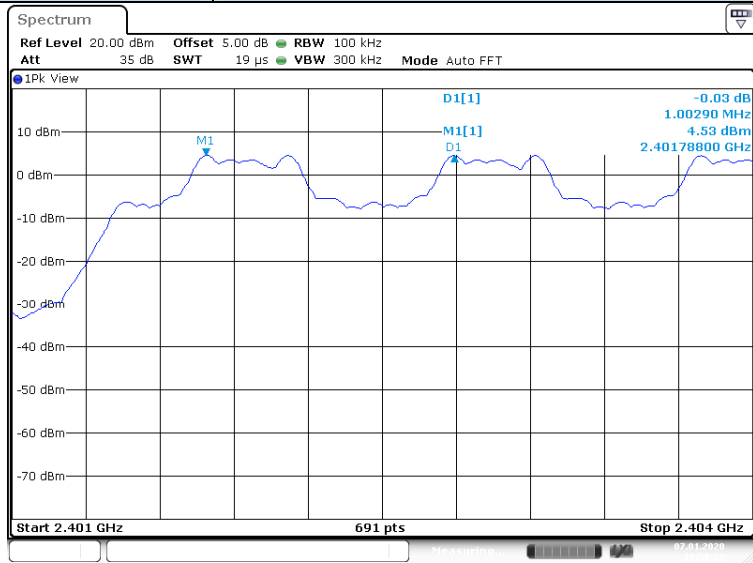

CH39

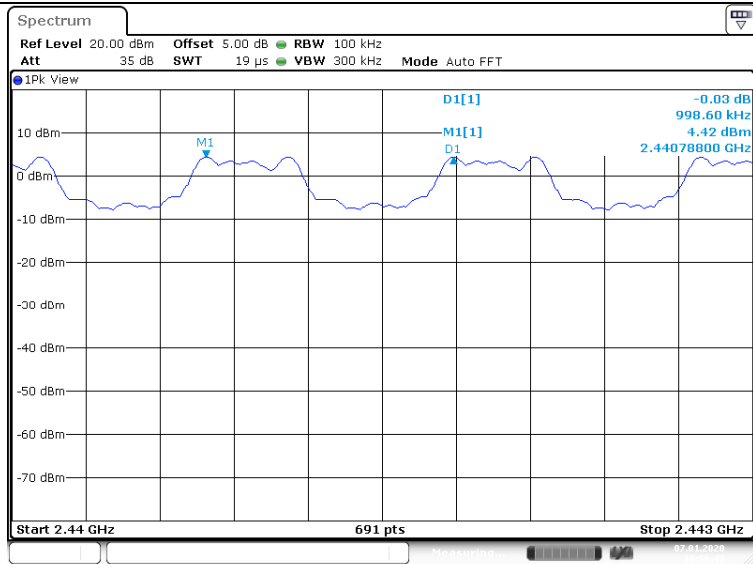

CH78

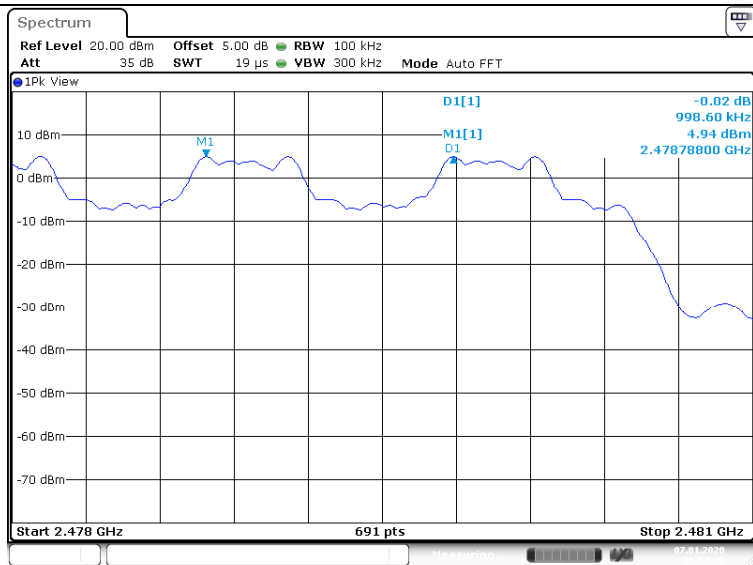

CTC Laboratories, Inc.

2/F., Building 1 and 1-2/F., Building 2, Jiaquan Building, Guanlan High-Tech Park, Longhua District, Shenzhen, Guangdong, China  
 Tel.: (86)755-27521059 Fax: (86)755-27521011 Http://www.sz-ctc.org.cn



For anti-fake verification, please visit the official website of Certification and Accreditation Administration of the People's Republic of China : [yz.cnca.cn](http://yz.cnca.cn)



### 3.6. Number of Hopping Channel

#### Limit

FCC CFR Title 47 Part 15 Subpart C Section 15.247 (a)(iii)/ RSS-247 5.1 d:

Section	Test Item	Limit
15.247 (a)(iii)/ RSS-247 5.1 d:	Number of Hopping Channel	>15

#### Test Configuration

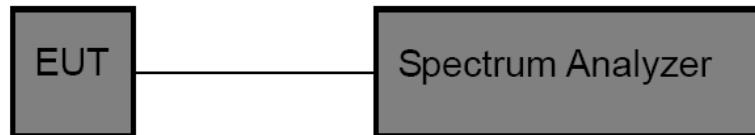

#### Test Procedure

- The EUT was directly connected to the spectrum analyzer and antenna output port as show in the block diagram above.
- Spectrum Setting:
  - Peak Detector: RBW=100 kHz, VBW≥RBW, Sweep time= Auto.

#### Test Mode

Please refer to the clause 2.3.

#### Test Result

Modulation type	Channel number	Limit	Result
GFSK	79	≥15.00	Pass
π/4-DQPSK	79		
8DPSK	79		



<p style="text-align: center;">GFSK</p>	
<p style="text-align: center;"><math>\pi/4</math>-DQPSK</p>	
<p style="text-align: center;">8-DPSK</p>	



### 3.7. Dwell Time

#### Limit

Section	Test Item	Limit
15.247(a)(iii)/ RSS-247 5.1 d	Average Time of Occupancy	0.4 sec

#### Test Configuration

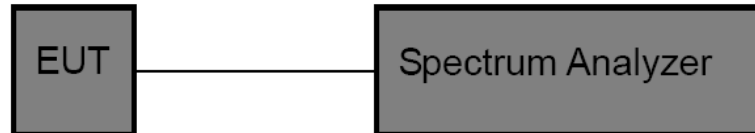

#### Test Procedure

1. The EUT was directly connected to the spectrum analyzer and antenna output port as show in the block diagram above.
2. Spectrum Setting:
  - (1) Spectrum Setting: RBW=1MHz, VBW≥RBW.
  - (2) Use video trigger with the trigger level set to enable triggering only on full pulses.
  - (3) Sweep Time is more than once pulse time.
  - (4) Set the center frequency on any frequency would be measure and set the frequency span to zero.
  - (5) Measure the maximum time duration of one single pulse.
  - (6) Set the EUT for packet transmitting.

#### Test Mode

Please refer to the clause 2.3.

**Test Result**

Modulation type	Channel	Channel (MHz)	Pulse Time (ms)	Total of Dwell (ms)	Period Time (ms)	Limit (Second)	Result
GFSK	DH1	2441	0.408	130.56	31.60	≤ 0.40	Pass
	DH3	2441	1.655	264.80	31.60		
	DH5	2441	2.903	309.65	31.60		
π/4-DQPSK	2DH1	2441	0.408	130.56	31.60	≤ 0.40	Pass
	2DH3	2441	1.653	264.48	31.60		
	2DH5	2441	2.899	309.23	31.60		
8-DPSK	3DH1	2441	0.409	130.88	31.60	≤ 0.40	Pass
	3DH3	2441	1.655	264.80	31.60		
	3DH5	2441	2.899	309.23	31.60		

Note: 1DH1/ 2DH1/3DH1 Total of Dwell= Pulse Time\*(1600/2)\*31.6/79

1DH3/2DH3/3DH3 Total of Dwell= Pulse Time\*(1600/4)\*31.6/79

1DH5/2DH5/3DH5 Total of Dwell= Pulse Time\*(1600/6)\*31.6/79



Modulation Type: GFSK	
DH1	<p>           Spectrum            Ref Level 30.00 dBm    RBW 1 MHz            Att 40 dB    SWT 10 ms    VBW 3 MHz            SGL TRG:VID            IAP Clrw            M1[1] -22.66 dBm            D2[1] -2.25 μs            TRG -4.100 dBm            CF 2.441 GHz    8000 pts    1.0 ms/pt            Date: 7.JAN.2020 10:32:56         </p>
DH3	<p>           Spectrum            Ref Level 30.00 dBm    RBW 1 MHz            Att 40 dB    SWT 20 ms    VBW 3 MHz            SGL TRG:VID            IAP Clrw            M1[1] -22.75 dBm            D2[1] -2.25 μs            TRG -8.400 dBm            CF 2.441 GHz    8000 pts    2.0 ms/pt            Date: 7.JAN.2020 10:33:28         </p>
DH5	<p>           Spectrum            Ref Level 30.00 dBm    RBW 1 MHz            Att 40 dB    SWT 30 ms    VBW 3 MHz            SGL TRG:VID            IAP Clrw            M1[1] -23.95 dBm            D2[1] -4.75 μs            TRG -8.300 dBm            CF 2.441 GHz    8000 pts    3.0 ms/pt            Date: 7.JAN.2020 10:32:11         </p>



Modulation Type:		$\pi/4$ -DQPSK
2DH1		<p> <b>Spectrum</b>            Ref Level 30.00 dBm            Att 40 dB RBW 1 MHz            SWT 10 ms VBW 3 MHz            SGL TRG:VID            IAP Clrw            M1[1] -23.72 dBm            D2[1] 15.74 dB            TRG -4.100 dBm            CF 2.441 GHz 8000 pts 1.0 ms/pt            Date: 7.JAN.2020 10:47:41         </p>
2DH3		<p> <b>Spectrum</b>            Ref Level 30.00 dBm            Att 40 dB RBW 1 MHz            SWT 20 ms VBW 3 MHz            SGL TRG:VID            IAP Clrw            M1[1] -24.34 dBm            D2[1] 16.98 dB            TRG -4.100 dBm            CF 2.441 GHz 8000 pts 2.0 ms/pt            Date: 7.JAN.2020 10:48:15         </p>
2DH5		<p> <b>Spectrum</b>            Ref Level 30.00 dBm            Att 40 dB RBW 1 MHz            SWT 30 ms VBW 3 MHz            SGL TRG:VID            IAP Clrw            M1[1] -22.95 dBm            D2[1] 15.56 dB            TRG -4.200 dBm            CF 2.441 GHz 8000 pts 3.0 ms/pt            Date: 7.JAN.2020 10:47:00         </p>





Modulation Type: 8-DPSK	
3DH1	<p>Date: 7.JAN.2020 11:06:44</p>
3DH3	<p>Date: 7.JAN.2020 11:07:19</p>
3DH5	<p>Date: 7.JAN.2020 11:06:06</p>



### 3.8. Peak Output Power

#### Limit

FCC CFR Title 47 Part 15 Subpart C Section 15.247 (b)(1) / RSS-247 5.4 b:

Test Item	Limit	Frequency Range(MHz)
Peak Output Power	Hopping Channels>75 Power<1W(30dBm) Other <125mW(21dBm)	2400~2483.5

#### Test Configuration

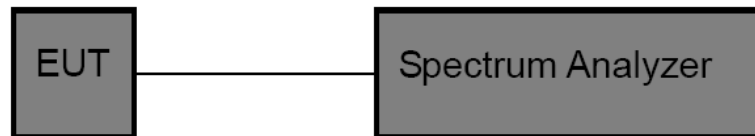

#### Test Procedure

- The EUT was directly connected to the spectrum analyzer and antenna output port as show in the block diagram above.
- Spectrum Setting:  
Peak Detector: RBW=1 MHz, VBW=3 MHz for bandwidth less than 1MHz.  
RBW=3 MHz, VBW=3 MHz for bandwidth more than 1MHz.

#### Test Mode

Please refer to the clause 2.3.

#### Test Result

Modulation type	Channel	Output power (dBm)	Limit (dBm)	Result
GFSK	00	3.75	≤ 30.00	Pass
	39	3.87		
	78	4.32		
π/4-DQPSK	00	3.74	≤ 21.00	Pass
	39	3.85		
	78	4.32		
8-DPSK	00	3.77	≤ 21.00	Pass
	39	3.86		
	78	4.31		



Modulation Type: GFSK	
CH00	<p>Ref Level 30.00 dBm   Offset 5.00 dB   RBW 1 MHz Att 40 dB   SWT 1.9 <math>\mu</math>s   VBW 3 MHz   Mode Auto FFT Count 100/100</p> <p>Peak: M1[1] 3.75 dBm @ 2.40178290 GHz</p> <p>CF 2.402 GHz   691 pts   Span 3.0 MHz</p> <p>Date: 7. JAN. 2020 09:49:21</p>
CH39	<p>Ref Level 30.00 dBm   Offset 5.00 dB   RBW 1 MHz Att 40 dB   SWT 1.9 <math>\mu</math>s   VBW 3 MHz   Mode Auto FFT Count 100/100</p> <p>Peak: M1[1] 3.87 dBm @ 2.44111290 GHz</p> <p>CF 2.441 GHz   691 pts   Span 3.0 MHz</p> <p>Date: 7. JAN. 2020 09:51:40</p>
CH78	<p>Ref Level 30.00 dBm   Offset 5.00 dB   RBW 1 MHz Att 40 dB   SWT 1.9 <math>\mu</math>s   VBW 3 MHz   Mode Auto FFT Count 100/100</p> <p>Peak: M1[1] 4.32 dBm @ 2.48012160 GHz</p> <p>CF 2.48 GHz   691 pts   Span 3.0 MHz</p> <p>Date: 7. JAN. 2020 09:55:47</p>

CTC Laboratories, Inc.

2/F., Building 1 and 1-2/F., Building 2, Jiaquan Building, Guanlan High-Tech Park, Longhua District, Shenzhen, Guangdong, China  
Tel.: (86)755-27521059   Fax: (86)755-27521011   Http://www.sz-ctc.org.cn



For anti-fake verification, please visit the official website of Certification and Accreditation Administration of the People's Republic of China : [yz.cnca.cn](http://yz.cnca.cn)



Modulation Type:		$\pi/4$ -DQPSK
CH00	<p>Date: 7.JAN.2020 10:05:14</p>	
CH39	<p>Date: 7.JAN.2020 10:07:46</p>	
CH78	<p>Date: 7.JAN.2020 10:12:20</p>	

CTC Laboratories, Inc.

2/F., Building 1 and 1-2/F., Building 2, Jiaquan Building, Guanlan High-Tech Park, Longhua District, Shenzhen, Guangdong, China  
Tel.: (86)755-27521059 Fax: (86)755-27521011 Http://www.sz-ctc.org.cn



For anti-fake verification, please visit the official website of Certification and Accreditation Administration of the People's Republic of China : [yz.cnca.cn](http://yz.cnca.cn)



Modulation Type: 8-DPSK	
CH00	<p>CF 2.402 GHz 691 pts Span 3.0 MHz</p> <p>Date: 7.JAN.2020 10:16:15</p>
CH39	<p>CF 2.441 GHz 691 pts Span 3.0 MHz</p> <p>Date: 7.JAN.2020 10:18:53</p>
CH78	<p>CF 2.48 GHz 691 pts Span 3.0 MHz</p> <p>Date: 7.JAN.2020 10:22:31</p>

CTC Laboratories, Inc.

2/F., Building 1 and 1-2/F., Building 2, Jiaquan Building, Guanlan High-Tech Park, Longhua District, Shenzhen, Guangdong, China  
Tel.: (86)755-27521059 Fax: (86)755-27521011 Http://www.sz-ctc.org.cn



For anti-fake verification, please visit the official website of Certification and Accreditation Administration of the People's Republic of China : [yz.cnca.cn](http://yz.cnca.cn)



### 3.9. Antenna requirement

#### Requirement

##### **FCC CFR Title 47 Part 15 Subpart C Section 15.203:**

An intentional radiator shall be designed to ensure that no antenna other than that furnished by the responsible party shall be used with the device. The use of a permanently attached antenna or of antenna that uses a unique coupling to the intentional radiator, the manufacturer may design the unit so that a broken antenna can be replaced by the user, but the use of a standard antenna jack or electrical connector is prohibited.

##### **FCC CFR Title 47 Part 15 Subpart C Section 15.247(c) (1)(i):**

(i) Systems operating in the 2400~2483.5 MHz band that is used exclusively for fixed. Point-to-point operations may employ transmitting antennas with directional gain greater than 6dBi provided the maximum conducted output power of the intentional radiator is reduced by 1 dB for every 3 dB that the directional gain of the antenna exceeds 6dBi.

#### Test Result

The directional gain of the antenna less than 6dBi, please refer to the EUT internal photographs antenna photo.