

FCC Radio Test Report

FCC ID: 2APPZ-I31S

This report concerns: Original Grant

Project No. : 1712C118A
Equipment : SIP DoorPhone
Test Model : i31S
Series Model : i23S, i18S
Applicant : Fanvil Technology Co.,LTD.
Address : 4F,Block A,Bldg#1,GaoXinQi Hi-TechPark
Phase-II,67th District,Bao'An Shenzhen China

Date of Receipt : Nov. 02, 2018
Date of Test : Nov. 02, 2018 ~ Jan. 30, 2019
Issued Date : Mar. 04, 2019
Tested by : BTL Inc.

Testing Engineer : Vincent Tan
(Vincent Tan)

Technical Manager : Steven Lu
(Steven Lu)

Authorized Signatory : Ethan Ma
(Ethan Ma)

B T L I N C .

No.3, Jinshagang 1st Road, Shixia, Dalang Town, Dongguan,
Guangdong, China.

TEL: +86-769-8318-3000 FAX: +86-769-8319-6000



Certificate #5123.02

Declaration

BTL represents to the client that testing is done in accordance with standard procedures as applicable and that test instruments used has been calibrated with standards traceable to international standard(s) and/or national standard(s).

BTL's reports apply only to the specific samples tested under conditions. It is manufacture's responsibility to ensure that additional production units of this model are manufactured with the identical electrical and mechanical components. **BTL** shall have no liability for any declarations, inferences or generalizations drawn by the client or others from **BTL** issued reports.

The report must not be used by the client to claim product certification, approval, or endorsement by NVLAP, NIST, A2LA, or any agency of the U.S. Government.

This report is the confidential property of the client. As a mutual protection to the clients, the public and ourselves, the test report shall not be reproduced, except in full, without our written approval.

BTL's laboratory quality assurance procedures are in compliance with the **ISO/IEC 17025** requirements, and accredited by the conformity assessment authorities listed in this test report.

BTL is not responsible for the sampling stage, so the results only apply to the sample as received.

The information, data and test plan are provided by manufacturer which may affect the validity of results, so it is manufacturer's responsibility to ensure that the apparatus meets the essential requirements of applied standards and in all the possible configurations as representative of its intended use.

Limitation

For the use of the authority's logo is limited unless the Test Standard(s)/Scope(s)/Item(s) mentioned in this test report is (are) included in the conformity assessment authorities acceptance respective.

Table of Contents**Page**

REPORT ISSUED HISTORY	5
1 . GENERAL SUMMARY	6
2 . SUMMARY OF TEST RESULTS	7
2.1 TEST FACILITY	8
2.2 MEASUREMENT UNCERTAINTY	8
3 . GENERAL INFORMATION	9
3.1 GENERAL DESCRIPTION OF EUT	9
3.2 DESCRIPTION OF TEST MODES	10
3.3 BLOCK DIAGRAM SHOWING THE CONFIGURATION OF SYSTEM TESTED	11
3.4 DESCRIPTION OF SUPPORT UNITS	11
4 . AC POWER LINE CONDUCTED EMISSIONS TEST	12
4.1 LIMIT	12
4.2 TEST PROCEDURE	12
4.3 DEVIATION FROM TEST STANDARD	12
4.4 TEST SETUP	13
4.5 EUT OPERATING CONDITIONS	13
4.6 EUT TEST CONDITIONS	13
4.7 TEST RESULTS	13
5 . RADIATED EMISSION TEST	14
5.1 LIMIT	14
5.2 TEST PROCEDURE	14
5.3 DEVIATION FROM TEST STANDARD	14
5.4 TEST SETUP	15
5.5 EUT OPERATING CONDITIONS	15
5.6 EUT TEST CONDITIONS	15
5.7 TEST RESULTS (9 KHZ TO 30 MHZ)	15
5.8 TEST RESULTS (30 MHZ TO 1000 MHZ)	15
6 . REQUENCY STABILITY	16
6.1 APPLIED PROCEDURES	16
6.2 TEST PROCEDURE	16
6.3 DEVIATION FROM STANDARD	16
6.4 TEST SETUP	16
6.5 EUT OPERATION CONDITIONS	17
6.6 EUT TEST CONDITIONS	17

Table of Contents

Page

6.7 TEST RESULTS	17
7 . MEASUREMENT INSTRUMENTS LIST	18
8 . EUT TEST PHOTO	19
APPENDIX A - AC POWER LINE CONDUCTED EMISSIONS	22
APPENDIX B - RADIATED EMISSION (9 KHZ TO 30 MHZ)	25
APPENDIX C - RADIATED EMISSION (30 MHZ TO 1000 MHZ)	32
APPENDIX D - FREQUENCY STABILITY	35

REPORT ISSUED HISTORY

Report Version	Description	Issued Date
R00	Original Issue.	Feb. 14, 2019
R01	Updated the Applicant which does not affect the test result.	Feb. 28, 2019
R02	Updated the TCB comments.	Mar. 04, 2019

1. GENERAL SUMMARY

Equipment : SIP DoorPhone
Brand Name : Fanvil
Test Model : i31S
Series Model : i23S, i18S
Applicant : Fanvil Technology Co.,LTD.
Manufacturer : Fanvil Technology Co.,LTD.
Address : 4F,Block A,Bldg#1,GaoXinQi Hi-TechPark Phase-II,67th District,Bao'An
Shenzhen China
Factory : Fanvil Technology Co.,LTD.
Address : 4F,Block A,Bldg#1,GaoXinQi Hi-TechPark Phase-II,67th District,Bao'An
Shenzhen China
Date of Test : Nov. 02, 2018 ~ Jan. 30, 2019
Test Sample : Engineering Sample No.: D181110502
Standard(s) : FCC Part 15, Subpart C: 15.225
ANSI C63.10-2013

The above equipment has been tested and found compliance with the requirement of the relative standards by BTL Inc.

The test data, data evaluation, and equipment configuration contained in our test report (Ref No. BTL-FCCP-1-1712C118A) were obtained utilizing the test procedures, test instruments, test sites that has been accredited by the Authority of A2LA according to the ISO/IEC 17025 quality assessment standard and technical standard(s).

2. SUMMARY OF TEST RESULTS

Test procedures according to the technical standard(s):

Applied Standard(s): FCC Part 15, Subpart C: 15.225			
Standard(s) Section	Test Item	Judgment	Remark
15.207	AC Power line conducted emissions	PASS	
15.225 (a) (b) (c) (d) and 15.209	Radiated Emissions	PASS	
15.203	Antenna Requirement	PASS	

2.1 TEST FACILITY

The test facilities used to collect the test data in this report is at the location of No.3,Jinshagang 1st Road, Shixia, Dalang Town, Dongguan, Guangdong, China.

BTL's Test Firm Registration Number for FCC: 357015

BTL's Designation Number for FCC: CN1240

2.2 MEASUREMENT UNCERTAINTY

ISO/IEC 17025 requires that an estimate of the measurement uncertainties associated with the emissions test results be included in the report. The measurement uncertainties given below are based on a 95% confidence level (based on a coverage factor (k=2)).

The BTL measurement uncertainty as below table:

A. AC Power Line Conducted Emissions:

Test Site	Method	Measurement Frequency Range	U, (dB)
DG-C02	CISPR	150 kHz ~ 30 MHz	2.32

B. Radiated Emissions:

Test Site	Method	Measurement Frequency Range	Ant. H / V	U, (dB)
DG-CB03	CISPR	9 KHz~30 MHz	V	3.79
		9 KHz~30 MHz	H	3.57
		30 MHz~200 MHz	V	3.82
		30 MH~200 MHz	H	3.78
		200 MHz~1,000 MHz	V	4.10
		200 MHz~1,000 MHz	H	4.06
		1 GHz~18 GHz	V	3.12
		1 GHz~18 GHz	H	3.68
		18 GHz~40 GHz	V	4.15
		18 GHz~40 GHz	H	4.14

Note: Unless specifically mentioned, the uncertainty of measurement has not been taken into account to declare the compliance or non-compliance to the specification.

3. GENERAL INFORMATION

3.1 GENERAL DESCRIPTION OF EUT

Equipment	SIP DoorPhone	
Brand Name	Fanvil	
Model Name	i31S	
Series Model	i23S, i18S	
Model Difference(s)	Model i31S is similar to model i23S and i18S except for model designation. The specific differences please refer to Note 2.	
Product Description	Operation Frequency	13.56 MHz
	Product Class	1
	Number of Channel	1
	Antenna Designation	Loop Antenna
	Field Strength	61.46 dBuV/m
Power Source	#1 supplied from battery (support unit). #2 Supplied from PoE adapter.	
Power Rating	#1 DC 12V #2 DC 48V	

Note:

1. For a more detailed features description, please refer to the manufacturer's specifications or the user's manual.

2.

Model	Camera module	Digital keyboard module	Induction module
i31S	Yes	Yes	Yes
i23S	No	Yes	Yes
i18S	Yes	No	No

3.2 DESCRIPTION OF TEST MODES

To investigate the maximum EMI emission characteristics generated from EUT, the test system was pre-scanning tested based on the consideration of following EUT operation mode or test configuration mode which possibly have effect on EMI emission level. Each of these EUT operation mode(s) or test configuration mode(s) mentioned above was evaluated respectively.

Pretest Test Mode	Description
Mode 1	TX Mode

AC Power Line Conducted Emissions Test	
Final Test Mode	Description
Mode 1	TX Mode

Radiated Emissions Test	
Final Test Mode	Description
Mode 1	TX Mode

3.3 BLOCK DIAGRAM SHOWING THE CONFIGURATION OF SYSTEM TESTED

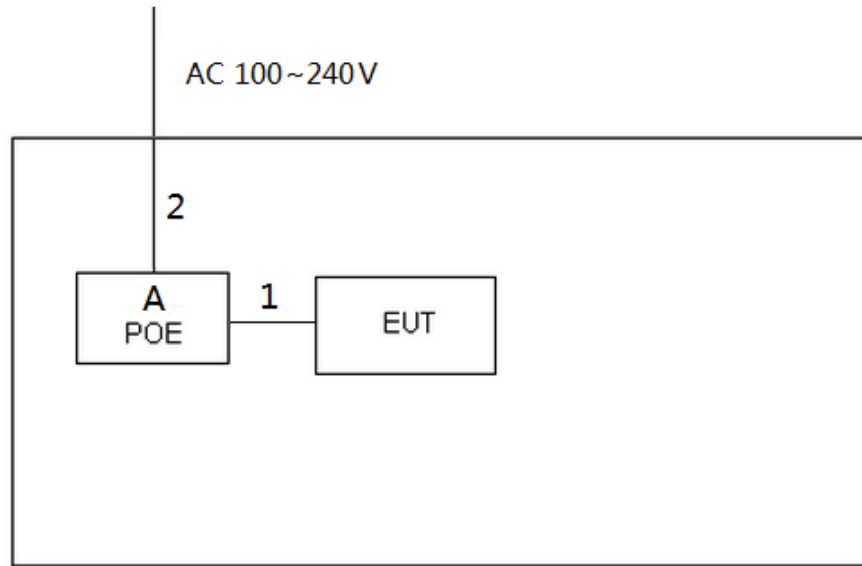

3.4 DESCRIPTION OF SUPPORT UNITS

The EUT has been tested as an independent unit together with other necessary accessories or support units. The following support units or accessories were used to form a representative test configuration during the tests.

Item	Equipment	Mfr/Brand	Model/Type No.	Series No.
A	POE Adapter	N/A	9501G	N/A

Item	Shielded Type	Ferrite Core	Length	Note
1	NO	NO	1m	RJ45 Cable
2	NO	NO	1.5m	DC Cable

Note:

- (1) The support equipment was authorized by Declaration of Conformity (DOC).

4. AC POWER LINE CONDUCTED EMISSIONS TEST

4.1 LIMIT

Frequency of Emission (MHz)	Conducted Limit (dB μ V)	
	Quasi-peak	Average
0.15 - 0.50	66 to 56*	56 to 46*
0.50 - 5.0	56	46
5.0 - 30.0	60	50

Note:

- (1) The limit of " * " decreases with the logarithm of the frequency
- (2) The test result calculated as following:
 Measurement Value = Reading Level + Correct Factor
 Correct Factor = Insertion Loss + Cable Loss + Attenuator Factor(if use)
 Margin Level = Measurement Value - Limit Value

The following table is the setting of the receiver

Receiver Parameters	Setting
Attenuation	10 dB
Start Frequency	0.15 MHz
Stop Frequency	30 MHz
IF Bandwidth	9 kHz

4.2 TEST PROCEDURE

- a. The EUT was placed 0.8 meters from the horizontal ground plane with EUT being connected to the power mains through a line impedance stabilization network (LISN). All other support equipment powered from additional LISN(s). The LISN provide 50 Ohm/ 50uH of coupling impedance for the measuring instrument.
- b. Interconnecting cables that hang closer than 40 cm to the ground plane shall be folded back and forth in the center forming a bundle 30 to 40 cm long.
- c. I/O cables that are not connected to a peripheral shall be bundled in the center. The end of the cable may be terminated, if required, using the correct terminating impedance. The overall length shall not exceed 1 m.
- d. LISN at least 80 cm from nearest part of EUT chassis.
- e. For the actual test configuration, please refer to the related Item -EUT Test Photos.

4.3 DEVIATION FROM TEST STANDARD

No deviation

4.4 TEST SETUP

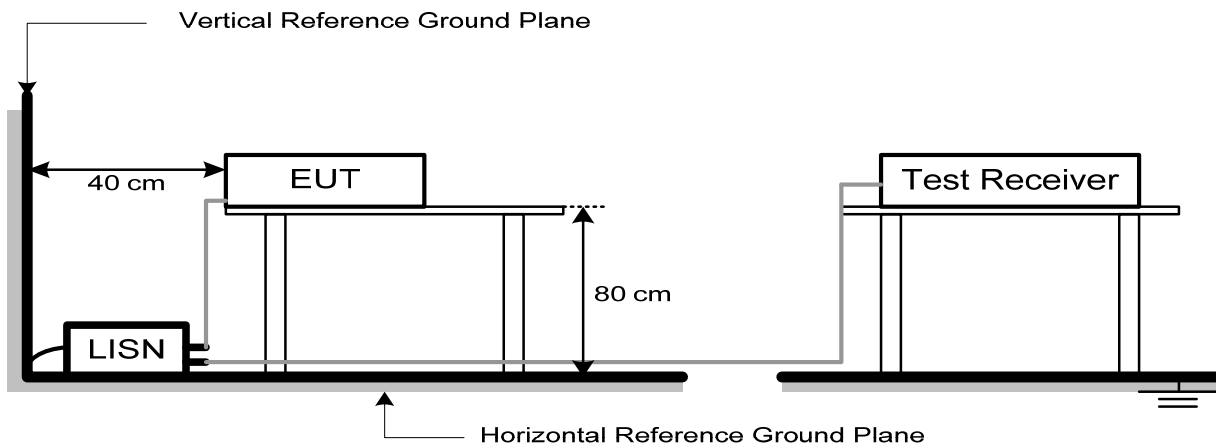

4.5 EUT OPERATING CONDITIONS

The EUT was placed on the test table and programmed in normal function.

4.6 EUT TEST CONDITIONS

Temperature: 24°C Relative Humidity: 50% Test Voltage: DC 12V

4.7 TEST RESULTS

Please refer to the Appendix A.

Remark:

- (1) All readings are QP Mode value unless otherwise stated AVG in column of 『Note』 . If the QP Mode Measured value compliance with the QP Limits and lower than AVG Limits, the EUT shall be deemed to meet both QP & AVG Limits and then only QP Mode was measured, but AVG Mode didn't perform in this case, a "*" marked in AVG Mode column of Interference Voltage Measured.
- (2) Measuring frequency range from 150 kHz to 30 MHz.

5. RADIATED EMISSION TEST

5.1 LIMIT

Clause 15.225(a) the field strength of any emissions within the band 13.553-13.567 MHz shall not exceed 15,848 microvolts/meter at 30 meters.

Clause 15.225(b) within the bands 13.410-13.553 MHz and 13.567-13.710 MHz, the field strength of any emissions shall not exceed 334 microvolts/meter at 30 meters.

Clause 15.225(c) within the bands 13.110-13.410 MHz and 13.710-14.010 MHz the field strength of any emissions shall not exceed 106 microvolts/meter at 30 meters.

Clause 15.225(d) The field strength of any emissions appearing outside of the 13.110-14.010 MHz band shall not exceed the general radiated emission limits in §15.209.

§15.209 (a) Except as provided elsewhere in this subpart, the emissions from an intentional radiator shall not exceed the field strength levels specified in the following table:

LIMITS OF RADIATED EMISSION MEASUREMENT (9 kHz-1000 MHz)

Frequency (MHz)	Field Strength (microvolts/meter)	Measurement Distance (meters)
0.009~0.490	2400/F(kHz)	300
0.490~1.705	24000/F(kHz)	30
1.705~30.0	30	30
30~88	100	3
88~216	150	3
216~960	200	3
960~1000	500	3

5.2 TEST PROCEDURE

The test set-up was made in accordance to the general provisions of ANSI C63.10-2013. The Equipment Under Test (EUT) was set up on a non-conductive table in the semi-anechoic chamber. The test was performed at the distance of 3 m between the EUT and the receiving antenna. The radiated emissions measurements were made in a typical installation configuration.

Sweep the whole frequency band through the range from 9 kHz to the 10th harmonic of the carrier, and the emissions less than 20 dB below the permissible value are reported.

During the test, below 30MHz, the center of the loop shall be 1 meters; above 30MHz, the height of receive antenna shall be moved from 1 to 4 meters, and the antenna shall be performed under horizontal and vertical polarization. The turntable shall be rotated from 0 to 360 degrees for detecting the maximum of radiated spurious signal level. The measurements shall be repeated with orthogonal polarization of the test antenna. The data of cable loss and antenna factor has been calibrated in full testing frequency range before the testing.

Set the spectrum analyzer in the following:

Below 1GHz (detector: Peak and Quasi-Peak)
RBW=100 kHz / VBW=300 kHz / Sweep=AUTO

The radiated emission was measured in the following position: EUT stand-up position (Z axis), lie-down position (X, Y axis). The worst emission was found in stand-up position (Z axis) and the worst case was recorded.

5.3 DEVIATION FROM TEST STANDARD

No deviation

5.4 TEST SETUP

(A) For Radiated Emissions 9 kHz-30 MHz

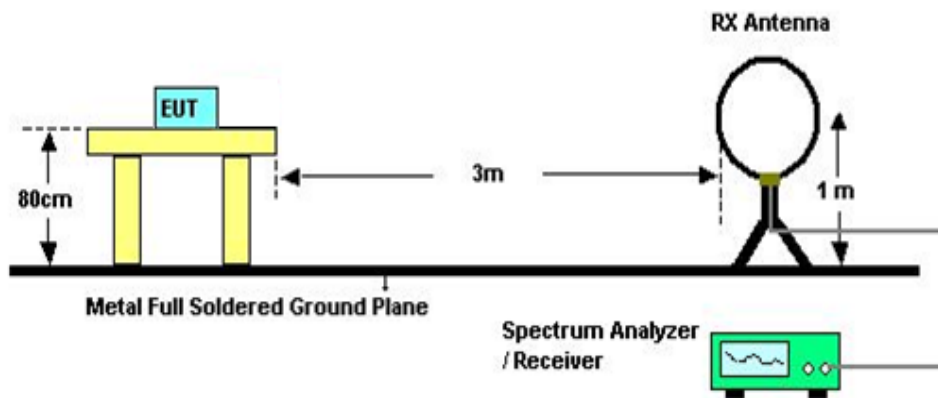

(B) Radiated Emission Test Set-Up Frequency 30 MHz-1000 MHz

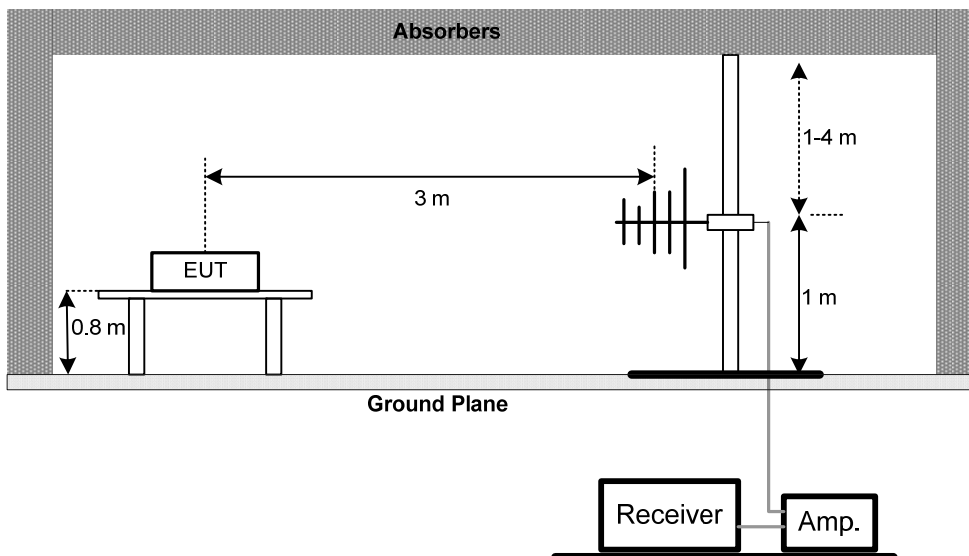

5.5 EUT OPERATING CONDITIONS

The EUT was programmed to be in continuously transmitting mode.

5.6 EUT TEST CONDITIONS

Temperature: 24°C Relative Humidity: 50% Test Voltage: DC 12V

5.7 TEST RESULTS (9 kHz TO 30 MHz)

Please refer to the Appendix B

5.8 TEST RESULTS (30 MHz TO 1000 MHz)

Please refer to the Appendix C.

Remark:

- (1) No limit: This is fundamental signal, the judgment is not applicable.
For fundamental signal judgment was referred to Peak output test.

6. REQUENCY STABILITY

6.1 APPLIED PROCEDURES

FCC Part15 Subpart C				
Section	Test Item	Frequency Range (MHz)	Lmint (MHz)	Result
15.225(e)	Frequency Stability Tolerance	13.56MHz	±0.001MHz	PASS

6.2 TEST PROCEDURE

1. Frequency Stability (Temperature Variation)

The temperature inside the climate chamber is varied from 0°C to +40°C in 10°C step size,

- (1) With all power removed, the temperature was decreased to 0°C and permitted to stabilize for three hours.
- (2) Measure the carrier frequency with the test equipment in a "call mode". These measurements should be made within 1 minute of powering up the mobile station, to prevent significant self warming.
- (3) Repeat the above measurements at 10°C increments from 0°C to +40°C. Allow at least 1.5 hours at each temperature, un-powered, before making measurements.

2. Frequency Stability (Voltage Variation)

The frequency stability shall be measured with variation of primary supply voltage as follows:

- (1) Vary primary supply voltage from 85 to 115 percent of the nominal value for other than hand carried battery equipment.
- (2) For hand carried, battery powered equipment, reduce primary supply voltage to the battery-operating end point which shall be specified by the manufacturer.

This transceiver is specified to operate with an input voltage of between 207 V AC and 253 V AC, with a nominal voltage of 230 V AC.

6.3 DEVIATION FROM STANDARD

No deviation.

6.4 TEST SETUP

Temperature And Humidity Box

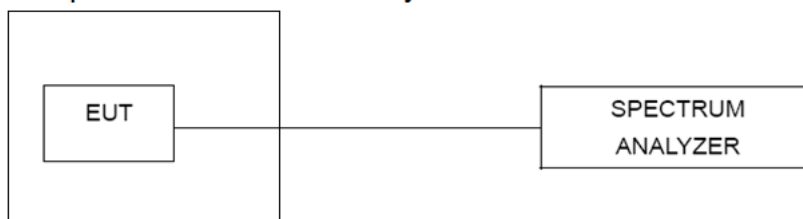

6.5 EUT OPERATION CONDITIONS

The EUT was programmed to be in continuously transmitting mode.

6.6 EUT TEST CONDITIONS

Temperature: 25°C Relative Humidity: 51% Test Voltage: DC 12V

6.7 TEST RESULTS

Please refer to the Appendix D.

7. MEASUREMENT INSTRUMENTS LIST

AC Power Line Conducted Emission Measurement					
Item	Kind of Equipment	Manufacturer	Type No.	Serial No.	Calibrated until
1	EMI Test Receiver	R&S	ESCI	100382	Mar. 11, 2019
2	LISN	EMCO	3816/2	52765	Mar. 11, 2019
3	50Ω Terminator	SHX	TF2-3G-A	8122901	Mar. 11, 2019
4	TWO-LINE V-NETWORK	R&S	ENV216	101447	Mar. 11, 2019
5	Measurement Software	Farad	EZ-EMC Ver.NB-03A1-01	N/A	N/A
6	Cable	N/A	RG223	12m	Mar. 23, 2019

Radiated Emission Measurement-9 kHz TO 30 MHz					
Item	Kind of Equipment	Manufacturer	Type No.	Serial No.	Calibrated until
1	Loop Antenna	EM	EM-6876-1	230	Feb. 07, 2019
2	Cable	N/A	RG 213/U	C-102	Jun. 01, 2019
3	EMI Test Receiver	R&S	ESCI	100382	Mar. 11, 2019
4	Measurement Software	Farad	EZ-EMC Ver.NB-03A1-01	N/A	N/A

Radiated Emission Measurement-30 MHz TO 1000 MHz					
Item	Kind of Equipment	Manufacturer	Type No.	Serial No.	Calibrated until
1	Antenna	Schwarbeck	VULB9160	9160-3232	Mar. 11, 2019
2	Amplifier	HP	8447D	2944A09673	Aug. 11, 2019
3	Receiver	Agilent	N9038A	MY52130039	Aug. 11, 2019
4	Cable	emci	LMR-400(30MHz-1 GHz)(8m+5m)	N/A	May 25, 2019
5	Controller	CT	SC100	N/A	N/A
6	Controller	MF	MF-7802	MF780208416	N/A
7	Measurement Software	Farad	EZ-EMC Ver.NB-03A1-01	N/A	N/A

Frequency Stability					
Item	Kind of Equipment	Manufacturer	Type No.	Serial No.	Calibrated until
1	Spectrum Analyzer	R&S	FSP40	100185	Aug. 11, 2019
2	Temperature And Humidity Box	Bell	BTH-50C	20170306001	Mar. 11, 2019

Remark: "N/A" denotes no model name, serial no. or calibration specified.
All calibration period of equipment list is one year.

8. EUT TEST PHOTO

AC Power Line Conducted Emissions Measurement Photos



Radiated Emissions Measurement Photos

9 kHz to 30 MHz

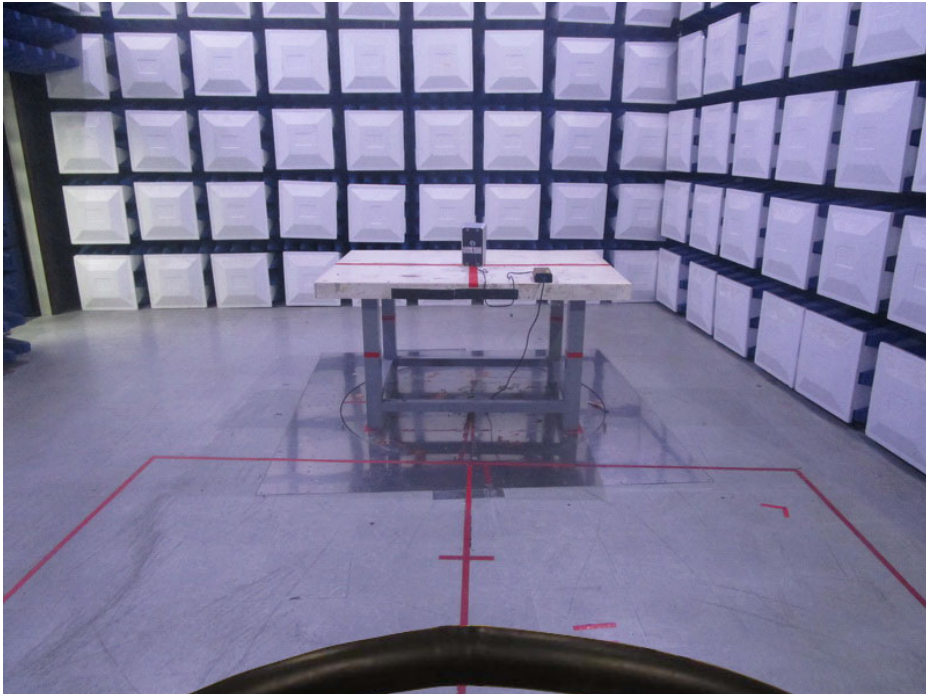
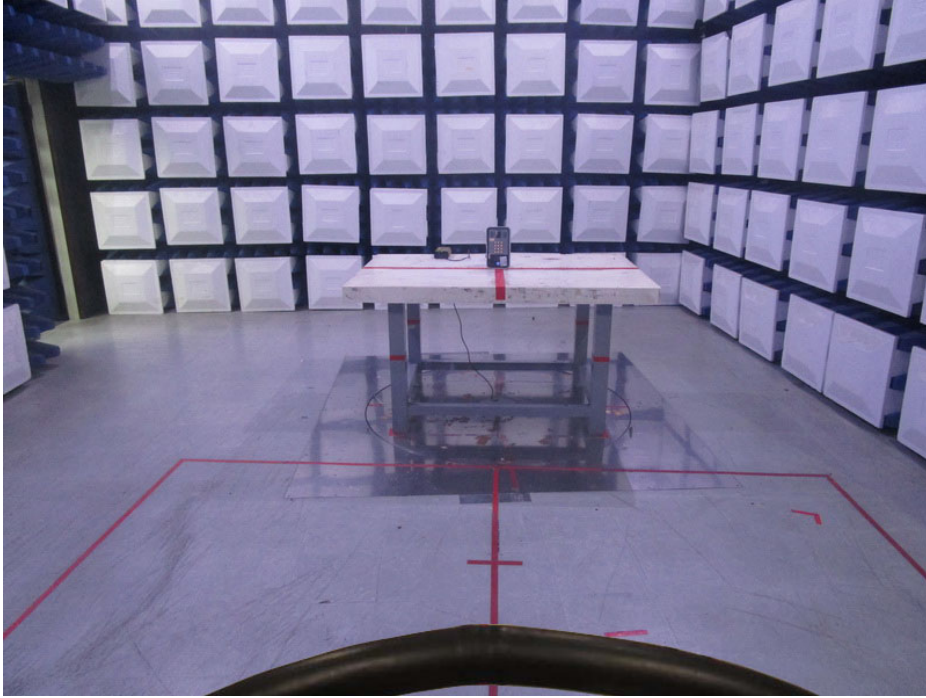

Radiated Emissions Measurement Photos

30 MHz to 1000 MHz

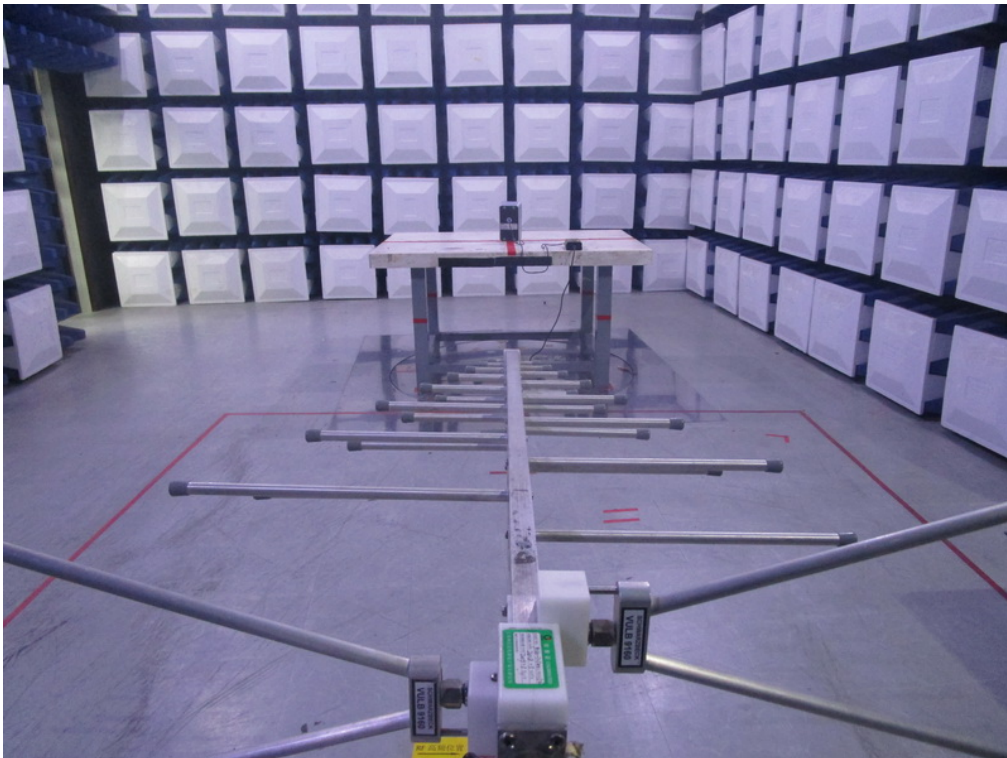

APPENDIX A - AC POWER LINE CONDUCTED EMISSIONS

Test Mode: TX Mode

Line

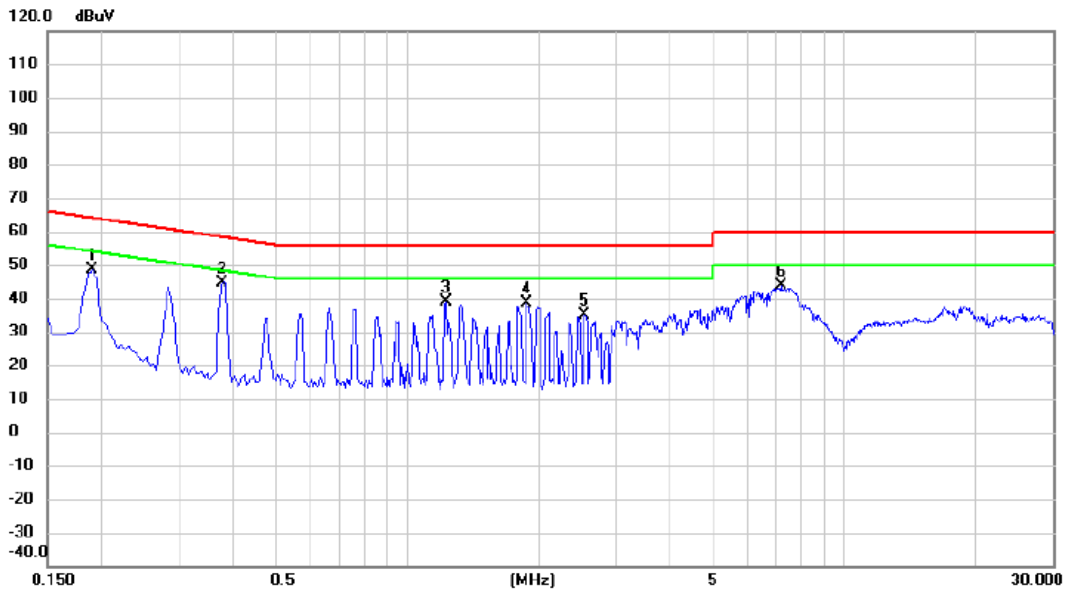

No.	Mk.	Freq. MHz	Reading Level dBuV	Correct Factor dB	Measure- ment dBuV	Limit dBuV	Margin dB	Detector	Comment
1		0.1905	38.79	9.82	48.61	64.01	-15.40	peak	
2	*	0.3771	34.80	9.81	44.61	58.34	-13.73	peak	
3		1.2300	29.20	9.94	39.14	56.00	-16.86	peak	
4		1.8780	28.44	9.99	38.43	56.00	-17.57	peak	
5		2.5485	25.12	10.02	35.14	56.00	-20.86	peak	
6		7.1700	33.39	10.33	43.72	60.00	-16.28	peak	

Test Mode: TX Mode

Neutral

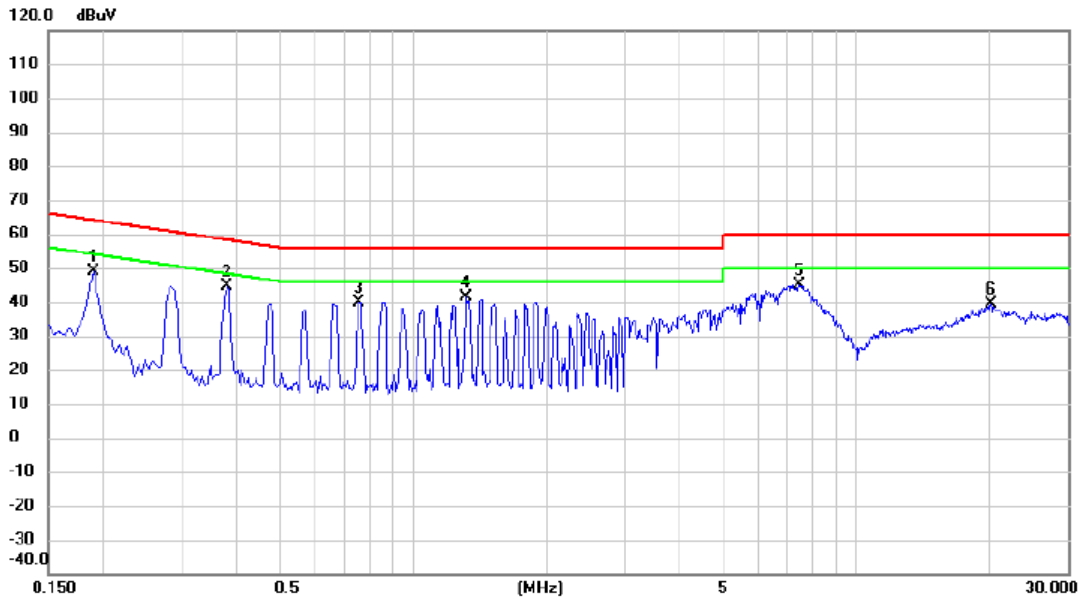

No.	Mk.	Freq. MHz	Reading Level dBuV	Correct Factor dB	Measure- ment dBuV	Limit dBuV	Margin dB	Detector	Comment
1		0.1905	38.92	9.91	48.83	64.01	-15.18	peak	
2	*	0.3795	34.68	9.95	44.63	58.29	-13.66	peak	
3		0.7530	29.87	10.07	39.94	56.00	-16.06	peak	
4		1.3200	31.25	10.14	41.39	56.00	-14.61	peak	
5		7.4355	34.41	10.61	45.02	60.00	-14.98	peak	
6		20.1030	27.86	11.48	39.34	60.00	-20.66	peak	

APPENDIX B - RADIATED EMISSION (9 KHZ TO 30 MHZ)

Test Mode: TX Mode

Ant 0°

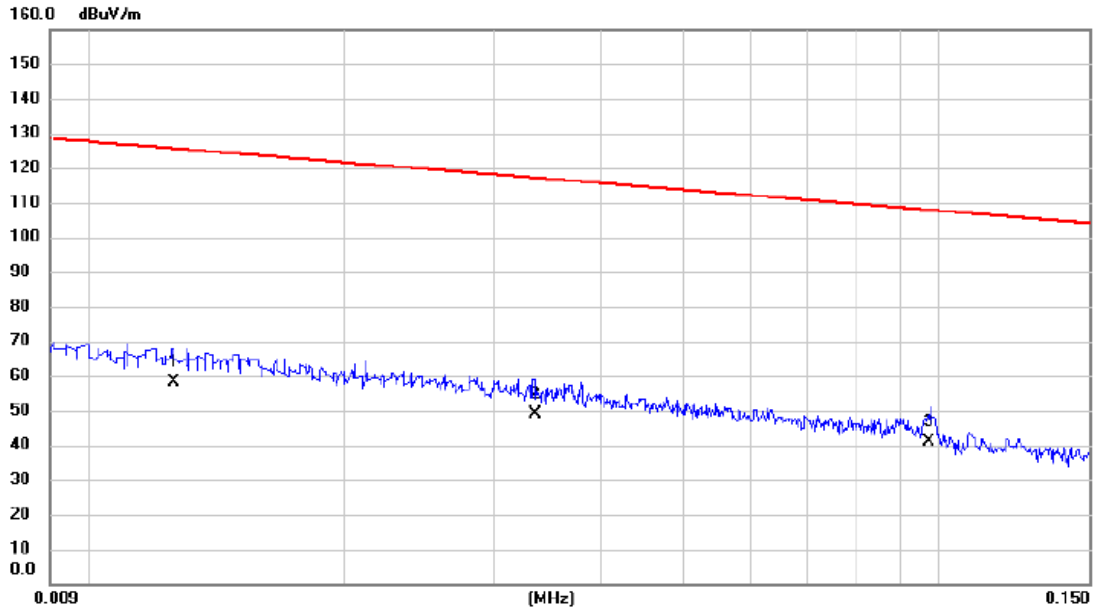

No.	Mk.	Freq. MHz	Reading Level dBuV	Correct Factor dB	Measure- ment dBuV/m	Limit dBuV/m	Margin dB	Detector	Comment
1		0.013	37.10	21.06	58.16	125.60	-67.44	AVG	
2		0.034	29.20	19.80	49.00	117.10	-68.10	AVG	
3	*	0.097	22.38	18.50	40.88	107.83	-66.95	AVG	

Test Mode: TX Mode

Ant 0°

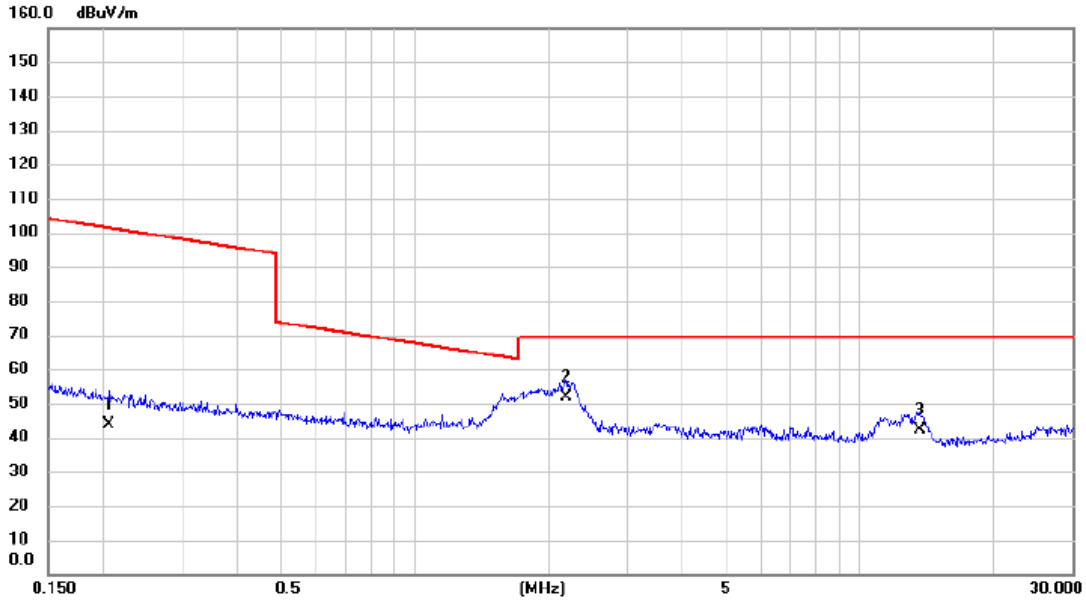

No.	Mk.	Freq. MHz	Reading Level dBuV	Correct Factor dB	Measure- ment dBuV/m	Limit dBuV/m	Margin dB	Detector	Comment
1		0.206	26.50	17.15	43.65	101.32	-57.67	AVG	
2	*	2.190	34.60	17.01	51.61	69.54	-17.93	QP	
3		13.623	27.60	14.65	42.25	69.54	-27.29	QP	

Test Mode: TX Mode

Ant 90°

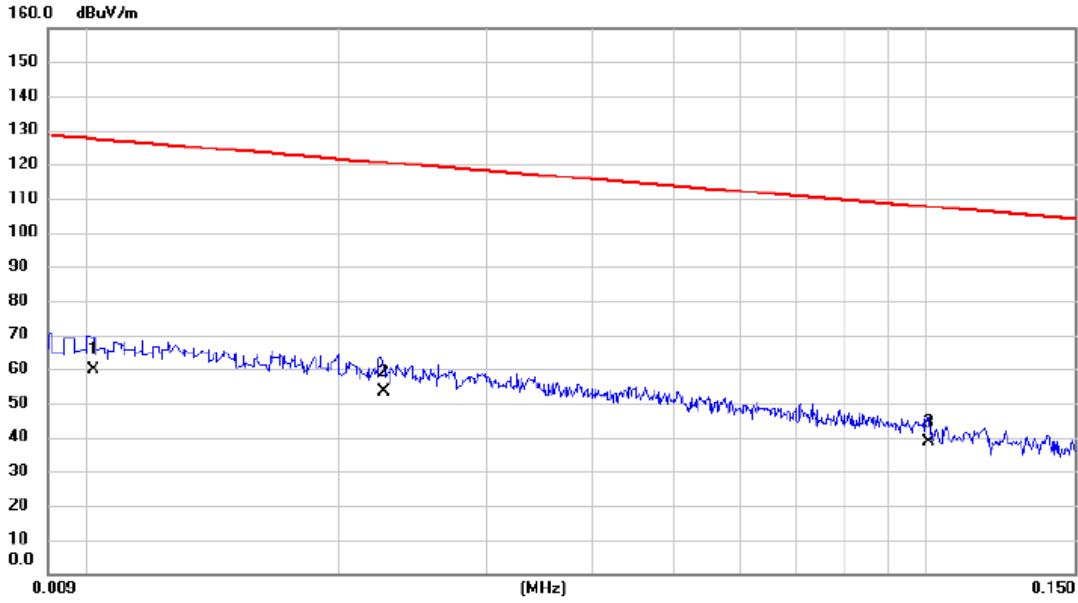

No.	Mk.	Freq. MHz	Reading Level dBuV	Correct Factor dB	Measure- ment dBuV/m	Limit dBuV/m	Margin dB	Detector	Comment
1		0.010	38.30	21.39	59.69	127.43	-67.74	AVG	
2	*	0.023	33.40	19.98	53.38	120.52	-67.14	AVG	
3		0.101	20.23	18.43	38.66	107.56	-68.90	AVG	

Test Mode: TX Mode

Ant 90°

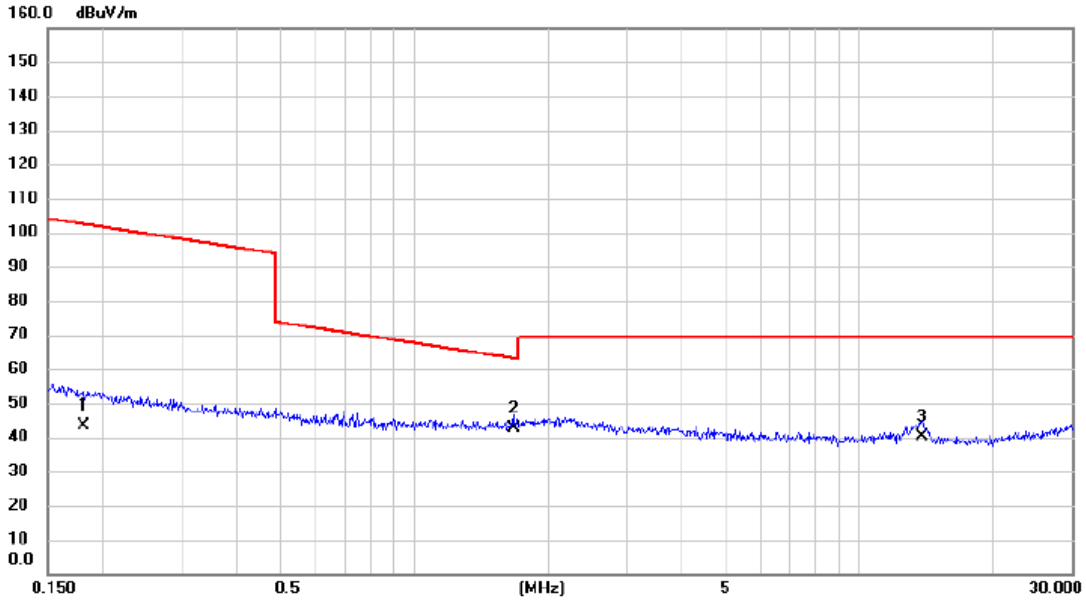

No.	Mk.	Freq. MHz	Reading Level dBuV	Correct Factor dB	Measure- ment dBuV/m	Limit dBuV/m	Margin dB	Detector	Comment
1		0.181	26.40	17.20	43.60	102.43	-58.83	AVG	
2	*	1.671	25.70	16.95	42.65	63.14	-20.49	QP	
3		13.841	25.50	14.67	40.17	69.54	-29.37	QP	

Test Mode: TX Mode

Ant 0°

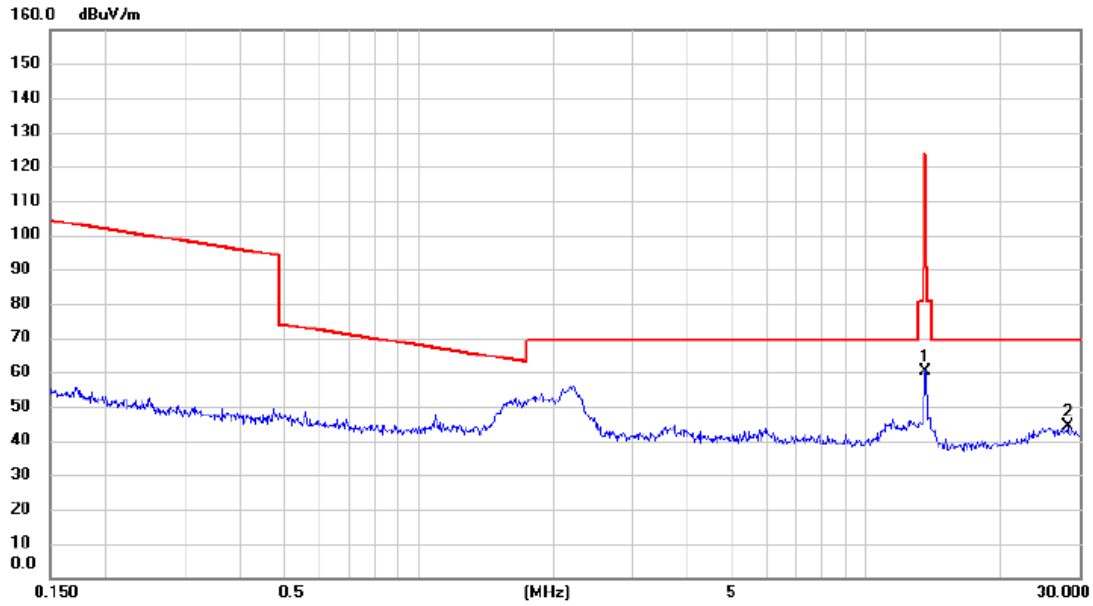

No.	Mk.	Freq. MHz	Reading Level dBuV	Correct Factor dB	Measure- ment dBuV/m	Limit dBuV/m	Margin dB	Detector	Comment
1		13.560	46.25	13.99	60.24	124.00	-63.76	peak	
2	*	28.152	23.72	20.57	44.29	69.50	-25.21	peak	

Test Mode: TX Mode

Ant 90°

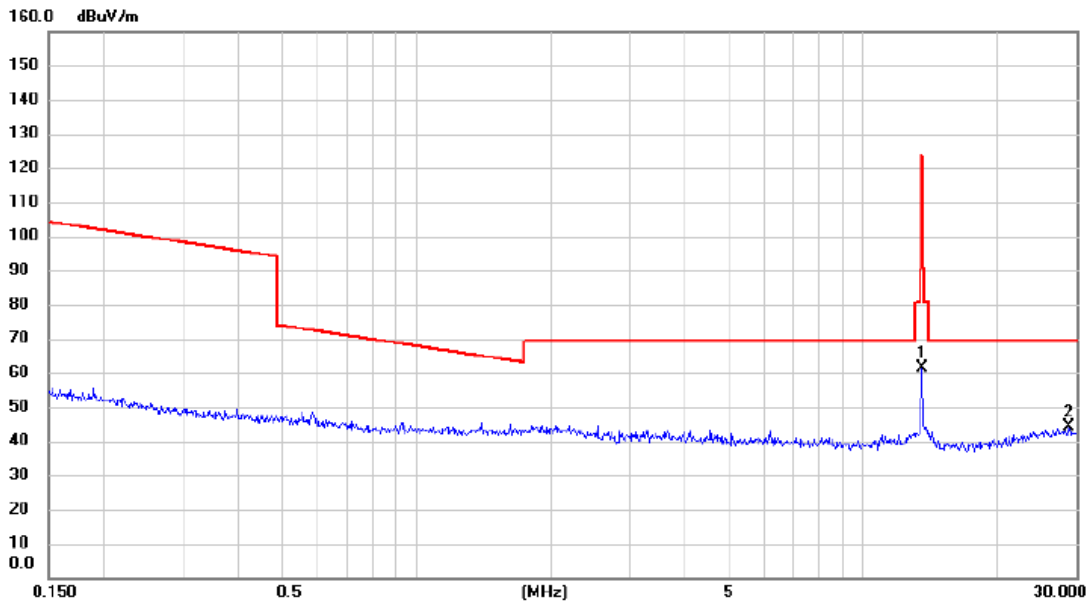

No.	Mk.	Freq. MHz	Reading Level dBuV	Correct Factor dB	Measure- ment dBuV/m	Limit dBuV/m	Margin dB	Detector	Comment
1		13.560	47.47	13.99	61.46	124.00	-62.54	peak	
2	*	28.755	23.58	20.73	44.31	69.50	-25.19	peak	

APPENDIX C - RADIATED EMISSION (30 MHZ TO 1000 MHZ)

Test Mode: TX Mode

Vertical

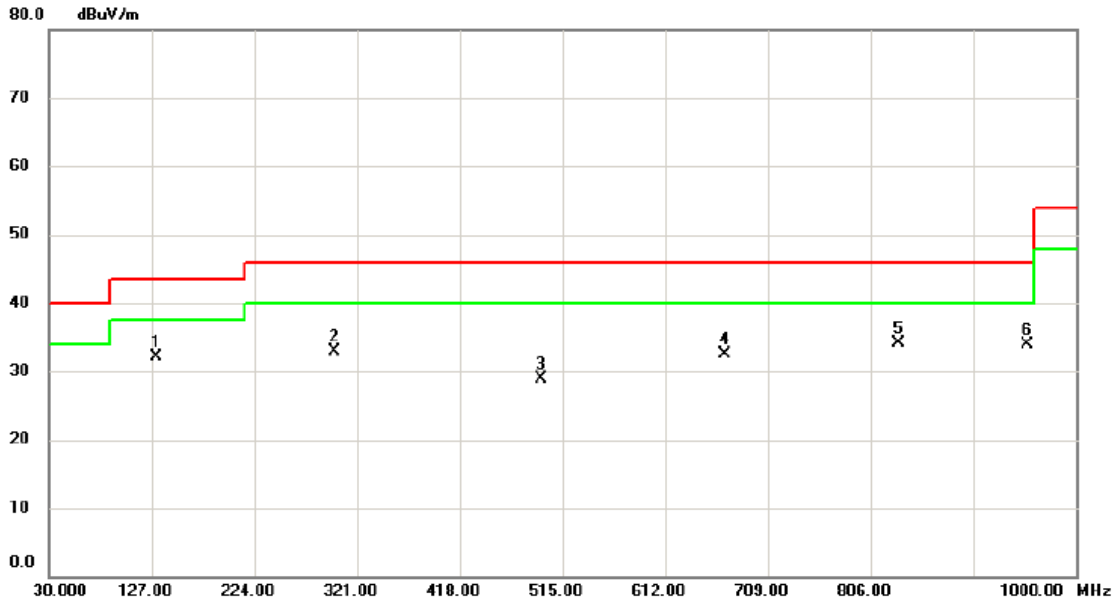

No.	Mk.	Freq. MHz	Reading Level dBuV	Correct Factor dB	Measure- ment dBuV/m	Limit dBuV/m	Margin dB	Detector	Comment
1	*	130.880	45.46	-13.27	32.19	43.50	-11.31	peak	
2		299.660	43.22	-10.39	32.83	46.00	-13.17	peak	
3		494.630	37.24	-8.40	28.84	46.00	-17.16	peak	
4		668.260	36.87	-4.29	32.58	46.00	-13.42	peak	
5		832.190	35.65	-1.54	34.11	46.00	-11.89	peak	
6		953.440	32.63	1.33	33.96	46.00	-12.04	peak	

Test Mode: TX Mode

Horizontal

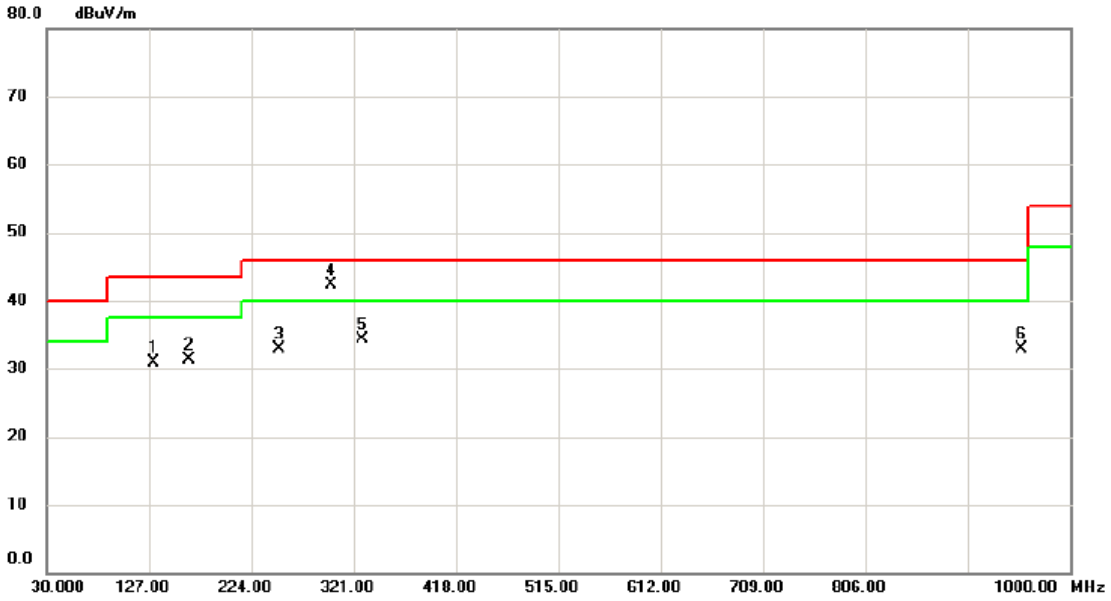

No.	Mk.	Freq. MHz	Reading Level dBuV	Correct Factor dB	Measure- ment dBuV/m	Limit dBuV/m	Margin dB	Detector	Comment
1		130.880	44.24	-13.27	30.97	43.50	-12.53	peak	
2		164.830	42.20	-10.90	31.30	43.50	-12.20	peak	
3		250.190	47.23	-14.28	32.95	46.00	-13.05	peak	
4	*	299.660	52.75	-10.39	42.36	46.00	-3.64	peak	
5		329.730	45.14	-10.80	34.34	46.00	-11.66	peak	
6		953.440	31.62	1.33	32.95	46.00	-13.05	peak	

APPENDIX D - FREQUENCY STABILITY

Test Mode:	TX Mode
------------	---------

Frequency Stability Versus Environmental Temperature						
	Temperature (°C)	Voltage (DC)	Frequency (MHz)	Frequency Error (kHz)	Limit (kHz)	Result
	25	12V	13.56			
0 min	50	12V	13.562	1.2	+/- 1.356	PASS
	-20	12V	13.561	1	+/- 1.356	PASS
2 min	50	12V	13.5611	1.1	+/- 1.356	PASS
	-20	12V	13.5606	0.6	+/- 1.356	PASS
5 min	50	12V	13.5612	1.2	+/- 1.356	PASS
	-20	12V	13.5596	-0.4	+/- 1.356	PASS
10 min	50	12V	13.5613	1.3	+/- 1.356	PASS
	-20	12V	13.5594	-0.6	+/- 1.356	PASS

Frequency Stability Versus Input Voltage						
Temperature (°C)	Voltage (AC)		Frequency (MHz)	Frequency Error (kHz)	Limit (kHz)	Result
25	V-nom	12V	13.56			
25	V-min	10.8V	13.5611	1.1	+/- 1.356	PASS
25	V-max	13.2V	13.5613	1.3	+/- 1.356	PASS

End of Test Report