

---

# FCC Test Report

---

Report No.: AGC14499230609FE04

**FCC ID** : 2APPZ-AP6221  
**APPLICATION PURPOSE** : Original Equipment  
**PRODUCT DESIGNATION** : IP Phone  
**BRAND NAME** : **Fanvil**  
**MODEL NAME** : X305  
**APPLICANT** : Fanvil Technology Co., Ltd.  
**DATE OF ISSUE** : Jul. 19, 2023  
**STANDARD(S)** : FCC Part 15 Subpart C §15.247  
**REPORT VERSION** : V1.0

Attestation of Global Compliance (Shenzhen) Co., Ltd



Any report having not been signed by authorized approver, or having been altered without authorization, or having not been stamped by the "Dedicated Testing/Inspection Stamp" is deemed to be invalid. Copying or excerpting portion of, or altering the content of the report is not permitted without the written authorization of AGC. The test results presented in the report apply only to the tested sample. Any objections to report issued by AGC should be submitted to AGC within 15days after the issuance of the test report. Further enquiry of validity or verification of the test report should be addressed to AGC by agc01@agccert.com.

Attestation of Global Compliance(Shenzhen)Co., Ltd  
Attestation of Global Compliance(Shenzhen)Std & Tech Co., Ltd  
Tel: +86-755 2523 4088 E-mail: agc@agccert.com Web: <http://www.agccert.com/>



### REPORT REVISE RECORD

Report Version	Revise Time	Issued Date	Valid Version	Notes
V1.0	/	Jul. 19, 2023	Valid	Initial Release

Any report having not been signed by authorized approver, or having been altered without authorization, or having not been stamped by the "Dedicated Testing/Inspection Stamp" is deemed to be invalid. Copying or excerpting portion of, or altering the content of the report is not permitted without the written authorization of AGC. The test results presented in the report apply only to the tested sample. Any objections to report issued by AGC should be submitted to AGC within 15days after the issuance of the test report. Further enquiry of validity or verification of the test report should be addressed to AGC by [agc01@agccert.com](mailto:agc01@agccert.com).

**TABLE OF CONTENTS**

**1. VERIFICATION OF CONFORMITY..... 5**

**2. GENERAL INFORMATION ..... 6**

    2.1. PRODUCT DESCRIPTION..... 6

    2.2. TABLE OF CARRIER FREQUENCYS ..... 7

    2.3. IEEE 802.11N MODULATION SCHEME ..... 8

    2.4. RELATED SUBMITTAL(S) / GRANT (S) ..... 9

    2.5. TEST METHODOLOGY..... 9

    2.6. SPECIAL ACCESSORIES ..... 9

    2.7. EQUIPMENT MODIFICATIONS ..... 9

    2.8. ANTENNA REQUIREMENT ..... 9

**3. MEASUREMENT UNCERTAINTY ..... 10**

**4. DESCRIPTION OF TEST MODES ..... 11**

**5. SYSTEM TEST CONFIGURATION ..... 12**

    5.1. CONFIGURATION OF EUT SYSTEM..... 12

    5.2. EQUIPMENT USED IN EUT SYSTEM..... 12

    5.3. SUMMARY OF TEST RESULTS ..... 12

**6. TEST FACILITY ..... 13**

**7. RF OUTPUT POWER MEASUREMENT..... 14**

    7.1 MEASUREMENT LIMITS ..... 14

    7.2 MEASUREMENT PROCEDURE ..... 14

    7.3 MEASUREMENT SETUP (BLOCK DIAGRAM OF CONFIGURATION)..... 14

    7.4 MEASUREMENT RESULT ..... 15

**8. 6DB BANDWIDTH MEASUREMENT ..... 16**

    8.1 MEASUREMENT LIMITS ..... 16

    8.2 MEASUREMENT PROCEDURE ..... 16

    8.3 MEASUREMENT SETUP (BLOCK DIAGRAM OF CONFIGURATION)..... 16

    8.4 MEASUREMENT RESULTS..... 17

**9. CONDUCTED SPURIOUS EMISSION..... 30**

    9.1 MEASUREMENT LIMIT ..... 30

    9.2 MEASUREMENT PROCEDURE ..... 30

    9.3 MEASUREMENT SETUP (BLOCK DIAGRAM OF CONFIGURATION)..... 30

    9.4 MEASUREMENT RESULTS..... 31

**10. POWER SPECTRAL DENSITY..... 45**

Any report having not been signed by authorized approver, or having been altered without authorization, or having not been stamped by the “Dedicated Testing/Inspection Stamp” is deemed to be invalid. Copying or excerpting portion of, or altering the content of the report is not permitted without the written authorization of AGC. The test results presented in the report apply only to the tested sample. Any objections to report issued by AGC should be submitted to AGC within 15days after the issuance of the test report. Further enquiry of validity or verification of the test report should be addressed to AGC by agc01@agccert.com.

10.1 MEASUREMENT LIMITS .....	45
10.2 MEASUREMENT PROCEDURE .....	45
10.3 MEASUREMENT SETUP (BLOCK DIAGRAM OF CONFIGURATION) .....	46
10.4 MEASUREMENT RESULT .....	46
<b>11. RADIATED EMISSION .....</b>	<b>53</b>
11.1 MEASUREMENT LIMITS.....	53
11.2 MEASUREMENT PROCEDURE .....	53
11.3 MEASUREMENT SETUP (BLOCK DIAGRAM OF CONFIGURATION) .....	55
11.4 MEASUREMENT RESULT .....	56
<b>12. LINE CONDUCTED EMISSION TEST .....</b>	<b>82</b>
12.1. LIMITS OF LINE CONDUCTED EMISSION TEST .....	82
12.2. BLOCK DIAGRAM OF LINE CONDUCTED EMISSION TEST .....	82
12.3. PRELIMINARY PROCEDURE OF LINE CONDUCTED EMISSION TEST .....	83
12.4. FINAL PROCEDURE OF LINE CONDUCTED EMISSION TEST .....	83
12.5. TEST RESULT OF LINE CONDUCTED EMISSION TEST .....	83
<b>APPENDIX I: PHOTOGRAPHS OF TEST SETUP .....</b>	<b>88</b>
<b>APPENDIX II: PHOTOGRAPHS OF EUT .....</b>	<b>88</b>



Any report having not been signed by authorized approver, or having been altered without authorization, or having not been stamped by the “Dedicated Testing/Inspection Stamp” is deemed to be invalid. Copying or excerpting portion of, or altering the content of the report is not permitted without the written authorization of AGC. The test results presented in the report apply only to the tested sample. Any objections to report issued by AGC should be submitted to AGC within 15days after the issuance of the test report. Further enquiry of validity or verification of the test report should be addressed to AGC by agc01@agccert.com.

### 1. VERIFICATION OF CONFORMITY

<b>Applicant</b>	Fanvil Technology Co., Ltd.
<b>Address</b>	10/F Block A, Dualshine Global Science Innovation, Honglang North 2nd Road, Bao'an District, Shenzhen, China
<b>manufacturer</b>	Fanvil Technology Co., Ltd.
<b>Address</b>	10/F Block A, Dualshine Global Science Innovation, Honglang North 2nd Road, Bao'an District, Shenzhen, China
<b>Factory</b>	Fanvil Technology Co., Ltd.
<b>Address</b>	10/F Block A, Dualshine Global Science Innovation, Honglang North 2nd Road, Bao'an District, Shenzhen, China
<b>Product Designation</b>	IP Phone
<b>Brand Name</b>	
<b>Test Model</b>	X305
<b>Date of receipt of test item</b>	Jun. 30, 2023
<b>Date of test</b>	Jun. 30, 2023~Jul. 19, 2023
<b>Deviation</b>	No any deviation from the test method
<b>Condition of Test Sample</b>	Normal
<b>Test Result</b>	Pass
<b>Report Template</b>	AGCRT-US-BGN/RF

We hereby certify that:

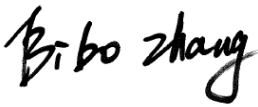
The above equipment was tested by Attestation of Global Compliance (Shenzhen) Co., Ltd. The test data, data evaluation, test procedures, and equipment configurations shown in this report were made in accordance with the procedures given in ANSI C63.10 (2013) and the energy emitted by the sample EUT tested as described in this report is in compliance with radiated emission limits of FCC Rules Part 15.247.

Prepared By	 <hr/> Bibo Zhang (Project Engineer)	Jul. 19, 2023
Reviewed By	 <hr/> Calvin Liu (Reviewer)	Jul. 19, 2023
Approved By	 <hr/> Max Zhang Authorized Officer	Jul. 19, 2023

Any report having not been signed by authorized approver, or having been altered without authorization, or having not been stamped by the "Dedicated Testing/Inspection Stamp" is deemed to be invalid. Copying or excerpting portion of, or altering the content of the report is not permitted without the written authorization of AGC. The test results presented in the report apply only to the tested sample. Any objections to report issued by AGC should be submitted to AGC within 15days after the issuance of the test report. Further enquiry of validity or verification of the test report should be addressed to AGC by agc01@agccert.com.

## 2. GENERAL INFORMATION

### 2.1. PRODUCT DESCRIPTION

<b>Equipment Type</b>	WLAN 2.4G
<b>Frequency Band</b>	2400MHz ~ 2483.5MHz
<b>Operation Frequency</b>	2412MHz ~ 2462MHz
<b>Output Power (Average)</b>	IEEE 802.11b:12.14dBm; IEEE 802.11g:11.48dBm; IEEE 802.11n(HT20):11.57dBm; IEEE 802.11n(HT40):11.95dBm
<b>Output Power (Peak)</b>	IEEE 802.11b:14.97dBm; IEEE 802.11g:18.92dBm; IEEE 802.11n(HT20):18.95dBm; IEEE 802.11n(HT40):19.13dBm
<b>Modulation</b>	802.11b:(DQPSK, DBPSK,CCK)DSSS 802.11g/n:(64-QAM,16-QAM,QPSK, BPSK)OFDM
<b>Data Rate</b>	802.11b:1/2/5.5/11Mbps 802.11g: 6/9/12/18/24/36/48/54Mbps 802.11n: up to 300Mbps
<b>Number of channels</b>	11
<b>Hardware Version</b>	V1.0
<b>Software Version</b>	T2.12.0.11
<b>Antenna Designation</b>	PIFA antenna (Comply with requirements of the FCC part 15.203)
<b>Antenna Gain</b>	4.2dBi
<b>Power Supply</b>	DC 5V by adapter or DC 48V by PoE

Any report having not been signed by authorized approver, or having been altered without authorization, or having not been stamped by the "Dedicated Testing/Inspection Stamp" is deemed to be invalid. Copying or excerpting portion of, or altering the content of the report is not permitted without the written authorization of AGC. The test results presented in the report apply only to the tested sample. Any objections to report issued by AGC should be submitted to AGC within 15days after the issuance of the test report. Further enquiry of validity or verification of the test report should be addressed to AGC by agc01@agccert.com.

**2.2. TABLE OF CARRIER FREQUENCIES**

**For 2412-2462MHz:**

**11 channels are provided for 802.11b/g/n(HT20):**

Channel	Frequency	Channel	Frequency	Channel	Frequency
01	2412 MHz	02	2417 MHz	03	2422 MHz
04	2427 MHz	05	2432 MHz	06	2437 MHz
07	2442 MHz	08	2447 MHz	09	2452 MHz
10	2457 MHz	11	2462 MHz		

**7 channels are provided for 802.11n(HT40):**

Channel	Frequency	Channel	Frequency	Channel	Frequency
01	--	02	--	03	2422 MHz
04	2427 MHz	05	2432 MHz	06	2437 MHz
07	2442 MHz	08	2447 MHz	09	2452 MHz
10	--	11	--		

Any report having not been signed by authorized approver, or having been altered without authorization, or having not been stamped by the "Dedicated Testing/Inspection Stamp" is deemed to be invalid. Copying or excerpting portion of, or altering the content of the report is not permitted without the written authorization of AGC. The test results presented in the report apply only to the tested sample. Any objections to report issued by AGC should be submitted to AGC within 15days after the issuance of the test report. Further enquiry of validity or verification of the test report should be addressed to AGC by agc01@agccert.com.

### 2.3. IEEE 802.11N MODULATION SCHEME

MCS Index	Nss	Modulation	R	NBPS	NCBPS		NDBPS		Data rate(Mbps)			
					800nsGI		20MHz	40MHz	20MHz	40MHz	20MHz	40MHz
					20MHz	40MHz						
0	1	BPSK	1/2	1	52	108	26	54	6.5	13.5		
1	1	QPSK	1/2	2	104	216	52	108	13.0	27.0		
2	1	QPSK	3/4	2	104	216	78	162	19.5	40.5		
3	1	16-QAM	1/2	4	208	432	104	216	26.0	54.0		
4	1	16-QAM	3/4	4	208	432	156	324	39.0	81.0		
5	1	64-QAM	2/3	6	312	648	208	432	52.0	108.0		
6	1	64-QAM	3/4	6	312	648	234	489	58.5	121.5		
7	1	64-QAM	5/6	6	312	648	260	540	65.0	135.0		

Symbol	Explanation
NSS	Number of spatial streams
R	Code rate
NBPS	Number of coded bits per single carrier
NCBPS	Number of coded bits per symbol
NDBPS	Number of data bits per symbol
GI	Guard interval

Any report having not been signed by authorized approver, or having been altered without authorization, or having not been stamped by the "Dedicated Testing/Inspection Stamp" is deemed to be invalid. Copying or excerpting portion of, or altering the content of the report is not permitted without the written authorization of AGC. The test results presented in the report apply only to the tested sample. Any objections to report issued by AGC should be submitted to AGC within 15days after the issuance of the test report. Further enquiry of validity or verification of the test report should be addressed to AGC by agc01@agccert.com.



## 2.4. RELATED SUBMITTAL(S) / GRANT (S)

This submittal(s) (test report) is intended for **FCC ID: 2APPZ-AP6221** filing to comply with the FCC Part 15 requirements.

## 2.5. TEST METHODOLOGY

The tests were performed according to following standards:

No.	Identity	Document Title
1	FCC 47 CFR Part 2	Frequency allocations and radio treaty matters; general rules and regulations
2	FCC 47 CFR Part 15	Radio Frequency Devices
3	ANSI C63.10-2013	American National Standard for Testing Unlicensed Wireless Devices

## 2.6. SPECIAL ACCESSORIES

Refer to section 5.2.

## 2.7. EQUIPMENT MODIFICATIONS

Not available for this EUT intended for grant.

## 2.8. ANTENNA REQUIREMENT

Standard Requirement
<p>15.203 requirement: An intentional radiator shall be designed to ensure that no antenna other than that furnished by the responsible party shall be used with the device. The use of a permanently attached antenna or of an antenna that uses a unique coupling to the intentional radiator, the manufacturer may design the unit so that a broken antenna can be replaced by the user, but the use of a standard antenna jack or electrical connector is prohibited.</p> <p>15.247(b) (4) requirement: The conducted output power limit specified in paragraph (b) of this section is based on the use of antennas with directional gains that do not exceed 6 dBi. Except as shown in paragraph (c) of this section, if transmitting antennas of directional gain greater than 6 dBi are used, the conducted output power from the intentional radiator shall be reduced below the stated values in paragraphs (b)(1), (b)(2), and (b)(3) of this section, as appropriate, by the amount in dB that the directional gain of the antenna exceeds 6 dBi</p>
<p><b>EUT Antenna:</b> The non-detachable antenna inside the device cannot be replaced by the user at will. For the antenna gain is 4.2dBi</p>

Any report having not been signed by authorized approver, or having been altered without authorization, or having not been stamped by the "Dedicated Testing/Inspection Stamp" is deemed to be invalid. Copying or excerpting portion of, or altering the content of the report is not permitted without the written authorization of AGC. The test results presented in the report apply only to the tested sample. Any objections to report issued by AGC should be submitted to AGC within 15days after the issuance of the test report. Further enquiry of validity or verification of the test report should be addressed to AGC by agc01@agccert.com.

### 3. MEASUREMENT UNCERTAINTY

The reported uncertainty of measurement  $y \pm U$ , where expanded uncertainty  $U$  is based on a standard uncertainty multiplied by a coverage factor of  $k=2$ , providing a level of confidence of approximately 95%.

Item	Measurement Uncertainty
Uncertainty of Conducted Emission for AC Port	$U_c = \pm 3.1$ dB
Uncertainty of Radiated Emission below 1GHz	$U_c = \pm 4.0$ dB
Uncertainty of Radiated Emission above 1GHz	$U_c = \pm 4.8$ dB
Uncertainty of total RF power, conducted	$U_c = \pm 0.8$ dB
Uncertainty of RF power density, conducted	$U_c = \pm 2.6$ dB
Uncertainty of spurious emissions, conducted	$U_c = \pm 2$ %
Uncertainty of Occupied Channel Bandwidth	$U_c = \pm 2$ %

Any report having not been signed by authorized approver, or having been altered without authorization, or having not been stamped by the "Dedicated Testing/Inspection Stamp" is deemed to be invalid. Copying or excerpting portion of, or altering the content of the report is not permitted without the written authorization of AGC. The test results presented in the report apply only to the tested sample. Any objections to report issued by AGC should be submitted to AGC within 15days after the issuance of the test report. Further enquiry of validity or verification of the test report should be addressed to AGC by [agc01@agccert.com](mailto:agc01@agccert.com).

#### 4. DESCRIPTION OF TEST MODES

NO.	TEST MODE DESCRIPTION
1	Low channel transmitting by DC 5V adapter
2	Middle channel transmitting by DC 5V adapter
3	High channel transmitting by DC 5V adapter
4	Low channel transmitting by DC 48V PoE
5	Middle channel transmitting by DC 48V PoE
6	High channel transmitting by DC 48V PoE

Note:

- 1) Transmit by 802.11b with Data rate (1/2/5.5/11)
- 2) Transmit by 802.11g with Data rate (6/9/12/18/24/36/48/54)
- 3) Transmit by 802.11n (20MHz) with Data rate (6.5/13/19.5/26/39/52/58.5/65)
- 4) Transmit by 802.11n (40MHz) with Data rate (13.5/27/40.5/54/81/108/121.5/135)
- 5) Transmit by 802.11ax (20MHz) with Data rate (MCS0-MCS15)
- 6) Transmit by 802.11ax (40MHz) with Data rate (MCS0-MCS15)
- 7) The test channel for 20MHz bandwidth system is channel 1, 6 and 11.
- 8) The test channel for 40MHz bandwidth system is channel 3, 6 and 9.

Note:

1. The EUT has been set to operate continuously on the lowest, middle and highest operation frequency Individually, and the EUT is operating at its maximum duty cycle>or equal 98%
2. All modes under which configure applicable have been tested and the worst mode test data recording in the test report, if no other mode data.

#### Software Setting

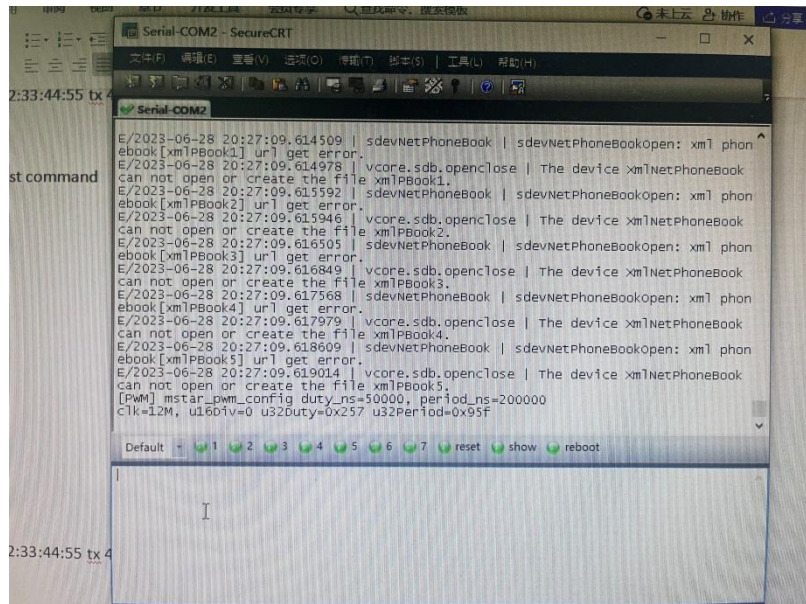

Any report having not been signed by authorized approver, or having been altered without authorization, or having not been stamped by the “Dedicated Testing/Inspection Stamp” is deemed to be invalid. Copying or excerpting portion of, or altering the content of the report is not permitted without the written authorization of AGC. The test results presented in the report apply only to the tested sample. Any objections to report issued by AGC should be submitted to AGC within 15days after the issuance of the test report. Further enquiry of validity or verification of the test report should be addressed to AGC by agc01@agccert.com.

## 5. SYSTEM TEST CONFIGURATION

### 5.1. CONFIGURATION OF EUT SYSTEM

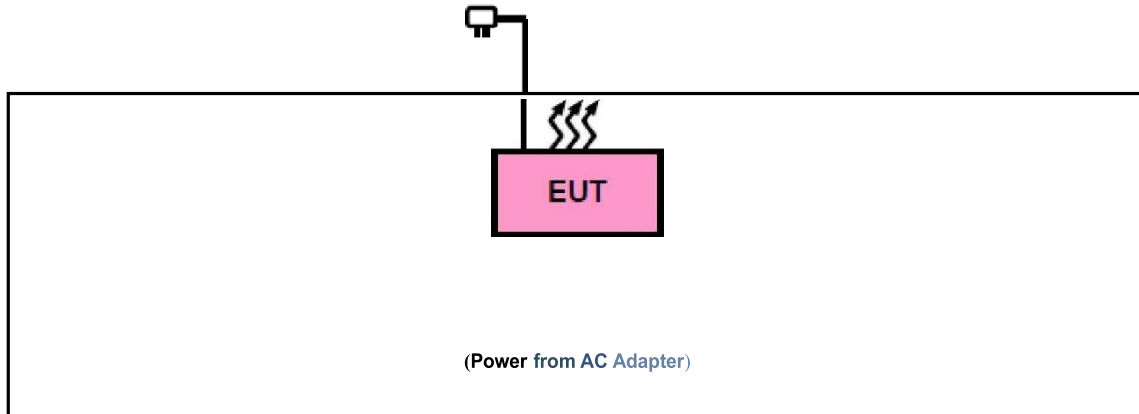

### 5.2. EQUIPMENT USED IN EUT SYSTEM

Item	Equipment	Model No.	Identifier	Note
1	IP Phone	X305	FCC ID: 2APPZ-AP6221	EUT
2	Adapter	GQ12-050200-AU	Input: AC 100-240V 50/60Hz, 0.4A Output: DC 5.0V 2A	AE
3	Ethernet Cable	N/A	N/A	AE
4	Handset Wire	N/A	1.5m Unshielded	AE
5	Handset	N/A	N/A	AE
6	Wall Stand	N/A	N/A	AE
7	Stand	N/A	N/A	AE
8	PoE	ADS-120HK-48-1 520120E	DC 12V 1A (IEEE 802.3af)	AE

### 5.3. SUMMARY OF TEST RESULTS

Item	FCC Rules	Description Of Test	Result
1	§15.203&15.247(b)(4)	Antenna Equipment	Pass
2	§15.247 (b)(1)	RF Output Power	Pass
3	§15.247 (a)(1)	6 dB Bandwidth	Pass
4	§15.247 (e)	Power Spectral Density	Pass
4	§15.247 (d)	Conducted Spurious Emission	Pass
5	§15.209	Radiated Emission& Band Edge	Pass
6	§15.207	AC Power Line Conducted Emission	Pass

Any report having not been signed by authorized approver, or having been altered without authorization, or having not been stamped by the "Dedicated Testing/Inspection Stamp" is deemed to be invalid. Copying or excerpting portion of, or altering the content of the report is not permitted without the written authorization of AGC. The test results presented in the report apply only to the tested sample. Any objections to report issued by AGC should be submitted to AGC within 15days after the issuance of the test report. Further enquiry of validity or verification of the test report should be addressed to AGC by agc01@agccert.com.

## 6. TEST FACILITY

<b>Test Site</b>	Attestation of Global Compliance (Shenzhen) Co., Ltd
<b>Location</b>	1-2/F, Building 19, Junfeng Industrial Park, Chongqing Road, Heping Community, Fuhai Street, Bao'an District, Shenzhen, Guangdong, China
<b>Designation Number</b>	CN1259
<b>FCC Test Firm Registration Number</b>	975832
<b>A2LA Cert. No.</b>	5054.02
<b>Description</b>	Attestation of Global Compliance(Shenzhen) Co., Ltd is accredited by A2LA

### TEST EQUIPMENT OF CONDUCTED EMISSION TEST

Equipment	Manufacturer	Model	S/N	Cal. Date	Cal. Due
TEST RECEIVER	R&S	ESPI	101206	Jun. 03, 2023	Jun. 02, 2024
LISN	R&S	ESH2-Z5	100086	Jun. 03, 2023	Jun. 02, 2024
Test software	R&S	ES-K1 (Ver.V1.71)	N/A	N/A	N/A

### TEST EQUIPMENT OF RADIATED EMISSION TEST

Equipment	Manufacturer	Model	S/N	Cal. Date	Cal. Due
TEST RECEIVER	R&S	ESCI	10096	Feb. 18, 2023	Feb. 17, 2024
EXA Signal Analyzer	Agilent	N9010A	MY53470504	Jun. 01, 2023	May 31, 2024
2.4GHz Filter	EM Electronics	2400-2500MHz	N/A	N/A	N/A
USB Wideband Power Sensor	Agilent	U2021XA	MY54110007	Mar. 03, 2023	Mar. 02, 2024
Attenuator	ZHINAN	E-002	N/A	Sep. 01, 2022	Aug. 31, 2023
Horn antenna	SCHWARZBECK	BBHA 9170	#768	Oct. 31, 2021	Oct. 30, 2023
Active loop antenna (9K-30MHz)	ZHINAN	ZN30900C	18051	Mar. 12, 2022	Mar. 11, 2024
Double-Ridged Waveguide Horn	ETS LINDGREN	3117	00034609	Mar. 23, 2023	Mar. 22, 2024
Broadband Preampifier	ETS LINDGREN	3117PA	00225134	N/A	N/A
ANTENNA	SCHWARZBECK	VULB9168	494	Jan. 05, 2023	Jan. 04, 2025
Test software	Tonscend	JS32-RE (Ver.2.5)	N/A	N/A	N/A

Any report having not been signed by authorized approver, or having been altered without authorization, or having not been stamped by the "Dedicated Testing/Inspection Stamp" is deemed to be invalid. Copying or excerpting portion of, or altering the content of the report is not permitted without the written authorization of AGC. The test results presented in the report apply only to the tested sample. Any objections to report issued by AGC should be submitted to AGC within 15days after the issuance of the test report. Further enquiry of validity or verification of the test report should be addressed to AGC by agc01@agccert.com.

## 7. RF OUTPUT POWER MEASUREMENT

### 7.1 MEASUREMENT LIMITS

For DTSs employing digital modulation techniques operating in the bands 2400-2483.5 MHz, the maximum peak conducted output power shall not exceed 1 W.

### 7.2 MEASUREMENT PROCEDURE

1. Connect EUT RF output port to power sensor through an RF attenuator.
2. Connect the power sensor to the PC.
3. Set the EUT Work on the top, the middle and the bottom operation frequency individually.
4. Set the gated average detector for average power measurement and peak detector for peak power measurement.
5. Record the maximum power from the software.

**Note :** The EUT was tested according to ANSI C63.10 (2013) for compliance to FCC 47CFR 15.247 requirements.

### 7.3 MEASUREMENT SETUP (BLOCK DIAGRAM OF CONFIGURATION)

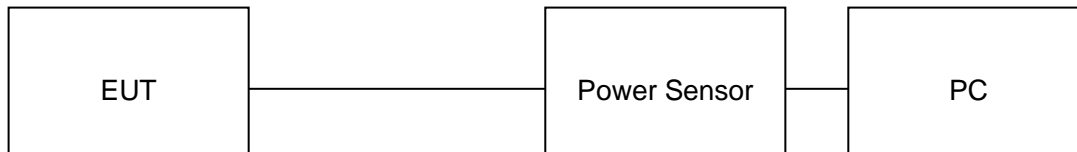

Any report having not been signed by authorized approver, or having been altered without authorization, or having not been stamped by the “Dedicated Testing/Inspection Stamp” is deemed to be invalid. Copying or excerpting portion of, or altering the content of the report is not permitted without the written authorization of AGC. The test results presented in the report apply only to the tested sample. Any objections to report issued by AGC should be submitted to AGC within 15days after the issuance of the test report. Further enquiry of validity or verification of the test report should be addressed to AGC by [agc01@agccert.com](mailto:agc01@agccert.com).

### 7.4 MEASUREMENT RESULT

Test Data of Conducted Output Power					
Test Mode	Test Channel (MHz)	Average Power (dBm)	Peak Power (dBm)	Limits (dBm)	Pass or Fail
802.11b	2412	12.14	14.97	≤30	Pass
	2437	11.94	14.77	≤30	Pass
	2462	11.86	14.88	≤30	Pass
802.11g	2412	11.48	18.92	≤30	Pass
	2437	11.33	18.74	≤30	Pass
	2462	10.81	18.76	≤30	Pass
802.11n20	2412	11.57	18.95	≤30	Pass
	2437	10.67	18.80	≤30	Pass
	2462	10.99	18.74	≤30	Pass
802.11n40	2422	11.95	19.13	≤30	Pass
	2437	11.26	19.07	≤30	Pass
	2452	11.09	19.11	≤30	Pass

Any report having not been signed by authorized approver, or having been altered without authorization, or having not been stamped by the “Dedicated Testing/Inspection Stamp” is deemed to be invalid. Copying or excerpting portion of, or altering the content of the report is not permitted without the written authorization of AGC. The test results presented in the report apply only to the tested sample. Any objections to report issued by AGC should be submitted to AGC within 15days after the issuance of the test report. Further enquiry of validity or verification of the test report should be addressed to AGC by agc01@agccert.com.

## 8. 6DB BANDWIDTH MEASUREMENT

### 8.1 MEASUREMENT LIMITS

The minimum 6 dB bandwidth shall be 500 kHz.

### 8.2 MEASUREMENT PROCEDURE

- 1) The testing follows the ANSI C63.10 Section 6.9.3 (OBW) and 11.8.1 (6dB BW).
- 2) The RF output of EUT was connected to the spectrum analyzer by RF cable and attenuator. The path loss was compensated to the results for each measurement.
- 3) Set to the maximum power setting and enable the EUT transmit continuously.
- 4) For 6dB Bandwidth Measurement, the spectrum analyzer's resolution bandwidth (RBW) = 100 kHz. Set the Video bandwidth (VBW) = 300 kHz. In order to make an accurate measurement.
- 5) For 99% Bandwidth Measurement, the spectrum analyzer's resolution bandwidth (RBW) is set 1-5% of the emission bandwidth and set the Video bandwidth (VBW)  $\geq 3 * RBW$ .
- 6) Detector = peak
- 7) Trace mode = max hold.
- 8) Sweep = auto couple.
- 9) Allow the trace to stabilize.
- 10) Measure and record the results in the test report.

### 8.3 MEASUREMENT SETUP (BLOCK DIAGRAM OF CONFIGURATION)

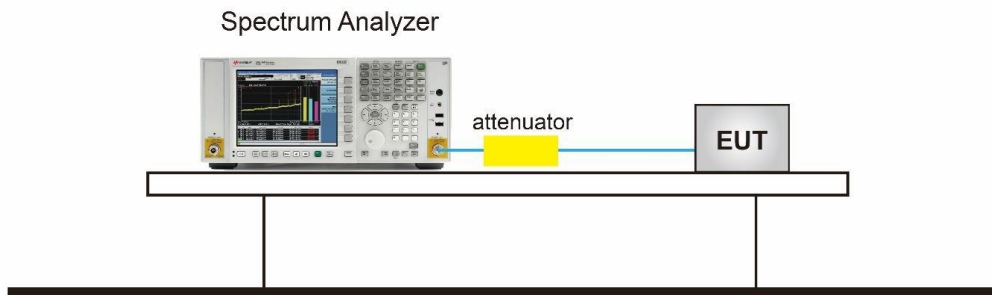

Any report having not been signed by authorized approver, or having been altered without authorization, or having not been stamped by the "Dedicated Testing/Inspection Stamp" is deemed to be invalid. Copying or excerpting portion of, or altering the content of the report is not permitted without the written authorization of AGC. The test results presented in the report apply only to the tested sample. Any objections to report issued by AGC should be submitted to AGC within 15days after the issuance of the test report. Further enquiry of validity or verification of the test report should be addressed to AGC by [agc01@agccert.com](mailto:agc01@agccert.com).



#### 8.4 MEASUREMENT RESULTS

Test Data of Occupied Bandwidth and DTS Bandwidth					
Test Mode	Test Channel (MHz)	99% Occupied Bandwidth (MHz)	DTS Bandwidth (MHz)	DTSBW Limits (MHz)	Pass or Fail
802.11b	2412	15.062	10.080	$\geq 0.5$	Pass
	2437	15.066	10.101	$\geq 0.5$	Pass
	2462	15.059	10.089	$\geq 0.5$	Pass
802.11g	2412	16.811	16.371	$\geq 0.5$	Pass
	2437	16.666	16.382	$\geq 0.5$	Pass
	2462	16.634	16.358	$\geq 0.5$	Pass
802.11n20	2412	17.714	17.573	$\geq 0.5$	Pass
	2437	17.812	17.545	$\geq 0.5$	Pass
	2462	17.733	17.573	$\geq 0.5$	Pass
802.11n40	2422	36.243	36.354	$\geq 0.5$	Pass
	2437	36.280	36.338	$\geq 0.5$	Pass
	2452	36.370	36.361	$\geq 0.5$	Pass

Any report having not been signed by authorized approver, or having been altered without authorization, or having not been stamped by the "Dedicated Testing/Inspection Stamp" is deemed to be invalid. Copying or excerpting portion of, or altering the content of the report is not permitted without the written authorization of AGC. The test results presented in the report apply only to the tested sample. Any objections to report issued by AGC should be submitted to AGC within 15days after the issuance of the test report. Further enquiry of validity or verification of the test report should be addressed to AGC by agc01@agccert.com.

### Test Graphs of Occupied Bandwidth

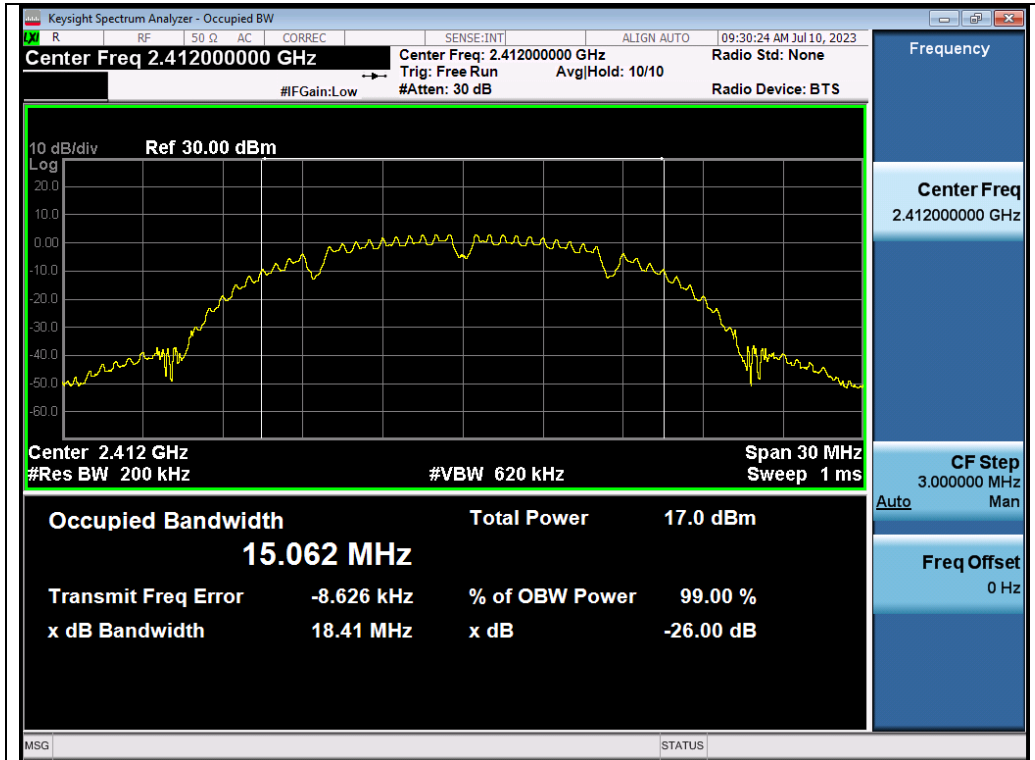

Test\_Graph\_802.11b\_ANT1\_2412\_1Mbps\_OBW

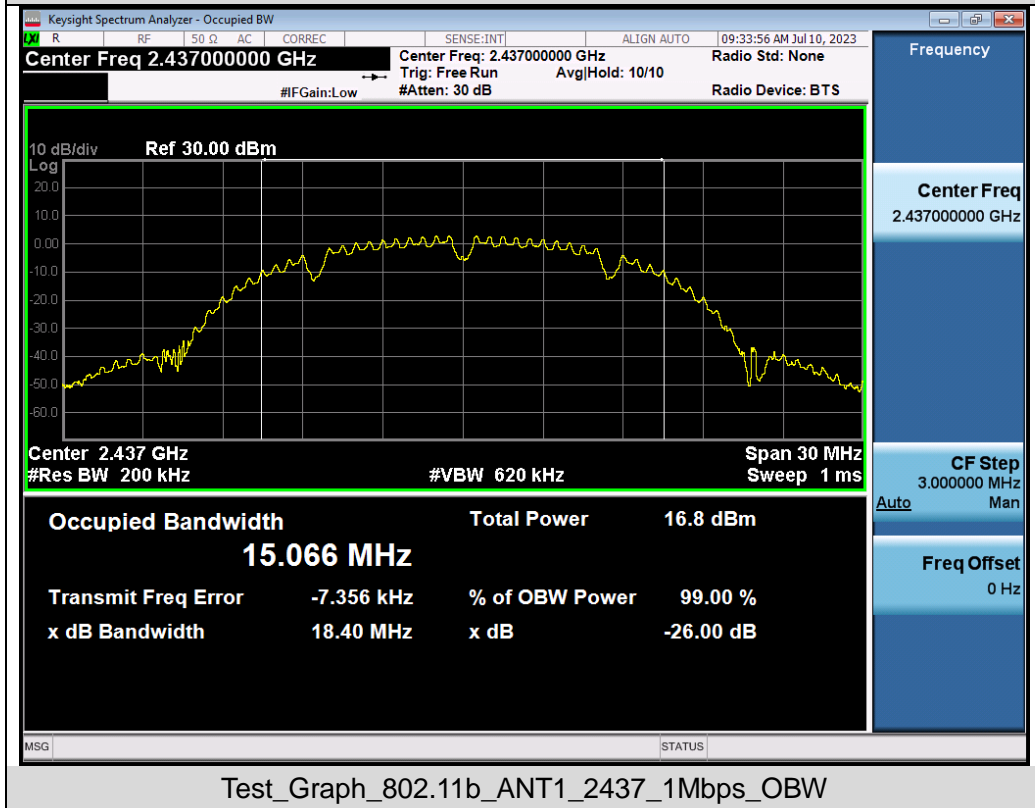

Test\_Graph\_802.11b\_ANT1\_2437\_1Mbps\_OBW

Any report having not been signed by authorized approver, or having been altered without authorization, or having not been stamped by the "Dedicated Testing/Inspection Stamp" is deemed to be invalid. Copying or excerpting portion of, or altering the content of the report is not permitted without the written authorization of AGC. The test results presented in the report apply only to the tested sample. Any objections to report issued by AGC should be submitted to AGC within 15days after the issuance of the test report. Further enquiry of validity or verification of the test report should be addressed to AGC by agc01@agccert.com.



Test\_Graph\_802.11b\_ANT1\_2462\_1Mbps\_OBW

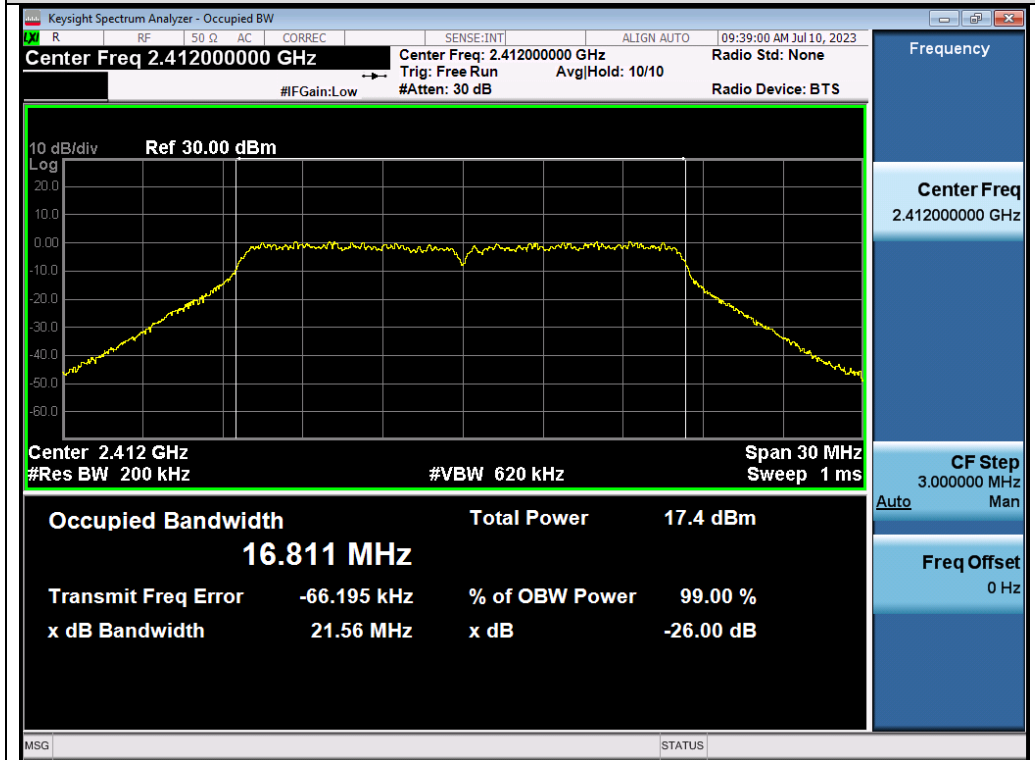

Test\_Graph\_802.11g\_ANT1\_2412\_6Mbps\_OBW

Any report having not been signed by authorized approver, or having been altered without authorization, or having not been stamped by the "Dedicated Testing/Inspection Stamp" is deemed to be invalid. Copying or excerpting portion of, or altering the content of the report is not permitted without the written authorization of AGC. The test results presented in the report apply only to the tested sample. Any objections to report issued by AGC should be submitted to AGC within 15days after the issuance of the test report. Further enquiry of validity or verification of the test report should be addressed to AGC by agc01@agccert.com.

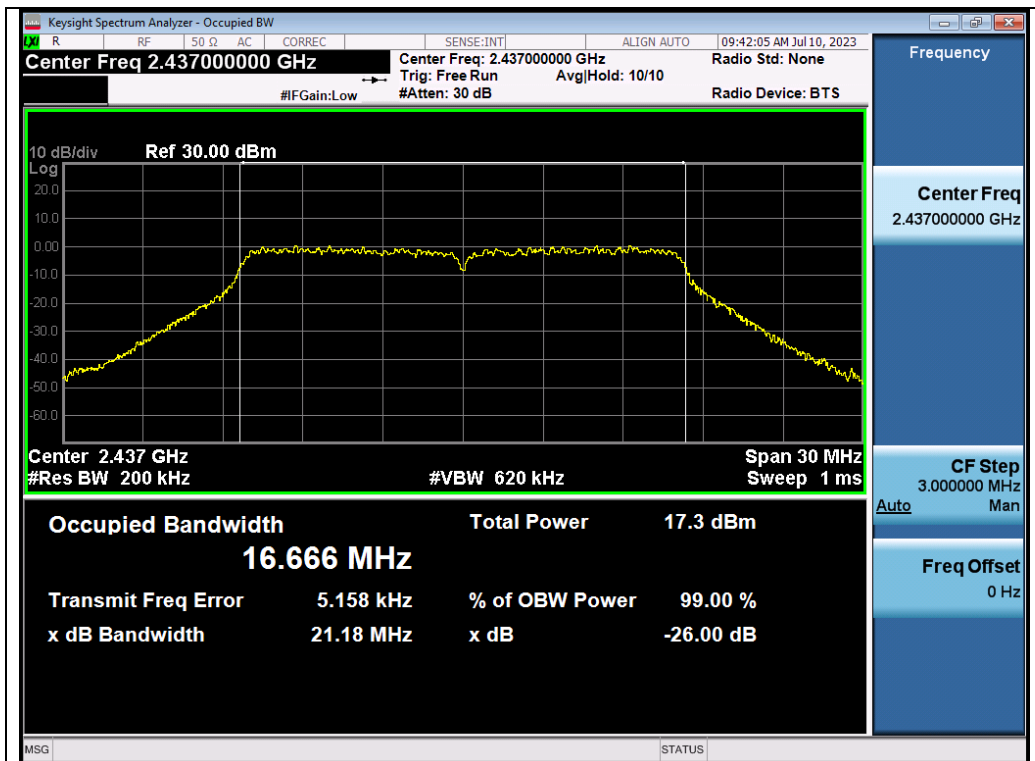

Test\_Graph\_802.11g\_ANT1\_2437\_6Mbps\_OBW

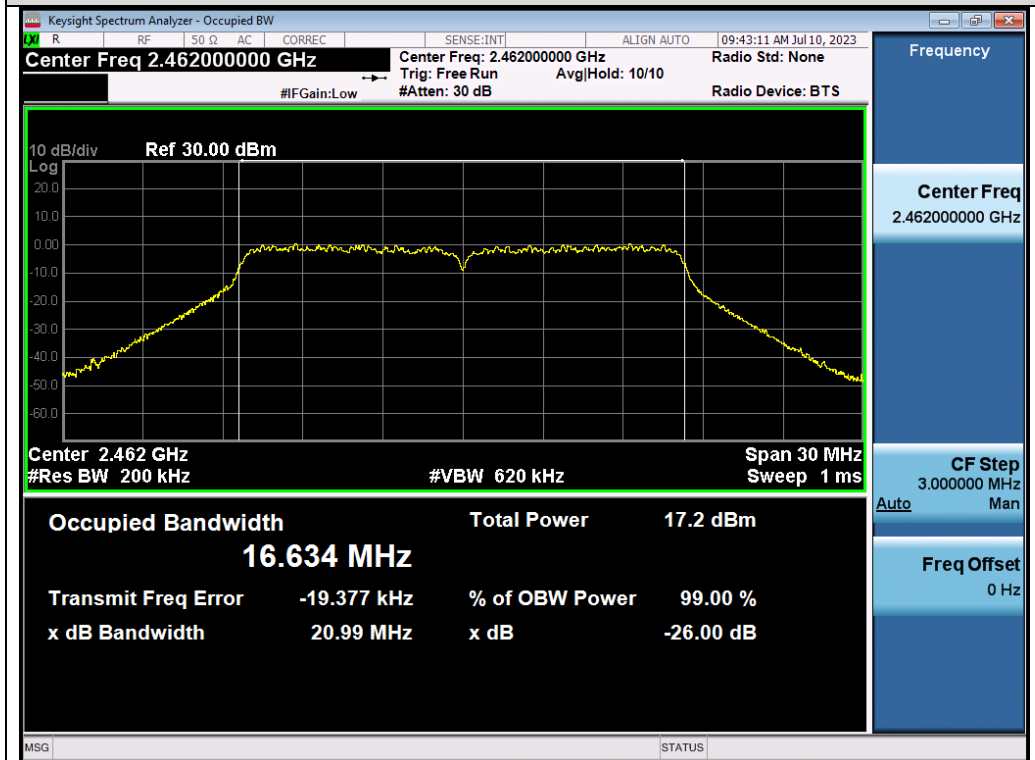

Test\_Graph\_802.11g\_ANT1\_2462\_6Mbps\_OBW

Any report having not been signed by authorized approver, or having been altered without authorization, or having not been stamped by the "Dedicated Testing/Inspection Stamp" is deemed to be invalid. Copying or excerpting portion of, or altering the content of the report is not permitted without the written authorization of AGC. The test results presented in the report apply only to the tested sample. Any objections to report issued by AGC should be submitted to AGC within 15days after the issuance of the test report. Further enquiry of validity or verification of the test report should be addressed to AGC by agc01@agccert.com.

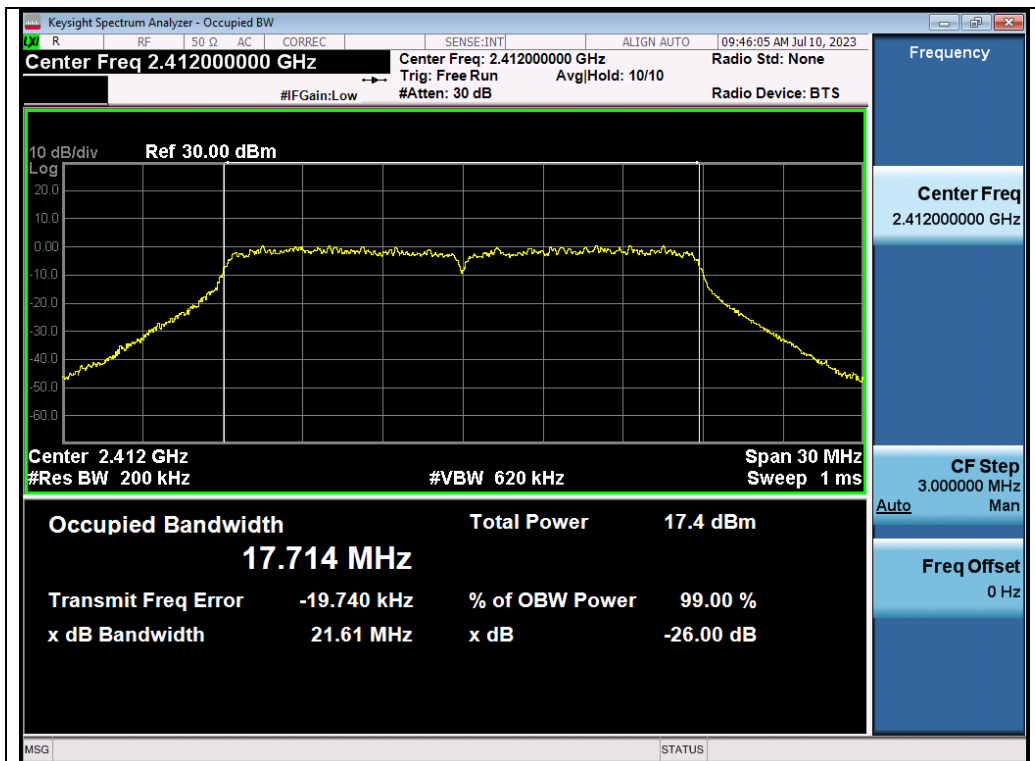

Test\_Graph\_802.11n20\_ANT1\_2412\_MCS0\_OBW

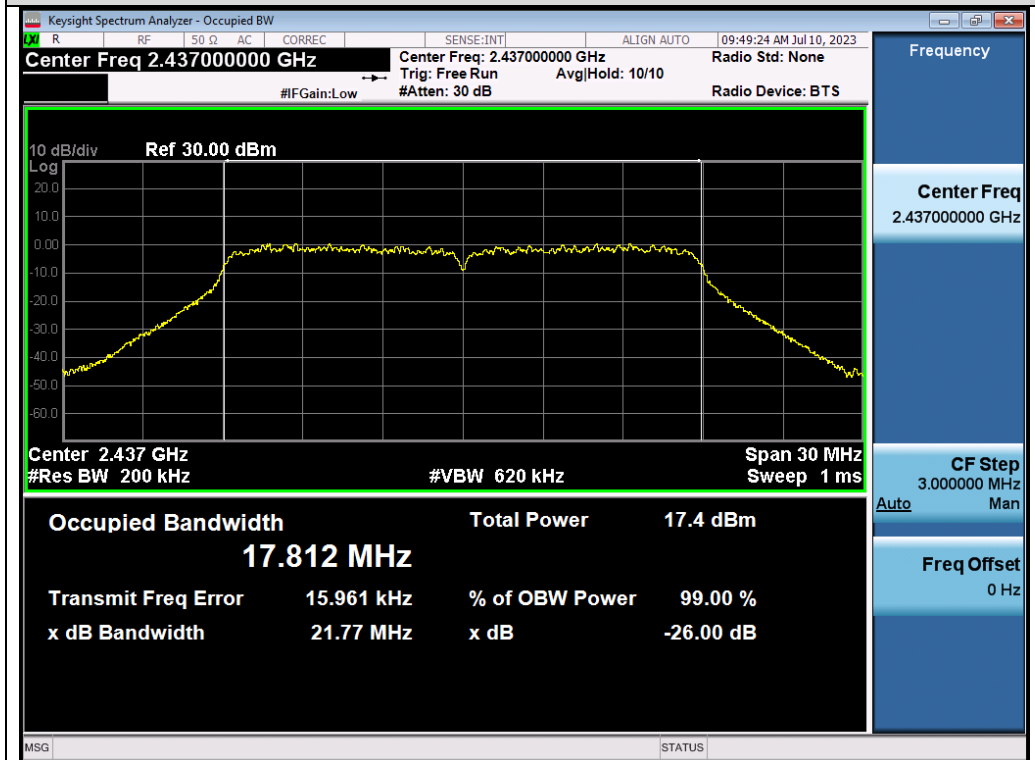

Test\_Graph\_802.11n20\_ANT1\_2437\_MCS0\_OBW

Any report having not been signed by authorized approver, or having been altered without authorization, or having not been stamped by the "Dedicated Testing/Inspection Stamp" is deemed to be invalid. Copying or excerpting portion of, or altering the content of the report is not permitted without the written authorization of AGC. The test results presented in the report apply only to the tested sample. Any objections to report issued by AGC should be submitted to AGC within 15days after the issuance of the test report. Further enquiry of validity or verification of the test report should be addressed to AGC by agc01@agccert.com.

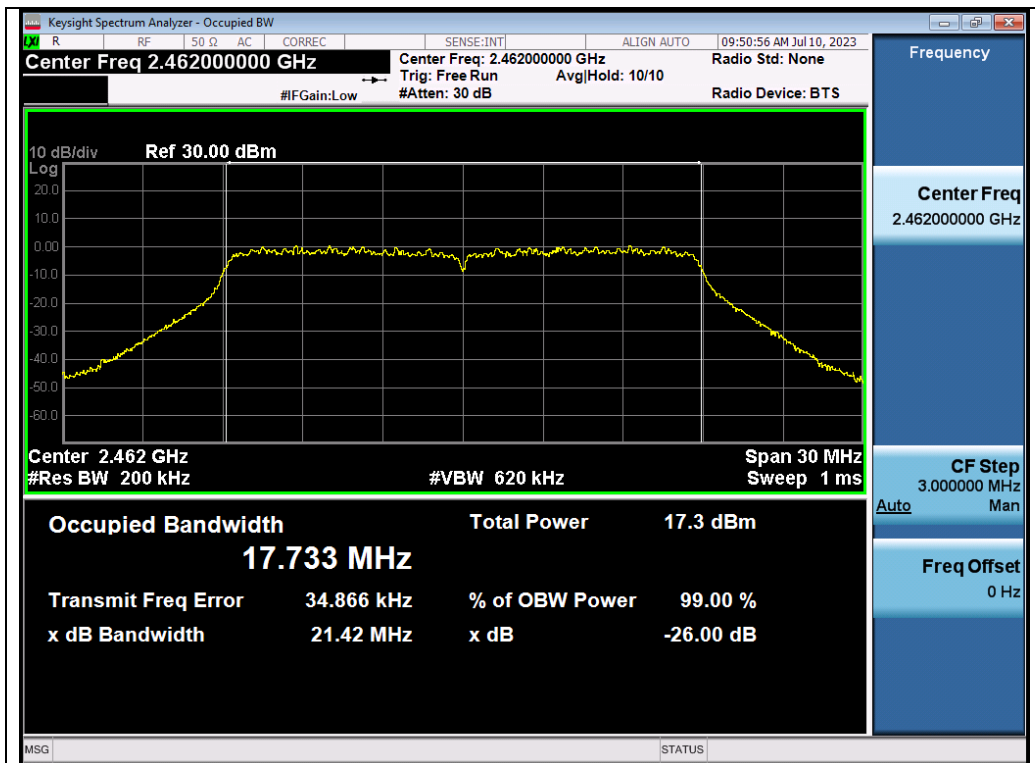

Test\_Graph\_802.11n20\_ANT1\_2462\_MCS0\_OBW

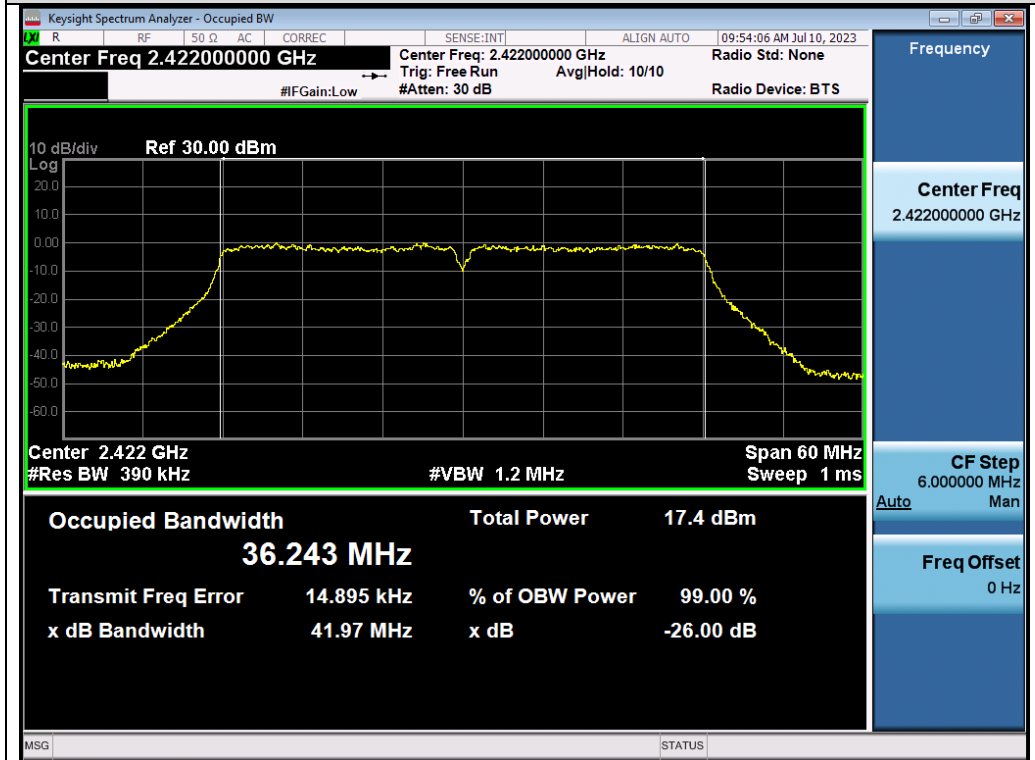

Test\_Graph\_802.11n40\_ANT1\_2422\_MCS0\_OBW

Any report having not been signed by authorized approver, or having been altered without authorization, or having not been stamped by the "Dedicated Testing/Inspection Stamp" is deemed to be invalid. Copying or excerpting portion of, or altering the content of the report is not permitted without the written authorization of AGC. The test results presented in the report apply only to the tested sample. Any objections to report issued by AGC should be submitted to AGC within 15days after the issuance of the test report. Further enquiry of validity or verification of the test report should be addressed to AGC by agc01@agccert.com.

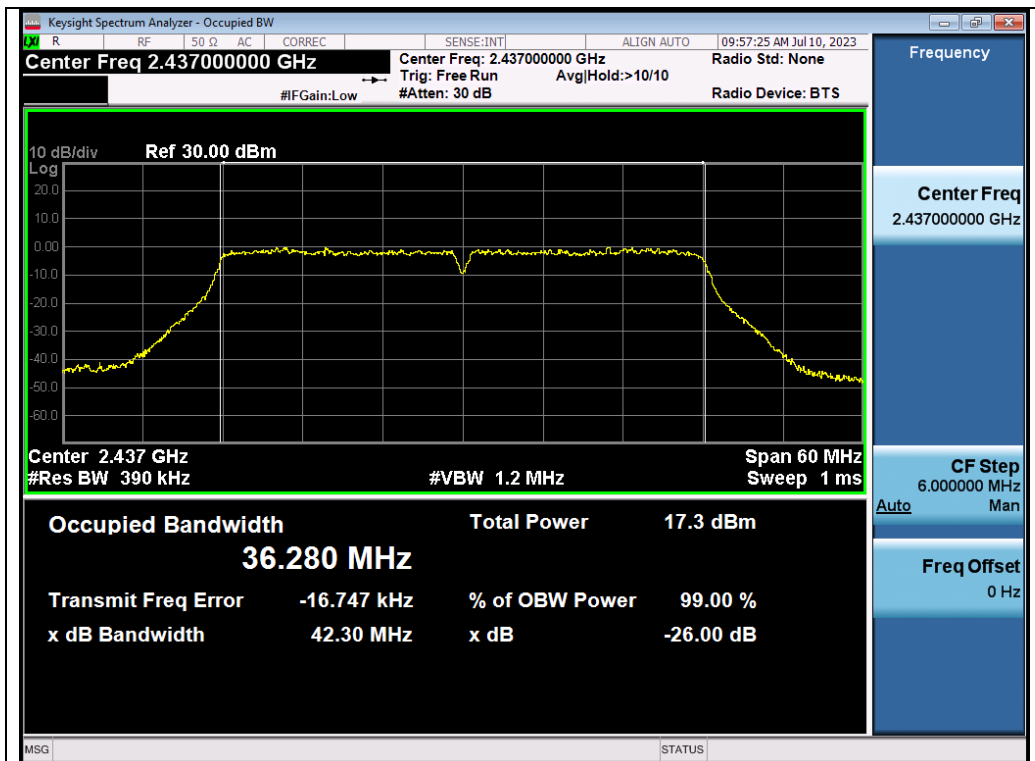

Test\_Graph\_802.11n40\_ANT1\_2437\_MCS0\_OBW

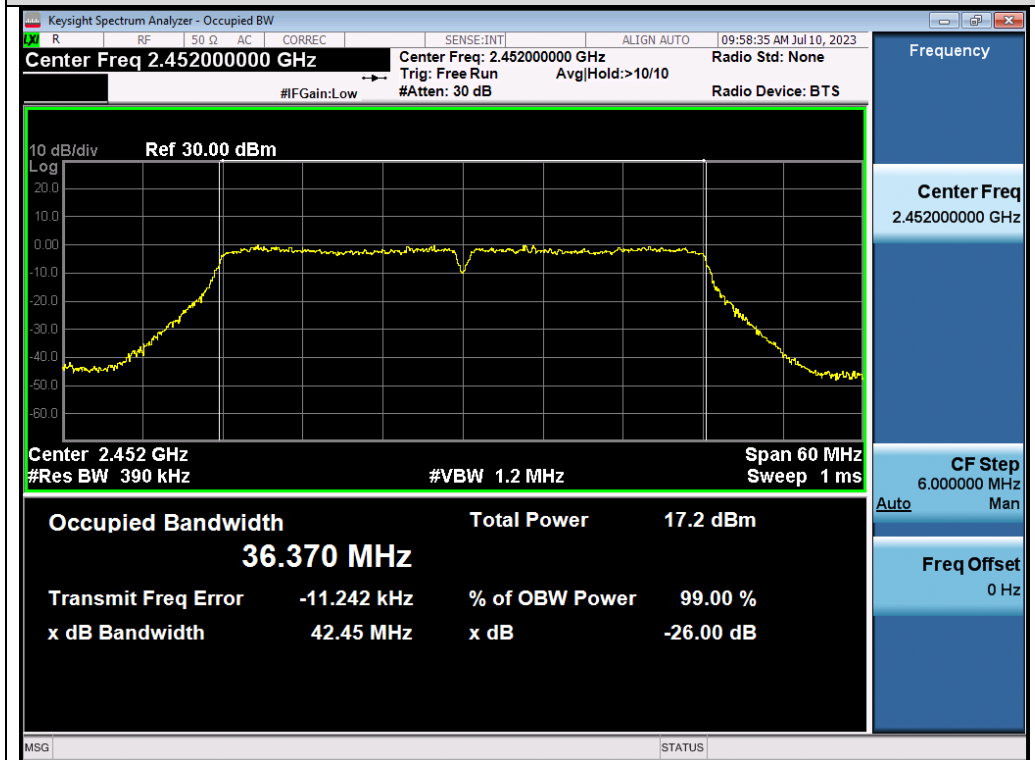

Test\_Graph\_802.11n40\_ANT1\_2452\_MCS0\_OBW

Any report having not been signed by authorized approver, or having been altered without authorization, or having not been stamped by the "Dedicated Testing/Inspection Stamp" is deemed to be invalid. Copying or excerpting portion of, or altering the content of the report is not permitted without the written authorization of AGC. The test results presented in the report apply only to the tested sample. Any objections to report issued by AGC should be submitted to AGC within 15days after the issuance of the test report. Further enquiry of validity or verification of the test report should be addressed to AGC by agc01@agccert.com.

### Test Graphs of DTS Bandwidth

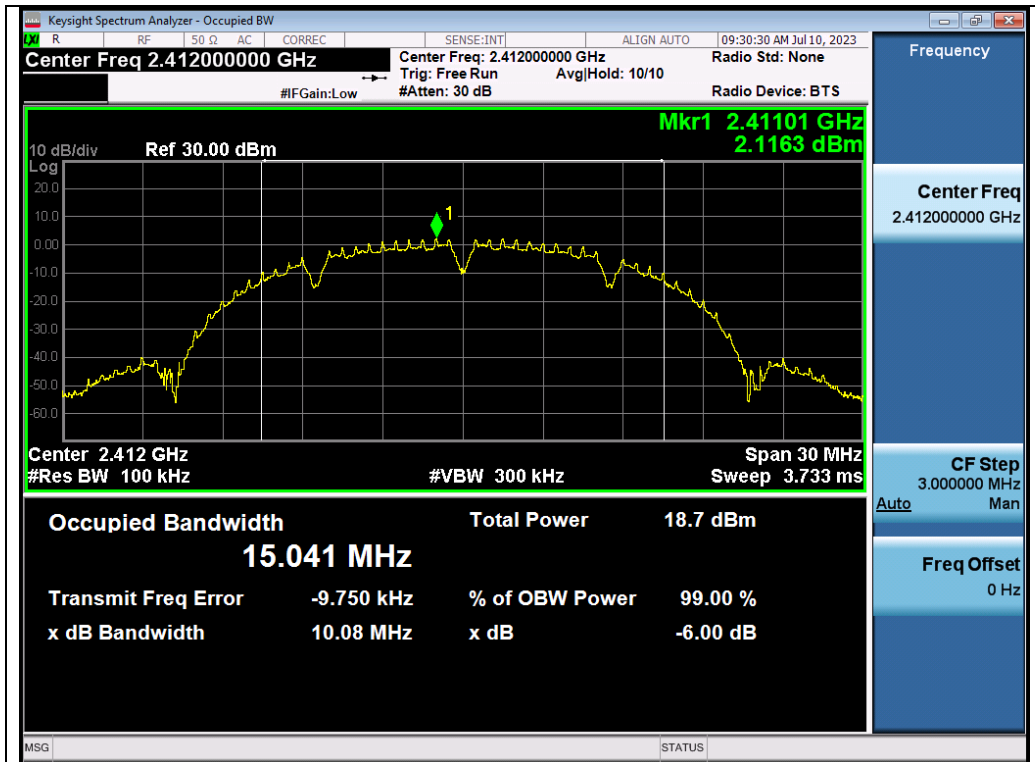

Test\_Graph\_802.11b\_ANT1\_2412\_1Mbps\_DTBSW

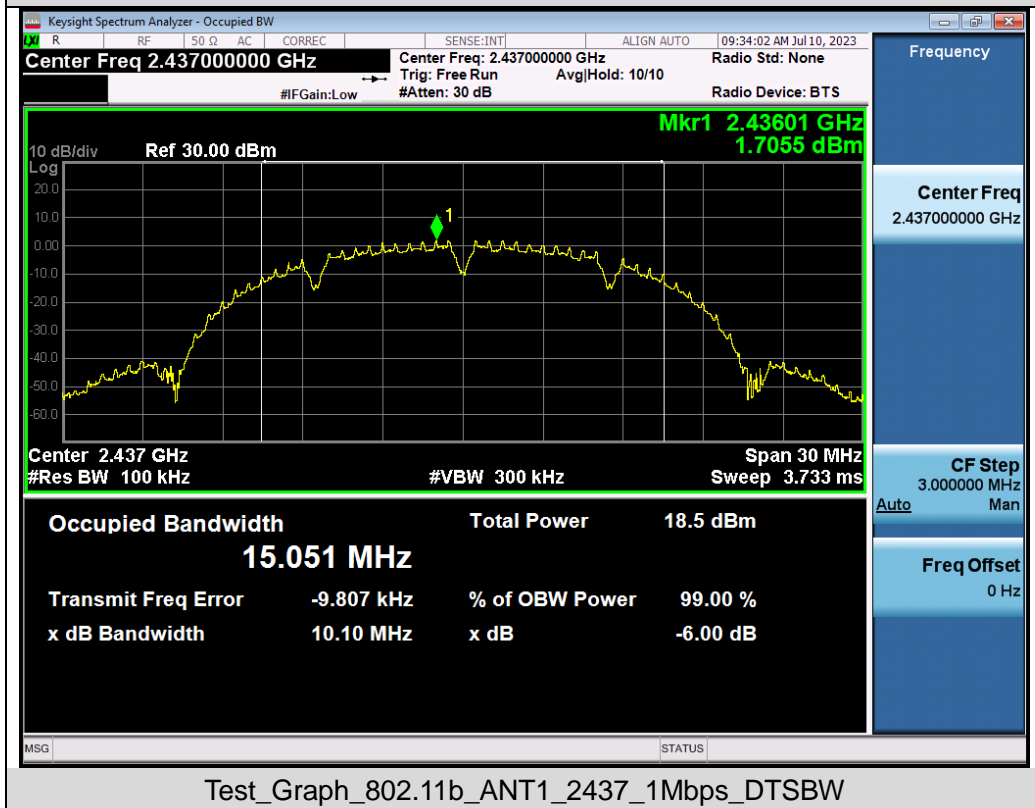

Test\_Graph\_802.11b\_ANT1\_2437\_1Mbps\_DTBSW

Any report having not been signed by authorized approver, or having been altered without authorization, or having not been stamped by the "Dedicated Testing/Inspection Stamp" is deemed to be invalid. Copying or excerpting portion of, or altering the content of the report is not permitted without the written authorization of AGC. The test results presented in the report apply only to the tested sample. Any objections to report issued by AGC should be submitted to AGC within 15days after the issuance of the test report. Further enquiry of validity or verification of the test report should be addressed to AGC by agc01@agccert.com.





Test\_Graph\_802.11b\_ANT1\_2462\_1Mbps\_DTSBW

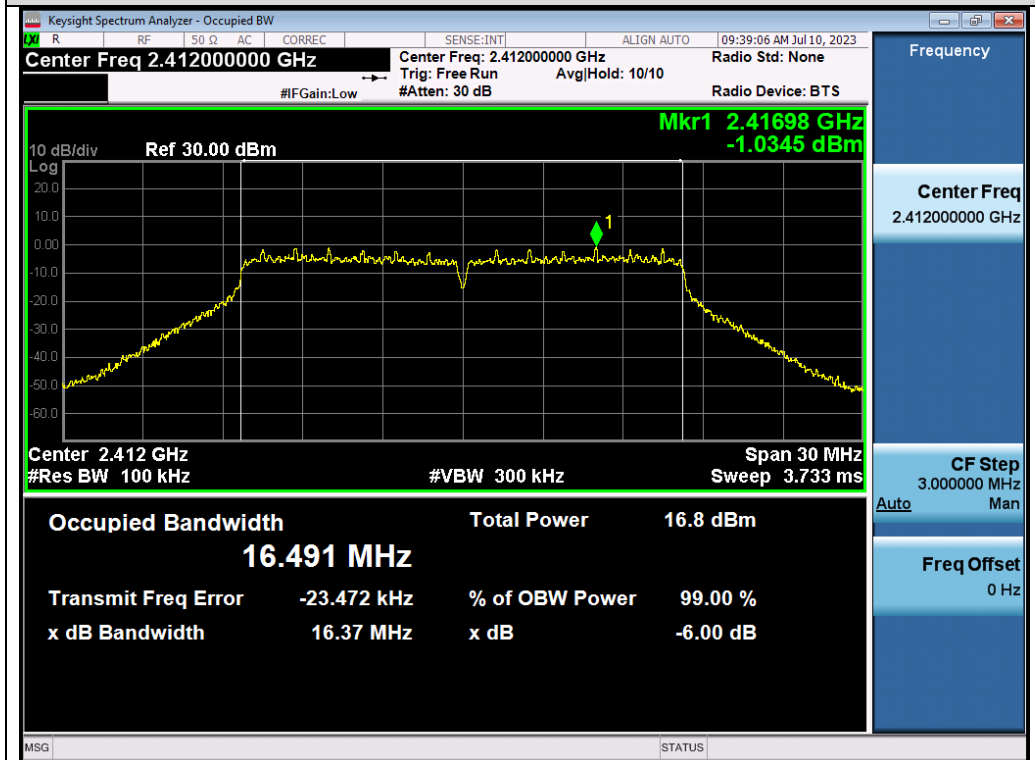

Test\_Graph\_802.11g\_ANT1\_2412\_6Mbps\_DTSBW

Any report having not been signed by authorized approver, or having been altered without authorization, or having not been stamped by the "Dedicated Testing/Inspection Stamp" is deemed to be invalid. Copying or excerpting portion of, or altering the content of the report is not permitted without the written authorization of AGC. The test results presented in the report apply only to the tested sample. Any objections to report issued by AGC should be submitted to AGC within 15days after the issuance of the test report. Further enquiry of validity or verification of the test report should be addressed to AGC by agc01@agccert.com.



Test\_Graph\_802.11g\_ANT1\_2437\_6Mbps\_DTSBW

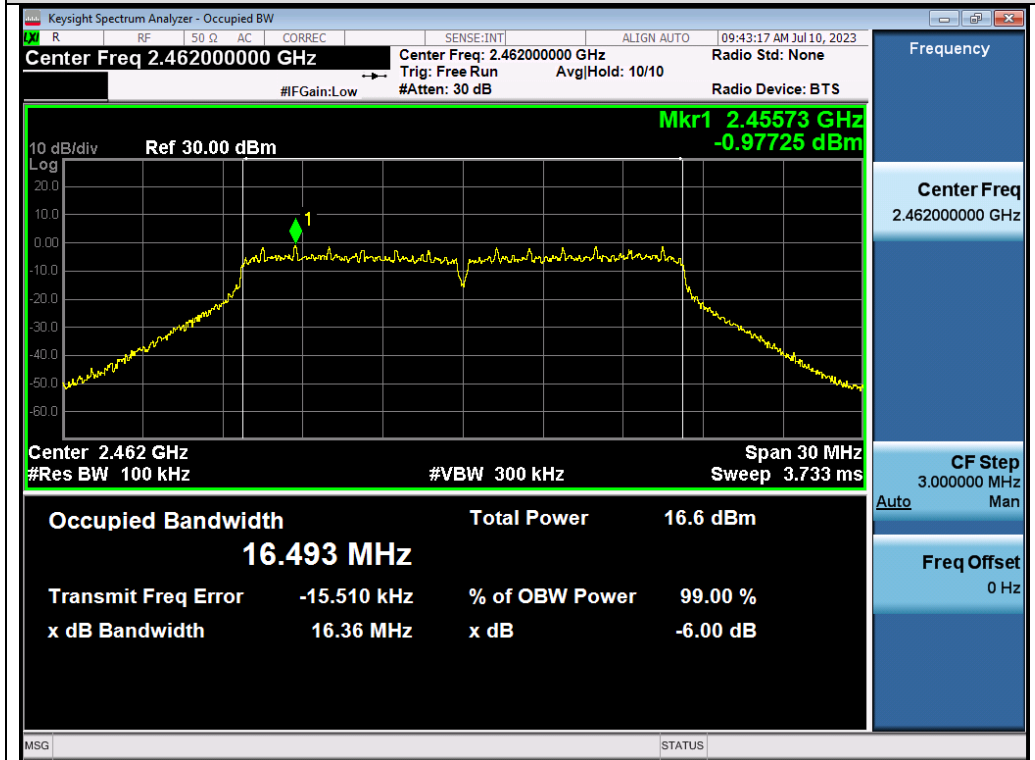

Test\_Graph\_802.11g\_ANT1\_2462\_6Mbps\_DTSBW

Any report having not been signed by authorized approver, or having been altered without authorization, or having not been stamped by the "Dedicated Testing/Inspection Stamp" is deemed to be invalid. Copying or excerpting portion of, or altering the content of the report is not permitted without the written authorization of AGC. The test results presented in the report apply only to the tested sample. Any objections to report issued by AGC should be submitted to AGC within 15days after the issuance of the test report. Further enquiry of validity or verification of the test report should be addressed to AGC by agc01@agccert.com.

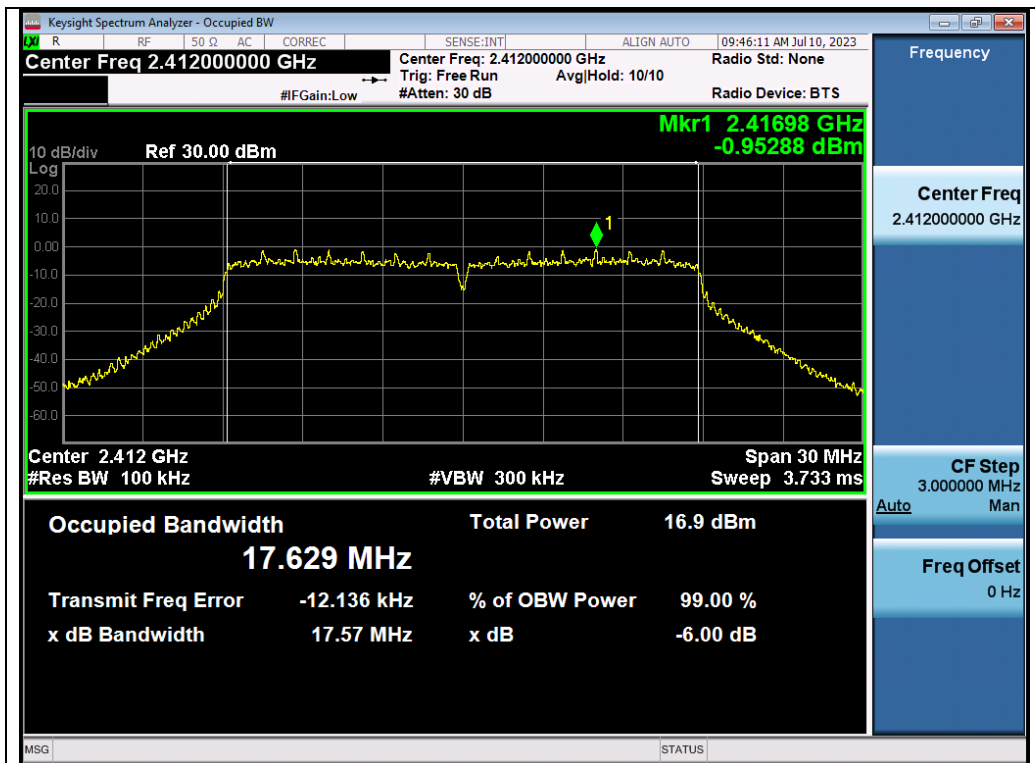

Test\_Graph\_802.11n20\_ANT1\_2412\_MCS0\_DTSBW



Test\_Graph\_802.11n20\_ANT1\_2437\_MCS0\_DTSBW

Any report having not been signed by authorized approver, or having been altered without authorization, or having not been stamped by the "Dedicated Testing/Inspection Stamp" is deemed to be invalid. Copying or excerpting portion of, or altering the content of the report is not permitted without the written authorization of AGC. The test results presented in the report apply only to the tested sample. Any objections to report issued by AGC should be submitted to AGC within 15days after the issuance of the test report. Further enquiry of validity or verification of the test report should be addressed to AGC by agc01@agccert.com.

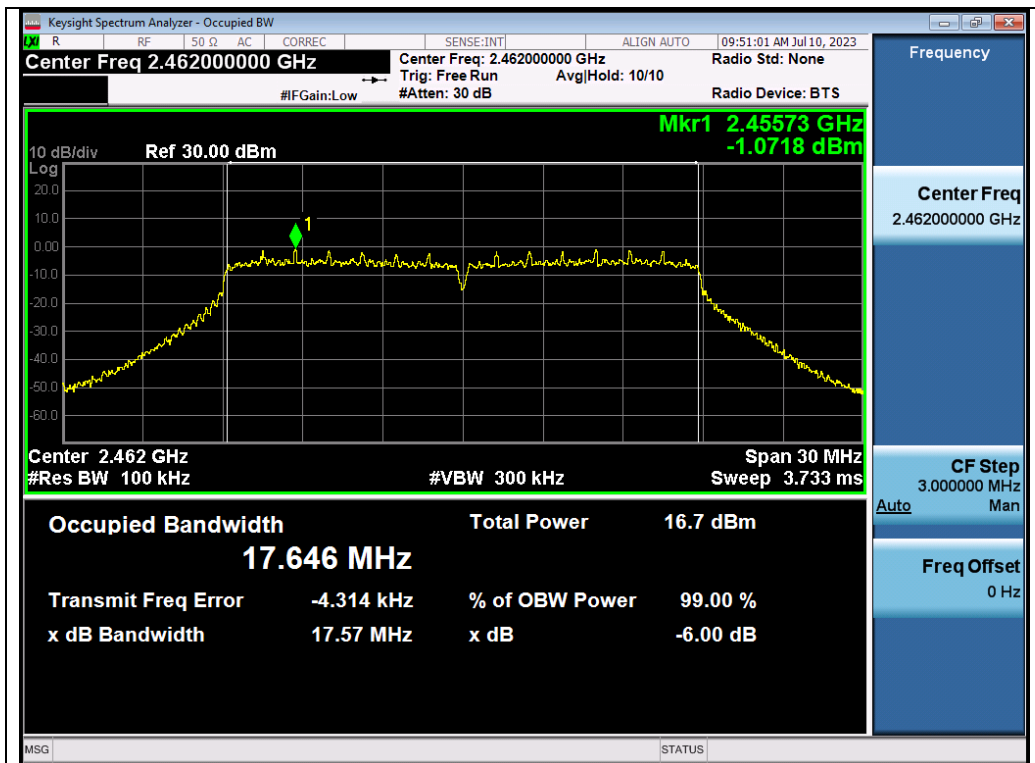

Test\_Graph\_802.11n20\_ANT1\_2462\_MCS0\_DTSBW

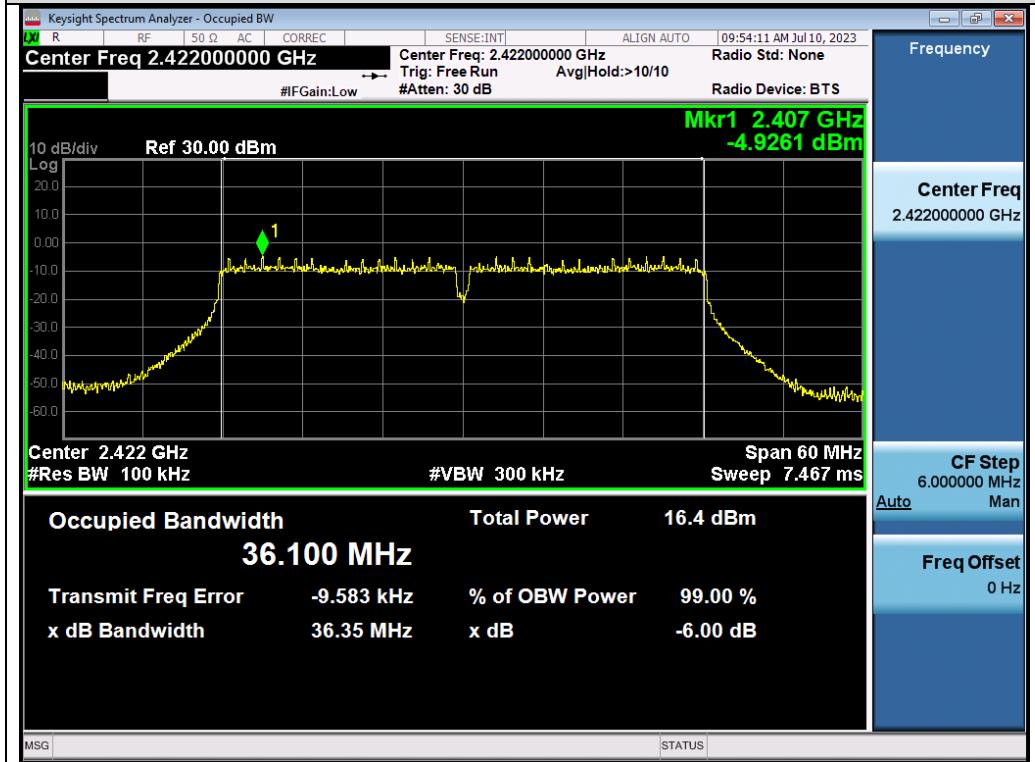

Test\_Graph\_802.11n40\_ANT1\_2422\_MCS0\_DTSBW

Any report having not been signed by authorized approver, or having been altered without authorization, or having not been stamped by the "Dedicated Testing/Inspection Stamp" is deemed to be invalid. Copying or excerpting portion of, or altering the content of the report is not permitted without the written authorization of AGC. The test results presented in the report apply only to the tested sample. Any objections to report issued by AGC should be submitted to AGC within 15days after the issuance of the test report. Further enquiry of validity or verification of the test report should be addressed to AGC by agc01@agccert.com.

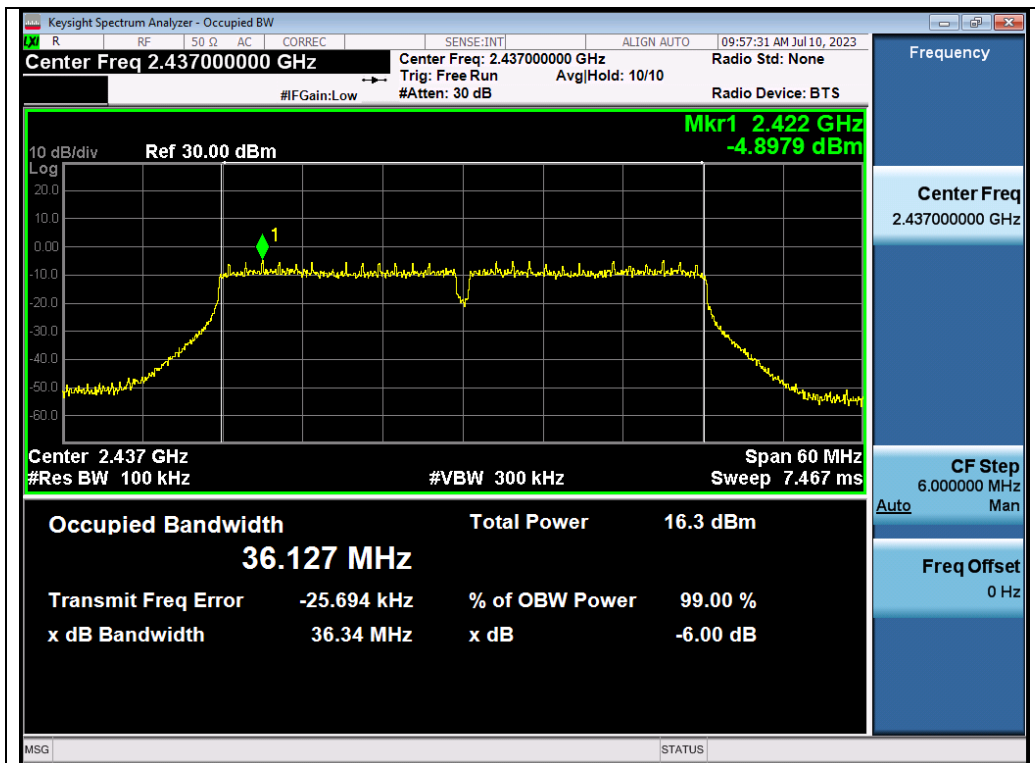

Test\_Graph\_802.11n40\_ANT1\_2437\_MCS0\_DTSBW

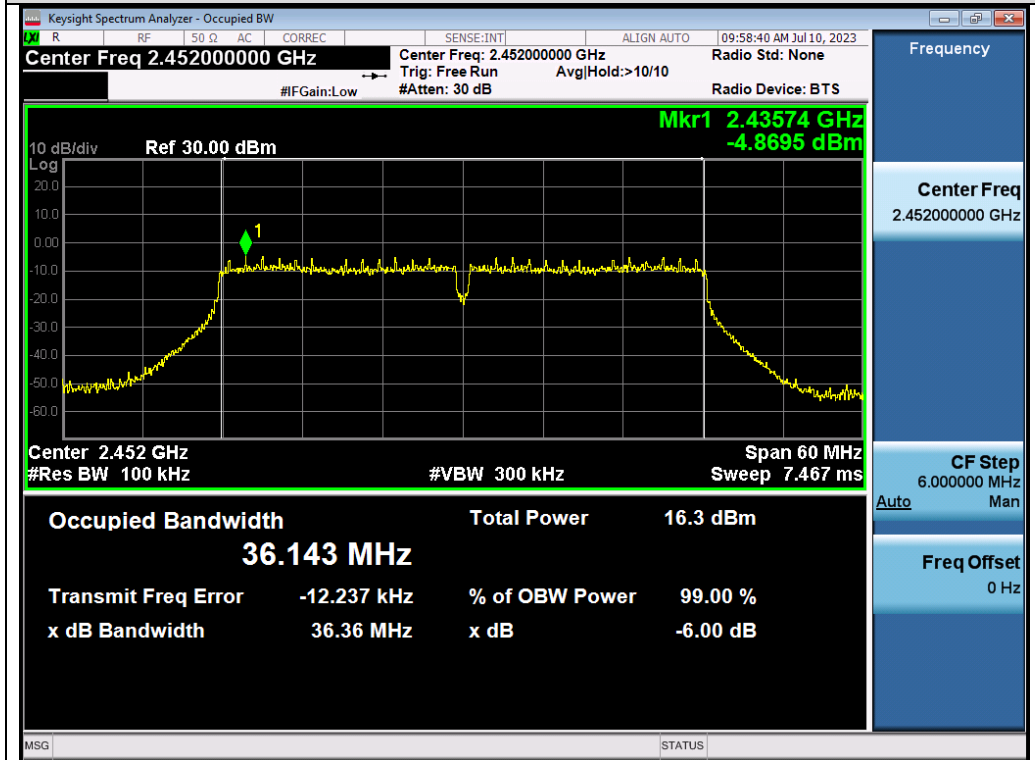

Test\_Graph\_802.11n40\_ANT1\_2452\_MCS0\_DTSBW

Any report having not been signed by authorized approver, or having been altered without authorization, or having not been stamped by the "Dedicated Testing/Inspection Stamp" is deemed to be invalid. Copying or excerpting portion of, or altering the content of the report is not permitted without the written authorization of AGC. The test results presented in the report apply only to the tested sample. Any objections to report issued by AGC should be submitted to AGC within 15days after the issuance of the test report. Further enquiry of validity or verification of the test report should be addressed to AGC by agc01@agccert.com.

## 9. CONDUCTED SPURIOUS EMISSION

### 9.1 MEASUREMENT LIMIT

Limits and Measurement Result		
Applicable Limits	Measurement Result	
	Test Data	Criteria
<p>In any 100 kHz Bandwidth Outside the frequency band in which the spread spectrum intentional radiator is operating, the radio frequency power that is produced by the intentional radiator shall be at least 20 dB below that in 100kHz bandwidth within the band that contains the highest level of the desired power.</p> <p>In addition, radiation emissions which fall in the restricted bands, as defined in §15.205(a), must also comply with the radiated emission limits specified in §15.209(a)</p>	At least -20dBc than the limit Specified on the Bottom Channel	PASS
	At least -20dBc than the limit Specified on the Top Channel	PASS

### 9.2 MEASUREMENT PROCEDURE

1. Connect EUT RF output port to the Spectrum Analyzer through an RF attenuator
2. Set the EUT Work on the top, the Middle and the bottom operation frequency individually.
3. Set the Span = wide enough to capture the peak level of the in-band emission and all spurious emissions from the lowest frequency generated in the EUT up through the 10th harmonic.
4. RBW = 100 kHz; VBW= 300 kHz; Sweep = auto; Detector function = peak.(Test frequency below 1GHz)
5. RBW = 1 MHz; VBW= 3 MHz; Sweep = auto; Detector function = peak.(Test frequency Above 1GHz)
6. Set SPA Trace 1 Max hold, then View.
7. Mark the maximum useless stray point and compare it with the limit value to record the result.

### 9.3 MEASUREMENT SETUP (BLOCK DIAGRAM OF CONFIGURATION)

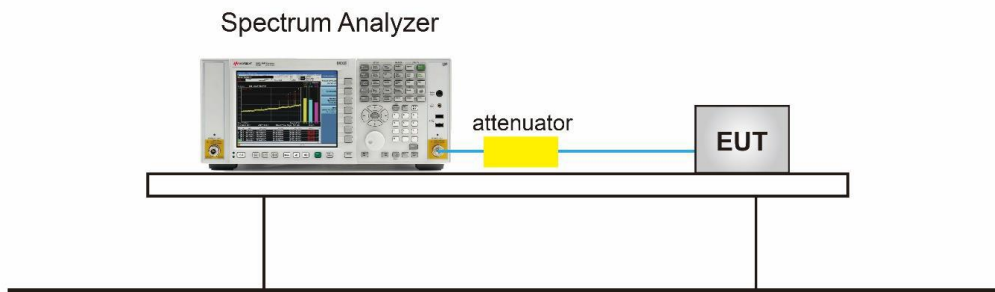

Any report having not been signed by authorized approver, or having been altered without authorization, or having not been stamped by the "Dedicated Testing/Inspection Stamp" is deemed to be invalid. Copying or excerpting portion of, or altering the content of the report is not permitted without the written authorization of AGC. The test results presented in the report apply only to the tested sample. Any objections to report issued by AGC should be submitted to AGC within 15days after the issuance of the test report. Further enquiry of validity or verification of the test report should be addressed to AGC by agc01@agccert.com.

### 9.4 MEASUREMENT RESULTS

#### Test Graphs of Spurious Emissions in Non-Restricted Frequency Bands

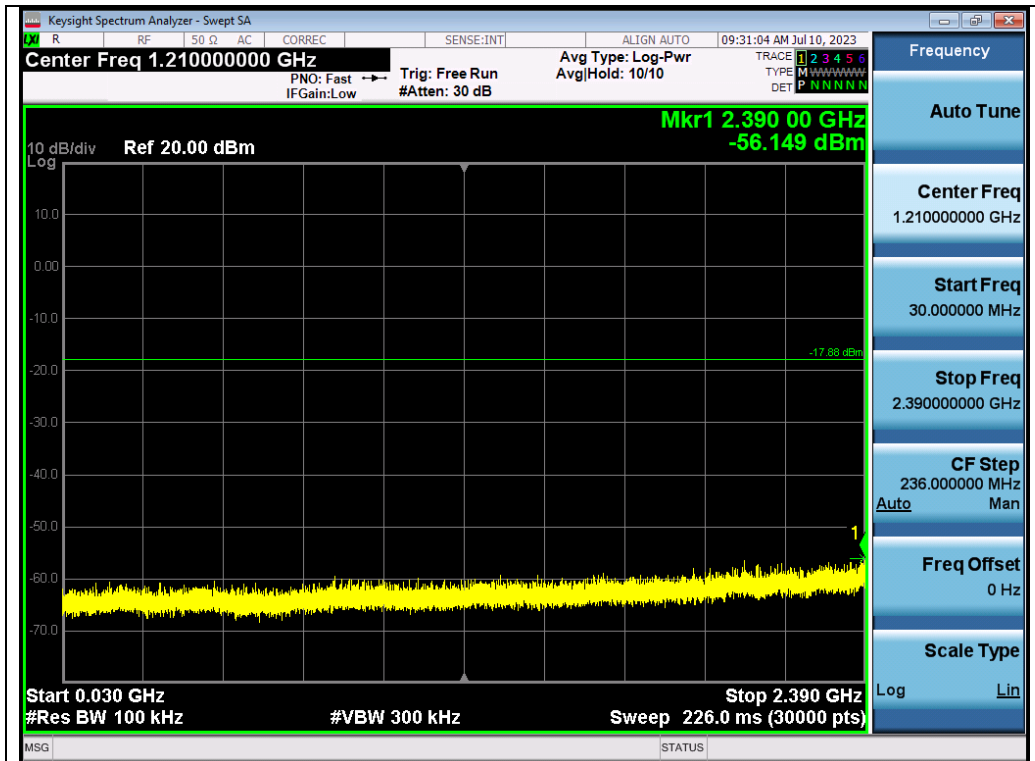

Test\_Graph\_802.11b\_ANT1\_2412\_1Mbps\_Lower Band Emissions

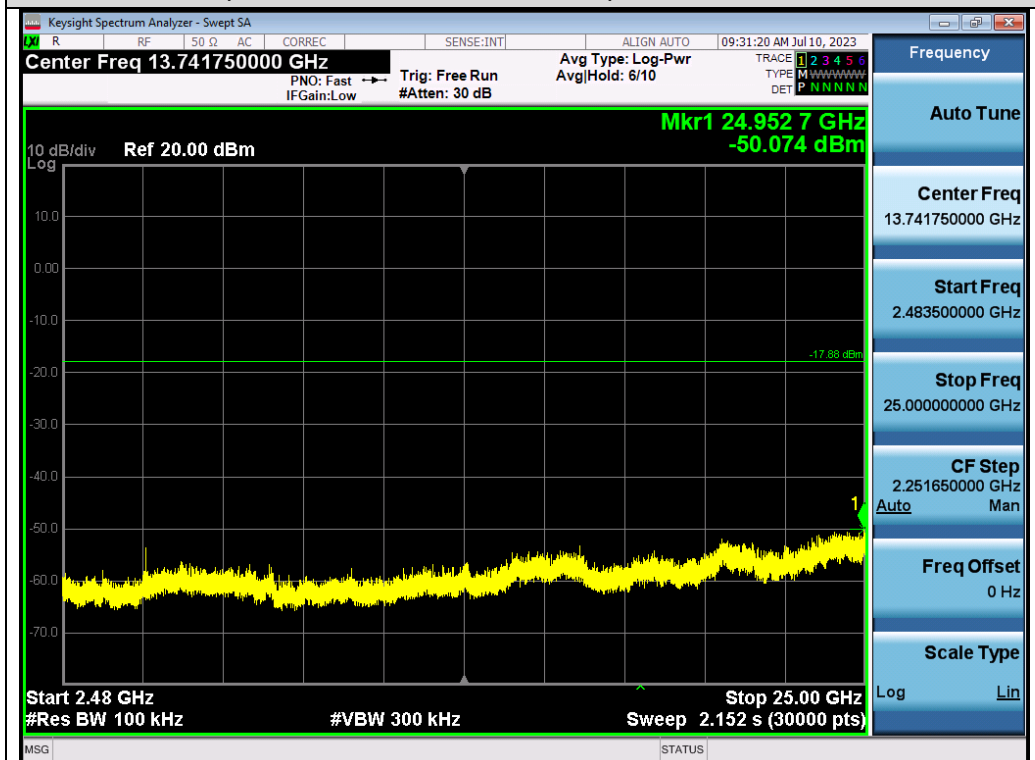

Test\_Graph\_802.11b\_ANT1\_2412\_1Mbps\_Higher Band Emissions

Any report having not been signed by authorized approver, or having been altered without authorization, or having not been stamped by the "Dedicated Testing/Inspection Stamp" is deemed to be invalid. Copying or excerpting portion of, or altering the content of the report is not permitted without the written authorization of AGC. The test results presented in the report apply only to the tested sample. Any objections to report issued by AGC should be submitted to AGC within 15days after the issuance of the test report. Further enquiry of validity or verification of the test report should be addressed to AGC by agc01@agccert.com.

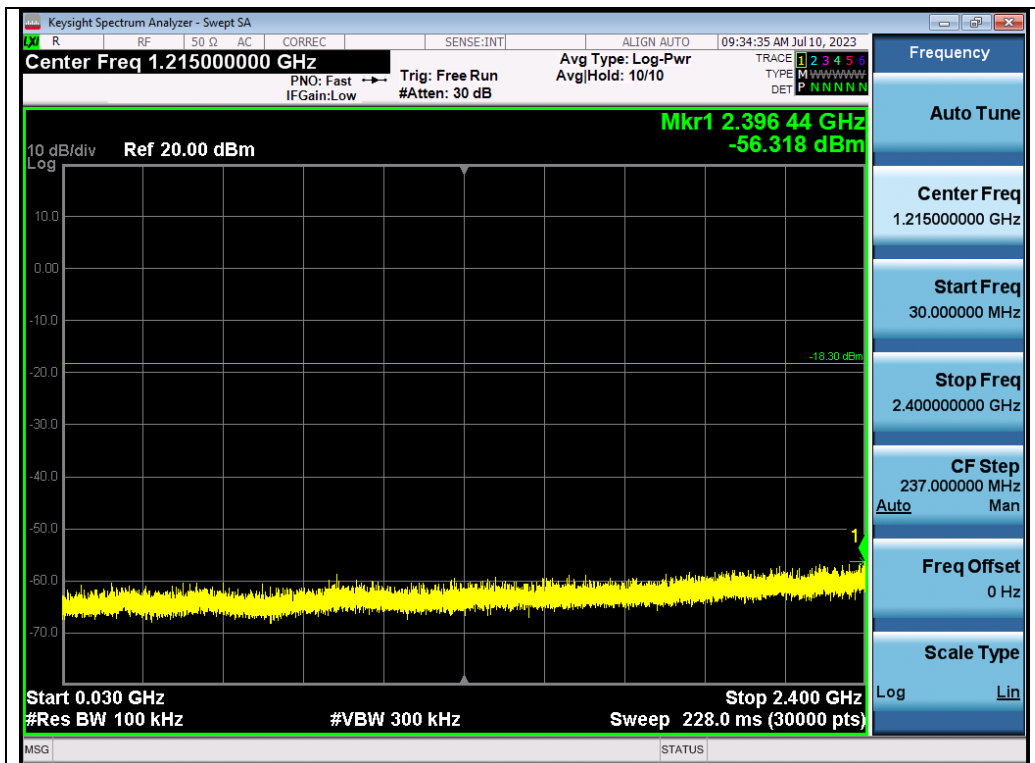

Test\_Graph\_802.11b\_ANT1\_2437\_1Mbps\_Lower Band Emissions

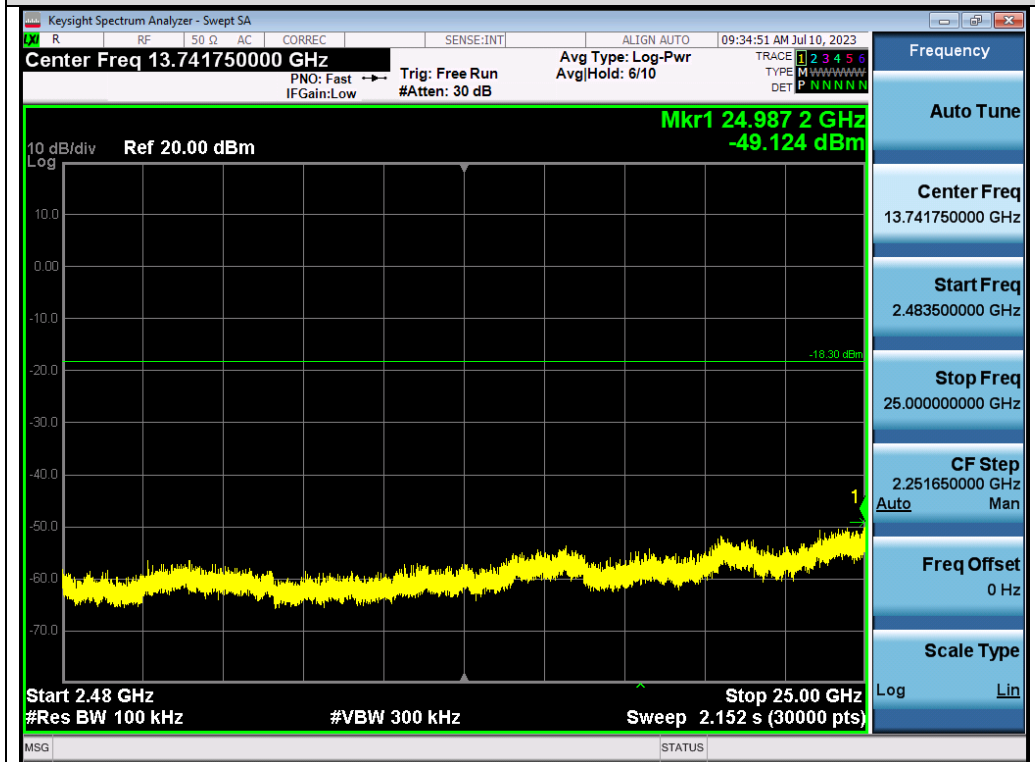

Test\_Graph\_802.11b\_ANT1\_2437\_1Mbps\_Higher Band Emissions

Any report having not been signed by authorized approver, or having been altered without authorization, or having not been stamped by the "Dedicated Testing/Inspection Stamp" is deemed to be invalid. Copying or excerpting portion of, or altering the content of the report is not permitted without the written authorization of AGC. The test results presented in the report apply only to the tested sample. Any objections to report issued by AGC should be submitted to AGC within 15days after the issuance of the test report. Further enquiry of validity or verification of the test report should be addressed to AGC by agc01@agccert.com.



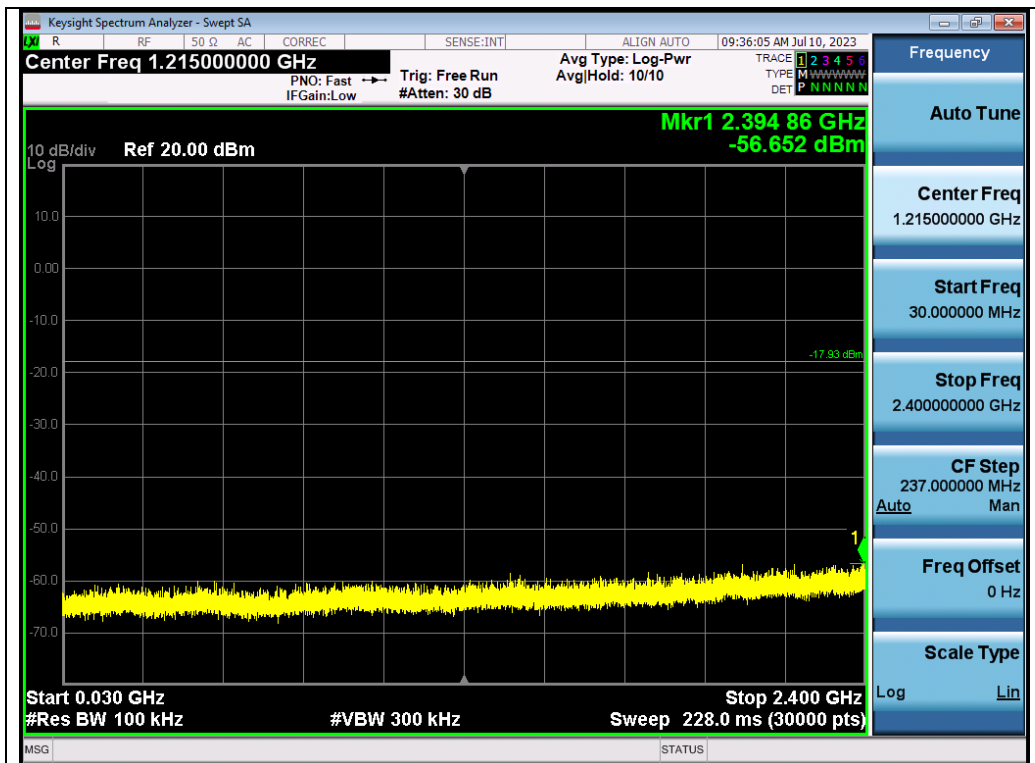

Test\_Graph\_802.11b\_ANT1\_2462\_1Mbps\_Lower Band Emissions

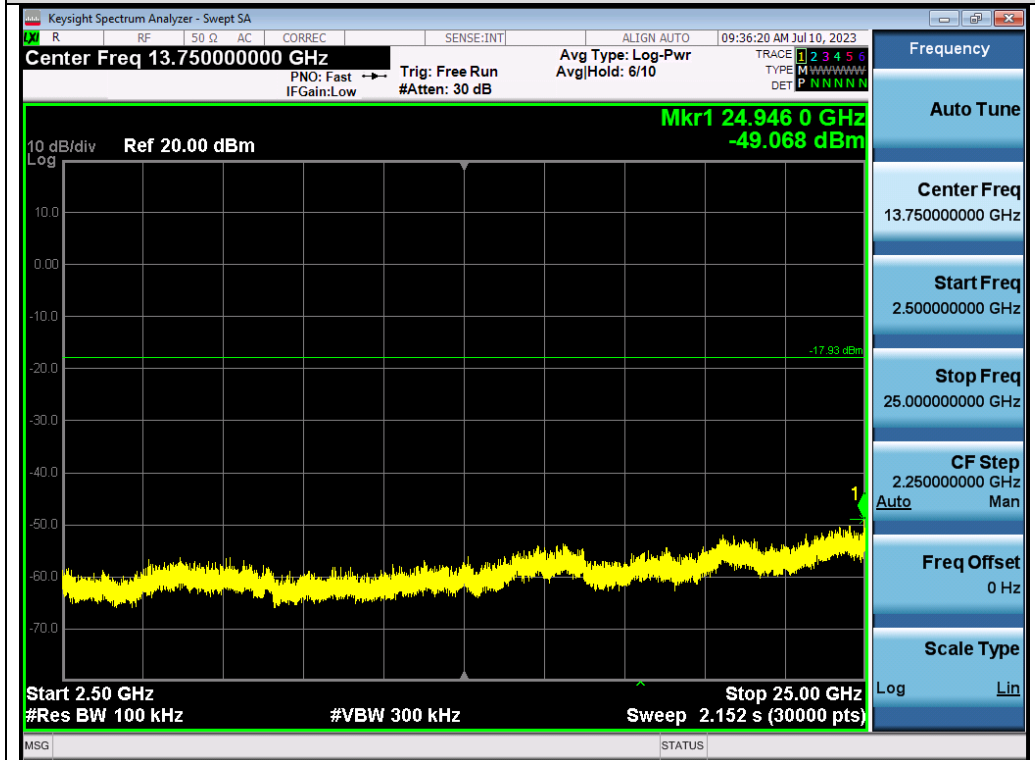

Test\_Graph\_802.11b\_ANT1\_2462\_1Mbps\_Higher Band Emissions

Any report having not been signed by authorized approver, or having been altered without authorization, or having not been stamped by the "Dedicated Testing/Inspection Stamp" is deemed to be invalid. Copying or excerpting portion of, or altering the content of the report is not permitted without the written authorization of AGC. The test results presented in the report apply only to the tested sample. Any objections to report issued by AGC should be submitted to AGC within 15days after the issuance of the test report. Further enquiry of validity or verification of the test report should be addressed to AGC by agc01@agccert.com.

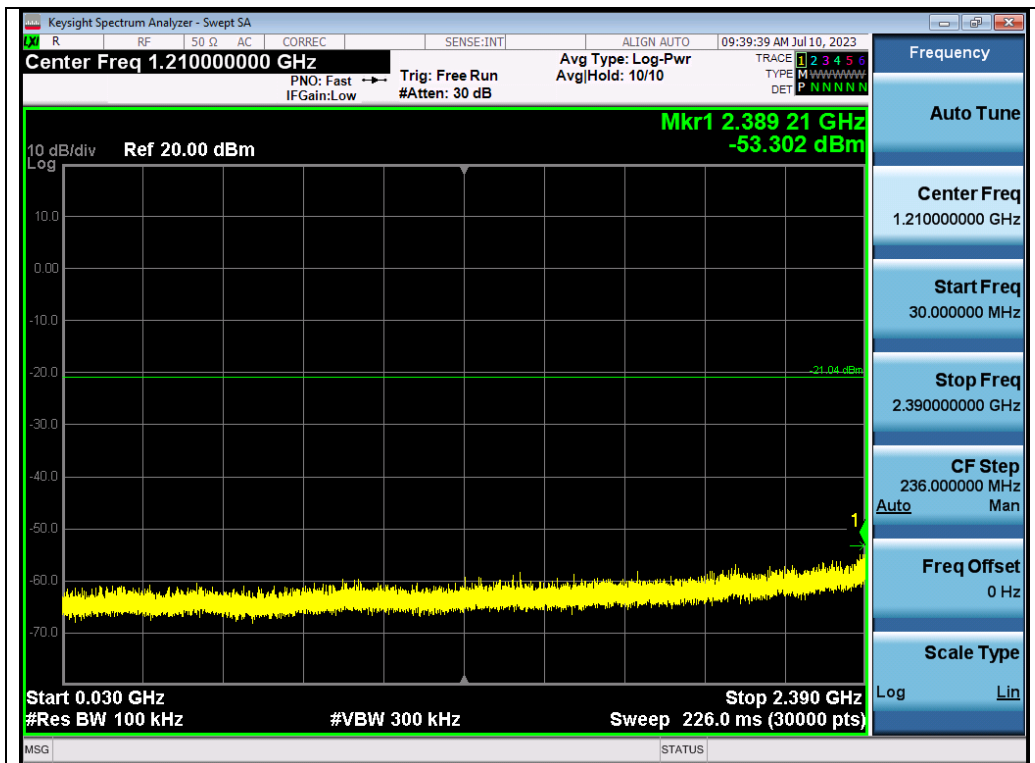

Test\_Graph\_802.11g\_ANT1\_2412\_6Mbps\_Lower Band Emissions

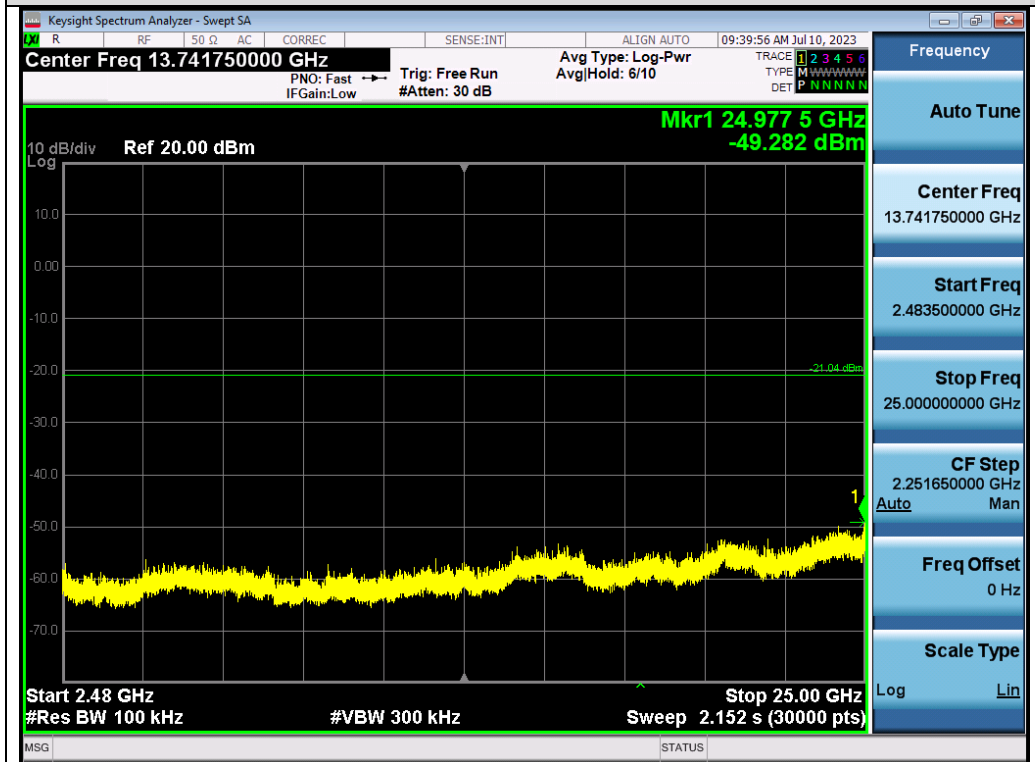

Test\_Graph\_802.11g\_ANT1\_2412\_6Mbps\_Higher Band Emissions

Any report having not been signed by authorized approver, or having been altered without authorization, or having not been stamped by the "Dedicated Testing/Inspection Stamp" is deemed to be invalid. Copying or excerpting portion of, or altering the content of the report is not permitted without the written authorization of AGC. The test results presented in the report apply only to the tested sample. Any objections to report issued by AGC should be submitted to AGC within 15days after the issuance of the test report. Further enquiry of validity or verification of the test report should be addressed to AGC by agc01@agccert.com.

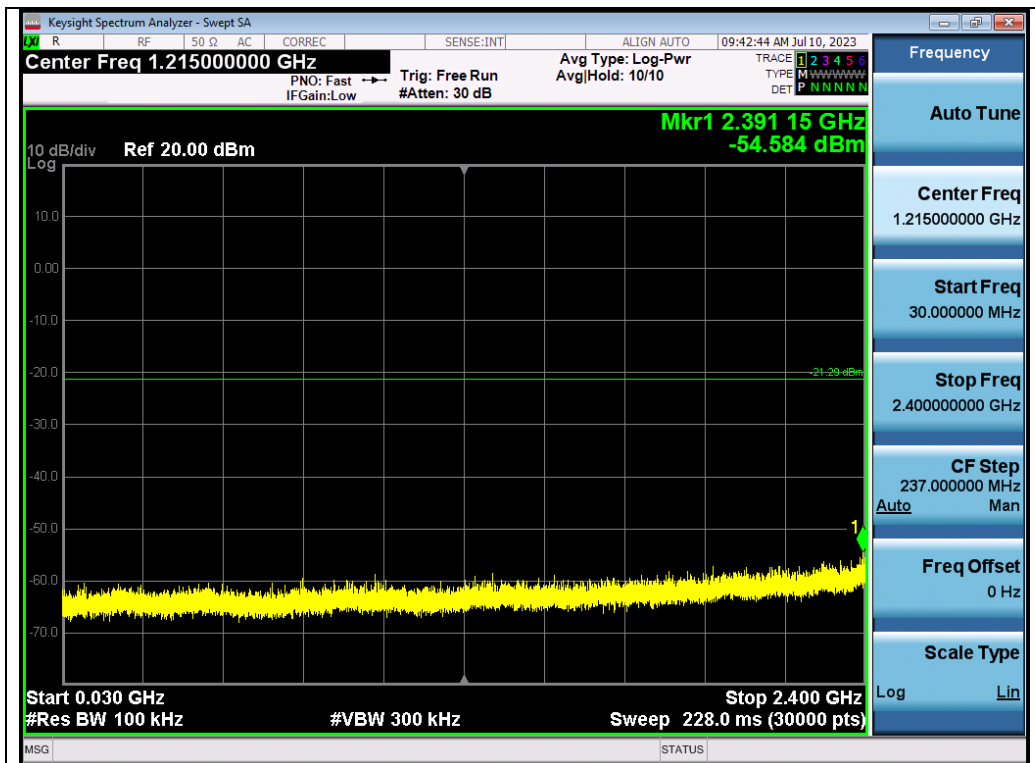

Test\_Graph\_802.11g\_ANT1\_2437\_6Mbps\_Lower Band Emissions

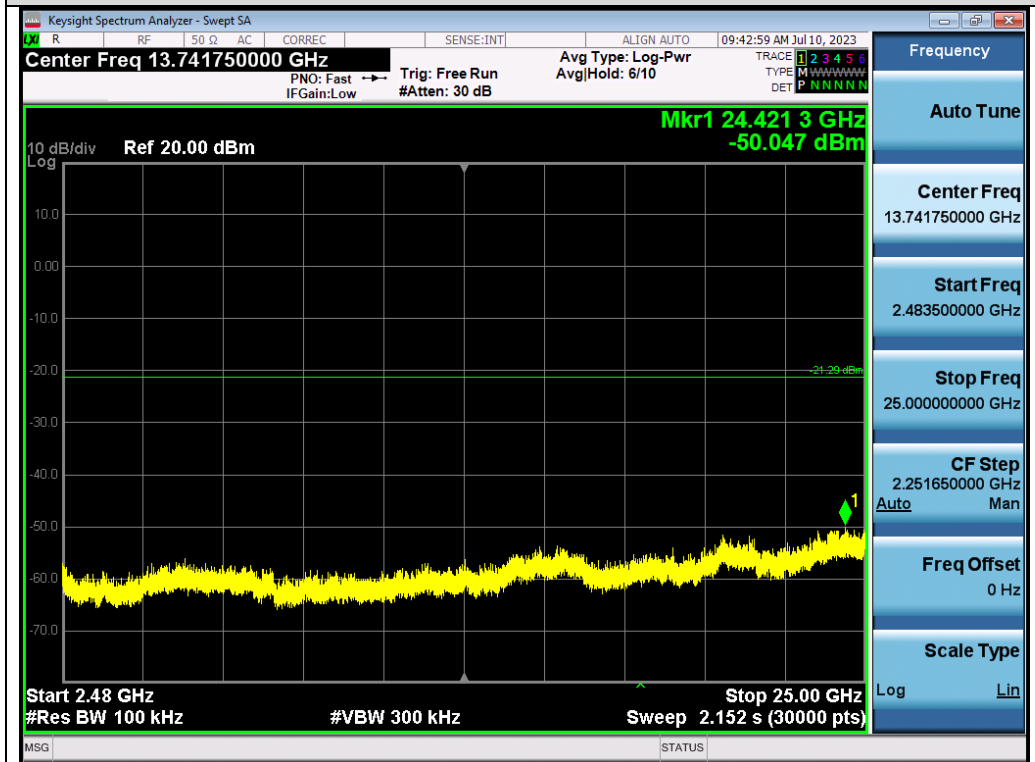

Test\_Graph\_802.11g\_ANT1\_2437\_6Mbps\_Higher Band Emissions

Any report having not been signed by authorized approver, or having been altered without authorization, or having not been stamped by the "Dedicated Testing/Inspection Stamp" is deemed to be invalid. Copying or excerpting portion of, or altering the content of the report is not permitted without the written authorization of AGC. The test results presented in the report apply only to the tested sample. Any objections to report issued by AGC should be submitted to AGC within 15days after the issuance of the test report. Further enquiry of validity or verification of the test report should be addressed to AGC by agc01@agccert.com.

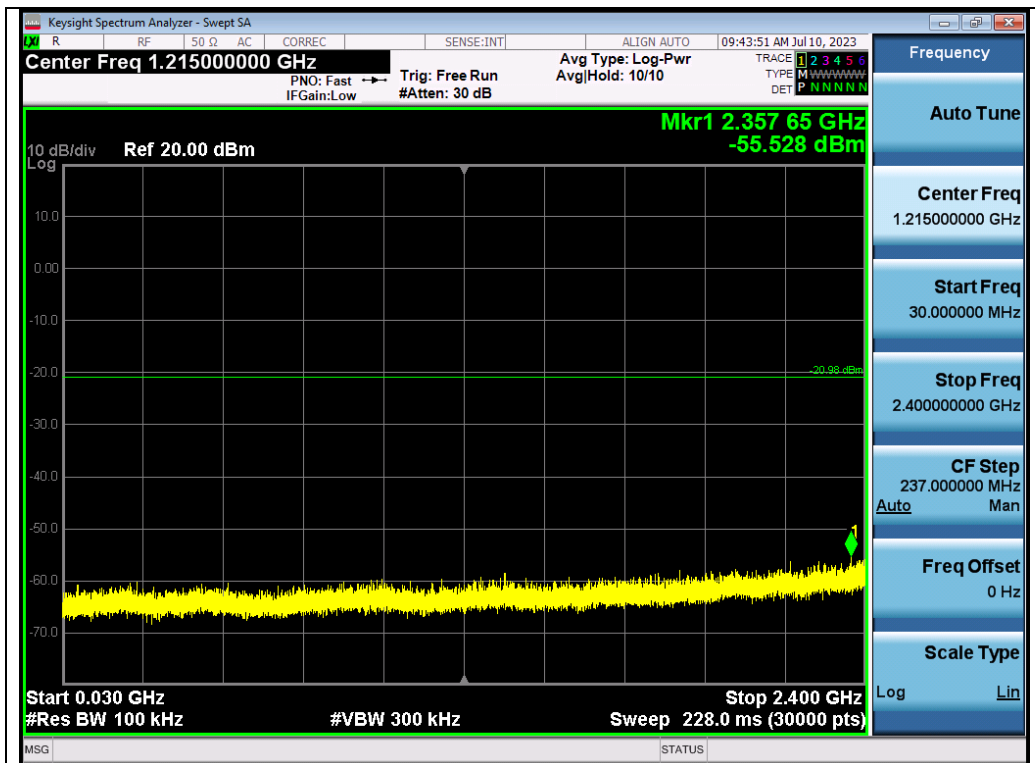

Test\_Graph\_802.11g\_ANT1\_2462\_6Mbps\_Lower Band Emissions

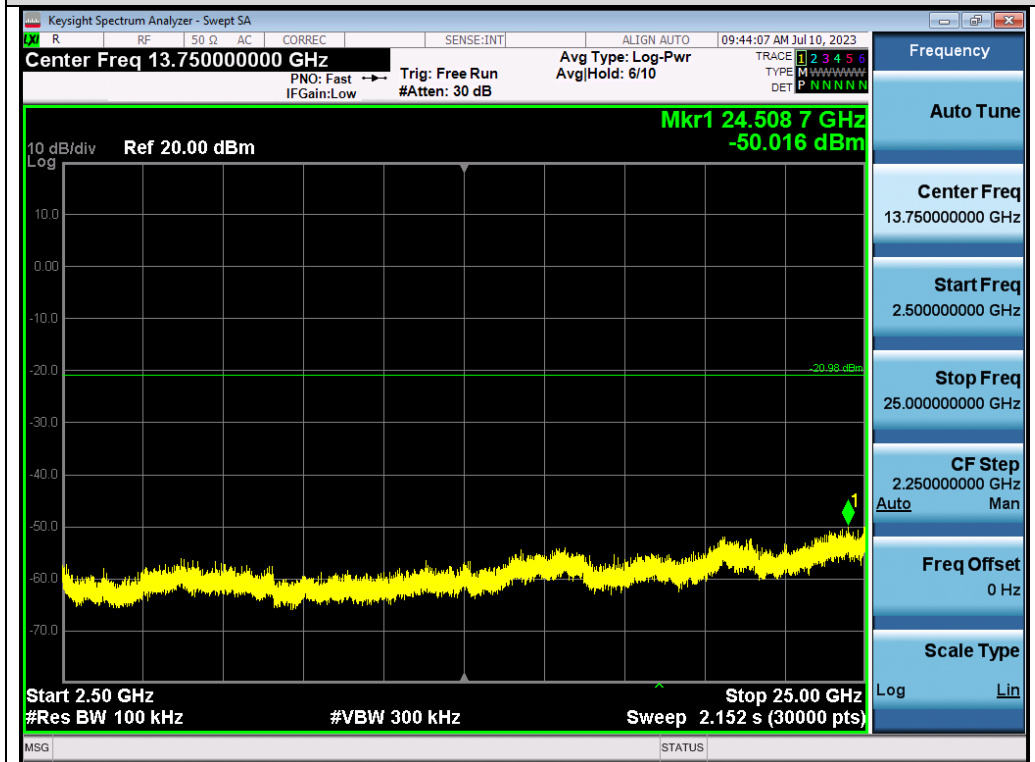

Test\_Graph\_802.11g\_ANT1\_2462\_6Mbps\_Higher Band Emissions

Any report having not been signed by authorized approver, or having been altered without authorization, or having not been stamped by the "Dedicated Testing/Inspection Stamp" is deemed to be invalid. Copying or excerpting portion of, or altering the content of the report is not permitted without the written authorization of AGC. The test results presented in the report apply only to the tested sample. Any objections to report issued by AGC should be submitted to AGC within 15days after the issuance of the test report. Further enquiry of validity or verification of the test report should be addressed to AGC by agc01@agccert.com.

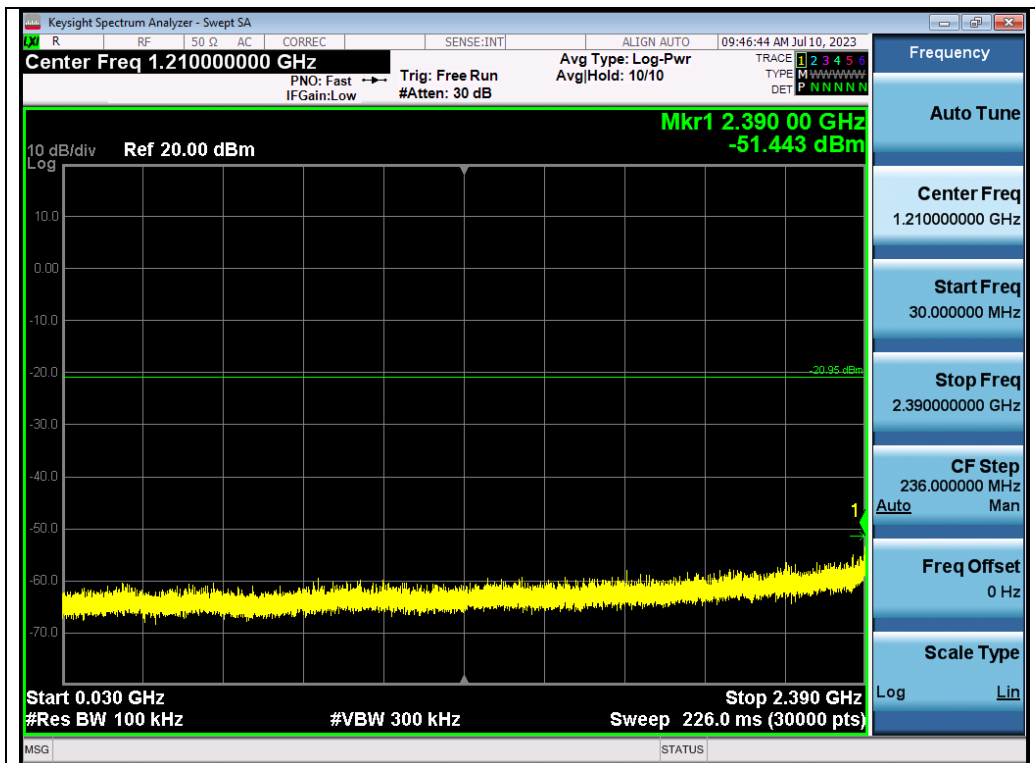

Test\_Graph\_802.11n20\_ANT1\_2412\_MCS0\_Lower Band Emissions

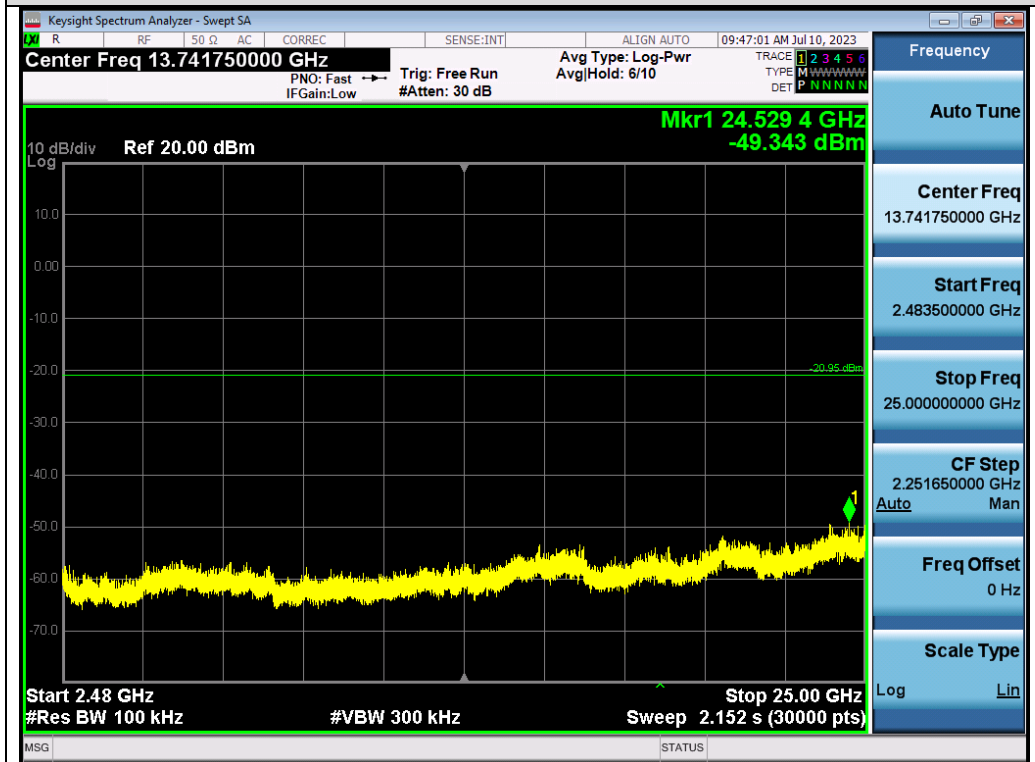

Test\_Graph\_802.11n20\_ANT1\_2412\_MCS0\_Higher Band Emissions

Any report having not been signed by authorized approver, or having been altered without authorization, or having not been stamped by the "Dedicated Testing/Inspection Stamp" is deemed to be invalid. Copying or excerpting portion of, or altering the content of the report is not permitted without the written authorization of AGC. The test results presented in the report apply only to the tested sample. Any objections to report issued by AGC should be submitted to AGC within 15days after the issuance of the test report. Further enquiry of validity or verification of the test report should be addressed to AGC by agc01@agccert.com.

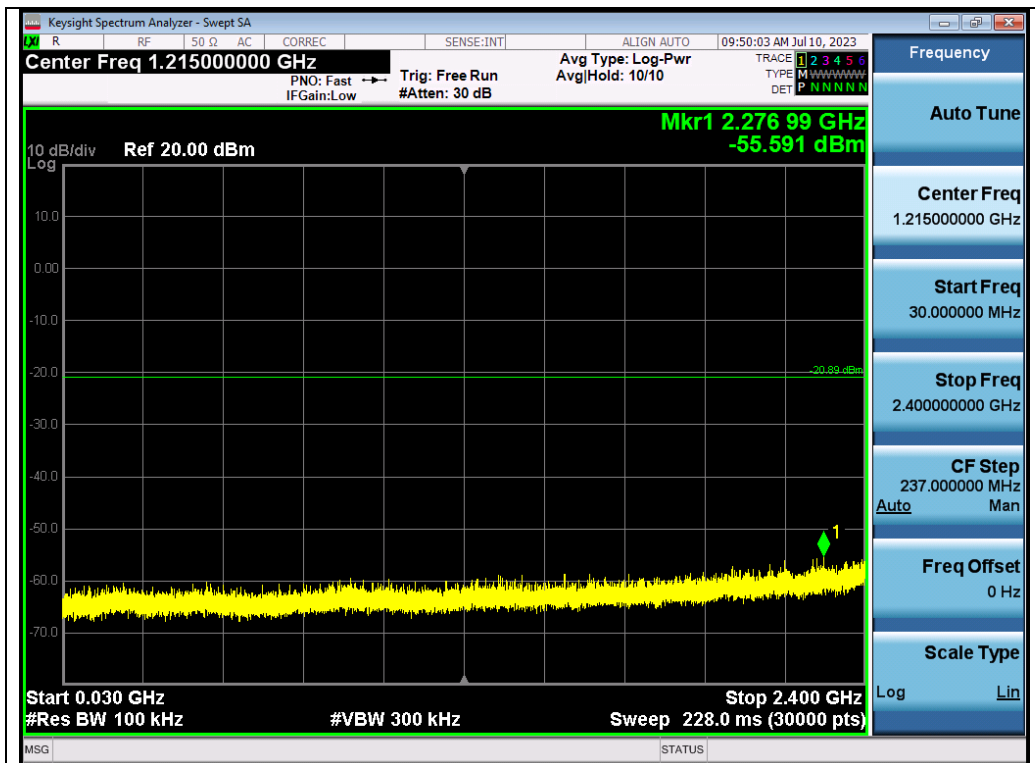

Test\_Graph\_802.11n20\_ANT1\_2437\_MCS0\_Lower Band Emissions

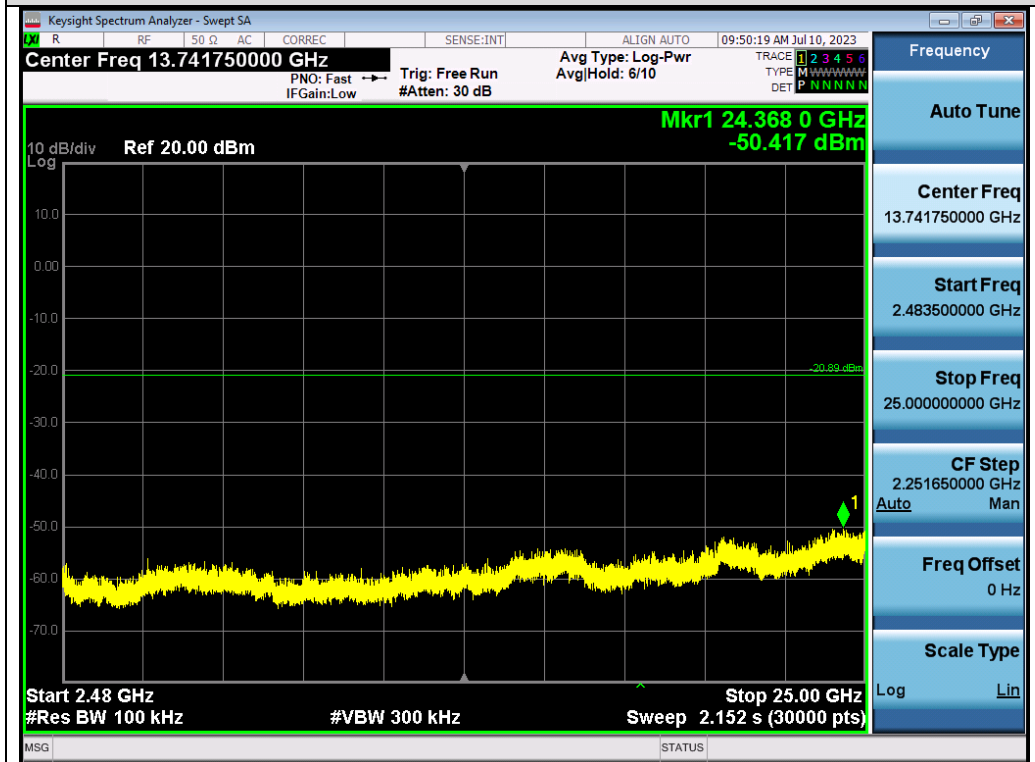

Test\_Graph\_802.11n20\_ANT1\_2437\_MCS0\_Higher Band Emissions

Any report having not been signed by authorized approver, or having been altered without authorization, or having not been stamped by the "Dedicated Testing/Inspection Stamp" is deemed to be invalid. Copying or excerpting portion of, or altering the content of the report is not permitted without the written authorization of AGC. The test results presented in the report apply only to the tested sample. Any objections to report issued by AGC should be submitted to AGC within 15days after the issuance of the test report. Further enquiry of validity or verification of the test report should be addressed to AGC by agc01@agccert.com.

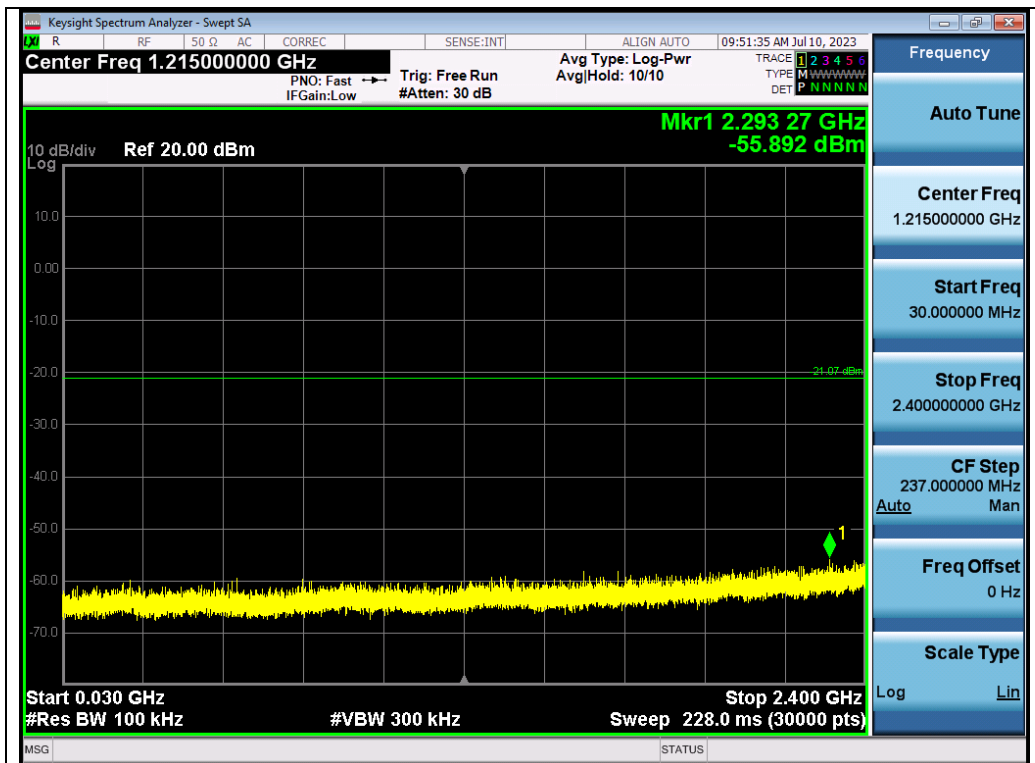

Test\_Graph\_802.11n20\_ANT1\_2462\_MCS0\_Lower Band Emissions

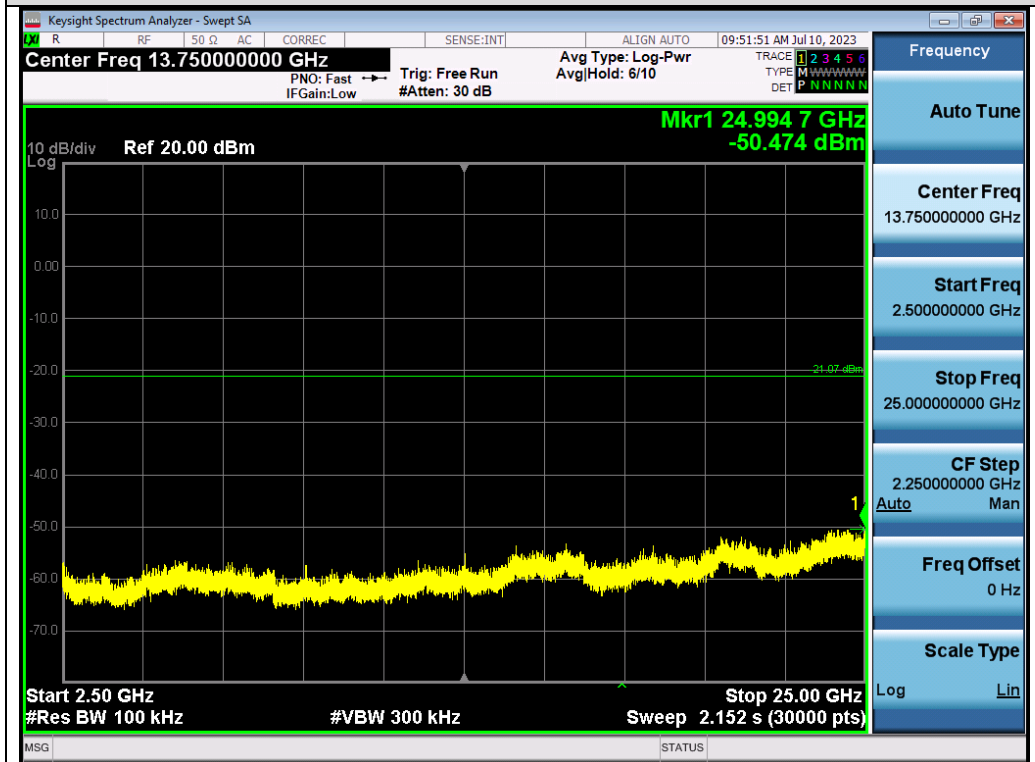

Test\_Graph\_802.11n20\_ANT1\_2462\_MCS0\_Higher Band Emissions

Any report having not been signed by authorized approver, or having been altered without authorization, or having not been stamped by the "Dedicated Testing/Inspection Stamp" is deemed to be invalid. Copying or excerpting portion of, or altering the content of the report is not permitted without the written authorization of AGC. The test results presented in the report apply only to the tested sample. Any objections to report issued by AGC should be submitted to AGC within 15days after the issuance of the test report. Further enquiry of validity or verification of the test report should be addressed to AGC by agc01@agccert.com.

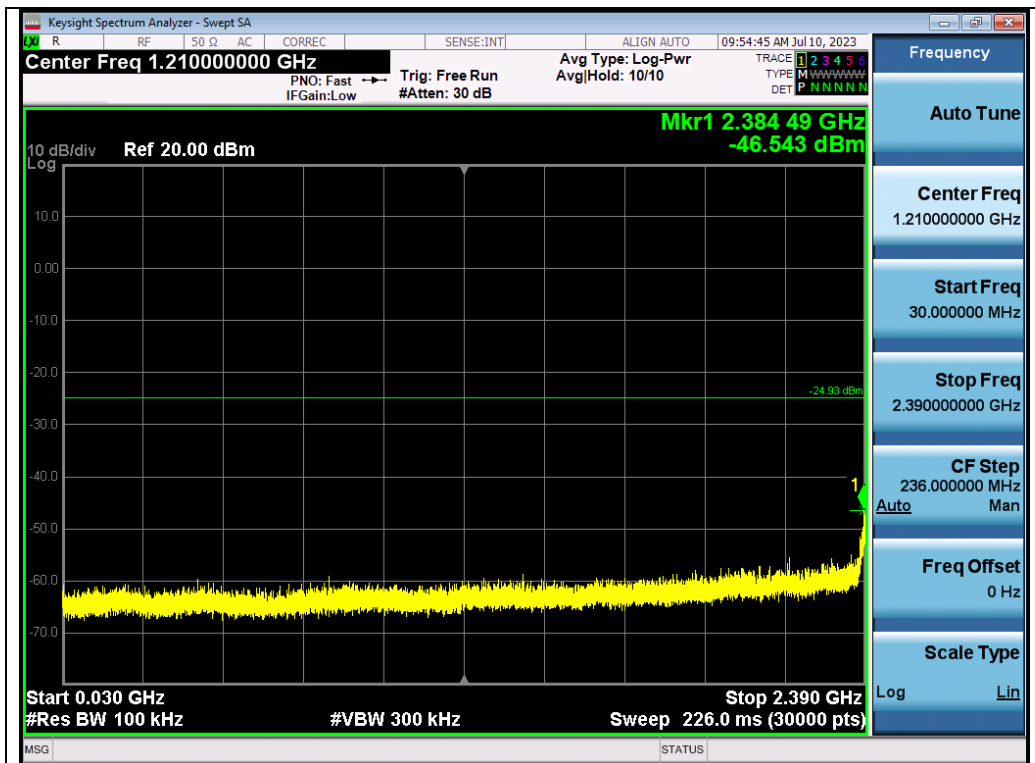

Test\_Graph\_802.11n40\_ANT1\_2422\_MCS0\_Lower Band Emissions

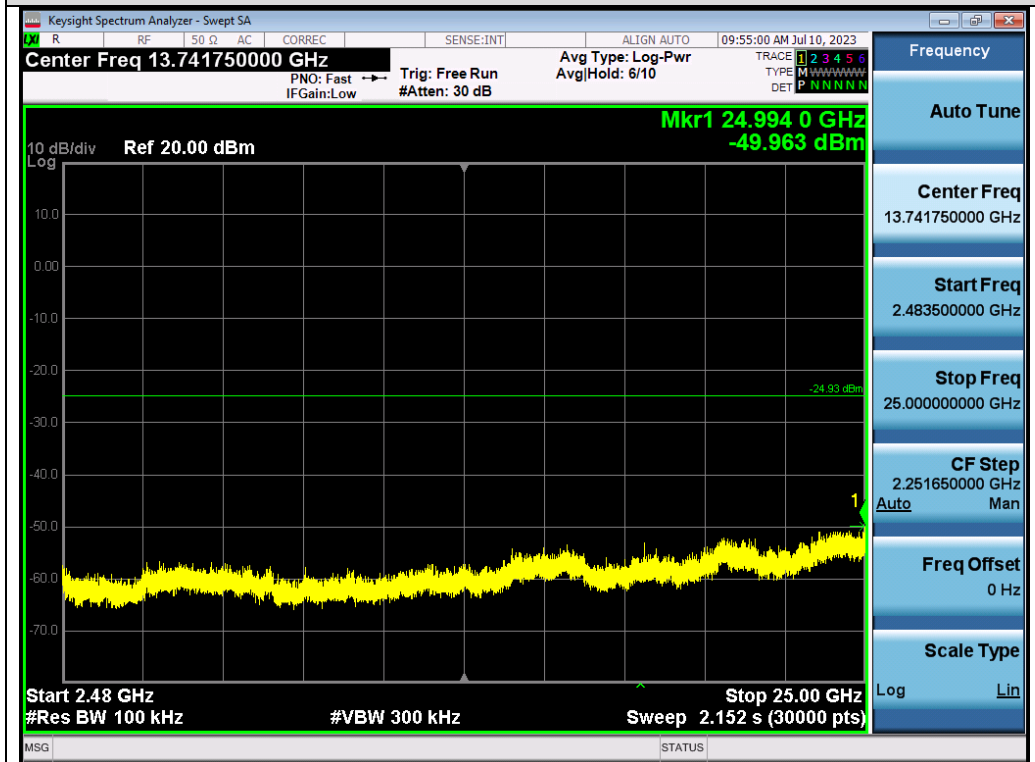

Test\_Graph\_802.11n40\_ANT1\_2422\_MCS0\_Higher Band Emissions

Any report having not been signed by authorized approver, or having been altered without authorization, or having not been stamped by the "Dedicated Testing/Inspection Stamp" is deemed to be invalid. Copying or excerpting portion of, or altering the content of the report is not permitted without the written authorization of AGC. The test results presented in the report apply only to the tested sample. Any objections to report issued by AGC should be submitted to AGC within 15days after the issuance of the test report. Further enquiry of validity or verification of the test report should be addressed to AGC by agc01@agccert.com.



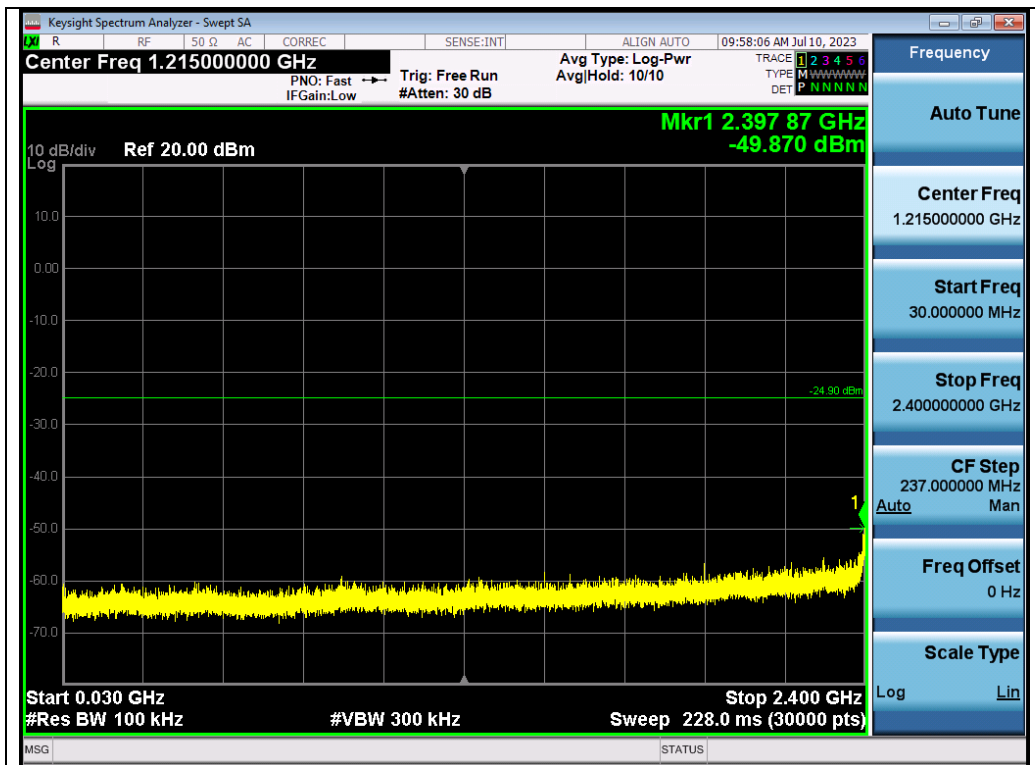

Test\_Graph\_802.11n40\_ANT1\_2437\_MCS0\_Lower Band Emissions

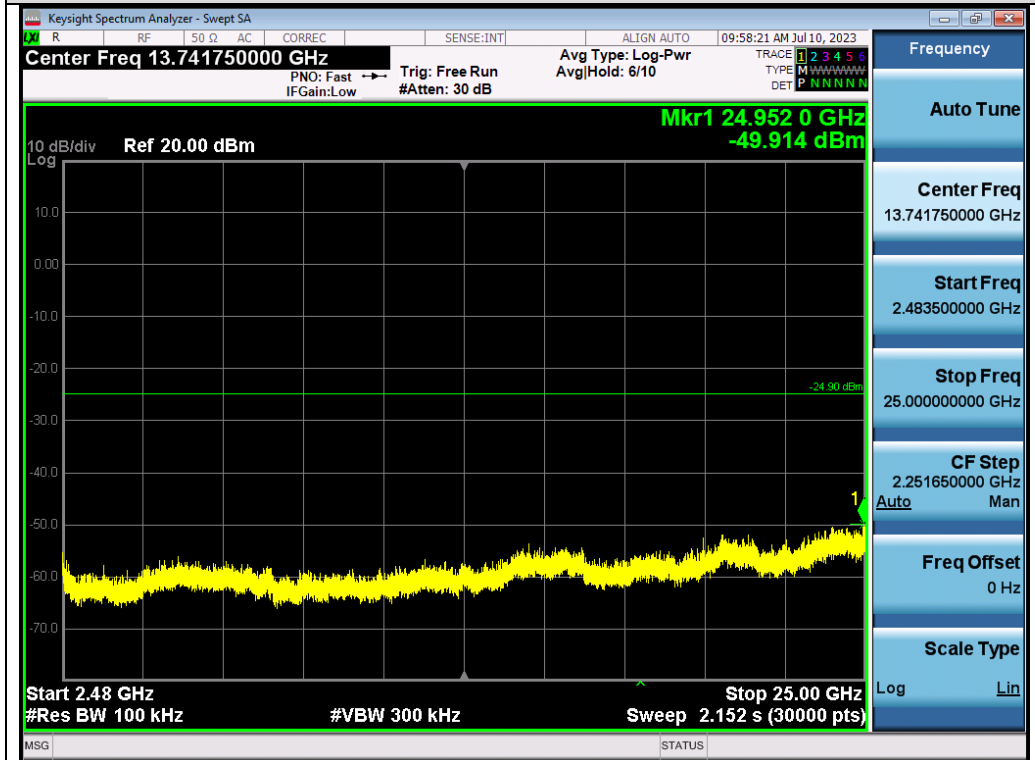

Test\_Graph\_802.11n40\_ANT1\_2437\_MCS0\_Higher Band Emissions

Any report having not been signed by authorized approver, or having been altered without authorization, or having not been stamped by the "Dedicated Testing/Inspection Stamp" is deemed to be invalid. Copying or excerpting portion of, or altering the content of the report is not permitted without the written authorization of AGC. The test results presented in the report apply only to the tested sample. Any objections to report issued by AGC should be submitted to AGC within 15days after the issuance of the test report. Further enquiry of validity or verification of the test report should be addressed to AGC by agc01@agccert.com.

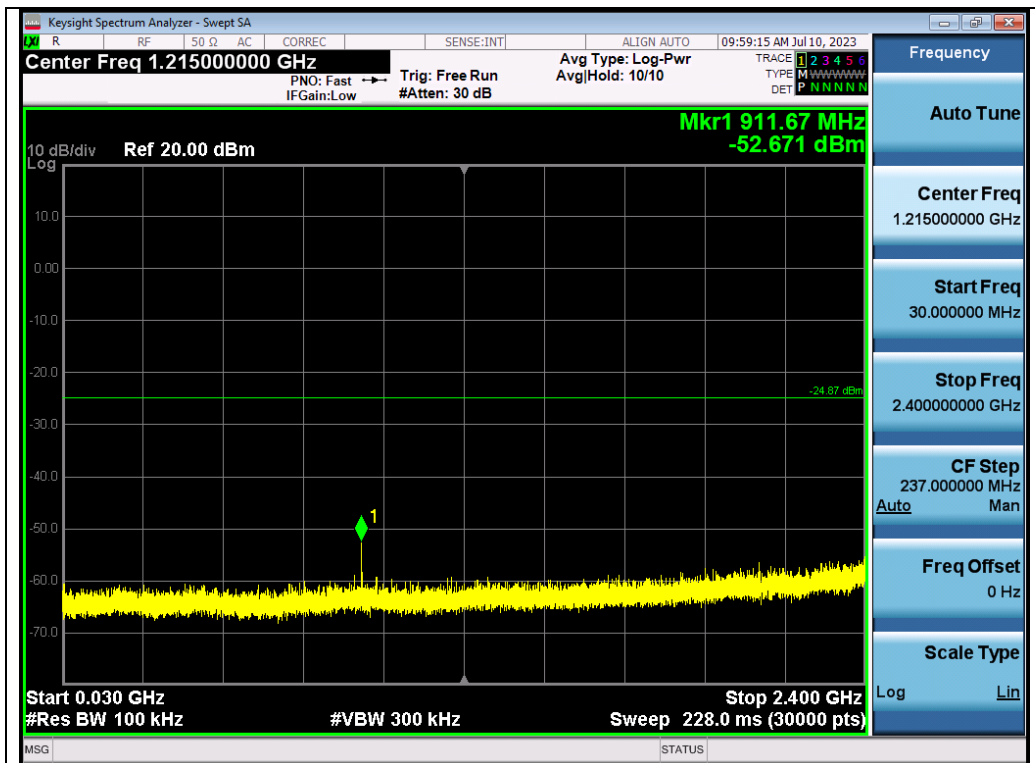

Test\_Graph\_802.11n40\_ANT1\_2452\_MCS0\_Lower Band Emissions

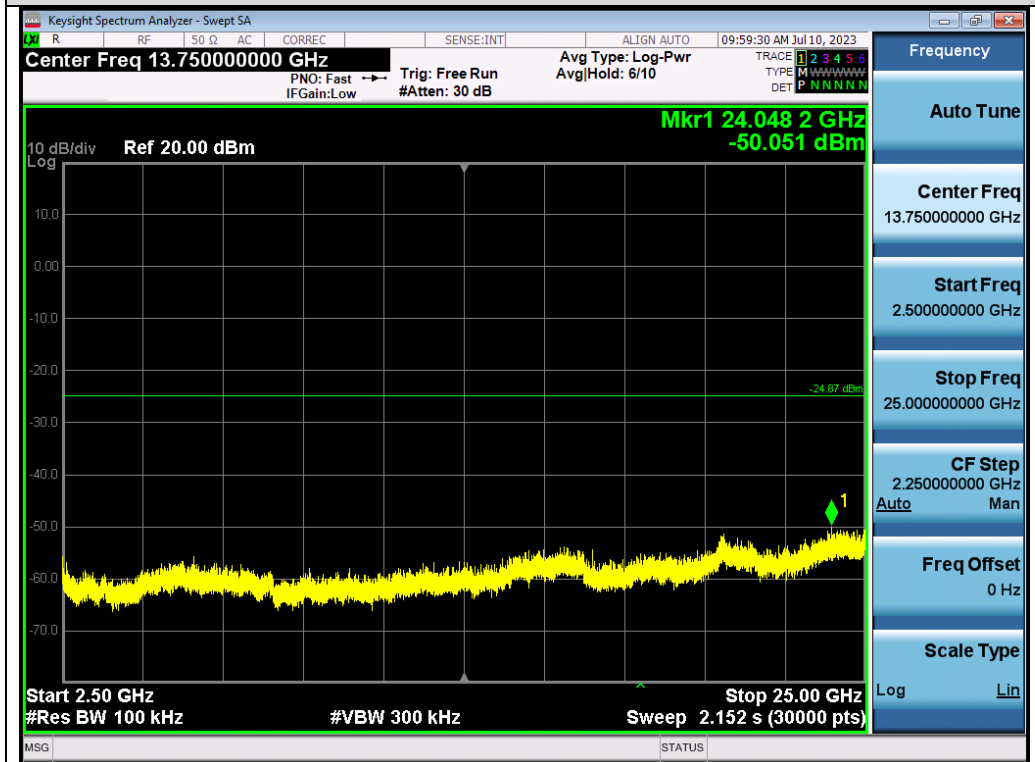

Test\_Graph\_802.11n40\_ANT1\_2452\_MCS0\_Higher Band Emissions

Any report having not been signed by authorized approver, or having been altered without authorization, or having not been stamped by the "Dedicated Testing/Inspection Stamp" is deemed to be invalid. Copying or excerpting portion of, or altering the content of the report is not permitted without the written authorization of AGC. The test results presented in the report apply only to the tested sample. Any objections to report issued by AGC should be submitted to AGC within 15days after the issuance of the test report. Further enquiry of validity or verification of the test report should be addressed to AGC by agc01@agccert.com.

**Test Graphs of Band Edge Emissions in Non-Restricted Frequency Bands**



Test\_Graph\_802.11b\_ANT1\_2412\_1Mbps\_Lower Band Edge Emissions

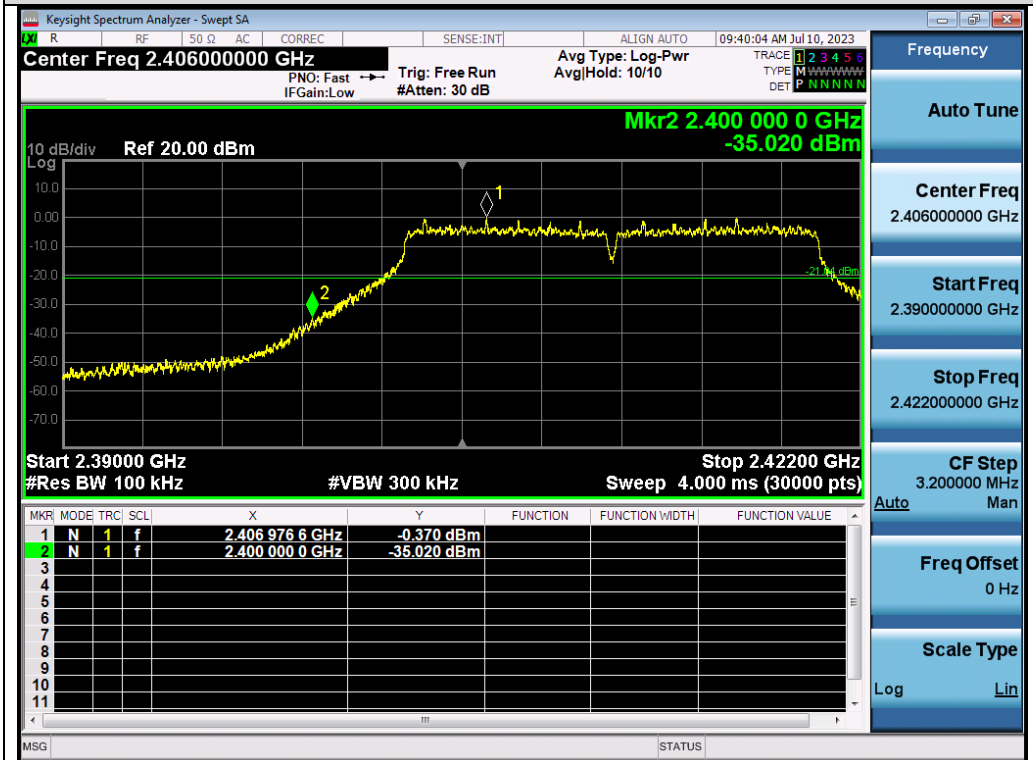

Test\_Graph\_802.11g\_ANT1\_2412\_6Mbps\_Lower Band Edge Emissions

Any report having not been signed by authorized approver, or having been altered without authorization, or having not been stamped by the "Dedicated Testing/Inspection Stamp" is deemed to be invalid. Copying or excerpting portion of, or altering the content of the report is not permitted without the written authorization of AGC. The test results presented in the report apply only to the tested sample. Any objections to report issued by AGC should be submitted to AGC within 15days after the issuance of the test report. Further enquiry of validity or verification of the test report should be addressed to AGC by agc01@agccert.com.

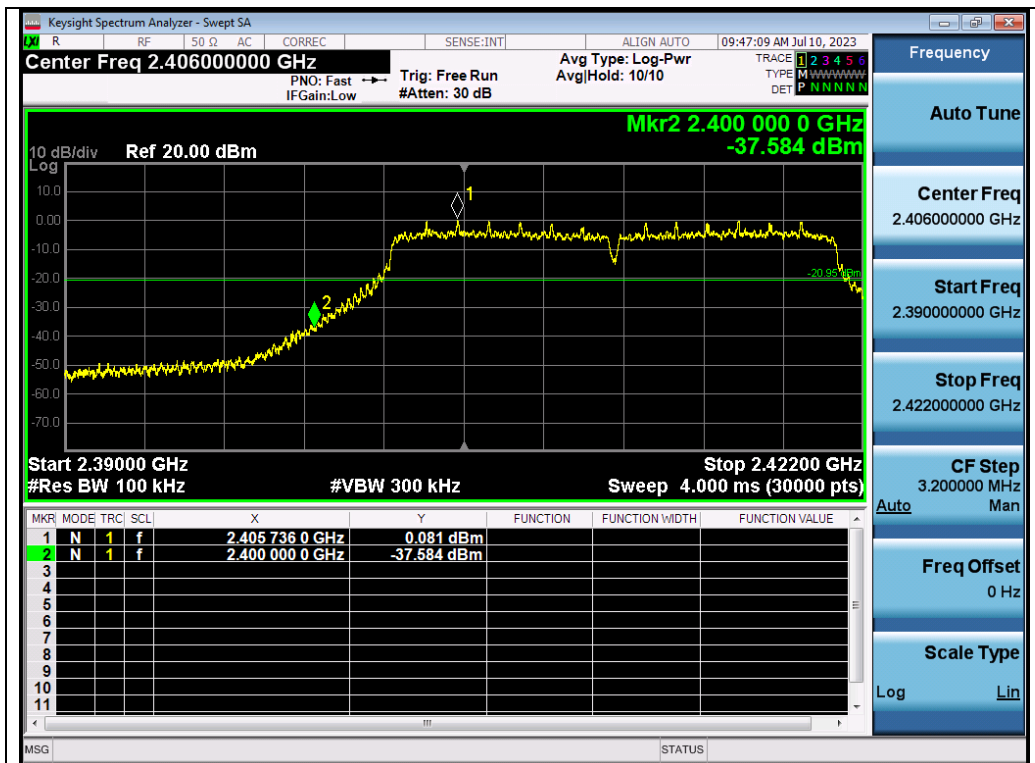

Test\_Graph\_802.11n20\_ANT1\_2412\_MCS0\_Lower Band Edge Emissions

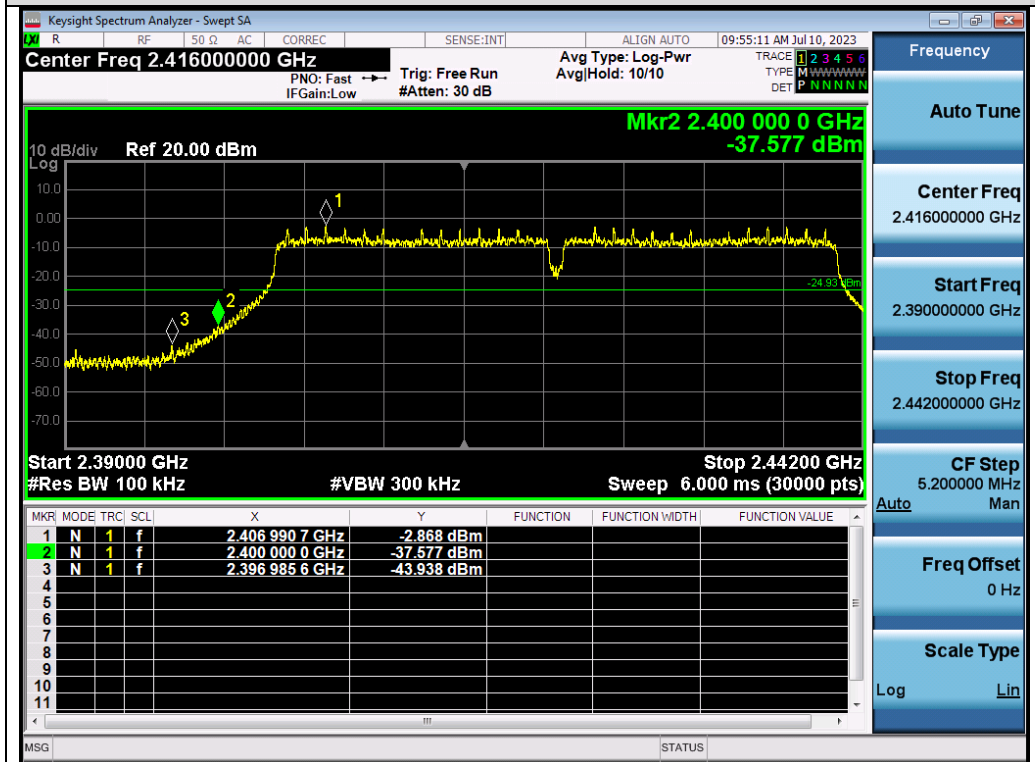

Test\_Graph\_802.11n40\_ANT1\_2422\_MCS0\_Lower Band Edge Emissions

Note: Emissions from 2483.5-2500MHz which fall in the restricted bands had been considered with the radiated emission limits specified.

Any report having not been signed by authorized approver, or having been altered without authorization, or having not been stamped by the "Dedicated Testing/Inspection Stamp" is deemed to be invalid. Copying or excerpting portion of, or altering the content of the report is not permitted without the written authorization of AGC. The test results presented in the report apply only to the tested sample. Any objections to report issued by AGC should be submitted to AGC within 15days after the issuance of the test report. Further enquiry of validity or verification of the test report should be addressed to AGC by agc01@agccert.com.

## 10. POWER SPECTRAL DENSITY

### 10.1 MEASUREMENT LIMITS

The transmitter power spectral density conducted from the transmitter to the antenna shall not be greater than 8 dBm in any 3 kHz band during any time interval of continuous transmission.

### 10.2 MEASUREMENT PROCEDURE

For Peak power spectral density test:

1. The testing follows the ANSI C63.10 Section 11.10.2 Method PKPSD.
2. Connect EUT RF output port to the Spectrum Analyzer through an RF attenuator
3. Set the RBW = 20 kHz.
4. Set the VBW  $\geq [3 \times \text{RBW}]$ .
5. Set the Span  $\geq [1.5 \times \text{DTS bandwidth}]$ .
6. Sweep time=Auto couple.
7. Detector function=Peak.
8. Trace Mode=Max hold.
9. When the measurement bandwidth of Maximum PSD is specified in 3 kHz, add a constant factor  $10 \cdot \log(3\text{kHz}/20\text{kHz}) = -8.23 \text{ dB}$  to the measured result.
10. Allow trace to stabilize. Use the marker-to-peak function to set the marker to the peak of the emission.
11. The indicated level is the peak output power, after any corrections for external attenuators and cables.

For Average power spectral density test:

1. The testing follows the ANSI C63.10 Section 11.10.5 Method AVPSD.
2. Connect EUT RF output port to the Spectrum Analyzer through an RF attenuator.
3. Set Span to at least 1.5 times the OBW.
4. Set RBW to:  $3 \text{ kHz} \leq \text{RBW} \leq 100 \text{ kHz}$ .
5. Set  $\text{VBW} \geq [3 \times \text{RBW}]$ .
6. Sweep Time=Auto couple.
7. Detector function=RMS (i.e., power averaging).
8. Trace average at least 100 traces in power averaging (rms) mode.
9. When the measurement bandwidth of Maximum PSD is specified in 3 kHz, add a constant factor  $10 \cdot \log(3\text{kHz}/20\text{kHz}) = -8.23 \text{ dB}$  to the measured result.
10. Determine according to the duty cycle of the equipment: when it is less than 98%, follow the steps below.
11. Add  $[10 \log (1 / D)]$ , where D is the duty cycle, to the measured power to compute the average power during the actual transmission times (because the measurement represents an average over both the ON and OFF times of the transmission). For example, add  $[10 \log (1/0.25)] = 6 \text{ dB}$  if the duty cycle is 25%.
12. Record the test results in the report.

Any report having not been signed by authorized approver, or having been altered without authorization, or having not been stamped by the "Dedicated Testing/Inspection Stamp" is deemed to be invalid. Copying or excerpting portion of, or altering the content of the report is not permitted without the written authorization of AGC. The test results presented in the report apply only to the tested sample. Any objections to report issued by AGC should be submitted to AGC within 15 days after the issuance of the test report. Further enquiry of validity or verification of the test report should be addressed to AGC by [agc01@agccert.com](mailto:agc01@agccert.com).

### 10.3 MEASUREMENT SETUP (BLOCK DIAGRAM OF CONFIGURATION)

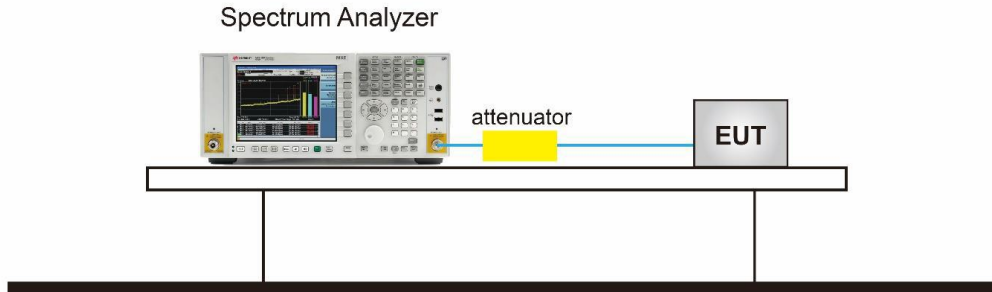

### 10.4 MEASUREMENT RESULT

Test Data of Conducted Output Power Spectral Density					
Test Mode	Test Channel (MHz)	Power density (dBm/20kHz)	Power density (dBm/3kHz)	Limit (dBm/3kHz)	Pass or Fail
802.11b	2412	-1.598	-9.837	≤8	Pass
	2437	-2.948	-11.187	≤8	Pass
	2462	-3.146	-11.385	≤8	Pass
802.11g	2412	-5.334	-13.573	≤8	Pass
	2437	-6.159	-14.398	≤8	Pass
	2462	-5.608	-13.847	≤8	Pass
802.11n20	2412	-6.475	-14.714	≤8	Pass
	2437	-6.415	-14.654	≤8	Pass
	2462	-6.397	-14.636	≤8	Pass
802.11n40	2422	-8.201	-16.44	≤8	Pass
	2437	-9.564	-17.803	≤8	Pass
	2452	-9.258	-17.497	≤8	Pass

Any report having not been signed by authorized approver, or having been altered without authorization, or having not been stamped by the “Dedicated Testing/Inspection Stamp” is deemed to be invalid. Copying or excerpting portion of, or altering the content of the report is not permitted without the written authorization of AGC. The test results presented in the report apply only to the tested sample. Any objections to report issued by AGC should be submitted to AGC within 15days after the issuance of the test report. Further enquiry of validity or verification of the test report should be addressed to AGC by agc01@agccert.com.

### Test Graphs of Conducted Output Power Spectral Density



Test\_Graph\_802.11b\_ANT1\_2412\_1Mbps\_PSD



Test\_Graph\_802.11b\_ANT1\_2437\_1Mbps\_PSD

Any report having not been signed by authorized approver, or having been altered without authorization, or having not been stamped by the "Dedicated Testing/Inspection Stamp" is deemed to be invalid. Copying or excerpting portion of, or altering the content of the report is not permitted without the written authorization of AGC. The test results presented in the report apply only to the tested sample. Any objections to report issued by AGC should be submitted to AGC within 15days after the issuance of the test report. Further enquiry of validity or verification of the test report should be addressed to AGC by agc01@agccert.com.



Test\_Graph\_802.11b\_ANT1\_2462\_1Mbps\_PSD

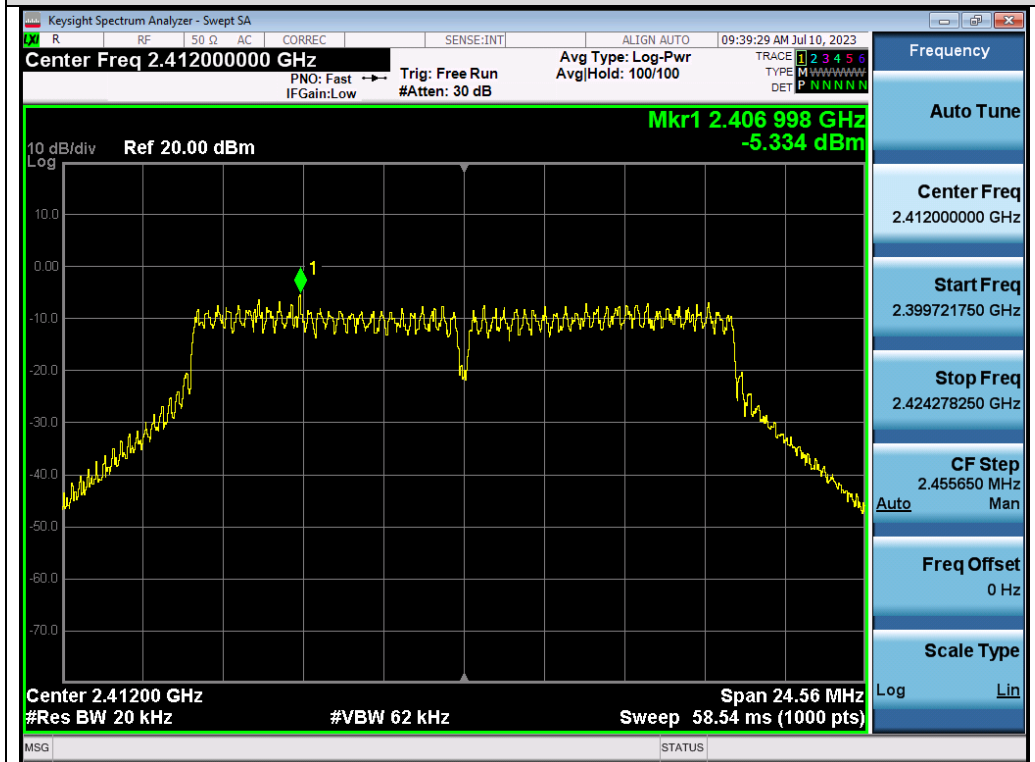

Test\_Graph\_802.11g\_ANT1\_2412\_6Mbps\_PSD

Any report having not been signed by authorized approver, or having been altered without authorization, or having not been stamped by the "Dedicated Testing/Inspection Stamp" is deemed to be invalid. Copying or excerpting portion of, or altering the content of the report is not permitted without the written authorization of AGC. The test results presented in the report apply only to the tested sample. Any objections to report issued by AGC should be submitted to AGC within 15days after the issuance of the test report. Further enquiry of validity or verification of the test report should be addressed to AGC by agc01@agccert.com.



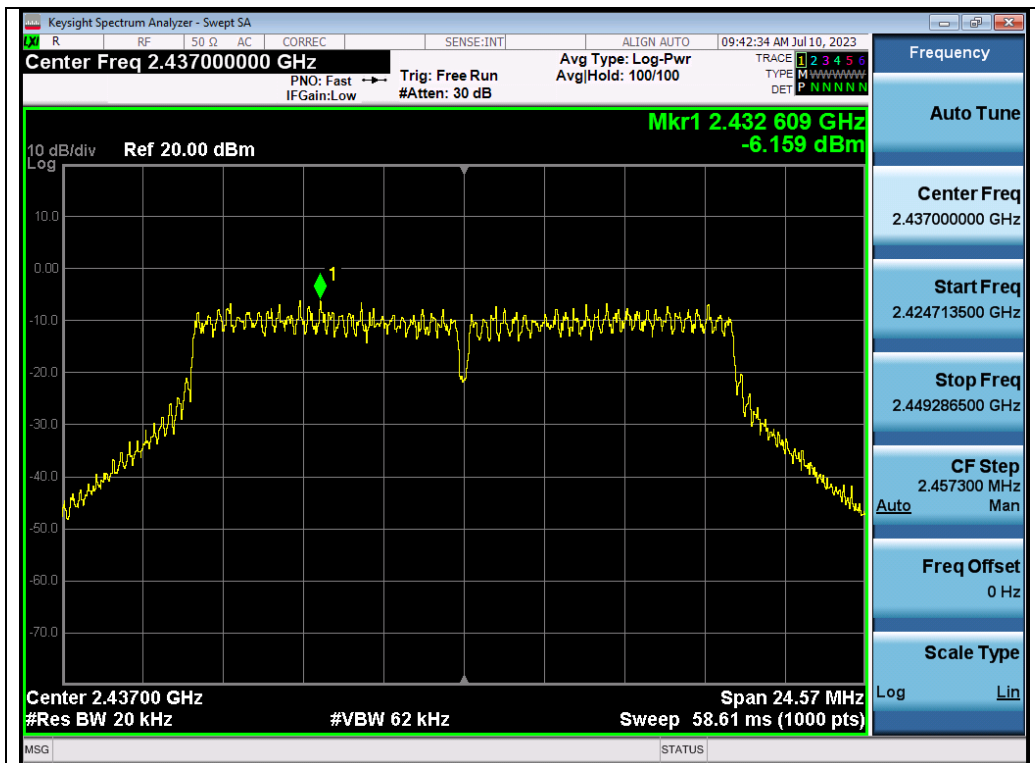

Test\_Graph\_802.11g\_ANT1\_2437\_6Mbps\_PSD

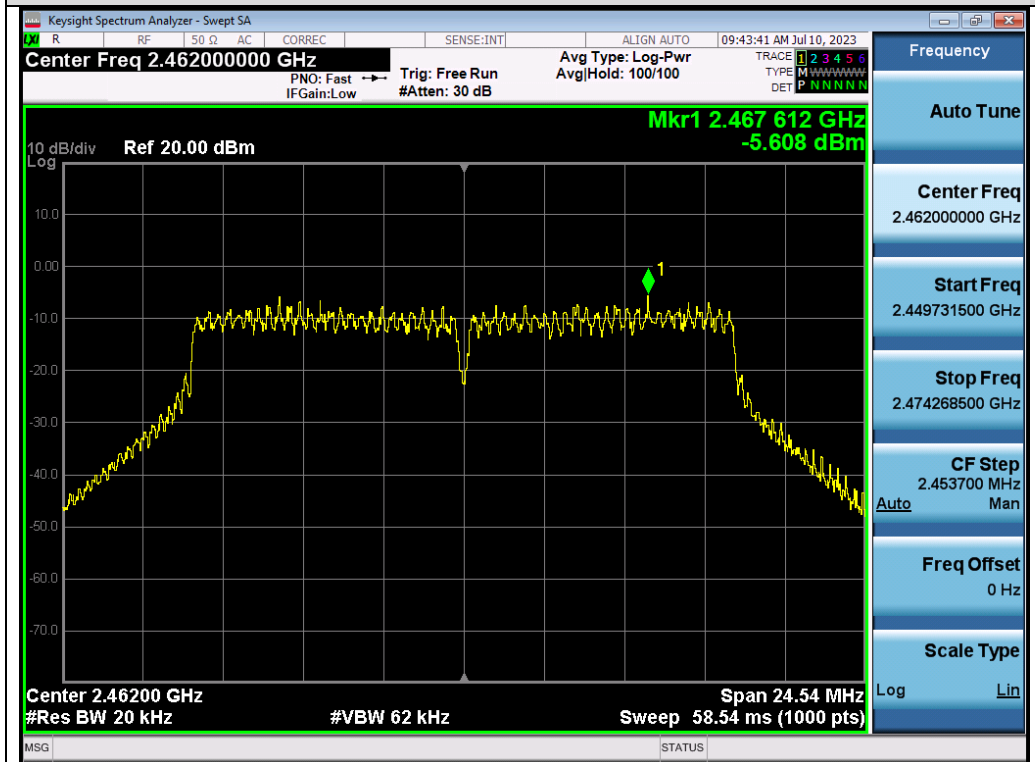

Test\_Graph\_802.11g\_ANT1\_2462\_6Mbps\_PSD

Any report having not been signed by authorized approver, or having been altered without authorization, or having not been stamped by the "Dedicated Testing/Inspection Stamp" is deemed to be invalid. Copying or excerpting portion of, or altering the content of the report is not permitted without the written authorization of AGC. The test results presented in the report apply only to the tested sample. Any objections to report issued by AGC should be submitted to AGC within 15days after the issuance of the test report. Further enquiry of validity or verification of the test report should be addressed to AGC by agc01@agccert.com.

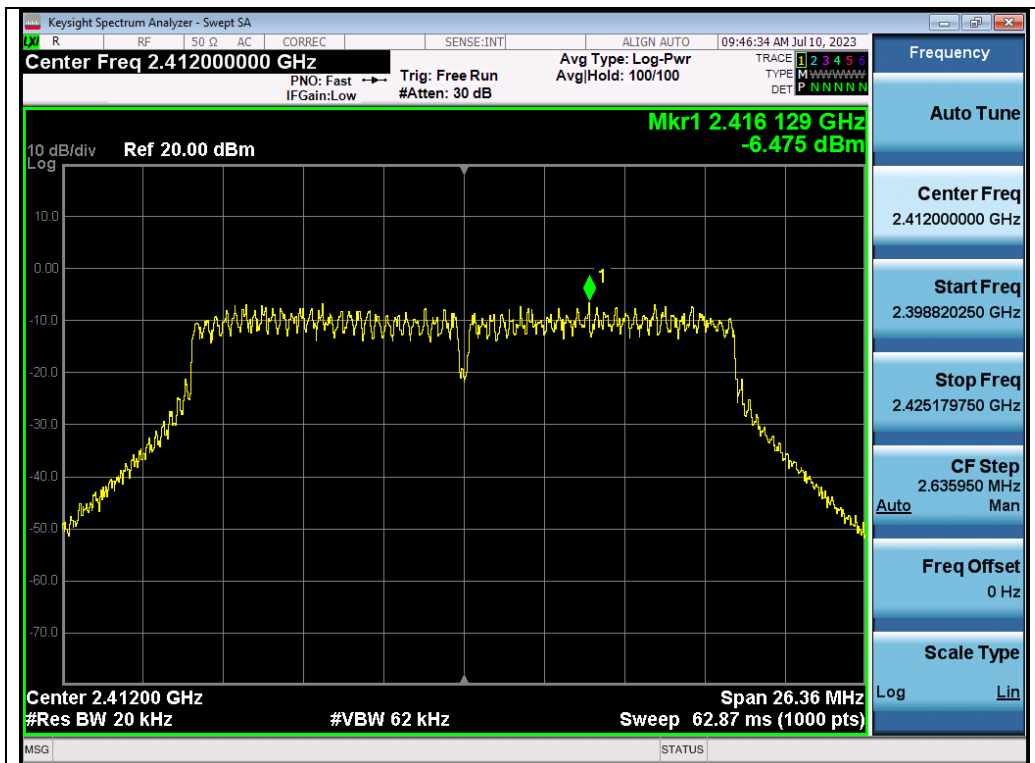

Test\_Graph\_802.11n20\_ANT1\_2412\_MCS0\_PSD

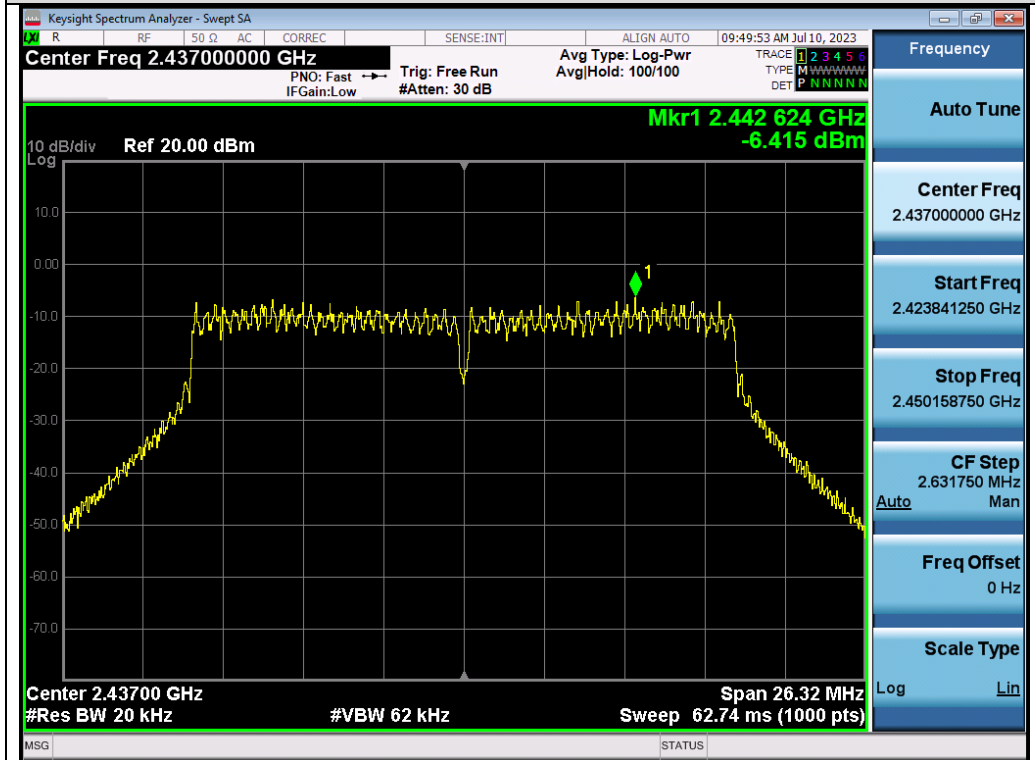

Test\_Graph\_802.11n20\_ANT1\_2437\_MCS0\_PSD

Any report having not been signed by authorized approver, or having been altered without authorization, or having not been stamped by the "Dedicated Testing/Inspection Stamp" is deemed to be invalid. Copying or excerpting portion of, or altering the content of the report is not permitted without the written authorization of AGC. The test results presented in the report apply only to the tested sample. Any objections to report issued by AGC should be submitted to AGC within 15days after the issuance of the test report. Further enquiry of validity or verification of the test report should be addressed to AGC by agc01@agccert.com.

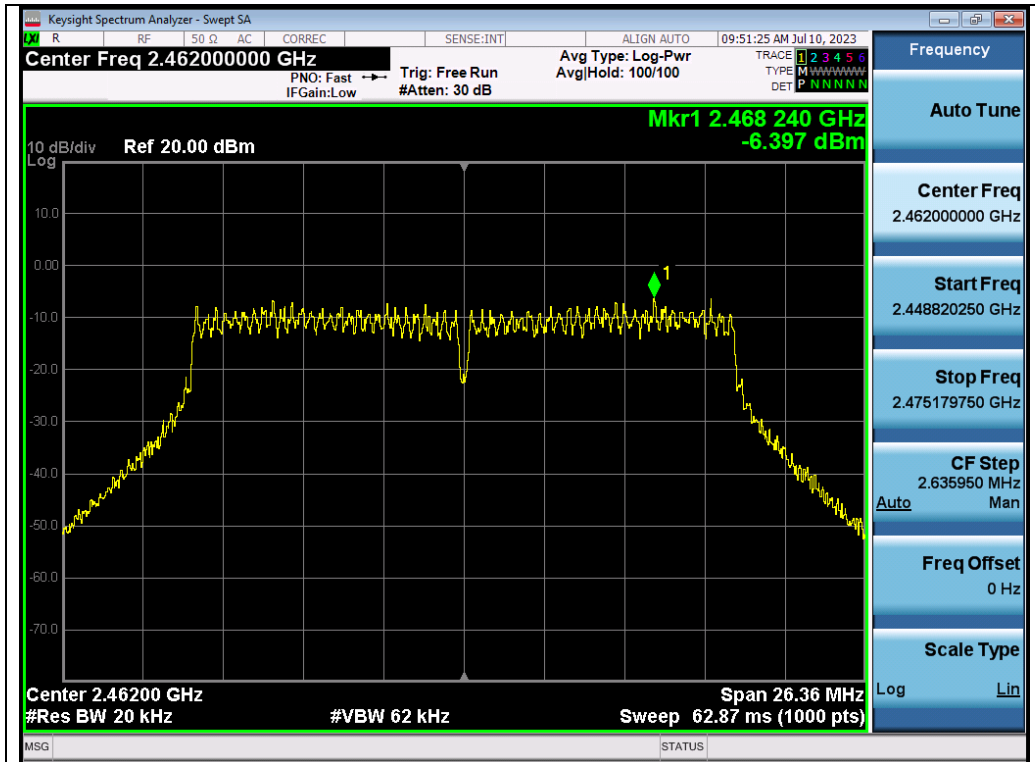

Test\_Graph\_802.11n20\_ANT1\_2462\_MCS0\_PSD

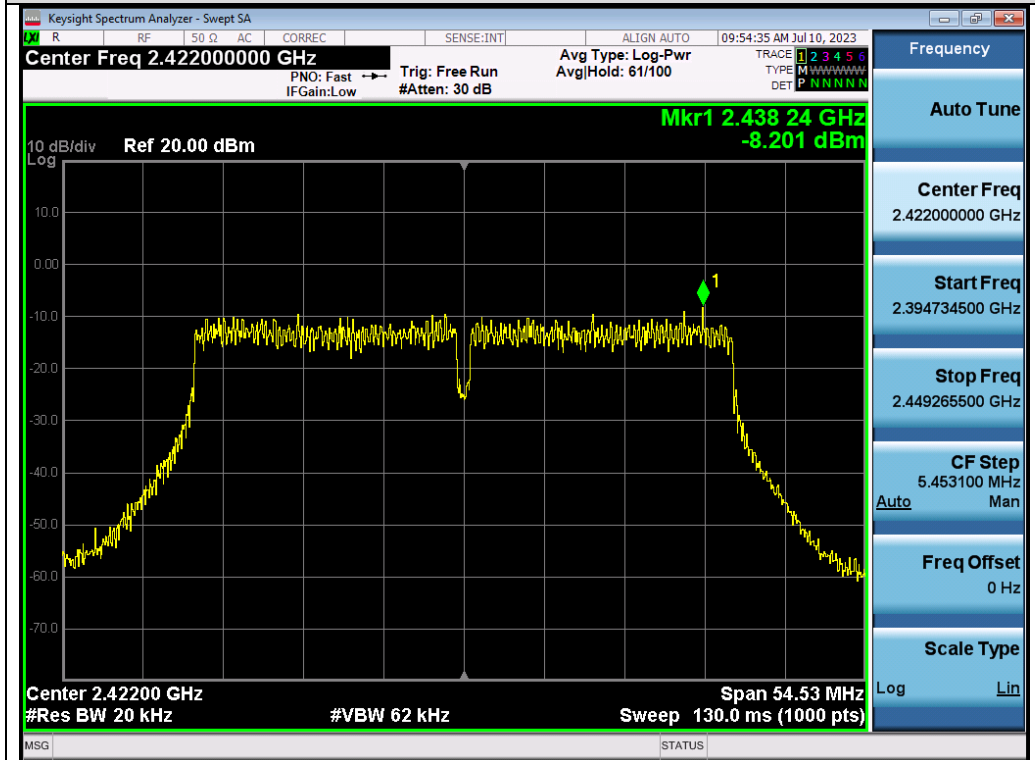

Test\_Graph\_802.11n40\_ANT1\_2422\_MCS0\_PSD

Any report having not been signed by authorized approver, or having been altered without authorization, or having not been stamped by the "Dedicated Testing/Inspection Stamp" is deemed to be invalid. Copying or excerpting portion of, or altering the content of the report is not permitted without the written authorization of AGC. The test results presented in the report apply only to the tested sample. Any objections to report issued by AGC should be submitted to AGC within 15days after the issuance of the test report. Further enquiry of validity or verification of the test report should be addressed to AGC by agc01@agccert.com.

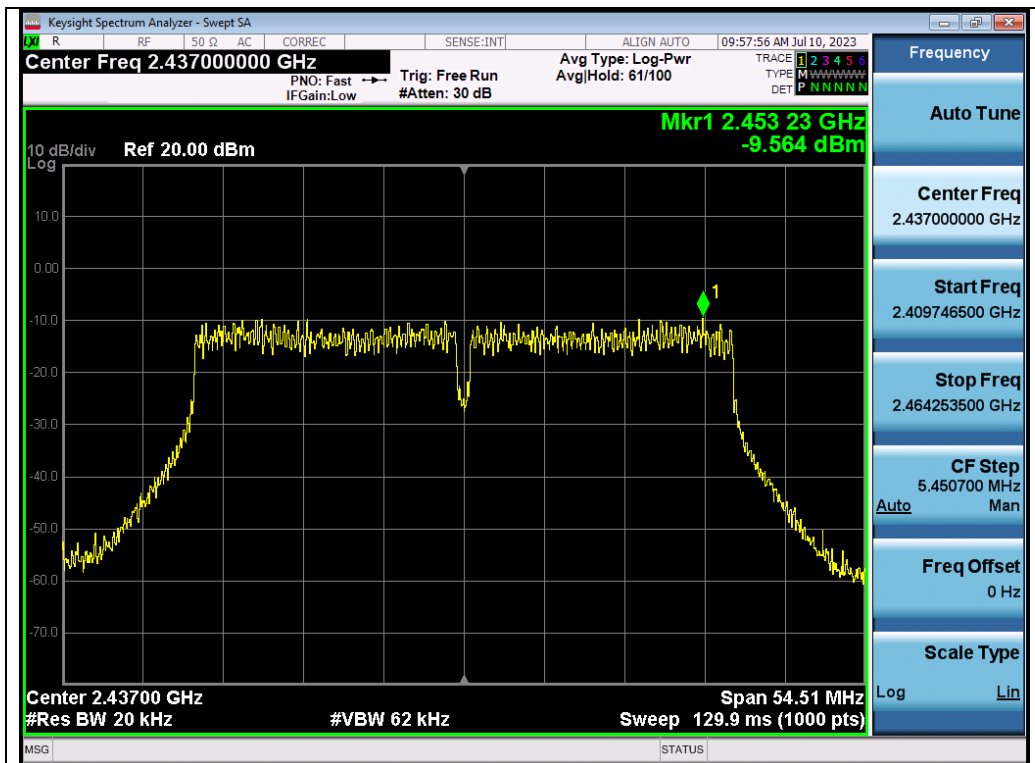

Test\_Graph\_802.11n40\_ANT1\_2437\_MCS0\_PSD

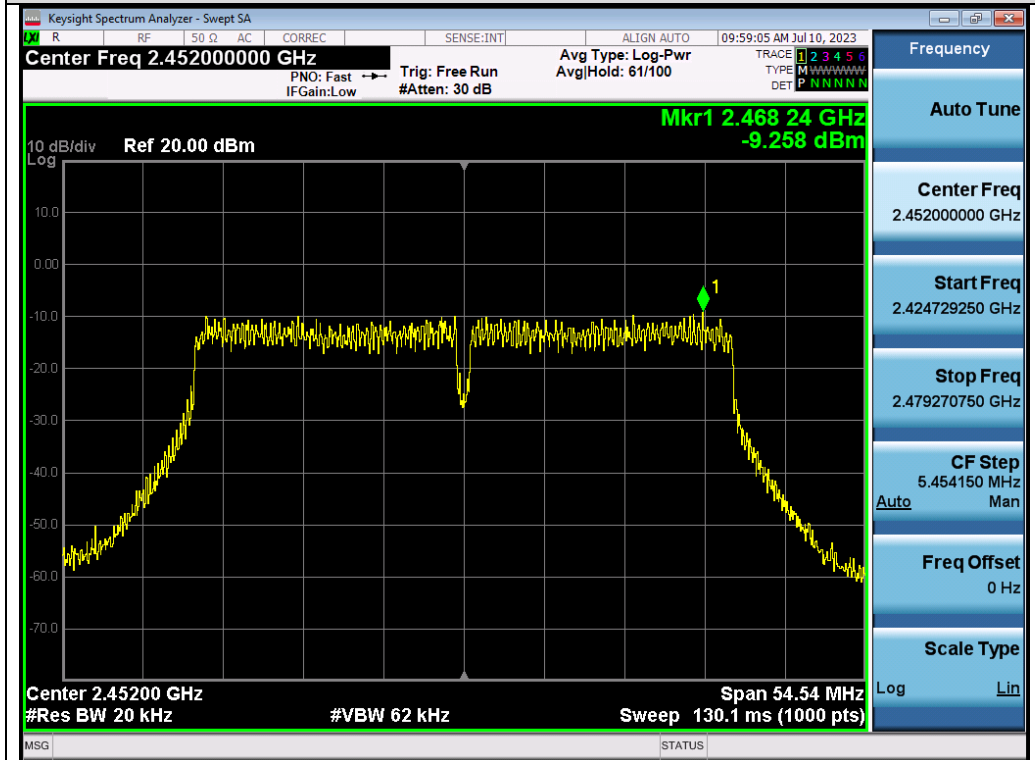

Test\_Graph\_802.11n40\_ANT1\_2452\_MCS0\_PSD

Any report having not been signed by authorized approver, or having been altered without authorization, or having not been stamped by the "Dedicated Testing/Inspection Stamp" is deemed to be invalid. Copying or excerpting portion of, or altering the content of the report is not permitted without the written authorization of AGC. The test results presented in the report apply only to the tested sample. Any objections to report issued by AGC should be submitted to AGC within 15days after the issuance of the test report. Further enquiry of validity or verification of the test report should be addressed to AGC by agc01@agccert.com.

## 11. RADIATED EMISSION

### 11.1 MEASUREMENT LIMITS

15.209(a) Limit in the below table has to be followed

Frequencies (MHz)	Field Strength (microvolts/meter)	Measurement Distance (meters)
0.009~0.490	2400/F(kHz)	300
0.490~1.705	24000/F(kHz)	30
1.705~30.0	30	30
30~88	100	3
88~216	150	3
216~960	200	3
Above 960	500	3

Note: All modes were tested for restricted band radiated emission, the test records reported below are the worst result compared to other modes.

### 11.2 MEASUREMENT PROCEDURE

1. The EUT was placed on the top of the turntable 0.8 or 1.5 meter above ground. The phase center of the receiving antenna mounted on the top of a height-variable antenna tower was placed 3 meters far away from the turntable.
2. Power on the EUT and all the supporting units. The turntable was rotated by 360 degrees to determine the position of the highest radiation.
3. The height of the broadband receiving antenna was varied between one meter and four meters above ground to find the maximum emissions field strength of both horizontal and vertical polarization.
4. For each suspected emission, the antenna tower was scan (from 1 M to 4 M) and then the turntable was rotated (from 0 degree to 360 degrees) to find the maximum reading.
5. Set the test-receiver system to Peak or CISPR quasi-peak Detect Function with specified bandwidth under Maximum Hold Mode.
6. For emissions above 1GHz, use 1MHz RBW and 3MHz VBW for peak reading. Place the measurement antenna away from each area of the EUT determined to be a source of emissions at the specified measurement distance, while keeping the measurement antenna aimed at the source of emissions at each frequency of significant emissions, with polarization oriented for maximum response. The measurement antenna may have to be higher or lower than the EUT, depending on the radiation pattern of the emission and staying aimed at the emission source for receiving the maximum signal. The final measurement antenna elevation shall be that which maximizes the emissions. The measurement antenna elevation for maximum emissions shall be restricted to a range of heights of from 1 m to 4 m above the ground or reference ground plane.
7. When the radiated emissions limits are expressed in terms of the average value of the emissions, and pulsed operation is employed, the measurement field strength shall be determined by averaging over one complete pulse train, including blanking intervals, as long as the pulse train does not exceed 0.1 seconds.

Any report having not been signed by authorized approver, or having been altered without authorization, or having not been stamped by the "Dedicated Testing/Inspection Stamp" is deemed to be invalid. Copying or excerpting portion of, or altering the content of the report is not permitted without the written authorization of AGC. The test results presented in the report apply only to the tested sample. Any objections to report issued by AGC should be submitted to AGC within 15days after the issuance of the test report. Further enquiry of validity or verification of the test report should be addressed to AGC by agc01@agccert.com.

As an alternative (provided the transmitter operates for longer than 0.1 seconds) or in cases where the pulse train exceeds 0.1 seconds, the measured field strength shall be determined from the average absolute voltage during a 0.1 second interval during which the field strength is at its maximum values.

8. If the emissions level of the EUT in peak mode was 3 dB lower than the average limit specified, then testing will be stopped and peak values of EUT will be reported, otherwise, the emissions which do not have 3 dB margin will be repeated one by one using the quasi-peak method for below 1GHz.
9. For testing above 1GHz, the emissions level of the EUT in peak mode was lower than average limit (that means the emissions level in peak mode also complies with the limit in average mode), then testing will be stopped and peak values of EUT will be reported, otherwise, the emissions will be measured in average mode again and reported.
10. In case the emission is lower than 30MHz, loop antenna has to be used for measurement and the recorded data should be QP measured by receiver. High - Low scan is not required in this case.

The following table is the setting of spectrum analyzer and receiver.

Spectrum Parameter	Setting
Start ~Stop Frequency	9KHz~150KHz/RB 200Hz for QP
Start ~Stop Frequency	150KHz~30MHz/RB 9KHz for QP
Start ~Stop Frequency	30MHz~1000MHz/RB 120KHz for QP
Start ~Stop Frequency	1GHz~26.5GHz 1MHz/3MHz for Peak, 1MHz/3MHz for Average

Receiver Parameter	Setting
Start ~Stop Frequency	9KHz~150KHz/RB 200Hz for QP
Start ~Stop Frequency	150KHz~30MHz/RB 9KHz for QP
Start ~Stop Frequency	30MHz~1000MHz/RB 120KHz for QP

Any report having not been signed by authorized approver, or having been altered without authorization, or having not been stamped by the "Dedicated Testing/Inspection Stamp" is deemed to be invalid. Copying or excerpting portion of, or altering the content of the report is not permitted without the written authorization of AGC. The test results presented in the report apply only to the tested sample. Any objections to report issued by AGC should be submitted to AGC within 15days after the issuance of the test report. Further enquiry of validity or verification of the test report should be addressed to AGC by agc01@agccert.com.

### 11.3 MEASUREMENT SETUP (BLOCK DIAGRAM OF CONFIGURATION)

RADIATED EMISSION TEST SETUP 9KHz-30MHz

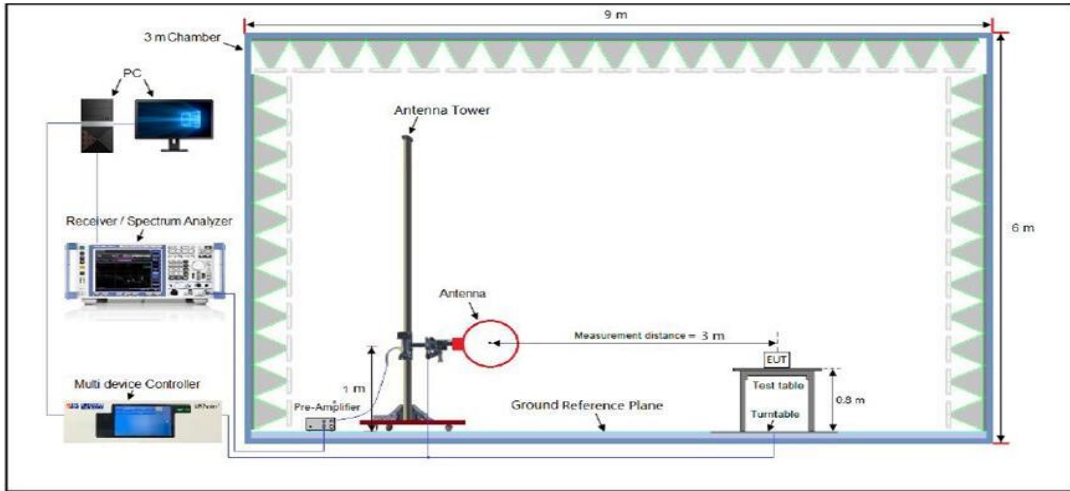

RADIATED EMISSION TEST SETUP 30MHz-1000MHz

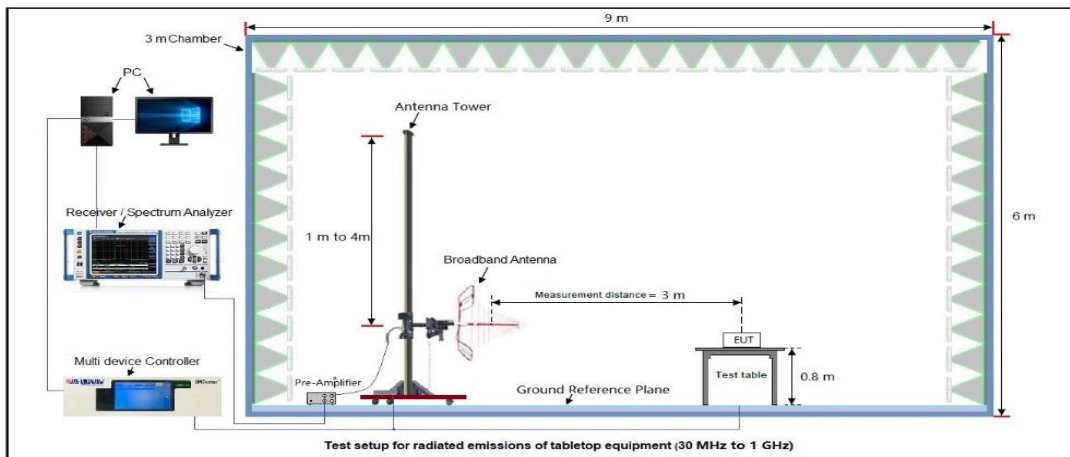

RADIATED EMISSION TEST SETUP ABOVE 1000MHz

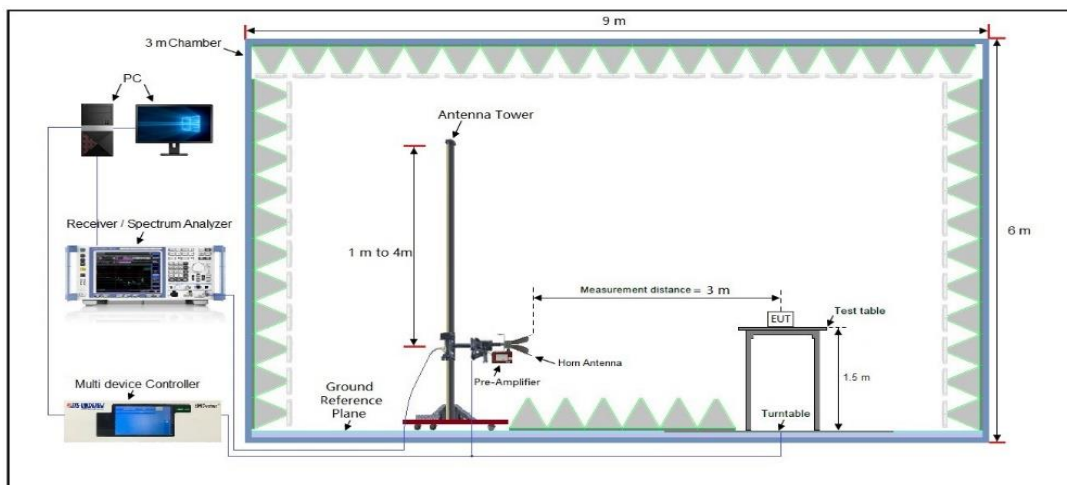

Any report having not been signed by authorized approver, or having been altered without authorization, or having not been stamped by the "Dedicated Testing/Inspection Stamp" is deemed to be invalid. Copying or excerpting portion of, or altering the content of the report is not permitted without the written authorization of AGC. The test results presented in the report apply only to the tested sample. Any objections to report issued by AGC should be submitted to AGC within 15days after the issuance of the test report. Further enquiry of validity or verification of the test report should be addressed to AGC by agc01@agccert.com.

### 11.4 MEASUREMENT RESULT

#### Radiated emission below 30MHz

The amplitude of spurious emissions from 9kHz to 30MHz which are attenuated more than 20 dB below the permissible value need not be reported.

#### Radiated emission from 30MHz to 1000MHz

<b>EUT</b>	IP Phone	<b>Model Name</b>	X305
<b>Temperature</b>	25°C	<b>Relative Humidity</b>	58%
<b>Pressure</b>	960hPa	<b>Test Voltage</b>	DC 5V
<b>Test Mode</b>	802.11b with 2412MHz	<b>Antenna</b>	Horizontal

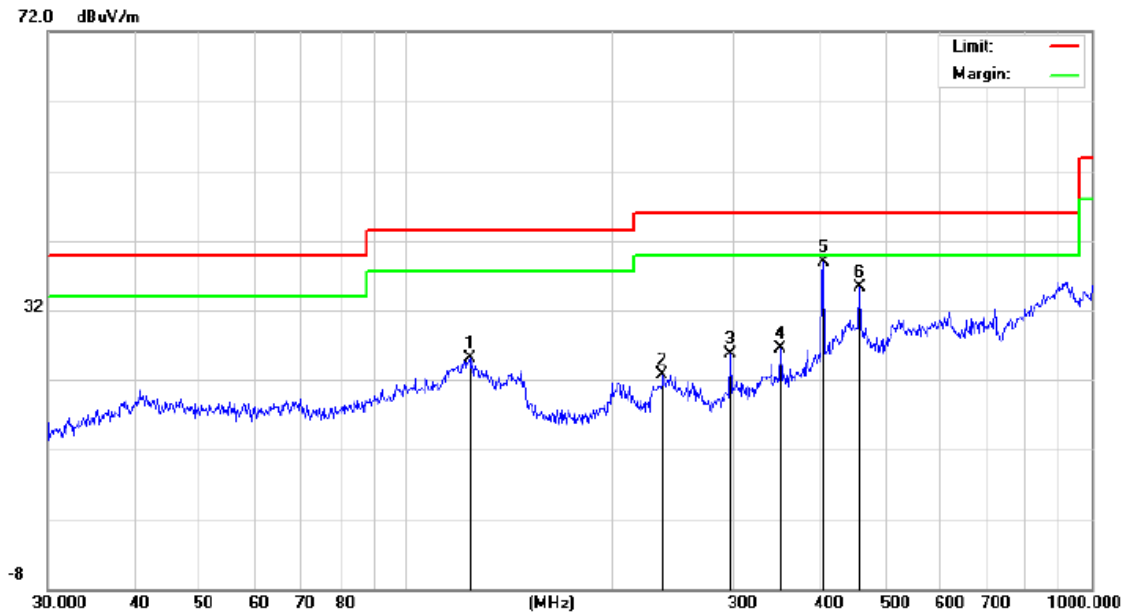

No.	Mk.	Freq.	Reading Level	Correct Factor	Measurement	Limit	Over	Detector
		MHz	dBuV	dB	dBuV/m	dB/m	dB	
1		123.6985	8.96	16.18	25.14	43.50	-18.36	peak
2		236.6447	7.52	15.23	22.75	46.00	-23.25	peak
3		297.2241	10.45	15.28	25.73	46.00	-20.27	peak
4		351.7079	9.21	17.39	26.60	46.00	-19.40	peak
5	*	406.0880	18.40	20.52	38.92	46.00	-7.08	peak
6		459.1144	10.88	24.43	35.31	46.00	-10.69	peak

### RESULT: PASS

Any report having not been signed by authorized approver, or having been altered without authorization, or having not been stamped by the "Dedicated Testing/Inspection Stamp" is deemed to be invalid. Copying or excerpting portion of, or altering the content of the report is not permitted without the written authorization of AGC. The test results presented in the report apply only to the tested sample. Any objections to report issued by AGC should be submitted to AGC within 15days after the issuance of the test report. Further enquiry of validity or verification of the test report should be addressed to AGC by agc01@agccert.com.



EUT	IP Phone	Model Name	X305
Temperature	25°C	Relative Humidity	58%
Pressure	960hPa	Test Voltage	DC 5V
Test Mode	802.11b with 2412MHz	Antenna	Vertical

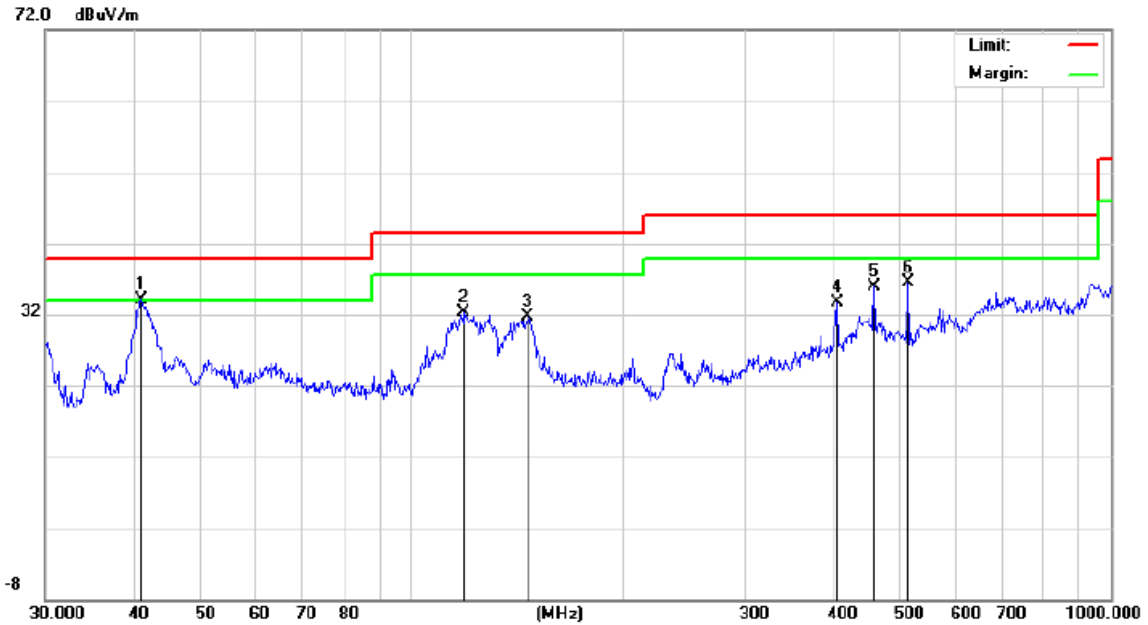

No.	Mk.	Freq. MHz	Reading Level dBuV	Correct Factor dB	Measure- ment dBuV/m	Limit dB/m	Over dB	Detector
1	*	41.1320	17.26	16.91	34.17	40.00	-5.83	peak
2		119.0180	14.72	17.53	32.25	43.50	-11.25	peak
3		146.8877	13.54	18.20	31.74	43.50	-11.76	peak
4		406.0880	11.23	22.41	33.64	46.00	-12.36	peak
5		459.1144	10.57	25.24	35.81	46.00	-10.19	peak
6		513.6331	13.05	23.49	36.54	46.00	-9.46	peak

Any report having not been signed by authorized approver, or having been altered without authorization, or having not been stamped by the "Dedicated Testing/Inspection Stamp" is deemed to be invalid. Copying or excerpting portion of, or altering the content of the report is not permitted without the written authorization of AGC. The test results presented in the report apply only to the tested sample. Any objections to report issued by AGC should be submitted to AGC within 15days after the issuance of the test report. Further enquiry of validity or verification of the test report should be addressed to AGC by agc01@agccert.com.

EUT	IP Phone	Model Name	X305
Temperature	25°C	Relative Humidity	58%
Pressure	960hPa	Test Voltage	DC 48V
Test Mode	802.11b with 2412MHz	Antenna	Horizontal

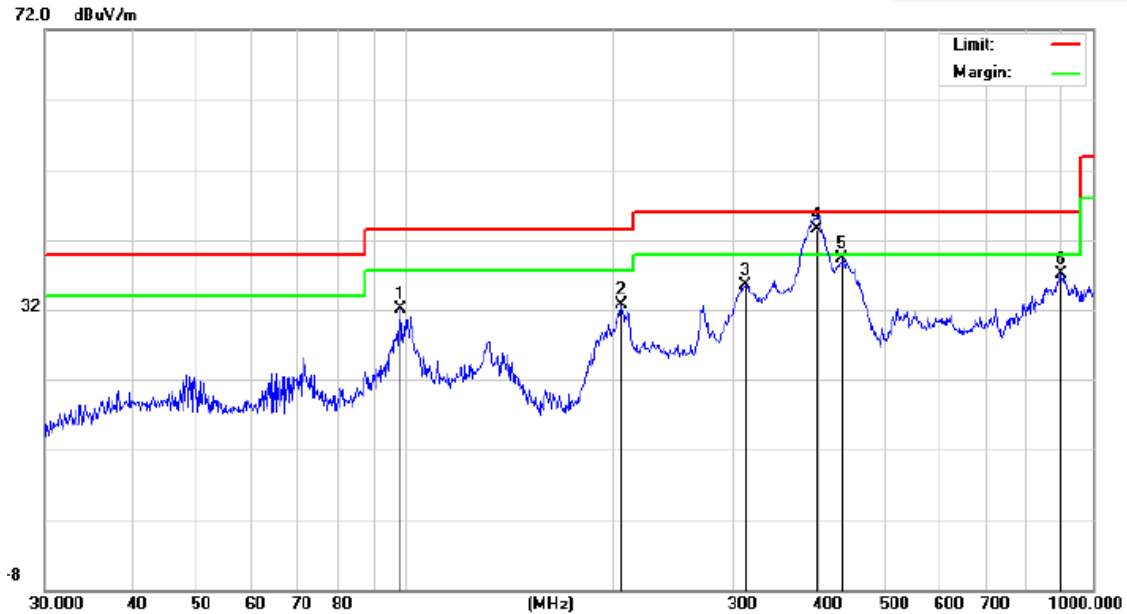

No.	Mk.	Freq. MHz	Reading Level dBuV	Correct Factor dB	Measure- ment dBuV/m	Limit dB/m	Over dB	Detector
1		98.4866	16.11	15.97	32.08	43.50	-11.42	peak
2		206.3976	18.14	14.47	32.61	43.50	-10.89	peak
3		312.1794	20.04	15.50	35.54	46.00	-10.46	peak
4	*	397.6334	22.65	20.14	42.79	46.00	-3.21	QP
5		432.5457	15.87	23.50	39.37	46.00	-6.63	peak
6		900.1474	5.38	31.78	37.16	46.00	-8.84	peak

**RESULT: PASS**

Any report having not been signed by authorized approver, or having been altered without authorization, or having not been stamped by the "Dedicated Testing/Inspection Stamp" is deemed to be invalid. Copying or excerpting portion of, or altering the content of the report is not permitted without the written authorization of AGC. The test results presented in the report apply only to the tested sample. Any objections to report issued by AGC should be submitted to AGC within 15days after the issuance of the test report. Further enquiry of validity or verification of the test report should be addressed to AGC by agc01@agccert.com.

EUT	IP Phone	Model Name	X305
Temperature	25°C	Relative Humidity	58%
Pressure	960hPa	Test Voltage	DC 48V
Test Mode	802.11b with 2412MHz	Antenna	Vertical

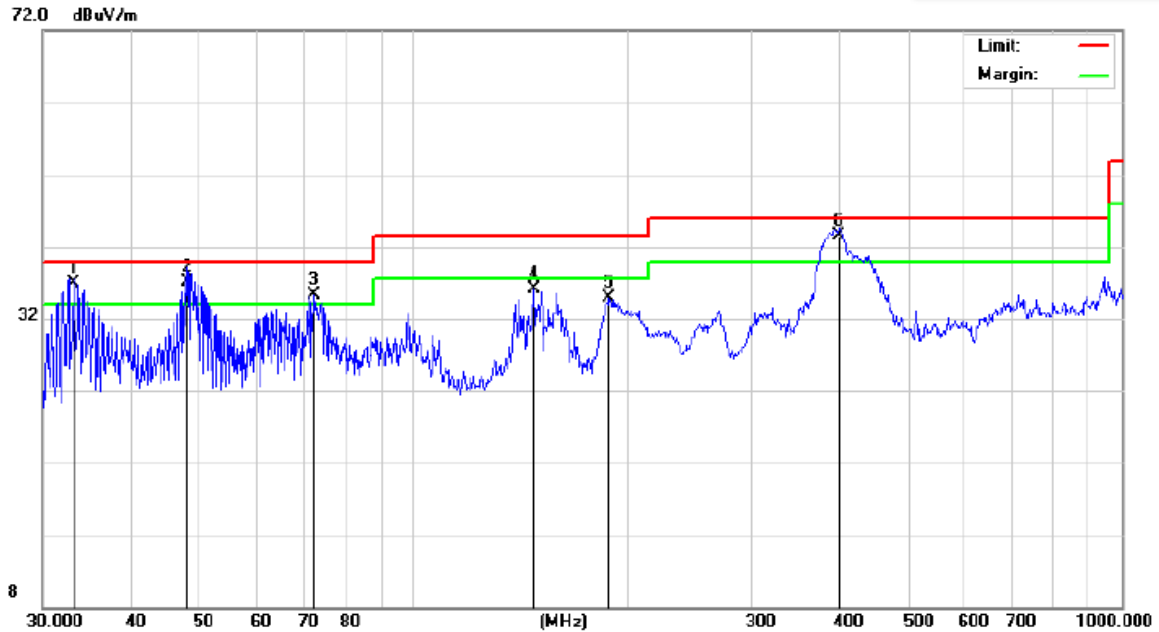

No.	Mk.	Freq. MHz	Reading Level dBuV	Correct Factor dB	Measure- ment dBuV/m	Limit dB/m	Over dB	Detector
1	!	33.0950	21.80	14.62	36.42	40.00	-3.58	QP
2	!	47.9940	19.55	16.98	36.53	40.00	-3.47	QP
3	!	72.3376	18.36	16.98	35.34	40.00	-4.66	peak
4		147.9214	17.84	18.20	36.04	43.50	-7.46	peak
5		189.0743	16.65	18.23	34.88	43.50	-8.62	peak
6	*	399.0302	20.74	22.16	42.90	46.00	-3.10	QP

**RESULT: PASS**

**Note:** 1. Factor=Antenna Factor + Cable loss, Margin= Measurement-Limit.

2. The “Factor” value can be calculated automatically by software of measurement system.

3. All test modes had been pre-tested. The 802.11b mode of 802.11b with 2412MHz is the worst case and recorded in the report.

Any report having not been signed by authorized approver, or having been altered without authorization, or having not been stamped by the “Dedicated Testing/Inspection Stamp” is deemed to be invalid. Copying or excerpting portion of, or altering the content of the report is not permitted without the written authorization of AGC. The test results presented in the report apply only to the tested sample. Any objections to report issued by AGC should be submitted to AGC within 15days after the issuance of the test report. Further enquiry of validity or verification of the test report should be addressed to AGC by agc01@agccert.com.

**Radiated emission above 1GHz**

<b>EUT</b>	IP Phone	<b>Model Name</b>	X305
<b>Temperature</b>	25°C	<b>Relative Humidity</b>	58%
<b>Pressure</b>	960hPa	<b>Test Voltage</b>	DC 5V
<b>Test Mode</b>	802.11b with data rate 1_2412MHz	<b>Antenna</b>	Horizontal

Frequency (MHz)	Meter Reading (dBµV)	Factor (dB)	Emission Level (dBµV/m)	Limits (dBµV/m)	Margin (dB)	Value Type
4824.000	52.16	0.08	52.24	74.00	-21.76	peak
4824.000	43.51	0.08	43.59	54.00	-10.41	AVG
7236.000	50.13	2.21	52.34	74.00	-21.66	peak
7236.000	41.22	2.21	43.43	54.00	-10.57	AVG

Remark:  
Factor = Antenna Factor + Cable Loss – Pre-amplifier.

<b>EUT</b>	IP Phone	<b>Model Name</b>	X305
<b>Temperature</b>	25°C	<b>Relative Humidity</b>	58%
<b>Pressure</b>	960hPa	<b>Test Voltage</b>	DC 5V
<b>Test Mode</b>	802.11b with data rate 1_2412MHz	<b>Antenna</b>	Vertical

Frequency (MHz)	Meter Reading (dBµV)	Factor (dB)	Emission Level (dBµV/m)	Limits (dBµV/m)	Margin (dB)	Value Type
4824.000	50.69	0.08	50.77	74.00	-23.23	peak
4824.000	42.84	0.08	42.92	54.00	-11.08	AVG
7236.000	49.36	2.21	51.57	74.00	-22.43	peak
7236.000	40.85	2.21	43.06	54.00	-10.94	AVG

Remark:  
Factor = Antenna Factor + Cable Loss – Pre-amplifier.

**RESULT: PASS**

Any report having not been signed by authorized approver, or having been altered without authorization, or having not been stamped by the “Dedicated Testing/Inspection Stamp” is deemed to be invalid. Copying or excerpting portion of, or altering the content of the report is not permitted without the written authorization of AGC. The test results presented in the report apply only to the tested sample. Any objections to report issued by AGC should be submitted to AGC within 15days after the issuance of the test report. Further enquiry of validity or verification of the test report should be addressed to AGC by agc01@agccert.com.

<b>EUT</b>	IP Phone	<b>Model Name</b>	X305
<b>Temperature</b>	25°C	<b>Relative Humidity</b>	58%
<b>Pressure</b>	960hPa	<b>Test Voltage</b>	DC 5V
<b>Test Mode</b>	802.11b with data rate 1_2437MHz	<b>Antenna</b>	Horizontal

Frequency (MHz)	Meter Reading (dBµV)	Factor (dB)	Emission Level (dBµV/m)	Limits (dBµV/m)	Margin (dB)	Value Type
4874.000	52.85	0.14	52.99	74.00	-21.01	peak
4874.000	37.94	0.14	38.08	54.00	-15.92	AVG
7311.000	51.22	2.36	53.58	74.00	-20.42	peak
7311.000	35.74	2.36	38.10	54.00	-15.90	AVG

Remark:  
Factor = Antenna Factor + Cable Loss – Pre-amplifier.

<b>EUT</b>	IP Phone	<b>Model Name</b>	X305
<b>Temperature</b>	25°C	<b>Relative Humidity</b>	58%
<b>Pressure</b>	960hPa	<b>Test Voltage</b>	DC 5V
<b>Test Mode</b>	802.11b with data rate 1_2437MHz	<b>Antenna</b>	Vertical

Frequency (MHz)	Meter Reading (dBµV)	Factor (dB)	Emission Level (dBµV/m)	Limits (dBµV/m)	Margin (dB)	Value Type
4874.000	50.44	0.14	50.58	74.00	-23.42	peak
4874.000	38.12	0.14	38.26	54.00	-15.74	AVG
7311.000	50.54	2.36	52.90	74.00	-21.10	peak
7311.000	36.56	2.36	38.92	54.00	-15.08	AVG

Remark:  
Factor = Antenna Factor + Cable Loss – Pre-amplifier.

**RESULT: PASS**

Any report having not been signed by authorized approver, or having been altered without authorization, or having not been stamped by the “Dedicated Testing/Inspection Stamp” is deemed to be invalid. Copying or excerpting portion of, or altering the content of the report is not permitted without the written authorization of AGC. The test results presented in the report apply only to the tested sample. Any objections to report issued by AGC should be submitted to AGC within 15days after the issuance of the test report. Further enquiry of validity or verification of the test report should be addressed to AGC by agc01@agccert.com.

<b>EUT</b>	IP Phone	<b>Model Name</b>	X305
<b>Temperature</b>	25°C	<b>Relative Humidity</b>	58%
<b>Pressure</b>	960hPa	<b>Test Voltage</b>	DC 5V
<b>Test Mode</b>	802.11b with data rate 1_2462MHz	<b>Antenna</b>	Horizontal

Frequency (MHz)	Meter Reading (dBμV)	Factor (dB)	Emission Level (dBμV/m)	Limits (dBμV/m)	Margin (dB)	Value Type
4924.000	51.25	0.22	51.47	74.00	-22.53	peak
4924.000	42.02	0.22	42.24	54.00	-11.76	AVG
7386.000	48.13	2.64	50.77	74.00	-23.23	peak
7386.000	39.52	2.64	42.16	54.00	-11.84	AVG

Remark:  
Factor = Antenna Factor + Cable Loss – Pre-amplifier.

<b>EUT</b>	IP Phone	<b>Model Name</b>	X305
<b>Temperature</b>	25°C	<b>Relative Humidity</b>	58%
<b>Pressure</b>	960hPa	<b>Test Voltage</b>	DC 5V
<b>Test Mode</b>	802.11b with data rate 1_2462MHz	<b>Antenna</b>	Vertical

Frequency (MHz)	Meter Reading (dBμV)	Factor (dB)	Emission Level (dBμV/m)	Limits (dBμV/m)	Margin (dB)	Value Type
4924.000	49.88	0.22	50.10	74.00	-23.90	peak
4924.000	41.15	0.22	41.37	54.00	-12.63	AVG
7386.000	47.36	2.64	50.00	74.00	-24.00	peak
7386.000	38.74	2.64	41.38	54.00	-12.62	AVG

Remark:  
Factor = Antenna Factor + Cable Loss – Pre-amplifier.

**RESULT: PASS**

Any report having not been signed by authorized approver, or having been altered without authorization, or having not been stamped by the “Dedicated Testing/Inspection Stamp” is deemed to be invalid. Copying or excerpting portion of, or altering the content of the report is not permitted without the written authorization of AGC. The test results presented in the report apply only to the tested sample. Any objections to report issued by AGC should be submitted to AGC within 15days after the issuance of the test report. Further enquiry of validity or verification of the test report should be addressed to AGC by agc01@agccert.com.

**Radiated emission above 1GHz**

<b>EUT</b>	IP Phone	<b>Model Name</b>	X305
<b>Temperature</b>	25°C	<b>Relative Humidity</b>	58%
<b>Pressure</b>	960hPa	<b>Test Voltage</b>	DC 48V
<b>Test Mode</b>	802.11b with data rate 1_2412MHz	<b>Antenna</b>	Horizontal

Frequency (MHz)	Meter Reading (dBµV)	Factor (dB)	Emission Level (dBµV/m)	Limits (dBµV/m)	Margin (dB)	Value Type
4824.000	51.84	0.08	51.92	74.00	-22.08	peak
4824.000	42.19	0.08	42.27	54.00	-11.73	AVG
7236.000	49.66	2.21	51.87	74.00	-22.13	peak
7236.000	40.37	2.21	42.58	54.00	-11.42	AVG

Remark:  
Factor = Antenna Factor + Cable Loss – Pre-amplifier.

<b>EUT</b>	IP Phone	<b>Model Name</b>	X305
<b>Temperature</b>	25°C	<b>Relative Humidity</b>	58%
<b>Pressure</b>	960hPa	<b>Test Voltage</b>	DC 48V
<b>Test Mode</b>	802.11b with data rate 1_2412MHz	<b>Antenna</b>	Vertical

Frequency (MHz)	Meter Reading (dBµV)	Factor (dB)	Emission Level (dBµV/m)	Limits (dBµV/m)	Margin (dB)	Value Type
4824.000	52.05	0.08	52.13	74.00	-21.87	peak
4824.000	43.11	0.08	43.19	54.00	-10.81	AVG
7236.000	48.74	2.21	50.95	74.00	-23.05	peak
7236.000	41.52	2.21	43.73	54.00	-10.27	AVG

Remark:  
Factor = Antenna Factor + Cable Loss – Pre-amplifier.

**RESULT: PASS**

Any report having not been signed by authorized approver, or having been altered without authorization, or having not been stamped by the “Dedicated Testing/Inspection Stamp” is deemed to be invalid. Copying or excerpting portion of, or altering the content of the report is not permitted without the written authorization of AGC. The test results presented in the report apply only to the tested sample. Any objections to report issued by AGC should be submitted to AGC within 15days after the issuance of the test report. Further enquiry of validity or verification of the test report should be addressed to AGC by agc01@agccert.com.

<b>EUT</b>	IP Phone	<b>Model Name</b>	X305
<b>Temperature</b>	25°C	<b>Relative Humidity</b>	58%
<b>Pressure</b>	960hPa	<b>Test Voltage</b>	DC 48V
<b>Test Mode</b>	802.11b with data rate 1_2437MHz	<b>Antenna</b>	Horizontal

Frequency (MHz)	Meter Reading (dBµV)	Factor (dB)	Emission Level (dBµV/m)	Limits (dBµV/m)	Margin (dB)	Value Type
4874.000	52.15	0.14	52.29	74.00	-21.71	peak
4874.000	37.40	0.14	37.54	54.00	-16.46	AVG
7311.000	49.52	2.36	51.88	74.00	-22.12	peak
7311.000	37.01	2.36	39.37	54.00	-14.63	AVG

Remark:  
Factor = Antenna Factor + Cable Loss – Pre-amplifier.

<b>EUT</b>	IP Phone	<b>Model Name</b>	X305
<b>Temperature</b>	25°C	<b>Relative Humidity</b>	58%
<b>Pressure</b>	960hPa	<b>Test Voltage</b>	DC 48V
<b>Test Mode</b>	802.11b with data rate 1_2437MHz	<b>Antenna</b>	Vertical

Frequency (MHz)	Meter Reading (dBµV)	Factor (dB)	Emission Level (dBµV/m)	Limits (dBµV/m)	Margin (dB)	Value Type
4874.000	50.14	0.14	50.28	74.00	-23.72	peak
4874.000	38.05	0.14	38.19	54.00	-15.81	AVG
7311.000	50.11	2.36	52.47	74.00	-21.53	peak
7311.000	38.12	2.36	40.48	54.00	-13.52	AVG

Remark:  
Factor = Antenna Factor + Cable Loss – Pre-amplifier.

**RESULT: PASS**

Any report having not been signed by authorized approver, or having been altered without authorization, or having not been stamped by the “Dedicated Testing/Inspection Stamp” is deemed to be invalid. Copying or excerpting portion of, or altering the content of the report is not permitted without the written authorization of AGC. The test results presented in the report apply only to the tested sample. Any objections to report issued by AGC should be submitted to AGC within 15days after the issuance of the test report. Further enquiry of validity or verification of the test report should be addressed to AGC by agc01@agccert.com.



<b>EUT</b>	IP Phone	<b>Model Name</b>	X305
<b>Temperature</b>	25°C	<b>Relative Humidity</b>	58%
<b>Pressure</b>	960hPa	<b>Test Voltage</b>	DC 48V
<b>Test Mode</b>	802.11b with date rate 1_2462MHz	<b>Antenna</b>	Horizontal

Frequency (MHz)	Meter Reading (dBµV)	Factor (dB)	Emission Level (dBµV/m)	Limits (dBµV/m)	Margin (dB)	Value Type
4924.000	50.52	0.22	50.74	74.00	-23.26	peak
4924.000	42.38	0.22	42.60	54.00	-11.40	AVG
7386.000	48.36	2.64	51.00	74.00	-23.00	peak
7386.000	37.63	2.64	40.27	54.00	-13.73	AVG

Remark:  
Factor = Antenna Factor + Cable Loss – Pre-amplifier.

<b>EUT</b>	IP Phone	<b>Model Name</b>	X305
<b>Temperature</b>	25°C	<b>Relative Humidity</b>	58%
<b>Pressure</b>	960hPa	<b>Test Voltage</b>	DC 48V
<b>Test Mode</b>	802.11b with date rate 1_2462MHz	<b>Antenna</b>	Vertical

Frequency (MHz)	Meter Reading (dBµV)	Factor (dB)	Emission Level (dBµV/m)	Limits (dBµV/m)	Margin (dB)	Value Type
4924.000	49.89	0.22	50.11	74.00	-23.89	peak
4924.000	41.15	0.22	41.37	54.00	-12.63	AVG
7386.000	49.34	2.64	51.98	74.00	-22.02	peak
7386.000	38.62	2.64	41.26	54.00	-12.74	AVG

Remark:  
Factor = Antenna Factor + Cable Loss – Pre-amplifier.

**RESULT: PASS**

**Note:**

The amplitude of other spurious emissions from 1G to 25 GHz which are attenuated more than 20 dB below the permissible value need not be reported.

Factor = Antenna Factor + Cable loss - Amplifier gain, Over= Measure-Limit.

The “Factor” value can be calculated automatically by software of measurement system.

All test modes had been pre-tested. The 802.11b mode is the worst case and recorded in the report.

Any report having not been signed by authorized approver, or having been altered without authorization, or having not been stamped by the “Dedicated Testing/Inspection Stamp” is deemed to be invalid. Copying or excerpting portion of, or altering the content of the report is not permitted without the written authorization of AGC. The test results presented in the report apply only to the tested sample. Any objections to report issued by AGC should be submitted to AGC within 15days after the issuance of the test report. Further enquiry of validity or verification of the test report should be addressed to AGC by agc01@agccert.com.

**Test result for band edge emission at restricted bands**

EUT	IP Phone	Model Name	X305
Temperature	25°C	Relative Humidity	60%
Pressure	960hPa	Test Voltage	DC 5V
Test Mode	802.11b with date rate 1_2412MHz	Antenna	Horizontal

Test Graph for Peak Measurement

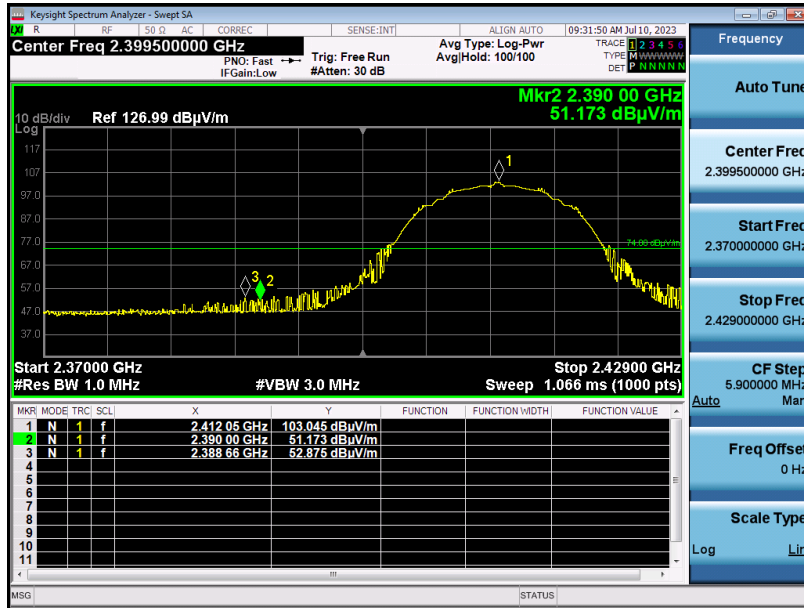

Test Graph for Average Measurement

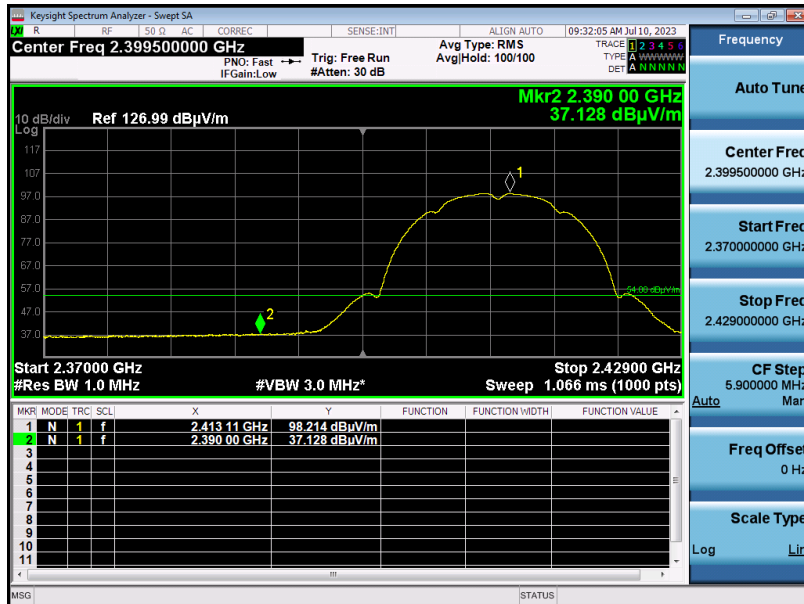

**RESULT: PASS**

Any report having not been signed by authorized approver, or having been altered without authorization, or having not been stamped by the "Dedicated Testing/Inspection Stamp" is deemed to be invalid. Copying or excerpting portion of, or altering the content of the report is not permitted without the written authorization of AGC. The test results presented in the report apply only to the tested sample. Any objections to report issued by AGC should be submitted to AGC within 15days after the issuance of the test report. Further enquiry of validity or verification of the test report should be addressed to AGC by agc01@agccert.com.

EUT	IP Phone	Model Name	X305
Temperature	25°C	Relative Humidity	60%
Pressure	960hPa	Test Voltage	DC 5V
Test Mode	802.11b with data rate 1_2412MHz	Antenna	Vertical

Test Graph for Peak Measurement

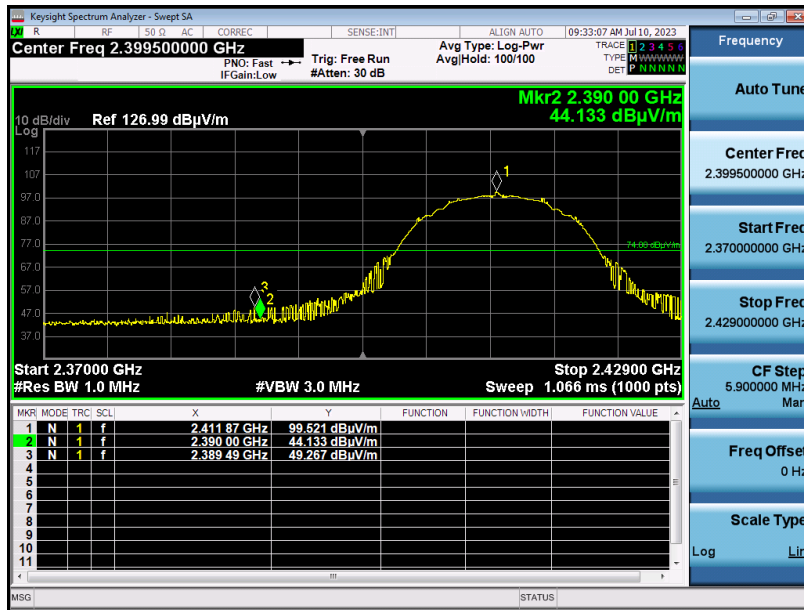

Test Graph for Average Measurement

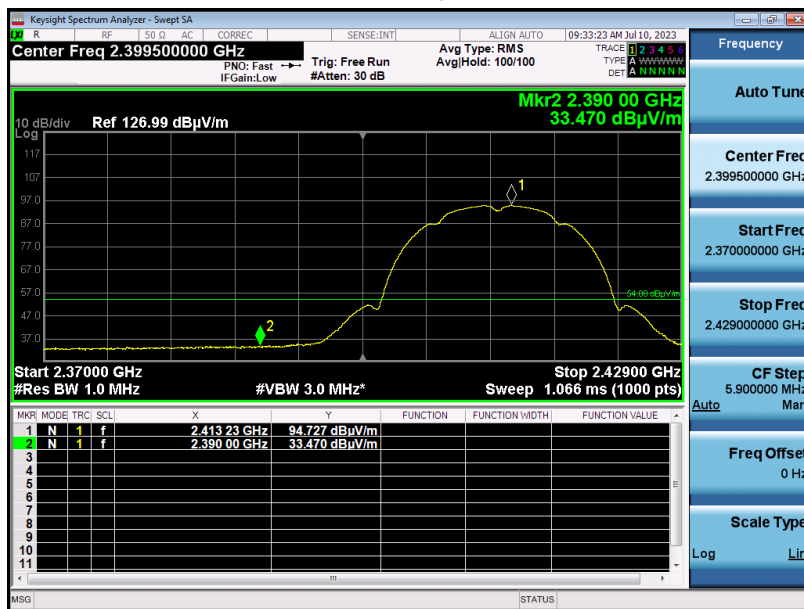

**RESULT: PASS**

Any report having not been signed by authorized approver, or having been altered without authorization, or having not been stamped by the "Dedicated Testing/Inspection Stamp" is deemed to be invalid. Copying or excerpting portion of, or altering the content of the report is not permitted without the written authorization of AGC. The test results presented in the report apply only to the tested sample. Any objections to report issued by AGC should be submitted to AGC within 15days after the issuance of the test report. Further enquiry of validity or verification of the test report should be addressed to AGC by agc01@agccert.com.

EUT	IP Phone	Model Name	X305
Temperature	25°C	Relative Humidity	60%
Pressure	960hPa	Test Voltage	DC 5V
Test Mode	802.11b with data rate 1_2462MHz	Antenna	Horizontal

Test Graph for Peak Measurement

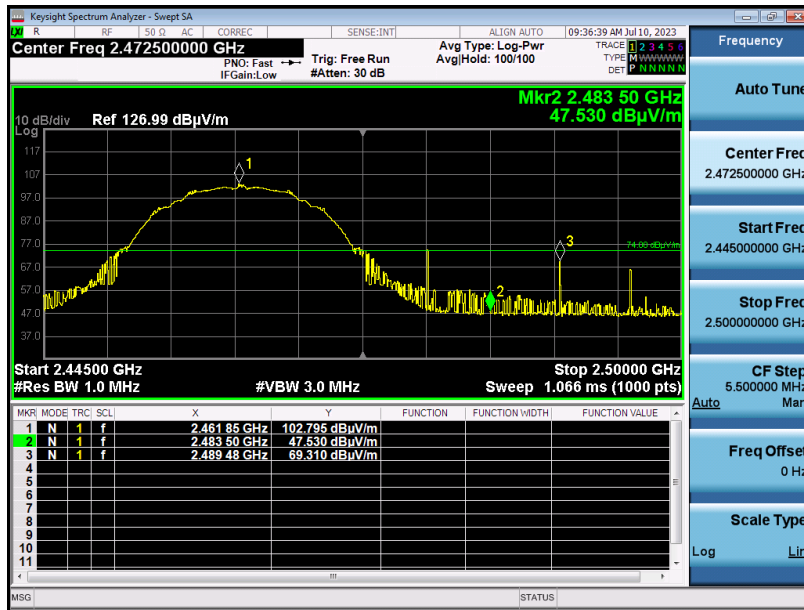

Test Graph for Average Measurement

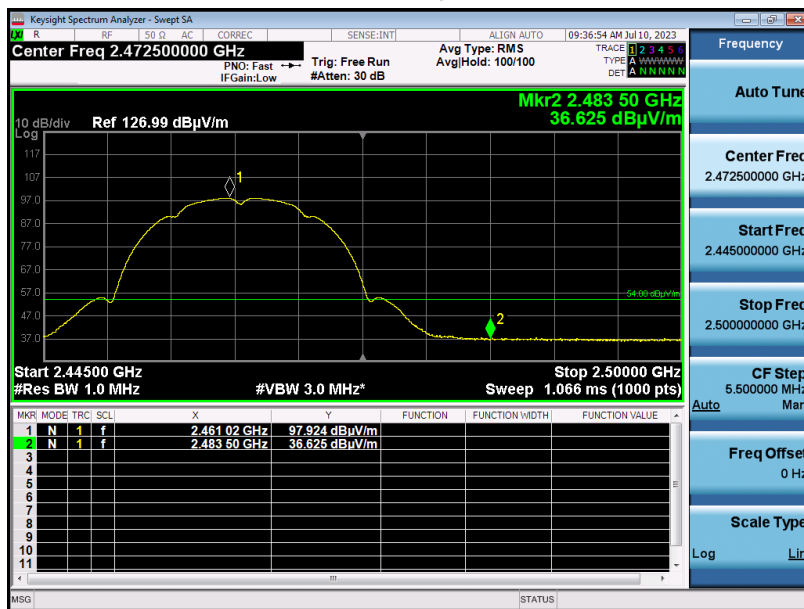

**RESULT: PASS**

Any report having not been signed by authorized approver, or having been altered without authorization, or having not been stamped by the "Dedicated Testing/Inspection Stamp" is deemed to be invalid. Copying or excerpting portion of, or altering the content of the report is not permitted without the written authorization of AGC. The test results presented in the report apply only to the tested sample. Any objections to report issued by AGC should be submitted to AGC within 15days after the issuance of the test report. Further enquiry of validity or verification of the test report should be addressed to AGC by agc01@agccert.com.