

# Test Report

FCC ID: 2APOP-M7

Date of issue: Nov. 13, 2018

Report Number: MTi181112E045

Sample Description: Bluetooth earphone

Model(s): M7

Applicant: Marsk T Co., limited

Address: 702, Baishiwei Business Building, Fuwei West Street 39, Fuyong,  
Baoan, Shenzhen, China.

Date of Test: Nov. 06, 2018 to Nov. 13, 2018

Shenzhen Microtest Co., Ltd.  
<http://www.mtitest.com>

This test report is valid for the tested samples only. It cannot be reproduced except in full without prior written consent of Shenzhen Microtest Co., Ltd.

Tel: (86-755) 88850135

Fax: (86-755) 88850136

Web: <http://www.mtitest.com>

E-mail: [mti@51mti.com](mailto:mti@51mti.com)

Address: No.102A & 302A, East Block, Hengfang Industrial Park, Xingye Road, Xixiang, Bao'an District, Shenzhen, Guangdong, China

## Table of Contents

<b>1</b>	<b>GENERAL INFORMATION .....</b>	<b>5</b>
1.1	DESCRIPTION OF EUT .....	5
1.2	OPERATION CHANNEL LIST .....	5
1.3	TEST CHANNEL LIST .....	6
1.4	ANCILLARY EQUIPMENT LIST .....	6
1.5	DESCRIPTION OF SUPPORT UNITS .....	6
<b>2</b>	<b>SUMMARY OF TEST RESULTS .....</b>	<b>7</b>
<b>3</b>	<b>TEST FACILITIES AND ACCREDITATIONS .....</b>	<b>8</b>
3.1	TEST LABORATORY .....	8
3.2	ENVIRONMENTAL CONDITIONS .....	8
3.3	MEASUREMENT UNCERTAINTY .....	8
3.4	TEST SOFTWARE .....	8
<b>4</b>	<b>EQUIPMENT LIST .....</b>	<b>9</b>
<b>5</b>	<b>TEST RESULT .....</b>	<b>10</b>
5.1	ANTENNA REQUIREMENT .....	10
5.1.1	<i>Standard requirement</i> .....	10
5.1.2	<i>EUT Antenna</i> .....	10
5.2	PEAK OUTPUT POWER .....	11
5.2.1	<i>Limit</i> .....	11
5.2.2	<i>Test setup</i> .....	11
5.2.3	<i>Test procedure</i> .....	11
5.2.4	<i>Test results</i> .....	11
5.3	CONDUCTED EMISSION .....	16
5.3.1	<i>Limits</i> .....	16
5.3.2	<i>Test setup</i> .....	16
5.3.3	<i>Test procedure</i> .....	17
5.3.4	<i>Test results</i> .....	17
5.4	RADIATED SPURIOUS EMISSION .....	22
5.4.1	<i>Limits</i> .....	22
5.4.2	<i>Test setup</i> .....	23
5.4.3	<i>Test procedure</i> .....	24
5.4.4	<i>Test results</i> .....	25
5.4.4.1	<i>Radiation emission</i> .....	25
5.4.4.2	<i>Band edge – radiated</i> .....	29
5.4.4.3	<i>Spurious Emission in Restricted Band 3260MMHz-18000MHz</i> .....	30
5.5	20dB OCCUPIED CHANNEL BANDWIDTH .....	31
5.5.1	<i>Limit</i> .....	31
5.5.2	<i>Test setup</i> .....	31
5.5.3	<i>Test procedure</i> .....	31
5.5.4	<i>Test results</i> .....	31
5.6	CARRIER FREQUENCY SEPARATION .....	36
5.6.1	<i>Limit</i> .....	36
5.6.2	<i>Test setup</i> .....	36
5.6.3	<i>Test procedure</i> .....	36
5.6.4	<i>Test results</i> .....	36
5.7	HOPPING CHANNEL .....	41
5.7.1	<i>Limit</i> .....	41
5.7.2	<i>Test setup</i> .....	41
5.7.3	<i>Test procedure</i> .....	41
5.7.4	<i>Test results</i> .....	41

5.8	DWELL TIME.....	43
5.8.1	Limit .....	43
5.8.2	Test setup .....	43
5.8.3	Test procedure.....	43
5.8.4	Test results.....	43
5.9	CONDUCTED BANDEDGE .....	47
5.9.1	Limit .....	47
5.9.2	Test setup .....	47
5.9.3	Test procedure.....	47
5.9.4	Test results.....	47
5.10	SPURIOUS RF CONDUCTED EMISSIONS .....	52
5.10.1	Conformance Limit.....	52
5.10.2	Measuring Instruments.....	52
5.10.3	Test Setup.....	52
5.10.4	Test Procedure .....	52
5.10.5	Test Results .....	52
<b>PHOTOGRAPHS OF THE TEST SETUP.....</b>		<b>55</b>
<b>PHOTOGRAPHS OF THE EUT.....</b>		<b>57</b>

## TEST REPORT

Applicant's name: Marsk T Co., limited

Address: 702, Baishiwei Business Building, Fuwei West Street 39, Fuyong, Baoan, Shenzhen, China.

Manufacture's Name: Marsk T Co., limited

Address: 702, Baishiwei Business Building, Fuwei West Street 39, Fuyong, Baoan, Shenzhen, China.

Product name: Bluetooth earphone

Trademark: N/A

Model name: M7

Standards: FCC Part 15.247

Test Procedure: ANSI C63.10-2013  
KDB 174176 D01 Line Conducted FAQ v01r01

*This device described above has been tested by Shenzhen Microtest Co., Ltd. and the test results show that the equipment under test (EUT) is in compliance with the FCC requirements. And it is applicable only to the tested sample identified in the report.*

Tested by:



Demi Mu

Nov. 13, 2018

Reviewed by:



Blue Zheng

Nov. 13, 2018

Approved by:



Smith Chen

Nov. 13, 2018

## 1 General Information

### 1.1 Description of EUT

Product name:	Bluetooth earphone
Model name:	M7
Serial model:	N/A
Difference in series models:	N/A
Operation frequency:	2402-2480MHz
Modulation type:	GFSK, $\pi/4$ -DQPSK
Bit Rate of transmitter:	1 Mbps, 2 Mbps
Antenna type:	PCB Antenna
Antenna gain:	0dBi
Max. output power:	-3.339dBm
Hardware version:	VA
Software version:	1.0
Power supply:	DC 3.7V from battery or DC 5V from adapter
Adapter information:	N/A
Battery:	DC 3.7V 45mAh

### 1.2 Operation channel list

Channel	Frequency (MHz)	Channel	Frequency (MHz)	Channel	Frequency (MHz)
00	2402	27	2429	54	2456
01	2403	28	2430	55	2457
02	2404	29	2431	56	2458
03	2405	30	2432	57	2459
04	2406	31	2433	58	2460
05	2407	32	2434	59	2461
06	2408	33	2435	60	2462
07	2409	34	2436	61	2463
08	2410	35	2437	62	2464
09	2411	36	2438	63	2465
10	2412	37	2439	64	2466
11	2413	38	2440	65	2467
12	2414	39	2441	66	2468

13	2415	40	2442	67	2469
14	2416	41	2443	68	2470
15	2417	42	2444	69	2471
16	2418	43	2445	70	2472
17	2419	44	2446	71	2473
18	2420	45	2447	72	2474
19	2421	46	2448	73	2475
20	2422	47	2449	74	2476
21	2423	48	2450	75	2477
22	2424	49	2451	76	2478
23	2425	50	2452	77	2479
24	2426	51	2453	78	2480
25	2427	52	2454	--	--
26	2428	53	2455	--	--

1.3 Test channel list

Channel	Channel	Frequency (MHz)
Low	00	2402
Middle	39	2441
High	79	2480

1.4 Ancillary equipment list

Equipment	Model	S/N	Manufacturer	Certificate type
Adapter	HW-059200CHQ	/	HUAWEI	/

1.5 Description of Support Units

The EUT has been tested as an independent unit together with other necessary accessories or support units. The following support units or accessories were used to form a representative test configuration during the tests.

Item	Equipment	Brand	Model/Type No.	Series No.	Note
/	/	/	/	/	/

Note:

(1)The support equipment was authorized by Declaration of Confirmation.

(2)For detachable type I/O cable should be specified the length in cm in 『Length』 column.

## 2 Summary of Test Results

Test procedures according to the technical standards:

No.	Standard Section	Test Item	Result	Remark
1	15.203	Antenna requirement	Pass	
2	15.247(b)(1)	Peak output power	Pass	
3	15.207	Conducted emission	Pass	
4	15.247(d)	Band edge	Pass	
5	15.205/15.209	Spurious emission	Pass	
6	15.247(a)(1)	20dB occupied bandwidth	Pass	
7	15.247(a)(1)	Carrier Frequencies Separation	Pass	
8	15.247(a)(1)	Hopping channel number	Pass	
9	15.247(a)(1)	Dwell time	Pass	
10	15.205	Spurious RF Conducted Emissions	Pass	

### 3 Test Facilities and Accreditations

#### 3.1 Test laboratory

Test Laboratory	Shenzhen Microtest Co., Ltd.
Location	No.102A & 302A, East Block, Hengfang Industrial Park, Xingye Road, Xixiang, Bao'an District, Shenzhen, Guangdong, China
FCC Registration No.:	448573

#### 3.2 Environmental conditions

Temperature:	20°C~30°C
Humidity	30%~70%
Atmospheric pressure	98kPa~101kPa

#### 3.3 Measurement uncertainty

The reported uncertainty of measurement  $y \pm U$  where expanded uncertainty  $U$  is based on a standard uncertainty multiplied by a coverage factor of  $k=2$  providing a level of confidence of approximately 95 %

No.	Item	Uncertainty
1	Conducted Emission Test	$\pm 1.38\text{dB}$
2	RF power, conducted	$\pm 0.16\text{dB}$
3	Spurious emissions, conducted	$\pm 0.21\text{dB}$
4	All emissions, radiated(<1G)	$\pm 4.68\text{dB}$
5	All emissions, radiated(>1G)	$\pm 4.89\text{dB}$
6	Temperature	$\pm 0.5^\circ\text{C}$
7	Humidity	$\pm 2\%$

#### 3.4 Test software

Software Name	Manufacturer	Model	Version
RF Test System	Farad	LZ-RF	Lz_Rf 3A3



## 4 Equipment List

Equipment No.	Equipment Name	Manufacturer	Model	Serial No.	Calibration date	Due date
MTI-E001	Spectrum Analyzer	Agilent	E4407B	MY41441082	2018/09/18	2019/09/17
MTI-E002	CMU 200 universal radio communication tester	Rohde&schwarz	CMU 200	114587	2018/09/18	2019/09/17
MTI-E004	EMI Test Receiver	Rohde&schwarz	ESPI	1000314	2018/09/18	2019/09/17
MTI-E006	Broadband antenna	schwarabeck	VULB9163	872	2018/09/18	2019/09/17
MTI-E007	Horn antenna	schwarabeck	BBHA9120D	1201	2018/09/18	2019/09/17
MTI-E014	amplifier	America	8447D	3113A06150	2018/09/18	2019/09/17
MTI-E015	Conduction Immunity Signal Generator	Schloder	CDG6000	126A1343/2015	2018/09/18	2019/09/17
MTI-E016	Coupled decoupling network	Schloder	CDA M2/M3	A2210332/2015	2018/09/18	2019/09/17
MTI-E032	Comprehensive test instrument	Rohde&schwarz	CMW500	124192	2018/09/18	2019/09/17
MTI-E034	amplifier	Agilent	8449B	3008A02400	2018/09/18	2019/09/17
MTI-E037	Artificial power network	Schwarzbeck	NSLK8127	#841	2018/09/18	2019/09/17
MTI-E040	Spectrum analyzer	Agilent	N9020A	MY49100060	2018/09/18	2019/09/17
MTI-E041	Signal generator	Agilent	N5182A	MY49060455	2018/09/18	2019/09/17
MTI-E042	Analog signal generator	Agilent	E4421B	GB40051240	2018/09/18	2019/09/17
MTI-E043	Power probe	Dare Instruments	RPR3006W	16100054SN016	2018/09/18	2019/09/17
MTI-E047	10dB attenuator	Mini-Circuits	UNAT-10+	15542	2018/09/18	2019/09/17
MTI-E049	spectrum analyzer	Rohde&schwarz	FSP-38	100019	2018/09/18	2019/09/17
MTI-E050	PSG Signal generator	Agilent	E8257D	MY46520873	2018/09/18	2019/09/17
MTI-E051	Active Loop Antenna 9kHz - 30MHz	Schwarzbeck	FMZB 1519 B	00044	2018/09/18	2019/09/17
MTI-E052	18-40GHz amplifier	Chengdu step Micro Technology	ZLNA-18-40G-21	1608001	2018/09/18	2019/09/17
MTI-E053	15-40G Antenna	Schwarzbeck	BBHA9170	BBHA9170582	2018/09/18	2019/09/17
MTI-E058	Artificial power network	Schwarzbeck	NSLK8127	#841	2018/09/18	2019/09/17

Note: the calibration interval of the above test instruments is 12 months and the calibrations are traceable to international system unit (SI).

## 5 Test Result

### 5.1 Antenna requirement

#### 5.1.1 Standard requirement

15.203 requirement: For intentional device, according to 15.203: an intentional radiator shall be designed to ensure that no antenna other than that furnished by the responsible party shall be used with the device

#### 5.1.2 EUT Antenna

The EUT antenna is PCB antenna (0dBi). It comply with the standard requirement. In case of replacement of broken antenna the same antenna type must be used.

## 5.2 Peak output power

### 5.2.1 Limit

FCC Part15 Subpart C			
Section	Test Item	Limit	Frequency Range (MHz)
15.247(b)(1)	Peak output power	Power<1W(30dBm)	2400-2483.5

### 5.2.2 Test setup

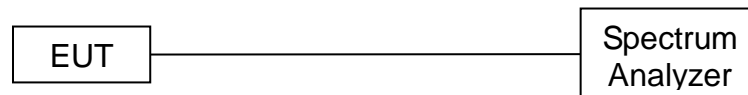

### 5.2.3 Test procedure

- (1) The EUT was directly connected to the spectrum analyzer and antenna output port as show in the block diagram above.
- (2) Spectrum Setting:  
 RBW=1MHz, VBW=3MHz, Detector=Peak (If 20dB BW ≤1 MHz)  
 RBW=3MHz, VBW=8MHz, Detector=Peak (If 20dB BW > 1 MHz)
- (3) The EUT was set to continuously transmitting in the max power during the test.

### 5.2.4 Test results

Test data

EUT :	Bluetooth earphone	Model Name :	M7
Temperature :	25 °C	Relative Humidity :	60%
Pressure :	1012 hPa	Test Voltage :	DC 3.7V by battery

GFSK

Test Channel	Frequency (MHz)	Maximum Peak Output Power(dBm)	Limit (dBm)
CH00	2402	-5.027	30
CH39	2441	-5.144	30
CH78	2480	-5.706	30

$\pi/4$ -DQPSK

Test Channel	Frequency (MHz)	Maximum Peak Output Power(dBm)	Limit (dBm)
CH00	2402	-3.786	20.97
CH39	2441	-3.339	20.97
CH78	2480	-3.878	20.97

Test plots

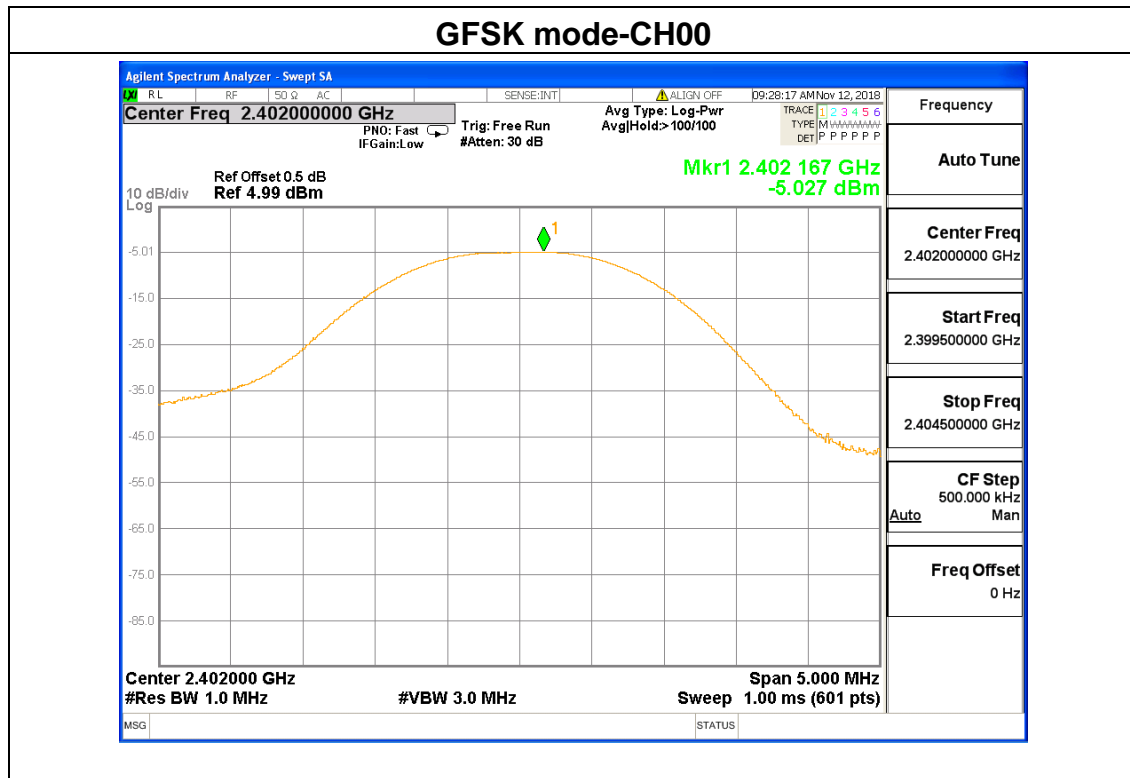

### GFSK mode-CH39

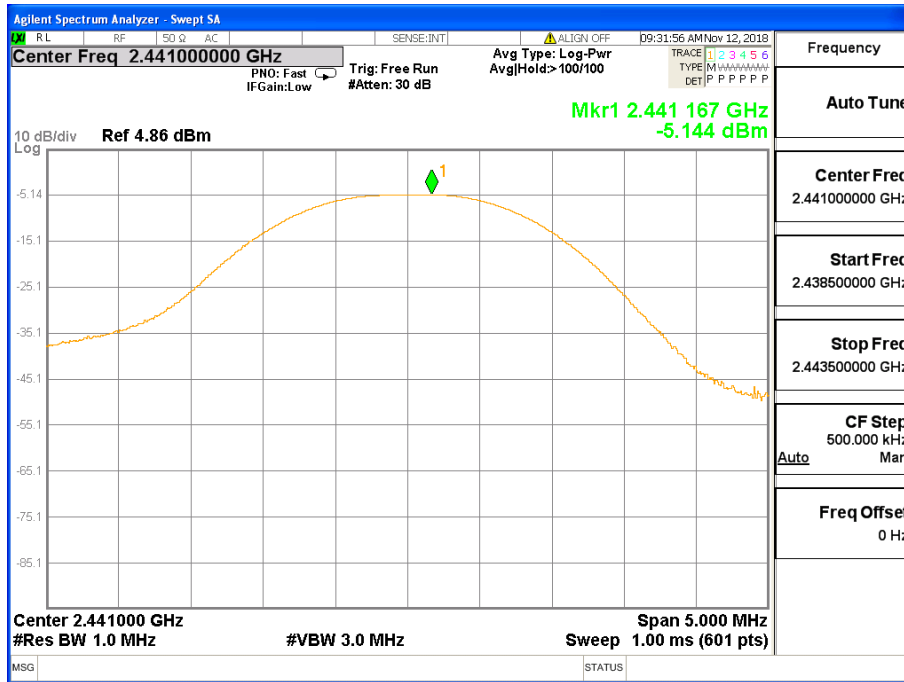

### GFSK mode-CH78

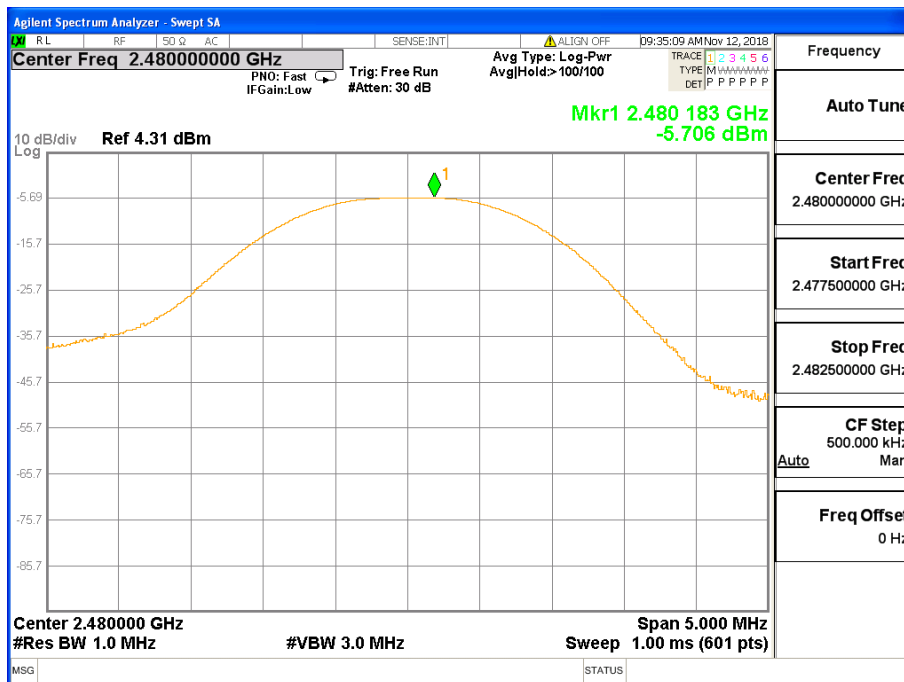

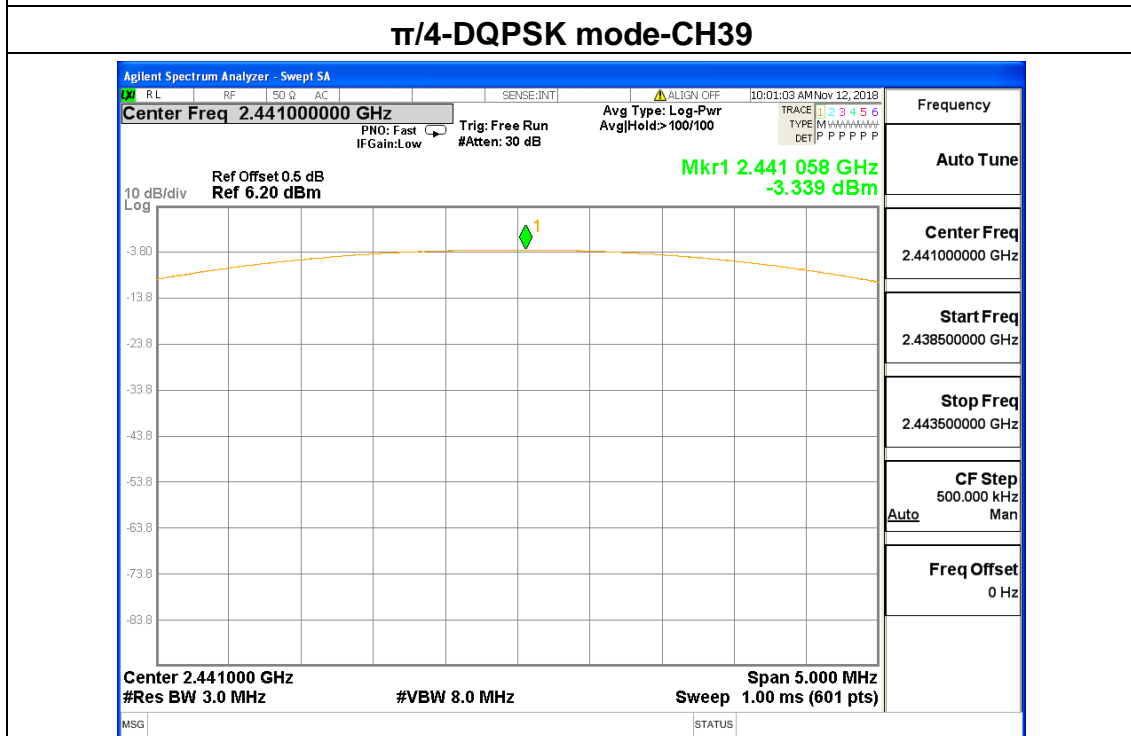
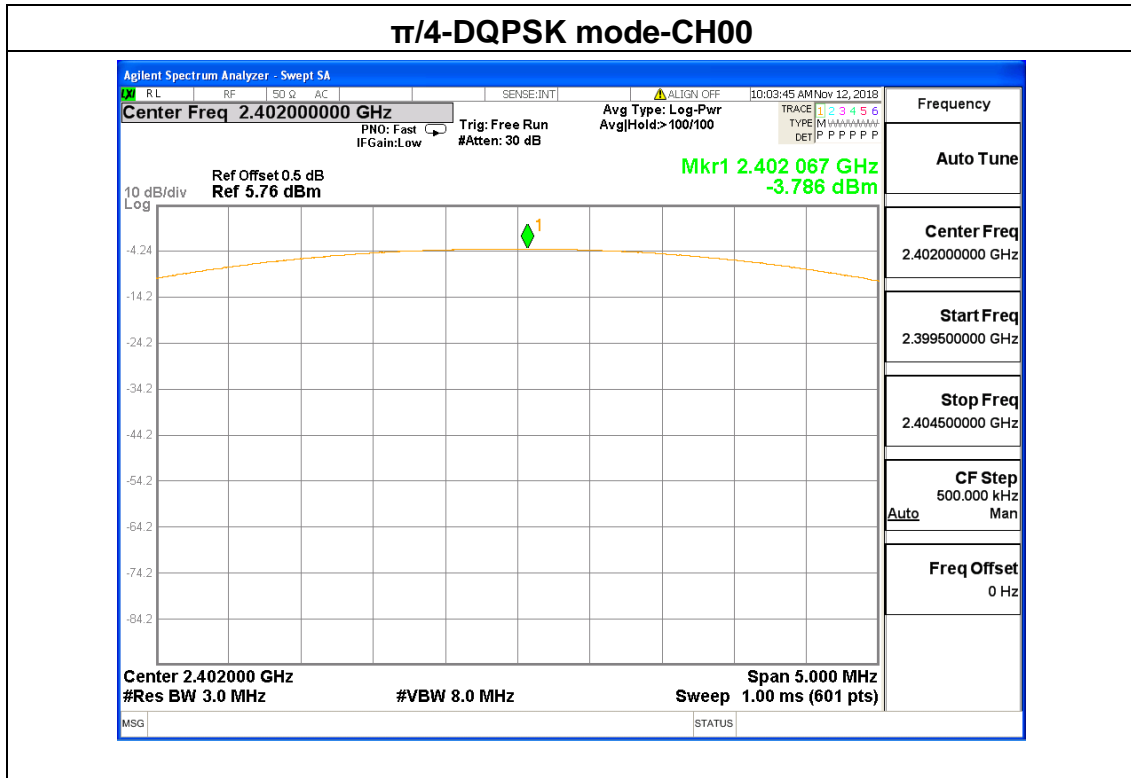

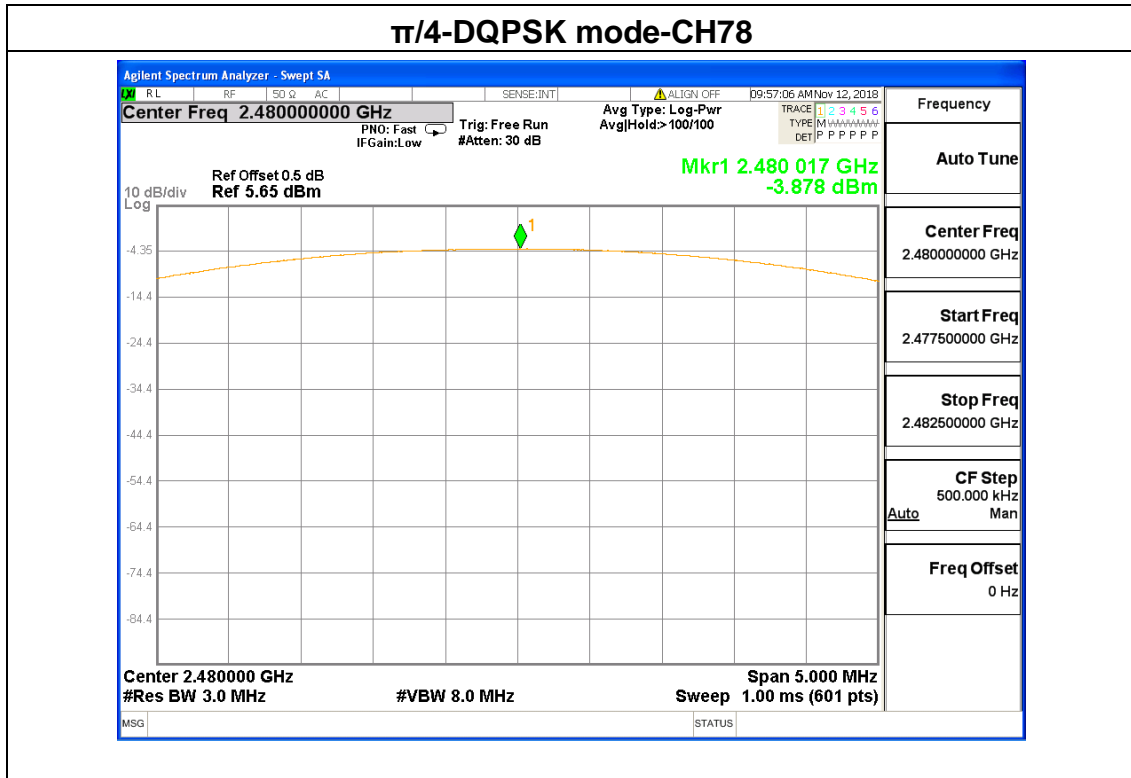

### 5.3 Conducted emission

#### 5.3.1 Limits

FREQUENCY (MHz)	Class B (dBuV)	
	Quasi-peak	Average
0.15 -0.5	66 - 56 *	56 - 46 *
0.50 -5.0	56.00	46.00
5.0 -30.0	60.00	50.00

**Note**

(1)The tighter limit applies at the band edges.

(2)The limit of " \* " marked band means the limitation decreases linearly with the logarithm of the frequency in the range.

#### 5.3.2 Test setup

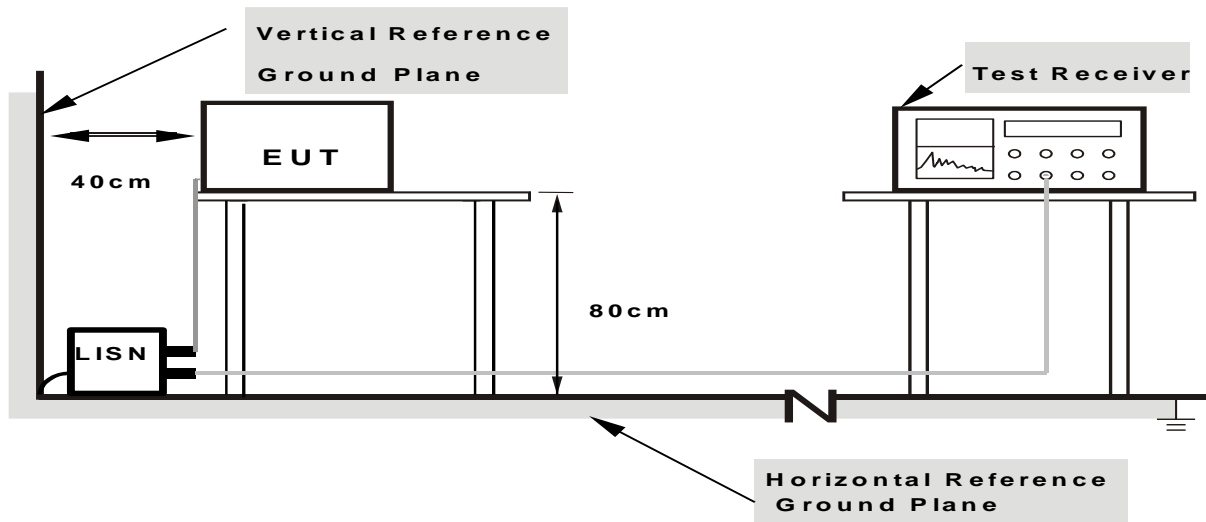

**Note: 1.Support units were connected to second LISN.**

**2.Both of LISNs (AMN) are 80 cm from EUT and at least 80 cm from other units and other metal planes**



### 5.3.3 Test procedure

#### a. EUT Operating Conditions

The EUT was configured for testing in a typical fashion (as a customer would normally use it). The EUT has been programmed to continuously transmit during test. This operating condition was tested and used to collect the included data.

#### b. The following table is the setting of the receiver

Receiver Parameters	Setting
Attenuation	10 dB
Start Frequency	0.15 MHz
Stop Frequency	30 MHz
IF Bandwidth	9 kHz

- c. The EUT was placed 0.8 meters from the horizontal ground plane with EUT being connected to the power mains through a line impedance stabilization network (LISN). All other support equipments powered from additional LISN(s). The LISN provide 50 Ohm/ 50uH of coupling impedance for the measuring instrument.
- d. Interconnecting cables that hang closer than 40 cm to the ground plane shall be folded back and forth in the center forming a bundle 30 to 40 cm long.
- e. I/O cables that are not connected to a peripheral shall be bundled in the center. The end of the cable may be terminated, if required, using the correct terminating impedance. The overall length shall not exceed 1 m.
- f. LISN at least 80 cm from nearest part of EUT chassis.

For the actual test configuration, please refer to the related Item –EUT Test Photos.

### 5.3.4 Test results

Test data

EUT :	Bluetooth earphone	Model Name :	M7
Temperature :	26 °C	Relative Humidity :	54%
Pressure :	1010hPa	Phase :	L
Test Voltage :	DC 5V from adapter AC 120V/60Hz	Test Mode :	Normal link

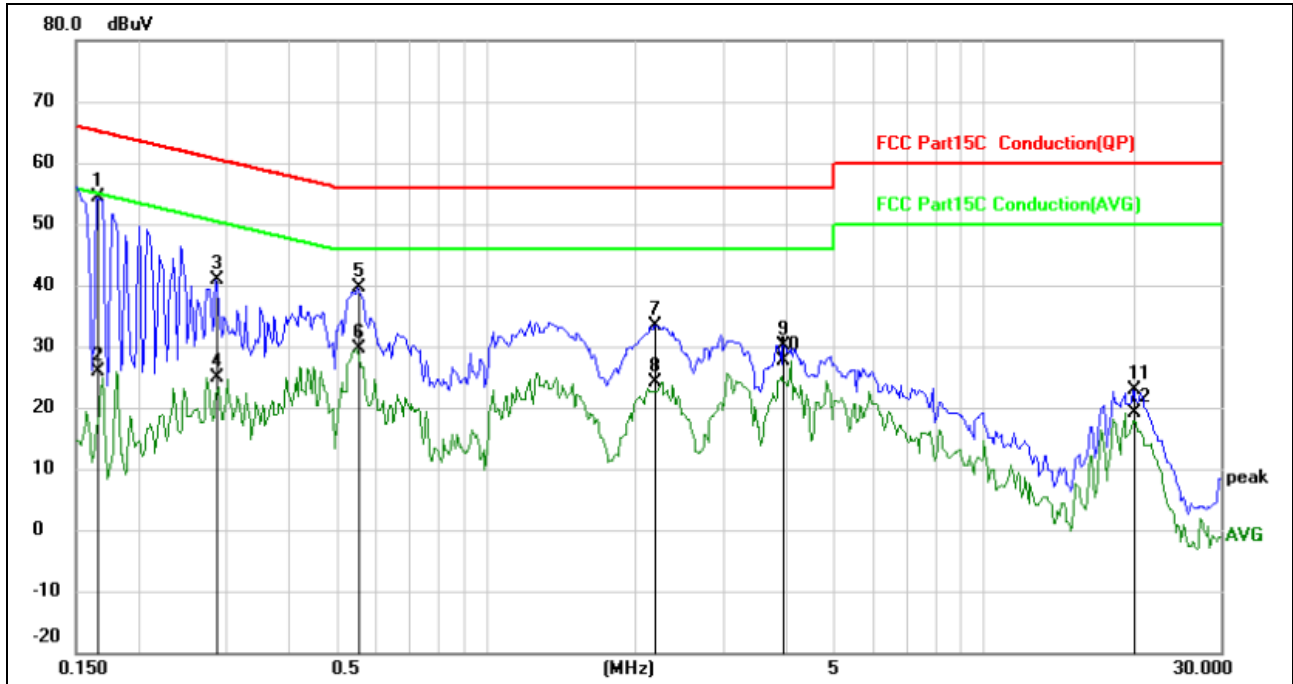

No.	Mk.	Freq. MHz	Reading Level dBuV	Correct Factor dB	Measure- ment dBuV	Limit dBuV	Over dB	Detector	Comment
1	*	0.1655	52.70	1.57	54.27	65.18	-10.91	QP	
2		0.1655	24.31	1.57	25.88	55.18	-29.30	AVG	
3		0.2867	39.23	1.57	40.80	60.62	-19.82	QP	
4		0.2867	23.31	1.57	24.88	50.62	-25.74	AVG	
5		0.5523	38.13	1.57	39.70	56.00	-16.30	QP	
6		0.5523	27.96	1.57	29.53	46.00	-16.47	AVG	
7		2.1891	32.00	1.45	33.45	56.00	-22.55	QP	
8		2.1891	22.66	1.45	24.11	46.00	-21.89	AVG	
9		3.9570	29.34	0.90	30.24	56.00	-25.76	QP	
10		3.9570	26.77	0.90	27.67	46.00	-18.33	AVG	
11		20.0195	22.68	0.30	22.98	60.00	-37.02	QP	
12		20.0195	18.93	0.30	19.23	50.00	-30.77	AVG	

EUT :	Bluetooth earphone	Model Name :	M7
Temperature :	26 °C	Relative Humidity :	54%
Pressure :	1010hPa	Phase :	N
Test Voltage :	DC 5V from adapter AC 120V/60Hz	Test Mode :	Normal link

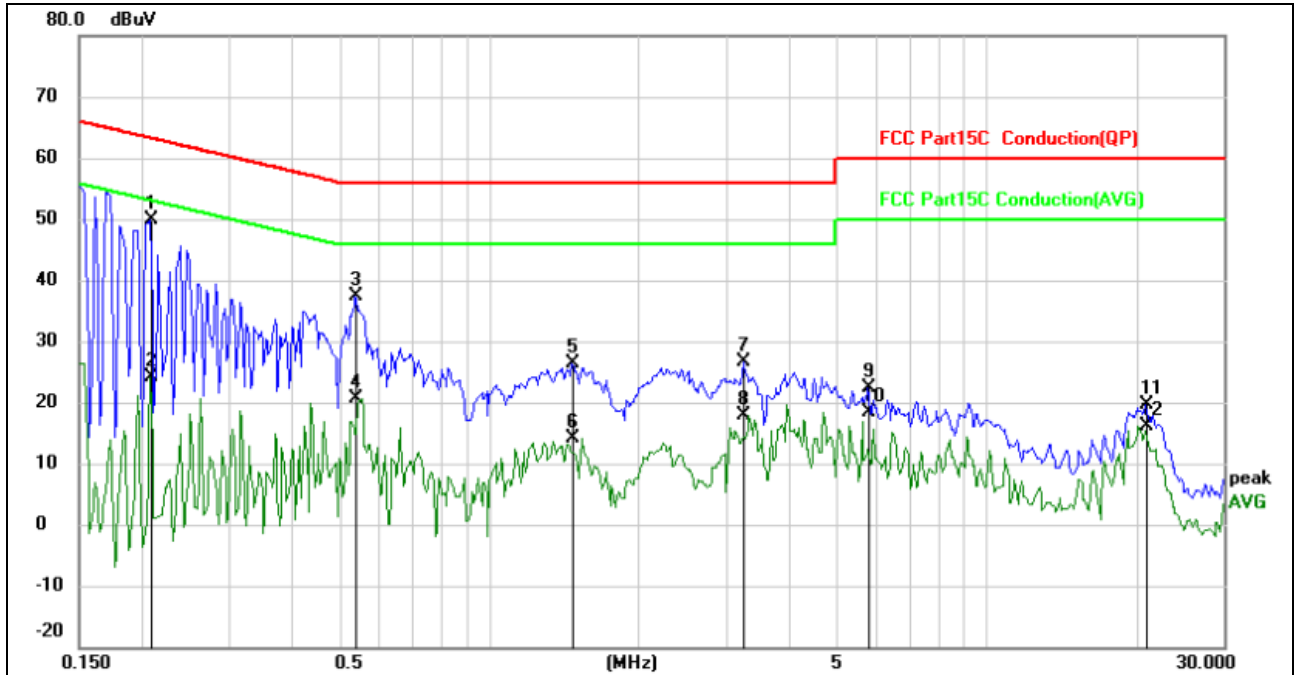

No.	Mk.	Freq. MHz	Reading Level dBuV	Correct Factor dB	Measure- ment dBuV	Limit dBuV	Over dB	Detector	Comment
1	*	0.2086	48.25	1.57	49.82	63.26	-13.44	QP	
2		0.2086	22.58	1.57	24.15	53.26	-29.11	AVG	
3		0.5406	35.70	1.57	37.27	56.00	-18.73	QP	
4		0.5406	19.16	1.57	20.73	46.00	-25.27	AVG	
5		1.4703	24.70	1.58	26.28	56.00	-29.72	QP	
6		1.4703	12.46	1.58	14.04	46.00	-31.96	AVG	
7		3.2461	25.68	0.99	26.67	56.00	-29.33	QP	
8		3.2461	16.79	0.99	17.78	46.00	-28.22	AVG	
9		5.7813	21.96	0.35	22.31	60.00	-37.69	QP	
10		5.7813	17.99	0.35	18.34	50.00	-31.66	AVG	
11		20.8555	19.25	0.31	19.56	60.00	-40.44	QP	
12		20.8555	15.88	0.31	16.19	50.00	-33.81	AVG	

EUT :	Bluetooth earphone	Model Name :	M7
Temperature :	26 °C	Relative Humidity :	54%
Pressure :	1010hPa	Phase :	L
Test Voltage :	DC 5V from adapter AC 240V/60Hz	Test Mode :	Normal link

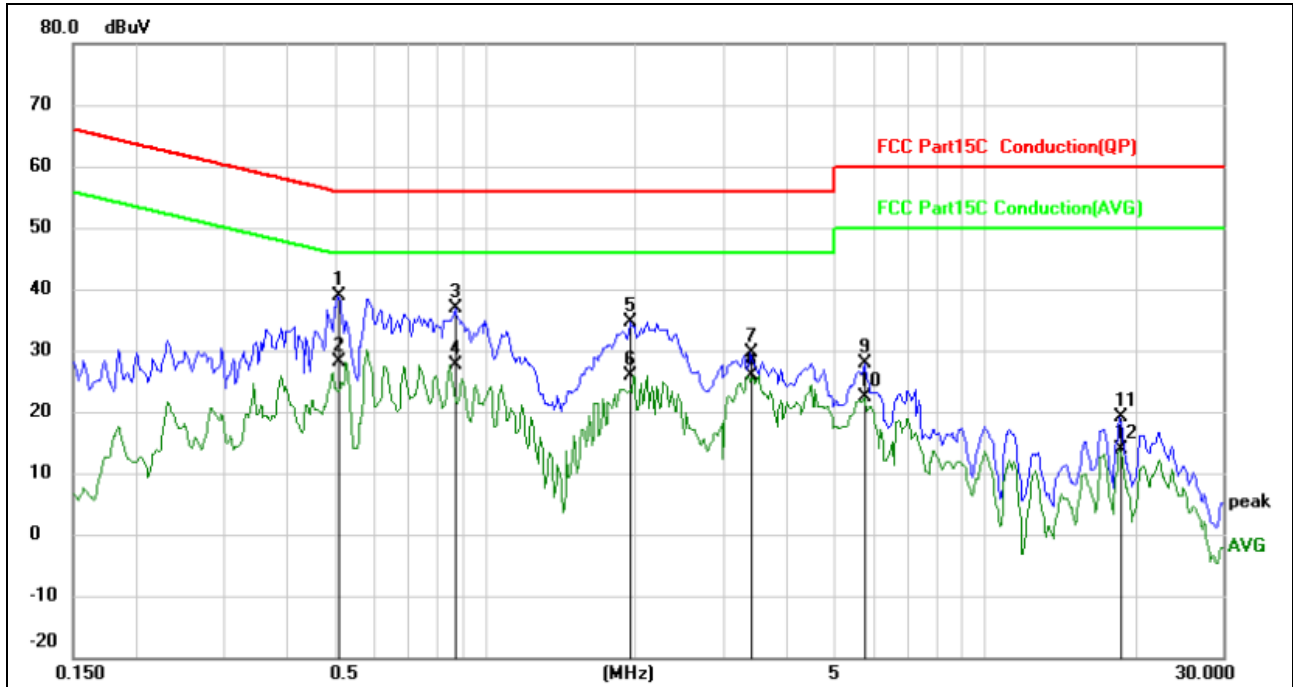

No.	Mk.	Freq.	Reading Level	Correct Factor	Measurement	Limit	Over	Detector	Comment
		MHz	dBuV	dB	dBuV	dBuV	dB		
1	*	0.5094	38.75	0.02	38.77	56.00	-17.23	QP	
2		0.5094	28.02	0.02	28.04	46.00	-17.96	AVG	
3		0.8727	36.75	0.02	36.77	56.00	-19.23	QP	
4		0.8727	27.59	0.02	27.61	46.00	-18.39	AVG	
5		1.9547	34.60	0.02	34.62	56.00	-21.38	QP	
6		1.9547	25.88	0.02	25.90	46.00	-20.10	AVG	
7		3.4063	29.62	0.04	29.66	56.00	-26.34	QP	
8		3.4063	25.81	0.04	25.85	46.00	-20.15	AVG	
9		5.7656	27.75	0.06	27.81	60.00	-32.19	QP	
10		5.7656	22.44	0.06	22.50	50.00	-27.50	AVG	
11		18.6484	18.97	0.09	19.06	60.00	-40.94	QP	
12		18.6484	13.78	0.09	13.87	50.00	-36.13	AVG	

EUT :	Bluetooth earphone	Model Name :	M7
Temperature :	26 °C	Relative Humidity :	54%
Pressure :	1010hPa	Phase :	N
Test Voltage :	DC 5V from adapter AC 240V/60Hz	Test Mode :	Normal link

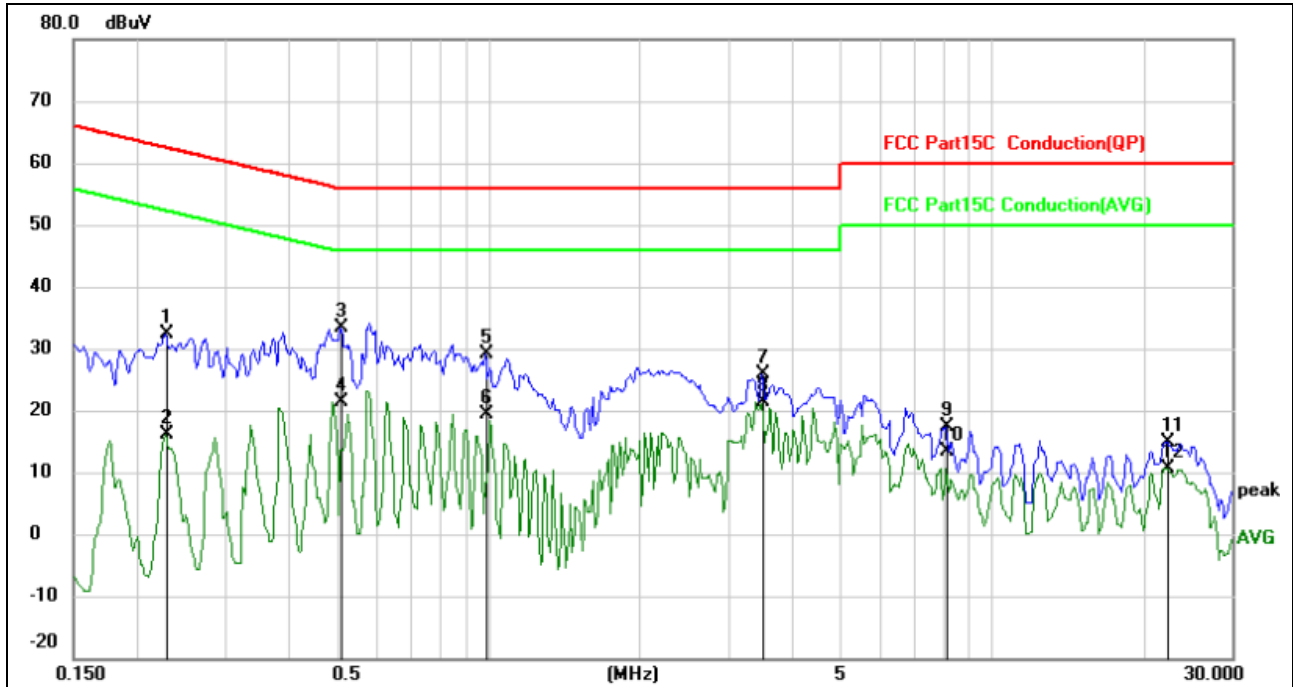

No.	Mk.	Freq. MHz	Reading Level dBuV	Correct Factor dB	Measure- ment dBuV	Limit dBuV	Over dB	Detector	Comment
1		0.2281	32.41	0.02	32.43	62.52	-30.09	QP	
2		0.2281	16.19	0.02	16.21	52.52	-36.31	AVG	
3	*	0.5094	33.32	0.02	33.34	56.00	-22.66	QP	
4		0.5094	21.28	0.02	21.30	46.00	-24.70	AVG	
5		0.9859	29.04	0.02	29.06	56.00	-26.94	QP	
6		0.9859	19.42	0.02	19.44	46.00	-26.56	AVG	
7		3.4961	25.85	0.04	25.89	56.00	-30.11	QP	
8		3.4961	21.27	0.04	21.31	46.00	-24.69	AVG	
9		8.1055	17.18	0.08	17.26	60.00	-42.74	QP	
10		8.1055	13.35	0.08	13.43	50.00	-36.57	AVG	
11		22.2734	14.84	0.11	14.95	60.00	-45.05	QP	
12		22.2734	10.54	0.11	10.65	50.00	-39.35	AVG	

## 5.4 Radiated spurious emission

### 5.4.1 Limits

20dBc in any 100 kHz bandwidth outside the operating frequency band. In case the emission fall within the restricted band specified on 15.205(a), then the 15.209(a) limit in the table below has to be followed.

Frequency (MHz)	Field Strength (microvolts/meter)	Measurement Distance (meters)
0.009~0.490	2400/F(KHz)	300
0.490~1.705	24000/F(KHz)	30
1.705~30.0	30	30
30~88	100	3
88~216	150	3
216~960	200	3
Above 960	500	3

Spectrum Parameter	Setting
Attenuation	Auto
Start Frequency	1000 MHz
Stop Frequency	10th carrier harmonic
RB / VB (emission in restricted band)	1 MHz / 1 MHz for Peak, 1 MHz / 10Hz for Average

Receiver Parameter	Setting
Attenuation	Auto
Start ~ Stop Frequency	9kHz~150kHz / RB 200Hz for QP
Start ~ Stop Frequency	150kHz~30MHz / RB 9kHz for QP
Start ~ Stop Frequency	30MHz~1000MHz / RB 120kHz for QP

5.4.2 Test setup

Radiated emission test-up frequency below 30MHz

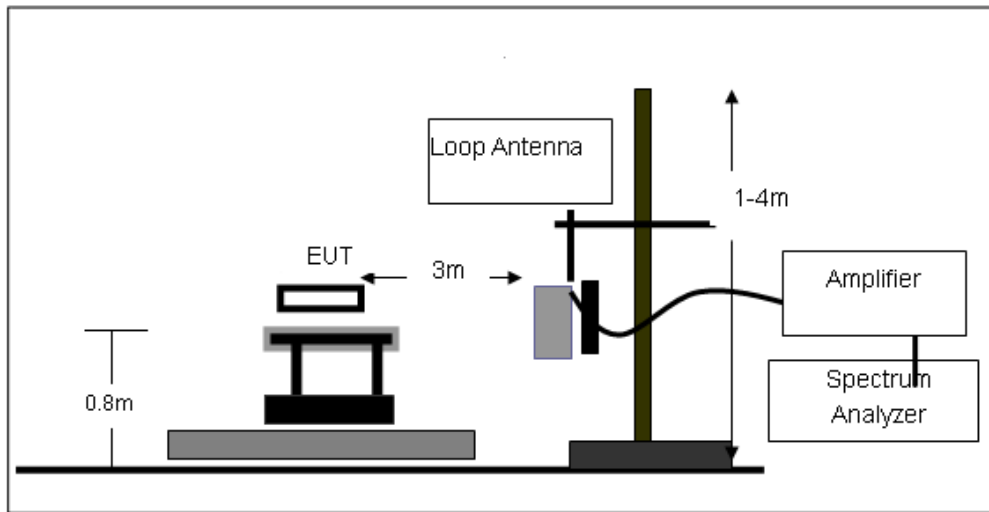

Radiated emission test-up frequency 30MHz~1GHz

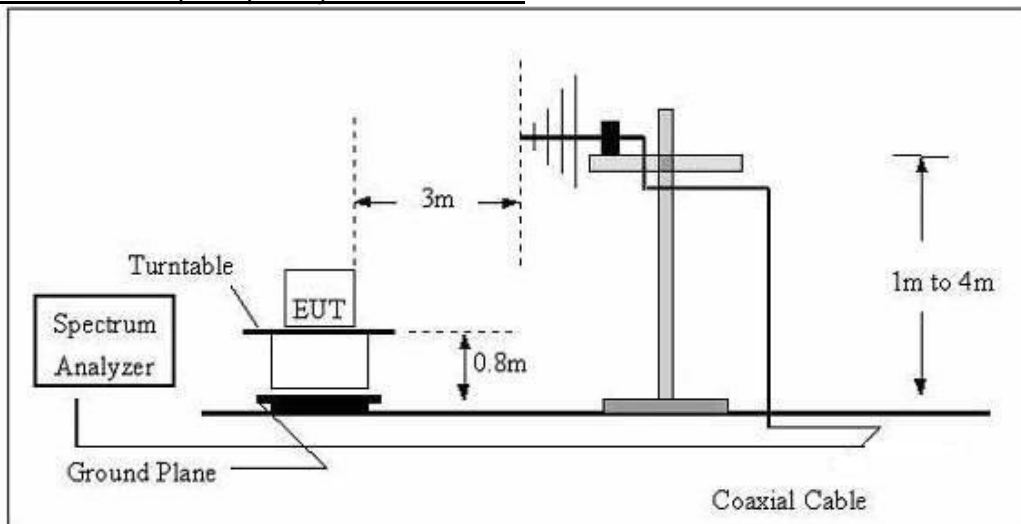

Radiated emission test-up frequency above 1GHz

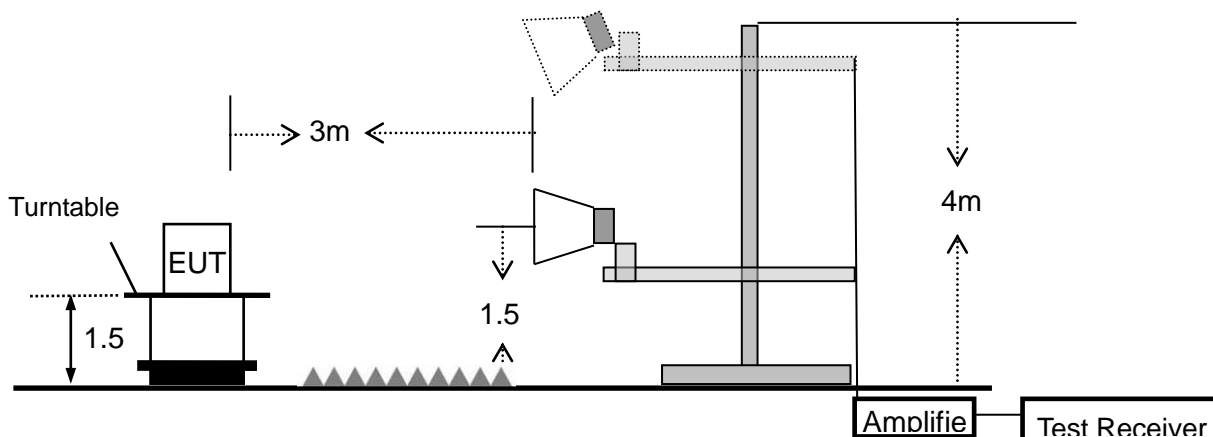

5.4.3 Test procedure

- a. EUT operating conditions. The EUT tested system was configured as the statements of 2.4 Unless otherwise a special operating condition is specified in the follows during the testing.
- b. The measuring distance of at 3 m shall be used for measurements at frequency up to 1GHz. For frequencies above 1GHz, any suitable measuring distance may be used.
- c. The EUT was placed on the top of a rotating table 0.8 meters above the ground at a 3 meter open area test site. The table was rotated 360 degrees to determine the position of the highest radiation.
- d. The height of the equipment or of the substitution antenna shall be 0.8 m; the height of the test antenna shall vary between 1 m to 4 m. Both horizontal and vertical polarizations of the antenna are set to make the measurement.
- e. The initial step in collecting conducted emission data is a spectrum analyzer peak detector mode pre-scanning the measurement frequency range. Significant peaks are then marked and then Quasi Peak detector mode re-measured.
- f. If the Peak Mode measured value compliance with and lower than Quasi Peak Mode Limit, the EUT shall be deemed to meet QP Limits and then no additional QP Mode measurement performed.
- g. For the actual test configuration, please refer to the related Item –EUT Test photos.

Note: Both horizontal and vertical antenna polarities were tested and performed pretest to three orthogonal axis. The worst case emissions were reported.

During the radiated emission test, the Spectrum Analyzer was set with the following configurations:

Frequency Band (MHz)	Function	Resolution bandwidth	Video Bandwidth
30 to 1000	QP	120 kHz	300 kHz
Above 1000	Peak	1 MHz	1 MHz
	Average	1 MHz	10 Hz

Note: for the frequency ranges below 30 MHz, a narrower RBW is used for these ranges but the measured value should add a RBW correction factor (RBWCF) where  $RBWCF [dB] = 10 \cdot \lg(100 [kHz]/\text{narrower RBW [kHz]})$ . , the narrower RBW is 1 kHz and RBWCF is 20 dB for the frequency 9 kHz to 150 kHz, and the narrower RBW is 10 kHz and RBWCF is 10 dB for the frequency 150 kHz to 30 MHz.



5.4.4 Test results

5.4.4.1 Radiation emission

Below 30MHz

EUT :	Bluetooth earphone	Model Name :	M7
Temperature:	20 °C	Relative Humidity:	48%
Pressure:	1010 hPa	Test Voltage:	DC 5V from adapter
Test Mode:	TX	Polarization :	--

Freq.	Reading	Limit	Margin	State
(MHz)	(dBuV/m)	(dBuV/m)	(dB)	P/F
--	--	--	--	Pass
--	--	--	--	Pass

Note:

The amplitude of spurious emissions which are attenuated by more than 20dB below the permissible value has no need to be reported.

Distance extrapolation factor =  $40 \log(\text{specific distance}/\text{test distance})$ (dB);

Limit line = specific limits(dBuV) + distance extrapolation factor.

Between 30MHz – 1GHz

Note1 : Emission Level = Meter Reading + Factor, Margin= Emission Level- Limit, Factor = Antenna Factor + Cable Loss – Pre-amplifier.

Note2: The three modulated high, medium and low channels have been tested. The report only shows the worst mode. The worst mode is  $\pi/4$ -DQPSK CH39

EUT :	Bluetooth earphone	Model Name :	M7
Relative Humidity:	52%	Phase:	Horizontal
Pressure:	1010 hPa	Test Voltage :	DC 5V from adapter
Test Mode :	TX Mode $\pi/4$ -DQPSK/CH39		

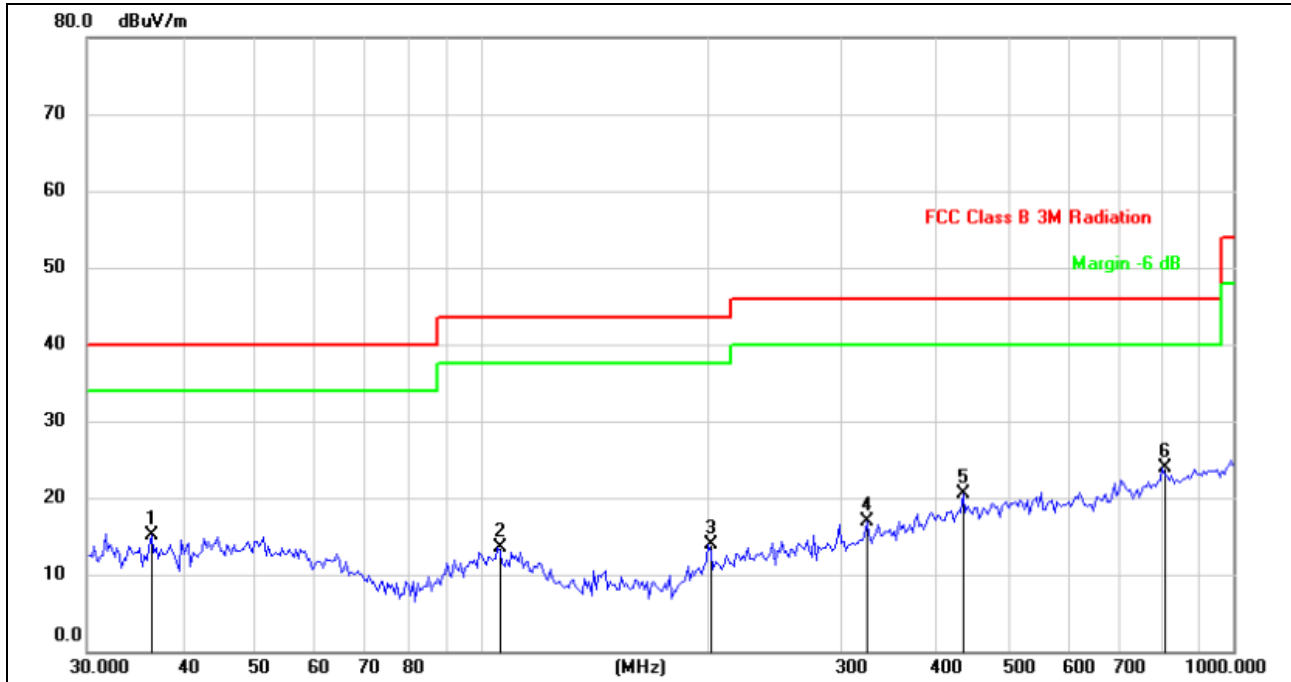

No.	Mk.	Freq.	Reading Level	Correct Factor	Measurement	Limit	Over	Detector
		MHz	dBuV	dBuV/m	dBuV/m	dBuV/m	dB	
1		36.5092	25.59	-10.39	15.20	40.00	-24.80	QP
2		105.2718	24.88	-11.44	13.44	43.50	-30.06	QP
3		200.6881	25.69	-11.70	13.99	43.50	-29.51	QP
4		325.5958	24.96	-8.10	16.86	46.00	-29.14	QP
5		437.1199	26.43	-6.00	20.43	46.00	-25.57	QP
6	*	804.6028	26.57	-2.73	23.84	46.00	-22.16	QP

EUT :	Bluetooth earphone	Model Name :	M7
Relative Humidity:	52%	Phase:	Vertical
Pressure:	1010 hPa	Test Voltage :	DC 5V from adapter
Test Mode :	TX Mode $\pi$ /4-DQPSK/CH39		

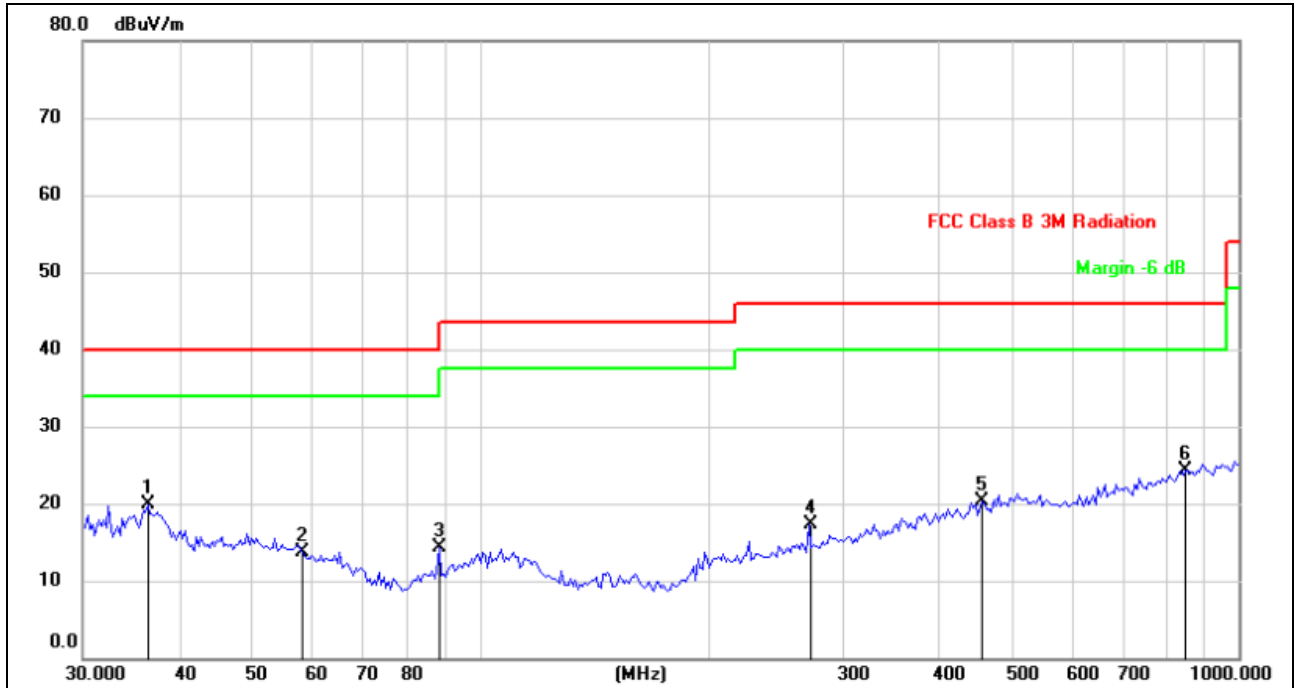

No.	Mk.	Freq. MHz	Reading Level dBuV	Correct Factor dBuV/m	Measure- ment dBuV/m	Limit dBuV/m	Over dB	Detector
1	*	36.5092	30.95	-11.09	19.86	40.00	-20.14	QP
2		58.4074	24.69	-10.94	13.75	40.00	-26.25	QP
3		88.3421	27.83	-13.51	14.32	43.50	-29.18	QP
4		271.3246	25.78	-8.42	17.36	46.00	-28.64	QP
5		459.1144	26.06	-5.68	20.38	46.00	-25.62	QP
6		851.0353	26.28	-2.02	24.26	46.00	-21.74	QP

**1G-25GHz**

- Note: (1) All Readings are Peak Value (VBW=3MHz) and AV Value (VBW=10Hz).  
 (2) Emission Level= Antenna Factor + Cable Loss + Read Level - Preamp Factor  
 (3) All other emissions more than 20dB below the limit.

All the modulation modes have been tested, and the worst result was report as below:

Frequency (MHz)	Read Level (dBμV)	Cable loss (dB)	Antenna Factor dB/m	Preamp Factor (dB)	Emission Level (dBμV/m)	Limits (dBμV/m)	Margin (dB)	Remark	Comment
Low Channel (2402 MHz)(π/4-DQPSK)--Above 1G									
4804.03	62.81	5.21	35.59	44.30	59.31	74.00	-14.69	Pk	Vertical
4804.03	41.09	5.21	35.59	44.30	37.59	54.00	-16.41	AV	Vertical
7206.27	61.31	6.48	36.27	44.60	59.46	74.00	-14.54	Pk	Vertical
7206.27	44.72	6.48	36.27	44.60	42.87	54.00	-11.13	AV	Vertical
4804.11	61.28	5.21	35.55	44.30	57.74	74.00	-16.26	Pk	Horizontal
4804.11	44.24	5.21	35.55	44.30	40.70	54.00	-13.30	AV	Horizontal
7206.22	63.75	6.48	36.27	44.52	61.98	74.00	-12.02	Pk	Horizontal
7206.22	48.34	6.48	36.27	44.52	46.57	54.00	-7.43	AV	Horizontal
Mid Channel (2441 MHz)(π/4-DQPSK)--Above 1G									
4882.4	62.96	5.21	35.66	44.20	59.63	74.00	-14.37	Pk	Vertical
4882.4	43.68	5.21	35.66	44.20	40.35	54.00	-13.65	AV	Vertical
7323.24	60.52	7.10	36.50	44.43	59.69	74.00	-14.31	Pk	Vertical
7323.24	48.11	7.10	36.50	44.43	47.28	54.00	-6.72	AV	Vertical
4882.11	61.49	5.21	35.66	44.20	58.16	74.00	-15.84	Pk	Horizontal
4882.11	48.07	5.21	35.66	44.20	44.74	54.00	-9.26	AV	Horizontal
7323.13	60.32	7.10	36.50	44.43	59.49	74.00	-14.51	Pk	Horizontal
7323.13	42.41	7.10	36.50	44.43	41.58	54.00	-12.42	AV	Horizontal
High Channel (2480 MHz)(π/4-DQPSK)-- Above 1G									
4960.4	66.52	5.21	35.52	44.21	63.04	74.00	-10.96	Pk	Vertical
4960.4	44.06	5.21	35.52	44.21	40.58	54.00	-13.42	AV	Vertical
7440.2	61.19	7.10	36.53	44.60	60.22	74.00	-13.78	Pk	Vertical
7440.2	46.13	7.10	36.53	44.60	45.16	54.00	-8.84	AV	Vertical
4960.23	67.90	5.21	35.52	44.21	64.42	74.00	-9.58	Pk	Horizontal
4960.23	47.73	5.21	35.52	44.21	44.25	54.00	-9.75	AV	Horizontal
7440.3	62.38	7.10	36.53	44.60	61.41	74.00	-12.59	Pk	Horizontal
7440.3	44.78	7.10	36.53	44.60	43.81	54.00	-10.19	AV	Horizontal

5.4.4.2 Band edge – radiated

All the modulation modes have been tested, and the worst result was report as below:

Frequency (MHz)	Meter Reading (dBμV)	Cable Loss (dB)	Antenna Factor dB/m	Preamp Factor (dB)	Emission Level (dBμV/m)	Limits (dBμV/m)	Margin (dB)	Detector Type	Comment
1Mbps (π/4-DQPSK)-hopping									
2310.00	56.36	2.97	27.80	43.80	43.33	74	-30.67	Pk	Horizontal
2310.00	44.90	2.97	27.80	43.80	31.87	54	-22.13	AV	Horizontal
2310.00	58.76	2.97	27.80	43.80	45.73	74	-28.27	Pk	Vertical
2310.00	43.21	2.97	27.80	43.80	30.18	54	-23.82	AV	Vertical
2390.00	58.01	3.14	27.21	43.80	44.56	74	-29.44	Pk	Vertical
2390.00	43.48	3.14	27.21	43.80	30.03	54	-23.97	AV	Vertical
2390.00	57.27	3.14	27.21	43.80	43.82	74	-30.18	Pk	Horizontal
2390.00	42.73	3.14	27.21	43.80	29.28	54	-24.72	AV	Horizontal
2483.50	57.76	3.58	27.70	44.00	45.04	74	-28.96	Pk	Vertical
2483.50	43.16	3.58	27.70	44.00	30.44	54	-23.56	AV	Vertical
2483.50	58.76	3.58	27.70	44.00	46.04	74	-27.96	Pk	Horizontal
2483.50	42.54	3.58	27.70	44.00	29.82	54	-24.18	AV	Horizontal
1Mbps(π/4-DQPSK)- Non-hopping									
2310.00	56.36	2.97	27.80	43.80	43.33	74	-30.67	Pk	Horizontal
2310.00	43.41	2.97	27.80	43.80	30.38	54	-23.62	AV	Horizontal
2310.00	58.38	2.97	27.80	43.80	45.35	74	-28.65	Pk	Vertical
2310.00	43.04	2.97	27.80	43.80	30.01	54	-23.99	AV	Vertical
2390.00	57.90	3.14	27.21	43.80	44.45	74	-29.55	Pk	Vertical
2390.00	42.34	3.14	27.21	43.80	28.89	54	-25.11	AV	Vertical
2390.00	57.05	3.14	27.21	43.80	43.60	74	-30.40	Pk	Horizontal
2390.00	42.76	3.14	27.21	43.80	29.31	54	-24.69	AV	Horizontal
2483.50	58.84	3.58	27.70	44.00	46.12	74	-27.88	Pk	Vertical
2483.50	42.99	3.58	27.70	44.00	30.27	54	-23.73	AV	Vertical
2483.50	59.35	3.58	27.70	44.00	46.63	74	-27.37	Pk	Horizontal
2483.50	42.88	3.58	27.70	44.00	30.16	54	-23.84	AV	Horizontal

5.4.4.3 Spurious Emission in Restricted Band 3260MHz-18000MHz

All the modulation modes have been tested, and the worst result was report as below:

Frequency (MHz)	Reading Level (dB $\mu$ V)	Cable Loss (dB)	Antenna Factor (dB/m)	Preamp Factor (dB)	Emission Level (dB $\mu$ V/m)	Limits (dB $\mu$ V/m)	Margin (dB)	Detector Type	Comment
3260	60.54	4.04	29.57	44.70	49.45	74	-24.55	Pk	Vertical
3260	50.16	4.04	29.57	44.70	39.07	54	-14.93	AV	Vertical
3260	61.09	4.04	29.57	44.70	50.00	74	-24.00	Pk	Horizontal
3260	51.25	4.04	29.57	44.70	40.16	54	-13.84	AV	Horizontal
3332	64.38	4.26	29.87	44.40	54.11	74	-19.89	Pk	Vertical
3332	53.25	4.26	29.87	44.40	42.98	54	-11.02	AV	Vertical
3332	62.81	4.26	29.87	44.40	52.54	74	-21.46	Pk	Horizontal
3332	54.15	4.26	29.87	44.40	43.88	54	-10.12	AV	Horizontal
17797	43.55	10.99	43.95	43.50	54.99	74	-19.01	Pk	Vertical
17797	33.97	10.99	43.95	43.50	45.41	54	-8.59	AV	Vertical
17788	44.64	11.81	43.69	44.60	55.54	74	-18.46	Pk	Horizontal
17788	32.39	11.81	43.69	44.60	43.29	54	-10.71	AV	Horizontal

## 5.5 20dB occupied channel bandwidth

### 5.5.1 Limit

FCC Part15 (15.247) , Subpart C			
Section	Test Item	Limit	Frequency Range (MHz)
15.247a(1)	20dB bandwidth	N/A	2400-2483.5

### 5.5.2 Test setup

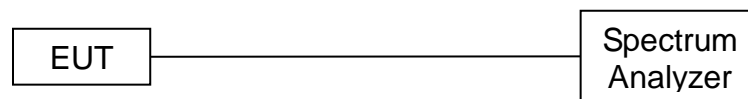

### 5.5.3 Test procedure

- (1) The EUT was directly connected to the spectrum analyzer and antenna output port as show in the block diagram above.
- (2) Spectrum Setting:  
Bandwidth: RBW=30 kHz, VBW=100 kHz, detector= Peak

### 5.5.4 Test results

Test data

EUT :	Bluetooth earphone	Model Name :	M7
Temperature :	25 °C	Relative Humidity :	60%
Pressure :	1012 hPa	Test Voltage :	DC 3.7V by battery

Mode	Frequency (MHz)	20dB Bandwidth (MHz)	Limit (kHz)	Result
GFSK	2402	0.9484	N/A	Pass
	2441	0.9465	N/A	Pass
	2480	0.9500	N/A	Pass
$\pi$ /4-DQPSK	2402	1.281	N/A	Pass
	2441	1.278	N/A	Pass
	2480	1.278	N/A	Pass



Test plots

GFSK mode

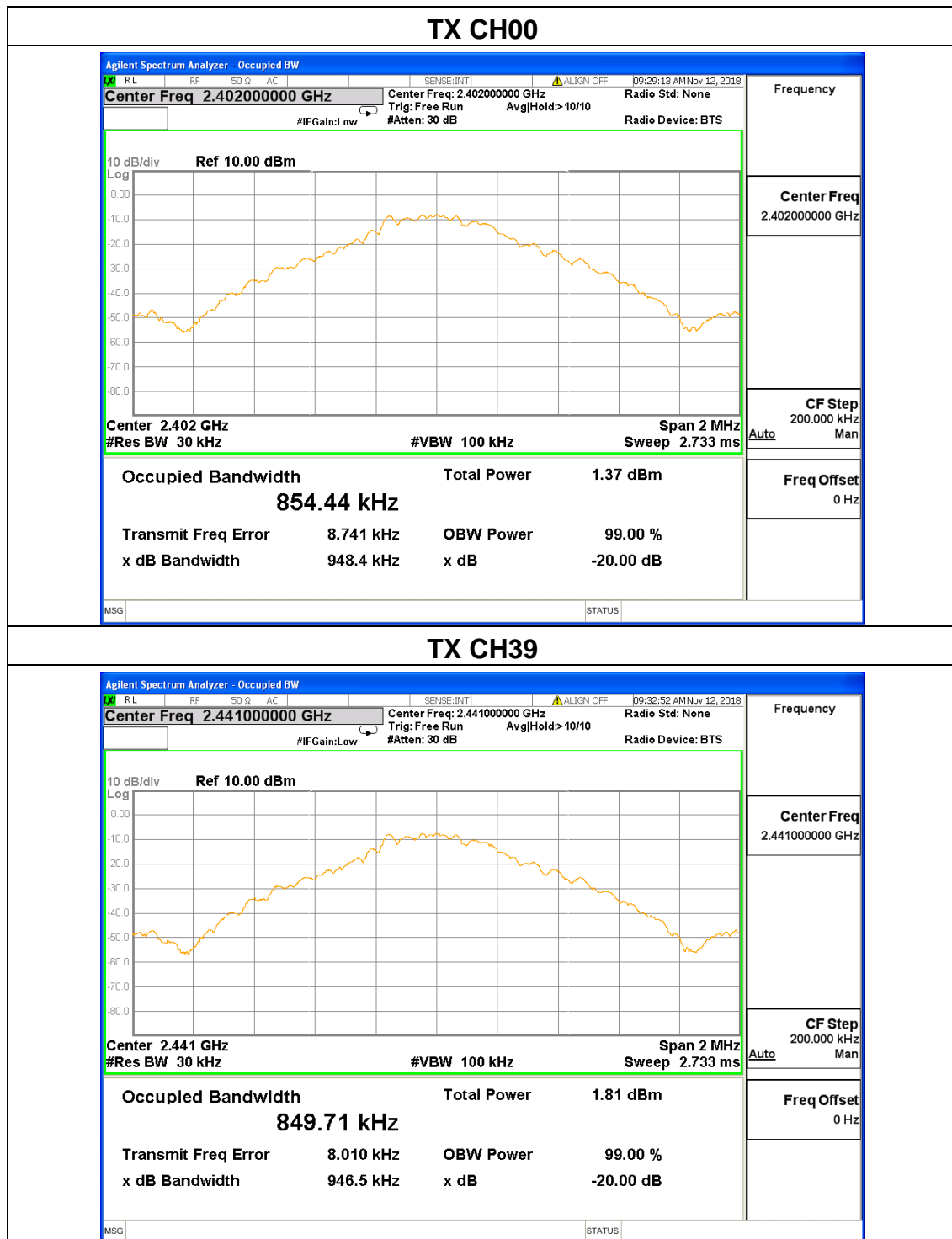

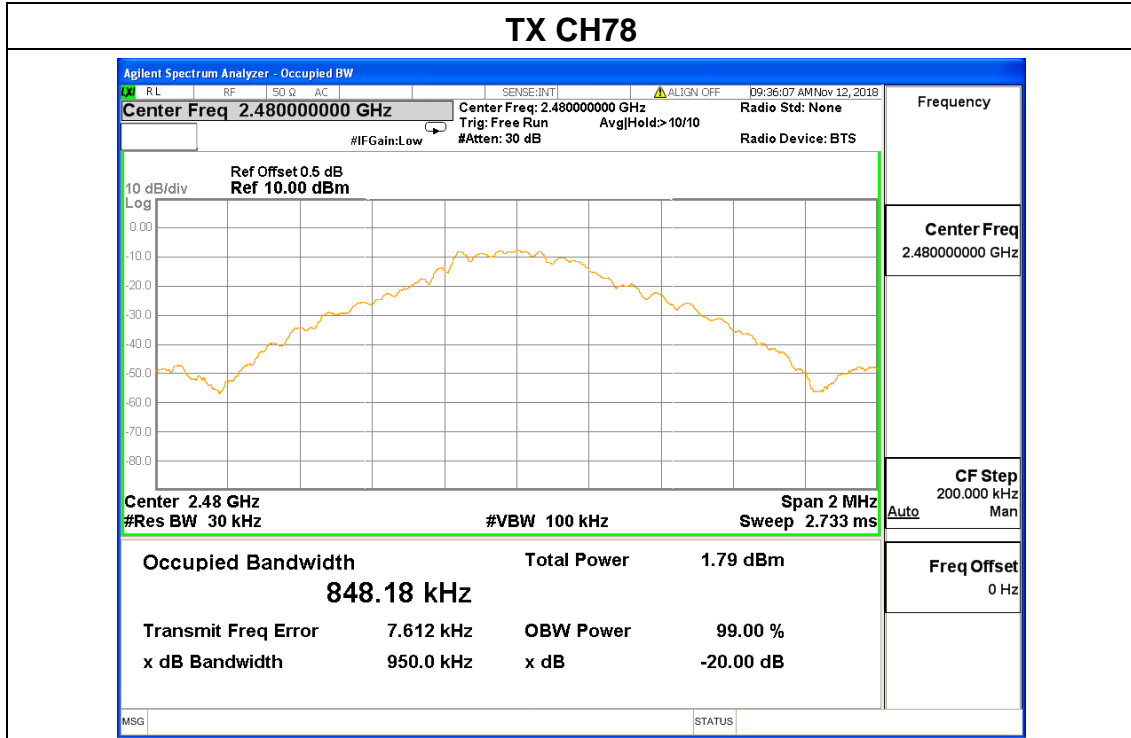

**$\pi/4$ -DQPSK**

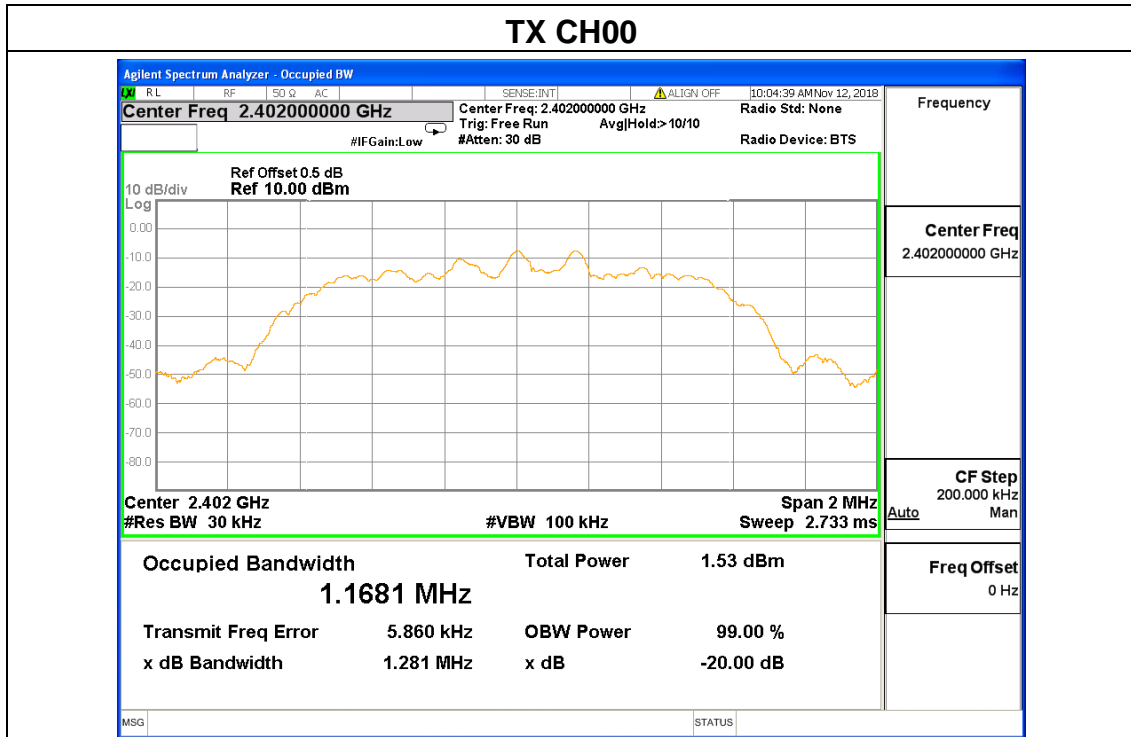

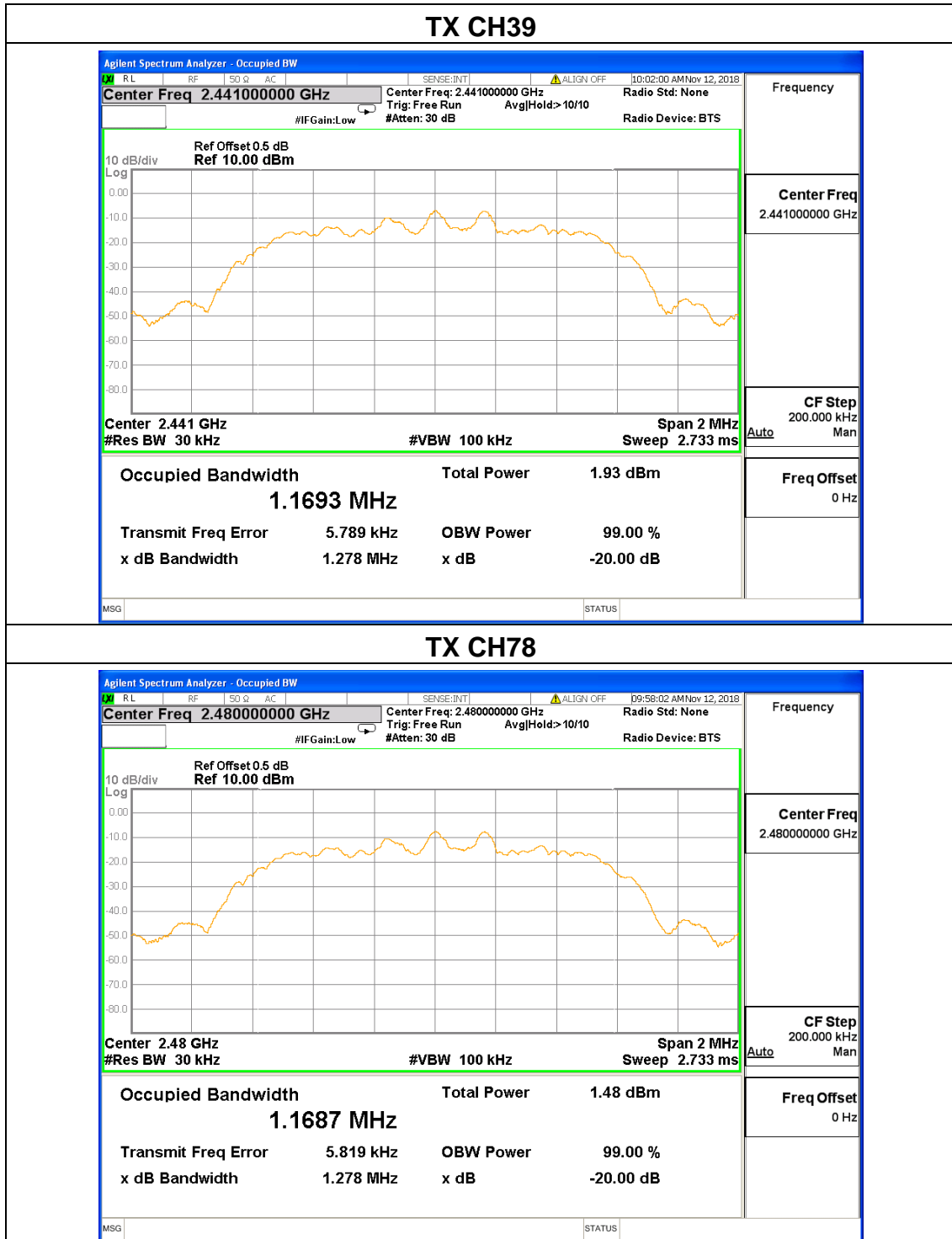

## 5.6 Carrier frequency separation

### 5.6.1 Limit

FCC Part15 (15.247) , Subpart C			
Section	Test Item	Limit	Frequency Range (MHz)
15.247(a)(1)	Channel Separation	>25KHz or >two-thirds of the 20 dB bandwidth (Which is greater)	2400-2483.5

### 5.6.2 Test setup

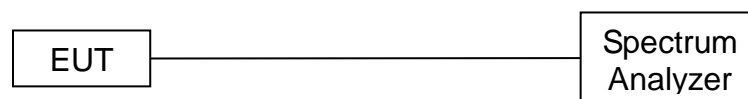

### 5.6.3 Test procedure

- (1) The EUT was directly connected to the spectrum analyzer and antenna output port as show in the block diagram above.
- (2) Spectrum Setting:  
RBW=30 kHz, VBW=100 kHz, detector= Peak, Sweep Time =auto.
- (3) The EUT was set to the Hopping Mode for Channel Separation Test and continuously transmitting for the Test.

### 5.6.4 Test results

Test data

EUT :	Bluetooth earphone	Model Name :	M7
Temperature :	25 °C	Relative Humidity :	60%
Pressure :	1012 hPa	Test Voltage :	DC 3.7V by battery
Test Mode :	GFSK, $\pi/4$ -DQPSK /CH00, CH39, CH78		

Mode	Channel	Frequency (MHz)	Test Result (KHz)	Limit (kHz)		Result
GFSK	Low	2402	1000	632.267	2/3 of 20dB BW	Pass
	Middle	2441	1000	631.000	2/3 of 20dB BW	Pass
	High	2480	1005	633.333	2/3 of 20dB BW	Pass
$\pi/4$ -DQPSK	Low	2402	1000	854.000	2/3 of 20dB BW	Pass
	Middle	2441	1005	852.000	2/3 of 20dB BW	Pass
	High	2480	1000	852.000	2/3 of 20dB BW	Pass

Test plots

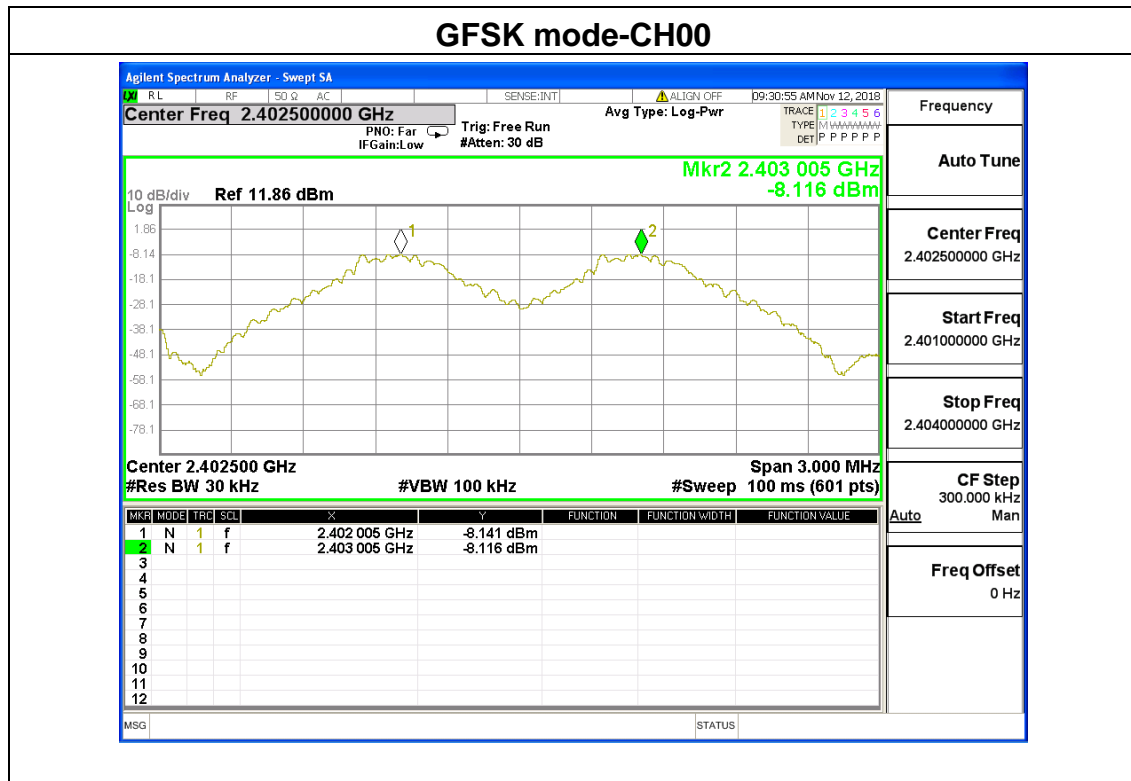

### GFSK mode-CH39

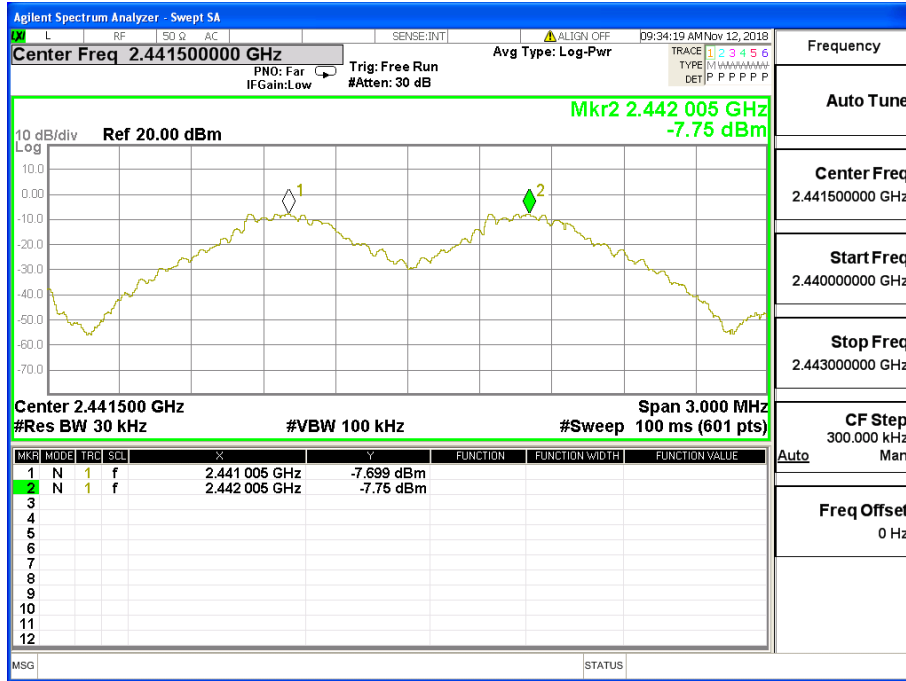

### GFSK mode-CH78

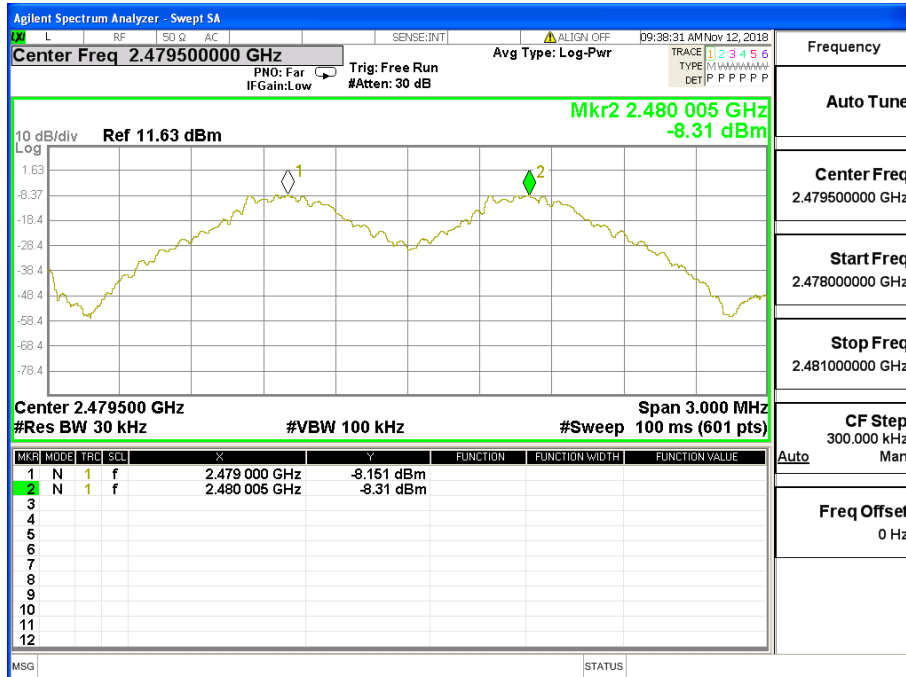

**$\pi/4$ -DQPSK mode-CH00**

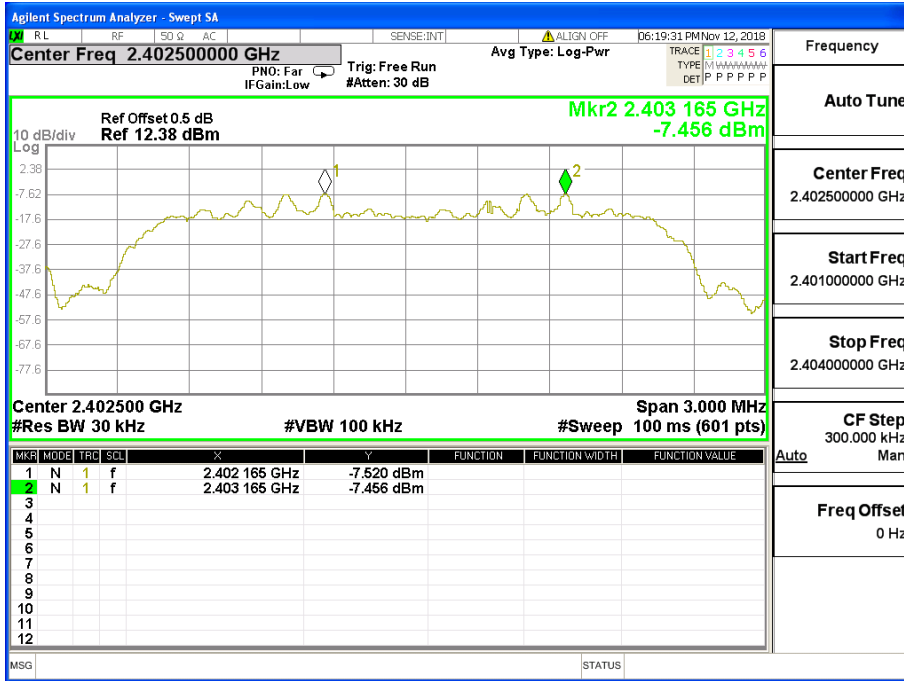

**$\pi/4$ -DQPSK mode-CH39**

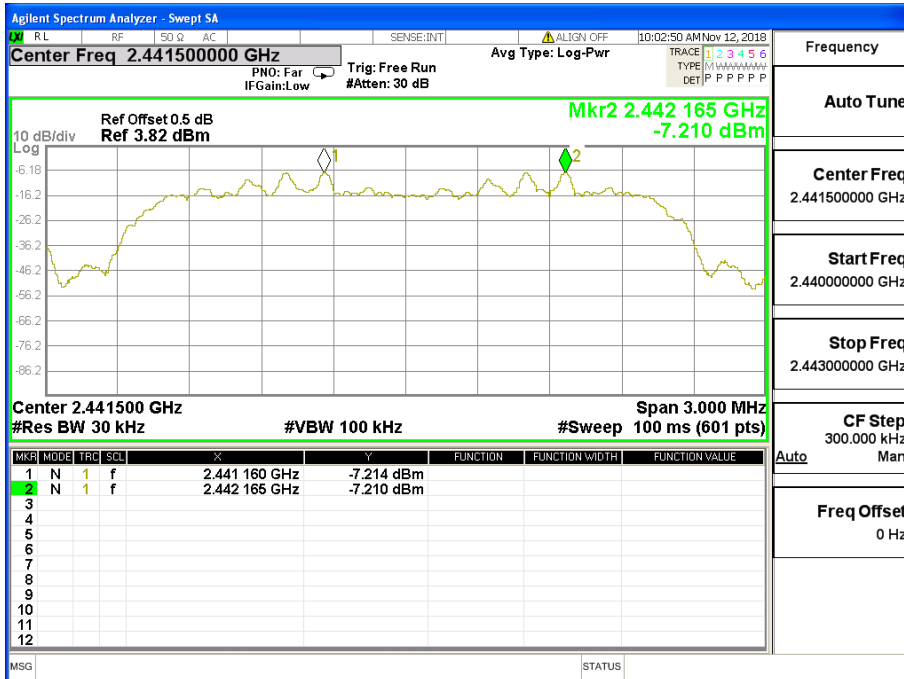

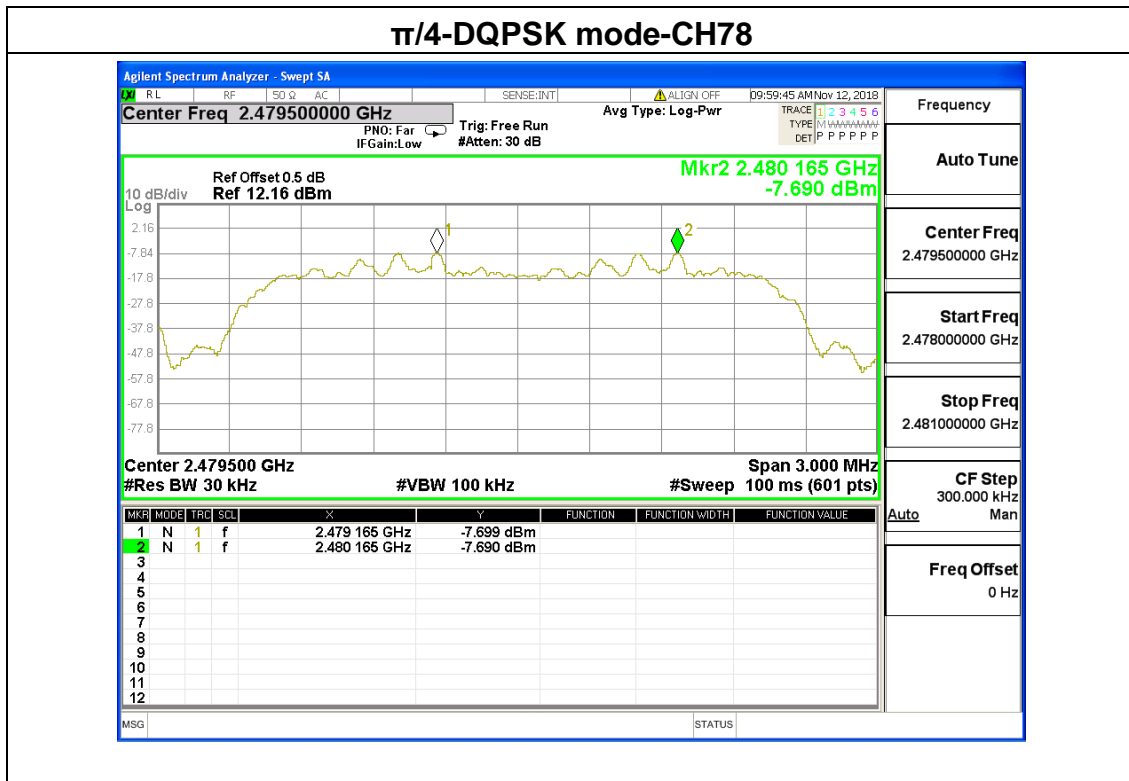



## 5.7 Hopping Channel

### 5.7.1 Limit

Frequency hopping systems in the 2400-2483.5MHz band shall use at least 15 channels.

### 5.7.2 Test setup

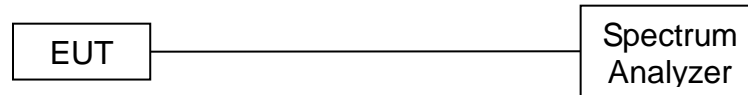

### 5.7.3 Test procedure

The testing follows ANSI C63.10-2013 clause 7.8.3

The RF output of EUT was connected to the spectrum analyzer by RF cable and attenuator.

The path loss was compensated to the results for each measurement.

Set to the maximum power setting and enable the EUT transmit continuously.

The EUT must have its hopping function enabled.

Use the following spectrum analyzer settings:

Span = the frequency band of operation

RBW : To identify clearly the individual channels, set the RBW to less than 30% of the channel spacing or the 20 dB bandwidth, whichever is smaller.

VBW  $\geq$  RBW

Sweep = auto

Detector function = peak

Trace = max hold

### 5.7.4 Test results

Mode	Quantity of Hopping Channel	Limit	Results
GFSK, $\pi/4$ -DQPSK	79	>15	Pass

Test plots

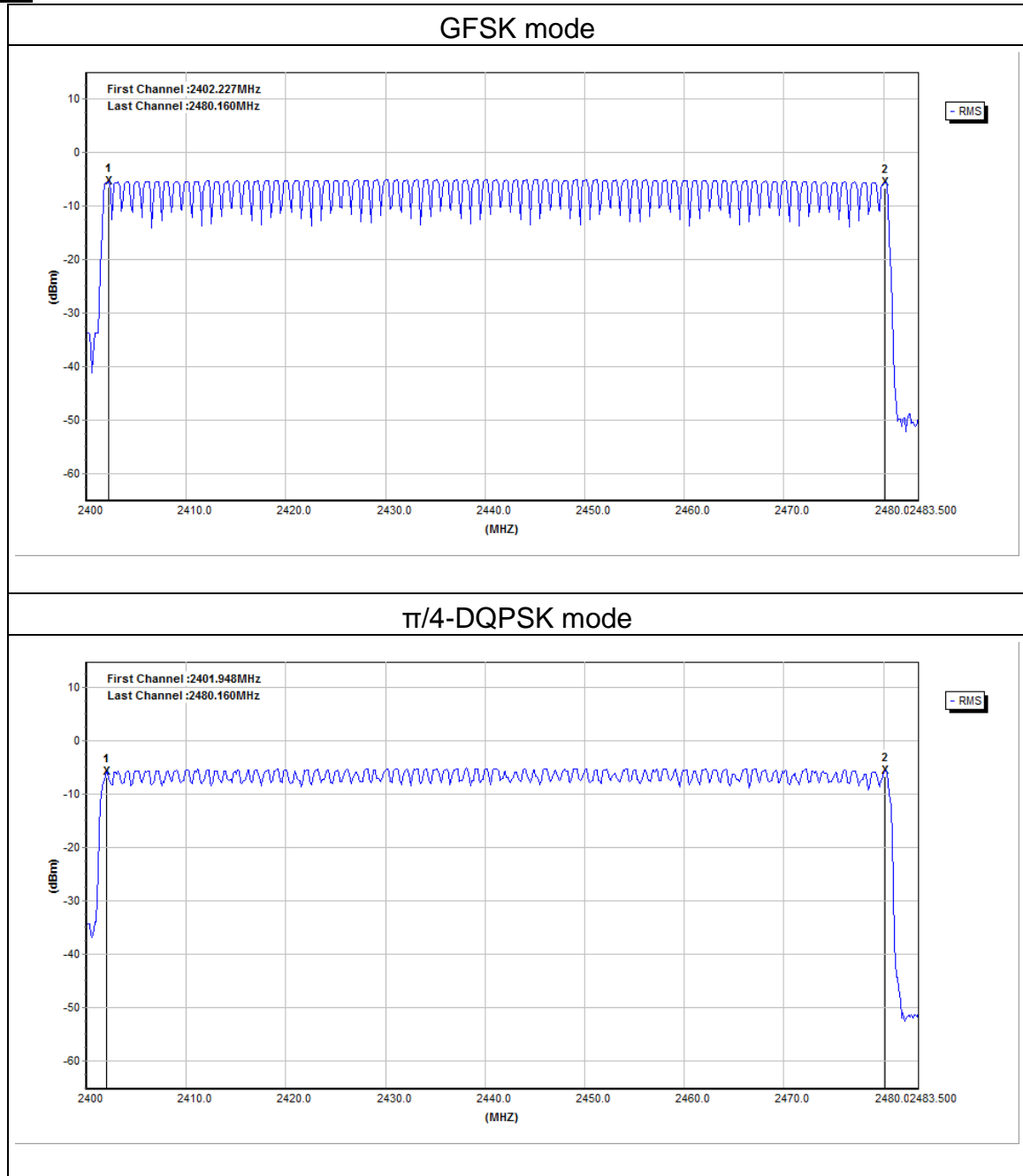

## 5.8 Dwell time

### 5.8.1 Limit

FCC Part15 (15.247) , Subpart C			
Section	Test Item	Limit	Frequency Range (MHz)
15.247(a)(a)	Dwell time	0.4 sec	2400-2483.5

### 5.8.2 Test setup

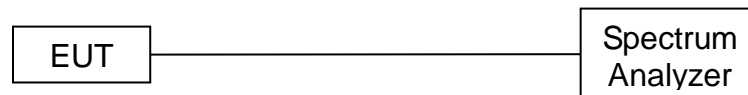

### 5.8.3 Test procedure

- (1) The EUT was directly connected to the spectrum analyzer and antenna output port as show in the block diagram above.
- (2) Spectrum Setting: RBW=1MHz, VBW=1MHz, Span=0Hz, Detector=Peak
- (3) Use video trigger with the trigger level set to enable triggering only on full pulses.
- (4) Sweep Time is more than once pulse time.
- (5) Set the center frequency on any frequency would be measure and set the frequency span to zero span.
- (6) Measure the maximum time duration of one single pulse.
- (7) Set the EUT for packet transmitting.
- (8) Measure the maximum time duration of one single pulse.
- (9) The EUT was set to the Hopping Mode for Dwell Time Test

### 5.8.4 Test results

Test data

EUT :	Bluetooth earphone	Model Name :	M7
Temperature :	25 °C	Relative Humidity :	60%
Pressure :	1012 hPa	Test Voltage :	DC 3.7V by battery
Test Mode :	GFSK, $\pi/4$ -DQPSK /CH39		

Mode	Data Packet	Frequency (MHz)	Pulse Duration (ms)	Dwell Time (ms)	Limit(s)	Conclusion
GFSK	DH1	2441	0.38	121.60	<0.4	Pass
	DH3	2441	1.64	262.40	<0.4	Pass
	DH5	2441	2.90	309.33	<0.4	Pass
$\pi/4$ DQPSK	2DH1	2441	0.39	124.80	<0.4	Pass
	2DH3	2441	1.64	262.40	<0.4	Pass
	2DH5	2441	2.90	309.33	<0.4	Pass

Note1: A period time = 0.4 (s) \* 79 = 31.6(s)

Note2:

*DH1 time slot = Pulse Duration \* (1600/(2\*79)) \* A period time*

*DH3 time slot = Pulse Duration \* (1600/(4\*79)) \* A period time*

*DH5 time slot = Pulse Duration \* (1600/(6\*79)) \* A period time*

Note3: For GFSK,  $\pi/4$ -DQPSK: The test period: T= 0.4 Second/Channel x 79 Channel = 31.6 s

Test plots

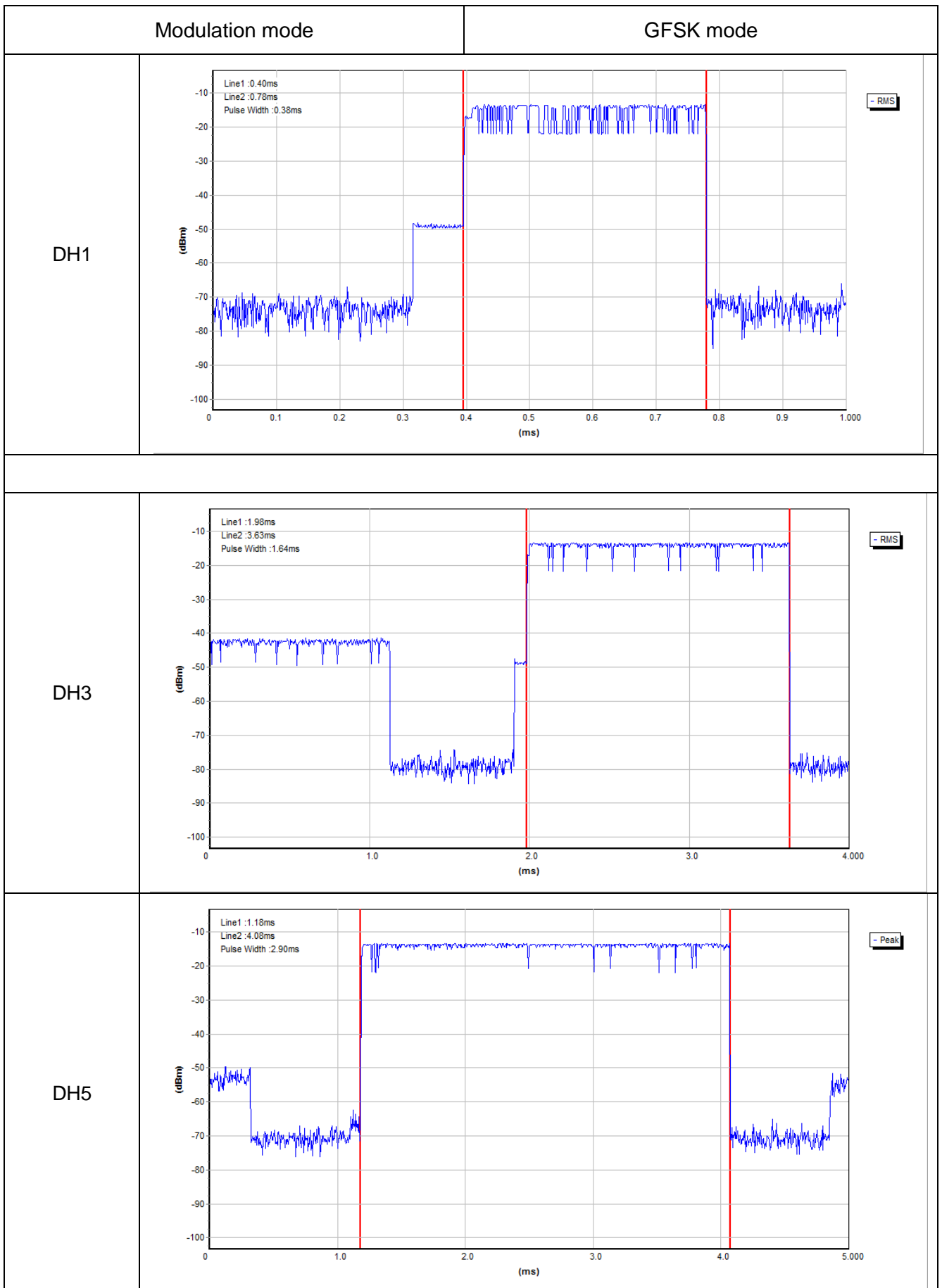

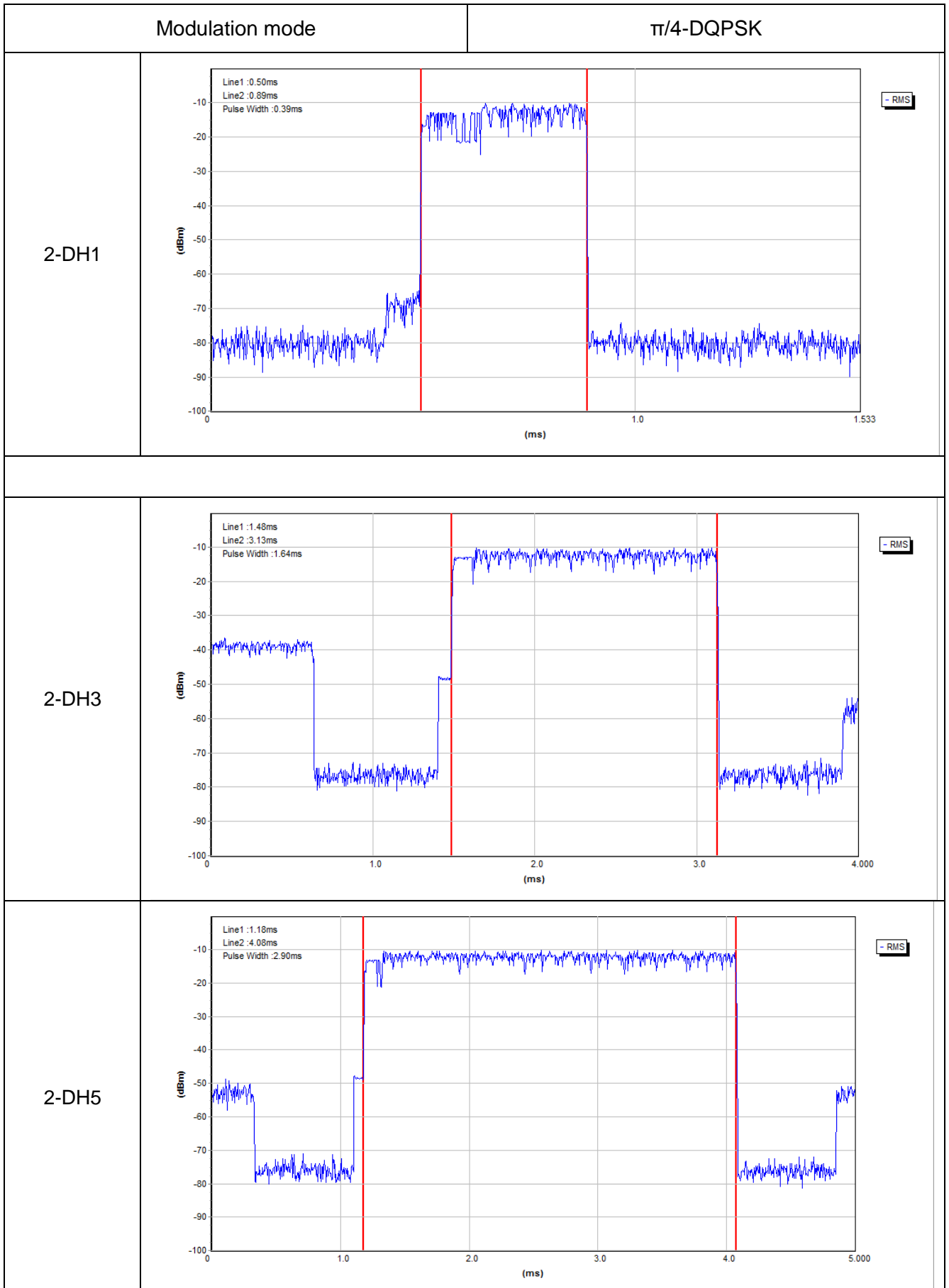

## 5.9 Conducted bandedge

### 5.9.1 Limit

In any 100 kHz bandwidth outside the frequency band in which the spread spectrum or digitally modulated intentional radiator is operating, the radio frequency power that is produced by the intentional radiator shall be at least 20 dB below that in the 100 kHz bandwidth within the band that contains the highest level of the desired power, based on either an RF conducted or a radiated measurement, provided the transmitter demonstrates compliance with the peak conducted power limits. If the transmitter complies with the conducted power limits based on the use of RMS averaging over a time interval, as permitted under paragraph (b)(3) of this section, the attenuation required under this paragraph shall be 30 dB instead of 20 dB. Attenuation below the general limits specified in §15.209(a) is not required. In addition, radiated emissions which fall in the restricted bands, as defined in §15.205(a), must also comply with the radiated emission limits specified in §15.209(a) (see §15.205(c)).

### 5.9.2 Test setup

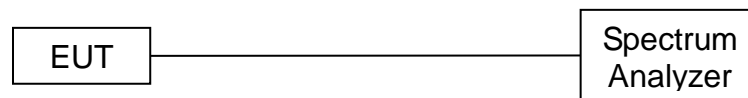

### 5.9.3 Test procedure

- a) Check the calibration of the measuring instrument using either an internal calibrator or a known signal from an external generator.
- b) Position the EUT without connection to measurement instrument. Turn on the EUT and connect its antenna terminal to measurement instrument via a low loss cable. Then set it to any one measured frequency within its operating range, and make sure the instrument is operated in its linear range.
- c) Set RBW to 100 kHz and VBW of spectrum analyzer to 300 kHz with a convenient frequency span including 100 kHz bandwidth from band edge.
- d) Measure the highest amplitude appearing on spectral display and set it as a reference level. Plot the graph with marking the highest point and edge frequency.
- e) Repeat above procedures until all measured frequencies were complete.

### 5.9.4 Test results

Test data

EUT :	Bluetooth earphone	Model Name :	M7
Temperature :	25 °C	Relative Humidity :	60%
Pressure :	1012 hPa	Test Voltage :	DC 3.7V by battery

Test plots

GFSK: Band Edge, Left Side

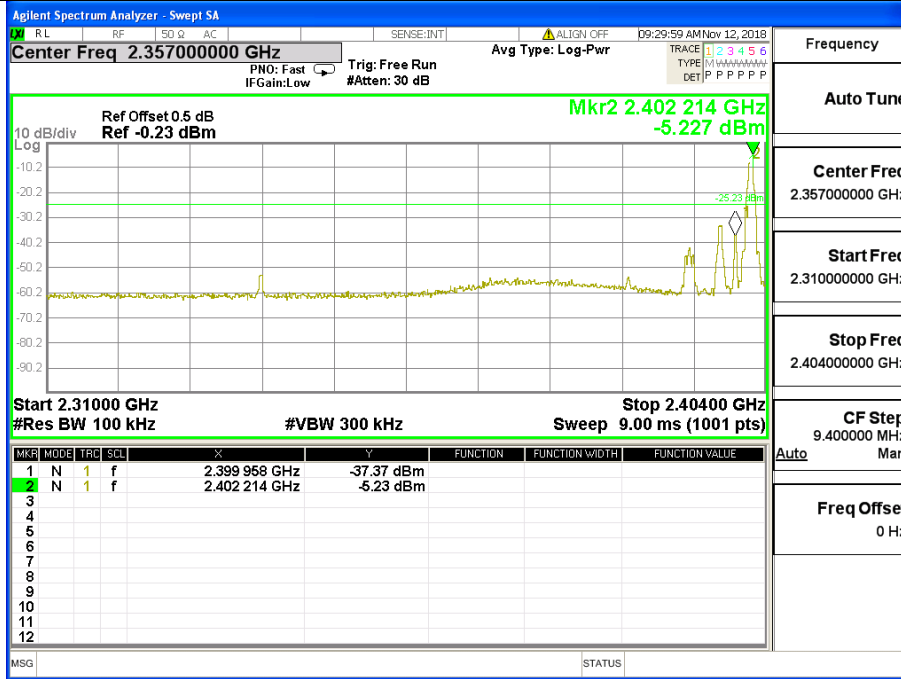

GFSK: Band Edge, Right Side

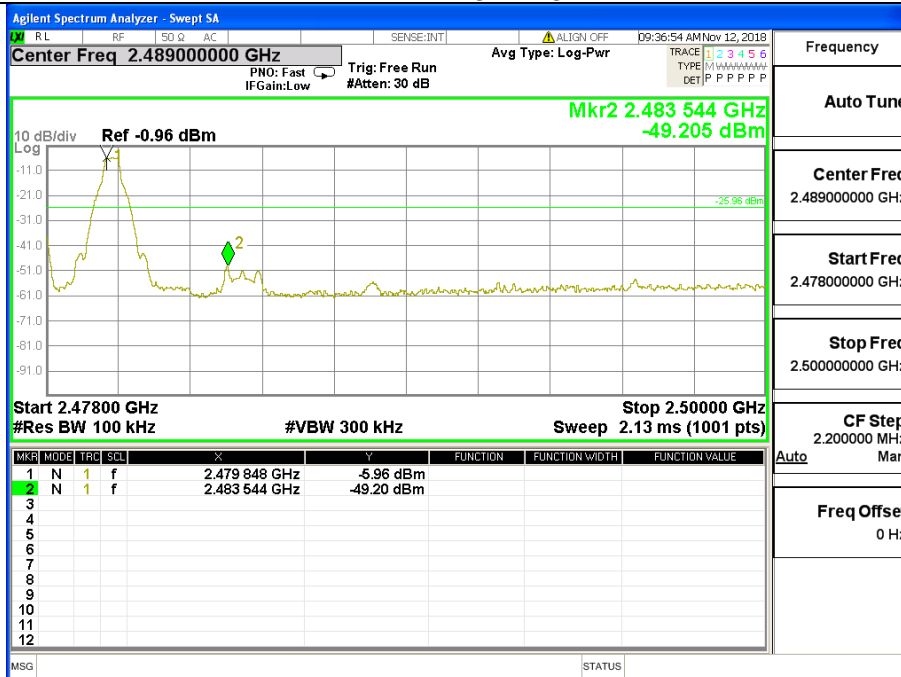



$\pi/4$ -DQPSK: Band Edge, Left Side

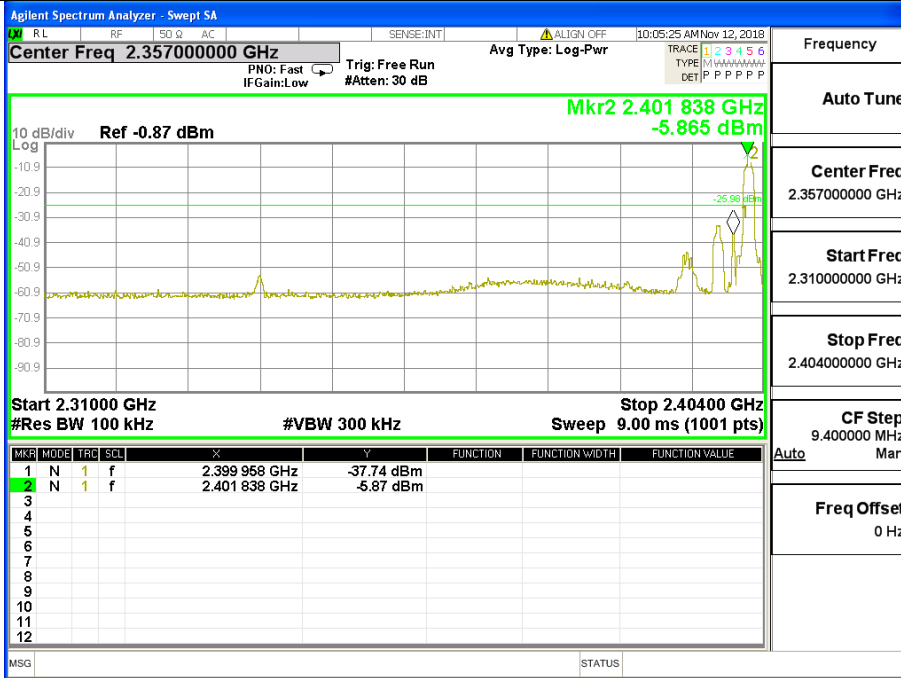

$\pi/4$ -DQPSK: Band Edge, Right Side

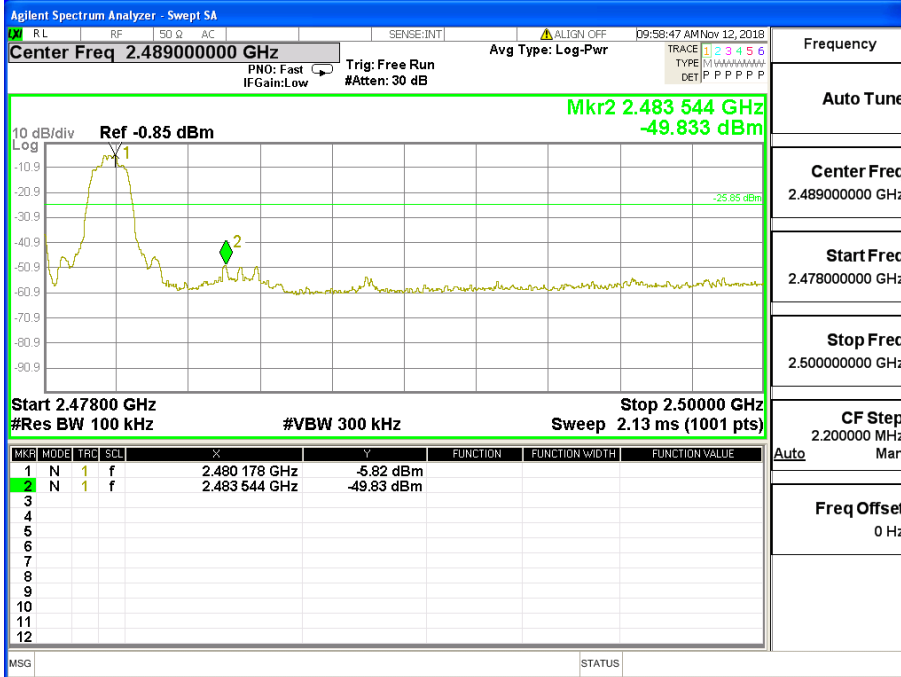

Hopping Mode  
Test plots

**GFSK: Band Edge, Left Side**

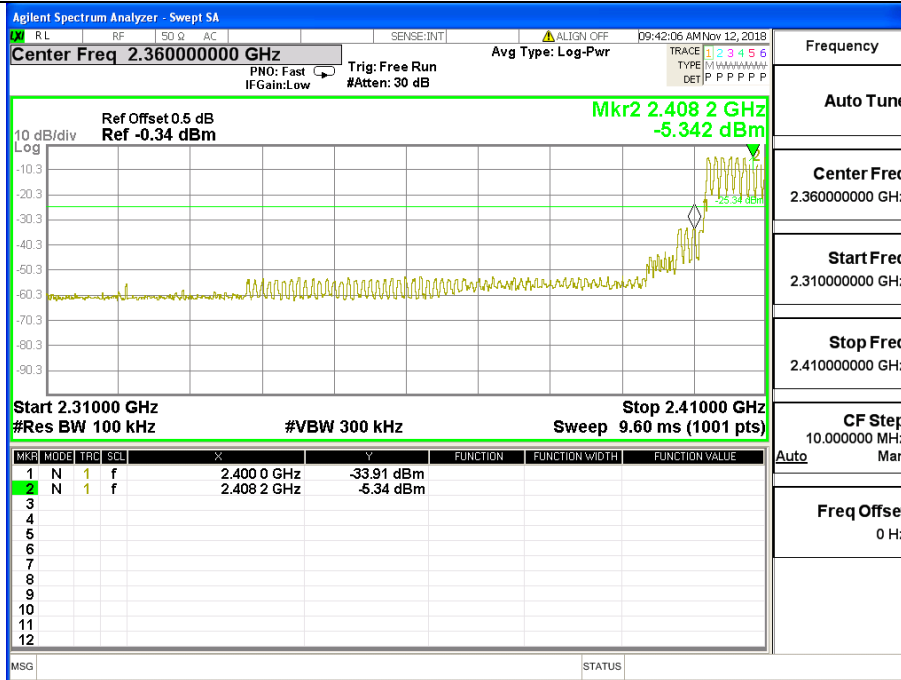

**GFSK: Band Edge, Right Side**

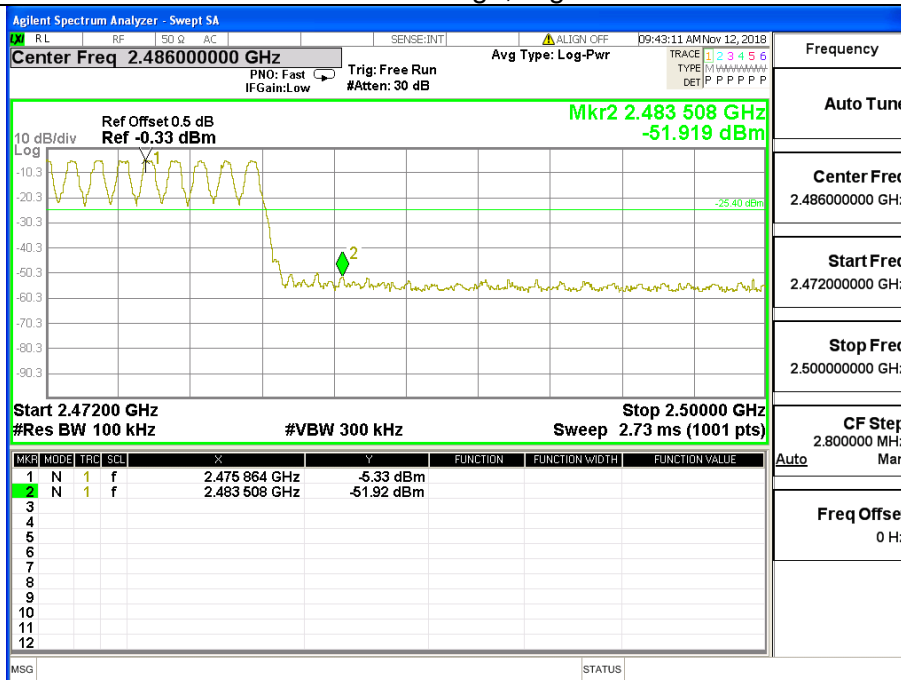

$\pi/4$ -DQPSK: Band Edge, Left Side

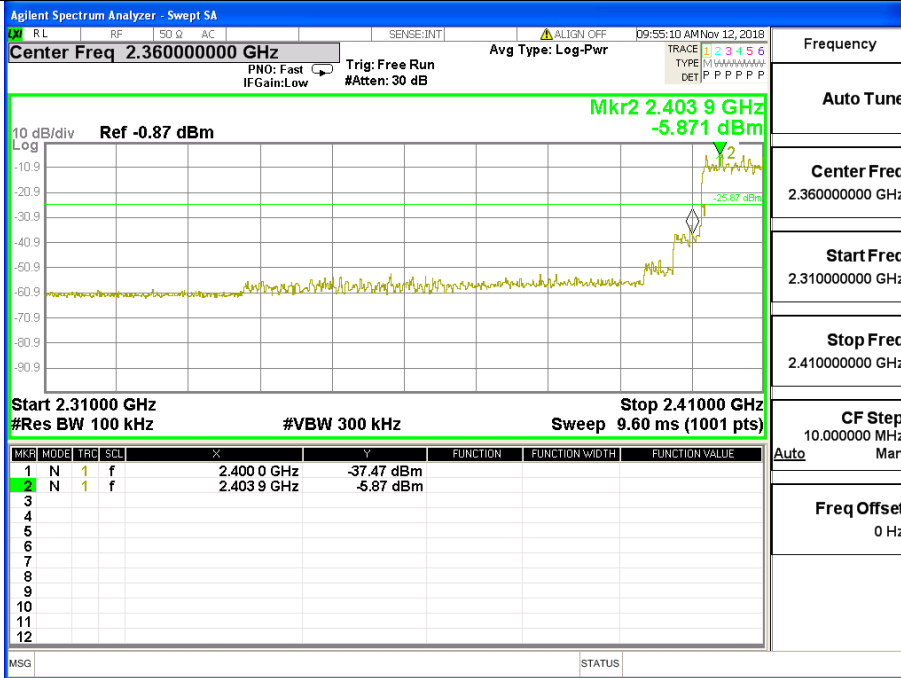

$\pi/4$ -DQPSK Band Edge, Right Side

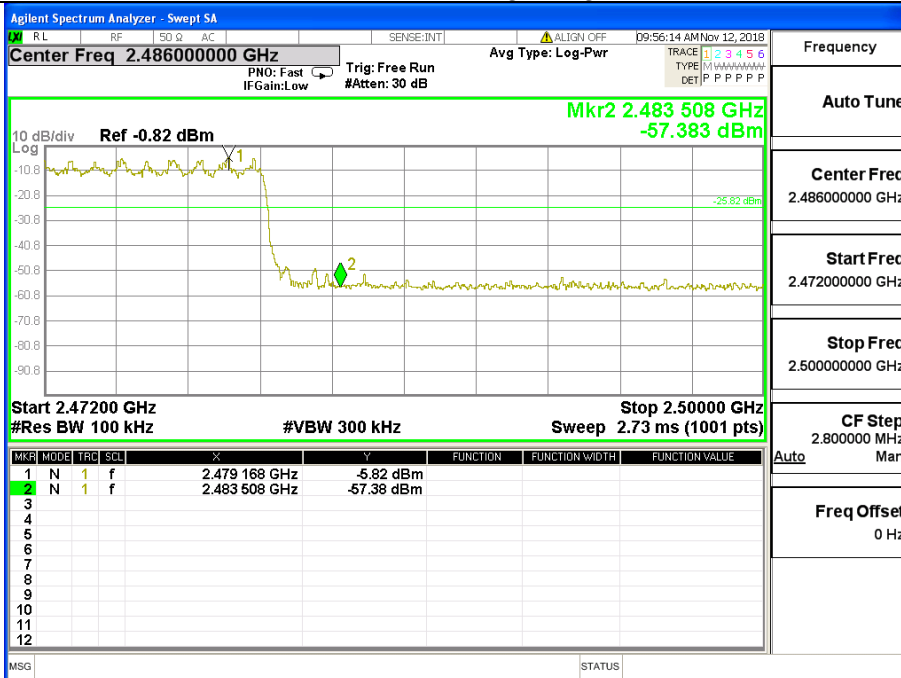

## 5.10 Spurious RF Conducted Emissions

### 5.10.1 Conformance Limit

Below -20dB of the highest emission level in operating band.

### 5.10.2 Measuring Instruments

The Measuring equipment is listed in the section 6.3 of this test report.

### 5.10.3 Test Setup

Please refer to Section 6.1 of this test report.

### 5.10.4 Test Procedure

The Spurious RF conducted emissions compliance of RF radiated emission should be measured by following the guidance in ANSI C63.10-2013 with respect to maximizing the emission by rotating the EUT, measuring the emission while the EUT is situated in three orthogonal planes (if appropriate), adjusting the measurement antenna height and polarization etc. Set RBW=100kHz and VBW=300kHz to measure the peak field strength, and measure frequency range from 9kHz to 26.5GHz.

### 5.10.5 Test Results

Remark: The measurement frequency range is from 9kHz to the 10th harmonic of the fundamental frequency. The lowest, middle and highest channels are tested to verify the spurious emissions and band-edge measurement data.

The worst mode is  $\pi/4$ -DQPSK mode, and the report only show the worst mode data.

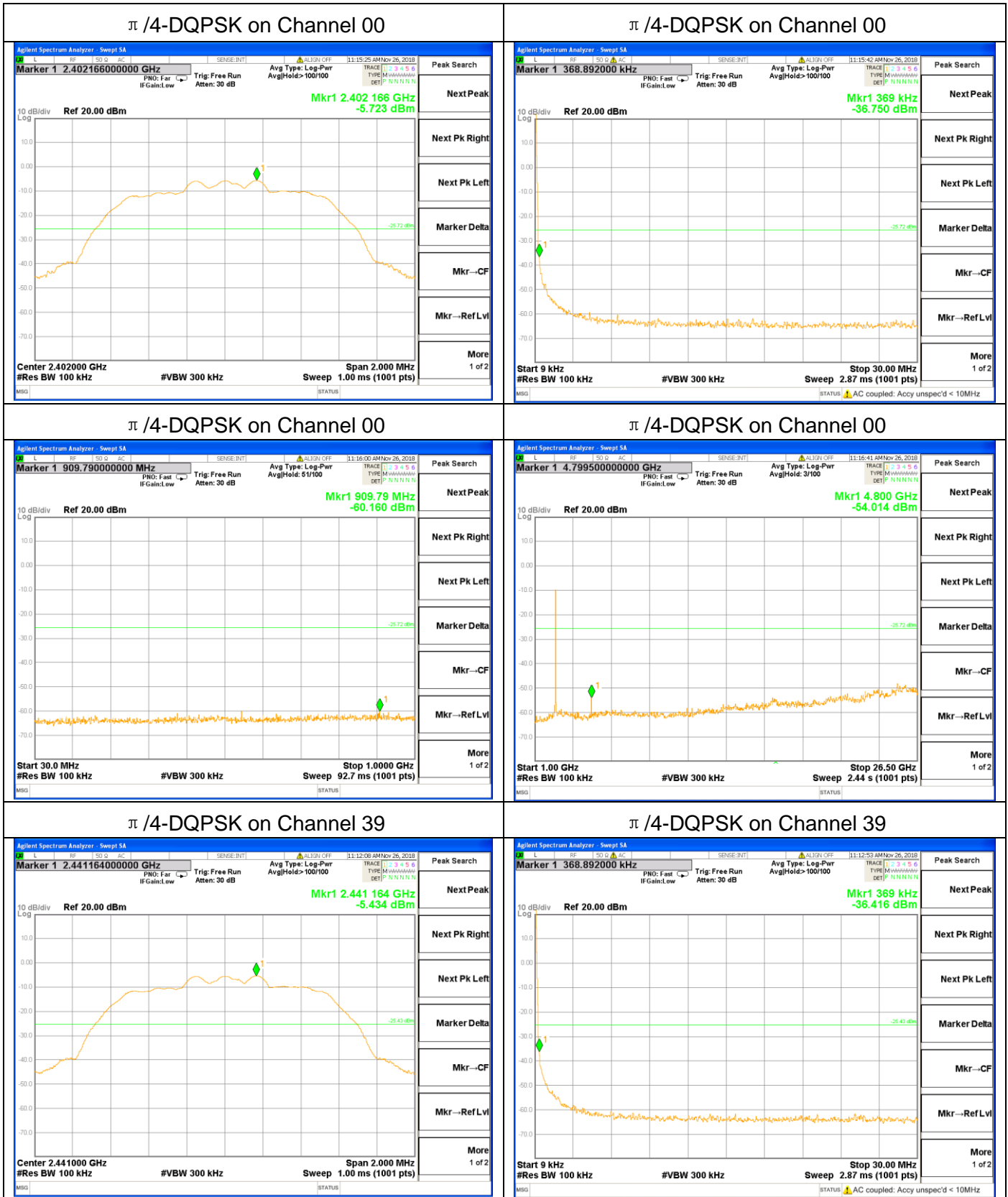

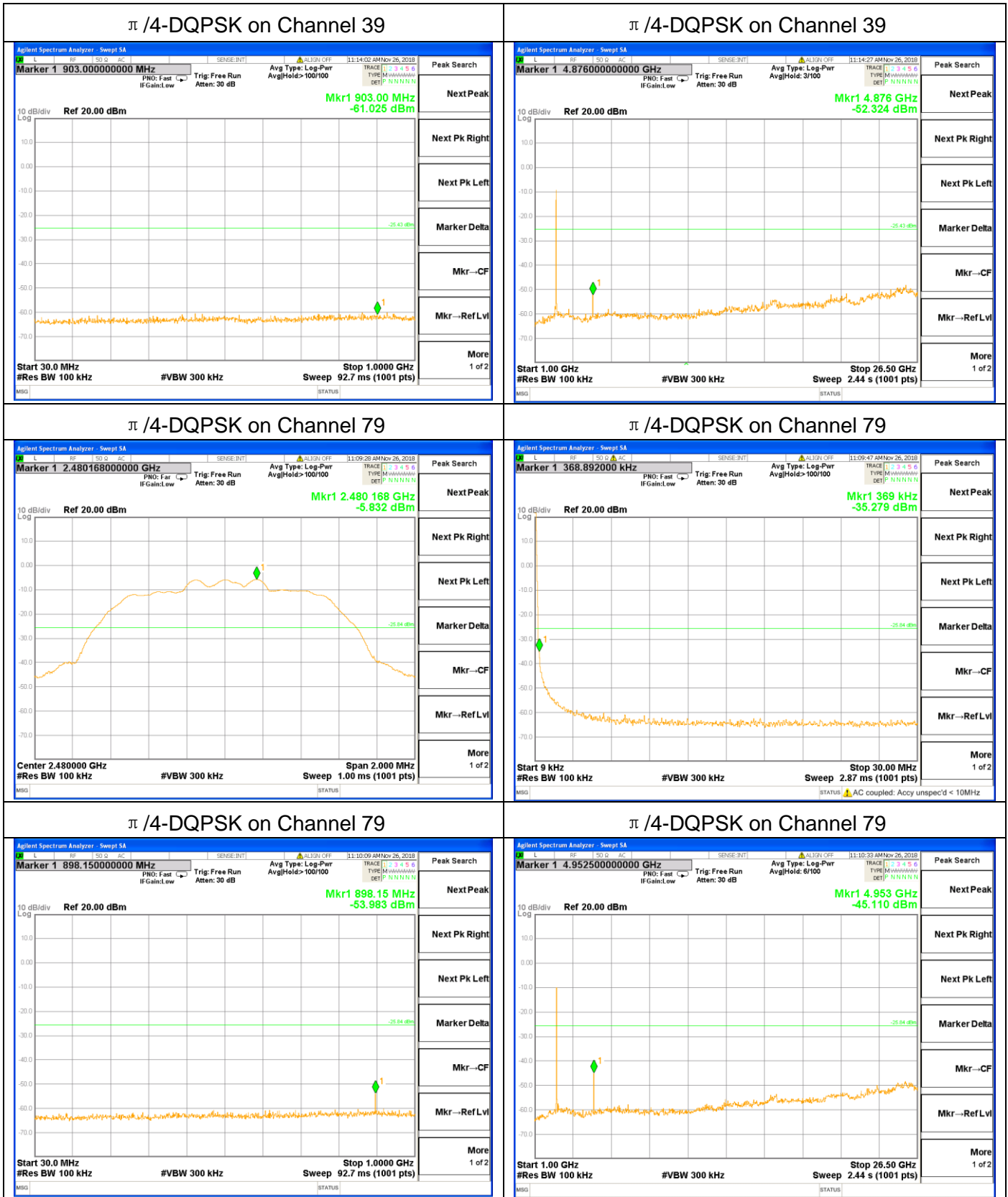

**Photographs of the Test Setup**

Radiated emission

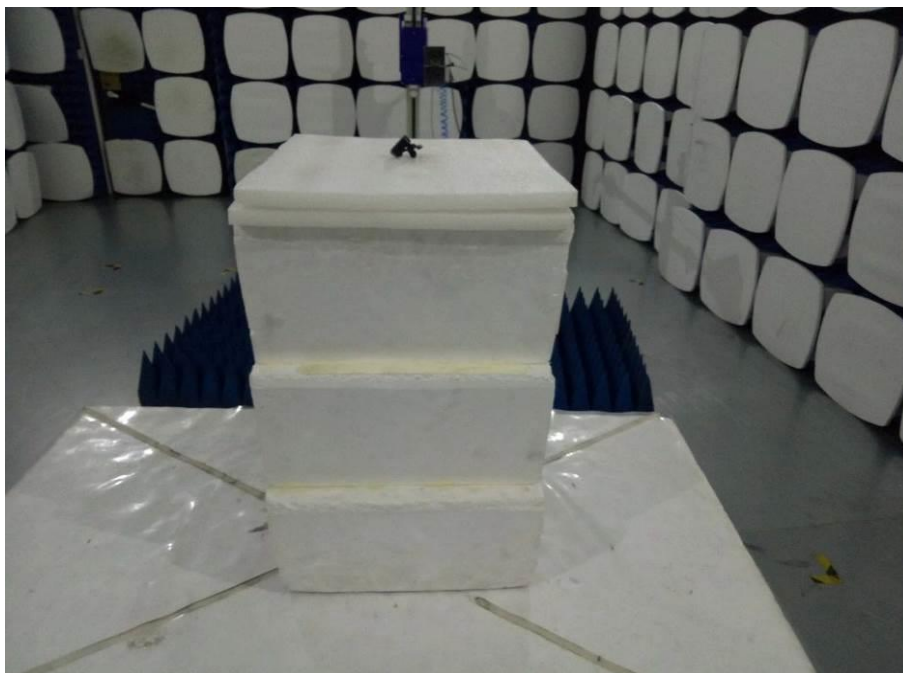
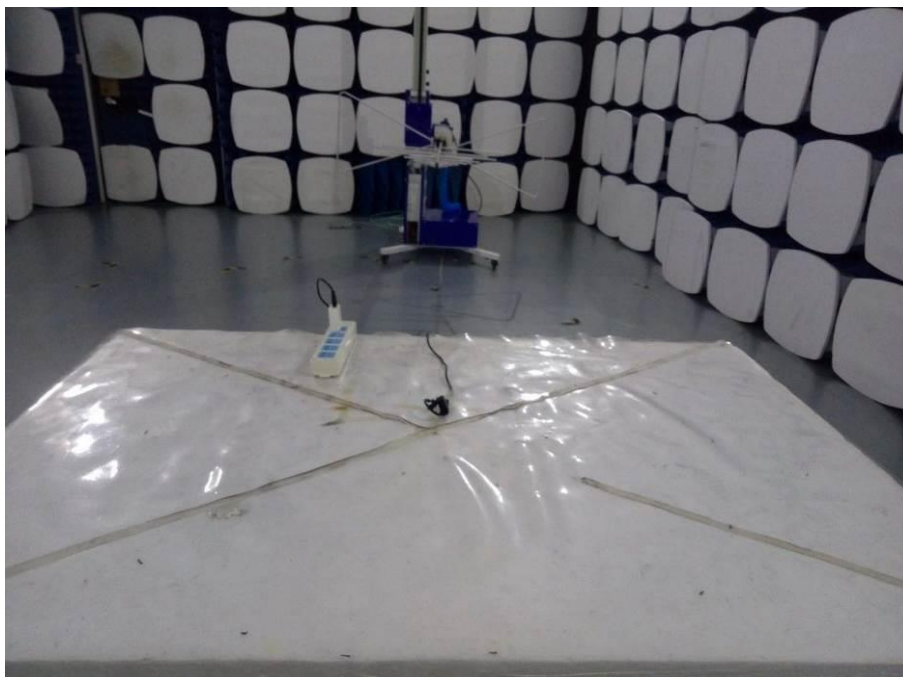



Conducted emission





## **Photographs of the EUT**

See the APPENDIX 1: EUT PHOTO in the report No.: MTi181112E045-1.

**---END OF REPORT---**