



FCC RADIO TEST REPORT

Applicant : Newline Interactive Inc.
Address : 101 East Park Blvd. Suite 807 Plano, TX 75074, USA
Equipment : Newline Chromebox A10
Model No. : TCB-AC2
Trade Name : **newline**
FCC ID. : 2APNX00TCBAC2

I HEREBY CERTIFY THAT :

The sample was received on Apr. 15, 2019 and the testing was carried out on Jun. 08, 2019 at CerpPASS Technology Corp. The test result refers exclusively to the test presented test model / sample. Without written approval of CerpPASS Technology Corp., the test report shall not be reproduced except in full.

Approved by:

Mark Liao / Supervisor

Laboratory Accreditation:

CerpPASS Technology Corporation Test Laboratory





Contents

1. Summary of Test Procedure and Test Results	5
1.1 Applicable Standards	5
2. Test Configuration of Equipment under Test	6
2.1 Feature of Equipment under Test	6
2.2 Carrier Frequency of Channes	7
2.3 Test Mode & Test Software	8
2.4 Description of Test System	8
2.5 General Information of Test	9
2.6 Measurement Uncertainty	10
3. Test Equipment and Ancillaries Used for Tests	11
4. Antenna Requirements	12
4.1 Standard Applicable	12
4.2 Antenna Construction and Directional Gain	12
5. Test of AC Power Line Conducted Emission	13
5.1 Test Limit	13
5.2 Test Procedures	13
5.3 Typical Test Setup	14
5.4 Test Result and Data	15
5.5 Test Photographs	17
6. Test of Radiated Spurious Emission	18
6.1 Test Limit	18
6.2 Test Procedures	18
6.3 Typical Test Setup	19
6.4 Test Result and Data (9kHz ~ 30MHz)	20
6.5 Test Result and Data (30MHz ~ 1GHz)	20
6.6 Test Result and Data (1GHz ~ 25GHz)	22
6.7 Restricted Bands of Operation	34
6.8 Test Photographs (30MHz ~ 1GHz)	35
6.9 Test Photographs (1GHz ~ 25GHz)	36
7. Test of Conducted Spurious Emission	37
7.1 Test Limit	37
7.2 Test Procedure	37
7.3 Test Setup Layout	37
7.4 Test Result and Data	37
8. 20dB Bandwidth Measurement Data	45
8.1 Test Limit	45
8.2 Test Procedures	45
8.3 Test Setup Layout	45
8.4 Test Result and Data	45
9. Frequencies Separation	49
9.1 Test Limit	49
9.2 Test Procedures	49



- 9.3 Test Setup Layout 49
- 9.4 Test Result and Data 49
- 10. Dwell Time on each channel 53**
 - 10.1 Test Limit 53
 - 10.2 Test Procedures 53
 - 10.3 Test Setup Layout 53
 - 10.4 Test Result and Data 53
- 11. Number of Hopping Channels 57**
 - 11.1 Test Limit 57
 - 11.2 Test Procedures 57
 - 11.3 Test Setup Layout 57
 - 11.4 Test Result and Data 57
- 12. Maximum Peak Output Power 59**
 - 12.1 Test Limit 59
 - 12.2 Test Procedures 59
 - 12.3 Test Setup Layout 59
 - 12.4 Test Result and Data 60
- 13. Radio Frequency Exposure 61**
 - 13.1 EUT Specification 61
 - 13.2 Test Results 62
 - 13.3 Calculation 62
 - 13.4 Maximum Permissible Exposure 63



History of this test report

Report No.	Issue Date	Description
TEFB2002144	Mar. 20, 2020	Original

Report Type		Description
<input type="checkbox"/>	Original report	NA
<input checked="" type="checkbox"/>	Derivative Report	<p>This sample provided has been confirmed to be identical to the original report sample. The only difference are as listed below. As it doesn't affect the test result, the original report number: TEFB1903256 and content will be used.</p> <p>1.Applicant information change. 2.Model No. change. 3.Trade Name change.</p>



1. Summary of Test Procedure and Test Results

1.1 Applicable Standards

ANSI C63.4:2014

ANSI C63.10:2013

FCC Rules and Regulations Part 15 Subpart C §15.247

FCC Rule	Description of Test	Result
15.203	. Antenna Requirement	PASS
15.207	. AC Power Line Conducted Emission	PASS
15.209 15.205	. Radiated Spurious Emission	PASS
15.247(d)	. Conducted Spurious Emission	PASS
15.247(a)(1)	. Channel Carrier Frequencies Separation	PASS
15.247(a)(1)	. 20dB Bandwidth	PASS
15.247(a)(1)	. Dwell Time	PASS
15.247(b)	. Number of Hopping Channels	PASS
15.247(b)	. Peak Output Power Measurement Data	PASS

*The principle of judgment is made according to the laboratory's reporting control and measurement uncertainty standard procedures.

*This EUT has been also tested and compiled with the requirement of FCC Part 15, Subpart B, recorded in a separate test report(TEFD1901352).



2. Test Configuration of Equipment under Test

2.1 Feature of Equipment under Test

WLAN Module	Intel / Dual Band Wireless-AC 7265(Stone Peak)
Frequency Range	BT / BLE: 2400-2483.5MHz 802.11b/g/n: 2400-2483.5MHz 802.11a/n/ac: 5150-5250MHz, 5250-5350MHz, 5470-5725MHz, 5725-5850MHz
Modulation Type	BT: GFSK, $\pi/4$ -DQPSK, 8DPSK BLE: GFSK 802.11b: CCK, DQPSK, DBPSK 802.11g/n/a: BPSK, QPSK, 16QAM, 64QAM 802.11ac: BPSK, QPSK, 16QAM, 64QAM, 256QAM
Data Rate	BT: GFSK: 1Mbps, $\pi/4$ -DQPSK: 2Mbps, 8DPSK: 3Mbps BLE: GFSK: 1Mbps WLAN: 802.11b: 1, 2, 5.5, 11Mbps 802.11g: 6, 9, 12, 18, 24, 36, 48, 54Mbps 802.11n: MCS0 – MCS15, HT20/40 802.11a: 6, 9, 12, 18, 24, 36, 48, 54Mbps 802.11ac: MCS0 – MCS9, VHT20/40/80
Antenna Type	Dipole Antenna
Antenna Gain	2400-2483.5MHz: 3.53dBi 5150-5250MHz: 2.52dBi 5250-5350MHz: 2.52dBi 5470-5725MHz: 2.02dBi 5725-5850MHz: 1.59dBi
Data Rate	BT: GFSK: 1Mbps, $\pi/4$ -DQPSK: 2Mbps, 8DPSK: 3Mbps BLE: GFSK: 1Mbps WLAN: 802.11b: 1, 2, 5.5, 11Mbps 802.11g: 6, 9, 12, 18, 24, 36, 48, 54Mbps 802.11n: MCS0 – MCS15, HT20/40 802.11a: 6, 9, 12, 18, 24, 36, 48, 54Mbps 802.11ac: MCS0 – MCS9, VHT20/40/80
Adapter	Chicony \ A11-065N1A INPUT: 100-240V~1.7A 50-60Hz OUTPUT: 19V / 3.42A 65W Chicony \ A16-090P1A INPUT: 100-240V~1.5A 50-60Hz OUTPUT: 19V / 4.74A 90W

Note:

1. For a more detailed features description, please refer to the manufacturer's specifications or the User's Manual.
2. EUT support TPC function.



2.2 Carrier Frequency of Channes

Channel	Frequency (MHz)	Channel	Frequency (MHz)	Channel	Frequency (MHz)	Channel	Frequency (MHz)
*00	2402	20	2422	40	2442	60	2462
01	2403	21	2423	41	2443	61	2463
02	2404	22	2424	42	2444	62	2464
03	2405	23	2425	43	2445	63	2465
04	2406	24	2426	44	2446	64	2466
05	2407	25	2427	45	2447	65	2467
06	2408	26	2428	46	2448	66	2468
07	2409	27	2429	47	2449	67	2469
08	2410	28	2430	48	2450	68	2470
09	2411	29	2431	49	2451	69	2471
10	2412	30	2432	50	2452	70	2472
11	2413	31	2433	51	2453	71	2473
12	2414	32	2434	52	2454	72	2474
13	2415	33	2435	53	2455	73	2475
14	2416	34	2436	54	2456	74	2476
15	2417	35	2437	55	2457	75	2477
16	2418	36	2438	56	2458	76	2478
17	2419	37	2439	57	2459	77	2479
18	2420	38	2440	58	2460	*78	2480
19	2421	*39	2441	59	2461	---	---

Note: Channels remarked * are selected to perform test.



2.3 Test Mode & Test Software

- During testing, the interface cables and equipment positions were varied according to ANSI C63.10
- The complete test system included Notebook and EUT for RF test.
- An executive program, "DRTU: Ver 11.1833.0-08103" under WIN 7 was executed to transmit and receive data via Bluetooth.
- The following test modes were performed for the test:

Test Mode	Operating Description
1	GFSK (1Mbps)
2	$\pi/4$ -DQPSK (2Mbps)
3	8DPSK (3Mbps)
<p>For radiation test (below 1GHz) & AC Power Line Conducted Emission, caused "Test Mode 1" generated the worst case, it was reported as the final data. For radiation test (above 1GHz), caused "Test Mode 1, 3" generated the worst case, they were reported as the final data. For Maximum Peak Output Power, caused "Test Mode 1, 2, 3" generated the worst case, they were reported as the final data.</p>	

2.4 Description of Test System

RF Conducted				
Equipment	Brand	Model	Length/Type	Power cord/Length/Type
Notebook	DELL	Latitude E5470	N/A	Adapter / 1.8m / NS
AP	D-link	DIR-868L	N/A	Adapter / 1.5m / NS
Network cable	N/A	N/A	1.2m / NS	N/A
Network cable	N/A	N/A	1.2m / NS	N/A
Radiated Emissions				
Equipment	Brand	Model	Length/Type	Power cord/Length/Type
Notebook	DELL	Latitude E5470	N/A	Adapter / 1.8m / NS
AP	D-link	DIR-868L	N/A	Adapter / 1.5m / NS
Network cable	N/A	N/A	15m / NS	N/A
Network cable	N/A	N/A	15m / NS	N/A
AC Power Line Conducted Emission				
Equipment	Brand	Model	Length/Type	Power cord/Length/Type
Notebook	DELL	Latitude E5470	N/A	Adapter / 1.8m / NS
AP	D-link	DIR-868L	N/A	Adapter / 1.5m / NS
Network cable	N/A	N/A	15m / NS	N/A
Network cable	N/A	N/A	15m / NS	N/A



2.5 General Information of Test

Test Site	Cerpass Technology Corporation Test Laboratory Address: No.10, Ln. 2, Lianfu St., Luzhu Dist., Taoyuan City 33848, Taiwan (R.O.C.) Tel:+886-3-3226-888 Fax:+886-3-3226-881 Address: No.68-1, Shihbachongsi, Shihding Township, New Taipei City 223, Taiwan, R.O.C. Tel: +886-2-2663-8582	
	FCC	TW1079, TW1061, TW1439
	IC	4934E-1, 4934E-2
	VCCI	T-2205 for Telecommunication test C-4663 for Conducted emission test R-4399, R-4218 for Radiated emission test G-10812, G-10813 for radiated disturbance above 1GHz
Frequency Range Investigated:	Conducted: from 150kHz to 30 MHz Radiation: from 30 MHz to 25,000MHz	
Test Distance:	The test distance of radiated emission from antenna to EUT is 3 M.	

Test Item	Test Site	Tested Date	Environmental Conditions	Tested By
RF Conducted	RFCON01-NK	2019/06/07	22°C / 63%	Spree Yeh
Radiated Emissions	3M02-NK	2019/06/03	24°C / 47%	Leon Huang
RF Conduction	CON01-NK	2019/06/08	24°C / 45%	Leon Huang



2.6 Measurement Uncertainty

Measurement Item	Uncertainty
Radiated Spurious Emission(9KHz~30MHz)	±3.405dB
Radiated Spurious Emission(30MHz~1GHz)	±5.326dB
Radiated Spurious Emission(1GHz~25GHz)	±5.918dB
Conducted Spurious Emission	±2.156dB
6dB Bandwidth	±4.401%
20dB Bandwidth	±4.40%
Occupied Bandwidth	±4.41%
Peak Output Power(Conducted Power Meter)	±1.31dB
Dwell Time	±0.11%
Power Spectral Density	±2.146dB
Duty Cycle	±0.17%



3. Test Equipment and Ancillaries Used for Tests

Test Item	Radiated Emissions				
Test Site	Semi Anechoic Room(3M02-NK)				
Instrument	Manufacturer	Model No	Serial No	Calibration Date	Valid Date
Bilog Antenna	Schwarzbeck	VULB9168	275	2018/09/17	2019/09/16
Active Loop Antenna	EMCO	6507	40855	2019/05/24	2020/05/23
Horn Antenna	EMCO	3115	31589	2019/04/01	2020/03/31
Horn Antenna	EMCO	3116	31974	2018/09/07	2019/09/06
EMI Receiver	ROHDE & SCHWARZ	ESCI	101423	2018/06/11	2019/06/10
Spectrum Analyzer	ROHDE & SCHWARZ	FSP 40	100219	2018/07/03	2019/07/02
Preamplifier	EM Electronics corp.	EM330	60660	2019/03/11	2020/03/10
Preamplifier	EMC INSTRUMENTS	EMC051845SE	980333	2018/09/18	2019/09/17
Bluetooth Tester	ROHDE & SCHWARZ	CBT	101133	2019/04/07	2020/04/06
Cable-3in1(30M-1G)	HARBOUR INDUSTRIES	LL142	CCE1316	2018/09/12	2019/09/11
Cable-0.5m(1G-40G)	Rapidtek	40GHZ 50CM	38MS-38MS50314	2019/04/09	2020/04/08
Cable-3m(1G-40G)	Rapidtek	40GHZ 300CM	38MS-38MS300314	2019/04/09	2020/04/08
Cable-8m(1G-40G)	Rapidtek	40GHZ 800CM	38MS-38MS800314	2019/04/10	2020/04/09
E3	AUDIX	v8.2014-8-6	RK-000529	NA	NA

Test Item	RF Conducted				
Test Site	RFCON01-NK				
Instrument	Manufacturer	Model No	Serial No	Calibration Date	Valid Date
Spectrum Analyzer	ROHDE & SCHWARZ	FSP 40	100219	2018/07/03	2019/07/02
Bluetooth Tester	ROHDE & SCHWARZ	CBT	101133	2019/04/07	2020/04/06
Attenuator	KEYSIGHT	8491B	MY39250705	2018/09/04	2019/09/03
TEMP & HUMIDITY CHAMBER	T-MACHINE	TMJ-9712	T-12-040111	2018/08/30	2019/08/29
Power Sensor	Anritsu	MA2411B	1207295	2019/04/11	2020/04/10

Test Item	AC Power Line Conducted Emission				
Test Site	CON01-NK				
Instrument	Manufacturer	Model No	Serial No	Calibration Date	Valid Date
EMI Receiver	ROHDE & SCHWARZ	ESCI	100821	2018/9/12	2019/09/11
Line Impedance Stabilization Network	Schwarzbeck	NSLK 8127	8127-740	2018/6/13	2019/06/12
Pulse Limiter	ROHDE & SCHWARZ	ESH3-Z2	101933	2018/9/4	2019/09/03
E3	AUDIX	v8.2014-8-6	RK-000531	NA	NA



4. Antenna Requirements

4.1 Standard Applicable

For intentional device, according to FCC 47 CFR Section 15.203, an intentional radiator shall be designed to ensure that no antenna other than that furnished by the responsible party shall be used with the device.

And according to FCC 47 CFR Section 15.247 (b), if transmitting antennas of directional gain greater than 6dBi are used, the power shall be reduced by the amount in dB that the directional gain of the antenna exceeds 6dBi.

4.2 Antenna Construction and Directional Gain

Antenna Type	Dipole Antenna
Antenna Gain	3.53dBi



5. Test of AC Power Line Conducted Emission

5.1 Test Limit

Conducted Emissions were measured from 150 kHz to 30 MHz with a bandwidth of 9 KHz, according to the methods defined in ANSI C63.4-2014. The EUT was placed on a nonmetallic stand in a shielded room 0.8 meters above the ground plane. The interface cables and equipment positioning were varied within limits of reasonable applications to determine the position produced maximum conducted emissions.

Frequency (MHz)	Quasi Peak (dB μ V)	Average (dB μ V)
0.15 – 0.5	66-56*	56-46*
0.5 – 5.0	56	46
5.0 – 30.0	60	50

*Decreases with the logarithm of the frequency.

5.2 Test Procedures

- a. The EUT was placed 0.4 meter from the conducting wall of the shielding room was kept at least 80 centimeters from any other grounded conducting surface.
- b. Connect EUT to the power mains through a line impedance stabilization network (LISN).
- c. All the support units are connecting to the other LISN.
- d. The LISN provides 50 ohm coupling impedance for the measuring instrument.
- e. The FCC states that a 50 ohm, 50 micro-Henry LISN should be used.
- f. Both sides of AC line were checked for maximum conducted interference.
- g. The frequency range from 150 kHz to 30 MHz was searched.
- h. Set the test-receiver system to Peak Detect Function and Specified Bandwidth with Maximum Hold Mode.



5.3 Typical Test Setup

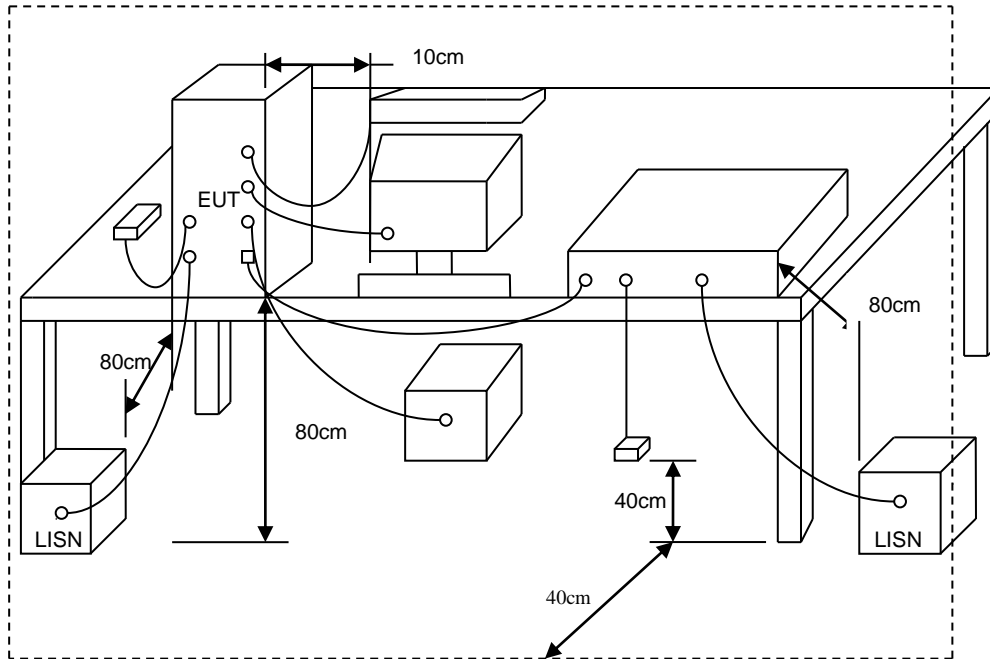



5.4 Test Result and Data

Power	: AC 120V / 60Hz	Pol/Phase	: LINE
Test Mode	: Mode 1		:

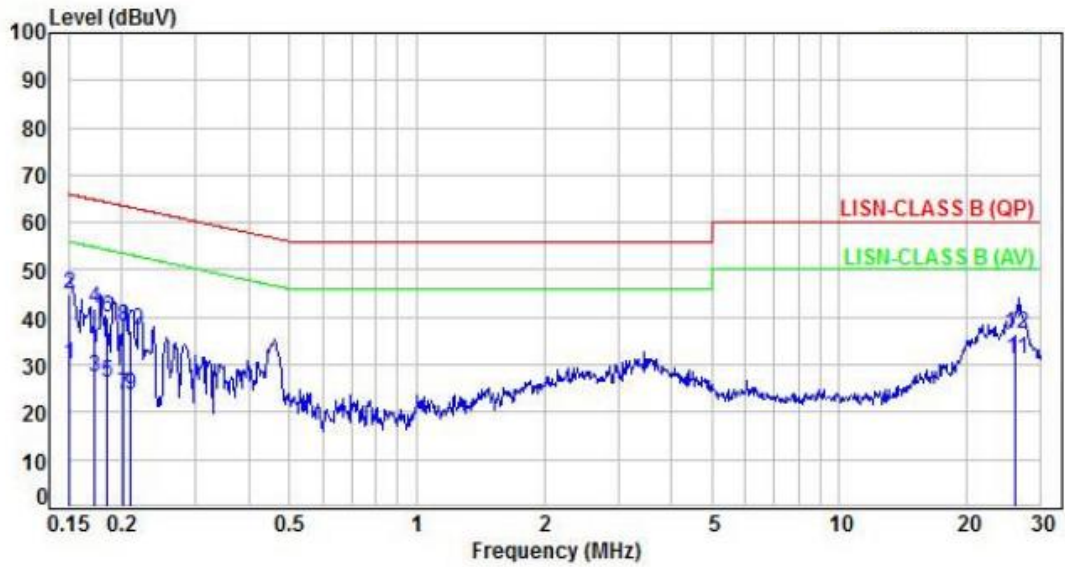

No.	Frequency (MHz)	Factor (dB)	Reading (dBuV)	Level (dBuV)	Limit (dBuV)	Margin (dB)	Detector	P/F
1	0.15	9.92	20.24	30.16	55.96	-25.80	Average	P
2	0.15	9.92	34.77	44.69	65.96	-21.27	QP	P
3	0.17	9.92	17.46	27.38	54.84	-27.46	Average	P
4	0.17	9.92	31.79	41.71	64.84	-23.13	QP	P
5	0.19	9.92	16.23	26.15	54.25	-28.10	Average	P
6	0.19	9.92	30.13	40.05	64.25	-24.20	QP	P
7	0.20	9.92	13.59	23.51	53.52	-30.01	Average	P
8	0.20	9.92	28.07	37.99	63.52	-25.53	QP	P
9	0.21	9.92	13.50	23.42	53.17	-29.75	Average	P
10	0.21	9.92	27.41	37.33	63.17	-25.84	QP	P
11	26.18	10.86	20.21	31.07	50.00	-18.93	Average	P
12	26.18	10.86	25.74	36.60	60.00	-23.40	QP	P

Note: Level=Reading+Factor
Margin=Level-Limit
Factor=(LISN or ISN or Current Probe)Factor + Cable Loss



Power	: AC 120V / 60Hz	Pol/Phase	: NEUTRAL
Test Mode	: Mode 1		:

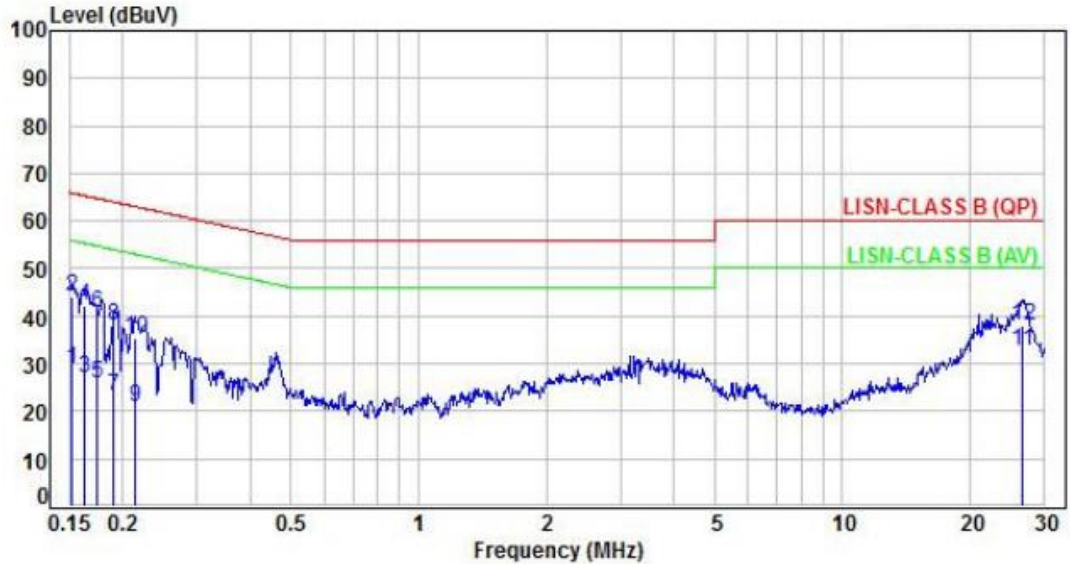

No.	Frequency (MHz)	Factor (dB)	Reading (dBuV)	Level (dBuV)	Limit (dBuV)	Margin (dB)	Detector	P/F
1	0.15	9.95	19.08	29.03	55.93	-26.90	Average	P
2	0.15	9.95	34.03	43.98	65.93	-21.95	QP	P
3	0.16	9.95	16.92	26.87	55.31	-28.44	Average	P
4	0.16	9.95	32.09	42.04	65.31	-23.27	QP	P
5	0.17	9.95	15.97	25.92	54.72	-28.80	Average	P
6	0.17	9.95	30.74	40.69	64.72	-24.03	QP	P
7	0.19	9.95	13.41	23.36	54.00	-30.64	Average	P
8	0.19	9.95	28.23	38.18	64.00	-25.82	QP	P
9	0.21	9.95	11.14	21.09	53.02	-31.93	Average	P
10	0.21	9.95	25.55	35.50	63.02	-27.52	QP	P
11	26.53	10.89	21.63	32.52	50.00	-17.48	Average	P
12	26.53	10.89	27.27	38.16	60.00	-21.84	QP	P

Note: Level=Reading+Factor
 Margin=Level-Limit
 Factor=(LISN or ISN or Current Probe)Factor + Cable Loss



6. Test of Radiated Spurious Emission

6.1 Test Limit

In any 100kHz bandwidth outside the frequency band in which the spread spectrum or digitally modulated intentional radiator is operating, the radio frequency power that is produced by the intentional radiator shall be at least 20dB below that in the 100kHz bandwidth within the band that contains the highest level of the desired power, based on either an RF conducted or a radiated measurement. If the transmitter measurement is based on the maximum conducted output power, the attenuation required under this paragraph shall be 30dB instead of 20dB. In addition, radiated emissions which fall in section 15.205(a) the restricted bands must also comply with the radiated emission limit specified in section 15.209(a).

Frequency (MHz)	Field Strength (microvolt/meter)	Measurement Distance (meters)
0.009 ~ 0.490	2400/F(kHz)	300
0.490 ~ 1.705	24000/F(kHz)	30
1.705 ~ 30.0	30	30
30 ~ 88	100	3
88 ~ 216	150	3
216 ~ 960	200	3
Above 960	500	3

6.2 Test Procedures

- The EUT was placed on a rotatable table top 0.8 meter above ground.
- The EUT was set 3 meters from the interference receiving antenna which was mounted on the top of a variable height antenna tower.
- The table was rotated 360 degrees to determine the position of the highest radiation.
- The antenna is a broadband antenna and its height is varied between one meter and four meters above ground to find the maximum value of the field strength both horizontal polarization and vertical polarization of the antenna are set to make the measurement.
- For each suspected emission the EUT was arranged to its worst case and then tune the antenna tower (from 1 M to 4 M) and turn table (from 0 degree to 360 degrees) to find the maximum reading.
- Set the test-receiver system to Peak or CISPR quasi-peak Detect Function and specified bandwidth with Maximum Hold Mode.
- If the emission level of the EUT in peak mode was 3 dB lower than the limit specified, then testing will be stopped and peak values of EUT will be reported, otherwise, the emissions which do not have 3 dB margin will be repeated one by one using the quasi-peak method and reported.
- For testing above 1GHz, the emission level of the EUT in peak mode was 20dB lower than average limit (that means the emission level in peak mode also complies with the limit in average mode), then testing will be stopped and peak values of EUT will be reported, otherwise, the emissions will be measured in average mode again and reported.



6.3 Typical Test Setup

Below 30MHz test setup

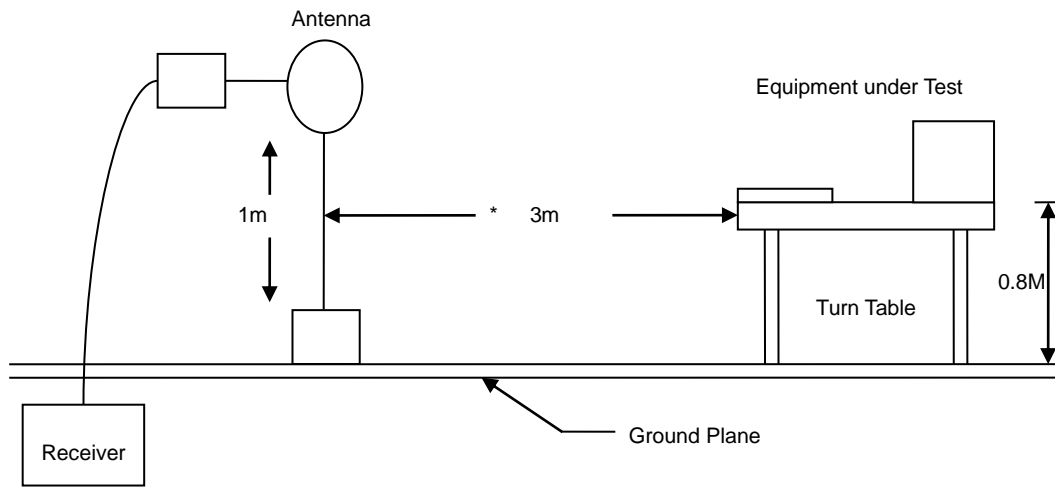

30MHz- 1GHz Test Setup

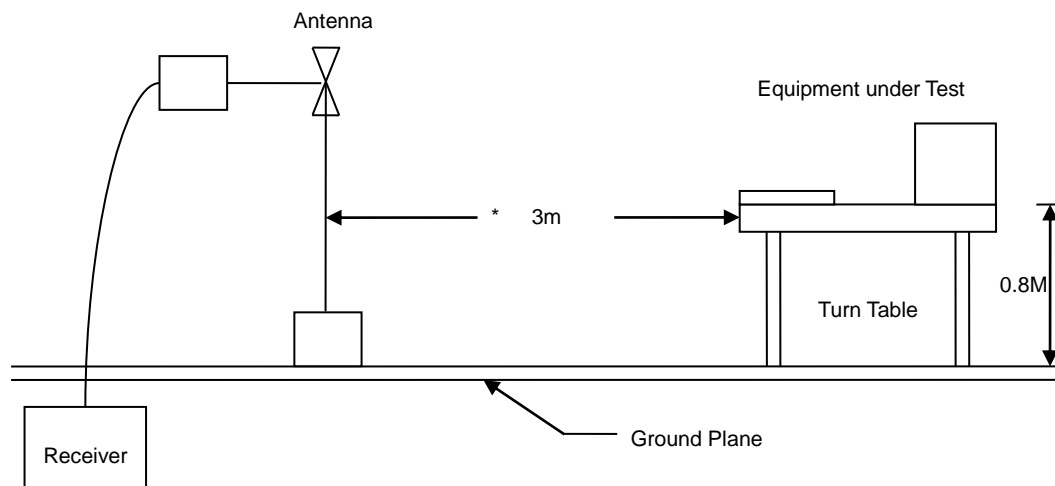

Above 1GHz Test Setup

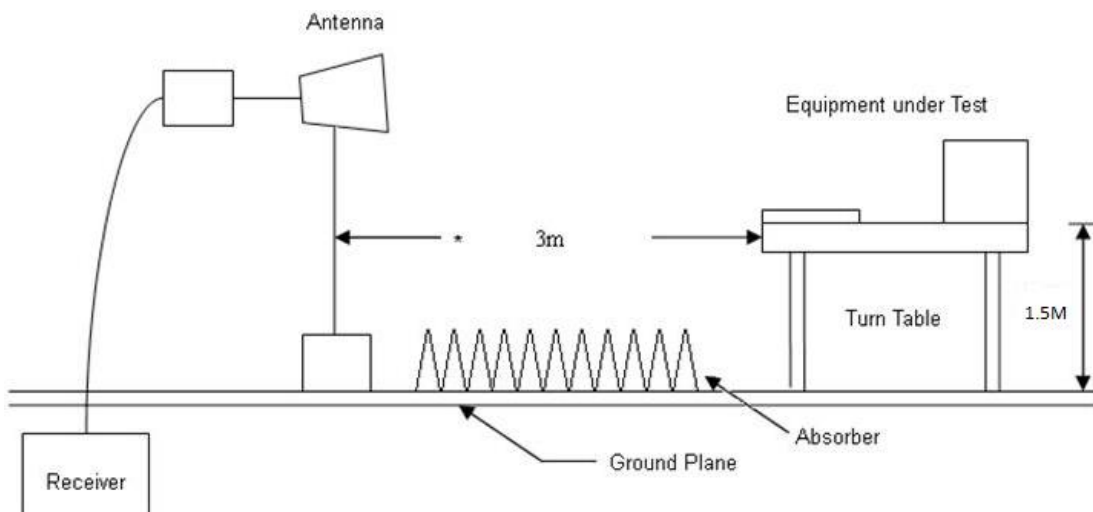



6.4 Test Result and Data (9kHz ~ 30MHz)

The 9kHz-30MHz spurious emission is under limit 20dB more.

6.5 Test Result and Data (30MHz ~ 1GHz)

Power	: AC 120V / 60Hz	Pol/Phase	: VERTICAL
Test Mode	: Mode 1		:

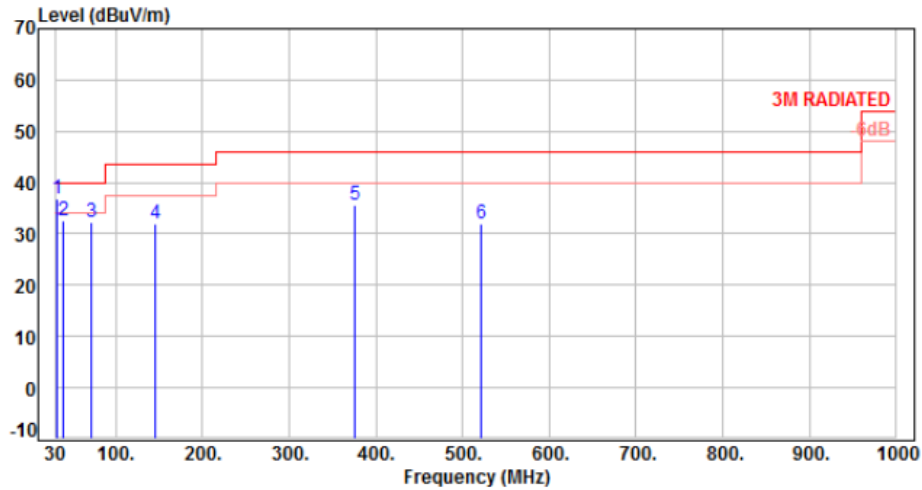

No.	Frequency (MHz)	Factor (dB)	Reading (dBUV)	Level (dBUV/m)	Limit (dBUV/m)	Margin (dB)	Detector	Height (cm)	Azimuth (deg)	P/F
1	32.91	-10.64	47.43	36.79	40.00	-3.21	Peak	400	0	P
2	39.92	-9.68	42.20	32.52	40.00	-7.48	QP	100	150	P
3	71.71	-11.92	44.11	32.19	40.00	-7.81	Peak	400	0	P
4	145.43	-9.70	41.70	32.00	43.50	-11.50	Peak	400	0	P
5	375.32	-6.51	42.21	35.70	46.00	-10.30	Peak	400	0	P
6	520.82	-3.24	35.20	31.96	46.00	-14.04	Peak	400	0	P

Note: Level=Reading+Factor
Margin=Level-Limit
Factor=Antenna Factor + cable loss - Amplifier Factor



Power	: AC 120V / 60Hz	Pol/Phase	: HORIZONTAL
Test Mode	: Mode 1		:

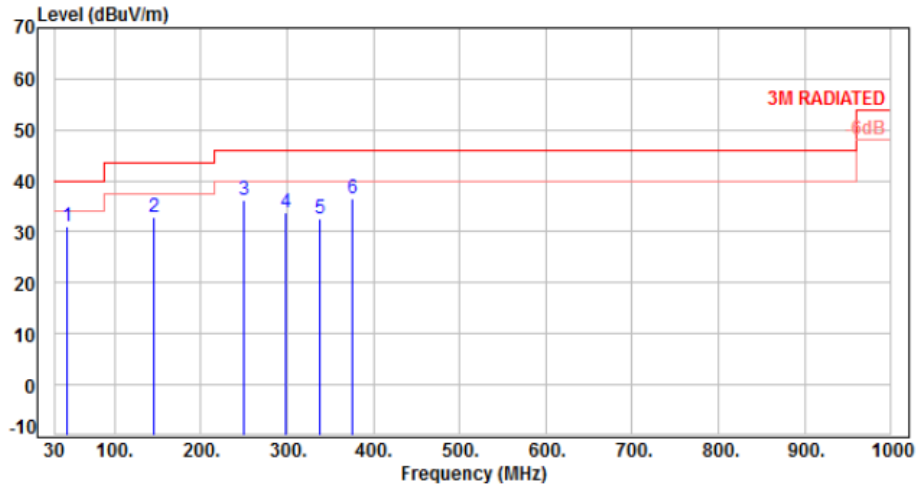

No.	Frequency (MHz)	Factor (dB)	Reading (dBuV)	Level (dBuV/m)	Limit (dBuV/m)	Margin (dB)	Detector	Height (cm)	Azimuth (deg)	P/F
1	44.55	-9.44	40.54	31.10	40.00	-8.90	Peak	100	0	P
2	145.43	-9.70	42.70	33.00	43.50	-10.50	Peak	100	0	P
3	250.19	-10.37	46.51	36.14	46.00	-9.86	Peak	100	0	P
4	297.72	-8.74	42.49	33.75	46.00	-12.25	Peak	100	0	P
5	337.49	-7.53	40.11	32.58	46.00	-13.42	Peak	100	0	P
6	375.32	-6.51	43.06	36.55	46.00	-9.45	Peak	100	0	P

Note: Level=Reading+Factor
Margin=Level-Limit
Factor=Antenna Factor + cable loss - Amplifier Factor



6.6 Test Result and Data (1GHz ~ 25GHz)

Power	: AC 120V / 60Hz	Pol/Phase	: VERTICAL
Test Mode	: Mode 1, CH00, DH5		

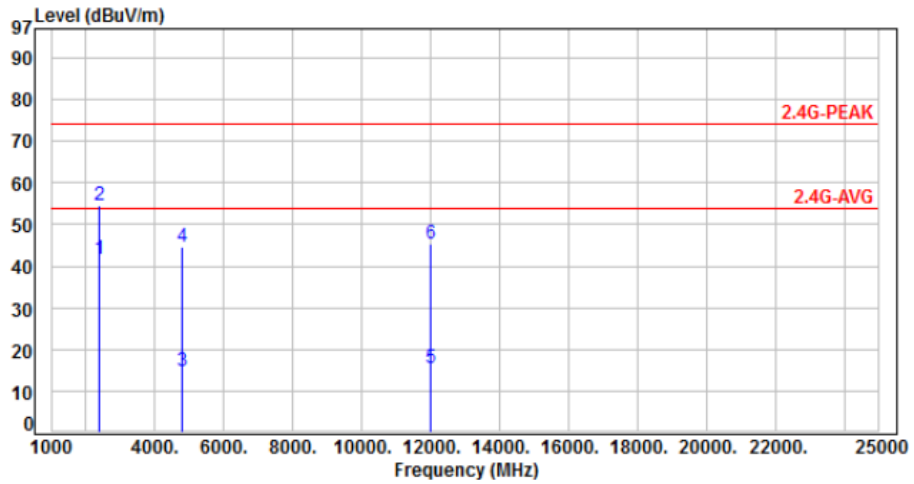

No.	Frequency (MHz)	Factor (dB)	Reading (dBuV)	Level (dBuV/m)	Limit (dBuV/m)	Margin (dB)	Detector	Height (cm)	Azimuth (deg)	P/F
1	2390.00	-14.61	56.12	41.51	54.00	-12.49	Average	225	180	P
2	2390.00	-14.61	69.35	54.74	74.00	-19.26	Peak	225	180	P
3	4804.00	-6.91	21.53	14.62	54.00	-39.38	Average	100	167	P
4	4804.00	-6.91	51.63	44.72	74.00	-29.28	Peak	100	167	P
5	12010.00	4.64	10.74	15.38	54.00	-38.62	Average	100	210	P
6	12010.00	4.64	40.84	45.48	74.00	-28.52	Peak	100	210	P

Note: Level=Reading+Factor
 Margin=Level-Limit
 Factor=Antenna Factor + cable loss - Amplifier Factor



Power	: AC 120V / 60Hz	Pol/Phase	: HORIZONTAL
Test Mode	: Mode 1, CH00, DH5		:

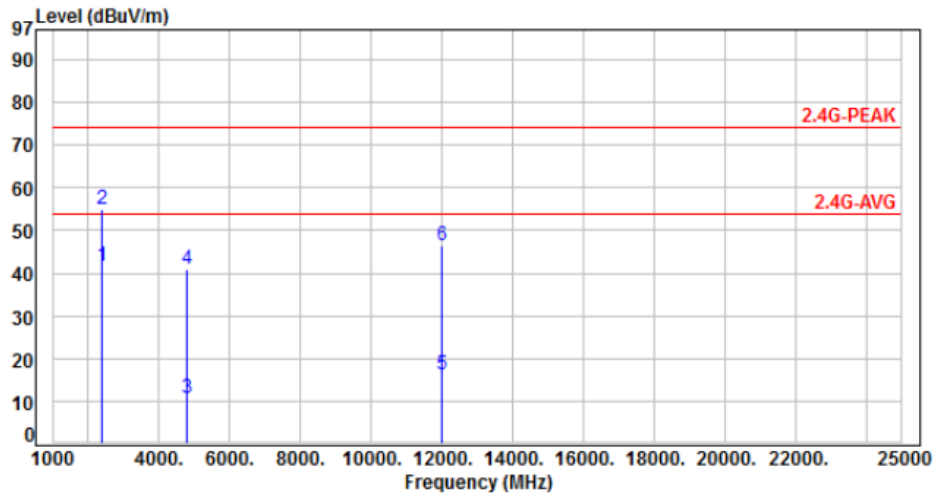

No.	Frequency (MHz)	Factor (dB)	Reading (dBuV)	Level (dBuV/m)	Limit (dBuV/m)	Margin (dB)	Detector	Height (cm)	Azimuth (deg)	P/F
1	2390.00	-14.61	56.14	41.53	54.00	-12.47	Average	100	300	P
2	2390.00	-14.61	69.39	54.78	74.00	-19.22	Peak	100	300	P
3	4804.00	-6.91	17.58	10.67	54.00	-43.33	Average	100	102	P
4	4804.00	-6.91	47.68	40.77	74.00	-33.23	Peak	100	102	P
5	12010.00	4.64	11.61	16.25	54.00	-37.75	Average	100	130	P
6	12010.00	4.64	41.71	46.35	74.00	-27.65	Peak	100	130	P

Note: Level=Reading+Factor
Margin=Level-Limit
Factor=Antenna Factor + cable loss - Amplifier Factor



Power	: AC 120V / 60Hz	Pol/Phase	: VERTICAL
Test Mode	: Mode 1, CH39, DH5		:

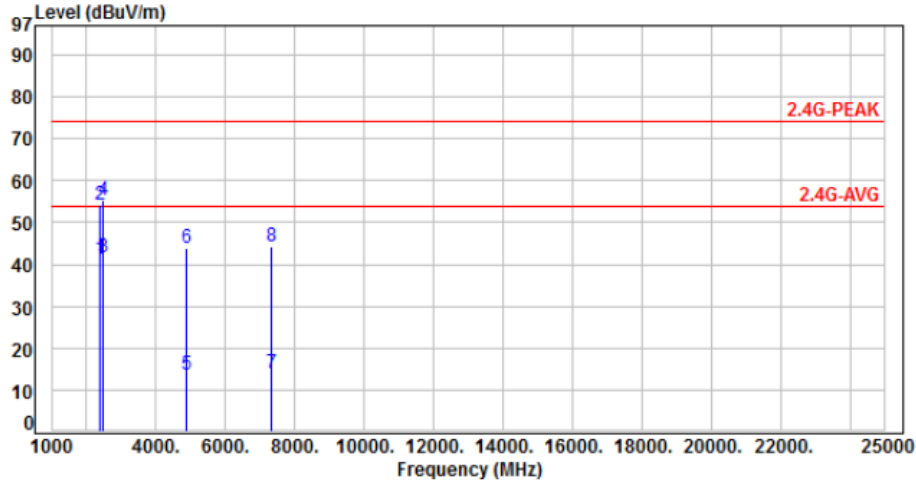

No.	Frequency (MHz)	Factor (dB)	Reading (dBuV)	Level (dBuV/m)	Limit (dBuV/m)	Margin (dB)	Detector	Height (cm)	Azimuth (deg)	P/F
1	2390.00	-14.61	55.92	41.31	54.00	-12.69	Average	210	178	P
2	2390.00	-14.61	68.83	54.22	74.00	-19.78	Peak	210	178	P
3	2483.50	-14.22	55.80	41.58	54.00	-12.42	Average	210	178	P
4	2483.50	-14.22	69.56	55.34	74.00	-18.66	Peak	210	178	P
5	4882.00	-6.61	20.38	13.77	54.00	-40.23	Average	100	163	P
6	4882.00	-6.61	50.48	43.87	74.00	-30.13	Peak	100	163	P
7	7323.00	-1.27	15.32	14.05	54.00	-39.95	Average	100	75	P
8	7323.00	-1.27	45.42	44.15	74.00	-29.85	Peak	100	75	P

Note: Level=Reading+Factor
 Margin=Level-Limit
 Factor=Antenna Factor + cable loss - Amplifier Factor



Power	: AC 120V / 60Hz	Pol/Phase	: HORIZONTAL
Test Mode	: Mode 1, CH39, DH5		:

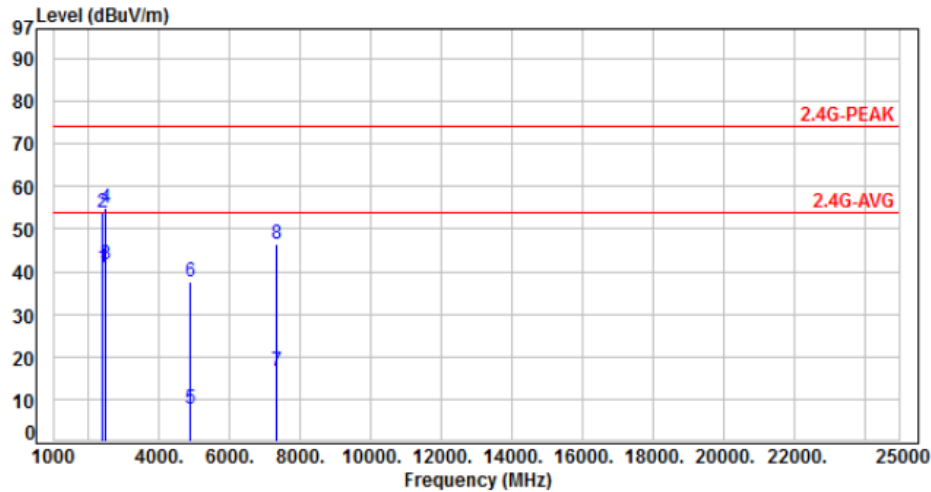

No.	Frequency (MHz)	Factor (dB)	Reading (dBuV)	Level (dBuV/m)	Limit (dBuV/m)	Margin (dB)	Detector	Height (cm)	Azimuth (deg)	P/F
1	2390.00	-14.61	55.67	41.06	54.00	-12.94	Average	130	302	P
2	2390.00	-14.61	68.58	53.97	74.00	-20.03	Peak	130	302	P
3	2483.50	-14.22	55.89	41.67	54.00	-12.33	Average	130	302	P
4	2483.50	-14.22	69.09	54.87	74.00	-19.13	Peak	130	302	P
5	4882.00	-6.61	14.29	7.68	54.00	-46.32	Average	100	195	P
6	4882.00	-6.61	44.39	37.78	74.00	-36.22	Peak	100	195	P
7	7323.00	-1.27	17.78	16.51	54.00	-37.49	Average	100	251	P
8	7323.00	-1.27	47.88	46.61	74.00	-27.39	Peak	100	251	P

Note: Level=Reading+Factor
 Margin=Level-Limit
 Factor=Antenna Factor + cable loss - Amplifier Factor



Power	: AC 120V / 60Hz	Pol/Phase	: VERTICAL
Test Mode	: Mode 1, CH78, DH5		:

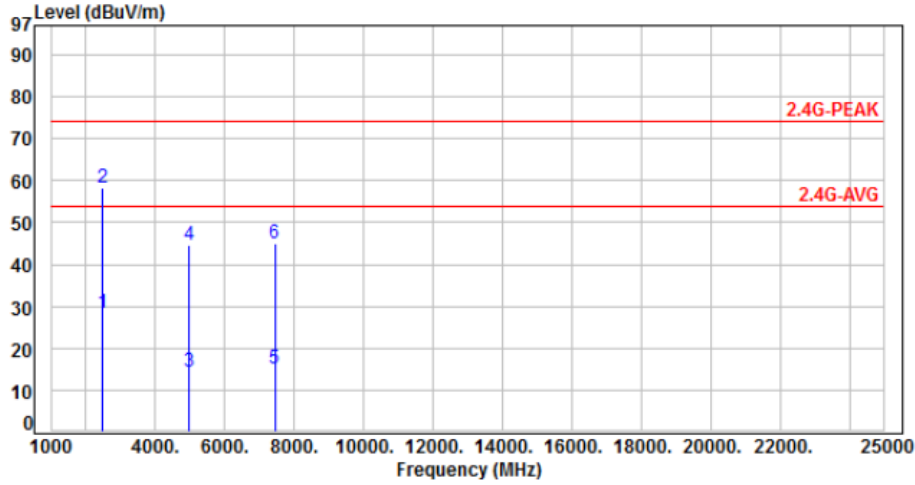

No.	Frequency (MHz)	Factor (dB)	Reading (dBuV)	Level (dBuV/m)	Limit (dBuV/m)	Margin (dB)	Detector	Height (cm)	Azimuth (deg)	P/F
1	2483.50	-14.22	42.50	28.28	54.00	-25.72	Average	270	205	P
2	2483.50	-14.22	72.60	58.38	74.00	-15.62	Peak	270	205	P
3	4960.00	-6.39	20.78	14.39	54.00	-39.61	Average	100	174	P
4	4960.00	-6.39	50.88	44.49	74.00	-29.51	Peak	100	174	P
5	7440.00	-1.14	16.19	15.05	54.00	-38.95	Average	100	25	P
6	7440.00	-1.14	46.29	45.15	74.00	-28.85	Peak	100	25	P

Note: Level=Reading+Factor
Margin=Level-Limit
Factor=Antenna Factor + cable loss - Amplifier Factor



Power	: AC 120V / 60Hz	Pol/Phase	: HORIZONTAL
Test Mode	: Mode 1, CH78, DH5		:

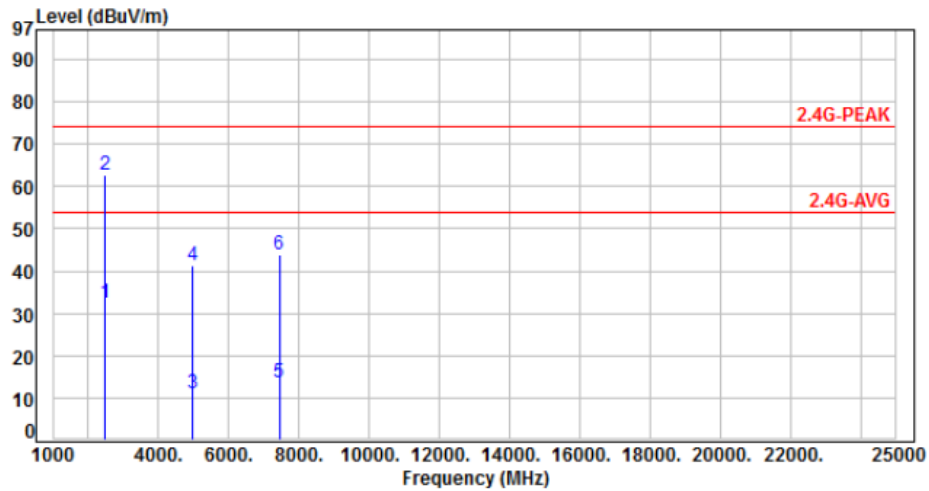

No.	Frequency (MHz)	Factor (dB)	Reading (dBuV)	Level (dBuV/m)	Limit (dBuV/m)	Margin (dB)	Detector	Height (cm)	Azimuth (deg)	P/F
1	2483.50	-14.22	46.83	32.61	54.00	-21.39	Average	100	305	P
2	2483.50	-14.22	76.93	62.71	74.00	-11.29	Peak	100	305	P
3	4960.00	-6.39	17.50	11.11	54.00	-42.89	Average	100	208	P
4	4960.00	-6.39	47.60	41.21	74.00	-32.79	Peak	100	208	P
5	7440.00	-1.14	14.96	13.82	54.00	-40.18	Average	100	145	P
6	7440.00	-1.14	45.06	43.92	74.00	-30.08	Peak	100	145	P

Note: Level=Reading+Factor
Margin=Level-Limit
Factor=Antenna Factor + cable loss - Amplifier Factor



Power	: AC 120V / 60Hz	Pol/Phase	: VERTICAL
Test Mode	: Mode 3, CH00, 3DH5		:

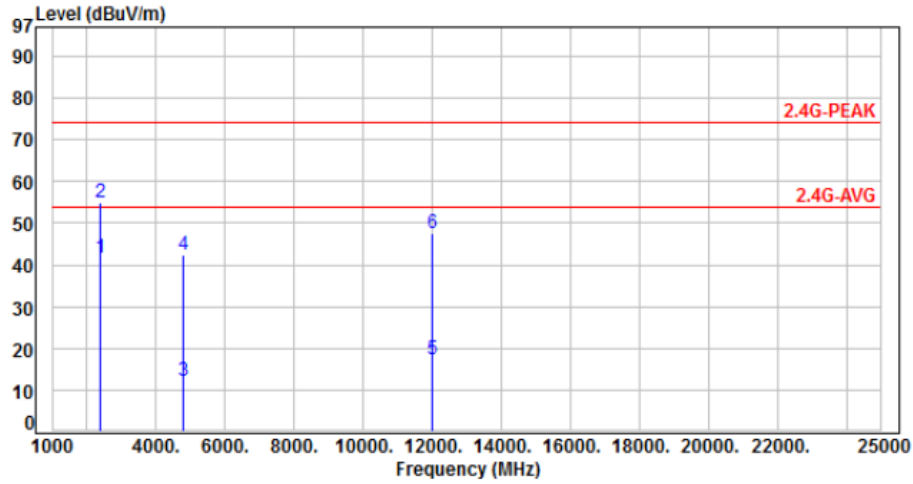

No.	Frequency (MHz)	Factor (dB)	Reading (dBuV)	Level (dBuV/m)	Limit (dBuV/m)	Margin (dB)	Detector	Height (cm)	Azimuth (deg)	P/F
1	2390.00	-14.61	56.26	41.65	54.00	-12.35	Average	225	178	P
2	2390.00	-14.61	69.46	54.85	74.00	-19.15	Peak	225	178	P
3	4804.00	-6.91	19.24	12.33	54.00	-41.67	Average	100	158	P
4	4804.00	-6.91	49.34	42.43	74.00	-31.57	Peak	100	158	P
5	12010.00	4.64	12.81	17.45	54.00	-36.55	Average	100	55	P
6	12010.00	4.64	42.91	47.55	74.00	-26.45	Peak	100	55	P

Note: Level=Reading+Factor
 Margin=Level-Limit
 Factor=Antenna Factor + cable loss - Amplifier Factor



Power	: AC 120V / 60Hz	Pol/Phase	: HORIZONTAL
Test Mode	: Mode 3, CH00, 3DH5		:

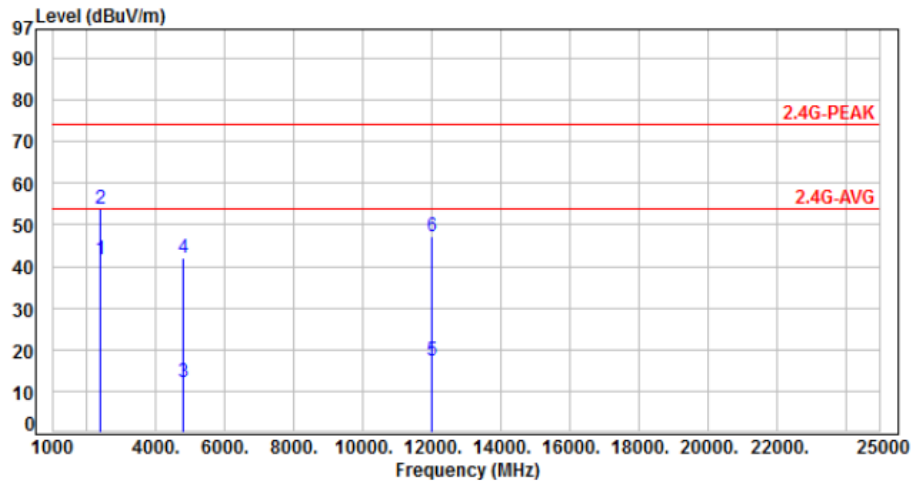

No.	Frequency (MHz)	Factor (dB)	Reading (dBuV)	Level (dBuV/m)	Limit (dBuV/m)	Margin (dB)	Detector	Height (cm)	Azimuth (deg)	P/F
1	2390.00	-14.61	56.10	41.49	54.00	-12.51	Average	100	300	P
2	2390.00	-14.61	68.39	53.78	74.00	-20.22	Peak	100	300	P
3	4804.00	-6.91	19.01	12.10	54.00	-41.90	Average	100	40	P
4	4804.00	-6.91	49.11	42.20	74.00	-31.80	Peak	100	40	P
5	12010.00	4.64	12.63	17.27	54.00	-36.73	Average	100	279	P
6	12010.00	4.64	42.73	47.37	74.00	-26.63	Peak	100	279	P

Note: Level=Reading+Factor
 Margin=Level-Limit
 Factor=Antenna Factor + cable loss - Amplifier Factor



Power	: AC 120V / 60Hz	Pol/Phase	: VERTICAL
Test Mode	: Mode 3, CH39, 3DH5		:

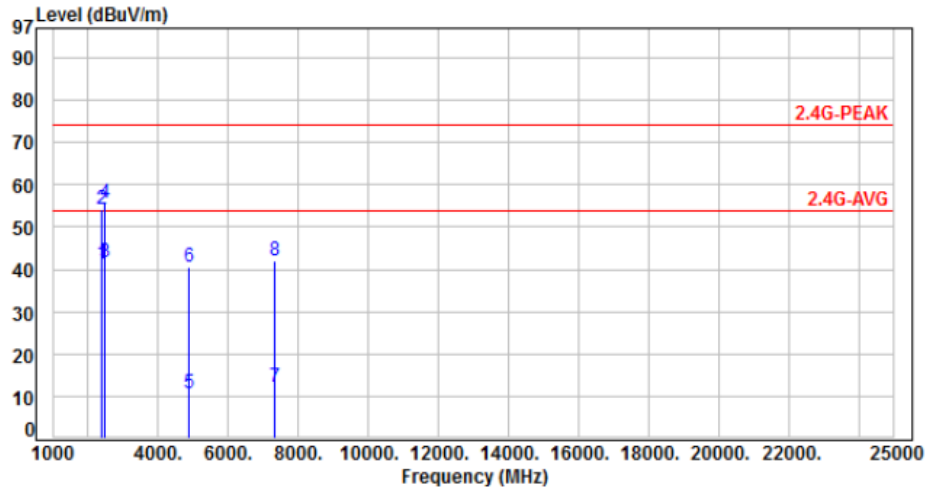

No.	Frequency (MHz)	Factor (dB)	Reading (dBUV)	Level (dBUV/m)	Limit (dBUV/m)	Margin (dB)	Detector	Height (cm)	Azimuth (deg)	P/F
1	2390.00	-14.61	55.89	41.28	54.00	-12.72	Average	220	178	P
2	2390.00	-14.61	68.87	54.26	74.00	-19.74	Peak	220	178	P
3	2483.50	-14.22	55.81	41.59	54.00	-12.41	Average	100	190	P
4	2483.50	-14.22	70.09	55.87	74.00	-18.13	Peak	100	190	P
5	4882.00	-6.61	17.25	10.64	54.00	-43.36	Average	100	175	P
6	4882.00	-6.61	47.35	40.74	74.00	-33.26	Peak	100	175	P
7	7323.00	-1.27	13.36	12.09	54.00	-41.91	Average	100	190	P
8	7323.00	-1.27	43.46	42.19	74.00	-31.81	Peak	100	190	P

Note: Level=Reading+Factor
 Margin=Level-Limit
 Factor=Antenna Factor + cable loss - Amplifier Factor



Power	: AC 120V / 60Hz	Pol/Phase	: HORIZONTAL
Test Mode	: Mode 3, CH39, 3DH5		:

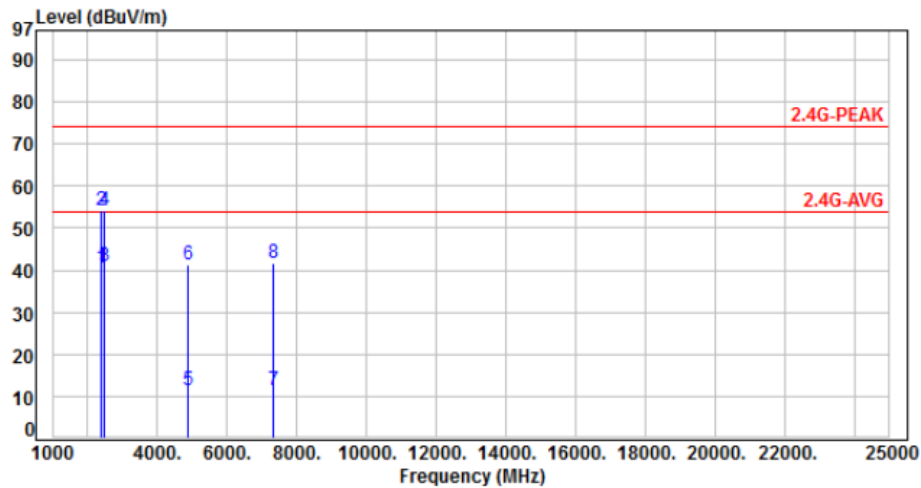

No.	Frequency (MHz)	Factor (dB)	Reading (dBuV)	Level (dBuV/m)	Limit (dBuV/m)	Margin (dB)	Detector	Height (cm)	Azimuth (deg)	P/F
1	2390.00	-14.61	55.16	40.55	54.00	-13.45	Average	100	302	P
2	2390.00	-14.61	68.67	54.06	74.00	-19.94	Peak	100	302	P
3	2483.50	-14.22	55.32	41.10	54.00	-12.90	Average	100	302	P
4	2483.50	-14.22	68.42	54.20	74.00	-19.80	Peak	100	302	P
5	4882.00	-6.61	17.92	11.31	54.00	-42.69	Average	100	100	P
6	4882.00	-6.61	48.02	41.41	74.00	-32.59	Peak	100	100	P
7	7323.00	-1.27	12.70	11.43	54.00	-42.57	Average	100	69	P
8	7323.00	-1.27	42.80	41.53	74.00	-32.47	Peak	100	69	P

Note: Level=Reading+Factor
 Margin=Level-Limit
 Factor=Antenna Factor + cable loss - Amplifier Factor



Power	: AC 120V / 60Hz	Pol/Phase	: VERTICAL
Test Mode	: Mode 3, CH78, 3DH5		:

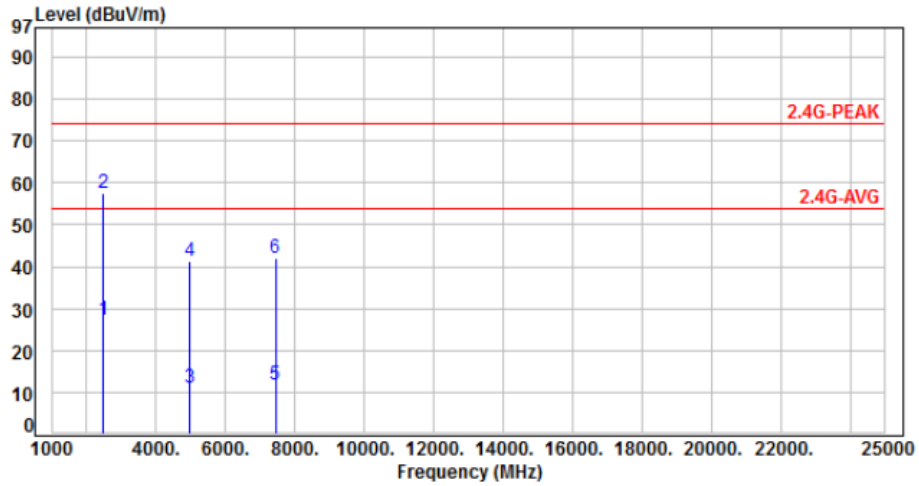

No.	Frequency (MHz)	Factor (dB)	Reading (dBuV)	Level (dBuV/m)	Limit (dBuV/m)	Margin (dB)	Detector	Height (cm)	Azimuth (deg)	P/F
1	2483.50	-14.22	41.54	27.32	54.00	-26.68	Average	320	172	P
2	2483.50	-14.22	71.64	57.42	74.00	-16.58	Peak	320	172	P
3	4960.00	-6.39	17.55	11.16	54.00	-42.84	Average	100	175	P
4	4960.00	-6.39	47.65	41.26	74.00	-32.74	Peak	100	175	P
5	7440.00	-1.14	12.91	11.77	54.00	-42.23	Average	100	285	P
6	7440.00	-1.14	43.01	41.87	74.00	-32.13	Peak	100	285	P

Note: Level=Reading+Factor
 Margin=Level-Limit
 Factor=Antenna Factor + cable loss - Amplifier Factor



Power	: AC 120V / 60Hz	Pol/Phase	: HORIZONTAL
Test Mode	: Mode 3, CH78, 3DH5		:

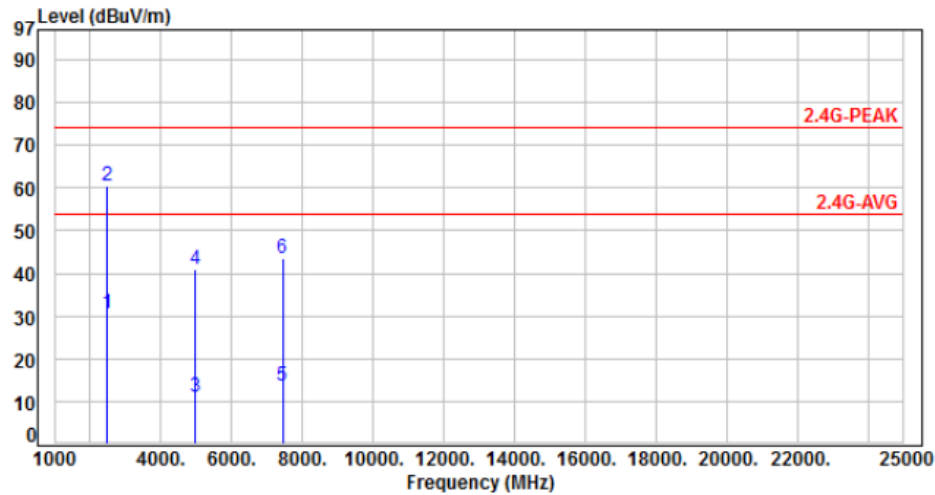

No.	Frequency (MHz)	Factor (dB)	Reading (dBuV)	Level (dBuV/m)	Limit (dBuV/m)	Margin (dB)	Detector	Height (cm)	Azimuth (deg)	P/F
1	2483.50	-14.22	44.68	30.46	54.00	-23.54	Average	100	305	P
2	2483.50	-14.22	74.78	60.56	74.00	-13.44	Peak	100	305	P
3	4960.00	-6.39	17.34	10.95	54.00	-43.05	Average	100	83	P
4	4960.00	-6.39	47.44	41.05	74.00	-32.95	Peak	100	83	P
5	7440.00	-1.14	14.62	13.48	54.00	-40.52	Average	100	105	P
6	7440.00	-1.14	44.72	43.58	74.00	-30.42	Peak	100	105	P

Note: Level=Reading+Factor
Margin=Level-Limit
Factor=Antenna Factor + cable loss - Amplifier Factor



6.7 Restricted Bands of Operation

Only spurious emissions are permitted in any of the frequency bands listed below:

MHz	MHz	MHz	GHz
0.09000 – 0.11000	16.42000 – 16.42300	399.9 – 410.0	4.500 – 5.250
0.49500 – 0.505**	16.69475 – 16.69525	608.0 – 614.0	5.350 – 5.460
2.17350 – 2.19050	16.80425 – 16.80475	960.0 – 1240.0	7.250 – 7.750
4.12500 – 4.12800	25.50000 – 25.67000	1300.0 – 1427.0	8.025 – 8.500
4.17725 – 4.17775	37.50000 – 38.25000	1435.0 – 1626.5	9.000 – 9.200
4.20725 – 4.20775	73.00000 – 74.60000	1645.5 – 1646.5	9.300 – 9.500
6.21500 – 6.21800	74.80000 – 75.20000	1660.0 – 1710.0	10.600 – 12.700
6.26775 – 6.26825	108.00000 – 121.94000	1718.8 – 1722.2	13.250 – 13.400
6.31175 – 6.31225	123.00000 – 138.00000	2200.0 – 2300.0	14.470 – 14.500
8.29100 – 8.29400	149.90000 – 150.05000	2310.0 – 2390.0	15.350 – 16.200
8.36200 – 8.36600	156.52475 – 156.52525	2483.5 – 2500.0	17.700 – 21.400
8.37625 – 8.38675	156.70000 – 156.90000	2655.0 – 2900.0	22.010 – 23.120
8.41425 – 8.41475	162.01250 – 167.17000	3260.0 – 3267.0	23.600 – 24.000
12.29000 – 12.29300	167.72000 – 173.20000	3332.0 – 3339.0	31.200 – 31.800
12.51975 – 12.52025	240.00000 – 285.00000	3345.8 – 3358.0	36.430 – 36.500
12.57675 – 12.57725	322.00000 – 335.40000	3600.0 – 4400.0	Above 38.6
13.36000 – 13.41000			

** : Until February 1, 1999, this restricted band shall be 0.490-0.510 MHz



7. Test of Conducted Spurious Emission

7.1 Test Limit

Below -20dB of the highest emission level of operating band (in 100kHz Resolution Bandwidth).

7.2 Test Procedure

- a. The transmitter output was connected to the spectrum analyzer via a low loss cable.
- b. Set both RBW and VBW of spectrum analyzer to 100 KHz with convenient frequency span including 100 KHz bandwidth from band edge.
- c. The band edges was measured and recorded.

7.3 Test Setup Layout

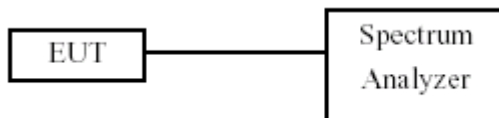

7.4 Test Result and Data

Note: Test plots refer to the following pages.



Modulation Type: GFSK, CH00

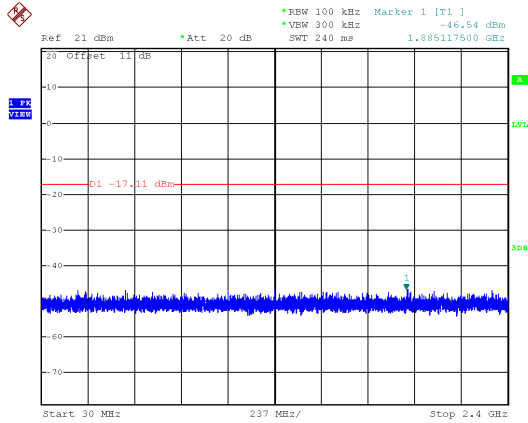

Modulation Type: GFSK, CH39

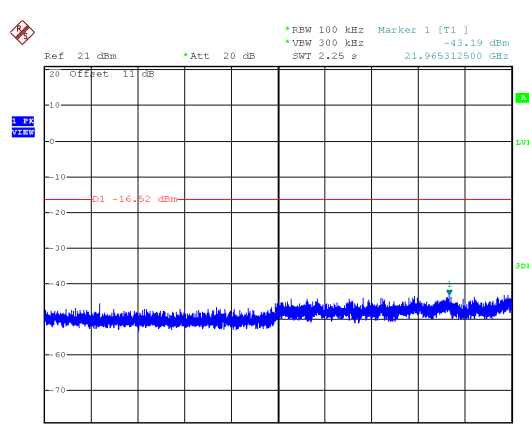
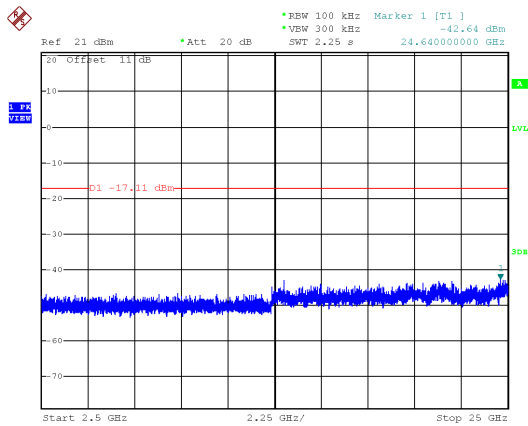
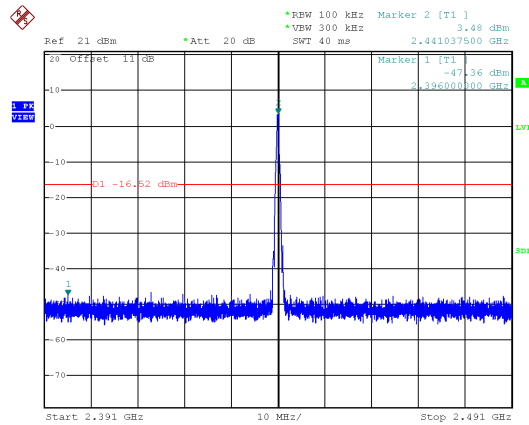
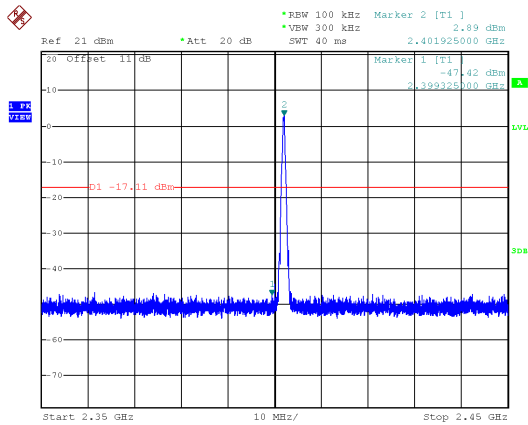
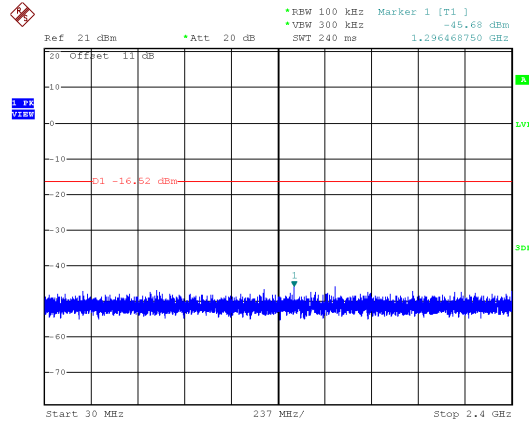



Modulation Type: GFSK, CH78

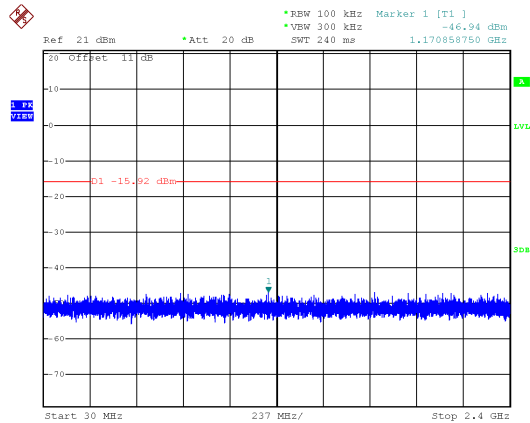

Modulation Type: $\pi/4$ -DQPSK, CH00

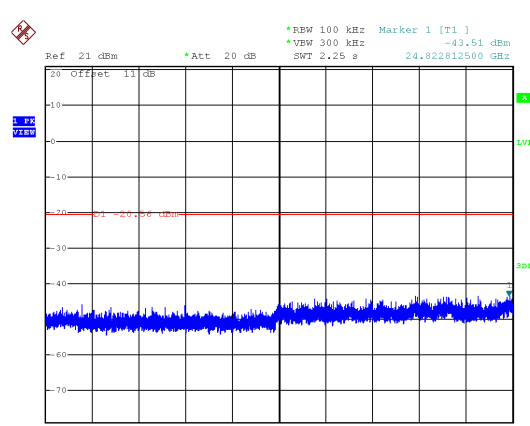
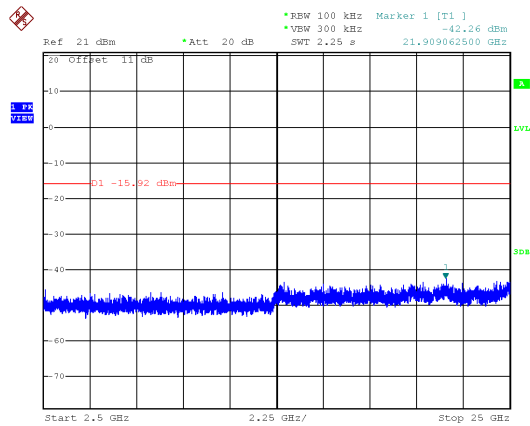
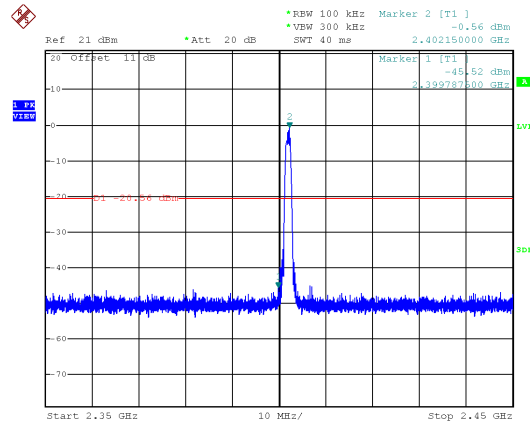
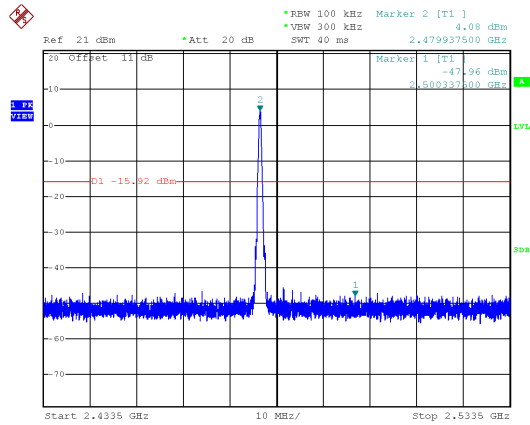
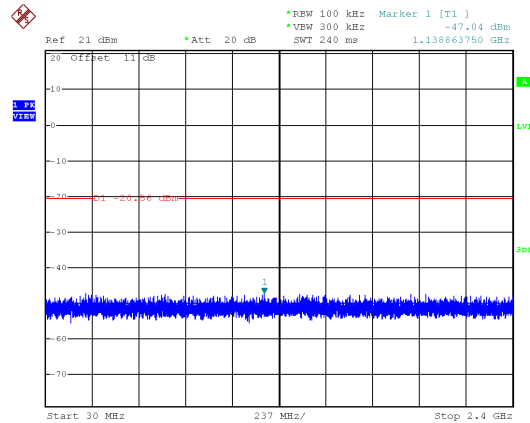



Modulation Type: $\pi/4$ -DQPSK, CH39

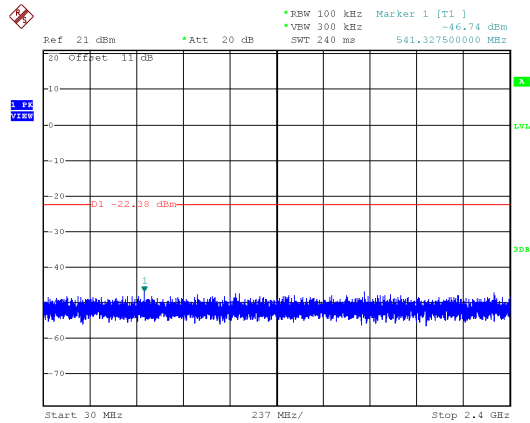

Modulation Type: $\pi/4$ -DQPSK, CH78

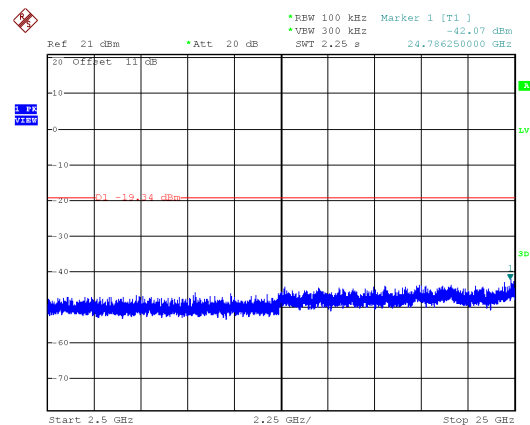
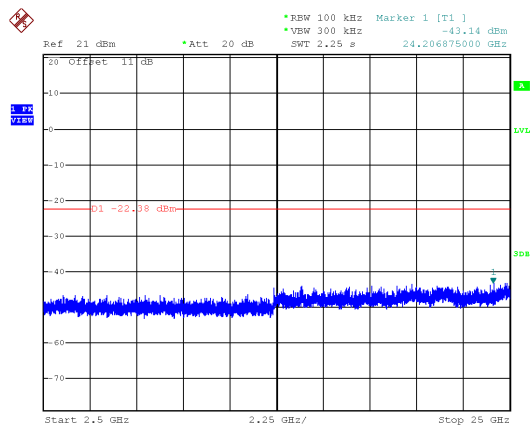
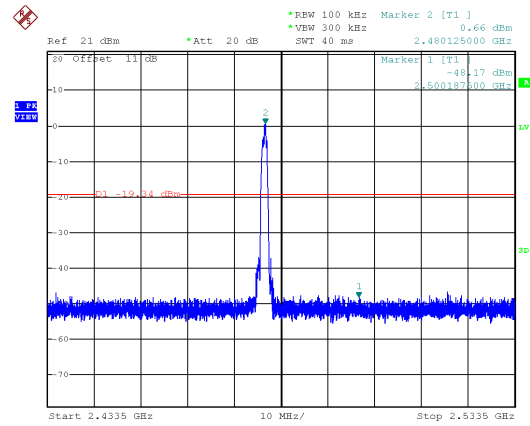
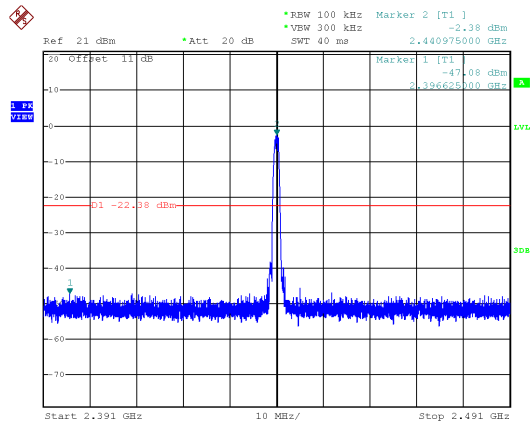
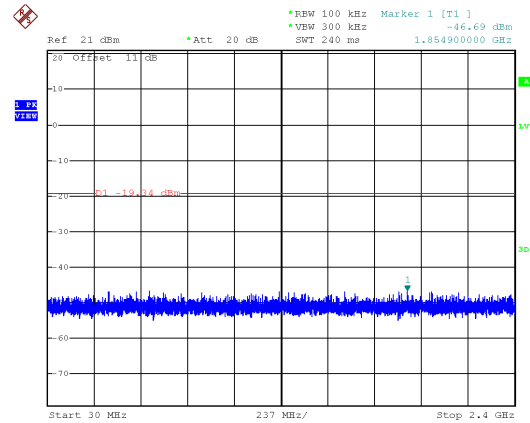



Modulation Type: 8DPSK, CH00

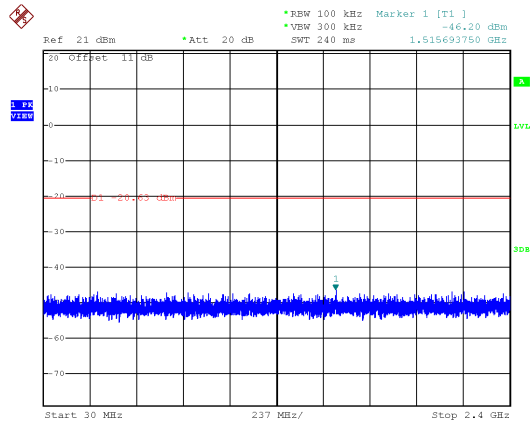

Modulation Type: 8DPSK, CH39

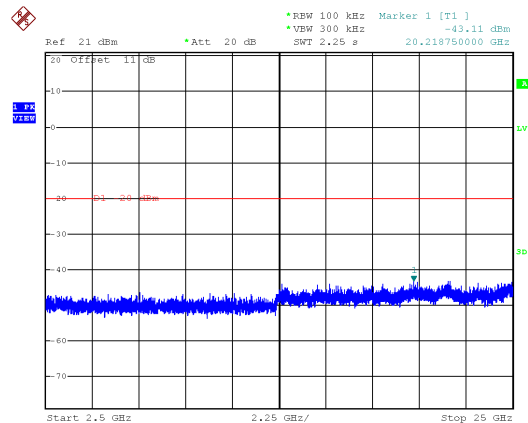
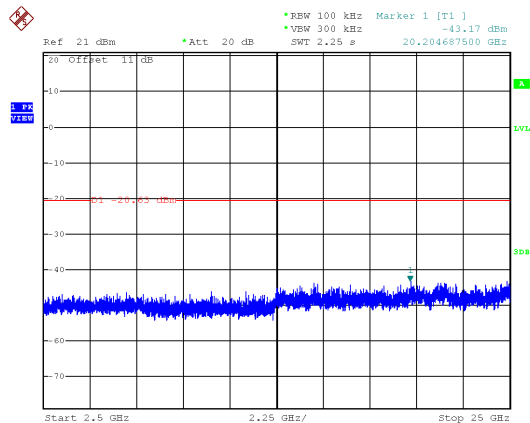
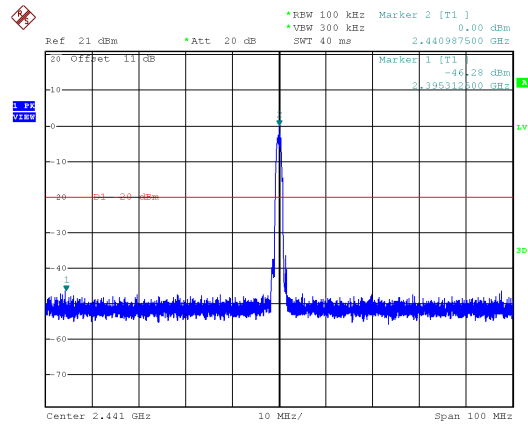
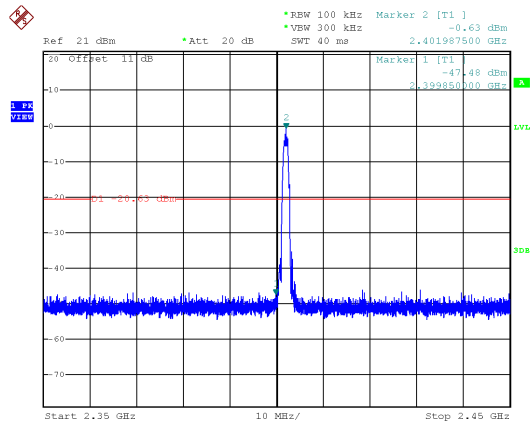
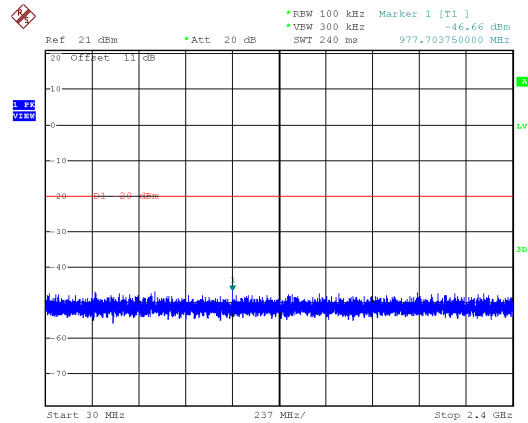



Modulation Type: 8DPSK, CH78

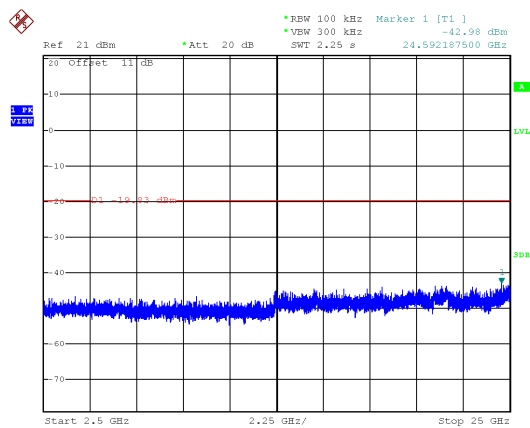
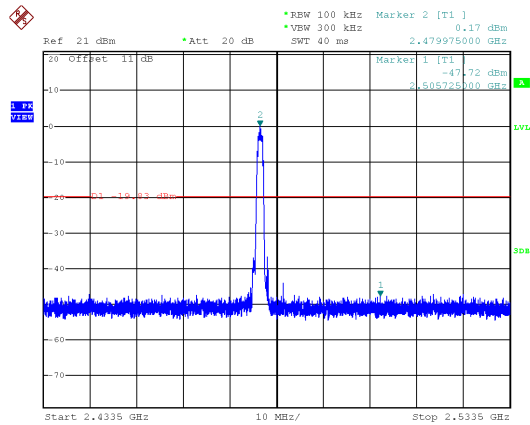
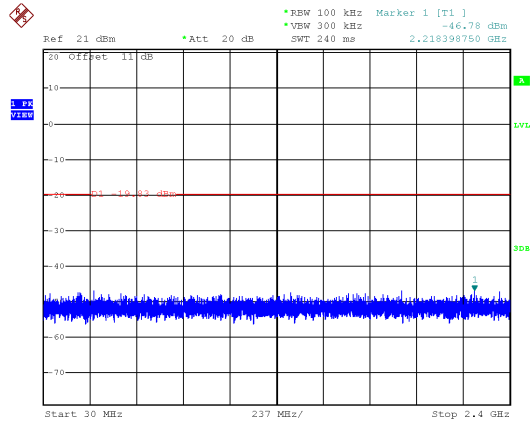



Hopping Mode:
Modulation Type: GFSK

Modulation Type: $\pi/4$ -DQPSK

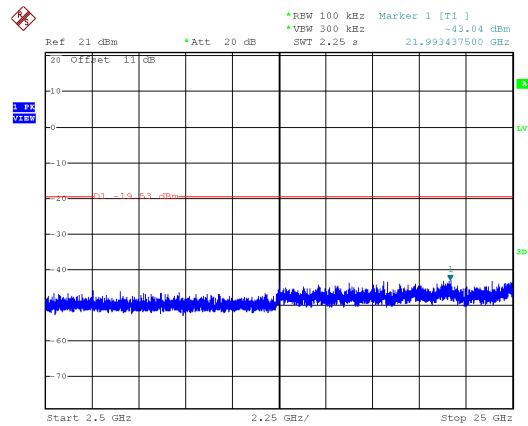
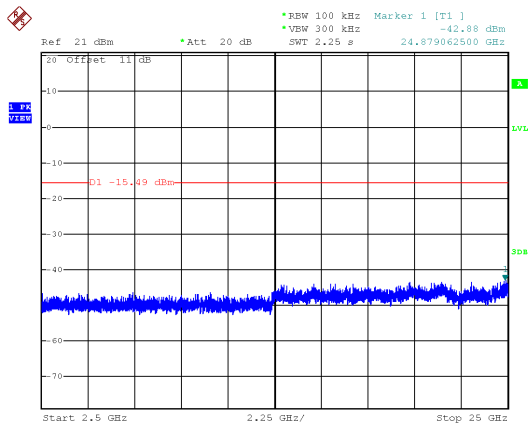
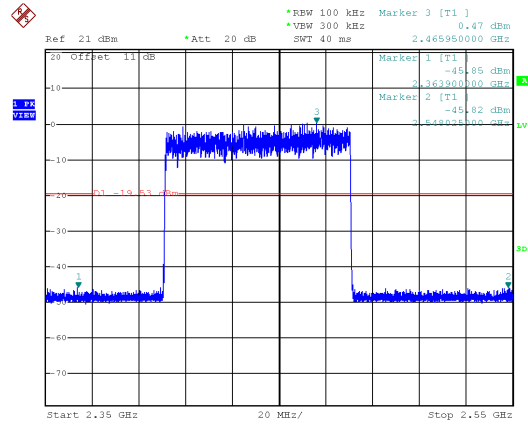
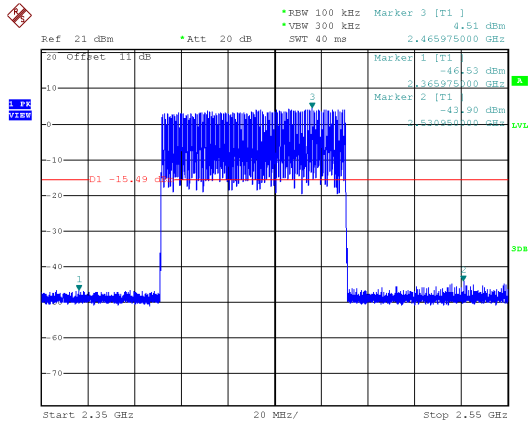
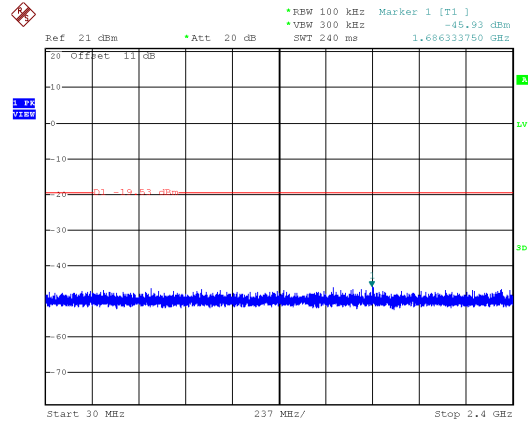
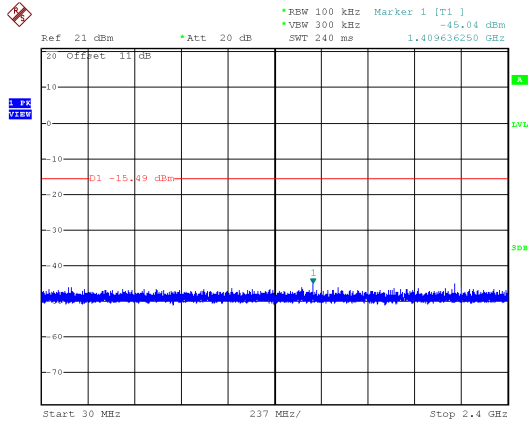



Modulation Type: 8DPSK

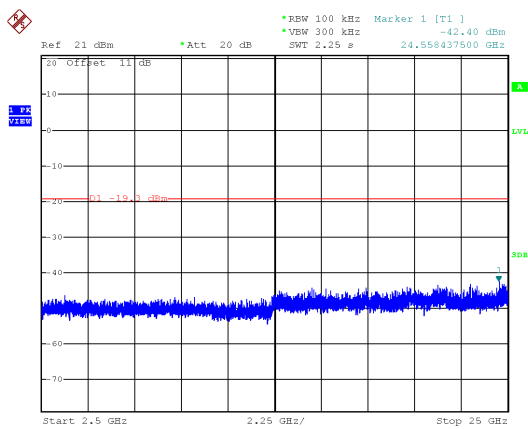
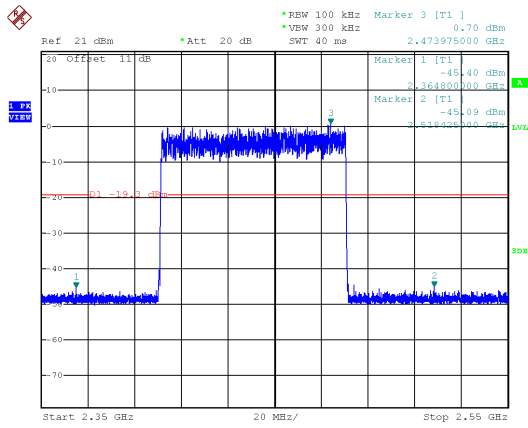
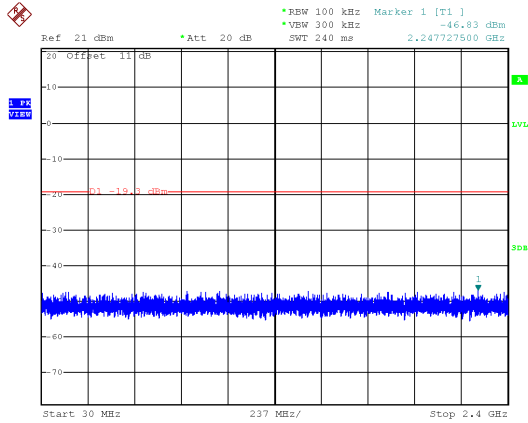



8. 20dB Bandwidth Measurement Data

8.1 Test Limit

Frequency hopping systems shall have hopping channel carrier frequencies separated by a minimum of 25 kHz or the 20 dB bandwidth of the hopping channel, whichever is greater. Alternatively, frequency hopping systems operating in the 2400–2483.5 MHz band may have hopping channel carrier frequencies that are separated by 25 kHz or two-thirds of the 20 dB bandwidth of the hopping channel, whichever is greater, provided the systems operate with an output power no greater than 125 mW.

8.2 Test Procedures

- a. The transmitter output was connected to the spectrum analyzer.
- b. Set RBW of spectrum analyzer to 30 KHz and VBW to 100 KHz.
- c. The 20 dB bandwidth is defined as the total spectrum the power of which is higher than peak power minus 20 dB.

8.3 Test Setup Layout

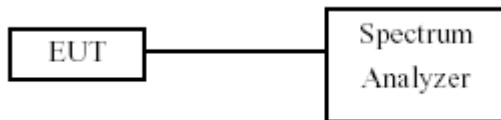

8.4 Test Result and Data

Modulation Type	Channel	Frequency (MHz)	20dB Bandwidth (MHz)	2/3 20dB Bandwidth (MHz)
GFSK	0	2402	0.970	0.647
	39	2441	0.960	0.640
	78	2480	0.960	0.640
$\pi/4$ -DQPSK	0	2402	1.460	0.973
	39	2441	1.450	0.967
	78	2480	1.460	0.973
8DPSK	0	2402	1.490	0.993
	39	2441	1.490	0.993
	78	2480	1.490	0.993



Modulation Type: GFSK
CH00

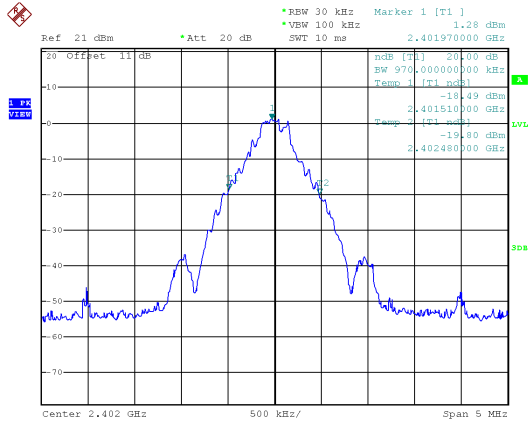

Modulation Type: $\pi/4$ -DQPSK
CH00

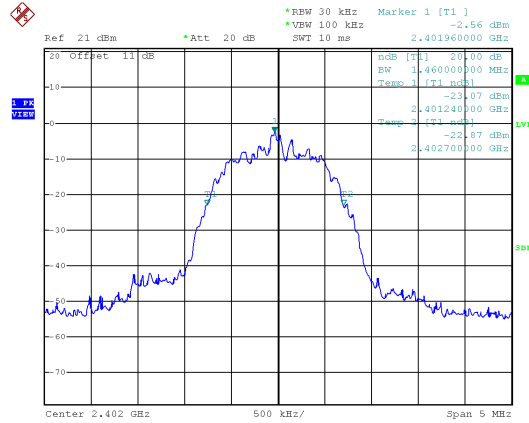

CH39

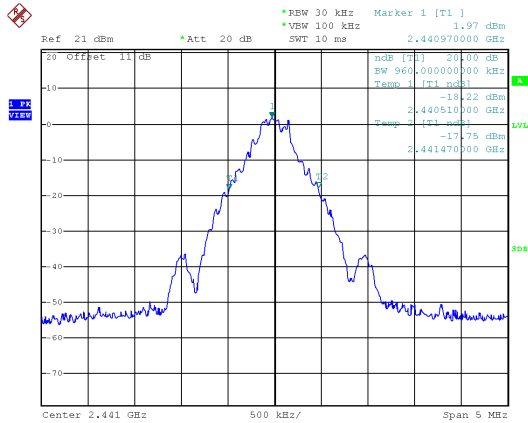

CH39

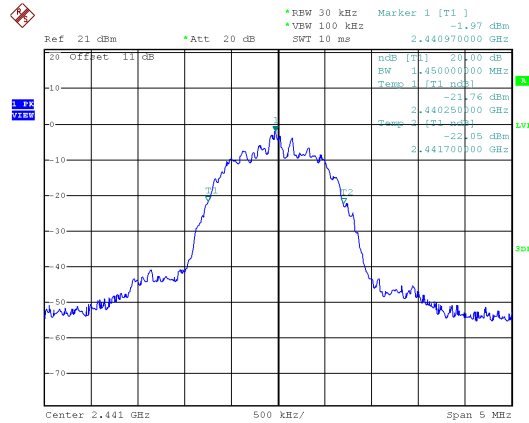

CH78

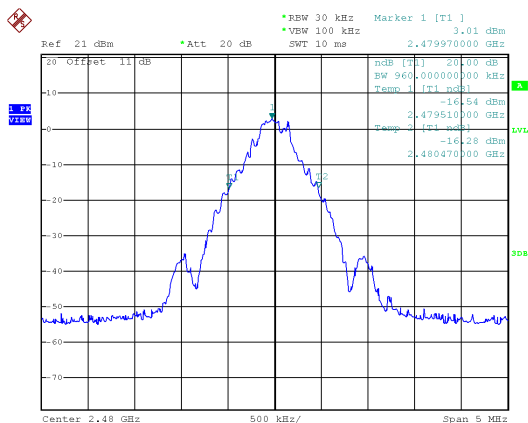

CH78

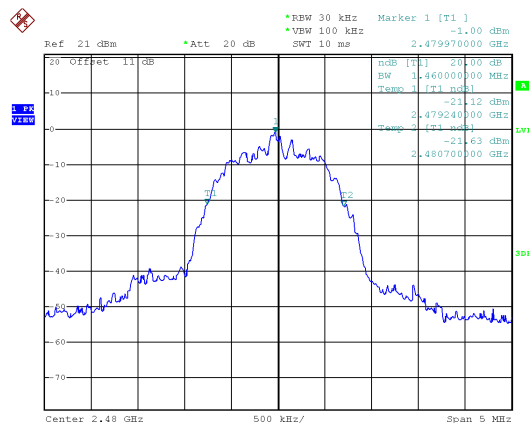



Modulation Type: 8DSPK
CH00

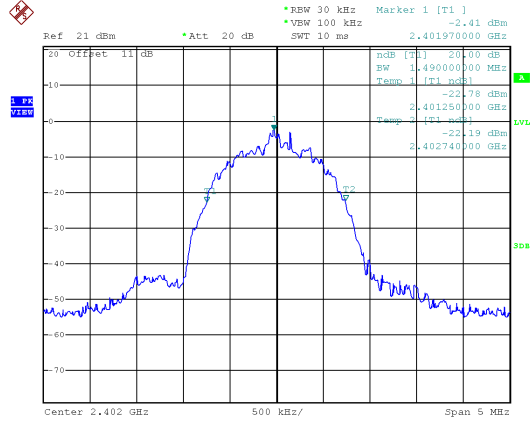

CH39

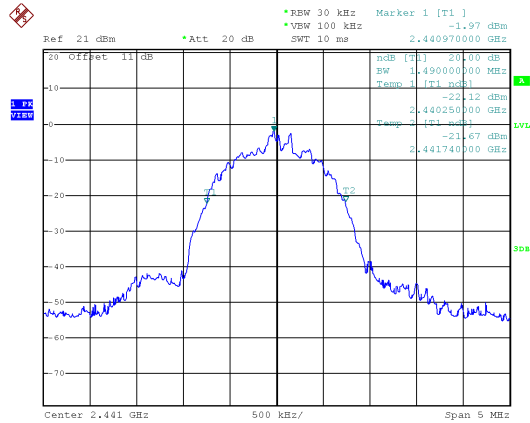

CH78

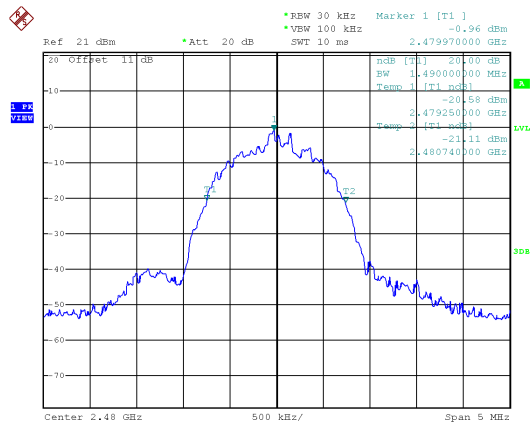





9. Frequencies Separation

9.1 Test Limit

Frequency hopping systems shall have hopping channel carrier frequencies separated by a minimum of 25 kHz or the 20 dB bandwidth of the hopping channel, whichever is greater.

9.2 Test Procedures

- a. The transmitter output was connected to the spectrum analyzer.
- b. Set RBW of spectrum analyzer to 30 KHz and VBW to 100 KHz.
- c. By using the MaxHold function record the separation of two adjacent channels.
- d. Measure the frequency difference of these two adjacent channels.

9.3 Test Setup Layout

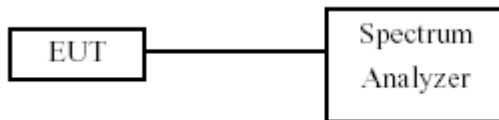

9.4 Test Result and Data

Modulation Type	Channel	Frequency (MHz)	Channel Separation (MHz)	Limit (MHz)
GFSK	00	2402	1.002	0.647
	39	2441	1.002	0.640
	78	2480	1.002	0.640
$\pi/4$ -DQPSK	00	2402	1.002	0.973
	39	2441	1.002	0.967
	78	2480	1.002	0.973
8DPSK	00	2402	1.002	0.993
	39	2441	1.002	0.993
	78	2480	1.002	0.993



Modulation Type: GFSK
CH00

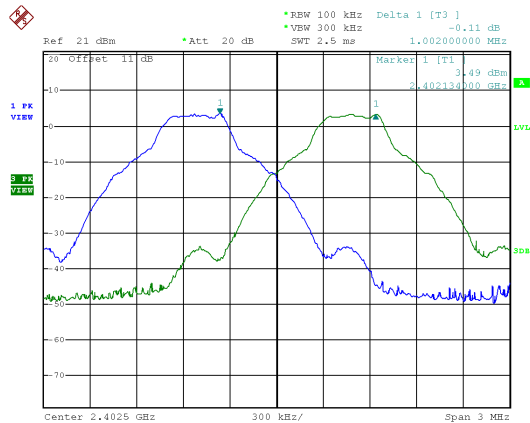

Modulation Type: $\pi/4$ -DQPSK
CH00

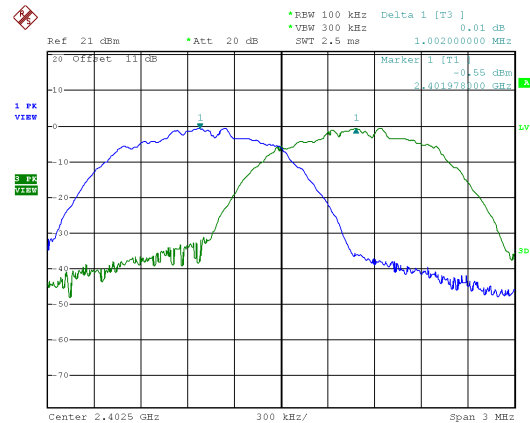

CH39

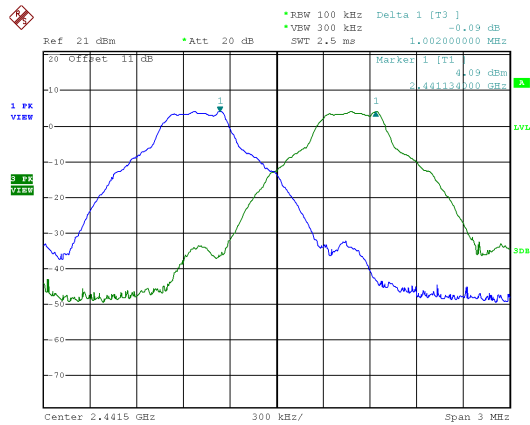

CH39

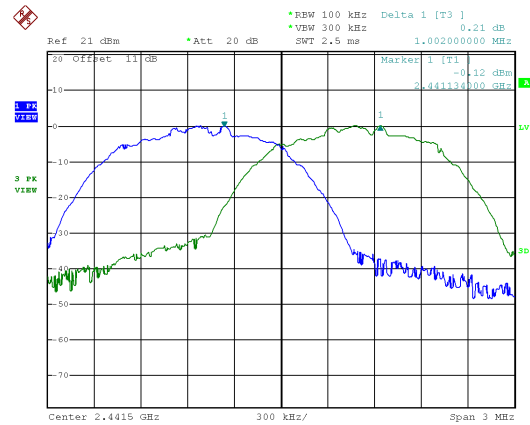

CH78

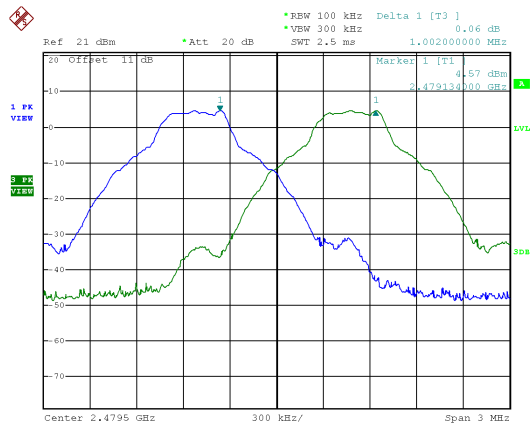

CH78

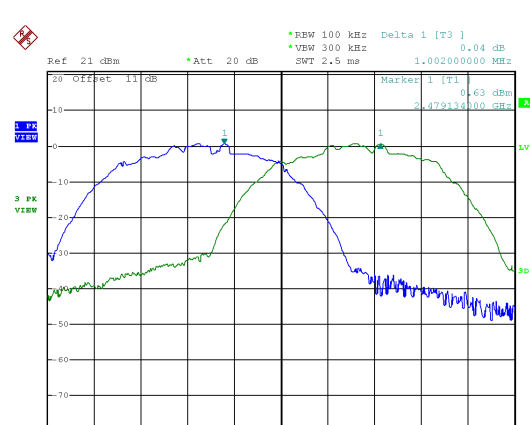



Modulation Type: 8DSPK
CH00

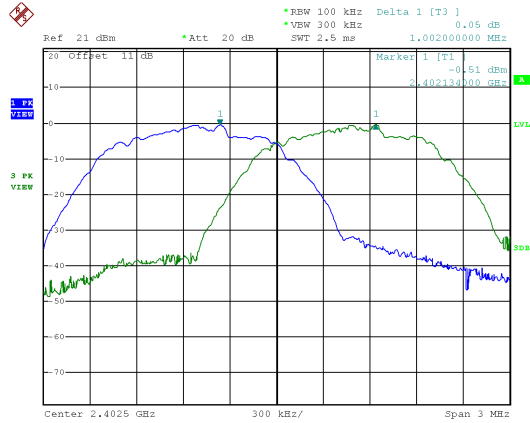

CH39

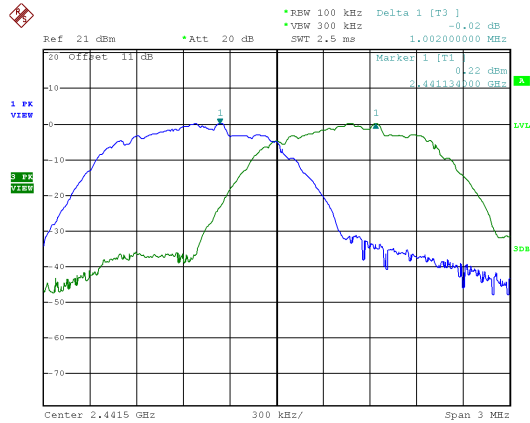

CH78

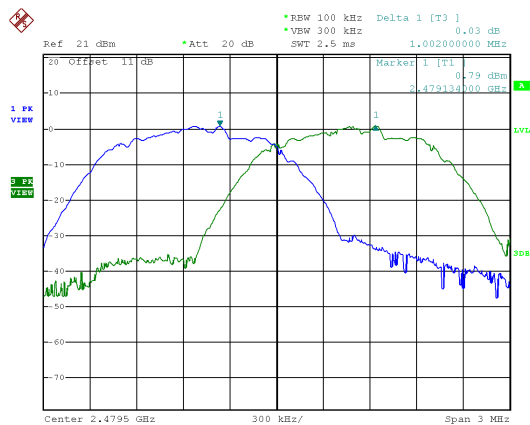





10. Dwell Time on each channel

10.1 Test Limit

The average time of occupancy on any channel shall not be greater than 0.4 seconds within a period of 0.4 seconds multiplied by the number of hopping channels employed.

10.2 Test Procedures

1. The transmitter output was connected to the spectrum analyzer.
2. Adjust the center frequency to measure frequency, then set zero span mode.
2. Set RBW of spectrum analyzer to 1 MHz and VBW to 1 MHz.
4. Measure the time duration of one transmission on the measured frequency.

10.3 Test Setup Layout

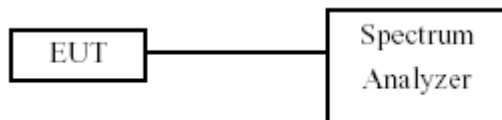

10.4 Test Result and Data

Modulation Type	Frequency (MHz)	Length of transmission time (ms)	Number of transmission in a 31.6 (79 Hopping*0.4)	Dwell Time (ms)	Limit (ms)
GFSK (DH1)	2402	0.410	320.10	131.24	400
GFSK (DH3)	2402	1.680	159.90	268.63	400
GFSK (DH5)	2402	2.920	106.81	311.89	400
$\pi/4$ -DQPSK (DH1)	2402	0.420	320.10	134.44	400
$\pi/4$ -DQPSK (DH3)	2402	1.680	159.90	268.63	400
$\pi/4$ -DQPSK (DH5)	2402	2.930	106.81	312.95	400
8DPSK (DH1)	2402	0.420	320.10	134.44	400
8DPSK (DH3)	2402	1.680	159.90	268.63	400
8DPSK (DH5)	2402	2.930	106.81	312.95	400

Test Period = 0.4 (second/ channel) x 20 Channel = 8 sec

Modulation Type	Frequency (MHz)	Length of transmission time (ms)	Number of transmission in a 8 (20 Hopping*0.4)	Dwell Time (ms)	Limit (ms)
AFH (DH1)	2402-2421	0.410	160.00	65.60	400
AFH (DH3)	2402-2421	1.680	80.00	134.40	400
AFH (DH5)	2402-2421	2.920	53.33	155.72	400



Modulation Type: GFSK(DH1)

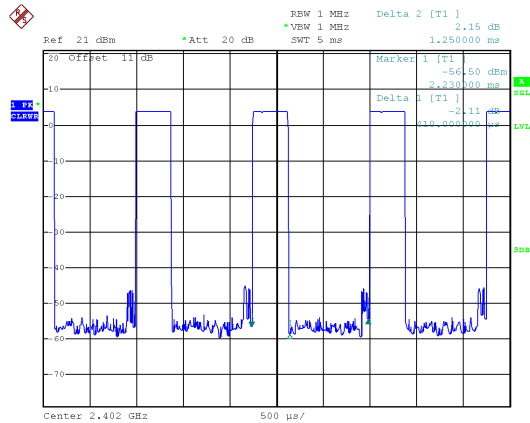

Modulation Type: $\pi/4$ -DQPSK (DH1)

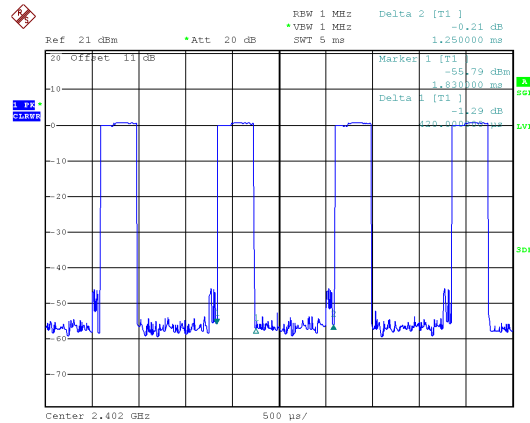

Modulation Type: GFSK(DH3)

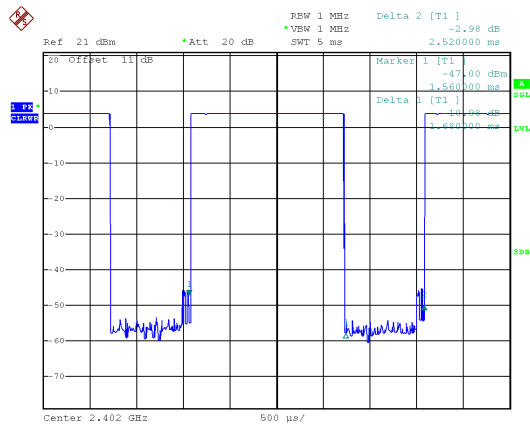

Modulation Type: $\pi/4$ -DQPSK (DH3)

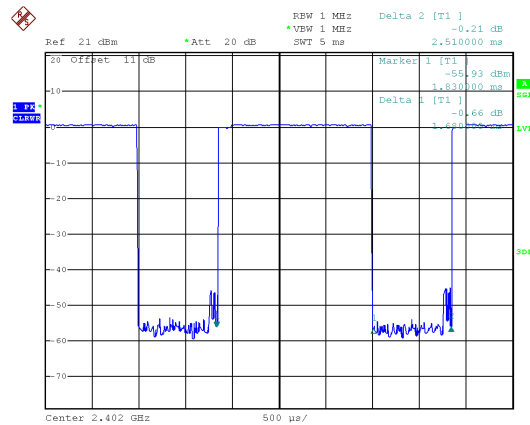

Modulation Type: GFSK(DH5)

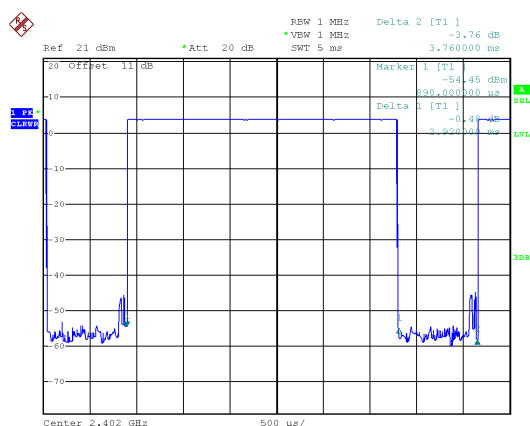

Modulation Type: $\pi/4$ -DQPSK (DH5)

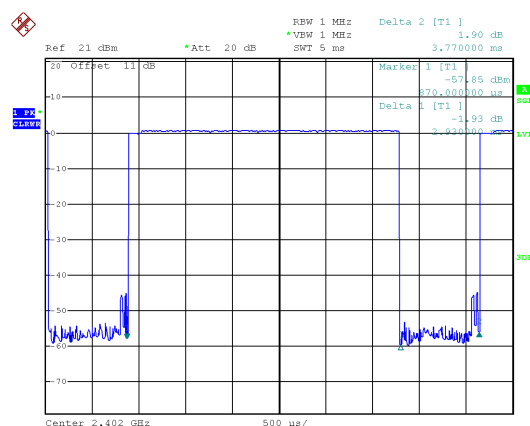



Modulation Type: 8DSPK (DH1)

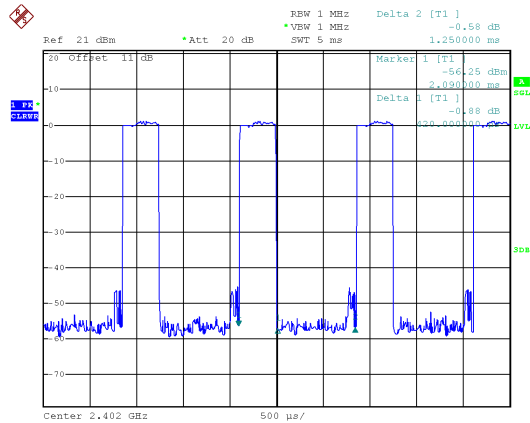

Modulation Type: AFH (DH1)

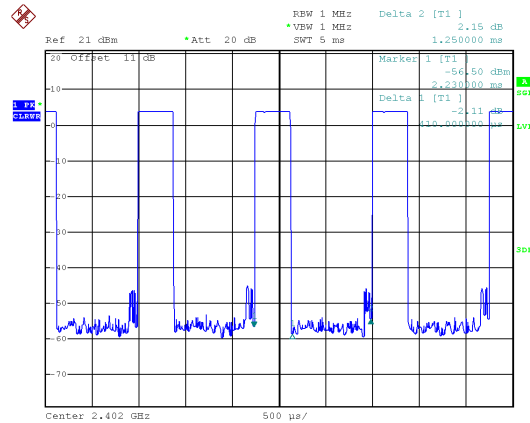

Modulation Type: 8DSPK (DH3)

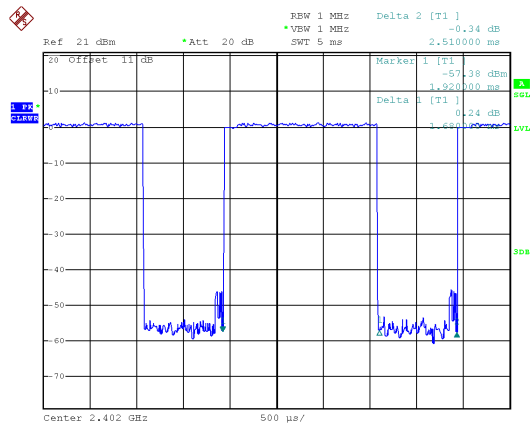

Modulation Type: AFH (DH3)

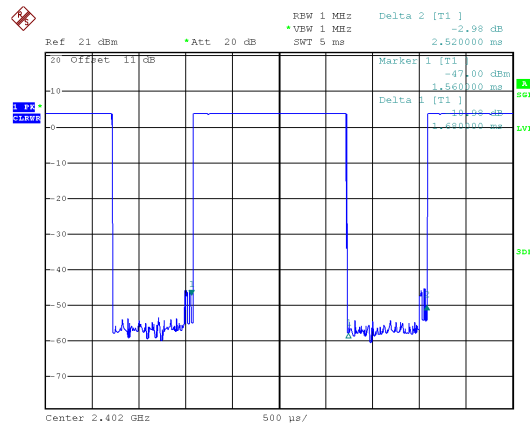

Modulation Type: 8DSPK (DH5)

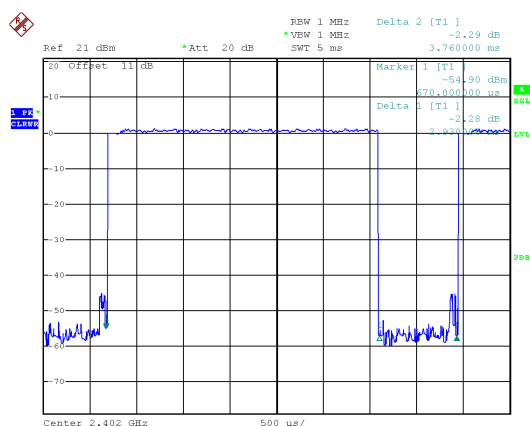

Modulation Type: AFH (DH5)

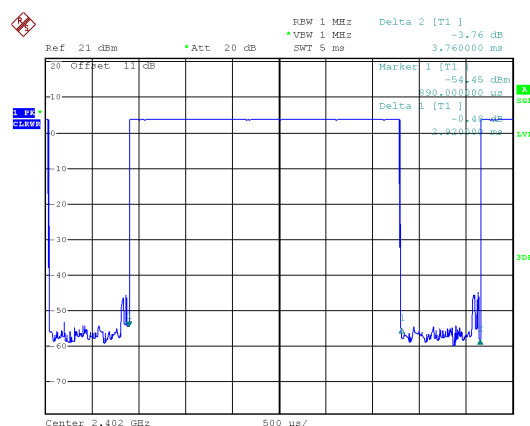





11. Number of Hopping Channels

11.1 Test Limit

Frequency hopping systems in the 2400 ~ 2483.5 MHz band shall use at least 15 channels.

11.2 Test Procedures

- a. The transmitter output was connected to the spectrum analyzer.
- b. 2. Set RBW of spectrum analyzer to 100 KHz and VBW to 100 KHz.
- c. 3. Set the MaxHold function, and then keep the EUT in hopping mode. Record all the signals from each channel until each one has been record.

11.3 Test Setup Layout

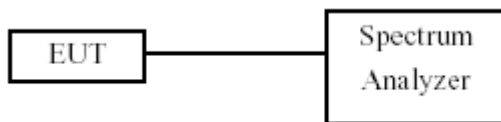

11.4 Test Result and Data

Modulation Type	Hopping Channels
GFSK	79
$\pi/4$ -DQPSK	79
8DPSK	79



Modulation Type: GFSK(DH5)

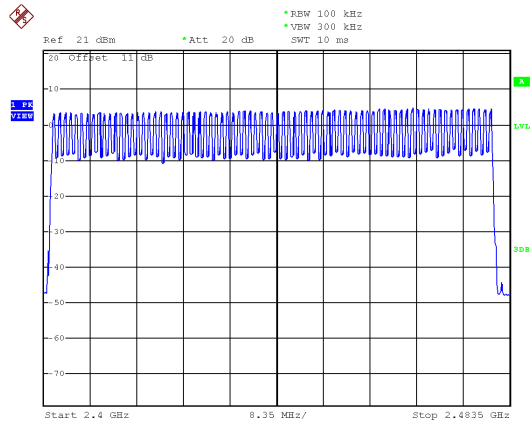

Modulation Type: $\pi/4$ -DQPSK (2DH5)

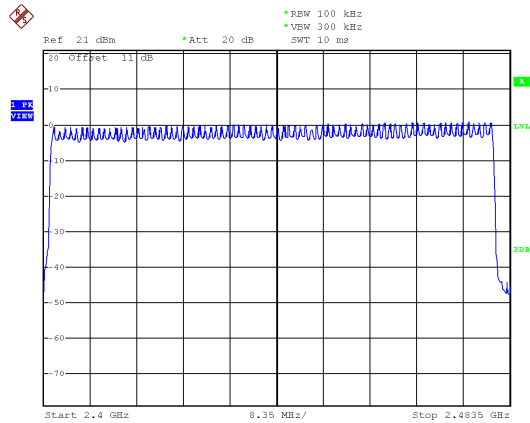

Modulation Type: 8DPSK(3DH5)

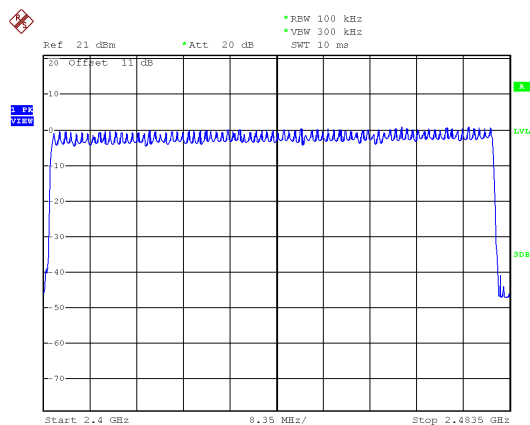



12. Maximum Peak Output Power

12.1 Test Limit

The Maximum Peak Output Power Measurement is 30dBm.

12.2 Test Procedures

The antenna port(RF output)of the EUT was connected to the input(RF input)of a power meter. Power was read directly from the meter and cable loss connection was added to the reading to obtain power at the EUT antenna terminal. The EUT Output Power was set to maximum to produce the worse case test result.

12.3 Test Setup Layout

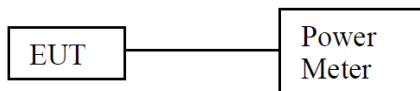



12.4 Test Result and Data

Modulation Type	Channel	Frequency (MHz)	Peak Output Power (dBm)	Peak Output Power (mW)
GFSK	00	2402	3.49	2.234
	39	2441	4.02	2.523
	78	2480	4.94	3.119
$\pi/4$ -DQPSK	00	2402	2.04	1.600
	39	2441	2.61	1.824
	78	2480	3.50	2.239
8DPSK	00	2402	2.16	1.644
	39	2441	2.72	1.871
	78	2480	3.66	2.323

Modulation Type	Channel	Frequency (MHz)	Average Output Power (dBm)	Average Output Power (mW)
GFSK	00	2402	3.34	2.158
	39	2441	3.91	2.460
	78	2480	4.81	3.027
$\pi/4$ -DQPSK	00	2402	-0.46	0.899
	39	2441	0.12	1.028
	78	2480	1.11	1.291
8DPSK	00	2402	-0.45	0.902
	39	2441	0.13	1.030
	78	2480	1.10	1.288

Note: Average power is for reference only.

AFH Mode:

Modulation Type	Channel	Frequency(MHz)	PK Output Power (dBm)	PK Output Power (mW)
GFSK	0-19	2402-2421	3.63	2.307
$\pi/4$ -DQPSK	0-19	2402-2421	2.23	1.671
8DPSK	0-19	2402-2421	2.47	1.766

Modulation Type	Channel	Frequency(MHz)	AV Output Power (dBm)	AV Output Power (mW)
GFSK	0-19	2402-2421	3.55	2.265
$\pi/4$ -DQPSK	0-19	2402-2421	-0.17	0.962
8DPSK	0-19	2402-2421	-0.22	0.951

Note: Average power is for reference only.