



# RF TEST REPORT

**Applicant** Gosuncn Technology Group Co.,Ltd.  
**FCC ID** 2APNR-GW631Q  
**Product** LTE CPE  
**Model** WF831, WF831+, WF831A, GW631  
**Report No.** R1805A0254-R2V1  
**Issue Date** June 6, 2018

TA Technology (Shanghai) Co., Ltd. tested the above equipment in accordance with the requirements in **FCC CFR47 Part 2 (2017)/ FCC CFR47 Part 27C (2017)**. The test results show that the equipment tested is capable of demonstrating compliance with the requirements as documented in this report.

*Jiang peng Lan*

*Performed by: Jiangpeng Lan*

*Kai Xu*

*Approved by: Kai Xu*

---

**TA Technology (Shanghai) Co., Ltd.**

No.145, Jintang Rd, Tangzhen Industry Park, Pudong Shanghai, China

TEL: +86-021-50791141/2/3

FAX: +86-021-50791141/2/3-8000

## Table of Contents

1	Test Laboratory.....	4
1.1	Notes of the Test Report.....	4
1.2	Test facility.....	4
1.3	Testing Location.....	5
2	General Description of Equipment under Test.....	6
3	Applied Standards.....	8
4	Test Configuration.....	9
5	Test Case Results.....	10
5.1	RF Power Output.....	10
5.2	Effective Isotropic Radiated Power.....	13
5.3	Occupied Bandwidth.....	17
5.4	Band Edge Compliance.....	23
5.5	Peak-to-Average Power Ratio (PAPR).....	31
5.6	Frequency Stability.....	33
5.7	Spurious Emissions at Antenna Terminals.....	36
5.8	Radiates Spurious Emission.....	42
6	Main Test Instruments.....	50
ANNEX A:	EUT Appearance and Test Setup.....	51
A.1	EUT Appearance.....	51
A.2	Test Setup.....	53

## Summary of Measurement Results

Number	Test Case	Clause in FCC rules	Verdict
1	RF power output	2.1046	PASS
2	Effective Isotropic Radiated power	27.50(d)(4)/27.50(h)(2)	PASS
3	Occupied Bandwidth	2.1049	PASS
4	Band Edge Compliance	2.1051 /27.53(h)	PASS
5	Peak-to-Average Power Ratio	27.50(d)/KDB971168 D01(5.7)	PASS
6	Frequency Stability	2.1055 / 27.54	PASS
7	Spurious Emissions at Antenna Terminals	2.1051 /27.53(h)	PASS
8	Radiates Spurious Emission	2.1053 /27.53(h)	PASS
Date of Testing: November 14, 2017~ November 24, 2017			
Note: PASS: The EUT complies with the essential requirements in the standard. FAIL: The EUT does not comply with the essential requirements in the standard.			

# 1 Test Laboratory

## 1.1 Notes of the Test Report

This report shall not be reproduced in full or partial, without the written approval of **TA technology (shanghai) co., Ltd.** The results documented in this report apply only to the tested sample, under the conditions and modes of operation as described herein. Measurement Uncertainties were not taken into account and are published for informational purposes only. This report is written to support regulatory compliance of the applicable standards stated above. This report must not be used by the client to claim product certification, approval, or endorsement by any government agencies.

## 1.2 Test facility

### **CNAS (accreditation number: L2264)**

TA Technology (Shanghai) Co., Ltd. has obtained the accreditation of China National Accreditation Service for Conformity Assessment (CNAS).

### **FCC (Designation number: CN1179, Test Firm Registration Number: 446626)**

TA Technology (Shanghai) Co., Ltd. has been listed on the US Federal Communications Commission list of test facilities recognized to perform electromagnetic emissions measurements.

### **IC (recognition number is 8510A)**

TA Technology (Shanghai) Co., Ltd. has been listed by industry Canada to perform electromagnetic emission measurement.

### **VCCI (recognition number is C-4595, T-2154, R-4113, G-10766)**

TA Technology (Shanghai) Co., Ltd. has been listed by industry Japan to perform electromagnetic emission measurement.

### **A2LA (Certificate Number: 3857.01)**

TA Technology (Shanghai) Co., Ltd. has been listed by American Association for Laboratory Accreditation to perform electromagnetic emission measurement.

### 1.3 Testing Location

Company: TA Technology (Shanghai) Co., Ltd.  
Address: No.145, Jintang Rd, Tangzhen Industry Park, Pudong Shanghai, China  
City: Shanghai  
Post code: 201201  
Country: P. R. China  
Contact: Xu Kai  
Telephone: +86-021-50791141/2/3  
Fax: +86-021-50791141/2/3-8000  
Website: <http://www.ta-shanghai.com>  
E-mail: [xukai@ta-shanghai.com](mailto:xukai@ta-shanghai.com)

## 2 General Description of Equipment under Test

### Client Information

<b>Applicant</b>	Gosuncn Technology Group Co.,Ltd.
<b>Applicant address</b>	6F, 2819 KaiChuang Blvd., Science Town, Huangpu District, Guangzhou City, Guangdong, China
<b>Manufacturer</b>	Gosuncn Technology Group Co.,Ltd.
<b>Manufacturer address</b>	6F, 2819 KaiChuang Blvd., Science Town, Huangpu District, Guangzhou City, Guangdong, China

### General information

EUT Description			
Model	WF831, WF831+, WF831A, GW631		
IMEI	8942017450400020		
Hardware Version	V1.0		
Software Version	ENTEL_PER_WF831_V1.0.0B02		
Power Supply	AC adapter		
Antenna Type	Embeded Antenna		
Test Mode(s)	LTE Band 4		
Test Modulation	QPSK 16QAM;		
LTE Release	R9		
Maximum E.I.R.P./ E.R.P.	LTE Band 4:	26.00dBm	
Rated Power Supply Voltage:	12V		
Extreme Voltage	Minimum: 9V    Maximum: 13V		
Extreme Temperature	Lowest: -10°C    Highest: +45°C		
Operating Frequency Range(s)	Mode	Tx (MHz)	Rx (MHz)
	LTE Band 4	1710 ~ 1755	2110 ~ 2155
EUT Accessory			
Adapter	Manufacturer:AQUILSTAR PRECISION INDUSTRIAL (SHENZHEN)CO., LTD Model: ASSA65A-120100		
Network cable	Manufacturer: SHANGHAI JINGTU ELECTRONICS LTD. Model: UTP CAT5E		
Note: 1. The information of the EUT is declared by the manufacturer.			

<b>Item</b>	<b>WF831</b>	<b>WF831+</b>	<b>WF831A</b>	<b>GW631</b>
Protocol Stack	The same	The same	The same	The same
MMS/STK	The same	The same	The same	The same
JAVA	The same	The same	The same	The same
Web User Interface page	The same	changes	changes	changes
HARDWARE	The same	The same	The same	The same
MECHANICAL	The same	The same	The same	The same
ACCESSORY	The same	The same	The same	The same
<p>Note: Customer declaration, four models are the same, except for the logo and default parameters in the Web User Interface page, which will not affect the RF characteristic according to Part 2.1043 requirement. This report tested WF831.</p>				

### 3 Applied Standards

According to the specifications of the manufacturer, it must comply with the requirements of the following standards:

#### Test standards

**FCC CFR47 Part 2 (2017)**

**FCC CFR47 Part 27C (2017)**

**ANSI/TIA-603-D (2010)**

**KDB 971168 D01 Power Meas License Digital Systems v03**



## 4 Test Configuration

Radiated measurements are performed by rotating the EUT in three different orthogonal test planes. EUT stand-up position (Z axis), lie-down position (X, Y axis). Receiver antenna polarization (horizontal and vertical), the worst emission was found in position (Z axis, horizontal polarization) and the worst case was recorded.

All mode and data rates and positions and RB size and modulations were investigated.

Subsequently, only the worst case emissions are reported.

The following testing in LTE is set based on the maximum RF Output Power.

The following testing in different Bandwidth is set to detail in the following table:

Test modes are chosen to be reported as the worst case configuration below for LTE Band 4:

Test items	Bandwidth (MHz)				Modulation		RB			Test Channel		
	5	10	15	20	QPSK	16QAM	1	50%	100%	L	M	H
RF power output	O	O	O	O	O	O	O	O	O	O	O	O
Effective Isotropic Radiated power	O	O	O	O	O	O	-	-	O	O	O	O
Occupied Bandwidth	O	O	O	O	O	O	-	-	O	O	O	O
Band Edge Compliance	O	O	O	O	O	O	O	-	O	O	-	O
Peak-to-Average Power Ratio	O	O	O	O	O	O	-	-	O	O	O	O
Frequency Stability	O	O	O	O	O	O	-	-	O	-	O	-
Spurious Emissions at Antenna Terminals	O	O	O	O	O	-	O	-	-	O	O	O
Radiates Spurious Emission	O	O	O	O	O	-	O	-	-	O	O	O
Note	1. The mark "O" means that this configuration is chosen for testing. 2. The mark "-" means that this configuration is not testing.											

## 5 Test Case Results

### 5.1 RF Power Output

#### Ambient condition

Temperature	Relative humidity	Pressure
23°C ~25°C	45%~50%	101.5kPa

#### Methods of Measurement

During the process of the testing, The EUT is controlled by the Base Station Simulator to ensure max power transmission and proper modulation.

#### Test Setup

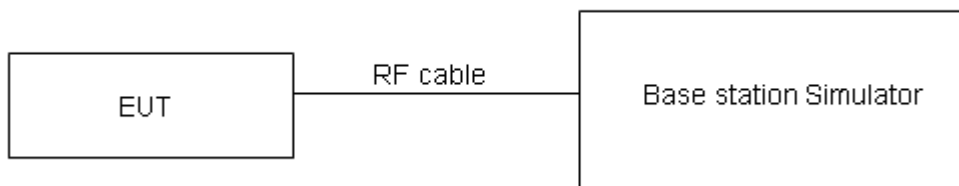

The loss between RF output port of the EUT and the input port of the tester has been taken into consideration.

#### Limits

No specific RF power output requirements in part 2.1046.

#### Measurement Uncertainty

The assessed measurement uncertainty to ensure 95% confidence level for the normal distribution is with the coverage factor  $k = 2$ ,  $U=0.4$  dB.

**Test Results**

LTE Band 4				AV Conducted Power(dBm)		
Bandwidth	Modulation	RB size	RB offset	Channel/Frequency (MHz)		
				19975/1712.5	20175/1732.5	20375/1752.5
5MHz	QPSK	1	0	22.11	22.18	23.31
		1	13	22.18	21.82	23.34
		1	24	22.35	22.06	22.68
		12	0	21.45	21.42	22.55
		12	6	21.39	20.94	22.26
		12	13	21.28	20.83	22.08
		25	0	21.24	20.96	22.35
	16QAM	1	0	21.12	21.48	22.39
		1	13	21.13	21.21	22.57
		1	24	21.34	21.33	22.00
		12	0	20.42	20.38	21.39
		12	6	20.51	20.02	21.52
		12	13	20.31	19.96	21.15
		25	0	20.28	20.15	21.53
Bandwidth	Modulation	RB size	RB offset	Channel/Frequency (MHz)		
				20000/1715	20175/1732.5	20350/1750
10MHz	QPSK	1	0	22.42	22.61	23.13
		1	25	22.48	22.03	23.56
		1	49	22.87	22.18	23.03
		25	0	21.57	21.32	22.36
		25	13	21.81	21.31	22.09
		25	25	21.79	21.15	22.35
		50	0	21.73	21.32	22.47
	16QAM	1	0	21.67	21.88	23.01
		1	25	21.86	21.13	23.14
		1	49	22.25	21.34	22.87
		25	0	20.65	20.51	21.41
		25	13	20.79	20.42	21.81
		25	25	21.05	20.32	21.53
		50	0	20.79	20.34	21.73
Bandwidth	Modulation	RB size	RB offset	Channel/Frequency (MHz)		
				20025/1717.5	20175/1732.5	20325/1747.5
15MHz	QPSK	1	0	22.45	22.65	23.16
		1	38	22.49	22.07	23.58
		1	74	22.89	22.19	23.06
		36	0	21.60	21.37	22.40
		36	18	21.83	21.35	22.12
		36	39	21.82	21.20	22.39
		75	0	21.76	21.37	22.51



Bandwidth	Modulation	RB size	RB offset	Channel/Frequency (MHz)		
				20050/1720	20175/1732.5	20300/1745
	16QAM	1	0	21.69	21.92	23.06
		1	38	21.90	21.15	23.18
		1	74	22.27	21.37	22.89
		36	0	20.68	20.55	21.44
		36	18	20.82	20.44	21.84
		36	39	21.08	20.37	21.57
		75	0	20.81	20.38	21.76
20MHz	QPSK	1	0	22.63	23.06	22.28
		1	50	23.21	22.10	23.13
		1	99	22.77	22.98	23.41
		50	0	21.89	21.89	21.77
		50	25	21.95	21.56	21.85
		50	50	21.98	21.35	22.79
		100	0	22.05	21.61	22.23
	16QAM	1	0	21.89	22.73	21.66
		1	50	22.52	21.82	22.45
		1	99	22.01	22.53	22.83
		50	0	21.07	20.85	20.66
		50	25	21.09	20.78	21.76
		50	50	21.14	20.41	21.91
		100	0	21.13	20.74	21.34
Note:1) The following testing in worst case based on the maximum RF Output Power.						

## 5.2 Effective Isotropic Radiated Power

### Ambient condition

Temperature	Relative humidity	Pressure
23°C ~25°C	45%~50%	101.5kPa

### Methods of Measurement

1. The testing follows FCC KDB 971168 v03 Section 5.8 and ANSI/TIA-603-D-2010.

- a) Connect the equipment as illustrated. Mount the equipment with the manufacturer specified antenna in a vertical orientation on a manufacturer specified mounting surface located on a non-conducting rotating platform of a RF anechoic chamber (preferred) or a standard radiation site.
- b) Key the transmitter, then rotate the EUT 360° azimuthally and record spectrum analyzer power level (LVL) measurements at angular increments that are sufficiently small to permit resolution of all peaks. If a standard radiation test site is used, raise and lower the test antenna to obtain a maximum reading at each angular increment. (Note: several batteries may be needed to offset the effect of battery voltage droop, which should not exceed 5% of the manufactured specified battery voltage during transmission).
- c) Replace the transmitter under test with a vertically polarized half-wave dipole (or an antenna whose gain is known relative to an ideal half-wave dipole). The center of the antenna should be at the same location as the center of the antenna under test.
- d) Connect the antenna to a signal generator with a known output power and record the path loss (in dB) as LOSS. If a standard radiation test site is used, raise and lower the test antenna to obtain a maximum reading.  $LOSS = \text{Generator Output Power (dBm)} - \text{Analyzer reading (dBm)}$
- e) Determine the effective radiated output power at each angular position from the readings in steps b) and d) using the following equation:  $ERP \text{ (dBm)} = LVL \text{ (dBm)} + LOSS \text{ (dB)}$
- f) The maximum ERP is the maximum value determined in the preceding step.
- g) When calculating ERP, in addition to knowing the antenna radiation and matching characteristics, it is necessary to know the loss values of all elements (e.g. transmission line attenuation, mismatches, filters, combiners) interposed between the point where transmitter output power is measured, and the point where power is applied to the antenna. ERP can then be calculated as follows:

$$ERP \text{ (dBm)} = \text{Output Power (dBm)} - \text{Losses (dB)} + \text{Antenna Gain (dBd)}$$

where: dBd refers to gain relative to an ideal dipole.

$$EIRP \text{ (dBm)} = ERP \text{ (dBm)} + 2.15 \text{ (dB.)}$$

**Test setup**

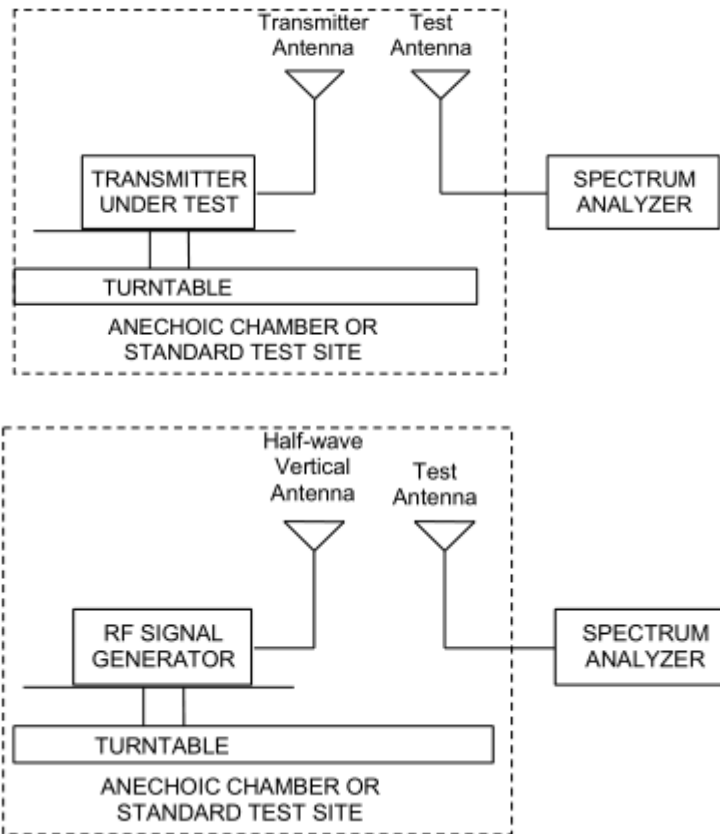

Note: Area side:2.4mX3.6m

The radiated emission was measured in the following position: EUT stand-up position (Z axis), lie-down position (X, Y axis). The worst emission was found in stand-up position (Z axis) and the worst case was recorded.

**Limits**

Rule Part 27.50(d) (4) specifies that “Fixed, mobile and portable (hand-held) stations operating in the 1710–1755 MHz band are limited to 1 watt EIRP”

Part 27.50(d)(4)Limit (EIRP)	$\leq 1 \text{ W}$ (30 dBm)
------------------------------	-----------------------------

**Measurement Uncertainty**

The assessed measurement uncertainty to ensure 95% confidence level for the normal distribution is with the coverage factor  $k = 2$ ,  $U = 1.19 \text{ dB}$

**Test Results**

The measurement is performed for both of horizontal and vertical antenna Polarization, and only the data of worst mode is recorded in this report.

LTE Band 4									
Bandwidth	Channel	Frequency (MHz)	Polarization	Output Power (dBm)	Losses (dB)	Antenna Gain (dBd)	EIRP (dBm)	Limit (dBm)	Conclusion
5 MHz (QPSK)	Low	1712.5	Horizontal	-31.27	-54.34	1.44	24.51	30	Pass
	Mid	1732.5	Horizontal	-32.82	-54.32	1.57	23.07	30	Pass
	High	1752.5	Horizontal	-31.26	-54.13	1.72	24.59	30	Pass
10 MHz (QPSK)	Low	1715	Horizontal	-30.80	-54.32	1.44	24.96	30	Pass
	Mid	1732.5	Horizontal	-32.80	-54.41	1.57	23.17	30	Pass
	High	1750	Horizontal	-30.18	-54.52	1.66	26.00	30	Pass
15 MHz (QPSK)	Low	1717.5	Horizontal	-30.63	-54.35	1.49	25.21	30	Pass
	Mid	1732.5	Horizontal	-32.57	-54.32	1.57	23.31	30	Pass
	High	1747.5	Horizontal	-30.04	-54.17	1.66	25.79	30	Pass
20 MHz (QPSK)	Low	1720	Horizontal	-30.50	-54.44	1.49	25.42	30	Pass
	Mid	1732.5	Horizontal	-32.24	-54.41	1.57	23.74	30	Pass
	High	1745	Horizontal	-31.66	-54.59	1.63	24.57	30	Pass
5 MHz (16QAM)	Low	1712.5	Horizontal	-31.38	-54.34	1.44	24.40	30	Pass
	Mid	1732.5	Horizontal	-32.93	-54.32	1.57	22.95	30	Pass
	High	1752.5	Horizontal	-31.37	-54.13	1.72	24.47	30	Pass
10 MHz (16QAM)	Low	1715	Horizontal	-30.93	-54.32	1.44	24.84	30	Pass
	Mid	1732.5	Horizontal	-32.92	-54.41	1.57	23.05	30	Pass
	High	1750	Horizontal	-30.30	-54.52	1.66	25.88	30	Pass
15 MHz (16QAM)	Low	1717.5	Horizontal	-30.75	-54.35	1.49	25.09	30	Pass
	Mid	1732.5	Horizontal	-32.69	-54.32	1.57	23.19	30	Pass
	High	1747.5	Horizontal	-30.16	-54.17	1.66	25.67	30	Pass
20 MHz (16QAM)	Low	1720	Horizontal	-30.62	-54.44	1.49	25.30	30	Pass
	Mid	1732.5	Horizontal	-32.36	-54.41	1.57	23.62	30	Pass
	High	1745	Horizontal	-31.78	-54.59	1.63	24.44	30	Pass



### 5.3 Occupied Bandwidth

#### Ambient condition

Temperature	Relative humidity	Pressure
23°C ~25°C	45%~50%	101.5kPa

#### Method of Measurement

The EUT was connected to Spectrum Analyzer and Base Station Simulator via power Splitter. The occupied bandwidth is measured using spectrum analyzer.

RBW is set to 100 kHz, VBW is set to 300 kHz for LTE Band 4 (5MHz).

RBW is set to 300 kHz, VBW is set to 1MHz for LTE Band 4 (10MHz/15MHz/20MHz).

99% power and -26dBc occupied bandwidths are recorded. Spectrum analyzer plots are included on the following pages.

#### Test Setup

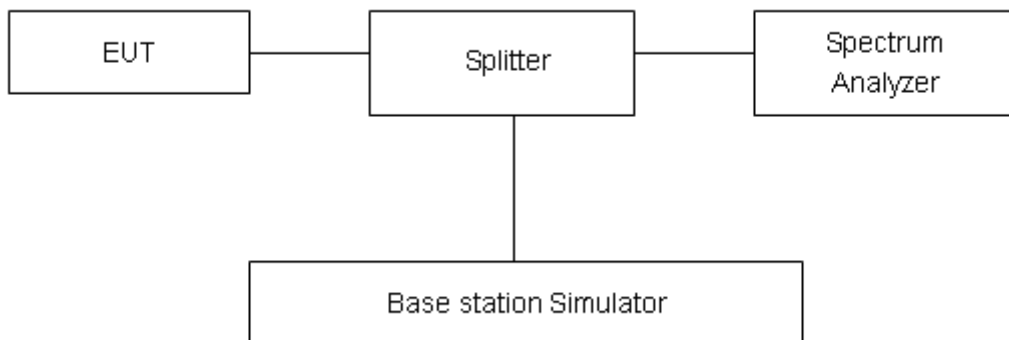

#### Limits

No specific occupied bandwidth requirements in part 2.1049.

#### Measurement Uncertainty

The assessed measurement uncertainty to ensure 95% confidence level for the normal distribution is with the coverage factor  $k = 2$ ,  $U=624\text{Hz}$ .

**Test Result**

LTE Band 4						
RB	Modulation	Bandwidth (MHz)	Channel	Frequency (MHz)	99% Power Bandwidth(MHz)	-26dBc Bandwidth(MHz)
100%	QPSK	5	19975	1712.5	4.5381	5.340
			20175	1732.5	4.5598	5.392
			20375	1752.5	4.5400	5.370
		10	20000	1715	9.0426	10.25
			20175	1732.5	9.0837	10.31
			20350	1750	9.0538	10.23
		15	20025	1717.5	13.432	14.71
			20175	1732.5	13.543	14.80
			20325	1747.5	13.415	14.69
		20	20050	1720	17.946	19.22
			20175	1732.5	17.955	19.17
			20300	1745	17.785	19.11
	16QAM	5	19975	1712.5	4.5676	5.392
			20175	1732.5	4.5463	5.363
			20375	1752.5	4.5724	5.443
		10	20000	1715	9.0474	10.20
			20175	1732.5	9.0841	10.23
			20350	1750	9.0553	10.18
		15	20025	1717.5	13.483	14.75
			20175	1732.5	13.545	14.75
			20325	1747.5	13.418	14.73
		20	20050	1720	17.931	19.35
			20175	1732.5	17.972	19.24
			20300	1745	17.745	19.01

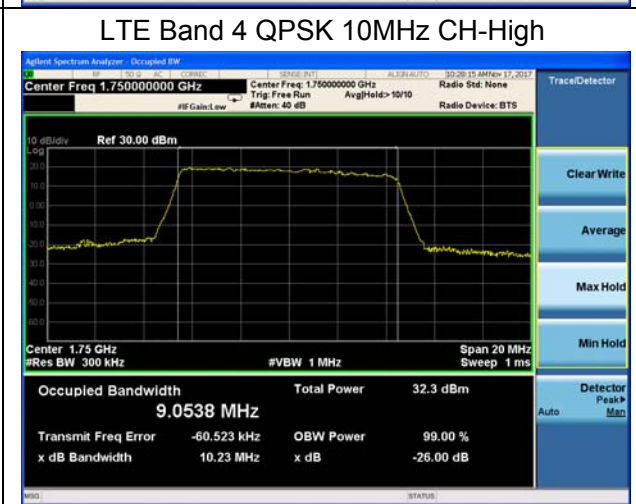
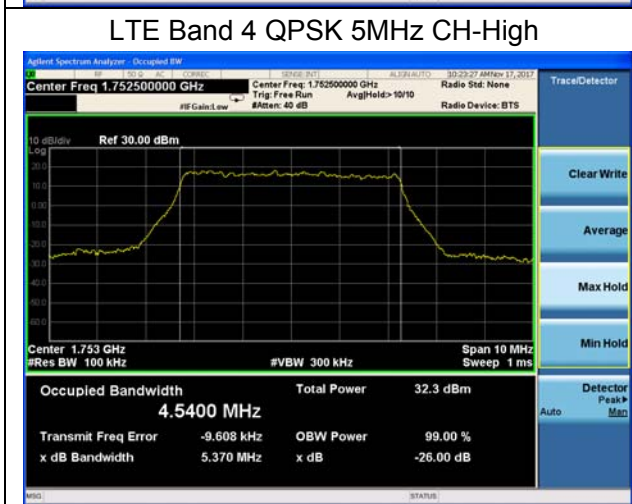
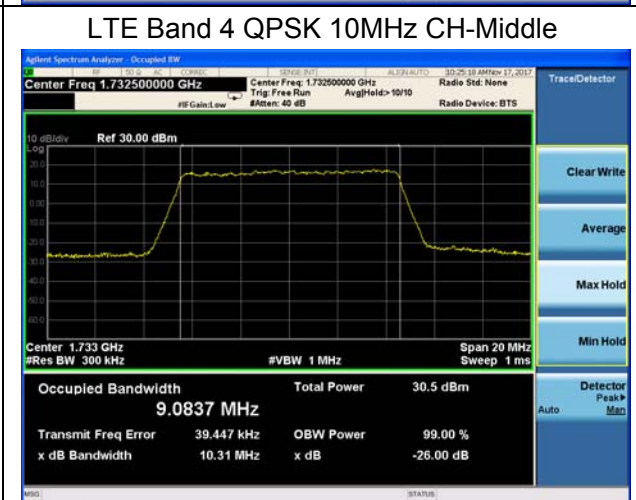
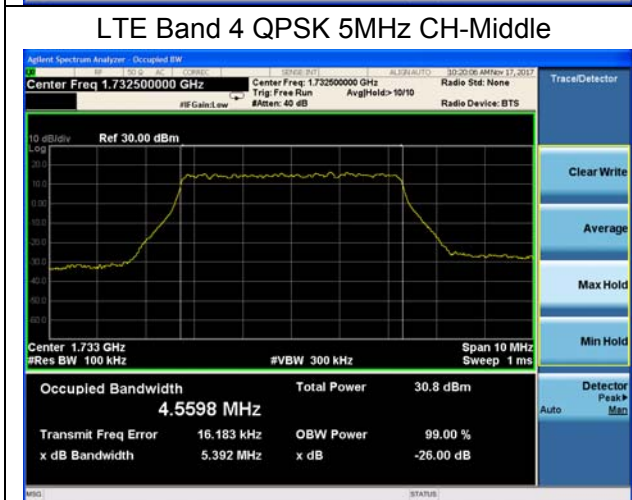
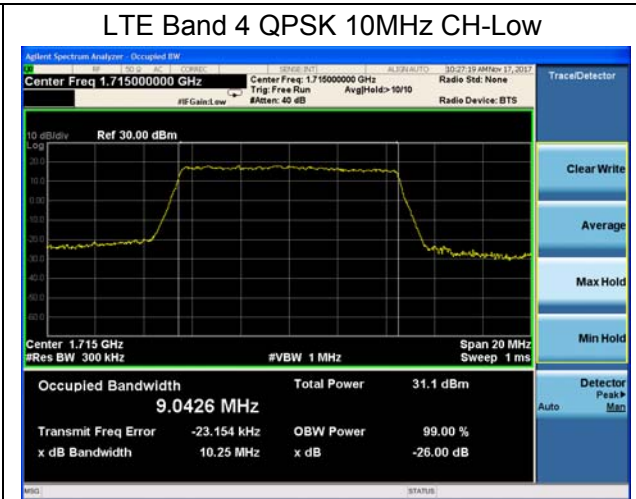
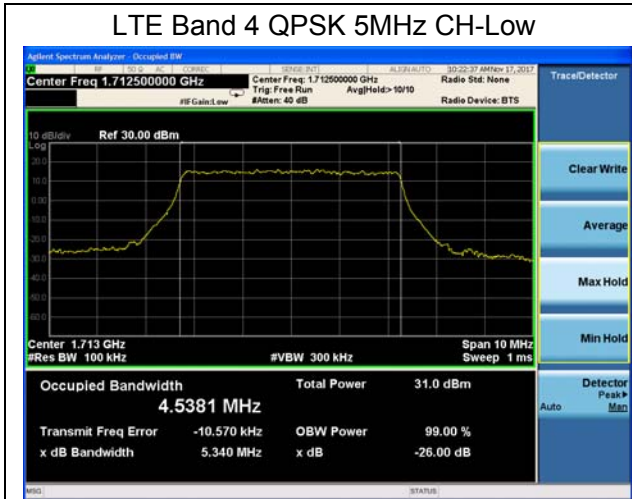

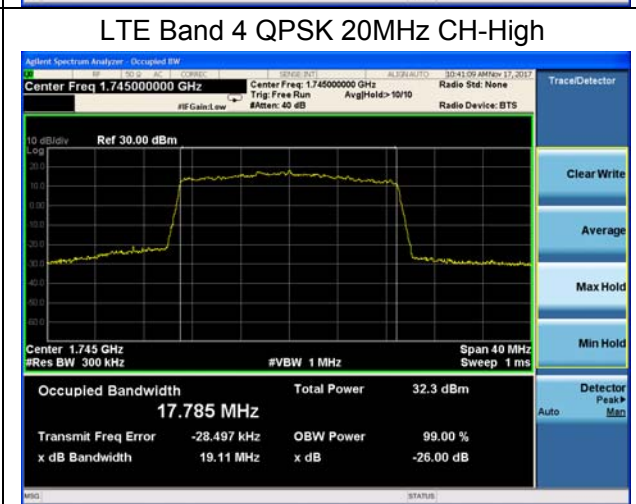
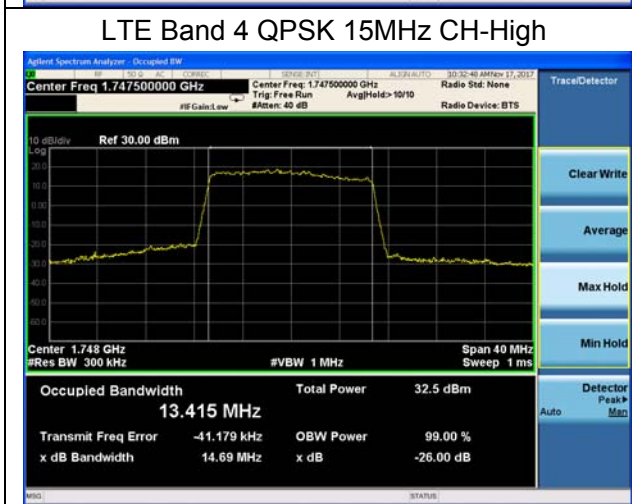
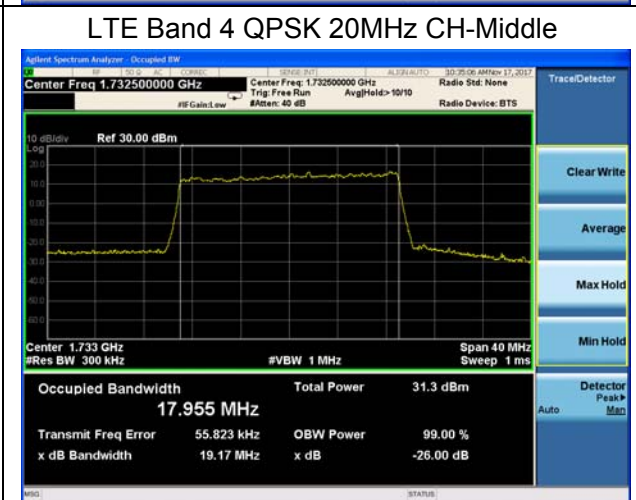
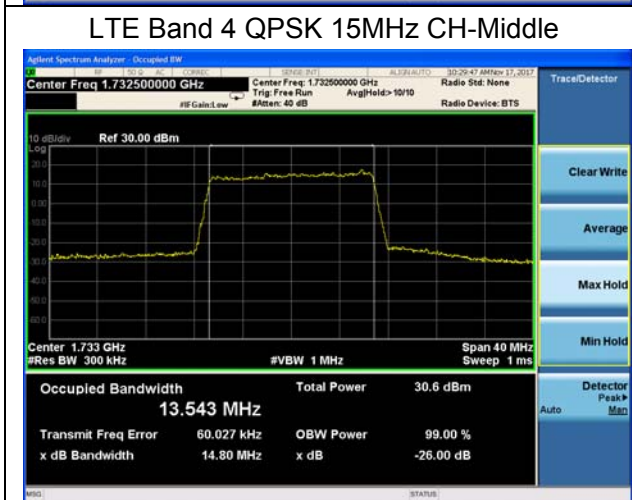
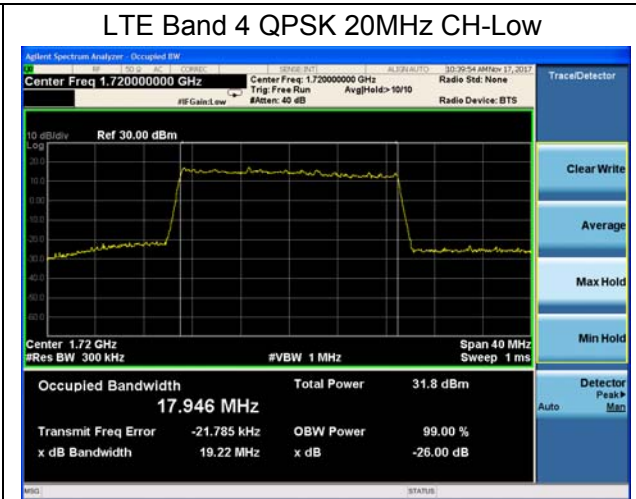
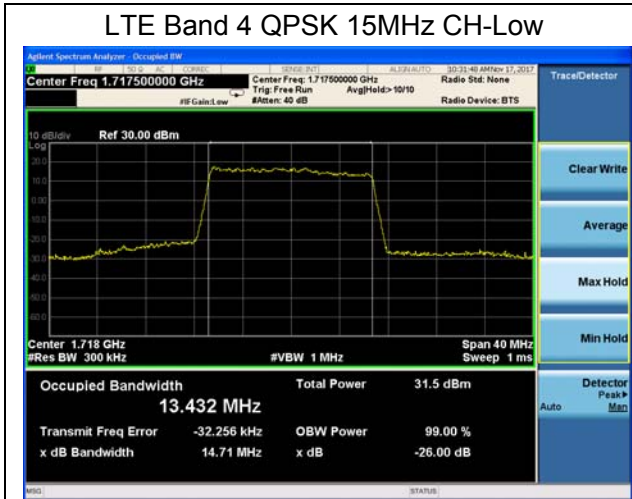

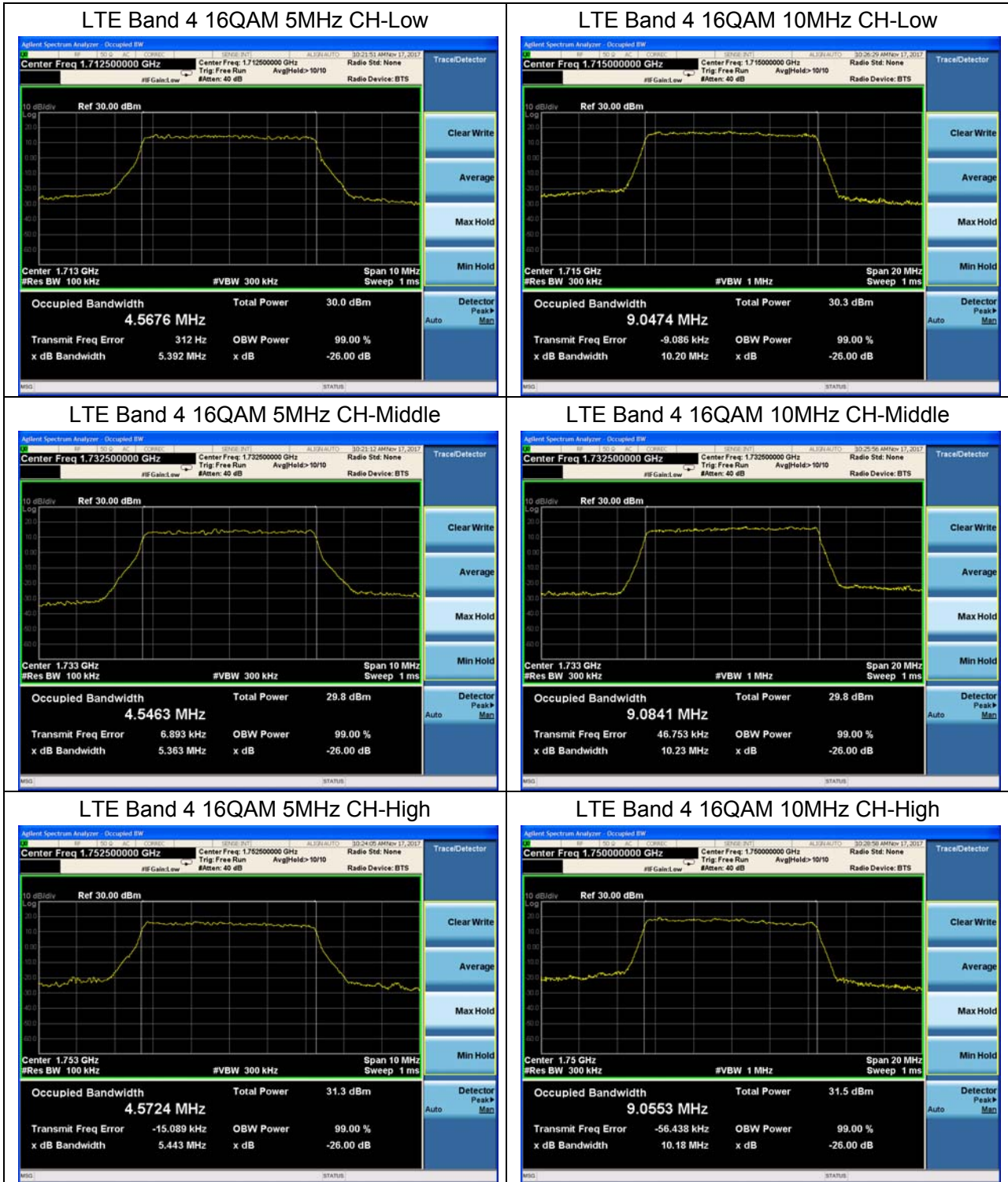

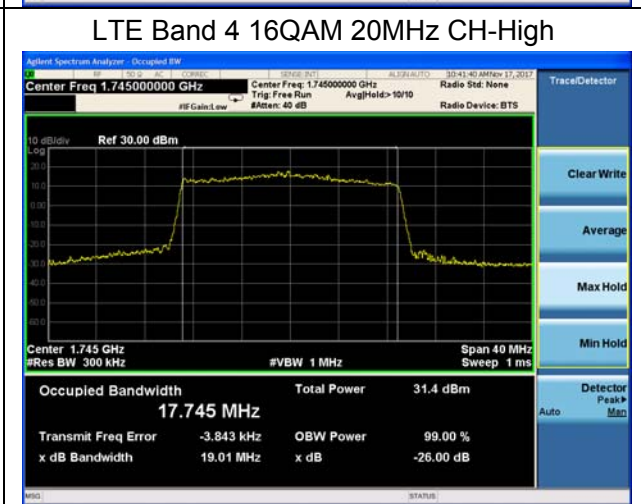
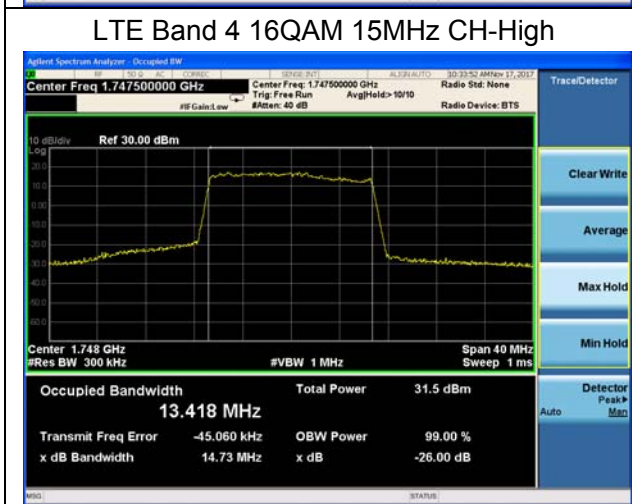
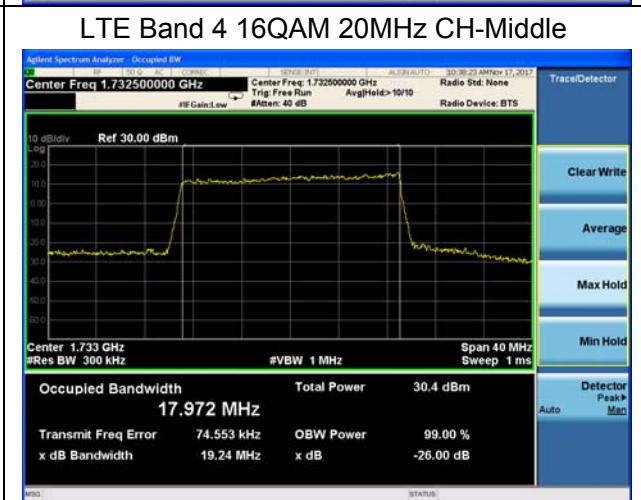
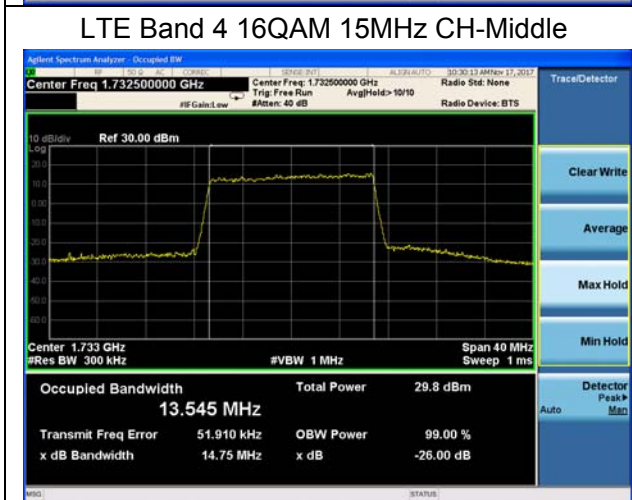
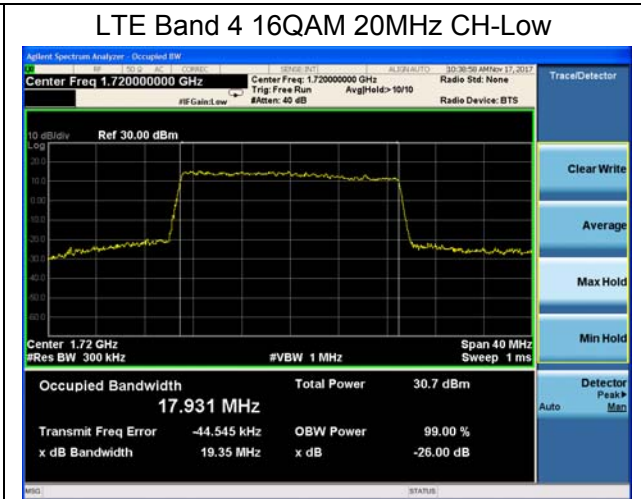
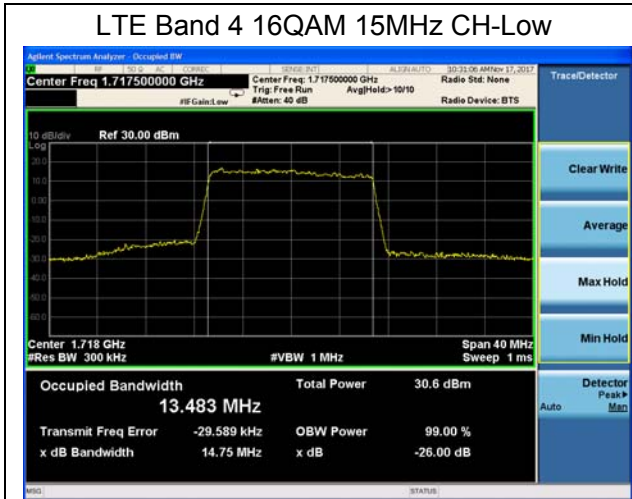



## 5.4 Band Edge Compliance

### Ambient condition

Temperature	Relative humidity	Pressure
23°C ~25°C	45%~50%	101.5kPa

### Method of Measurement

The EUT was connected to Spectrum Analyzer and Base Station Simulator via power Splitter. The band edge of the lowest and highest channels were measured.

The testing follows KDB 971168 v03 Section 6.0

- 1.The EUT was connected to spectrum analyzer and system simulator via a power divider.
2. The band edges of low and high channels for the highest RF powers were measured.
3. RBW is set to 51 kHz, VBW is set to 160 kHz for LTE Band 4 (5MHz).  
RBW is set to 100 kHz, VBW is set to 300kHz for LTE Band 4 (10MHz).  
RBW is set to 150 kHz, VBW is set to 510 kHz for LTE Band 4 (15MHz).  
RBW is set to 200 kHz, VBW is set to 620 kHz for LTE Band 4 (20MHz) on spectrum analyzer.
4. Set spectrum analyzer with RMS detector.
5. The RF fundamental frequency should be excluded against the limit line in the operating frequency band.
6. Checked that all the results comply with the emission limit line.

### Test Setup

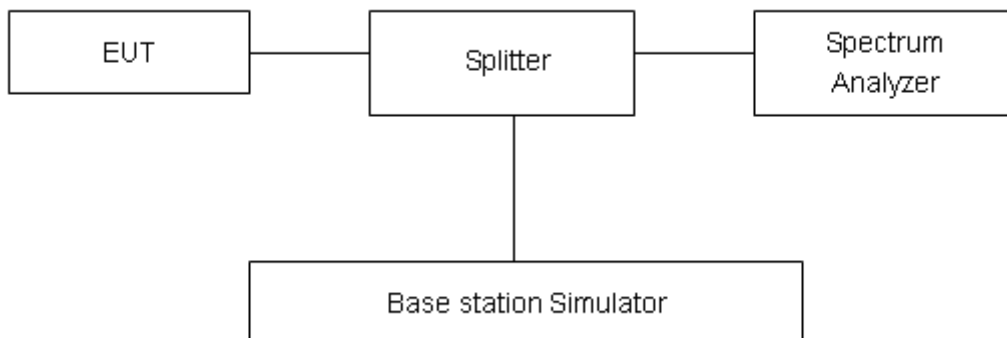

**Limits**

Rule Part 27.53(h) specifies that “ for operations in the 1695-1710 MHz, 1710-1755 MHz, 1755-1780 MHz, 1915-1920 MHz, 1995-2000 MHz, 2000-2020 MHz, 2110-2155 MHz, 2155-2180 MHz, and 2180-2200 bands, the power of any emission outside a licensee's frequency block shall be attenuated below the transmitter power (P) in watts by at least  $43 + 10 \log_{10} (P)$  dB”

**Measurement Uncertainty**

The assessed measurement uncertainty to ensure 95% confidence level for the normal distribution is with the coverage factor  $k = 1.96$ ,  $U=0.684$ dB.



**Test Result**

All the test traces in the plots shows the test results clearly.

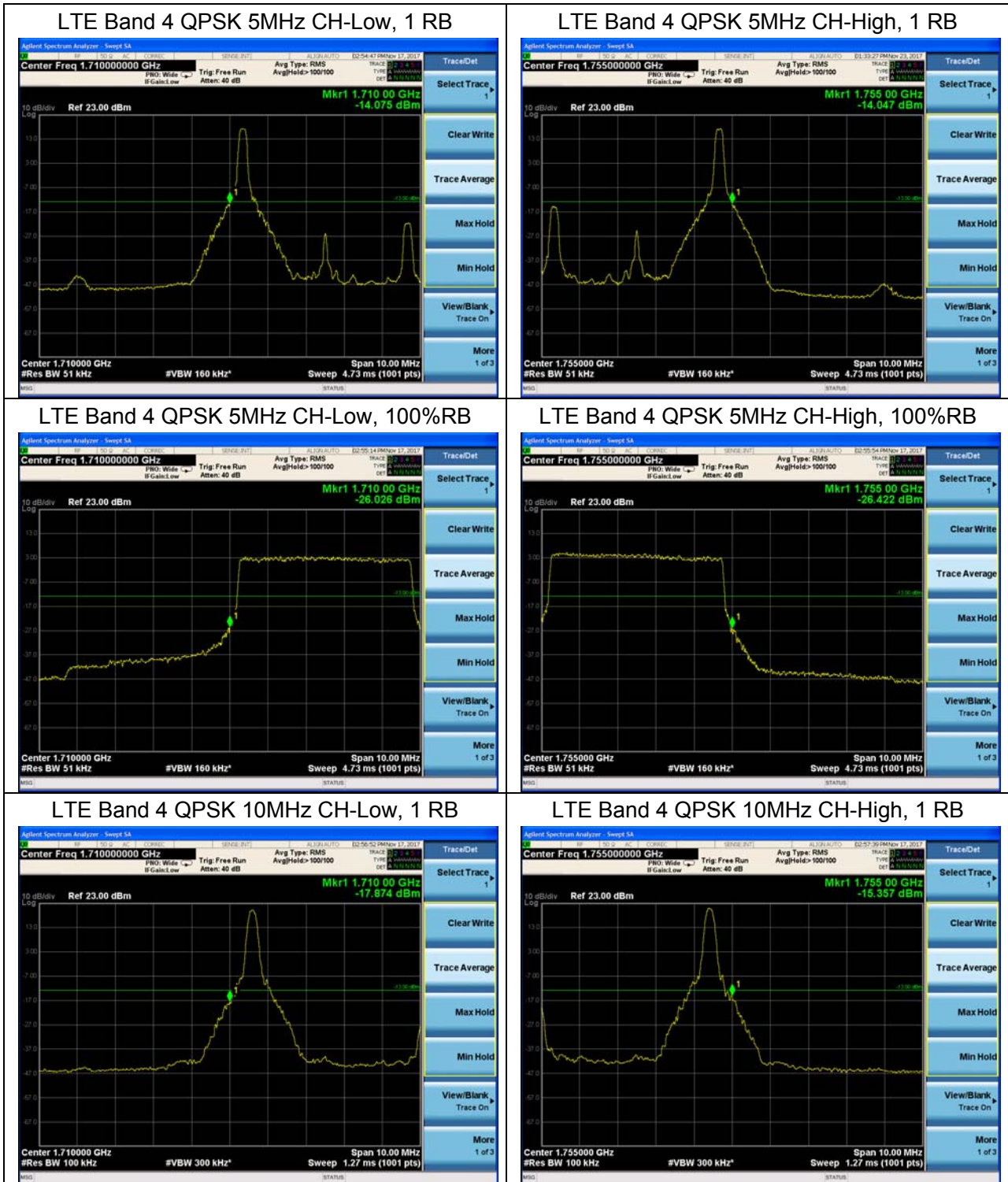



LTE Band 4 QPSK 10MHz CH-Low, 100%RB



LTE Band 4 QPSK 10MHz CH-High, 100%RB



LTE Band 4 QPSK 15MHz CH-Low, 1 RB

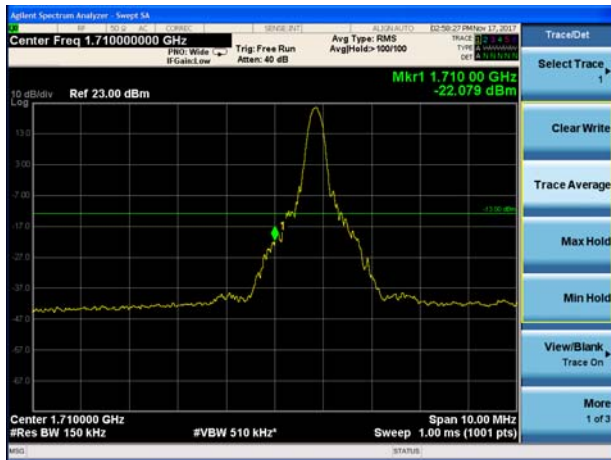

LTE Band 4 QPSK 15MHz CH-High, 1 RB

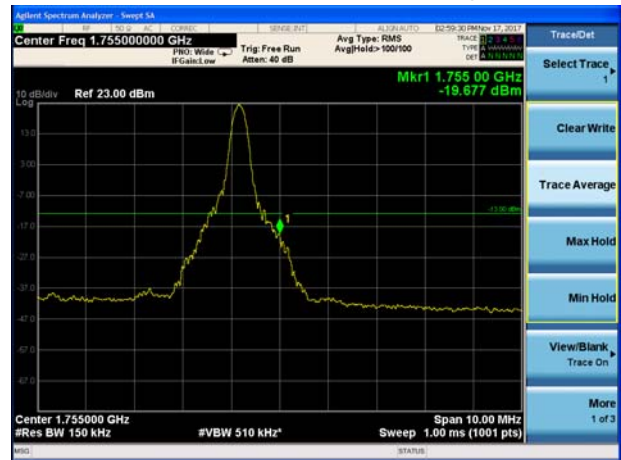

LTE Band 4 QPSK 15MHz CH-Low, 100%RB



LTE Band 4 QPSK 15MHz CH-High, 100%RB





LTE Band 4 QPSK 20MHz CH-Low, 1 RB



LTE Band 4 QPSK 20MHz CH-High, 1 RB

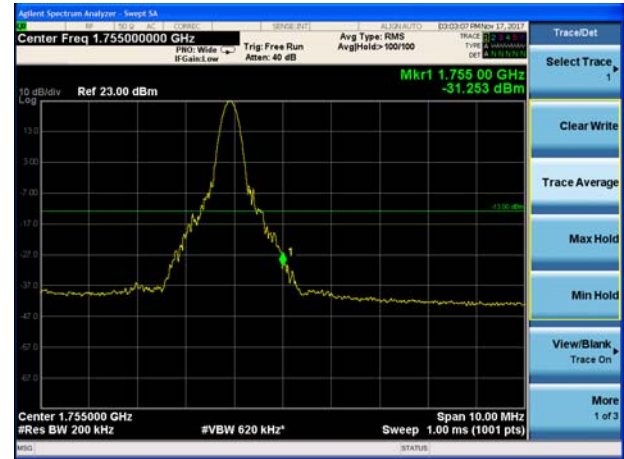

LTE Band 4 QPSK 20MHz CH-Low, 100%RB



LTE Band 4 QPSK 20MHz CH-High, 100%RB



LTE Band 4 16QAM 5MHz CH-Low, 1 RB

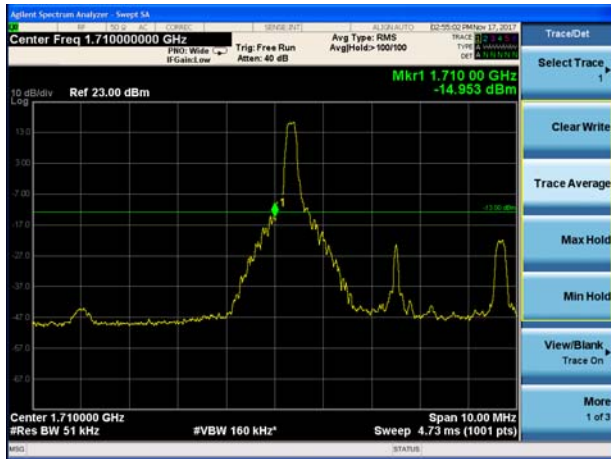

LTE Band 4 16QAM 5MHz CH-High, 1 RB





LTE Band 4 16QAM 5MHz CH-Low, 100%RB



LTE Band 4 16QAM 5MHz CH-High, 100%RB



LTE Band 4 16QAM 10MHz CH-Low, 1 RB

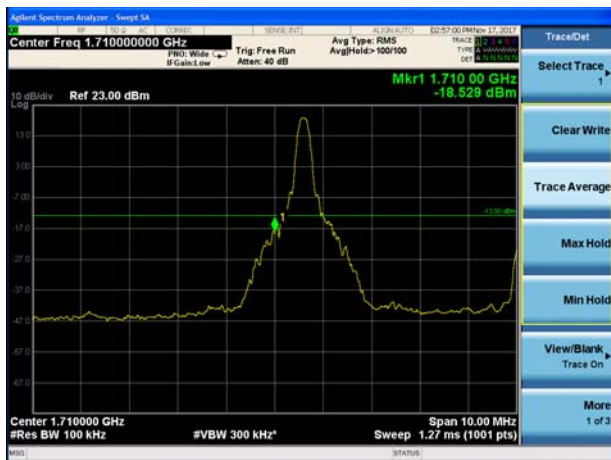

LTE Band 4 16QAM 10MHz CH-High, 1 RB

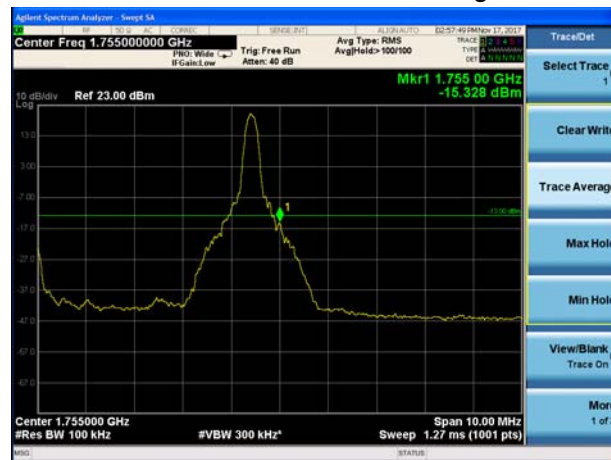

LTE Band 4 16QAM 10MHz CH-Low, 100%RB

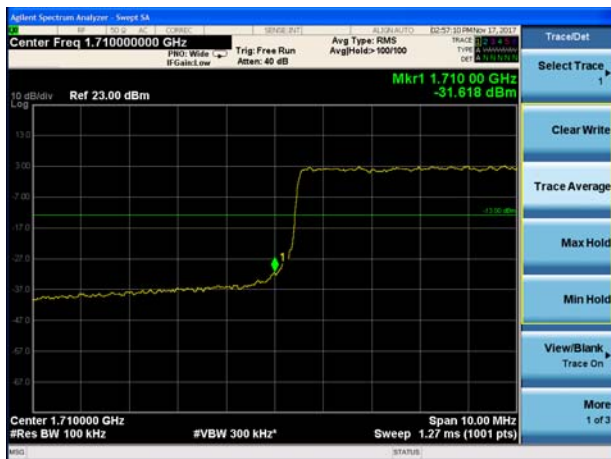

LTE Band 4 16QAM 10MHz CH-High, 100%RB

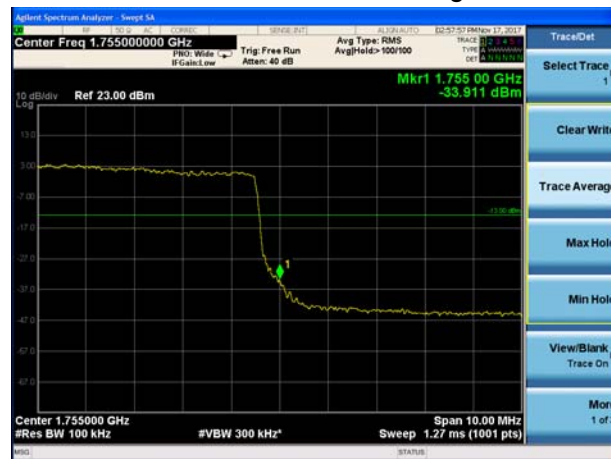





LTE Band 4 16QAM 15MHz CH-Low, 1 RB

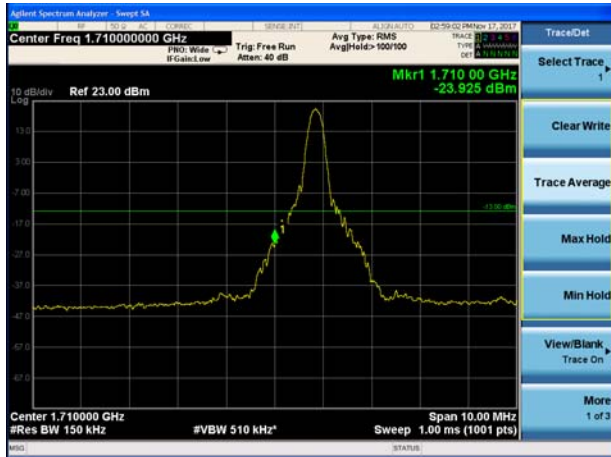

LTE Band 4 16QAM 15MHz CH-High, 1 RB

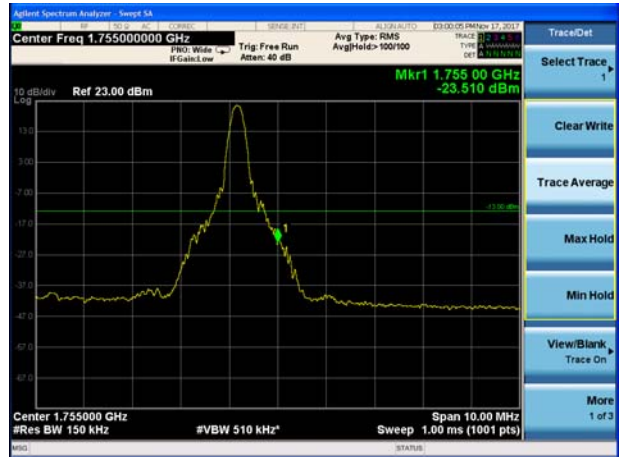

LTE Band 4 16QAM 15MHz CH-Low, 100%RB

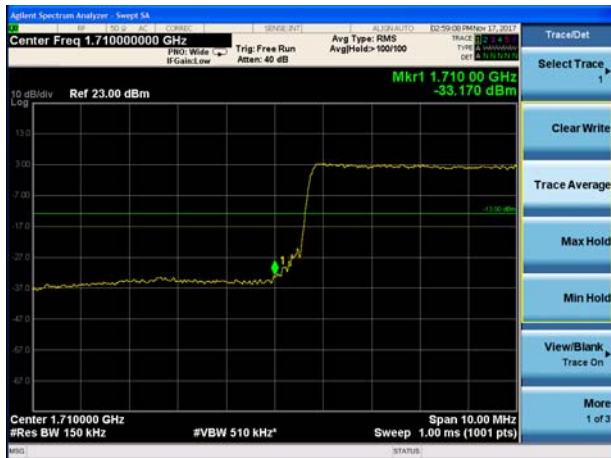

LTE Band 4 16QAM 15MHz CH-High, 100%RB



LTE Band 4 16QAM 20MHz CH-Low, 1 RB

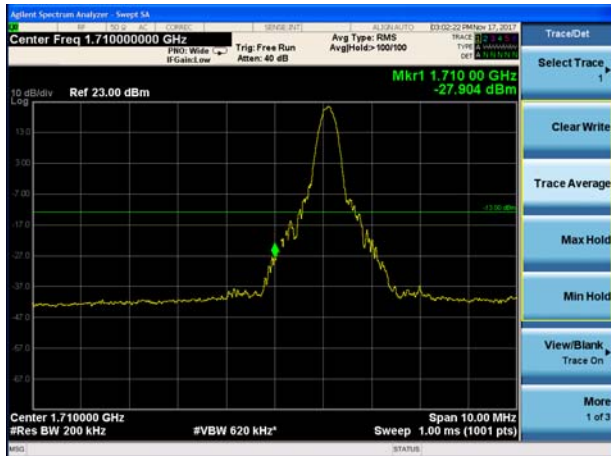

LTE Band 4 16QAM 20MHz CH-High, 1 RB





LTE Band 4 16QAM 20MHz CH-Low, 100%RB

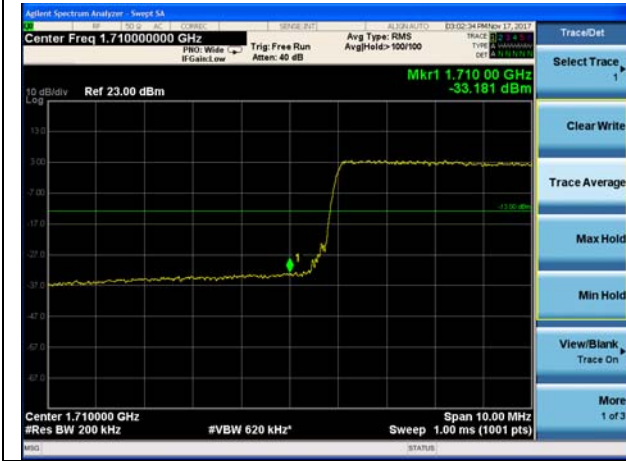

LTE Band 4 16QAM 20MHz CH-High, 100%RB

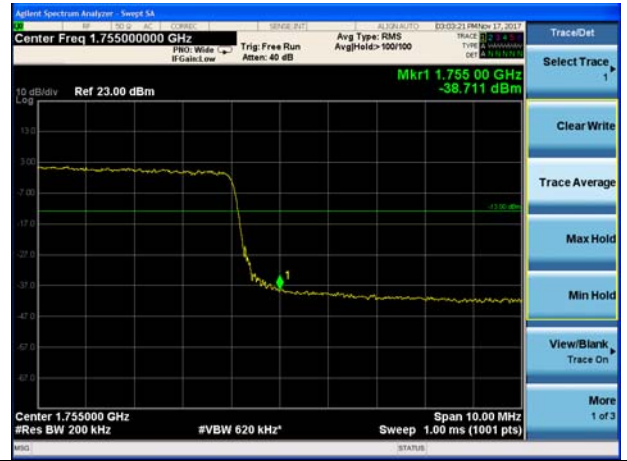

### 5.5 Peak-to-Average Power Ratio (PAPR)

#### Ambient condition

Temperature	Relative humidity	Pressure
23°C ~25°C	45%~50%	101.5kPa

#### Methods of Measurement

Measure the total peak power and record as PPk. And measure the total average power and record as PAvg. Both the peak and average power levels must be expressed in the same logarithmic units (e.g., dBm). Determine the PAPR from:

$$PAPR (dB) = PPk (dBm) - PAvg (dBm).$$

#### Test Setup

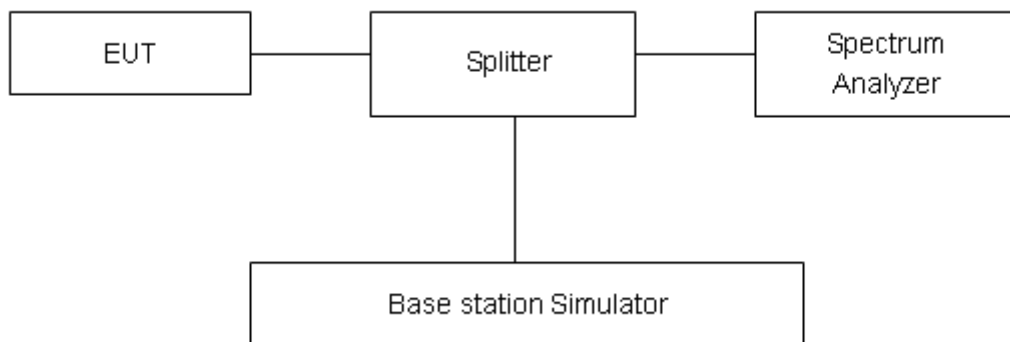

#### Limits

Rule Part 27.50(d)(5) Equipment employed must be authorized in accordance with the provisions of 24.51. Power measurements for transmissions by stations authorized under this section may be made either in accordance with a Commission-approved average power technique or in compliance with paragraph (d)(6) of this section. In measuring transmissions in this band using an average power technique, the peak-to-average ratio (PAR) of the transmission may not exceed 13 dB.

#### Measurement Uncertainty

The assessed measurement uncertainty to ensure 95% confidence level for the normal distribution is with the coverage factor k = 2, U= 0.4 dB.

**Test Results**

LTE Band 4								
Modulation	Bandwidth (MHz)	Channel	Frequency (MHz)	Peak (dBm)	Avg (dBm)	PAPR (dB)	Limit (dB)	Conclusion
QPSK	5	19975	1712.5	26.98	21.24	5.74	≤13	PASS
		20175	1732.5	26.79	20.96	5.83	≤13	PASS
		20375	1752.5	27.88	22.35	5.53	≤13	PASS
	10	20000	1715	27.30	21.73	5.57	≤13	PASS
		20175	1732.5	27.07	21.32	5.75	≤13	PASS
		20350	1750	27.86	22.47	5.39	≤13	PASS
	15	20025	1717.5	27.50	21.76	5.74	≤13	PASS
		20175	1732.5	27.47	21.37	6.10	≤13	PASS
		20325	1747.5	28.07	22.51	5.56	≤13	PASS
	20	20050	1720	27.58	22.05	5.53	≤13	PASS
		20175	1732.5	27.32	21.61	5.71	≤13	PASS
		20300	1745	27.37	22.23	5.14	≤13	PASS
16QAM	5	19975	1712.5	26.72	20.28	6.44	≤13	PASS
		20175	1732.5	26.56	20.15	6.41	≤13	PASS
		20375	1752.5	27.83	21.53	6.30	≤13	PASS
	10	20000	1715	27.10	20.79	6.31	≤13	PASS
		20175	1732.5	26.75	20.34	6.41	≤13	PASS
		20350	1750	27.98	21.73	6.25	≤13	PASS
	15	20025	1717.5	27.13	20.81	6.32	≤13	PASS
		20175	1732.5	26.89	20.38	6.51	≤13	PASS
		20325	1747.5	27.99	21.76	6.23	≤13	PASS
	20	20050	1720	27.41	21.13	6.28	≤13	PASS
		20175	1732.5	27.20	20.74	6.46	≤13	PASS
		20300	1745	27.46	21.34	6.12	≤13	PASS



## 5.6 Frequency Stability

### Ambient condition

Temperature	Relative humidity	Pressure
23°C ~25°C	45%~50%	101.5kPa

### Method of Measurement

#### 1. Frequency Stability (Temperature Variation)

The temperature inside the climate chamber is varied from -30°C to +50°C in 10°C step size.

(1) With all power removed, the temperature was decreased to -10°C and permitted to stabilize for three hours.

(2) Measure the carrier frequency with the test equipment in a “call mode”. These measurements should be made within 1 minute of powering up the mobile station, to prevent significant self warming.

(3) Repeat the above measurements at 10°C increments from -30°C to +50°C. Allow at least 1.5 hours at each temperature, un-powered, before making measurements.

#### 2. Frequency Stability (Voltage Variation)

The frequency stability shall be measured with variation of primary supply voltage as follows:

(1) Vary primary supply voltage from 85 to 115 percent of the nominal value for other than hand carried battery equipment.

(2) For hand carried, battery powered equipment, reduce primary supply voltage to the battery-operating end point which shall be specified by the manufacturer.

This transceiver is specified to operate with an input voltage of between 9 V and 13 V, with a nominal voltage of 12V.

### Test setup

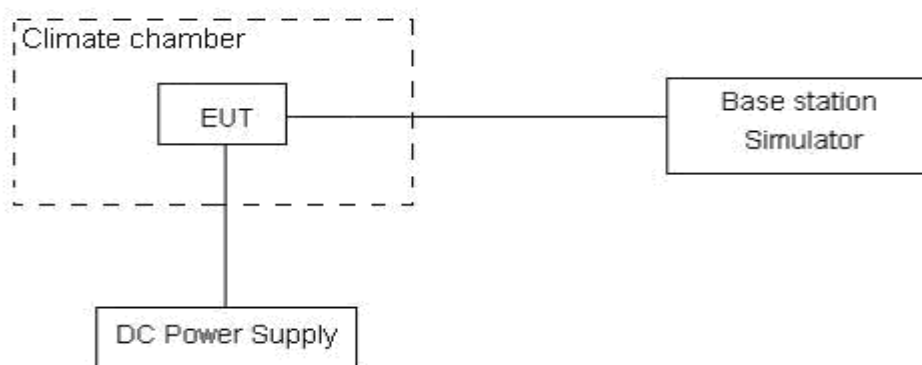

### Limits

No specific frequency stability requirements in part 27.54

### Measurement Uncertainty

The assessed measurement uncertainty to ensure 99.75% confidence level for the normal distribution is with the coverage factor  $k = 3, U=0.01\text{ppm}$ .

**Test Result**

Bandwidth	Test status	LTE Band 4 Middle Channel Test Results (ppm)	
		QPSK	16QAM
5MHz	-30°C/Normal Voltage	-0.00551	-0.00679
	-20°C/Normal Voltage	-0.00230	-0.00044
	-10°C/Normal Voltage	0.01762	-0.00516
	0°C/Normal Voltage	0.00269	0.00592
	10°C/Normal Voltage	-0.00656	0.00672
	20°C/Normal Voltage	-0.00447	-0.00036
	30°C/Normal Voltage	-0.00495	-0.00113
	40°C/Normal Voltage	0.00547	0.00311
	50°C/Normal Voltage	0.00510	0.00771
	20°C/Min Voltage	0.00291	0.00359
	20°C/Max Voltage	-0.00713	-0.01209
10MHz	-30°C/Normal Voltage	0.01122	0.00205
	-20°C/Normal Voltage	-0.00203	0.00163
	-10°C/Normal Voltage	0.00708	-0.00820
	0°C/Normal Voltage	0.00821	0.00519
	10°C/Normal Voltage	-0.00729	-0.00379
	20°C/Normal Voltage	0.01004	0.00136
	30°C/Normal Voltage	0.00618	0.00102
	40°C/Normal Voltage	-0.00332	0.00424
	50°C/Normal Voltage	0.00677	0.00111
	20°C/Min Voltage	-0.00648	-0.01005
	20°C/Max Voltage	0.00911	-0.00236
15MHz	-30°C/Normal Voltage	-0.00067	-0.00244
	-20°C/Normal Voltage	0.00769	-0.01202
	-10°C/Normal Voltage	-0.00004	-0.00401
	0°C/Normal Voltage	-0.00272	0.00749
	10°C/Normal Voltage	0.00194	-0.00257
	20°C/Normal Voltage	0.00068	0.00702
	30°C/Normal Voltage	0.00197	-0.00808
	40°C/Normal Voltage	-0.00390	0.00278
	50°C/Normal Voltage	0.00624	0.00676
	20°C/Min Voltage	-0.00425	-0.00468
	20°C/Max Voltage	-0.00214	-0.00353
20MHz	-30°C/Normal Voltage	-0.00412	0.00207
	-20°C/Normal Voltage	0.00010	-0.00319



-10°C/Normal Voltage	0.00407	-0.00109
0°C/Normal Voltage	0.00315	-0.01106
10°C/Normal Voltage	0.00828	0.00479
20°C/Normal Voltage	-0.01094	-0.00048
30°C/Normal Voltage	-0.00571	-0.00522
40°C/Normal Voltage	0.00414	-0.00142
50°C/Normal Voltage	-0.00429	-0.00136
20°C/Min Voltage	-0.00169	-0.00433
20°C/Max Voltage	-0.00570	-0.00217

### 5.7 Spurious Emissions at Antenna Terminals

**Ambient condition**

Temperature	Relative humidity	Pressure
23°C ~25°C	45%~50%	101.5kPa

**Method of Measurement**

The EUT was connected to Spectrum Analyzer and Base Station Simulator via power Splitter. The measurement is carried out using a spectrum analyzer. The spectrum analyzer scans from 30MHz to the 10th harmonic of the carrier. The peak detector is used. Set RBW 1MHz and VBW3MHz, Sweep is set to ATUO.

Of those disturbances below (limit – 20 dB), the mark is not required for the EUT.

**Test setup**

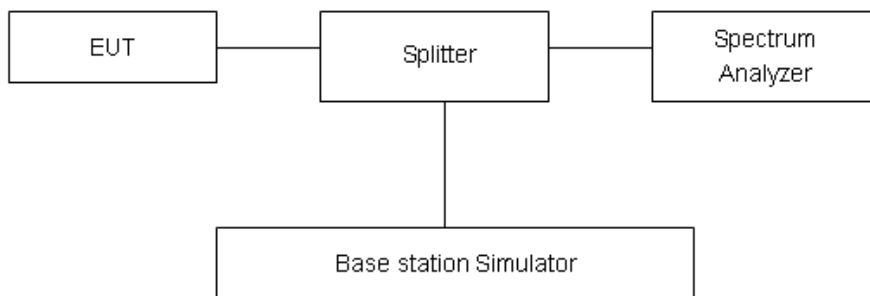

**Limits**

Rule Part 27.53(h) specifies that “for operations in the 1695-1710 MHz, 1710-1755 MHz, 1755-1780 MHz, 1915-1920 MHz, 1995-2000 MHz, 2000-2020 MHz, 2110-2155 MHz, 2155-2180 MHz, and 2180-2200 bands, the power of any emission outside a licensee's frequency block shall be attenuated below the transmitter power (P) in watts by at least 43 + 10 log<sub>10</sub> (P) dB..”

Limit	-13 dBm
-------	---------

**Measurement Uncertainty**

The assessed measurement uncertainty to ensure 99.75% confidence level for the normal distribution is with the coverage factor  $k = 1.96$ .

Frequency	Uncertainty
100kHz-2GHz	0.684 dB
2GHz-18GHz	1.407 dB

**Test Result**

Sweep from 9 kHz to 30MHz, and the emissions more than 20 dB below the permissible value are not reported.

If disturbances were found more than 20dB below limit line, the mark is not required for the EUT. The signal beyond the limit is carrier.

LTE Band 4 5MHz CH-Low 30MHz~3GHz

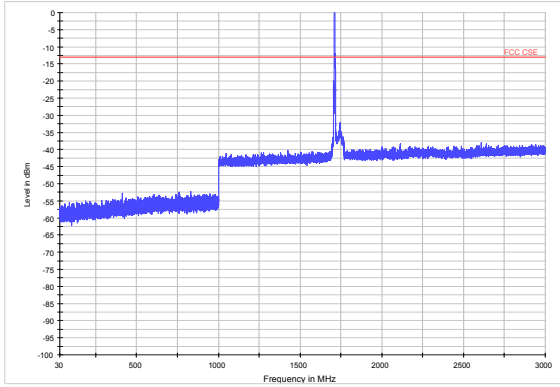

LTE Band 4 5MHz CH-Low 3GHz~18GHz

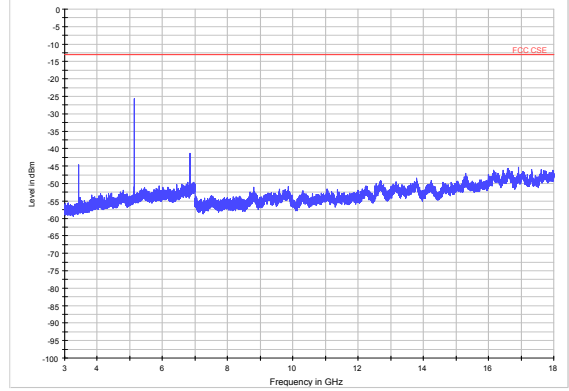

LTE Band 4 5MHz CH-Middle 30MHz~3GHz

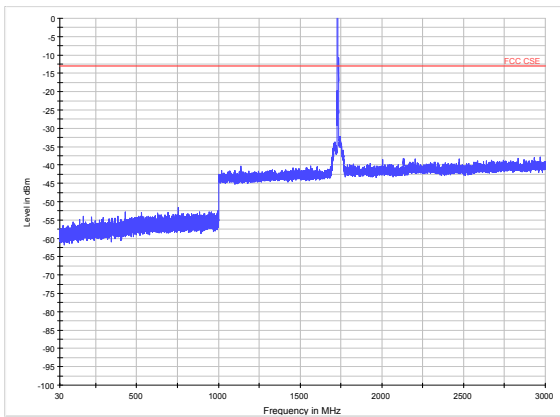

LTE Band 4 5MHz CH-Middle 3GHz~18GHz

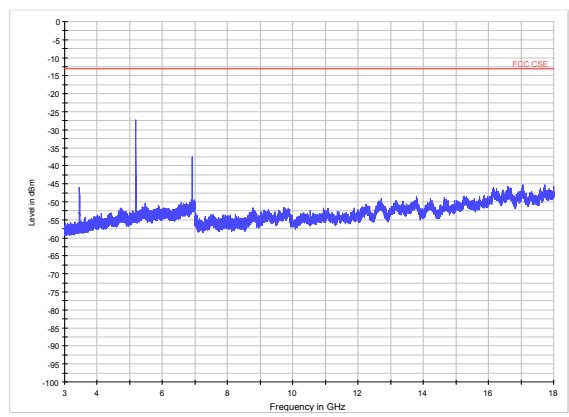

LTE Band 4 5MHz CH-High 30MHz~3GHz

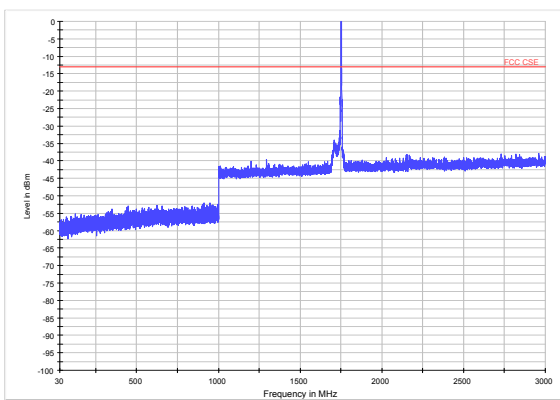

LTE Band 4 5MHz CH-High 3GHz~18GHz

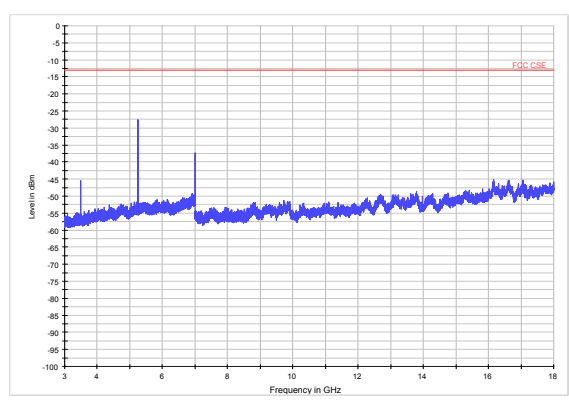



LTE Band 4 10MHz CH-Low 30MHz~3GHz

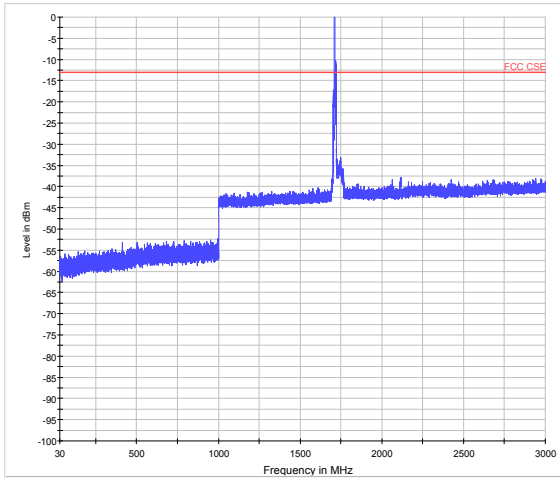

LTE Band 4 10MHz CH-Low 3GHz~18GHz

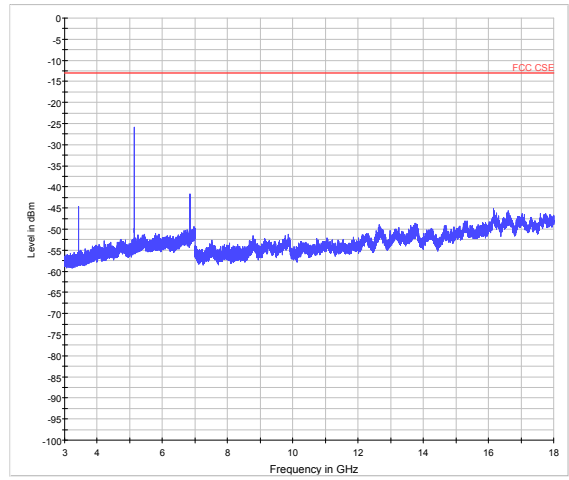

LTE Band 4 10MHz CH-Middle 30MHz~3GHz

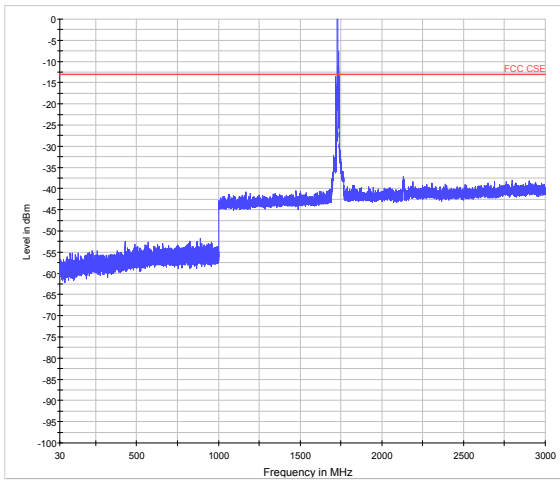

LTE Band 4 10MHz CH-Middle 3GHz~18GHz

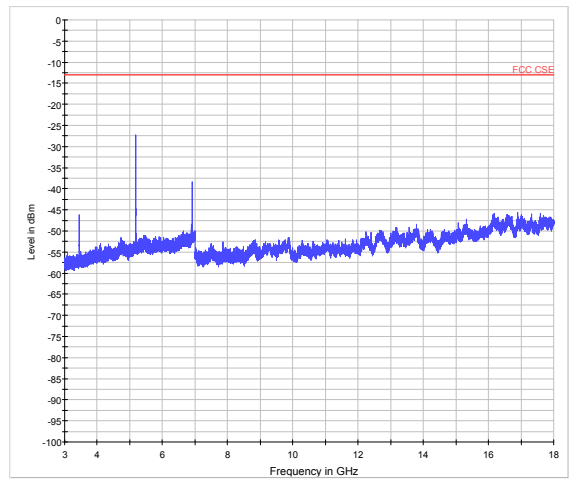

LTE Band 4 10MHz CH-High 30MHz~3GHz

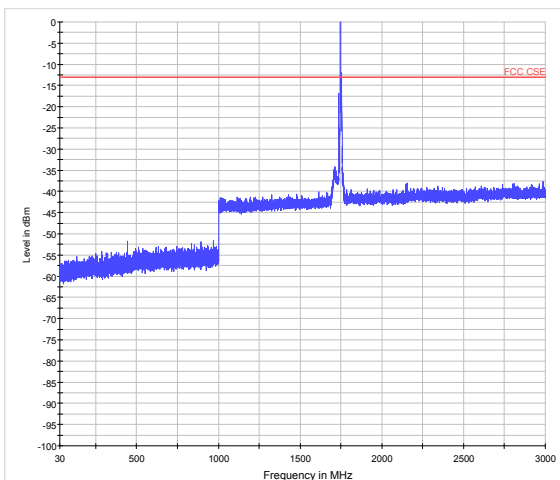

LTE Band 4 10MHz CH-High 3GHz~18GHz

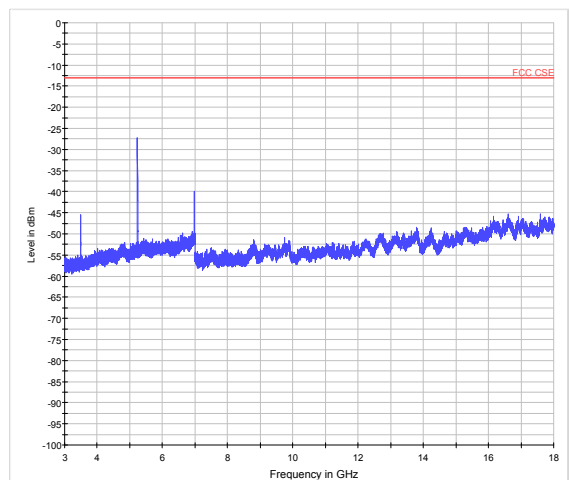



LTE Band 4 15MHz CH-Low 30MHz~3GHz

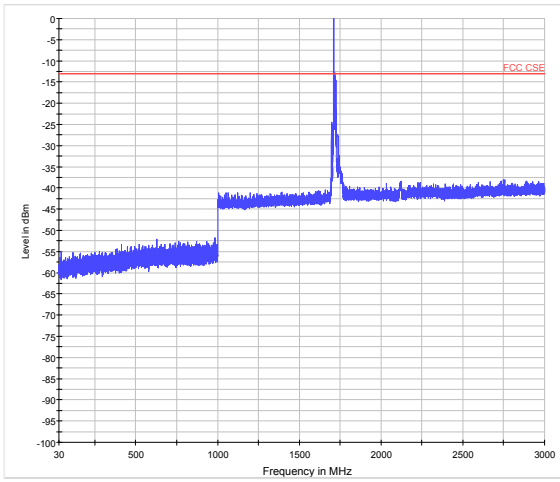

LTE Band 4 15MHz CH-Low 3GHz~18GHz

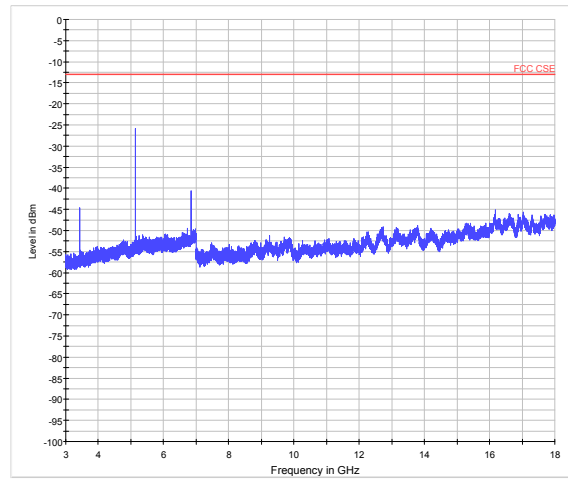

LTE Band 4 15MHz CH-Middle 30MHz~3GHz

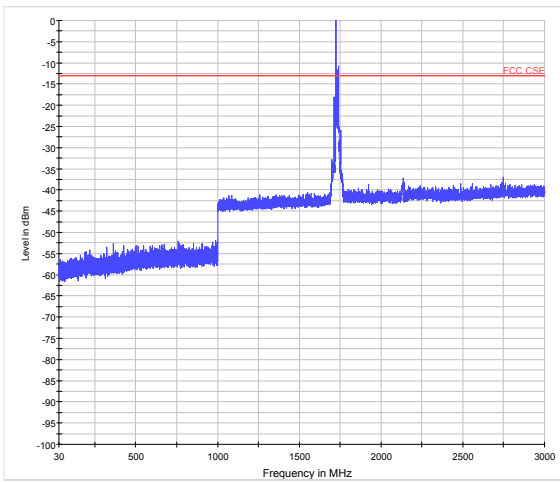

LTE Band 4 15MHz CH-Middle 3GHz~18GHz

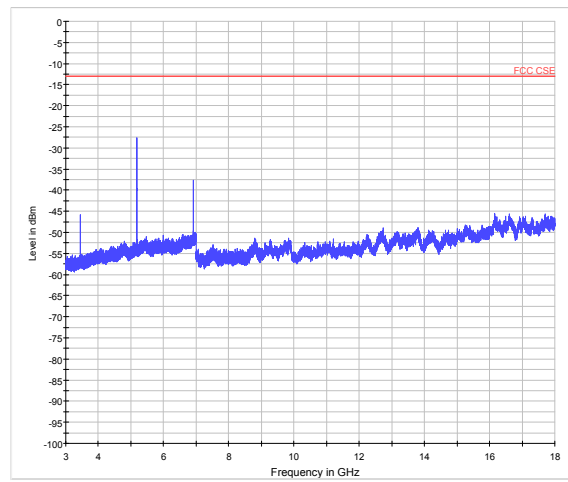

LTE Band 4 15MHz CH-High 30MHz~3GHz

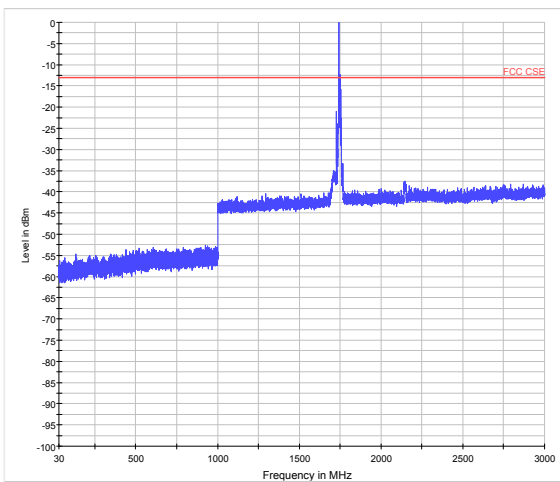

LTE Band 4 15MHz CH-High 3GHz~18GHz

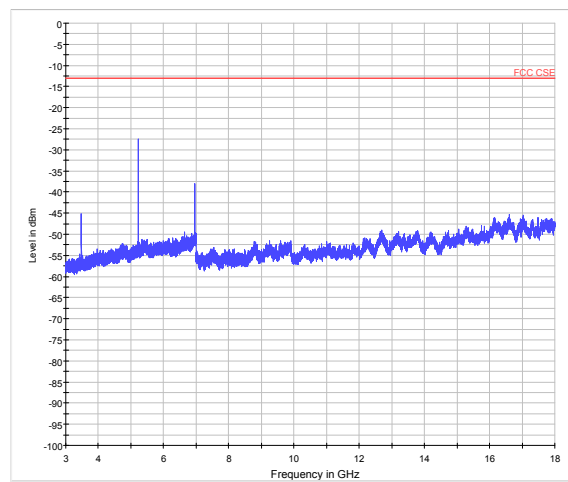



LTE Band 4 20MHz CH-Low 30MHz~3GHz

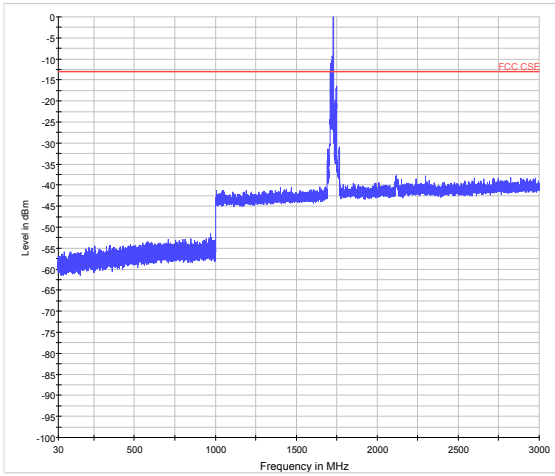

LTE Band 4 20MHz CH-Low 3GHz~18GHz

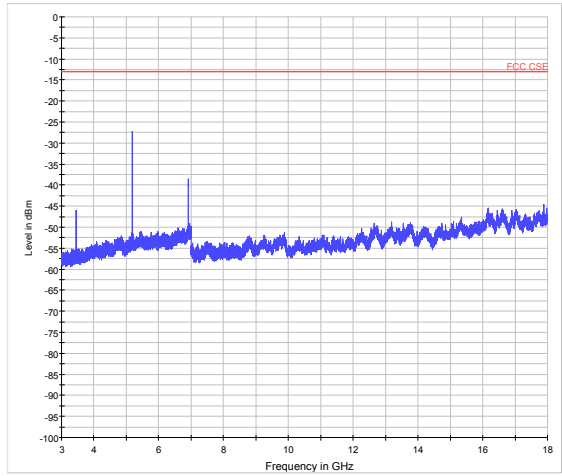

LTE Band 4 20MHz CH-Middle 30MHz~3GHz

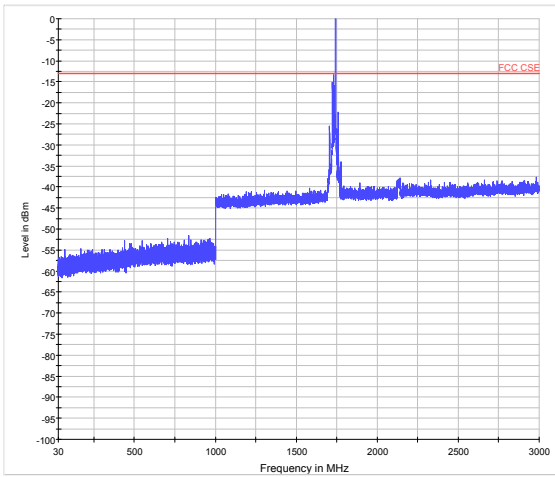

LTE Band 4 20MHz CH-Middle 3GHz~18GHz

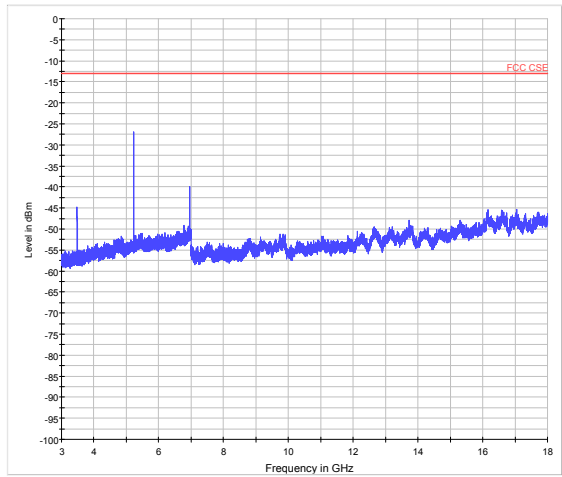

LTE Band 4 20MHz CH-High 30MHz~3GHz

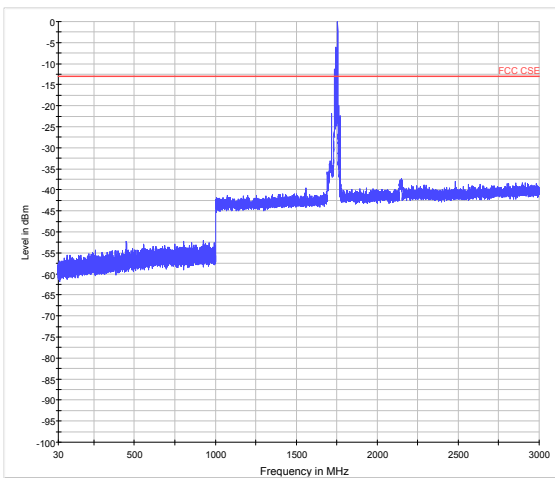

LTE Band 4 20MHz CH-High 3GHz~18GHz

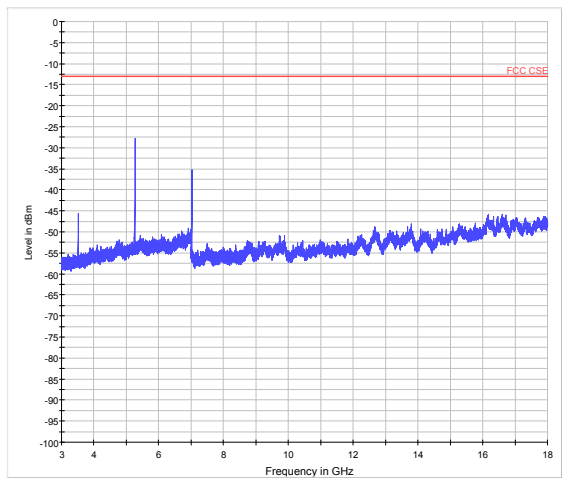



If disturbances were found more than 20dB below limit line, the mark is not required for the EUT.  
The signal beyond the limit is carrier in the following plots.

Test Data File Name	Frequency (MHz)	Level (dBm)	Limit (dBm)	Margin (dB)
CSE_LTE B4_CHLOW_5M_RB1_3-18GHz	5130.3	-26.75	-13.00	13.75
CSE_LTE B4_CHMID_5M_RB1_3-18GHz	5191.3	-27.29	-13.00	14.29
CSE_LTE B4_CHHIGH_5M_RB1_3-18GHz	5251.1	-27.64	-13.00	14.64
CSE_LTE B4_CHLOW_10M_RB1_3-18GHz	5131.9	-25.95	-13.00	12.95
CSE_LTE B4_CHMID_10M_RB1_3-18GHz	5184.4	-27.32	-13.00	14.32
CSE_LTE B4_CHHIGH_10M_RB1_3-18GHz	5236.9	-27.30	-13.00	14.30
CSE_LTE B4_CHLOW_15M_RB1_3-18GHz	5136.3	-25.89	-13.00	12.89
CSE_LTE B4_CHMID_15M_RB1_3-18GHz	5177.6	-27.55	-13.00	14.55
CSE_LTE B4_CHHIGH_15M_RB1_3-18GHz	5223.0	-27.90	-13.00	14.90
CSE_LTE B4_CHLOW_20M_RB1_3-18GHz	5186.6	-27.33	-13.00	14.33
CSE_LTE B4_CHMID_20M_RB1_3-18GHz	5224.5	-26.88	-13.00	13.88
CSE_LTE B4_CHHIGH_20M_RB1_3-18GHz	5262.0	-27.82	-13.00	14.82

## 5.8 Radiates Spurious Emission

### Ambient condition

Temperature	Relative humidity	Pressure
23°C ~25°C	45%~50%	101.5kPa

### Method of Measurement

1. The testing follows FCC KDB 971168 v03 Section 5.8 and ANSI/TIA-603-D-2010.
2. The EUT is placed on a turntable 0.8 meters above the ground in the chamber, 3 meter away from the antenna. The maximal emission value is acquired by adjusting the antenna height, polarisation and turntable azimuth. Normally, the height range of antenna is 1 m to 4 m, the azimuth range of turntable is 0° to 360°, and the receive antenna has two polarizations Vertical (V) and Horizontal (H).
3. A log-periodic antenna or double-ridged waveguide horn antenna shall be substituted in place of the EUT. The log-periodic antenna will be driven by a signal generator and the level will be adjusted till the same power value on the spectrum analyzer or receiver. The level of the spurious emissions can be calculated through the level of the signal generator, cable loss, the gain of the substitution antenna and the reading of the spectrum analyzer or receiver.
4. The EUT is then put into continuously transmitting mode at its maximum power level during the test. Set Test Receiver or Spectrum RBW=1MHz, VBW=3MHz, And the maximum value of the receiver should be recorded as (Pr).
5. The EUT shall be replaced by a substitution antenna. In the chamber, an substitution antenna for the frequency band of interest is placed at the reference point of the chamber. An RF Signal source for the frequency band of interest is connected to the substitution antenna with a cable that has been constructed to not interfere with the radiation pattern of the antenna. A power (PMea) is applied to the input of the substitution antenna, and adjust the level of the signal generator output until the value of the receiver reach the previously recorded (Pr). The power of signal source (PMea) is recorded. The test should be performed by rotating the test item and adjusting the receiving antenna polarization.
6. A amplifier should be connected to the Signal Source output port. And the cable should be connect between the Amplifier and the Substitution Antenna. The cable loss (Pcl) ,the Substitution Antenna Gain (Ga) and the Amplifier Gain (PAg) should be recorded after test.
7. The measurement results are obtained as described below:  

$$\text{Power(EIRP)} = \text{PMea} - \text{PAg} - \text{Pcl} + \text{Ga}$$
 The measurement results are amend as described below:  

$$\text{Power(EIRP)} = \text{PMea} - \text{Pcl} + \text{Ga}$$
8. This value is EIRP since the measurement is calibrated using an antenna of known gain (2.15 dBi) and known input power. ERP can be calculated from EIRP by subtracting the gain of the dipole,  $\text{ERP} = \text{EIRP} - 2.15\text{dBi}$ .

**Test setup**

**30MHz~~~ 1GHz**

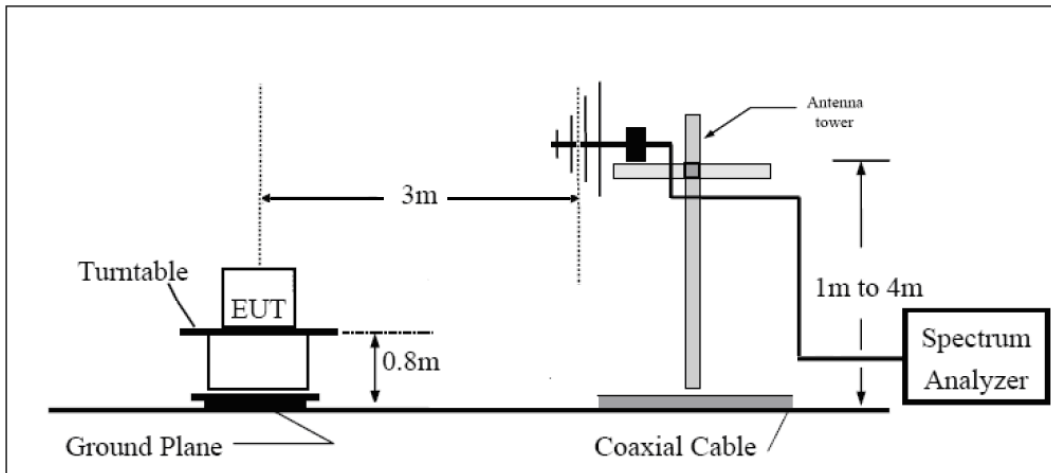

**Above 1GHz**

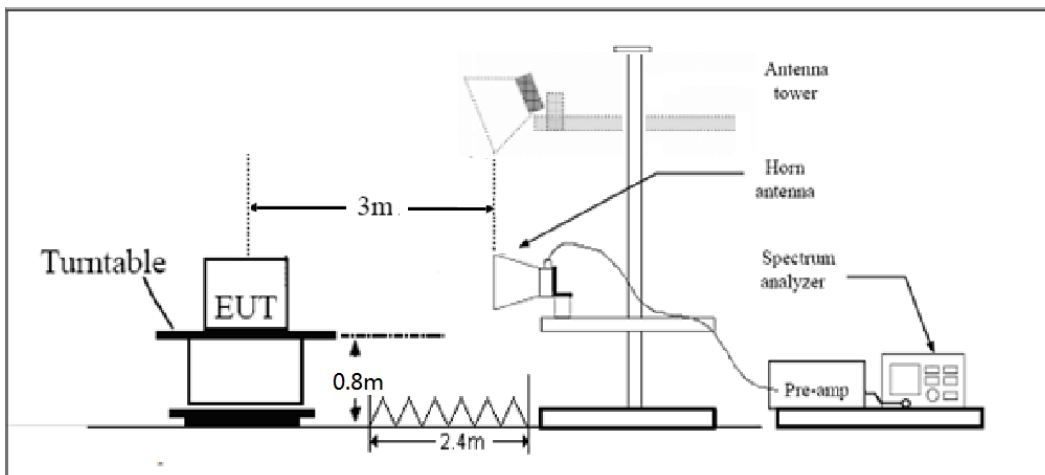

Note: Area side:2.4mX3.6m

The radiated emission was measured in the following position: EUT stand-up position (Z axis), lie-down position (X, Y axis). The worst emission was found in stand-up position (Z axis) and the worst case was recorded.

**Limits**

Rule Part 27.53(h) specifies that “for operations in the 1695-1710 MHz, 1710-1755 MHz, 1755-1780 MHz, 1915-1920 MHz, 1995-2000 MHz, 2000-2020 MHz, 2110-2155 MHz, 2155-2180 MHz, and 2180-2200 bands, the power of any emission outside a licensee's frequency block shall be attenuated below the transmitter power (P) in watts by at least 43 + 10 log<sub>10</sub> (P) dB..”

LTE B4 Limit	-13 dBm
--------------	---------

**Measurement Uncertainty**

The assessed measurement uncertainty to ensure 95% confidence level for the normal distribution is with the coverage factor  $k = \pm 1.96$ ,  $U = \pm 3.55$  dB.

**Test Result**

LTE Band 4 QPSK 5MHz CH-Low, RB 1

Harmonic	Frequency (MHz)	SG (dBm)	Cable Loss (dB)	Gain (dBi)	Antenna Polarization	EIRP Level (dBm)	Limit (dBm)	Margin (dB)	Azimuth (deg)
2	3425.0	-55.95	2.6	10.15	Horizontal	-48.4	-13.0	35.4	315
3	5137.5	-48.25	2.4	11.35	Horizontal	-39.3	-13.0	26.3	180
4	6850.0	-58.35	4.5	10.85	Horizontal	-52.0	-13.0	39.0	90
5	8562.5	-58.15	5.1	11.35	Horizontal	-51.9	-13.0	38.9	45
6	10275.0	-58.35	5.3	11.95	Horizontal	-51.7	-13.0	38.7	270
7	11987.5	-59.45	5.5	13.55	Horizontal	-51.4	-13.0	38.4	315
8	13700.0	-56.15	6.3	13.75	Horizontal	-48.7	-13.0	35.7	225
9	15412.5	-53.95	6.7	13.85	Horizontal	-46.8	-13.0	33.8	225
10	17125.0	-53.45	6.8	14.25	Horizontal	-46.0	-13.0	33.0	135

Note: 1.The other Spurious RF Radiated emissions level is no more than noise floor.  
2. The worst emission was found in the antenna is Horizontal position.

LTE Band 4 QPSK 5MHz CH-Middle, RB 1

Harmonic	Frequency (MHz)	SG (dBm)	Cable Loss (dB)	Gain (dBi)	Antenna Polarization	EIRP Level (dBm)	Limit (dBm)	Margin (dB)	Azimuth (deg)
2	3465.0	-61.05	2.6	10.75	Horizontal	-52.9	-13.0	39.9	0
3	5197.5	-47.15	2.4	11.05	Horizontal	-38.5	-13.0	25.5	135
4	6930.0	-54.95	4.5	11.15	Horizontal	-48.3	-13.0	35.3	270
5	8662.5	-48.85	5.1	11.35	Horizontal	-42.6	-13.0	29.6	0
6	10395.0	-59.65	5.3	11.95	Horizontal	-53.0	-13.0	40.0	90
7	12127.5	-61.75	5.5	13.55	Horizontal	-53.7	-13.0	40.7	45
8	13860.0	-56.45	6.3	13.75	Horizontal	-49.0	-13.0	36.0	45
9	15592.5	-54.85	6.7	13.85	Horizontal	-47.7	-13.0	34.7	180
10	17325.0	-52.65	6.8	14.25	Horizontal	-45.2	-13.0	32.2	270

Note: 1.The other Spurious RF Radiated emissions level is no more than noise floor.  
2. The worst emission was found in the antenna is Horizontal position.



## LTE Band 4 QPSK 5MHz CH-High, RB 1

Harmonic	Frequency (MHz)	SG (dBm)	Cable Loss (dB)	Gain (dBi)	Antenna Polarization	EIRP Level (dBm)	Limit (dBm)	Margin (dB)	Azimuth (deg)
2	3505.0	-60.75	2.6	10.15	Horizontal	-53.2	-13.0	40.2	180
3	5257.5	-45.55	2.4	11.05	Horizontal	-36.9	-13.0	23.9	270
4	7010.0	-57.35	4.5	11.15	Horizontal	-50.7	-13.0	37.7	225
5	8762.5	-55.75	5.1	11.35	Horizontal	-49.5	-13.0	36.5	45
6	10515.0	-59.45	5.3	11.95	Horizontal	-52.8	-13.0	39.8	135
7	12267.5	-56.45	5.5	13.55	Horizontal	-48.4	-13.0	35.4	225
8	14020.0	-56.55	6.3	13.75	Horizontal	-49.1	-13.0	36.1	315
9	15772.5	-53.25	6.7	13.85	Horizontal	-46.1	-13.0	33.1	45
10	17525.0	-53.85	6.8	14.25	Horizontal	-46.4	-13.0	33.4	315

Note: 1.The other Spurious RF Radiated emissions level is no more than noise floor.  
2. The worst emission was found in the antenna is Horizontal position.

## LTE Band 4 QPSK 10MHz CH-Low, RB 1

Harmonic	Frequency (MHz)	SG (dBm)	Cable Loss (dB)	Gain (dBi)	Antenna Polarization	EIRP Level (dBm)	Limit (dBm)	Margin (dB)	Azimuth (deg)
2	3430.0	-61.25	2.6	10.15	Horizontal	-53.7	-13.0	40.7	315
3	5145.0	-40.95	2.4	11.35	Horizontal	-32.0	-13.0	19.0	315
4	6860.0	-55.55	4.5	10.85	Horizontal	-49.2	-13.0	36.2	0
5	8575.0	-53.15	5.1	11.35	Horizontal	-46.9	-13.0	33.9	135
6	10290.0	-51.55	5.3	11.95	Horizontal	-44.9	-13.0	31.9	90
7	12005.0	-59.05	5.5	13.55	Horizontal	-51.0	-13.0	38.0	90
8	13720.0	-58.65	6.3	13.75	Horizontal	-51.2	-13.0	38.2	90
9	15435.0	-58.05	6.7	13.85	Horizontal	-50.9	-13.0	37.9	135
10	17150.0	-58.95	6.8	14.25	Horizontal	-51.5	-13.0	38.5	180

Note: 1.The other Spurious RF Radiated emissions level is no more than noise floor.  
2. The worst emission was found in the antenna is Horizontal position.

**LTE Band 4 QPSK 10MHz CH-Middle, RB 1**

Harmonic	Frequency (MHz)	SG (dBm)	Cable Loss (dB)	Gain (dBi)	Antenna Polarization	EIRP Level (dBm)	Limit (dBm)	Margin (dB)	Azimuth (deg)
2	3465.0	-57.45	2.6	10.75	Horizontal	-49.3	-13.0	36.3	180
3	5197.5	-39.95	2.4	11.05	Horizontal	-31.3	-13.0	18.3	180
4	6930.0	-56.05	4.5	11.15	Horizontal	-49.4	-13.0	36.4	270
5	8662.5	-51.45	5.1	11.35	Horizontal	-45.2	-13.0	32.2	45
6	10395.0	-58.05	5.3	11.95	Horizontal	-51.4	-13.0	38.4	270
7	12127.5	-59.35	5.5	13.55	Horizontal	-51.3	-13.0	38.3	225
8	13860.0	-58.45	6.3	13.75	Horizontal	-51.0	-13.0	38.0	0
9	15592.5	-57.85	6.7	13.85	Horizontal	-50.7	-13.0	37.7	270
10	17325.0	-58.85	6.8	14.25	Horizontal	-51.4	-13.0	38.4	0

Note: 1.The other Spurious RF Radiated emissions level is no more than noise floor.  
2. The worst emission was found in the antenna is Horizontal position.

**LTE Band 4 QPSK 10MHz CH-High, RB 1**

Harmonic	Frequency (MHz)	SG (dBm)	Cable Loss (dB)	Gain (dBi)	Antenna Polarization	EIRP Level (dBm)	Limit (dBm)	Margin (dB)	Azimuth (deg)
2	3500.0	-59.15	2.6	10.15	Horizontal	-51.6	-13.0	38.6	135
3	5250.0	-43.85	2.4	11.05	Horizontal	-35.2	-13.0	22.2	45
4	7000.0	-52.75	4.5	11.15	Horizontal	-46.1	-13.0	33.1	135
5	8750.0	-46.95	5.1	11.35	Horizontal	-40.7	-13.0	27.7	0
6	10500.0	-57.55	5.3	11.95	Horizontal	-50.9	-13.0	37.9	90
7	12250.0	-58.95	5.5	13.55	Horizontal	-50.9	-13.0	37.9	45
8	14000.0	-58.65	6.3	13.75	Horizontal	-51.2	-13.0	38.2	225
9	15750.0	-58.45	6.7	13.85	Horizontal	-51.3	-13.0	38.3	90
10	17500.0	-58.75	6.8	14.25	Horizontal	-51.3	-13.0	38.3	135

Note: 1.The other Spurious RF Radiated emissions level is no more than noise floor.  
2. The worst emission was found in the antenna is Horizontal position.

**LTE Band 4 QPSK 15MHz CH Low, RB 1**

Harmonic	Frequency (MHz)	SG (dBm)	Cable Loss (dB)	Gain (dBi)	Antenna Polarization	EIRP Level (dBm)	Limit (dBm)	Margin (dB)	Azimuth (deg)
2	3435.0	-59.35	2.6	10.15	Horizontal	-51.8	-13.0	38.8	90
3	5152.5	-41.45	2.4	11.35	Horizontal	-32.5	-13.0	19.5	45
4	6870.0	-55.85	4.5	10.85	Horizontal	-49.5	-13.0	36.5	180
5	8587.5	-52.45	5.1	11.35	Horizontal	-46.2	-13.0	33.2	315
6	10305.0	-55.45	5.3	11.95	Horizontal	-48.8	-13.0	35.8	315
7	12022.5	-59.05	5.5	13.55	Horizontal	-51.0	-13.0	38.0	0
8	13740.0	-58.75	6.3	13.75	Horizontal	-51.3	-13.0	38.3	225
9	15457.5	-58.35	6.7	13.85	Horizontal	-51.2	-13.0	38.2	0
10	17175.0	-58.65	6.8	14.25	Horizontal	-51.2	-13.0	38.2	225

Note: 1.The other Spurious RF Radiated emissions level is no more than noise floor.  
2. The worst emission was found in the antenna is Horizontal position.

**LTE Band 4 QPSK 15MHz CH-Middle, RB 1**

Harmonic	Frequency (MHz)	SG (dBm)	Cable Loss (dB)	Gain (dBi)	Antenna Polarization	EIRP Level (dBm)	Limit (dBm)	Margin (dB)	Azimuth (deg)
2	3465.0	-57.25	2.6	10.75	Horizontal	-49.1	-13.0	36.1	270
3	5197.5	-40.05	2.4	11.05	Horizontal	-31.4	-13.0	18.4	225
4	6930.0	-57.95	4.5	11.15	Horizontal	-51.3	-13.0	38.3	270
5	8662.5	-56.15	5.1	11.35	Horizontal	-49.9	-13.0	36.9	90
6	10395.0	-57.95	5.3	11.95	Horizontal	-51.3	-13.0	38.3	45
7	12127.5	-58.95	5.5	13.55	Horizontal	-50.9	-13.0	37.9	135
8	13860.0	-58.25	6.3	13.75	Horizontal	-50.8	-13.0	37.8	135
9	15592.5	-58.15	6.7	13.85	Horizontal	-51.0	-13.0	38.0	225
10	17325.0	-58.55	6.8	14.25	Horizontal	-51.1	-13.0	38.1	180

Note: 1.The other Spurious RF Radiated emissions level is no more than noise floor.  
2. The worst emission was found in the antenna is Horizontal position.

**LTE Band 4 QPSK 15MHz CH-High, RB 1**

Harmonic	Frequency (MHz)	SG (dBm)	Cable Loss (dB)	Gain (dBi)	Antenna Polarization	EIRP Level (dBm)	Limit (dBm)	Margin (dB)	Azimuth (deg)
2	3495.0	-56.65	2.6	10.15	Horizontal	-49.1	-13.0	36.1	90
3	5242.5	-42.45	2.4	11.05	Horizontal	-33.8	-13.0	20.8	135
4	6990.0	-53.15	4.5	11.15	Horizontal	-46.5	-13.0	33.5	225
5	8737.5	-53.35	5.1	11.35	Horizontal	-47.1	-13.0	34.1	315
6	10485.0	-57.85	5.3	11.95	Horizontal	-51.2	-13.0	38.2	90
7	12232.5	-58.95	5.5	13.55	Horizontal	-50.9	-13.0	37.9	315
8	13980.0	-59.05	6.3	13.75	Horizontal	-51.6	-13.0	38.6	45
9	15727.5	-58.05	6.7	13.85	Horizontal	-50.9	-13.0	37.9	180
10	17475.0	-58.95	6.8	14.25	Horizontal	-51.5	-13.0	38.5	45

Note: 1.The other Spurious RF Radiated emissions level is no more than noise floor.  
2. The worst emission was found in the antenna is Horizontal position.

**LTE Band 4 QPSK 20MHz CH-Low, RB 1**

Harmonic	Frequency (MHz)	SG (dBm)	Cable Loss (dB)	Gain (dBi)	Antenna Polarization	EIRP Level (dBm)	Limit (dBm)	Margin (dB)	Azimuth (deg)
2	3440.0	-56.25	2.6	10.15	Horizontal	-48.7	-13.0	35.7	315
3	5160.0	-40.15	2.4	11.35	Horizontal	-31.2	-13.0	18.2	45
4	6880.0	-55.35	4.5	10.85	Horizontal	-49.0	-13.0	36.0	135
5	8600.0	-56.25	5.1	11.35	Horizontal	-50.0	-13.0	37.0	135
6	10320.0	-58.05	5.3	11.95	Horizontal	-51.4	-13.0	38.4	90
7	12040.0	-59.75	5.5	13.55	Horizontal	-51.7	-13.0	38.7	0
8	13760.0	-58.95	6.3	13.75	Horizontal	-51.5	-13.0	38.5	225
9	15480.0	-58.75	6.7	13.85	Horizontal	-51.6	-13.0	38.6	0
10	17200.0	-58.65	6.8	14.25	Horizontal	-51.2	-13.0	38.2	315

Note: 1.The other Spurious RF Radiated emissions level is no more than noise floor.  
2. The worst emission was found in the antenna is Horizontal position.



**LTE Band 4 QPSK 20MHz CH-Middle, RB 1**

Harmonic	Frequency (MHz)	SG (dBm)	Cable Loss (dB)	Gain (dBi)	Antenna Polarization	EIRP Level (dBm)	Limit (dBm)	Margin (dB)	Azimuth (deg)
2	3465.0	-57.95	2.6	10.75	Horizontal	-49.8	-13.0	36.8	315
3	5197.5	-42.85	2.4	11.05	Horizontal	-34.2	-13.0	21.2	45
4	6930.0	-52.45	4.5	11.15	Horizontal	-45.8	-13.0	32.8	180
5	8662.5	-52.15	5.1	11.35	Horizontal	-45.9	-13.0	32.9	45
6	10395.0	-57.45	5.3	11.95	Horizontal	-50.8	-13.0	37.8	225
7	12127.5	-59.65	5.5	13.55	Horizontal	-51.6	-13.0	38.6	270
8	13860.0	-59.15	6.3	13.75	Horizontal	-51.7	-13.0	38.7	45
9	15592.5	-58.35	6.7	13.85	Horizontal	-51.2	-13.0	38.2	0
10	17325.0	-59.15	6.8	14.25	Horizontal	-51.7	-13.0	38.7	180

Note: 1. The other Spurious RF Radiated emissions level is no more than noise floor.  
2. The worst emission was found in the antenna is Horizontal position.

**LTE Band 4 QPSK 20MHz CH-High, RB 1**

Harmonic	Frequency (MHz)	SG (dBm)	Cable Loss (dB)	Gain (dBi)	Antenna Polarization	EIRP Level (dBm)	Limit (dBm)	Margin (dB)	Azimuth (deg)
2	3490.0	-56.75	2.6	10.15	Horizontal	-49.2	-13.0	36.2	45
3	5235.0	-42.45	2.4	11.05	Horizontal	-33.8	-13.0	20.8	225
4	6980.0	-48.55	4.5	11.15	Horizontal	-41.9	-13.0	28.9	315
5	8725.0	-47.75	5.1	11.35	Horizontal	-41.5	-13.0	28.5	315
6	10470.0	-53.35	5.3	11.95	Horizontal	-46.7	-13.0	33.7	135
7	12215.0	-57.75	5.5	13.55	Horizontal	-49.7	-13.0	36.7	0
8	13960.0	-54.05	6.3	13.75	Horizontal	-46.6	-13.0	33.6	270
9	15705.0	-58.05	6.7	13.85	Horizontal	-50.9	-13.0	37.9	45
10	17450.0	-58.25	6.8	14.25	Horizontal	-50.8	-13.0	37.8	45

Note: 1. The other Spurious RF Radiated emissions level is no more than noise floor.  
2. The worst emission was found in the antenna is Horizontal position.

## 6 Main Test Instruments

Name	Manufacturer	Type	Serial Number	Calibration Date	Expiration Date
Base Station Simulator	R&S	CMW500	113645	2017-05-14	2018-05-13
Power Splitter	Hua Xiang	SHX-GF2-2-13	10120101	2017-05-14	2018-05-13
Universal Radio Communication Tester	Agilent	E5515C	MY48367192	2017-05-14	2018-05-13
Spectrum Analyzer	Agilent	N9010A	MY47191109	2017-05-14	2018-05-13
Signal Analyzer	R&S	FSV30	100815	2016-12-16	2017-12-15
Signal generator	R&S	SMB 100A	102594	2017-05-14	2018-05-13
EMI Test Receiver	R&S	ESCI	100948	2017-05-20	2018-05-19
Trilog Antenna	SCHWARZBECK	VUBL 9163	9163-201	2014-12-06	2017-12-05
Horn Antenna	R&S	HF907	100126	2014-12-06	2017-12-05
Horn Antenna	ETS-Lindgren	3160-09	00102643	2015-01-30	2018-01-29
Climatic Chamber	Re Ce	PT-30B	20101891	2015-07-18	2018-07-17
RF Cable	Agilent	SMA 15cm	0001	2017-08-04	2018-02-03
Preamplifier	R&S	SCU18	102327	2017-06-18	2018-06-17
Software	R&S	EMC32	V 8.52.0	NA	NA

## ANNEX A: EUT Appearance and Test Setup

### A.1 EUT Appearance



a: EUT



b: Adapter

Picture 1 EUT and Accessory



## A.2 Test Setup

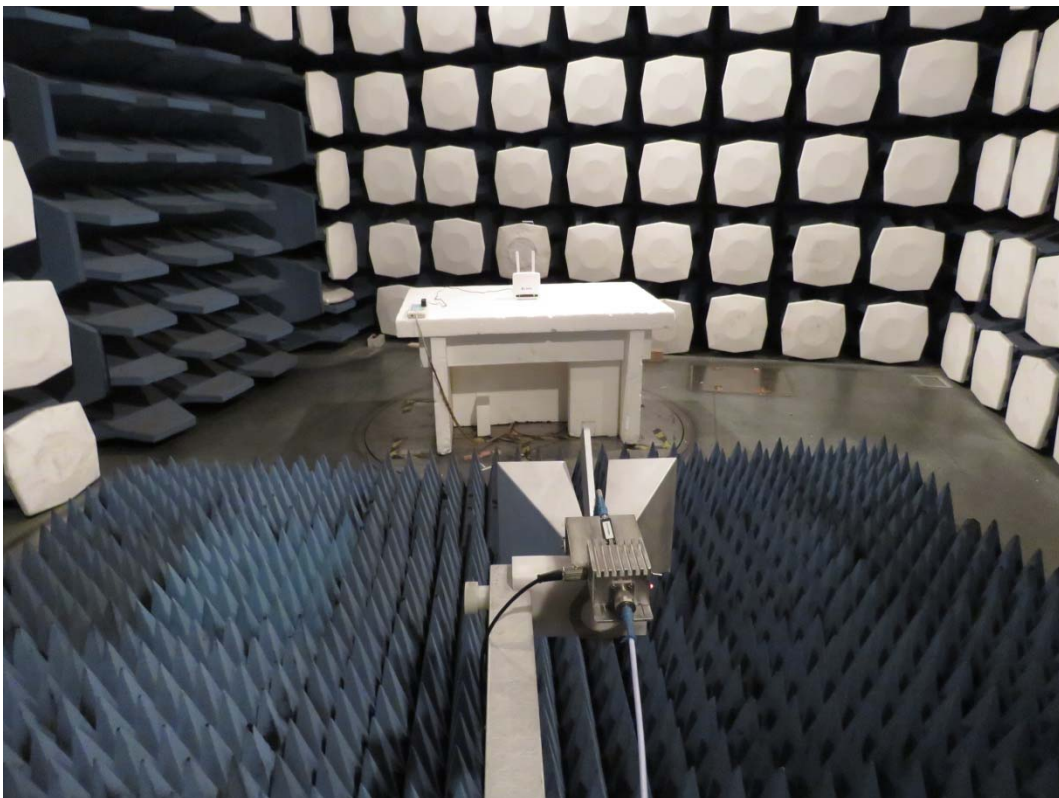
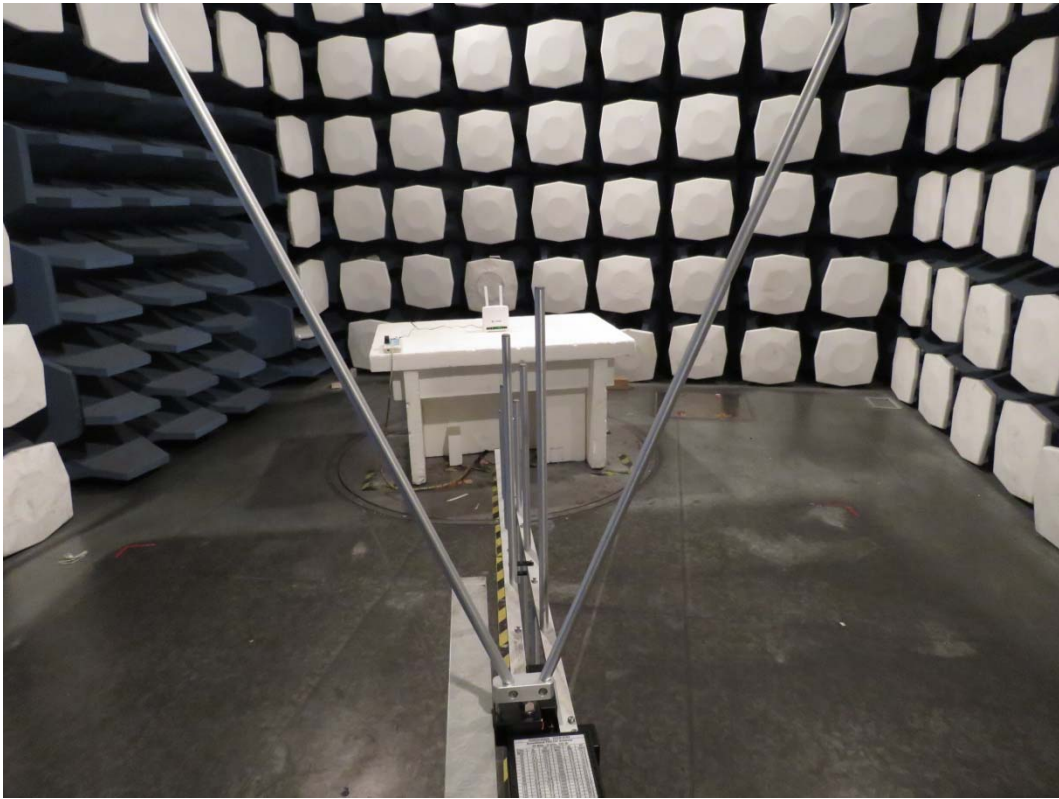

**Picture 2: Radiated Spurious Emissions Test setup**