



RF TEST REPORT

Applicant Gosuncn Technology Group Co.,Ltd.
FCC ID 2APNR-GW631Q
Product LTE CPE
Model WF831, WF831+, WF831A, GW631
Report No. R1805A0254-R1V1
Issue Date June 6, 2018

TA Technology (Shanghai) Co., Ltd. tested the above equipment in accordance with the requirements in **FCC CFR47 Part 2 (2017)/ FCC CFR 47 Part 24E (2017)**. The test results show that the equipment tested is capable of demonstrating compliance with the requirements as documented in this report.

Jiang peng Lan

Performed by: Jiangpeng Lan

Kai Xu

Approved by: Kai Xu

TA Technology (Shanghai) Co., Ltd.

No.145, Jintang Rd, Tangzhen Industry Park, Pudong Shanghai, China

TEL: +86-021-50791141/2/3

FAX: +86-021-50791141/2/3-8000



TABLE OF CONTENT

- 1. Test Laboratory4
 - 1.1. Notes of the test report.....4
 - 1.2. Test facility.....4
 - 1.3. Testing Location5
- 2. General Description of Equipment under Test.....6
- 3. Applied Standards.....8
- 4. Test Configuration.....9
- 5. Test Case Results.....10
 - 5.1. RF Power Output.....10
 - 5.2. Effective Isotropic Radiated Power13
 - 5.3. Occupied Bandwidth16
 - 5.4. Band Edge Compliance.....22
 - 5.5. Peak-to-Average Power Ratio (PAPR)29
 - 5.6. Frequency Stability.....31
 - 5.7. Spurious Emissions at Antenna Terminals35
 - 5.8. Radiates Spurious Emission43
- 6. Main Test Instruments51
- ANNEX A: EUT Appearance and Test Setup.....52
 - A.1 EUT Appearance52
 - A.2 Test Setup.....54

Summary of measurement results

No.	Test Case	Clause in FCC rules	Verdict
1	RF power output	2.1046	PASS
2	Effective Isotropic Radiated power	24.232(c)	PASS
3	Occupied Bandwidth	2.1049	PASS
4	Band Edge Compliance	2.1051 /24.238(a)	PASS
5	Peak-to-Average Power Ratio	24.232/KDB 971168 D01(5.7)	PASS
6	Frequency Stability	2.1055 / 24.235	PASS
7	Spurious Emissions at Antenna Terminals	2.1051 / 24.238(a)	PASS
8	Radiates Spurious Emission	2.1053 / 24.238(a)	PASS
Date of Testing: November 15, 2017 ~ November 24, 2017			
Note: PASS: The EUT complies with the essential requirements in the standard. FAIL: The EUT does not comply with the essential requirements in the standard.			



1. Test Laboratory

1.1. Notes of the test report

This report shall not be reproduced in full or partial, without the written approval of **TA technology (shanghai) co., Ltd.** The results documented in this report apply only to the tested sample, under the conditions and modes of operation as described herein. Measurement Uncertainties were not taken into account and are published for informational purposes only. This report is written to support regulatory compliance of the applicable standards stated above. This report must not be used by the client to claim product certification, approval, or endorsement by any government agencies.

1.2. Test facility

CNAS (accreditation number: L2264)

TA Technology (Shanghai) Co., Ltd. has obtained the accreditation of China National Accreditation Service for Conformity Assessment (CNAS).

FCC (Designation number: CN1179, Test Firm Registration Number: 446626)

TA Technology (Shanghai) Co., Ltd. has been listed on the US Federal Communications Commission list of test facilities recognized to perform electromagnetic emissions measurements.

IC (recognition number is 8510A)

TA Technology (Shanghai) Co., Ltd. has been listed by industry Canada to perform electromagnetic emission measurement.

VCCI (recognition number is C-4595, T-2154, R-4113, G-10766)

TA Technology (Shanghai) Co., Ltd. has been listed by industry Japan to perform electromagnetic emission measurement.

A2LA (Certificate Number: 3857.01)

TA Technology (Shanghai) Co., Ltd. has been listed by American Association for Laboratory Accreditation to perform electromagnetic emission measurement.



1.3. Testing Location

Company: TA Technology (Shanghai) Co., Ltd.
Address: No.145, Jintang Rd, Tangzhen Industry Park, Pudong
City: Shanghai
Post code: 201201
Country: P. R. China
Contact: Xu Kai
Telephone: +86-021-50791141/2/3
Fax: +86-021-50791141/2/3-8000
Website: <http://www.ta-shanghai.com>
E-mail: xukai@ta-shanghai.com

2. General Description of Equipment under Test

Client Information

Applicant	Gosuncn Technology Group Co.,Ltd.
Applicant address	6F, 2819 KaiChuang Blvd., Science Town, Huangpu District, Guangzhou City, Guangdong, China
Manufacturer	Gosuncn Technology Group Co.,Ltd.
Manufacturer address	6F, 2819 KaiChuang Blvd., Science Town, Huangpu District, Guangzhou City, Guangdong, China

General information

EUT Description			
Model	WF831, WF831+, WF831A, GW631		
IMEI	8942017450400020		
Hardware Version	V1.0		
Software Version	ENDEL_PER_WF831_V1.0.0B02		
Power Supply	AC adapter		
Antenna Type	External Antenna		
Test Mode(s)	LTE Band 2		
Test Modulation	QPSK,16QAM		
Maximum E.I.R.P	LTE Band 2:	26.05dBm	
Rated Power Supply Voltage	12V		
Extreme Voltage	Minimum: 9V Maximum: 13V		
Extreme Temperature	Lowest: -10°C Highest: +45°C		
Operating Frequency Range(s)	Band	Tx (MHz)	Rx (MHz)
	LTE Band 2	1850 ~ 1910	1930 ~ 1990
EUT Accessory			
Adapter	Manufacturer: AQUILSTAR PRECISION INDUSTRIAL (SHENZHEN) CO., LTD Model: ASSA65A-120100		
Network cable	Manufacturer: SHANGHAI JINGTU ELECTRONICS LTD. Model: UTP CAT5E		
Note: The information of the EUT is declared by the manufacturer.			



Item	WF831	WF831+	WF831A	GW631
Protocol Stack	The same	The same	The same	The same
MMS/STK	The same	The same	The same	The same
JAVA	The same	The same	The same	The same
Web User Interface page	The same	changes	changes	changes
HARDWARE	The same	The same	The same	The same
MECHANICAL	The same	The same	The same	The same
ACCESSORY	The same	The same	The same	The same

Note: Customer declaration, four models are the same, except for the logo and default parameters in the Web User Interface page, which will not affect the RF characteristic according to Part 2.1043 requirement. This report tested WF831.



3. Applied Standards

According to the specifications of the manufacturer, it must comply with the requirements of the following standards:

FCC CFR47 Part 2 (2017)

FCC CFR 47 Part 24E (2017)

ANSI/TIA-603-D (2010)

KDB 971168 D01 Power Meas License Digital Systems v03

4. Test Configuration

Radiated measurements are performed by rotating the EUT in three different orthogonal test planes. EUT stand-up position (Z axis), lie-down position (X, Y axis). Receiver antenna polarization (horizontal and vertical), the worst emission was found in position (Z axis, horizontal polarization) and the worst case was recorded.

All mode and data rates and positions and RB size and modulations were investigated.

Subsequently, only the worst case emissions are reported.

The following testing in LTE is set based on the maximum RF Output Power.

Test modes are chosen to be reported as the worst case configuration below for LTE Band 2:

Test items	Bandwidth (MHz)				Modulation		RB			Test Channel		
	5	10	15	20	QPSK	16QAM	1	50%	100%	L	M	H
RF power output	O	O	O	O	O	O	O	O	O	O	O	O
Effective Isotropic Radiated power	O	O	O	O	O	O	-	-	O	O	O	O
Occupied Bandwidth	O	O	O	O	O	O	-	-	O	O	O	O
Band Edge Compliance	O	O	O	O	O	O	O	-	O	O	-	O
Peak-to-Average Power Ratio	O	O	O	O	O	O	-	-	O	O	O	O
Frequency Stability	O	O	O	O	O	O	-	-	O	-	O	-
Conducted Spurious Emissions	O	O	O	O	O	-	O	-	-	O	O	O
Radiates Spurious Emission	O	O	O	O	O	-	O	-	-	O	O	O
Note	1. The mark "O" means that this configuration is chosen for testing. 2. The mark "-" means that this configuration is not testing.											

5. Test Case Results

5.1.RF Power Output

Ambient condition

Temperature	Relative humidity	Pressure
23°C ~25°C	45%~50%	101.5kPa

Methods of Measurement

During the process of the testing, The EUT is controlled by the Base Station Simulator to ensure max power transmission and proper modulation.

Test Setup



The loss between RF output port of the EUT and the input port of the tester has been taken into consideration.

Limits

No specific RF power output requirements in part 2.1046.

Measurement Uncertainty

The assessed measurement uncertainty to ensure 95% confidence level for the normal distribution is with the coverage factor $k = 2$, $U = 0.4$ dB.



Test Results

LTE Band 2				Conducted Power(dBm)		
Bandwidth	Modulation	RB size	RB offset	Channel/Frequency (MHz)		
				18625/1852.5	18900/1880	19175/1907.5
5MHz	QPSK	1	0	22.07	22.51	23.01
		1	13	22.30	22.53	23.00
		1	24	22.13	22.40	22.56
		12	0	21.63	21.86	22.34
		12	6	21.38	21.53	22.06
		12	13	21.36	21.59	22.13
		25	0	21.37	21.62	22.12
	16QAM	1	0	21.16	21.70	22.13
		1	13	21.26	21.84	22.12
		1	24	21.05	21.66	21.93
		12	0	20.53	21.07	21.45
		12	6	20.42	20.84	21.21
		12	13	20.23	20.70	21.02
		25	0	20.27	20.75	21.33
Bandwidth	Modulation	RB size	RB offset	Channel/Frequency (MHz)		
				18650/1855	18900/1880	19150/1905
10MHz	QPSK	1	0	22.53	22.88	23.12
		1	25	22.37	22.68	23.33
		1	49	22.58	22.61	22.90
		25	0	21.32	21.79	22.20
		25	13	21.53	21.79	22.37
		25	25	21.38	21.65	22.39
		50	0	21.44	21.71	22.35
	16QAM	1	0	21.62	22.48	22.15
		1	25	21.33	22.25	22.63
		1	49	21.74	22.21	22.23
		25	0	20.42	21.02	21.26
		25	13	20.53	20.87	21.47
		25	25	20.48	20.77	21.48
		50	0	20.46	20.86	21.41
Bandwidth	Modulation	RB size	RB offset	Channel/Frequency (MHz)		
				18675/1857.5	18900/1880	19125/1902.5
15MHz	QPSK	1	0	22.56	22.92	23.15
		1	38	22.38	22.72	23.35
		1	74	22.60	22.62	22.93



		36	0	21.35	21.84	22.24
		36	18	21.55	21.83	22.40
		36	39	21.41	21.70	22.43
		75	0	21.47	21.76	22.39
	16QAM	1	0	21.64	22.52	22.20
		1	38	21.37	22.27	22.67
		1	74	21.76	22.24	22.25
		36	0	20.45	21.06	21.29
		36	18	20.56	20.89	21.50
		36	39	20.51	20.82	21.52
		75	0	20.48	20.90	21.44
Bandwidth	Modulation	RB size	RB offset	Channel/Frequency (MHz)		
				18700/1860	18900/1880	19100/1900
20MHz	QPSK	1	0	22.70	23.21	22.86
		1	50	22.58	22.86	23.17
		1	99	23.01	22.68	22.85
		50	0	21.52	22.10	22.20
		50	25	21.58	21.93	22.35
		50	50	21.62	21.72	22.47
		100	0	21.63	21.92	22.18
	16QAM	1	0	22.01	22.57	22.08
		1	50	22.17	22.15	22.21
		1	99	22.45	21.87	22.31
		50	0	20.66	21.10	21.00
		50	25	20.69	21.25	21.43
		50	50	20.81	20.71	21.48
		100	0	20.71	20.99	21.18

5.2. Effective Isotropic Radiated Power

Ambient condition

Temperature	Relative humidity	Pressure
23°C ~25°C	45%~50%	101.5kPa

Methods of Measurement

1. The testing follows FCC KDB 971168 v03 Section 5.8 and ANSI/TIA-603-D-2010.

a) Connect the equipment as illustrated. Mount the equipment with the manufacturer specified antenna in a vertical orientation on a manufacturer specified mounting surface located on a non-conducting rotating platform of a RF anechoic chamber (preferred) or a standard radiation site.

b) Key the transmitter, then rotate the EUT 360° azimuthally and record spectrum analyzer power level (LVL) measurements at angular increments that are sufficiently small to permit resolution of all peaks. If a standard radiation test site is used, raise and lower the test antenna to obtain a maximum reading at each angular increment. (Note: several batteries may be needed to offset the effect of battery voltage droop, which should not exceed 5% of the manufactured specified battery voltage during transmission).

c) Replace the transmitter under test with a vertically polarized half-wave dipole (or an antenna whose gain is known relative to an ideal half-wave dipole). The center of the antenna should be at the same location as the center of the antenna under test.

d) Connect the antenna to a signal generator with a known output power and record the path loss (in dB) as LOSS. If a standard radiation test site is used, raise and lower the test antenna to obtain a maximum reading. $LOSS = \text{Generator Output Power (dBm)} - \text{Analyzer reading (dBm)}$

e) Determine the effective radiated output power at each angular position from the readings in steps b) and d) using the following equation: $ERP \text{ (dBm)} = \text{LVL (dBm)} + \text{LOSS (dB)}$

f) The maximum ERP is the maximum value determined in the preceding step.

g) When calculating ERP, in addition to knowing the antenna radiation and matching characteristics, it is necessary to know the loss values of all elements (e.g. transmission line attenuation, mismatches, filters, combiners) interposed between the point where transmitter output power is measured, and the point where power is applied to the antenna. ERP can then be calculated as follows:

$$ERP \text{ (dBm)} = \text{Output Power (dBm)} - \text{Losses (dB)} + \text{Antenna Gain (dBd)}$$

where: dBd refers to gain relative to an ideal dipole.

$$EIRP \text{ (dBm)} = ERP \text{ (dBm)} + 2.15 \text{ (dB)}$$

Test setup

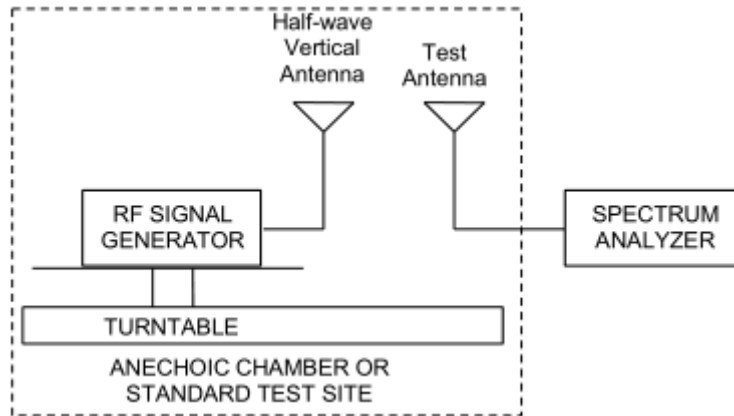
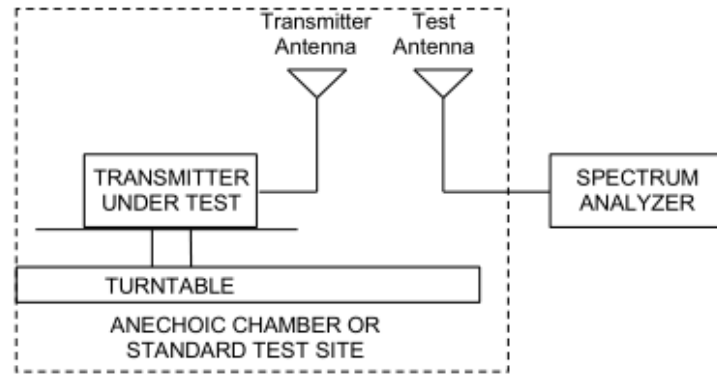

Limits

Rule Part 24.232(c) Mobile and portable stations are limited to 2 watts EIRP.

Rule Part 24.232(e) Peak transmit power must be measured over any interval of continuous transmission using instrumentation calibrated in terms of an rms-equivalent voltage.

Limit (EIRP)	$\leq 2 \text{ W}$ (33 dBm)
--------------	-----------------------------

Measurement Uncertainty

The assessed measurement uncertainty to ensure 95% confidence level for the normal distribution is with the coverage factor $k = 2$, $U = 1.19 \text{ dB}$

Test Results:

The measurement is performed for both of horizontal and vertical antenna Polarization, and only the data of worst mode is recorded in this report.

LTE Band 2									
bandwidth	Channel	Frequency (MHz)	Polarization	Output Power (dBm)	Losses (dB)	Antenna Gain (dBd)	EIRP (dBm)	Limit (dBm)	Conclusion
5 MHz (QPSK)	Low	1852.5	Horizontal	-33.57	-55.14	1.92	23.49	33	Pass
	Mid	1880	Horizontal	-33.73	-56.41	1.94	24.62	33	Pass
	High	1907.5	Horizontal	-33.91	-57.97	1.90	25.96	33	Pass
10 MHz (QPSK)	Low	1855	Horizontal	-33.32	-55.09	1.91	23.68	33	Pass
	Mid	1880	Horizontal	-33.43	-56.66	1.94	25.18	33	Pass
	High	1905	Horizontal	-33.88	-58.01	1.92	26.05	33	Pass
15 MHz (QPSK)	Low	1857.5	Horizontal	-33.65	-55.24	1.93	23.52	33	Pass
	Mid	1880	Horizontal	-32.94	-56.41	1.94	25.42	33	Pass
	High	1902.5	Horizontal	-34.19	-57.69	1.92	25.42	33	Pass
20 MHz (QPSK)	Low	1860	Horizontal	-33.54	-55.35	1.93	23.74	33	Pass
	Mid	1880	Horizontal	-32.95	-56.66	1.94	25.65	33	Pass
	High	1900	Horizontal	-35.13	-57.86	1.92	24.65	33	Pass
5 MHz (16QAM)	Low	1852.5	Horizontal	-33.69	-55.14	1.92	23.37	33	Pass
	Mid	1880	Horizontal	-33.84	-56.41	1.94	24.51	33	Pass
	High	1907.5	Horizontal	-34.02	-57.97	1.90	25.85	33	Pass
10 MHz (16QAM)	Low	1855	Horizontal	-33.44	-55.09	1.91	23.55	33	Pass
	Mid	1880	Horizontal	-33.55	-56.66	1.94	25.05	33	Pass
	High	1905	Horizontal	-34.00	-58.01	1.92	25.93	33	Pass
15 MHz (16QAM)	Low	1857.5	Horizontal	-33.77	-55.24	1.93	23.40	33	Pass
	Mid	1880	Horizontal	-33.06	-56.41	1.94	25.29	33	Pass
	High	1902.5	Horizontal	-34.31	-57.69	1.92	25.30	33	Pass
20 MHz (16QAM)	Low	1860	Horizontal	-33.66	-55.35	1.93	23.62	33	Pass
	Mid	1880	Horizontal	-33.07	-56.66	1.94	25.53	33	Pass
	High	1900	Horizontal	-35.25	-57.86	1.92	24.53	33	Pass

5.3.Occupied Bandwidth

Ambient condition

Temperature	Relative humidity	Pressure
23°C ~25°C	45%~50%	101.5kPa

Method of Measurement

The EUT was connected to Spectrum Analyzer and Base Station Simulator via power Splitter. The occupied bandwidth is measured using spectrum analyzer.

RBW is set to 100kHz,VBW is set to 300kHz for LTE Band 2 (5MHz),

RBW is set to 300kHz,VBW is set to 1MHz for LTE Band 2 (10MHz/15MHz/20MHz).

99% power and -26dBc occupied bandwidths are recorded. Spectrum analyzer plots are included on the following pages.

Test Setup

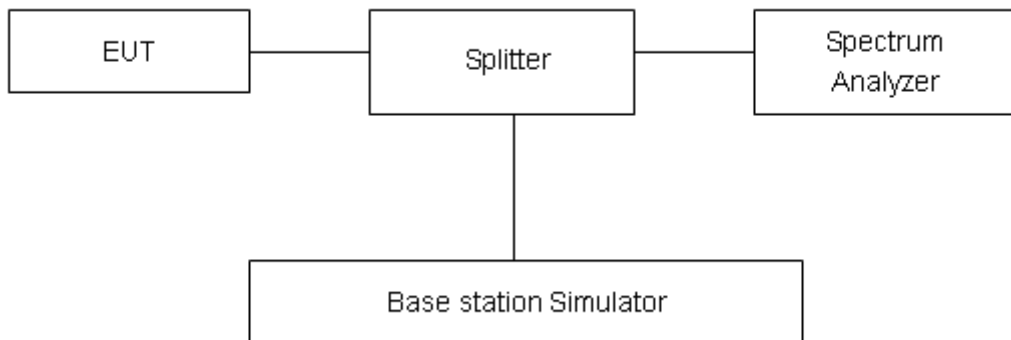

Limits

No specific occupied bandwidth requirements in part 2.1049.

Measurement Uncertainty

The assessed measurement uncertainty to ensure 95% confidence level for the normal distribution is with the coverage factor $k = 2$, $U = 624\text{Hz}$.

Test Result

LTE Band 2					
Modulation	Bandwidth (MHz)	Channel	Frequency (MHz)	99% Power Bandwidth(MHz)	-26dBc Bandwidth(MHz)
QPSK	5	18625	1852.5	4.5342	5.288
		18900	1880	4.5572	5.434
		19175	1907.5	4.5419	5.376
	10	18650	1855	9.0459	10.21
		18900	1880	9.0783	10.32
		19150	1905	9.0384	10.25
	15	18675	1857.5	13.437	14.71
		18900	1880	13.526	14.92
		19125	1902.5	13.421	14.68
	20	18700	1860	17.875	19.21
		18900	1880	17.924	19.17
		19100	1900	17.812	19.14
16QAM	5	18625	1852.5	4.5664	5.435
		18900	1880	4.5451	5.274
		19175	1907.5	4.5710	5.387
	10	18650	1855	9.0586	10.24
		18900	1880	9.0689	10.19
		19150	1905	9.0295	10.17
	15	18675	1857.5	13.482	14.74
		18900	1880	13.520	14.76
		19125	1902.5	13.435	14.64
	20	18700	1860	17.896	19.30
		18900	1880	17.961	19.24
		19100	1900	17.779	19.07

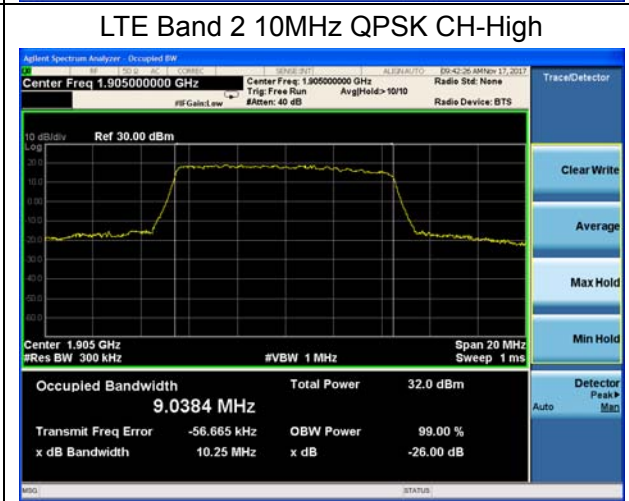
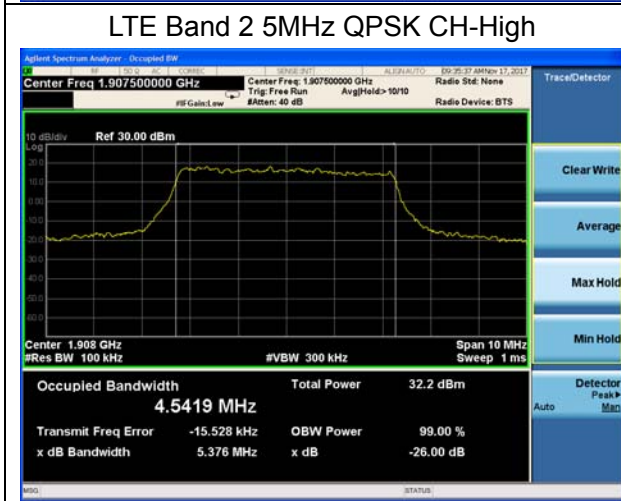
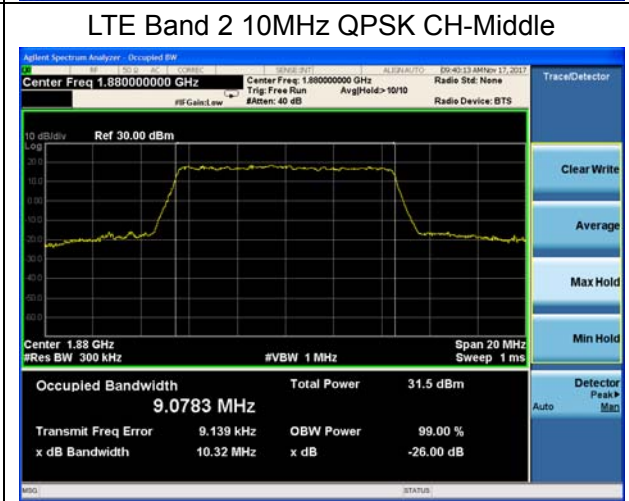
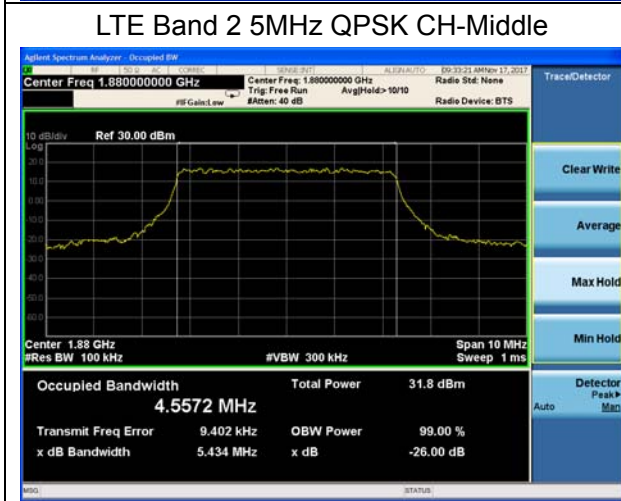
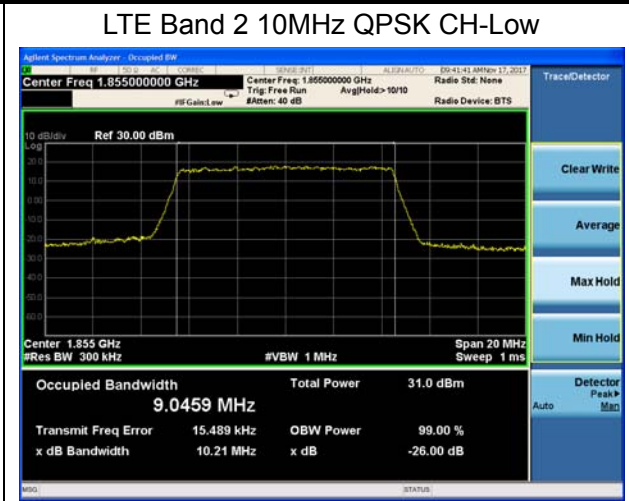
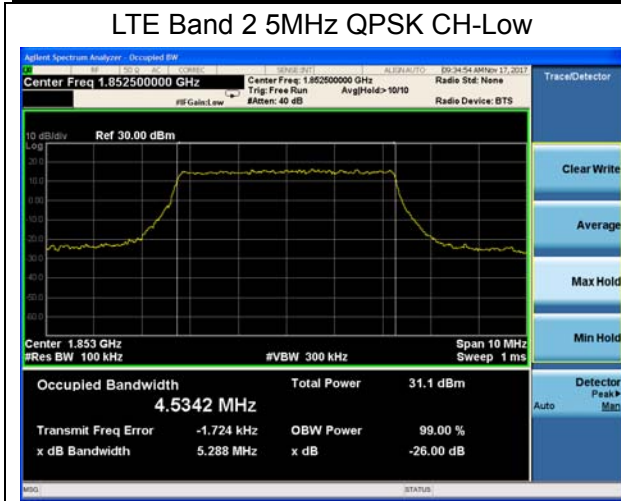

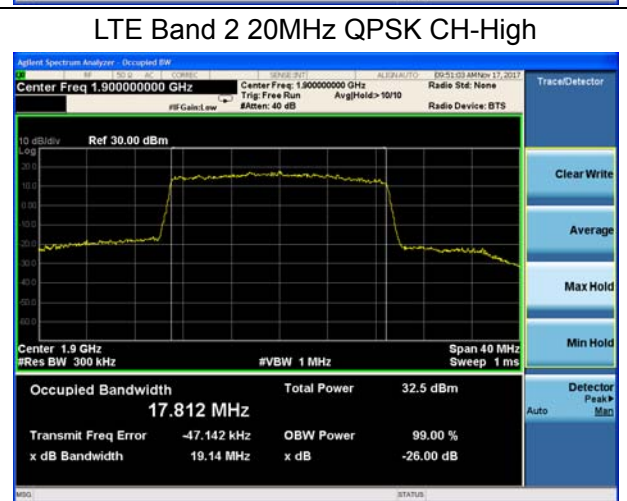
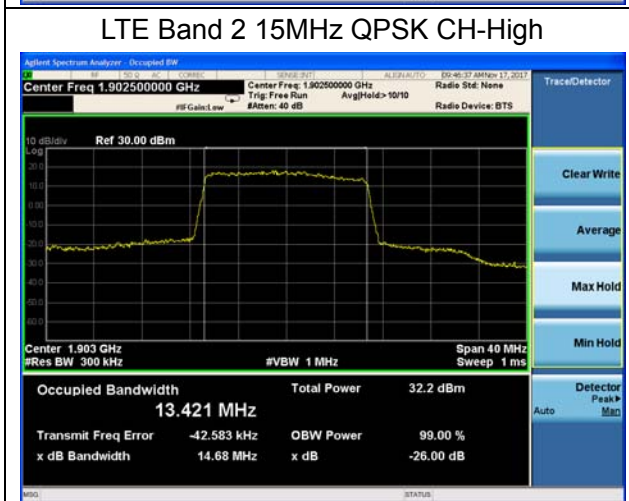
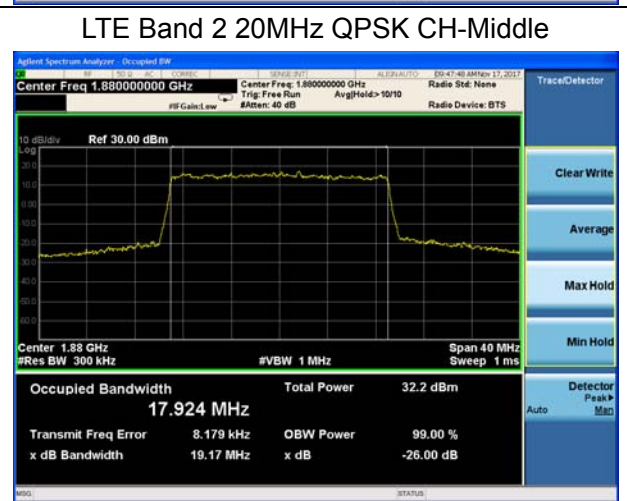
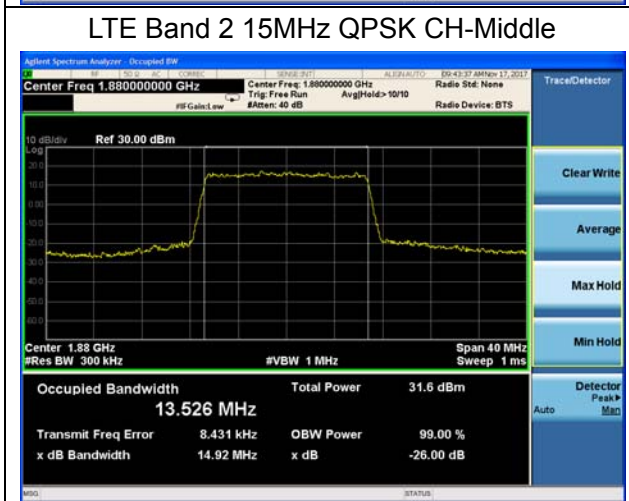
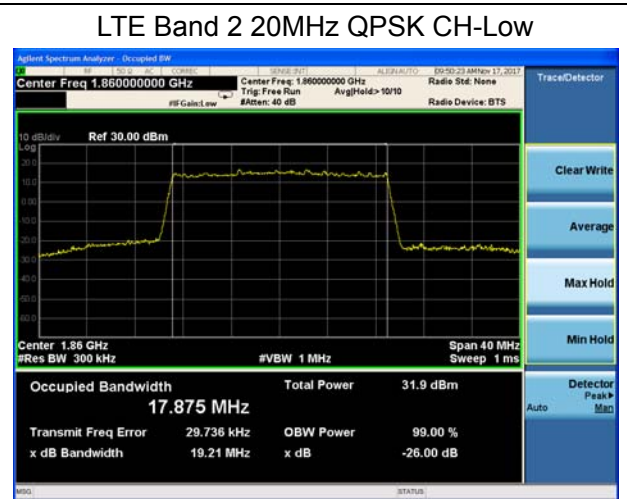
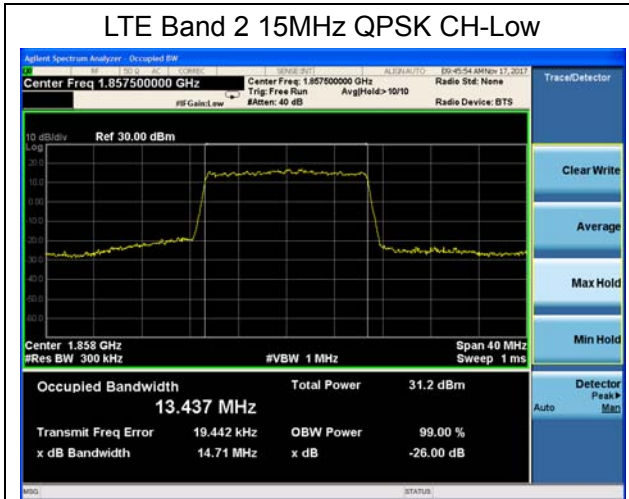

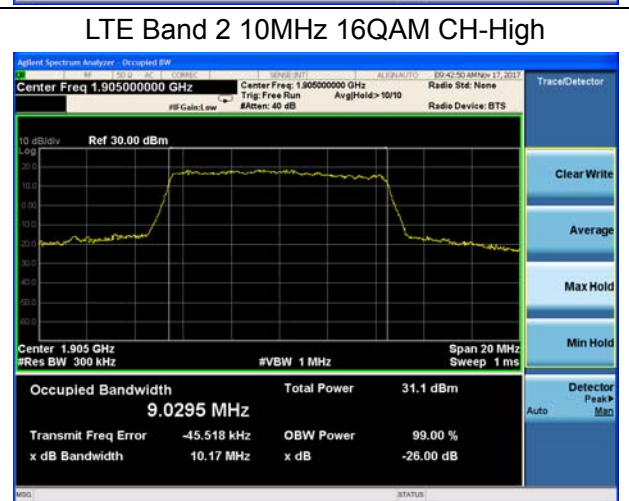
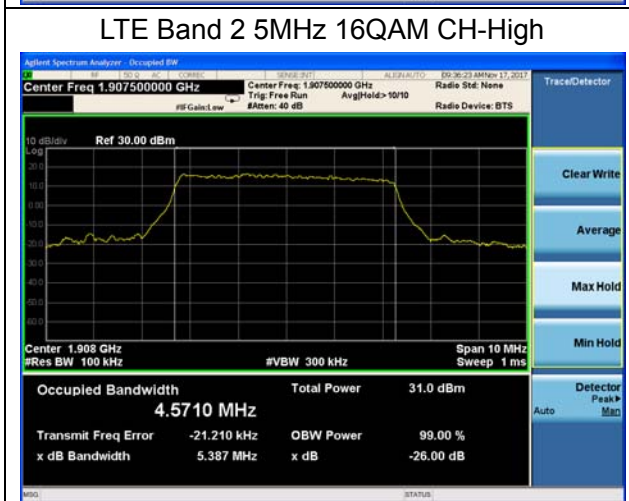
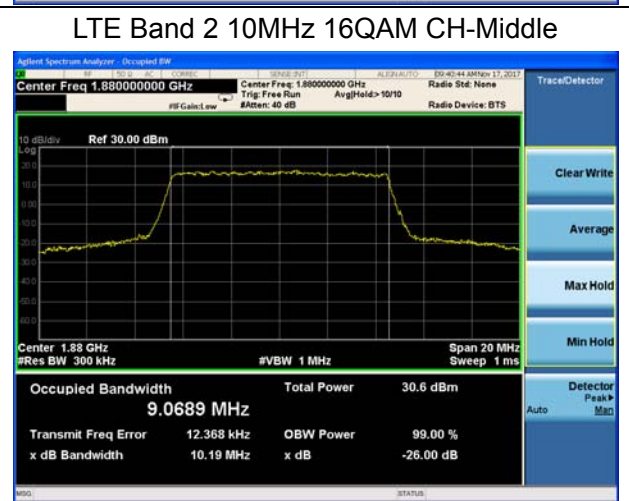
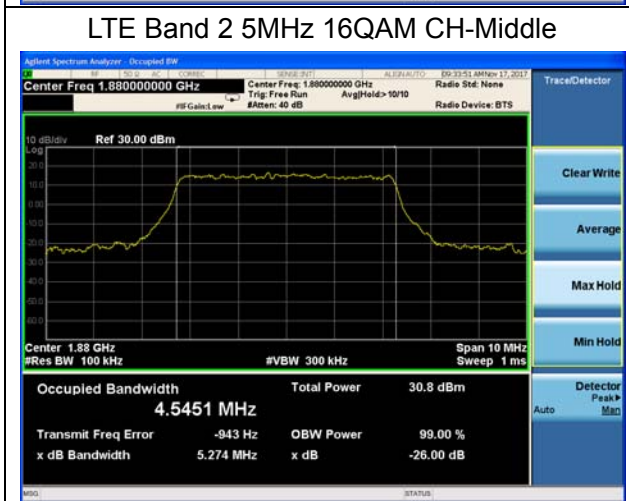
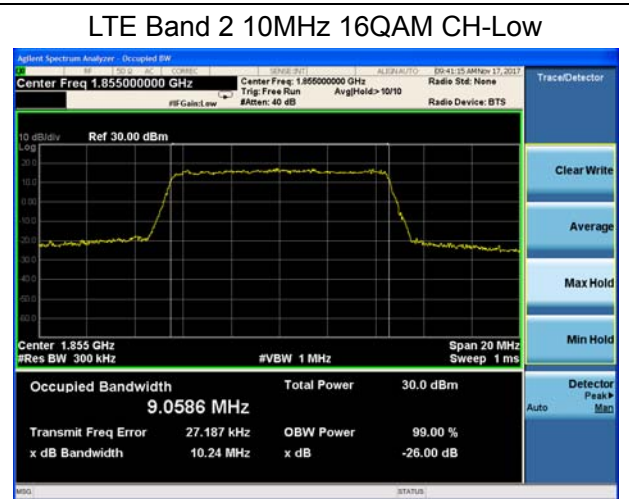
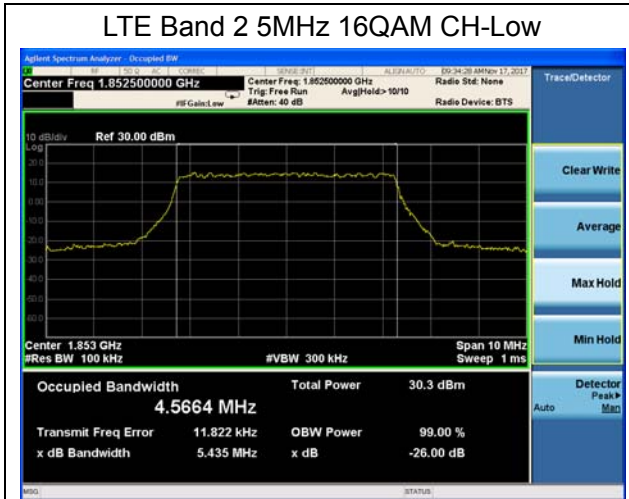

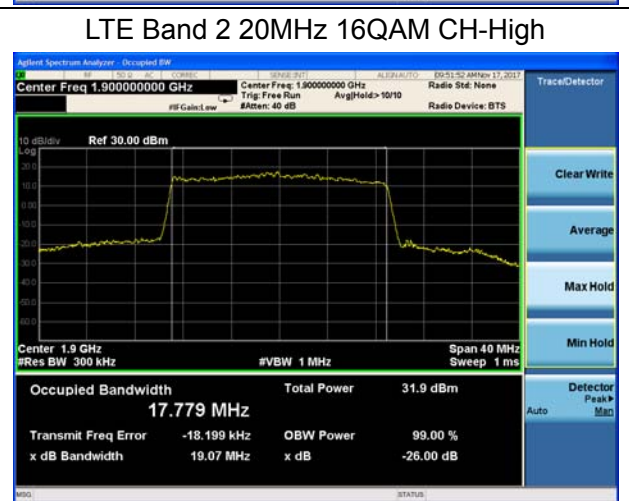
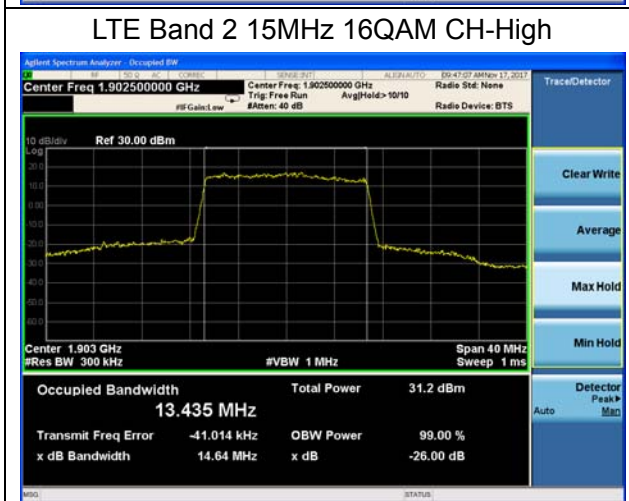
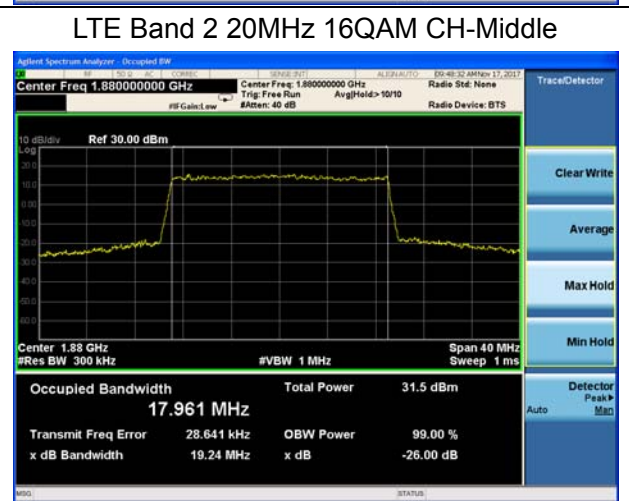
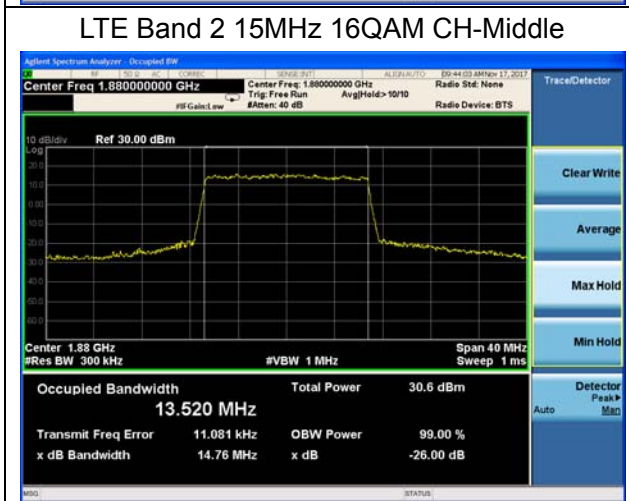
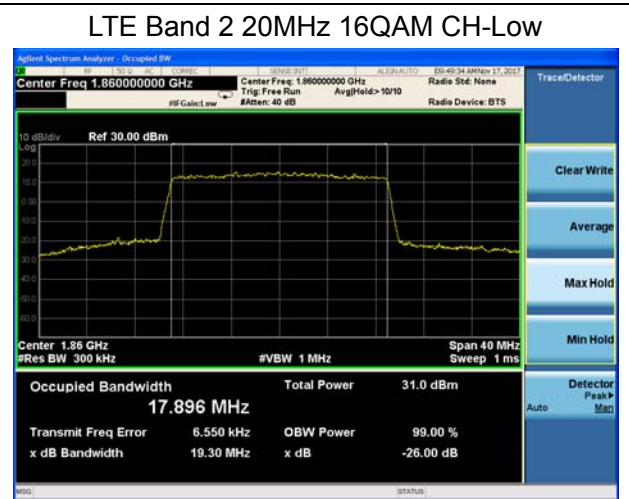
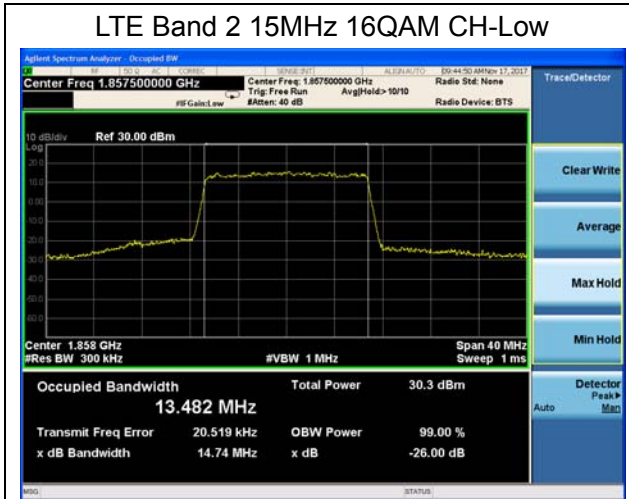

5.4. Band Edge Compliance

Ambient condition

Temperature	Relative humidity	Pressure
23°C ~25°C	45%~50%	101.5kPa

Method of Measurement

The EUT was connected to Spectrum Analyzer and Base Station Simulator via power Splitter. The band edge of the lowest and highest channels were measured. The Average detector is used and RBW is set to 51kHz,VBW is set to 160kHz for LTE Band 2 (5MHz), RBW is set to 100kHz,VBW is set to 300kHz for LTE Band 2 (10MHz), RBW is set to 150kHz,VBW is set to 510kHz for LTE Band 2 (15MHz), RBW is set to 200kHz,VBW is set to 620kHz for LTE Band 2 (20MHz). Spectrum analyzer plots are included on the following pages.

Test Setup

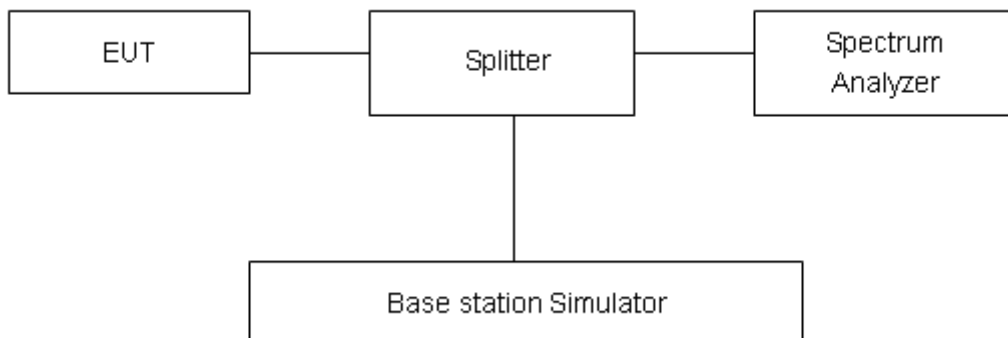

Limits

Rule Part 24.238(a) specifies that “on any frequency outside a licensee’s frequency block, the power of any emission shall be attenuated below the transmitter power (P) by at least 43 + 10 log₁₀ (P) dB.”

Limit	-13 dBm
-------	---------

Measurement Uncertainty

The assessed measurement uncertainty to ensure 95% confidence level for the normal distribution is with the coverage factor $k = 1.96$, $U=0.684$ dB.



Test Result:

LTE Band 2 5MHz QPSK 1RB CH-Low

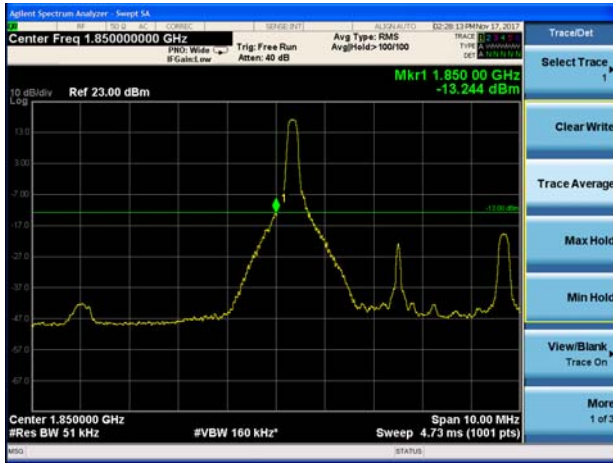

LTE Band 2 5MHz QPSK 1RB CH-High

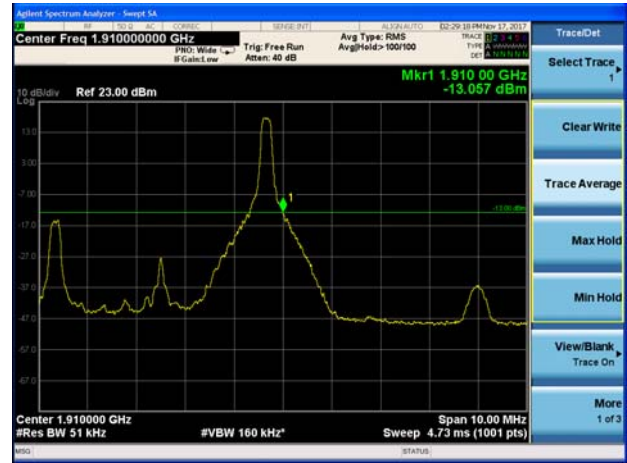

LTE Band 2 5MHz QPSK 100%RB CH-Low



LTE Band 2 5MHz QPSK 100%RB CH-High



LTE Band 2 10MHz QPSK 1RB CH-Low

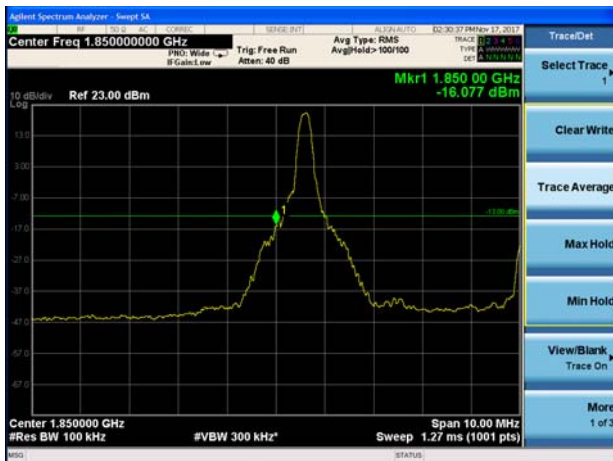

LTE Band 2 10MHz QPSK 1RB CH-High

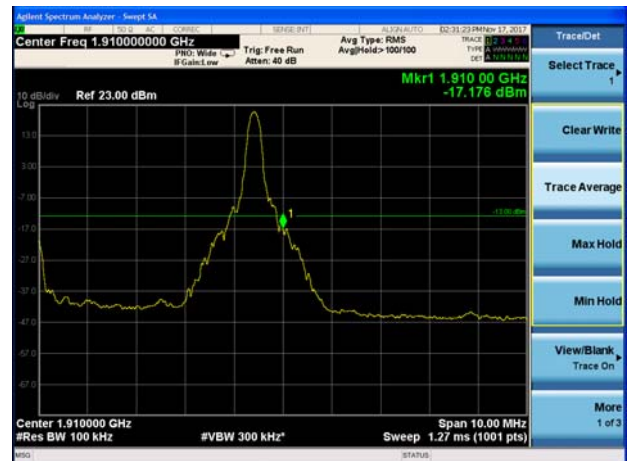



LTE Band 2 10MHz QPSK 100%RB CH-Low

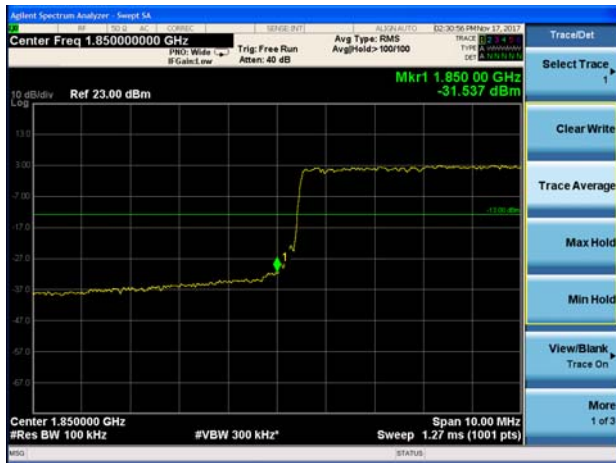

LTE Band 2 10MHz QPSK 100%RB CH-High



LTE Band 2 15MHz QPSK 1RB CH-Low

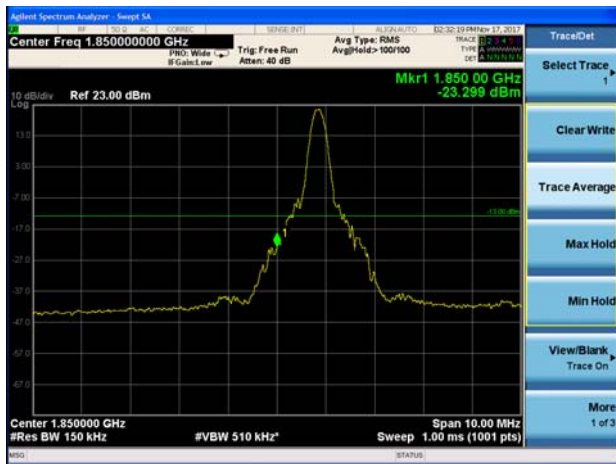

LTE Band 2 15MHz QPSK 1RB CH-High



LTE Band 2 15MHz QPSK 100%RB CH-Low

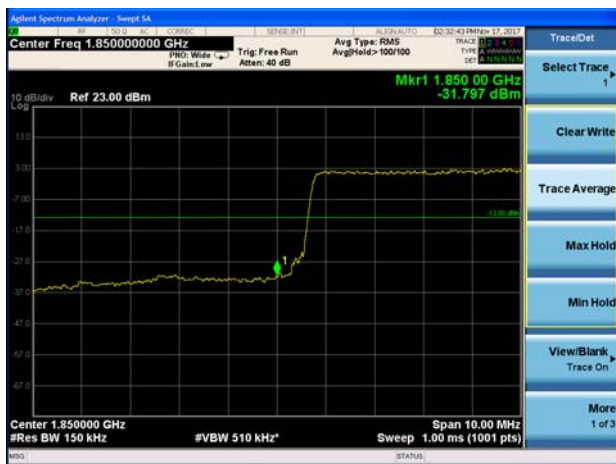

LTE Band 2 15MHz QPSK 100%RB CH-High





LTE Band 2 20MHz QPSK 1RB CH-Low

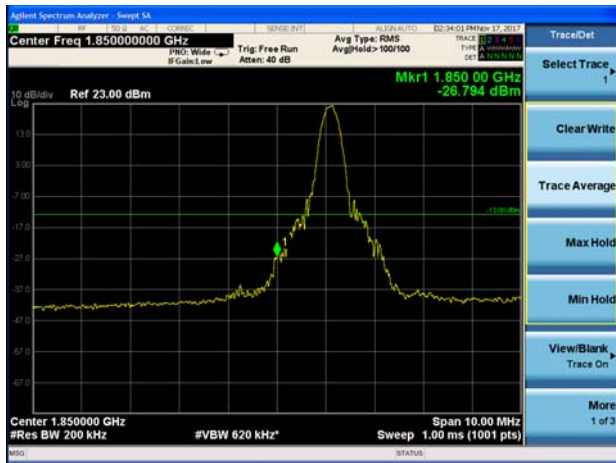

LTE Band 2 20MHz QPSK 1RB CH-High

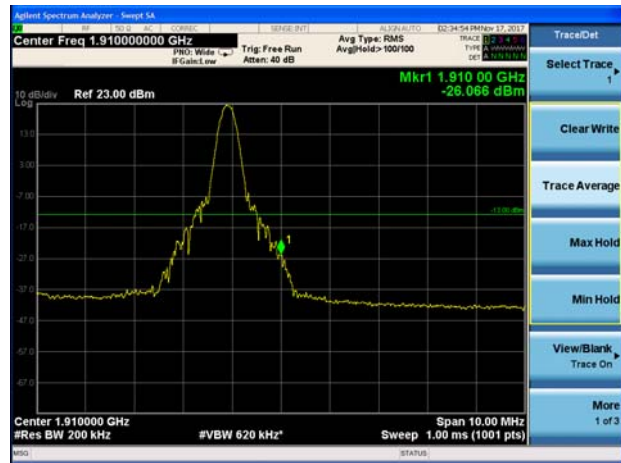

LTE Band 2 20MHz QPSK 100%RB CH-Low

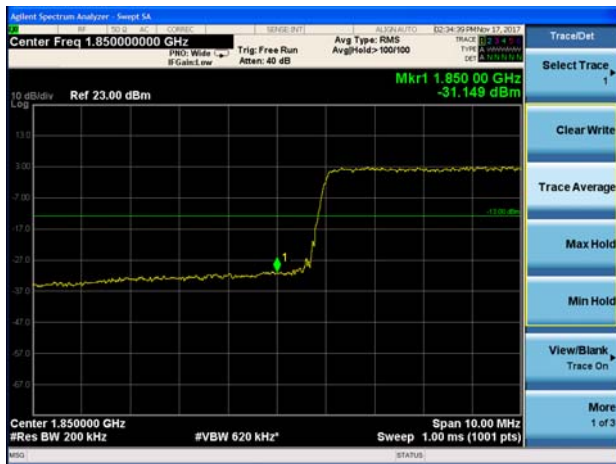

LTE Band 2 20MHz QPSK 100%RB CH-High



LTE Band 2 5MHz 16QAM 1RB CH-Low

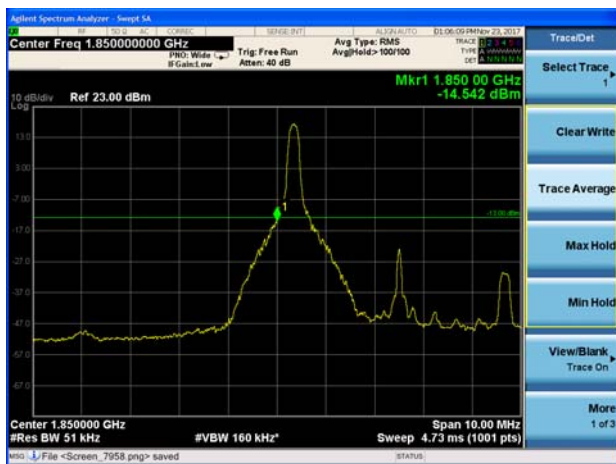

LTE Band 2 5MHz 16QAM 1RB CH-High

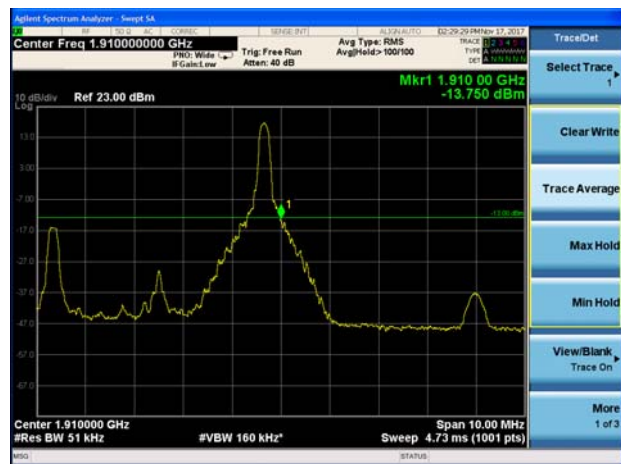



LTE Band 2 5MHz 16QAM 100%RB CH-Low

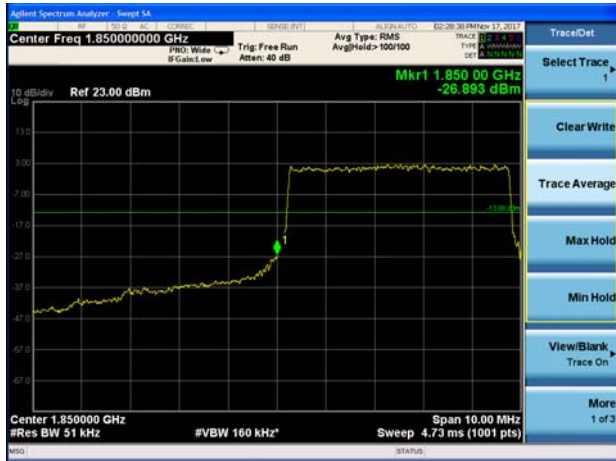

LTE Band 2 5MHz 16QAM 100%RB CH-High



LTE Band 2 10MHz 16QAM 1RB CH-Low

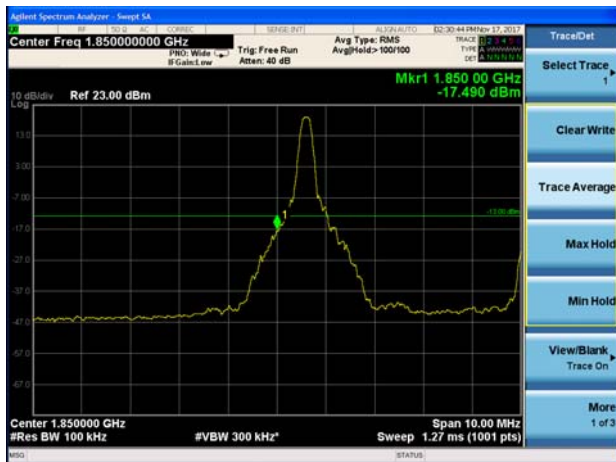

LTE Band 2 10MHz 16QAM 1RB CH-High

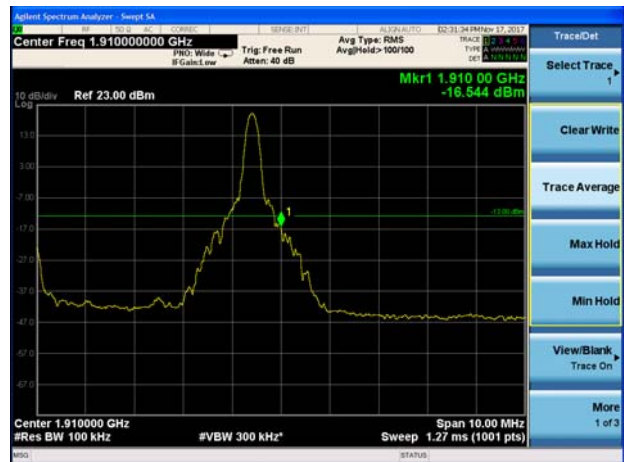

LTE Band 2 10MHz 16QAM 100%RB CH-Low

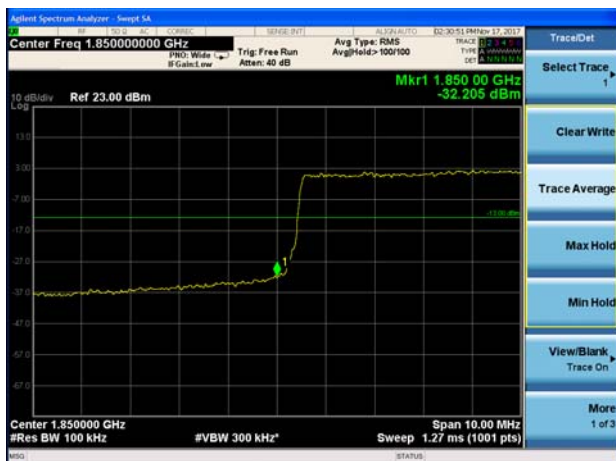

LTE Band 2 10MHz 16QAM 100%RB CH-High



LTE Band 2 15MHz 16QAM 1RB CH-Low



LTE Band 2 15MHz 16QAM 1RB CH-High

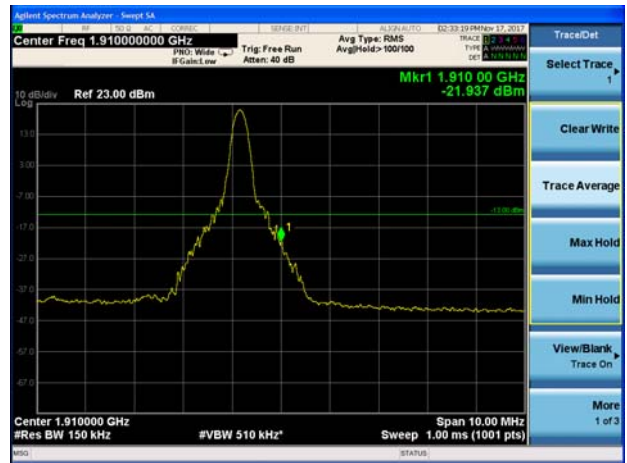

LTE Band 2 15MHz 16QAM 100%RB CH-Low



LTE Band 2 15MHz 16QAM 100%RB CH-High



LTE Band 2 20MHz 16QAM 1RB CH-Low

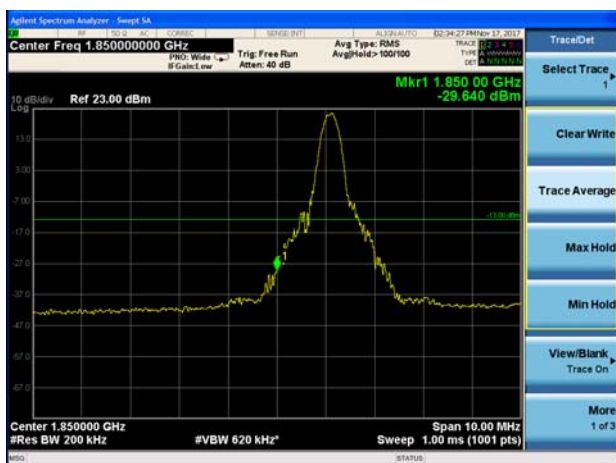

LTE Band 2 20MHz 16QAM 1RB CH-High

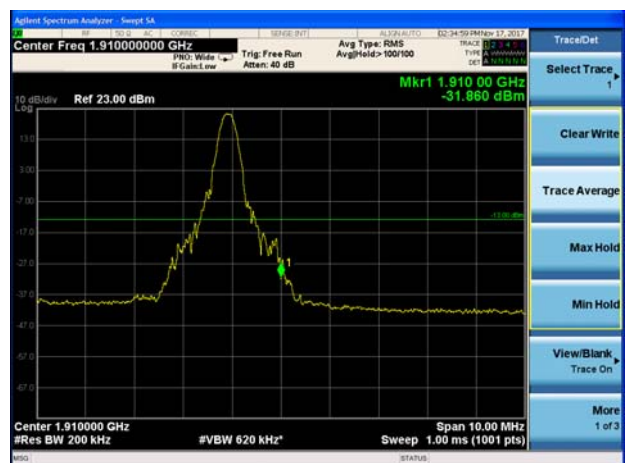



LTE Band 2 20MHz 16QAM 100%RB CH-Low



LTE Band 2 20MHz 16QAM 100%RB CH-High

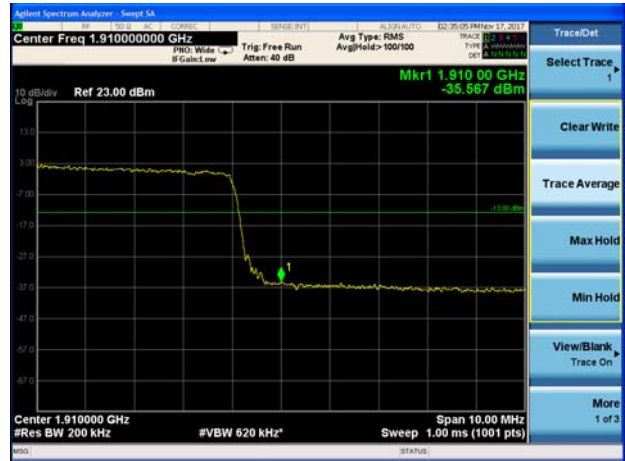

5.5. Peak-to-Average Power Ratio (PAPR)

Ambient condition

Temperature	Relative humidity	Pressure
23°C ~25°C	45%~50%	101.5kPa

Methods of Measurement

Measure the total peak power and record as PPk. And measure the total average power and record as PAvg. Both the peak and average power levels must be expressed in the same logarithmic units (e.g., dBm). Determine the PAPR from:

$$PAPR (dB) = PPk (dBm) - PAvg (dBm).$$

Test Setup

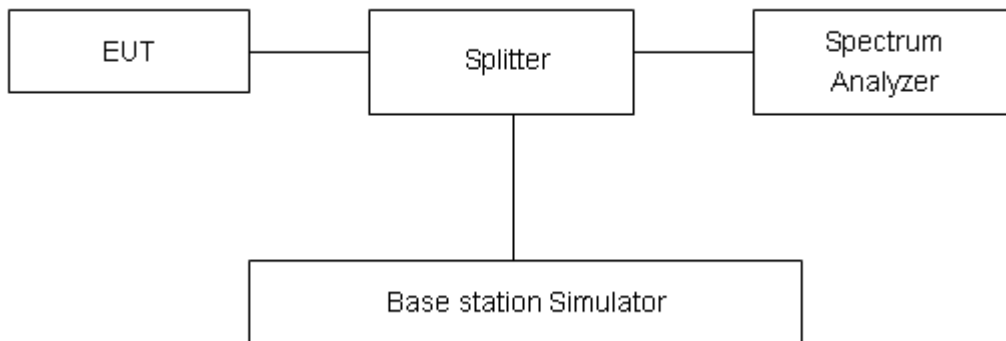

Limits

In measuring transmissions in this band using an average power technique, the peak-to-average ratio (PAR) of the transmission may not exceed 13 dB in 24.232(d).

Measurement Uncertainty

The assessed measurement uncertainty to ensure 95% confidence level for the normal distribution is with the coverage factor $k = 2$, $U = 0.4$ dB.



Test Results

LTE Band 2								
Modulation	Bandwidth	Channel	Frequency (MHz)	Peak (dBm)	Avg (dBm)	PAPR (dB)	Limit(dB)	Conclusion
QPSK	5MHz	18625	1852.5	27.00	21.37	5.63	≤13	PASS
		18900	1880	26.91	21.62	5.29	≤13	PASS
		19175	1907.5	27.19	22.12	5.07	≤13	PASS
	10MHz	18650	1855	27.01	21.44	5.57	≤13	PASS
		18900	1880	26.96	21.71	5.25	≤13	PASS
		19150	1905	27.45	22.35	5.10	≤13	PASS
	15MHz	18675	1857.5	27.27	21.47	5.80	≤13	PASS
		18900	1880	27.24	21.76	5.48	≤13	PASS
		19125	1902.5	27.74	22.39	5.35	≤13	PASS
	20MHz	18700	1860	26.99	21.63	5.36	≤13	PASS
		18900	1880	27.16	21.92	5.24	≤13	PASS
		19100	1900	27.19	22.18	5.01	≤13	PASS
16QAM	5MHz	18625	1852.5	26.62	20.27	6.35	≤13	PASS
		18900	1880	26.65	20.75	5.90	≤13	PASS
		19175	1907.5	27.12	21.33	5.79	≤13	PASS
	10MHz	18650	1855	26.83	20.46	6.37	≤13	PASS
		18900	1880	26.77	20.86	5.91	≤13	PASS
		19150	1905	27.33	21.41	5.92	≤13	PASS
	15MHz	18675	1857.5	26.81	20.48	6.33	≤13	PASS
		18900	1880	26.84	20.90	5.94	≤13	PASS
		19125	1902.5	27.41	21.44	5.97	≤13	PASS
	20MHz	18700	1860	26.92	20.71	6.21	≤13	PASS
		18900	1880	26.92	20.99	5.93	≤13	PASS
		19100	1900	27.10	21.18	5.92	≤13	PASS

5.6. Frequency Stability

Ambient condition

Temperature	Relative humidity	Pressure
23°C ~25°C	45%~50%	101.5kPa

Method of Measurement

1. Frequency Stability (Temperature Variation)

The temperature inside the climate chamber is varied from -30°C to +50°C in 10°C step size,

(1) With all power removed, the temperature was decreased to 0°C and permitted to stabilize for three hours.

(2) Measure the carrier frequency with the test equipment in a “call mode”. These measurements should be made within 1 minute of powering up the mobile station, to prevent significant self warming.

(3) Repeat the above measurements at 10°C increments from -30°C to +50°C. Allow at least 1.5 hours at each temperature, un-powered, before making measurements.

2. Frequency Stability (Voltage Variation)

The frequency stability shall be measured with variation of primary supply voltage as follows:

(1) Vary primary supply voltage from 85 to 115 percent of the nominal value for other than hand carried battery equipment.

(2) For hand carried, battery powered equipment, reduce primary supply voltage to the battery-operating end point which shall be specified by the manufacturer.

This transceiver is specified to operate with an input voltage of between 9V and 13V, with a nominal voltage of 12V.

Test setup

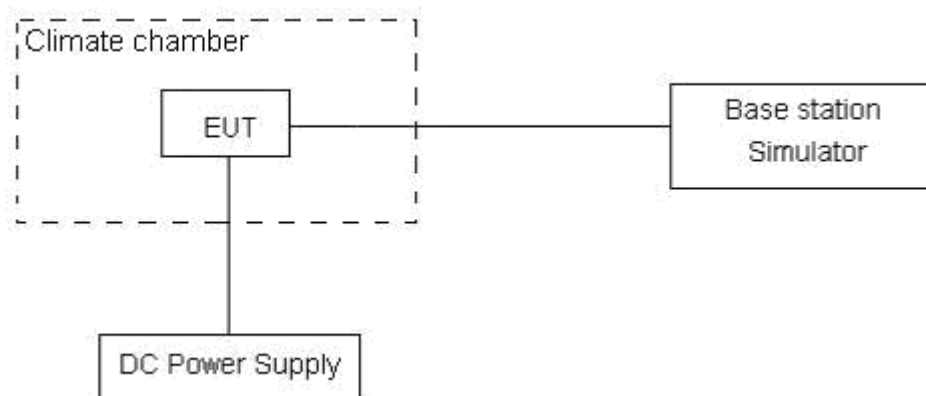



Limits

No specific frequency stability requirements in part 24.235

Measurement Uncertainty

The assessed measurement uncertainty to ensure 99.75% confidence level for the normal distribution is with the coverage factor $k = 3$, $U = 0.01\text{ppm}$.



Test Result

Bandwidth	Test status	LTE Band 2 Middle Channel Test Results (ppm)	
		QPSK	16QAM
5MHz	-30°C/Normal Voltage	-0.00256	0.00543
	-20°C/Normal Voltage	-0.00104	0.00255
	-10°C/Normal Voltage	0.00900	0.00635
	0°C/Normal Voltage	-0.00145	-0.00215
	10°C/Normal Voltage	0.00058	0.00828
	20°C/Normal Voltage	-0.00877	0.00311
	30°C/Normal Voltage	0.00031	-0.00059
	40°C/Normal Voltage	-0.00007	-0.00942
	50°C/Normal Voltage	-0.00191	0.00784
	20°C/Min Voltage	0.00062	-0.00093
	20°C/Max Voltage	0.00367	0.00769
10MHz	-30°C/Normal Voltage	0.00387	0.00801
	-20°C/Normal Voltage	-0.00412	-0.00023
	-10°C/Normal Voltage	-0.01056	-0.00116
	0°C/Normal Voltage	0.00253	-0.00368
	10°C/Normal Voltage	-0.00153	0.01083
	20°C/Normal Voltage	-0.00498	-0.00509
	30°C/Normal Voltage	-0.00787	0.00432
	40°C/Normal Voltage	0.00295	-0.00529
	50°C/Normal Voltage	-0.00181	-0.00513
	20°C/Min Voltage	-0.00120	-0.01159
	20°C/Max Voltage	0.00465	0.00170
15MHz	-30°C/Normal Voltage	-0.00488	-0.00107
	-20°C/Normal Voltage	0.00128	-0.00845
	-10°C/Normal Voltage	-0.00086	-0.00267
	0°C/Normal Voltage	0.00428	0.00138
	10°C/Normal Voltage	-0.00876	0.00618
	20°C/Normal Voltage	0.00274	-0.00874
	30°C/Normal Voltage	0.00217	-0.00926
	40°C/Normal Voltage	0.01020	-0.00261
	50°C/Normal Voltage	-0.00946	-0.00790
	20°C/Min Voltage	-0.00639	0.00004
	20°C/Max Voltage	-0.00652	0.00458
20MHz	-30°C/Normal Voltage	-0.00020	0.00693
	-20°C/Normal Voltage	-0.00224	-0.00165
	-10°C/Normal Voltage	-0.00280	-0.00638



	0°C/Normal Voltage	0.00129	-0.00714
	10°C/Normal Voltage	-0.00466	-0.00567
	20°C/Normal Voltage	-0.00972	-0.00090
	30°C/Normal Voltage	0.00027	-0.00350
	40°C/Normal Voltage	0.00216	-0.00684
	50°C/Normal Voltage	0.00301	-0.00631
	20°C/Min Voltage	0.00362	-0.00702
	20°C/Max Voltage	0.00435	-0.00359

5.7. Spurious Emissions at Antenna Terminals

Ambient condition

Temperature	Relative humidity	Pressure
23°C ~25°C	45%~50%	101.5kPa

Method of Measurement

The EUT was connected to Spectrum Analyzer and Base Station Simulator via power Splitter. The measurement is carried out using a spectrum analyzer. The spectrum analyzer scans from 9kHz to the 10th harmonic of the carrier. The peak detector is used.set RBW 1MHz and VBW is 3MHz, Sweep is set to ATUO.

Test setup

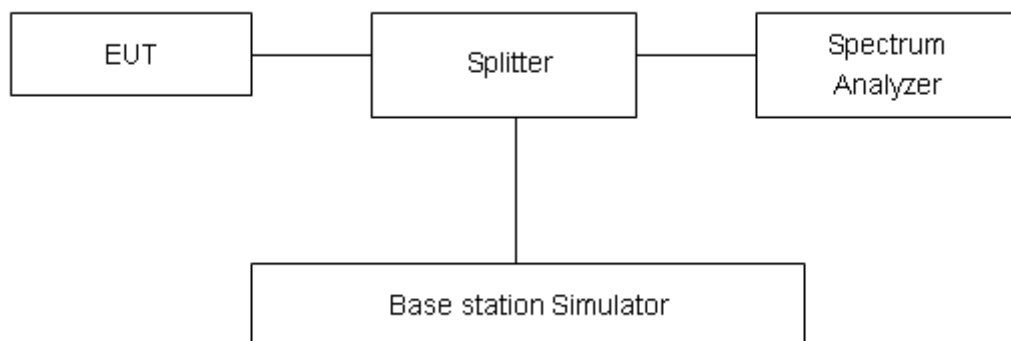

Limits

Rule Part 24.238(a) specifies that “on any frequency outside a licensee’s frequency block, the power of any emission shall be attenuated below the transmitter power (P) by at least 43 + 10 log₁₀ (P) dB.”

Limit	-13 dBm
-------	---------

Measurement Uncertainty

The assessed measurement uncertainty to ensure 99.75% confidence level for the normal distribution is with the coverage factor $k = 1.96$.

Frequency	Uncertainty
100kHz-2GHz	0.684 dB
2GHz-18GHz	1.407 dB

Test Result

Sweep from 9 kHz to 30MHz, and the emissions more than 20 dB below the permissible value are not reported.

If disturbances were found more than 20dB below limit line, the mark is not required for the EUT.

The signal beyond the limit is carrier.

LTE Band 2 5MHz CH-Low 30MHz~3GHz

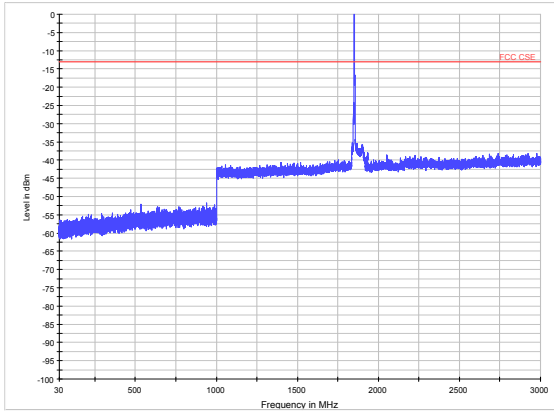

LTE Band 2 5MHz CH-Middle 30MHz~3GHz

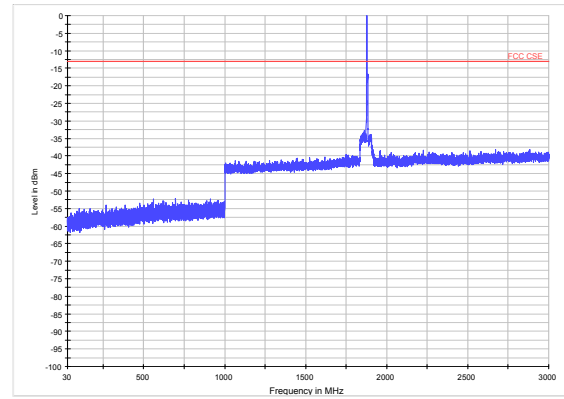

LTE Band 2 5MHz CH-Low 3GHz~18GHz

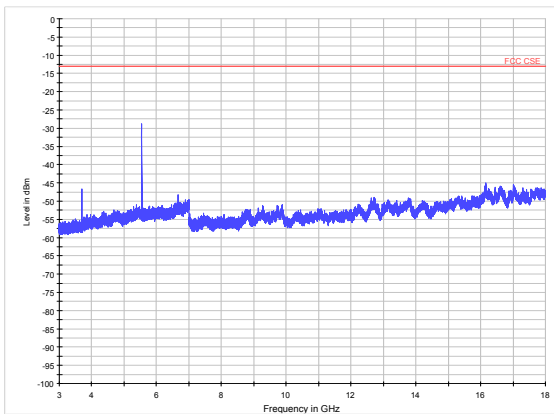

LTE Band 2 5MHz CH-Middle 3GHz~18GHz

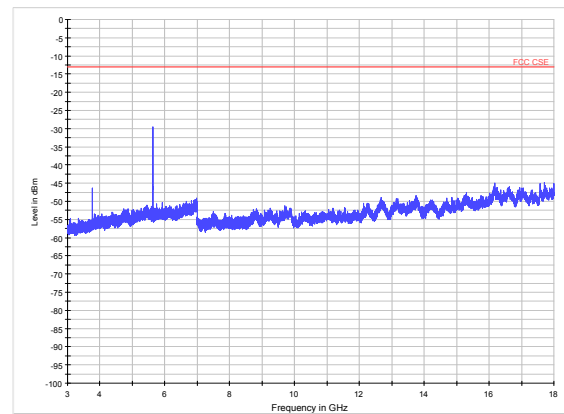

LTE Band 2 5MHz CH-Low 18GHz~20GHz

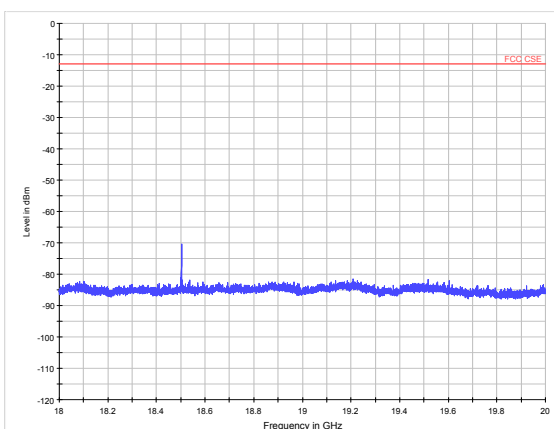

LTE Band 2 5MHz CH-Middle 18GHz~20GHz

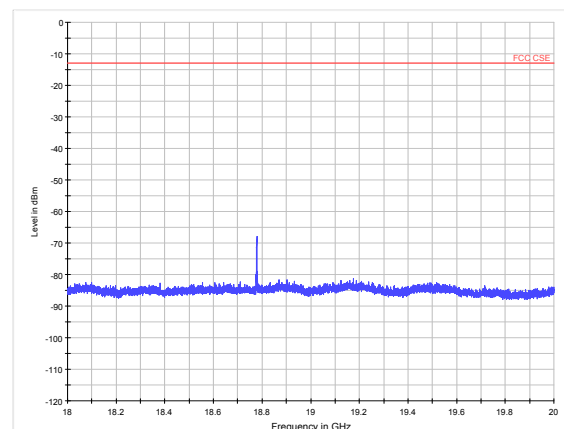



LTE Band 2 5MHz CH-High 30MHz~3GHz

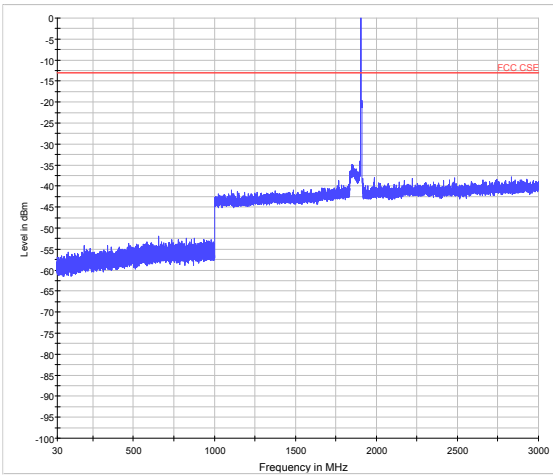

LTE Band 2 10MHz CH-Low 30MHz~3GHz

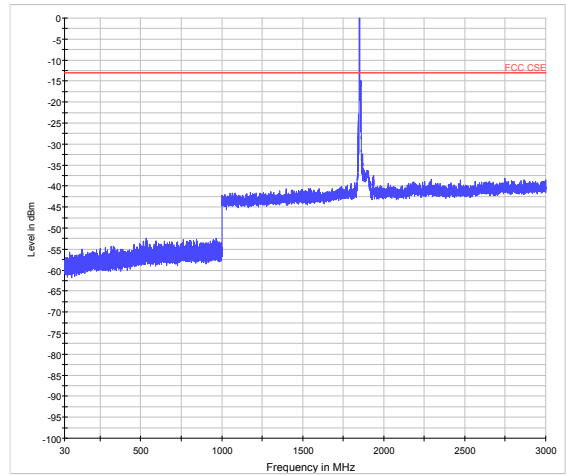

LTE Band 2 5MHz CH-High 3GHz~18GHz

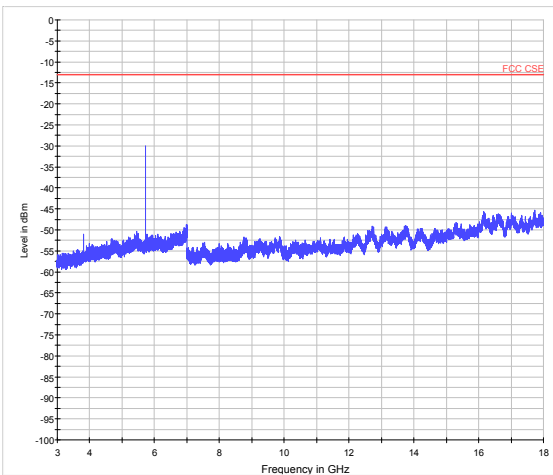

LTE Band 2 10MHz CH-Low 3GHz~18GHz

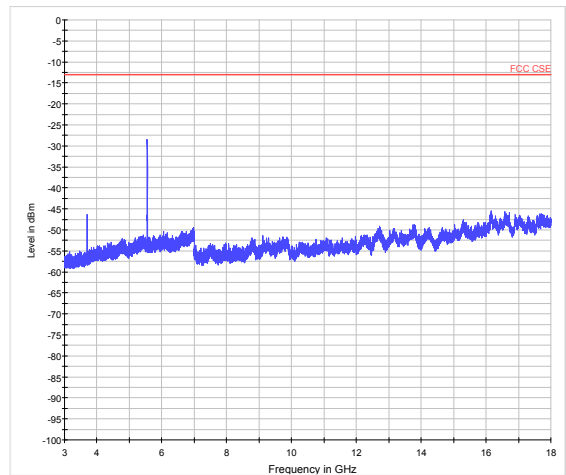

LTE Band 2 5MHz CH-High 18GHz~20GHz

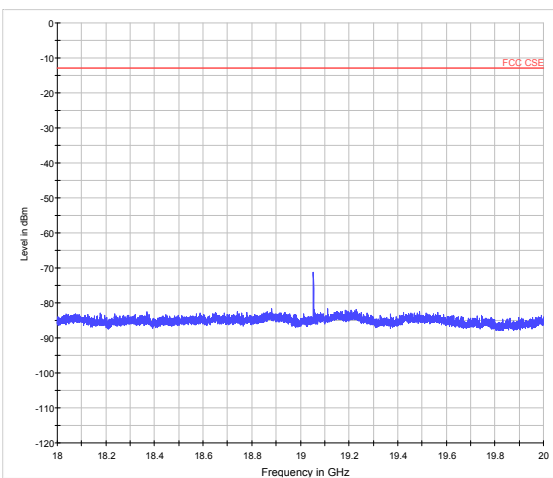

LTE Band 2 10MHz CH-Low 18GHz~20GHz

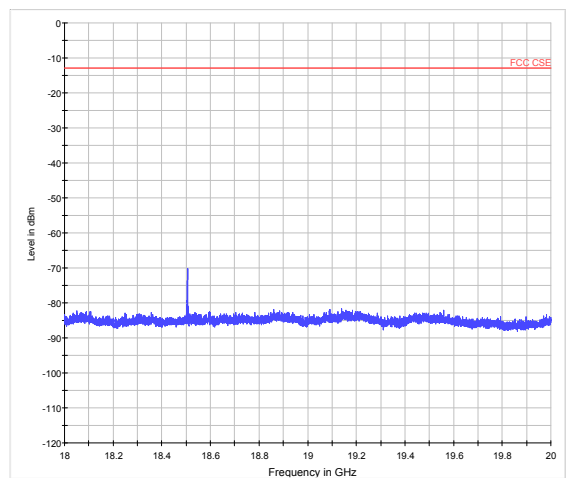



LTE Band 2 10MHz CH-Middle 30MHz~3GHz

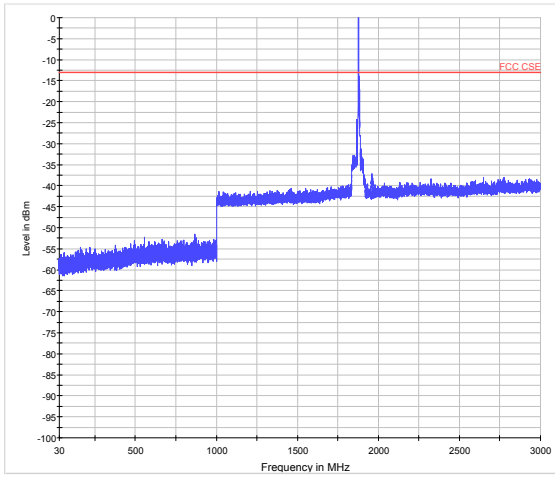

LTE Band 2 10MHz CH-High 30MHz~3GHz

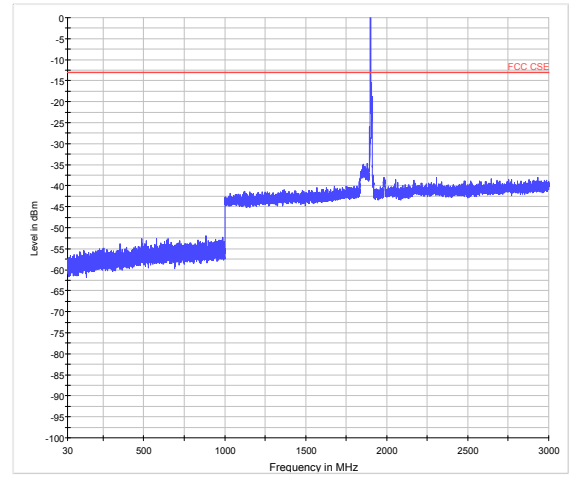

LTE Band 2 10MHz CH-Middle 3GHz~18GHz

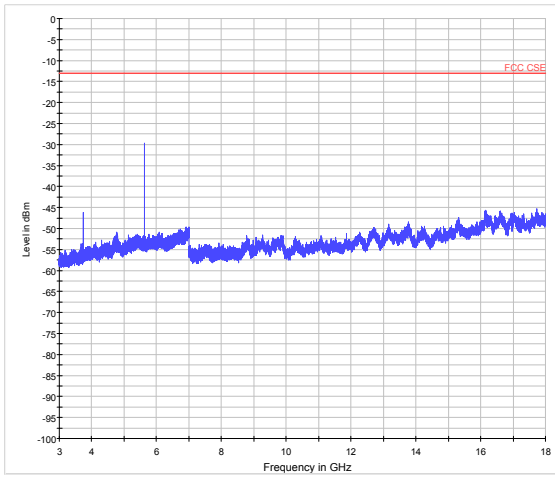

LTE Band 2 10MHz CH-High 3GHz~18GHz

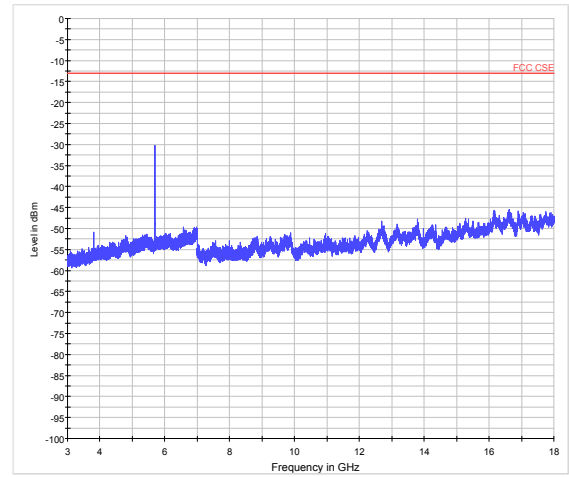

LTE Band 2 10MHz CH-Middle 18GHz~20GHz

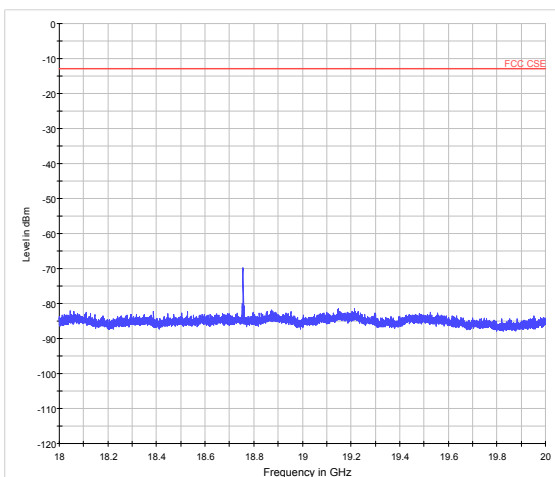

LTE Band 2 10MHz CH-High 18GHz~20GHz

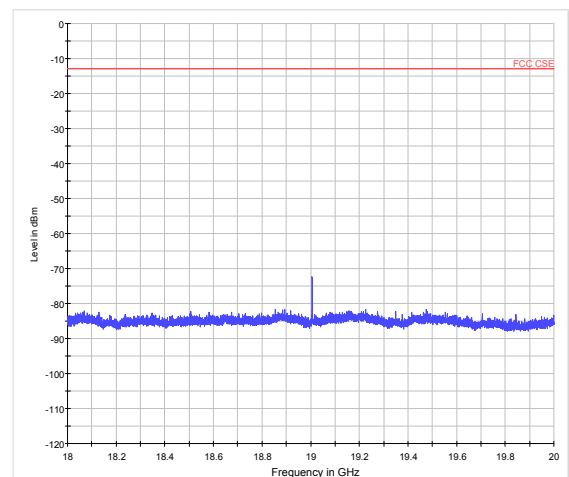



LTE Band 2 15MHz CH-Low 30MHz~3GHz

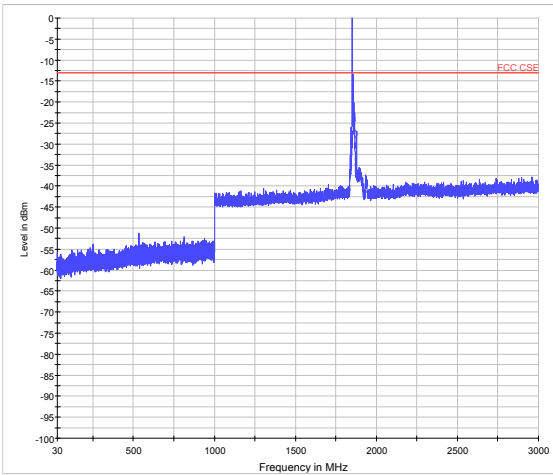

LTE Band 2 15MHz CH-Middle 30MHz~3GHz

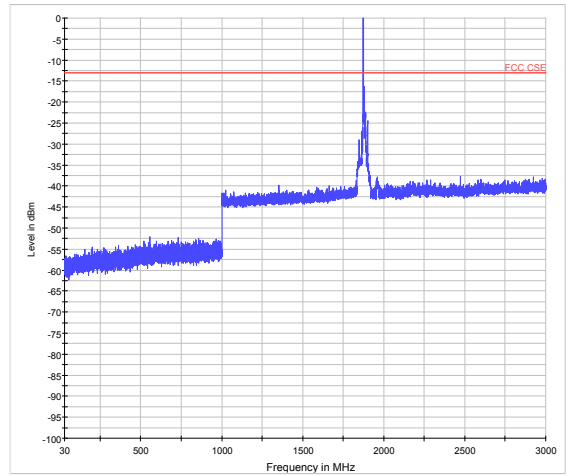

LTE Band 2 15MHz CH-Low 3GHz~18GHz

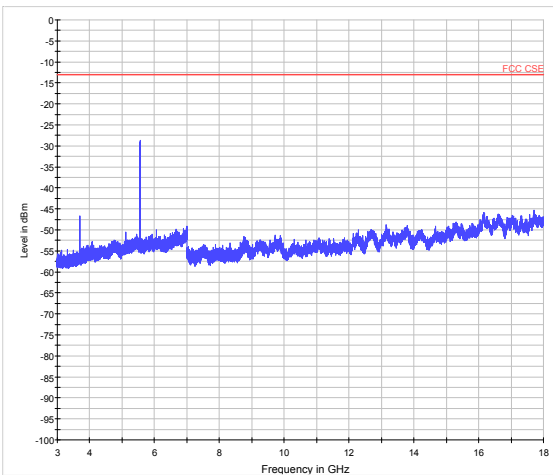

LTE Band 2 15MHz CH-Middle 3GHz~18GHz

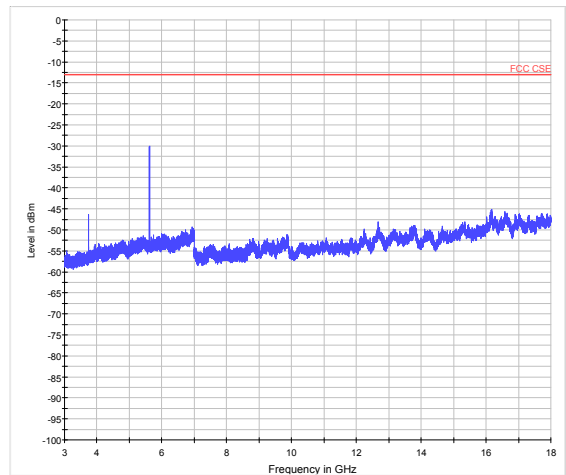

LTE Band 2 15MHz CH-Low 18GHz~20GHz

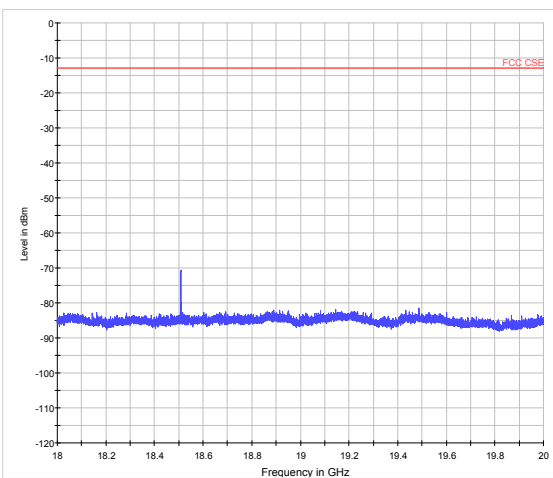

LTE Band 2 15MHz CH-Middle 18GHz~20GHz

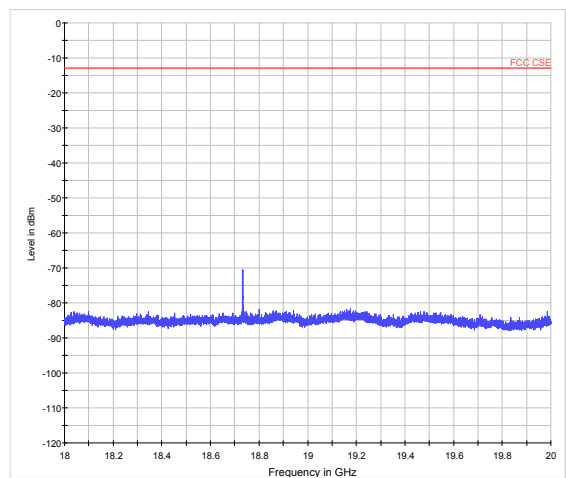



LTE Band 2 15MHz CH-High 30MHz~3GHz

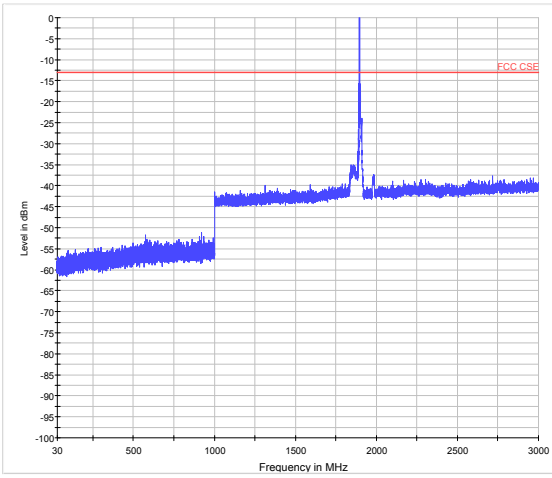

LTE Band 2 20MHz CH-Low 30MHz~3GHz

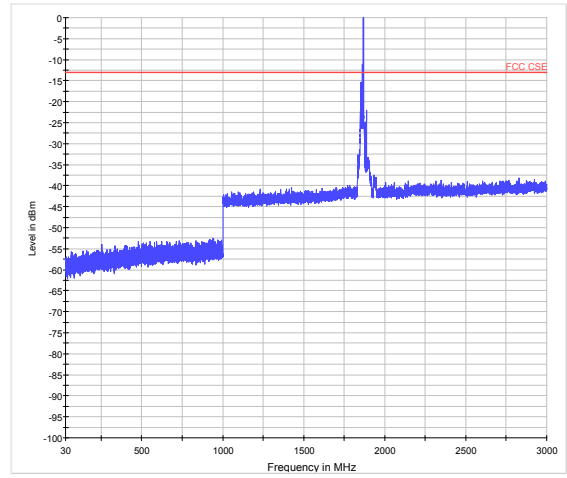

LTE Band 2 15MHz CH-High 3GHz~18GHz

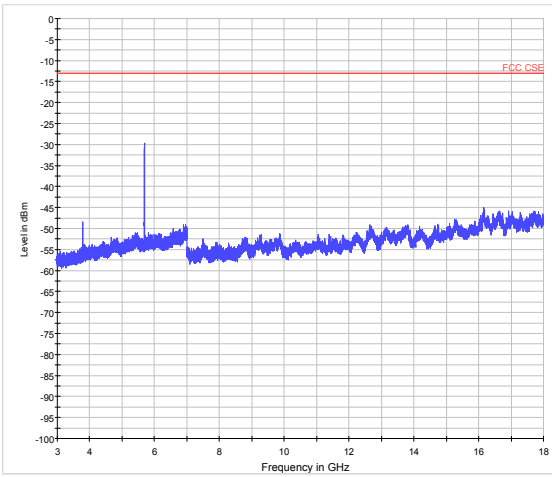

LTE Band 2 20MHz CH-Low 3GHz~18GHz

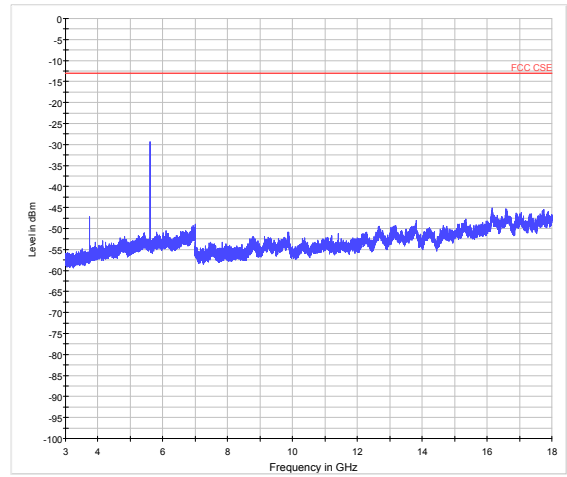

LTE Band 2 15MHz CH-High 18GHz~20GHz

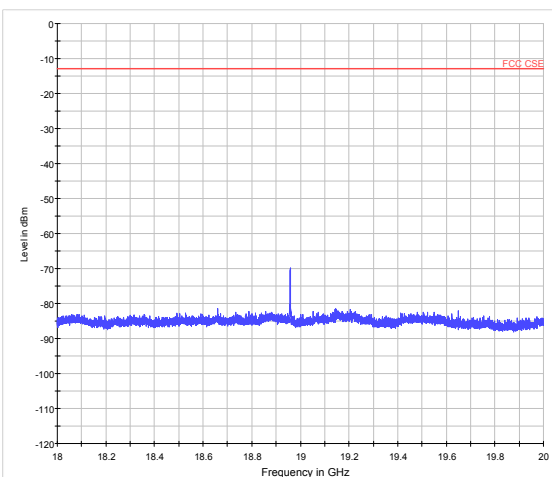

LTE Band 2 20MHz CH-Low 18GHz~20GHz

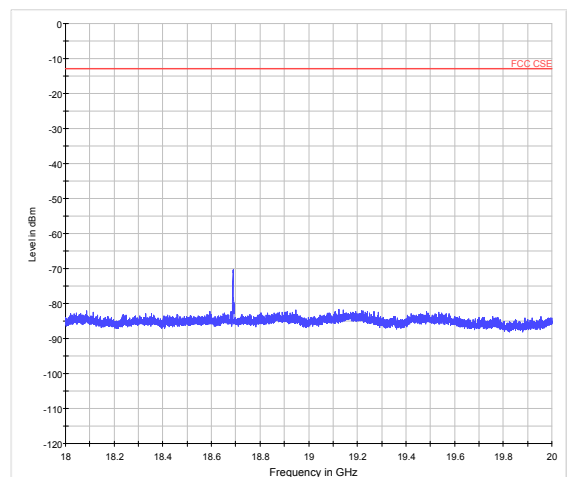



LTE Band 2 20MHz CH-Middle 30MHz~3GHz

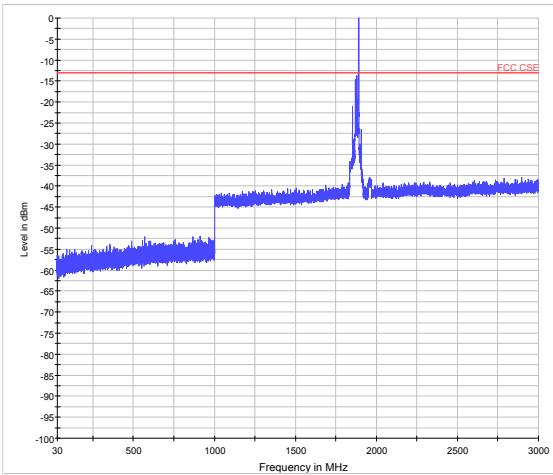

LTE Band 2 20MHz CH-High 30MHz~3GHz

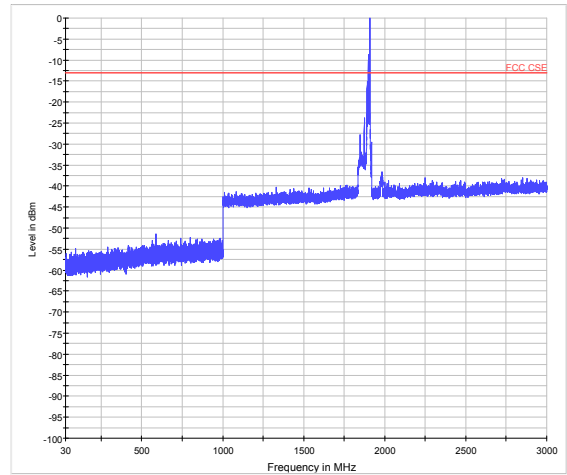

LTE Band 2 20MHz CH-Middle 3GHz~18GHz

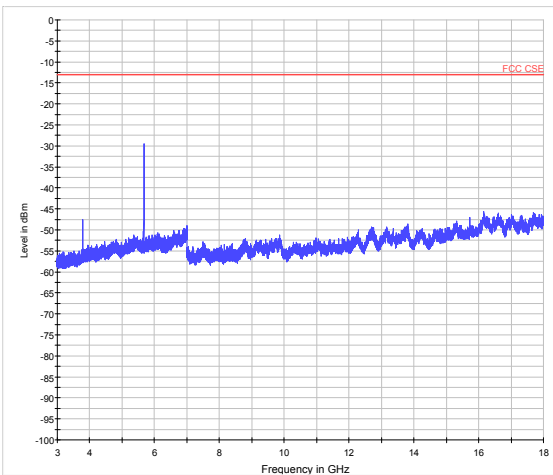

LTE Band 2 20MHz CH-High 3GHz~18GHz

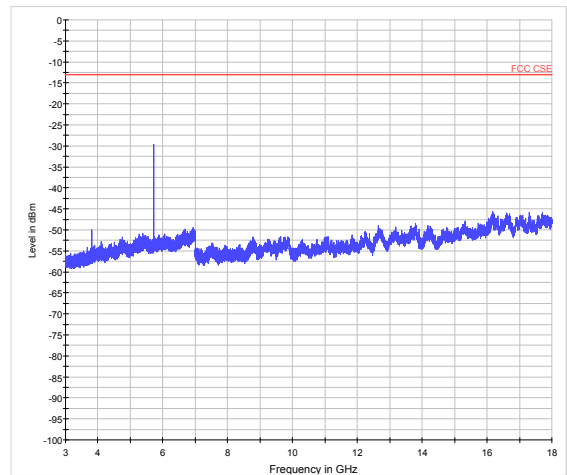

LTE Band 2 20MHz CH-Middle 18GHz~20GHz

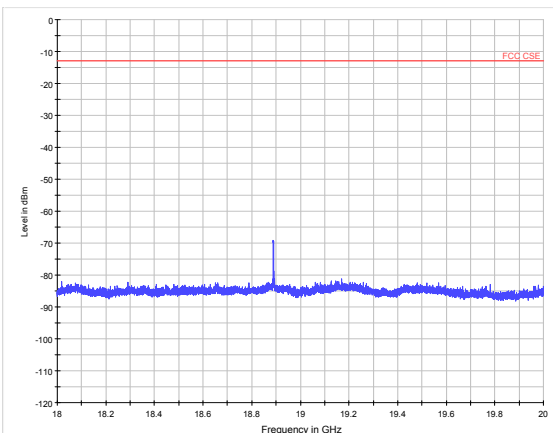

LTE Band 2 20MHz CH-High 18GHz~20GHz

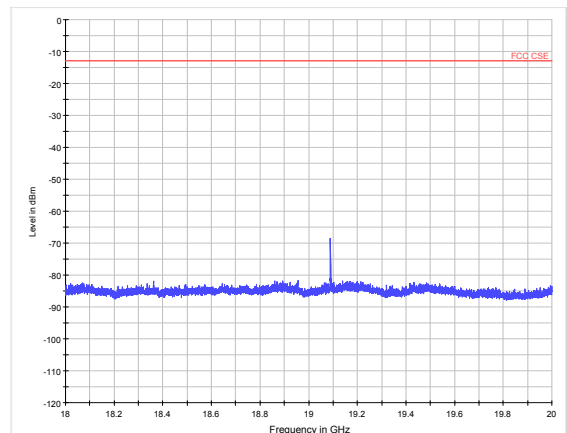



If disturbances were found more than 20dB below limit line, the mark is not required for the EUT.
The signal beyond the limit is carrier.

Test Data File Name	Frequency (MHz)	Level (dBm)	Limit (dBm)	Margin (dB)
CSE_LTE B2_CHLOW_5M_RB1_3-18GHz	5551.3	-28.76	-13.00	15.76
CSE_LTE B2_CHMID_5M_RB1_3-18GHz	5633.6	-29.56	-13.00	16.56
CSE_LTE B2_CHHIGH_5M_RB1_3-18GHz	5716.3	-30.06	-13.00	17.06
CSE_LTE B2_CHLOW_10M_RB1_3-18GHz	5551.9	-28.41	-13.00	15.41
CSE_LTE B2_CHMID_10M_RB1_3-18GHz	5627.3	-29.68	-13.00	16.68
CSE_LTE B2_CHHIGH_10M_RB1_3-18GHz	5701.9	-30.24	-13.00	17.24
CSE_LTE B2_CHLOW_15M_RB1_3-18GHz	5552.6	-28.70	-13.00	15.70
CSE_LTE B2_CHMID_15M_RB1_3-18GHz	5620.1	-29.99	-13.00	16.99
CSE_LTE B2_CHHIGH_15M_RB1_3-18GHz	5688.0	-29.71	-13.00	16.71
CSE_LTE B2_CHLOW_20M_RB1_3-18GHz	5607.0	-29.34	-13.00	16.34
CSE_LTE B2_CHMID_20M_RB1_3-18GHz	5666.6	-29.51	-13.00	16.51
CSE_LTE B2_CHHIGH_20M_RB1_3-18GHz	5727.0	-29.76	-13.00	16.76

5.8. Radiates Spurious Emission

Ambient condition

Temperature	Relative humidity	Pressure
23°C ~25°C	45%~50%	101.5kPa

Method of Measurement

1. The testing follows FCC KDB 971168 v03 Section 5.8 and ANSI/TIA-603-D-2010.
2. The EUT is placed on a turntable 0.8 meters above the ground in the chamber, 3 meter away from the antenna. The maximal emission value is acquired by adjusting the antenna height, polarisation and turntable azimuth. Normally, the height range of antenna is 1 m to 4 m, the azimuth range of turntable is 0° to 360°, and the receive antenna has two polarizations Vertical (V) and Horizontal (H).
3. A log-periodic antenna or double-ridged waveguide horn antenna shall be substituted in place of the EUT. The log-periodic antenna will be driven by a signal generator and the level will be adjusted till the same power value on the spectrum analyzer or receiver. The level of the spurious emissions can be calculated through the level of the signal generator, cable loss, the gain of the substitution antenna and the reading of the spectrum analyzer or receiver.
4. The EUT is then put into continuously transmitting mode at its maximum power level during the test. Set Test Receiver or Spectrum RBW=1MHz, VBW=3MHz, And the maximum value of the receiver should be recorded as (Pr).
5. The EUT shall be replaced by a substitution antenna. In the chamber, an substitution antenna for the frequency band of interest is placed at the reference point of the chamber. An RF Signal source for the frequency band of interest is connected to the substitution antenna with a cable that has been constructed to not interfere with the radiation pattern of the antenna. A power (PMea) is applied to the input of the substitution antenna, and adjust the level of the signal generator output until the value of the receiver reach the previously recorded (Pr). The power of signal source (PMea) is recorded. The test should be performed by rotating the test item and adjusting the receiving antenna polarization.
6. A amplifier should be connected to the Signal Source output port. And the cable should be connect between the Amplifier and the Substitution Antenna. The cable loss (Pcl), the Substitution Antenna Gain (Ga) and the Amplifier Gain (PAg) should be recorded after test.
7. The measurement results are obtained as described below:
$$\text{Power(EIRP)} = \text{PMea} - \text{PAg} - \text{Pcl} + \text{Ga}$$

The measurement results are amend as described below:
$$\text{Power(EIRP)} = \text{PMea} - \text{Pcl} + \text{Ga}$$
8. This value is EIRP since the measurement is calibrated using an antenna of known gain (2.15 dBi) and known input power. ERP can be calculated from EIRP by subtracting the gain of the dipole, $\text{ERP} = \text{EIRP} - 2.15\text{dBi}$.

Test setup

30MHz~~~ 1GHz

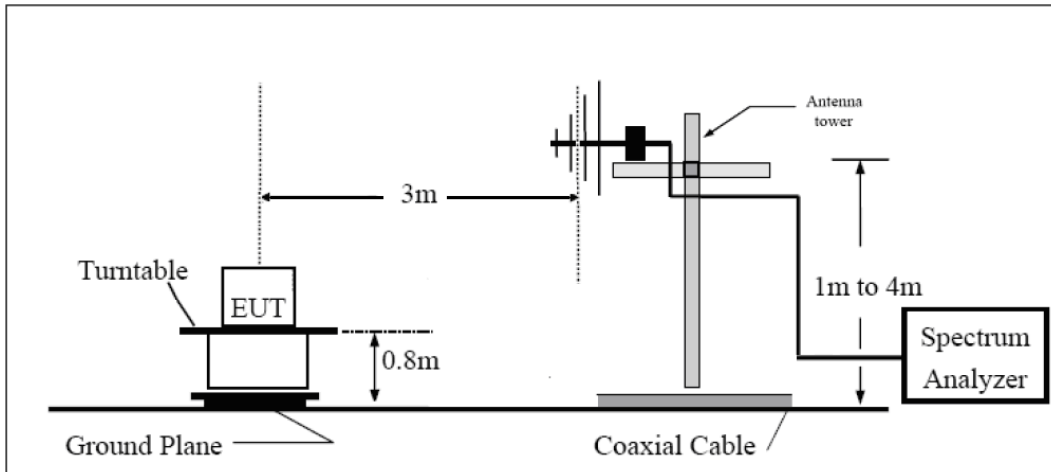

Above 1GHz

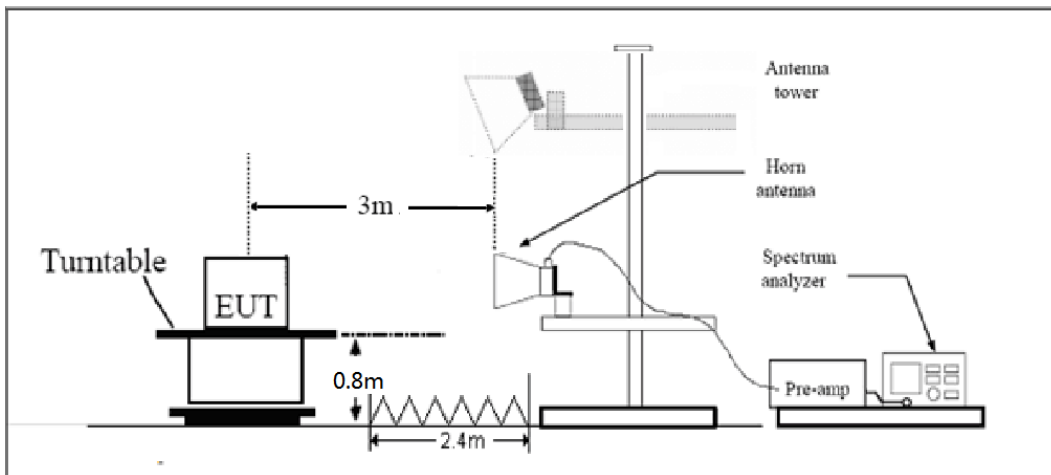

Note: Area side: 2.4mX3.6m

The radiated emission was measured in the following position: EUT stand-up position (Z axis), lie-down position (X, Y axis). The worst emission was found in stand-up position (Z axis) and the worst case was recorded.

Limits

Rule Part 24.238(a) specifies that “on any frequency outside a licensee's frequency block, the power of any emission shall be attenuated below the transmitter power (P) by at least $43 + 10 \log_{10} (P)$ dB.”

Limit	-13 dBm
-------	---------

Measurement Uncertainty

The assessed measurement uncertainty to ensure 95% confidence level for the normal distribution is with the coverage factor $k = 1.96$, $U = 3.55$ dB.

Test Result

LTE Band 2 5MHz CH-Low

Harmonic	Frequency (MHz)	SG (dBm)	Cable Loss (dB)	Gain (dBi)	Antenna Polarization	EIRP Level (dBm)	Limit (dBm)	Margin (dB)	Azimuth (deg)
2	3700.5	-58.05	5.10	11.05	Horizontal	-52.1	-13.0	39.1	180
3	5551.5	-50.63	5.42	12.65	Horizontal	-43.4	-13.0	30.4	90
4	7410.0	-58.85	6.70	13.85	Horizontal	-51.7	-13.0	38.7	135
5	9262.5	-59.44	7.01	14.75	Horizontal	-51.7	-13.0	38.7	225
6	11115.0	-60.67	7.48	15.95	Horizontal	-52.2	-13.0	39.2	45
7	12967.5	-59.64	7.51	16.55	Horizontal	-50.6	-13.0	37.6	225
8	14820.0	-55.01	8.24	15.35	Horizontal	-47.9	-13.0	34.9	180
9	16672.5	-52.94	8.41	14.95	Horizontal	-46.4	-13.0	33.4	315
10	18525.0	-52.11	8.54	15.45	Horizontal	-45.2	-13.0	32.2	90

Note: 1.The other Spurious RF Radiated emissions level is no more than noise floor.
 2. The worst emission was found in the antenna is Horizontal position.

LTE Band 2 5MHz CH-Middle

Harmonic	Frequency (MHz)	SG (dBm)	Cable Loss (dB)	Gain (dBi)	Antenna Polarization	EIRP Level (dBm)	Limit (dBm)	Margin (dB)	Azimuth (deg)
2	3760.0	-58.45	5.10	11.05	Horizontal	-52.5	-13.0	39.5	45
3	5640.0	-52.63	5.42	12.65	Horizontal	-45.4	-13.0	32.4	90
4	7520.0	-59.15	6.70	13.85	Horizontal	-52.0	-13.0	39.0	315
5	9400.0	-59.74	7.01	14.75	Horizontal	-52.0	-13.0	39.0	180
6	11280.0	-59.87	7.48	15.95	Horizontal	-51.4	-13.0	38.4	90
7	13160.0	-58.24	7.51	16.55	Horizontal	-49.2	-13.0	36.2	180
8	15040.0	-53.71	8.24	15.35	Horizontal	-46.6	-13.0	33.6	135
9	16920.0	-52.74	8.41	14.95	Horizontal	-46.2	-13.0	33.2	315
10	18800.0	-52.61	8.54	15.45	Horizontal	-45.7	-13.0	32.7	180

Note: 1.The other Spurious RF Radiated emissions level is no more than noise floor.
 2. The worst emission was found in the antenna is Horizontal position.

LTE Band 2 5MHz CH-High

Harmonic	Frequency (MHz)	SG (dBm)	Cable Loss (dB)	Gain (dBi)	Antenna Polarization	EIRP Level (dBm)	Limit (dBm)	Margin (dB)	Azimuth (deg)
2	3815.0	-56.05	5.10	11.05	Horizontal	-50.1	-13.0	37.1	45
3	5722.5	-51.93	5.42	12.65	Horizontal	-44.7	-13.0	31.7	315
4	7630.0	-56.95	6.70	13.85	Horizontal	-49.8	-13.0	36.8	135
5	9537.5	-57.84	7.01	14.75	Horizontal	-50.1	-13.0	37.1	135
6	11445.0	-60.07	7.48	15.95	Horizontal	-51.6	-13.0	38.6	270
7	13352.5	-58.94	7.51	16.55	Horizontal	-49.9	-13.0	36.9	180
8	15260.0	-54.21	8.24	15.35	Horizontal	-47.1	-13.0	34.1	315
9	17167.5	-52.04	8.41	14.95	Horizontal	-45.5	-13.0	32.5	315
10	19075.0	-52.21	8.54	15.45	Horizontal	-45.3	-13.0	32.3	45

Note: 1.The other Spurious RF Radiated emissions level is no more than noise floor.
2. The worst emission was found in the antenna is Horizontal position.

LTE Band 2 10MHz CH-Low

Harmonic	Frequency (MHz)	SG (dBm)	Cable Loss (dB)	Gain (dBi)	Antenna Polarization	EIRP Level (dBm)	Limit (dBm)	Margin (dB)	Azimuth (deg)
2	3710.0	-58.75	5.10	11.05	Horizontal	-52.8	-13.0	39.8	135
3	5565.0	-48.43	5.42	12.65	Horizontal	-41.2	-13.0	28.2	135
4	7420.0	-59.65	6.70	13.85	Horizontal	-52.5	-13.0	39.5	270
5	9275.0	-59.14	7.01	14.75	Horizontal	-51.4	-13.0	38.4	270
6	11130.0	-60.17	7.48	15.95	Horizontal	-51.7	-13.0	38.7	315
7	12985.0	-60.34	7.51	16.55	Horizontal	-51.3	-13.0	38.3	90
8	14840.0	-54.21	8.24	15.35	Horizontal	-47.1	-13.0	34.1	270
9	16695.0	-53.24	8.41	14.95	Horizontal	-46.7	-13.0	33.7	45
10	18550.0	-53.01	8.54	15.45	Horizontal	-46.1	-13.0	33.1	180

Note: 1.The other Spurious RF Radiated emissions level is no more than noise floor.
2. The worst emission was found in the antenna is Horizontal position.



LTE Band 2 10MHz CH-Middle

Harmonic	Frequency (MHz)	SG (dBm)	Cable Loss (dB)	Gain (dBi)	Antenna Polarization	EIRP Level (dBm)	Limit (dBm)	Margin (dB)	Azimuth (deg)
2	3760.0	-56.95	5.10	11.05	Horizontal	-51.0	-13.0	38.0	225
3	5640.0	-52.03	5.42	12.65	Horizontal	-44.8	-13.0	31.8	90
4	7520.0	-58.45	6.70	13.85	Horizontal	-51.3	-13.0	38.3	90
5	9400.0	-59.74	7.01	14.75	Horizontal	-52.0	-13.0	39.0	0
6	11280.0	-61.27	7.48	15.95	Horizontal	-52.8	-13.0	39.8	90
7	13160.0	-60.14	7.51	16.55	Horizontal	-51.1	-13.0	38.1	225
8	15040.0	-55.31	8.24	15.35	Horizontal	-48.2	-13.0	35.2	225
9	16920.0	-52.94	8.41	14.95	Horizontal	-46.4	-13.0	33.4	270
10	18800.0	-52.01	8.54	15.45	Horizontal	-45.1	-13.0	32.1	270

Note: 1. The other Spurious RF Radiated emissions level is no more than noise floor.
2. The worst emission was found in the antenna is Horizontal position.

LTE Band 2 10MHz CH-High

Harmonic	Frequency (MHz)	SG (dBm)	Cable Loss (dB)	Gain (dBi)	Antenna Polarization	EIRP Level (dBm)	Limit (dBm)	Margin (dB)	Azimuth (deg)
2	3810.0	-54.25	5.10	11.05	Horizontal	-48.3	-13.0	35.3	45
3	5715.0	-52.53	5.42	12.65	Horizontal	-45.3	-13.0	32.3	90
4	7620.0	-58.35	6.70	13.85	Horizontal	-51.2	-13.0	38.2	135
5	9525.0	-58.94	7.01	14.75	Horizontal	-51.2	-13.0	38.2	270
6	11430.0	-60.77	7.48	15.95	Horizontal	-52.3	-13.0	39.3	315
7	13335.0	-59.24	7.51	16.55	Horizontal	-50.2	-13.0	37.2	315
8	15240.0	-55.11	8.24	15.35	Horizontal	-48.0	-13.0	35.0	270
9	17145.0	-52.24	8.41	14.95	Horizontal	-45.7	-13.0	32.7	180
10	19050.0	-52.71	8.54	15.45	Horizontal	-45.8	-13.0	32.8	135

Note: 1. The other Spurious RF Radiated emissions level is no more than noise floor.
2. The worst emission was found in the antenna is Horizontal position.



LTE Band 2 15MHz CH-Low

Harmonic	Frequency (MHz)	SG (dBm)	Cable Loss (dB)	Gain (dBi)	Antenna Polarization	EIRP Level (dBm)	Limit (dBm)	Margin (dB)	Azimuth (deg)
2	3715.0	-58.75	5.10	11.05	Horizontal	-52.8	-13.0	39.8	180
3	5572.5	-49.53	5.42	12.65	Horizontal	-42.3	-13.0	29.3	45
4	7430.0	-58.45	6.70	13.85	Horizontal	-51.3	-13.0	38.3	180
5	9287.5	-58.64	7.01	14.75	Horizontal	-50.9	-13.0	37.9	90
6	11145.0	-60.27	7.48	15.95	Horizontal	-51.8	-13.0	38.8	90
7	13002.5	-59.34	7.51	16.55	Horizontal	-50.3	-13.0	37.3	225
8	14860.0	-54.91	8.24	15.35	Horizontal	-47.8	-13.0	34.8	180
9	16717.5	-51.74	8.41	14.95	Horizontal	-45.2	-13.0	32.2	135
10	18575.0	-52.61	8.54	15.45	Horizontal	-45.7	-13.0	32.7	90

Note: 1. The other Spurious RF Radiated emissions level is no more than noise floor.

2. The worst emission was found in the antenna is Horizontal position.

LTE Band 2 15MHz CH-Middle

Harmonic	Frequency (MHz)	SG (dBm)	Cable Loss (dB)	Gain (dBi)	Antenna Polarization	EIRP Level (dBm)	Limit (dBm)	Margin (dB)	Azimuth (deg)
2	3760.0	-57.35	5.10	11.05	Horizontal	-51.4	-13.0	38.4	180
3	5640.0	-53.43	5.42	12.65	Horizontal	-46.2	-13.0	33.2	225
4	7520.0	-54.95	6.70	13.85	Horizontal	-47.8	-13.0	34.8	90
5	9400.0	-58.94	7.01	14.75	Horizontal	-51.2	-13.0	38.2	45
6	11280.0	-61.37	7.48	15.95	Horizontal	-52.9	-13.0	39.9	90
7	13160.0	-59.34	7.51	16.55	Horizontal	-50.3	-13.0	37.3	315
8	15040.0	-55.31	8.24	15.35	Horizontal	-48.2	-13.0	35.2	180
9	16920.0	-53.74	8.41	14.95	Horizontal	-47.2	-13.0	34.2	180
10	18800.0	-51.91	8.54	15.45	Horizontal	-45.0	-13.0	32.0	135

Note: 1. The other Spurious RF Radiated emissions level is no more than noise floor.

2. The worst emission was found in the antenna is Horizontal position.



LTE Band 2 15MHz CH-High

Harmonic	Frequency (MHz)	SG (dBm)	Cable Loss (dB)	Gain (dBi)	Antenna Polarization	EIRP Level (dBm)	Limit (dBm)	Margin (dB)	Azimuth (deg)
2	3805.0	-56.45	5.10	11.05	Horizontal	-50.5	-13.0	37.5	135
3	5707.5	-51.73	5.42	12.65	Horizontal	-44.5	-13.0	31.5	270
4	7610.0	-57.85	6.70	13.85	Horizontal	-50.7	-13.0	37.7	135
5	9512.5	-60.54	7.01	14.75	Horizontal	-52.8	-13.0	39.8	90
6	11415.0	-60.57	7.48	15.95	Horizontal	-52.1	-13.0	39.1	180
7	13317.5	-59.14	7.51	16.55	Horizontal	-50.1	-13.0	37.1	90
8	15220.0	-55.01	8.24	15.35	Horizontal	-47.9	-13.0	34.9	90
9	17122.5	-53.64	8.41	14.95	Horizontal	-47.1	-13.0	34.1	90
10	19025.0	-51.71	8.54	15.45	Horizontal	-44.8	-13.0	31.8	315

Note: 1.The other Spurious RF Radiated emissions level is no more than noise floor.
2. The worst emission was found in the antenna is Horizontal position.

LTE Band 2 20MHz CH-Low

Harmonic	Frequency (MHz)	SG (dBm)	Cable Loss (dB)	Gain (dBi)	Antenna Polarization	EIRP Level (dBm)	Limit (dBm)	Margin (dB)	Azimuth (deg)
2	3720.0	-58.15	5.10	11.05	Horizontal	-52.2	-13.0	39.2	135
3	5580.0	-49.43	5.42	12.65	Horizontal	-42.2	-13.0	29.2	180
4	7440.0	-57.65	6.70	13.85	Horizontal	-50.5	-13.0	37.5	270
5	9300.0	-58.84	7.01	14.75	Horizontal	-51.1	-13.0	38.1	315
6	11160.0	-60.27	7.48	15.95	Horizontal	-51.8	-13.0	38.8	90
7	13020.0	-59.34	7.51	16.55	Horizontal	-50.3	-13.0	37.3	45
8	14880.0	-54.71	8.24	15.35	Horizontal	-47.6	-13.0	34.6	0
9	16740.0	-52.44	8.41	14.95	Horizontal	-45.9	-13.0	32.9	315
10	18600.0	-52.61	8.54	15.45	Horizontal	-45.7	-13.0	32.7	45

Note: 1.The other Spurious RF Radiated emissions level is no more than noise floor.
2. The worst emission was found in the antenna is Horizontal position.



LTE Band 2 20MHz CH-Middle

Harmonic	Frequency (MHz)	SG (dBm)	Cable Loss (dB)	Gain (dBi)	Antenna Polarization	EIRP Level (dBm)	Limit (dBm)	Margin (dB)	Azimuth (deg)
2	3760.0	-56.45	5.10	11.05	Horizontal	-50.5	-13.0	37.5	135
3	5640.0	-53.33	5.42	12.65	Horizontal	-46.1	-13.0	33.1	270
4	7520.0	-57.85	6.70	13.85	Horizontal	-50.7	-13.0	37.7	180
5	9400.0	-55.24	7.01	14.75	Horizontal	-47.5	-13.0	34.5	180
6	11280.0	-60.57	7.48	15.95	Horizontal	-52.1	-13.0	39.1	135
7	13160.0	-59.64	7.51	16.55	Horizontal	-50.6	-13.0	37.6	180
8	15040.0	-55.11	8.24	15.35	Horizontal	-48.0	-13.0	35.0	315
9	16920.0	-53.64	8.41	14.95	Horizontal	-47.1	-13.0	34.1	135
10	18800.0	-52.11	8.54	15.45	Horizontal	-45.2	-13.0	32.2	315

Note: 1.The other Spurious RF Radiated emissions level is no more than noise floor.
2. The worst emission was found in the antenna is Horizontal position.

LTE Band 2 20MHz CH-High

Harmonic	Frequency (MHz)	SG (dBm)	Cable Loss (dB)	Gain (dBi)	Antenna Polarization	EIRP Level (dBm)	Limit (dBm)	Margin (dB)	Azimuth (deg)
2	3800.0	-57.05	5.10	11.05	Horizontal	-51.1	-13.0	38.1	90
3	5700.0	-51.93	5.42	12.65	Horizontal	-44.7	-13.0	31.7	180
4	7600.0	-58.65	6.70	13.85	Horizontal	-51.5	-13.0	38.5	225
5	9500.0	-56.14	7.01	14.75	Horizontal	-48.4	-13.0	35.4	180
6	11400.0	-59.67	7.48	15.95	Horizontal	-51.2	-13.0	38.2	0
7	13300.0	-59.34	7.51	16.55	Horizontal	-50.3	-13.0	37.3	315
8	15200.0	-53.61	8.24	15.35	Horizontal	-46.5	-13.0	33.5	0
9	17100.0	-52.34	8.41	14.95	Horizontal	-45.8	-13.0	32.8	315
10	19000.0	-51.91	8.54	15.45	Horizontal	-45.0	-13.0	32.0	90

Note: 1.The other Spurious RF Radiated emissions level is no more than noise floor.
2. The worst emission was found in the antenna is Horizontal position.



6. Main Test Instruments

Name	Manufacturer	Type	Serial Number	Calibration Date	Expiration Date
Base Station Simulator	R&S	CMW500	113645	2017-05-14	2018-05-13
Power Splitter	Hua Xiang	SHX-GF2-2-13	10120101	2017-05-14	2018-05-13
Spectrum Analyzer	Agilent	N9010A	MY47191109	2017-05-20	2018-05-19
Universal Radio Communication Tester	Agilent	E5515C	MY48367192	2017-05-20	2018-05-19
Signal Analyzer	R&S	FSV30	100815	2016-12-16	2017-12-15
EMI Test Receiver	R&S	ESCI	100948	2017-05-20	2018-05-19
Signal generator	R&S	SMB 100A	102594	2017-05-14	2018-05-13
Signal generator	R&S	SMR27	100365	2017-05-14	2018-05-13
Trilog Antenna	SCHWARZBECK	VUBL 9163	9163-201	2014-12-06	2017-12-05
Horn Antenna	R&S	HF907	100126	2014-12-06	2017-12-05
Climatic Chamber	Re Ce	PT-30B	20101891	2015-07-18	2018-07-17
Horn Antenna	ETS-Lindgren	3160-09	00102644	2015-01-30	2018-01-29
RF Cable	Agilent	SMA 15cm	0001	2017-08-04	2018-02-03
Preampfier	R&S	SCU18	102327	2017-06-18	2018-06-17
Software	R&S	EMC32	V 8.52.0	NA	NA

*****END OF REPORT *****

ANNEX A: EUT Appearance and Test Setup

A.1 EUT Appearance



Front Side



Back Side

a: EUT



b: Adapter

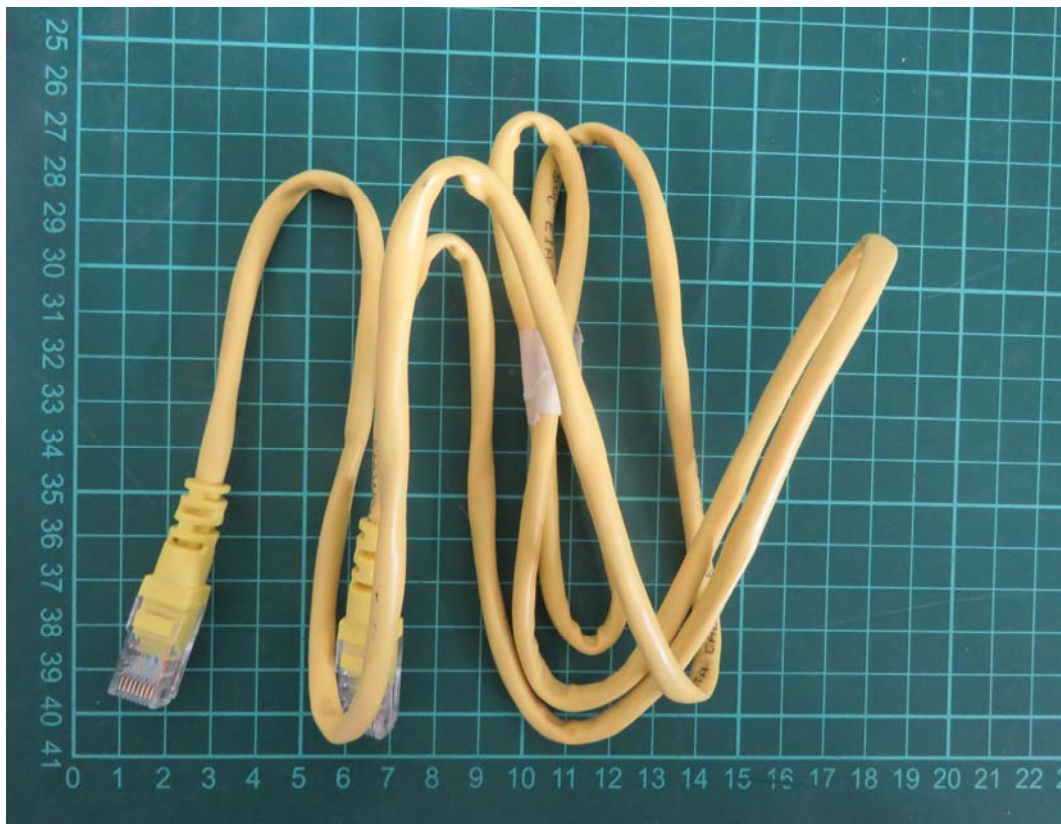

c: Network cable

Picture 1 EUT and Accessory

A.2 Test Setup

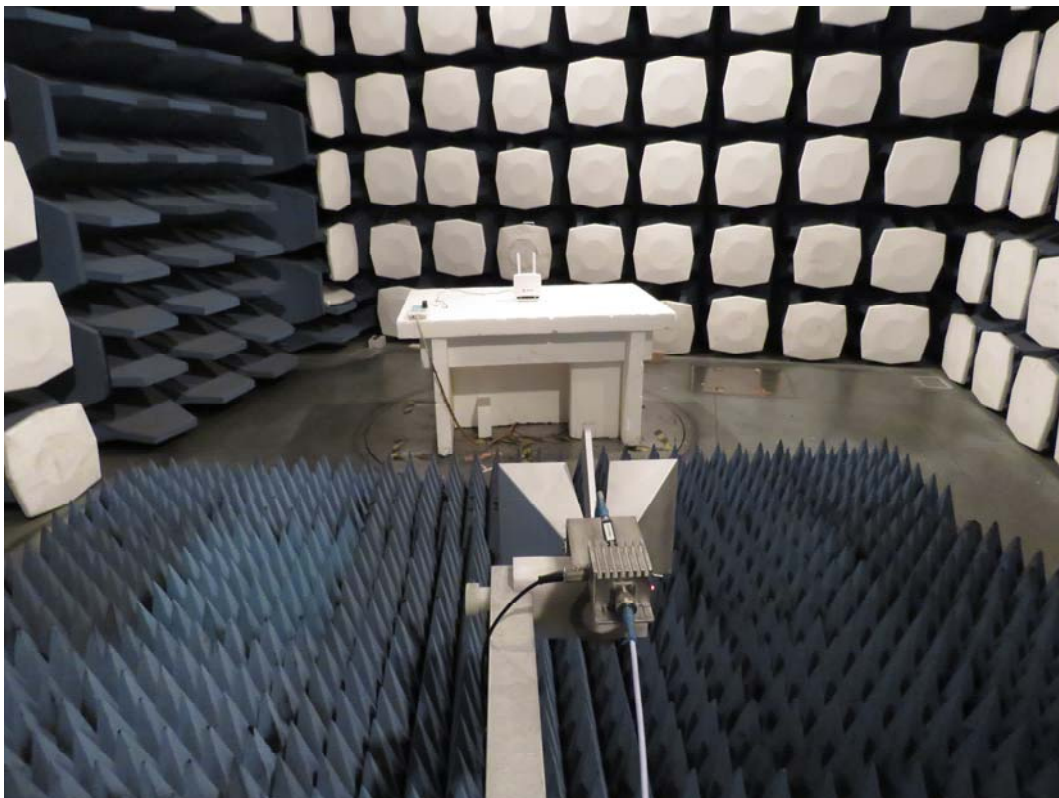
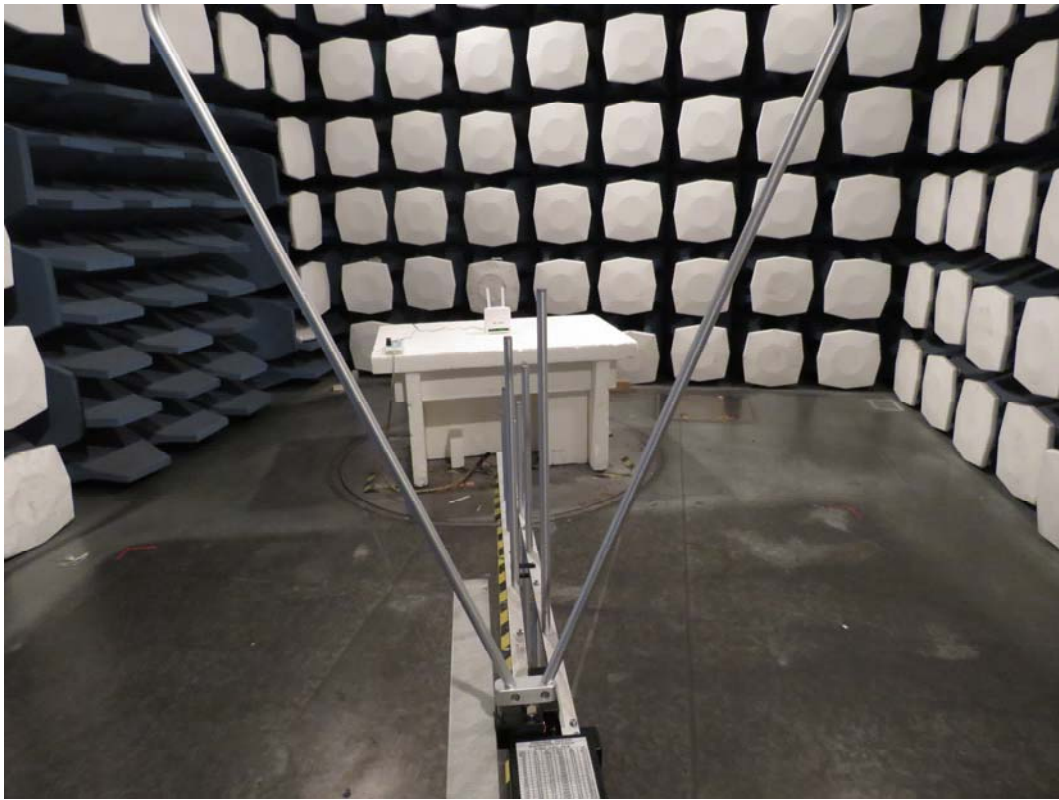

Picture 2: Radiated Spurious Emissions Test setup