

# FCC TEST REPORT (PART 24)



Applicant:	Gosuncn Technology Group Co., Ltd.
Address:	6F, 2819 KaiChuang Blvd., Science Town, Huangpu District, Guangzhou City, Guangdong, China.

Manufacturer or Supplier:	Gosuncn Technology Group Co., Ltd.
Address:	6F, 2819 KaiChuang Blvd., Science Town, Huangpu District, Guangzhou City, Guangdong, China.
Product:	Tracker
Brand Name:	GOSUNCN
Model Name:	GT105
FCC ID:	2APNR-GT105
Date of tests:	Feb. 18, 2019 ~ Mar. 18, 2019

The tests have been carried out according to the requirements of the following standard:

- FCC PART 24, Subpart E**     **ANSI C63.26-2015**  
 **ANSI/TIA/EIA-603-D**         **ANSI/TIA/EIA-603-E**

**CONCLUSION:** The submitted sample was found to COMPLY with the test requirement

Prepared by Roger Li Engineer / Mobile Department	Approved by Luke Lu Manager / Mobile Department
 Date: Mar. 26, 2019	 Date: Mar. 26, 2019

This report is governed by, and incorporates by reference, CPS Conditions of Service as posted at the date of issuance of this report at <http://www.bureauveritas.com/home/about-us/our-business/cps/about-us/terms-conditions> and is intended for your exclusive use. Any copying or replication of this report to or for any other person or entity, or use of our name or trademark, is permitted only with our prior written permission. This report sets forth our findings solely with respect to the test samples identified herein. The results set forth in this report are not indicative or representative of the quality or characteristics of the lot from which a test sample was taken or any similar or identical product unless specifically and expressly noted. Our report includes all of the tests requested by you and the results thereof based upon the information that you provided to us. Measurement uncertainty is only provided upon request for accredited tests. You have 60 days from date of issuance of this report to notify us of any material error or omission caused by our negligence or if you require measurement uncertainty; provided, however, that such notice shall be in writing and shall specifically address the issue you wish to raise. A failure to raise such issue within the prescribed time shall constitute your unqualified acceptance of the completeness of this report, the tests conducted and the correctness of the report contents.



# TABLE OF CONTENTS

**RELEASE CONTROL RECORD ..... 4**

**1 SUMMARY OF TEST RESULTS ..... 5**

1.1 MEASUREMENT UNCERTAINTY ..... 5

1.2 TEST SITE AND INSTRUMENTS ..... 6

**2 GENERAL INFORMATION ..... 7**

2.1 GENERAL DESCRIPTION OF EUT ..... 7

2.2 CONFIGURATION OF SYSTEM UNDER TEST ..... 9

2.3 DESCRIPTION OF SUPPORT UNITS ..... 10

2.4 TEST ITEM AND TEST CONFIGURATION ..... 10

2.5 EUT OPERATING CONDITIONS ..... 14

2.6 GENERAL DESCRIPTION OF APPLIED STANDARDS ..... 14

**3 TEST TYPES AND RESULTS ..... 15**

3.1 OUTPUT POWER MEASUREMENT ..... 15

3.1.1 LIMITS OF OUTPUT POWER MEASUREMENT ..... 15

3.1.2 TEST PROCEDURES ..... 15

3.1.3 TEST SETUP ..... 16

3.1.4 TEST RESULTS ..... 17

3.2 FREQUENCY STABILITY MEASUREMENT ..... 26

3.2.1 LIMITS OF FREQUENCY STABILITY MEASUREMENT ..... 26

3.2.2 TEST PROCEDURE ..... 26

3.2.3 TEST SETUP ..... 26

3.2.4 TEST RESULTS ..... 27

3.3 OCCUPIED BANDWIDTH MEASUREMENT ..... 34

3.3.1 TEST PROCEDURES ..... 34

3.3.2 TEST SETUP ..... 34

3.3.3 TEST RESULTS ..... 35

3.4 BAND EDGE MEASUREMENT ..... 42

3.4.1 LIMITS OF BAND EDGE MEASUREMENT ..... 42

3.4.2 TEST SETUP ..... 42

3.4.3 TEST PROCEDURES ..... 42

3.4.4 TEST RESULTS ..... 44

3.5 CONDUCTED SPURIOUS EMISSIONS ..... 51

3.5.1 LIMITS OF CONDUCTED SPURIOUS EMISSIONS MEASUREMENT ..... 51

3.5.2 TEST PROCEDURE ..... 51

3.5.3 TEST SETUP ..... 51

3.5.4 TEST RESULTS ..... 52

3.6 RADIATED EMISSION MEASUREMENT ..... 59

3.6.1 LIMITS OF RADIATED EMISSION MEASUREMENT ..... 59

3.6.2 TEST PROCEDURES ..... 59

3.6.3 DEVIATION FROM TEST STANDARD ..... 59

3.6.4 TEST SETUP ..... 60

3.6.5 TEST RESULTS ..... 62

3.7 PEAK TO AVERAGE RATIO ..... 86

3.7.1 LIMITS OF PEAK TO AVERAGE RATIO MEASUREMENT ..... 86

3.7.2 TEST SETUP ..... 86

3.7.3 TEST PROCEDURES ..... 86

3.7.4 TEST RESULTS ..... 87



**BUREAU VERITAS** Test Report No.: RF190123W002-3

<b>4</b>	<b>INFORMATION ON THE TESTING LABORATORIES.....</b>	<b>93</b>
<b>5</b>	<b>APPENDIX A – MODIFICATIONS RECORDERS FOR ENGINEERING CHANGES TO THE EUT BY THE LAB.....</b>	<b>94</b>



**BUREAU**  
**VERITAS**

Test Report No.: RF190123W002-3

## RELEASE CONTROL RECORD

ISSUE NO.	REASON FOR CHANGE	DATE ISSUED
RF190123W002-3	Original release	Mar. 26, 2019



# 1 SUMMARY OF TEST RESULTS

The EUT has been tested according to the following specifications:

APPLIED STANDARD: FCC Part 24 & Part 2			
STANDARD SECTION	TEST TYPE	RESULT	REMARK
2.1046 24.232	Equivalent Isotropic Radiated Power	PASS	Meet the requirement of limit.
2.1055 24.235	Frequency Stability	PASS	Meet the requirement of limit.
2.1049 24.238(b)	Occupied Bandwidth	PASS	Meet the requirement of limit.
24.232(d)	Peak to average ratio	PASS	Meet the requirement of limit.
24.238(b)	Band Edge Measurements	PASS	Meet the requirement of limit.
2.1051 24.238	Conducted Spurious Emissions	PASS	Meet the requirement of limit.
2.1053 24.238	Radiated Spurious Emissions	PASS	Meet the requirement of limit. Minimum passing margin is -13.20dB at 35.26MHz.

## 1.1 MEASUREMENT UNCERTAINTY

Where relevant, the following measurement uncertainty levels have been estimated for tests performed on the EUT as specified in CISPR 16-4-2:

MEASUREMENT	UNCERTAINTY
Effective Radiated Power	±4.48dB
Frequency Stability	±39.27Hz
Radiated emissions	±4.48dB
Conducted emissions	±2 dB
Occupied Channel Bandwidth	±21.7KHz
Band Edge Measurements	±4.48dB
Peak to average ratio	±0.76dB

This uncertainty represents an expanded uncertainty expressed at approximately the 95% confidence level using a coverage factor of k=2.



## 1.2 TEST SITE AND INSTRUMENTS

Equipment	Manufacturer	Model No.	Serial No.	Last Cal.	Next Cal.
MXE EMI Receiver	KEYSIGHT	N9038A-544	MY54450026	Feb. 26,19	Feb. 25,20
EXA Signal Analyzer	KEYSIGHT	N9010A-526	MY54510322	Feb. 26,19	Feb. 25,20
Bilog Antenna 1	ETS-LINDGREN	3143B	00161964	Feb. 26,19	Feb. 25,20
Bilog Antenna 2	ETS-LINDGREN	3143B	00161965	Feb. 26,19	Feb. 25,20
Horn Antenna 1	ETS-LINDGREN	3117	00168728	Feb. 26,19	Feb. 25,20
Horn Antenna 2	ETS-LINDGREN	3117	00168692	Nov. 30, 18	Nov. 29, 19
Loop antenna	Daze	ZN30900A	0708	Oct. 23,18	Oct. 22, 19
Horn Antenna (18GHz-40GHz)	N/A	QWH-SL-18-40-K-SG/QMS-00361	15433	Nov. 21, 18	Nov. 20, 19
Radio Communication Analyzer	ANRITSU	MT8820C	6201465426	Feb. 26,19	Feb. 25,20
Signal Pre-Amplifier	EMSI	EMC 9135	980249	Jul. 09,18	Jul. 08,19
Signal Pre-Amplifier	EMSI	EMC 012645B	980257	Jul. 09,18	Jul. 08,19
Signal Pre-Amplifier	EMSI	EMC 184045B	980259	Jul. 09,18	Jul. 08,19
3m Semi-anechoic Chamber	ETS-LINDGREN	9m*6m*6m	Euroshieldpn-CT0001143-1216	Feb. 26,19	Feb. 25,20
Test Software	E3	V 9.160323	N/A	N/A	N/A
Test Software	ADT	ADT_Radiated_V7.6.15.9.2	N/A	N/A	N/A
10dB Attenuator	JFW/USA	50HF-010-SM A	1505	Jul. 09,18	Jul. 08,19
Power Meter	Anritsu	ML2495A	1506002	Feb. 26,19	Feb. 25,20
Power Sensor	Anritsu	MA2411B	1339352	Feb. 26,19	Feb. 25,20
Humid & Temp Programmable Tester	Juyi	ITH-120-45-CP-AR	IAA1504-001	Jul. 09,18	Jul. 08,19
MXG Analog Microvave Signal Generator	KEYSIGHT	N5183A	MY50143024	Feb. 26,19	Feb. 25,20

- NOTE:**
1. The calibration interval of the above test instruments is 12 months or 24 months and the calibrations are traceable to CEPREI/CHINA, GRGT/CHINA and NIM/CHINA.
  2. The test was performed in 3m Semi-anechoic Chamber and RF Oven Room.
  3. The horn antenna is used only for the measurement of emission frequency above 1GHz if tested.
  4. The FCC Site Registration No. is 525120; The Designation No. is CN1171.



## 2 GENERAL INFORMATION

### 2.1 GENERAL DESCRIPTION OF EUT

<b>PRODUCT</b>	Tracker	
<b>BRAND NAME</b>	GOSUNCN	
<b>MODEL NAME</b>	GT105	
<b>POWER SUPPLY</b>	5.0Vdc (adapter or host equipment) 3.8Vdc (Li-ion, battery)	
<b>MODULATION TYPE</b>	<b>WCDMA</b> : BPSK <b>LTE Band 2</b> : QPSK, 16QAM	
<b>FREQUENCY RANGE</b>	<b>WCDMA</b>	1852.4MHz ~ 1907.6MHz
	<b>LTE Band 2</b> <b>Channel Bandwidth: 1.4MHz</b>	1850.7MHz ~ 1909.3MHz
	<b>LTE Band 2</b> <b>Channel Bandwidth: 3MHz</b>	1851.5MHz ~ 1908.5MHz
	<b>LTE Band 2</b> <b>Channel Bandwidth: 5MHz</b>	1852.5MHz ~ 1907.5MHz
	<b>LTE Band 2</b> <b>Channel Bandwidth: 10MHz</b>	1855.0MHz ~ 1905.0MHz
	<b>LTE Band 2</b> <b>Channel Bandwidth: 15MHz</b>	1857.5MHz ~ 1902.5MHz
	<b>LTE Band 2</b> <b>Channel Bandwidth: 20MHz</b>	1860.0MHz ~ 1900.0MHz
	<b>MAX. EIRP POWER</b>	<b>WCDMA</b>
<b>LTE Band 2</b> <b>Channel Bandwidth: 1.4MHz</b>		260mW
<b>LTE Band 2</b> <b>Channel Bandwidth: 3MHz</b>		266mW
<b>LTE Band 2</b> <b>Channel Bandwidth: 5MHz</b>		258mW
<b>LTE Band 2</b> <b>Channel Bandwidth: 10MHz</b>		254mW
<b>LTE Band 2</b> <b>Channel Bandwidth: 15MHz</b>		244mW
<b>LTE Band 2</b> <b>Channel Bandwidth: 20MHz</b>		203mW
<b>EMISSION DESIGNATOR</b>	<b>WCDMA</b>	4M14F9W
	<b>LTE Band 2</b> <b>Channel Bandwidth: 1.4MHz</b>	QPSK: 1M09G7D
		16QAM: 1M08W7D
	<b>LTE Band 2</b> <b>Channel Bandwidth: 3MHz</b>	QPSK: 2M69G7D
16QAM: 2M68W7D		



	<b>LTE Band 2 Channel Bandwidth: 5MHz</b>	QPSK: 4M48G7D 16QAM: 4M47W7D
	<b>LTE Band 2 Channel Bandwidth: 10MHz</b>	QPSK: 8M93G7D
	<b>LTE Band 2 Channel Bandwidth: 15MHz</b>	QPSK: 13M4G7D
	<b>LTE Band 2 Channel Bandwidth: 20MHz</b>	QPSK: 17M9G7D
<b>ANTENNA TYPE</b>	Fixed Internal antenna with 2.4 gain	
<b>HW VERSION</b>	SD2000.H02	
<b>SW VERSION</b>	EN_SD2000V1.0.0B01	
<b>ACCESSORY DEVICE</b>	Refer to note as below	
<b>DATA CABLE</b>	USB cable: non-shielded, detachable, 1.0m	

**NOTE:**

- For a more detailed features description, please refer to the manufacturer's specifications or the user's manual.
- The EUT was powered by the following adapter:

<b>ADAPTER</b>	
<b>BRAND:</b>	GOSUNCN
<b>MODEL:</b>	RD0501000-USBA-18MG
<b>INPUT:</b>	AC 100-240V, 25A
<b>OUTPUT:</b>	DC 5V, 100mA

- The EUT matched the following USB cable:

<b>USB CABLE</b>	
<b>BRAND:</b>	Zhanxin Technology Company Ltd.
<b>MODEL:</b>	C-ZX-10104
<b>SIGNAL LINE:</b>	1.0 METER

- For the test results, the EUT had been tested with all conditions. But only the worst case was shown in test report.





## 2.2 CONFIGURATION OF SYSTEM UNDER TEST

### FOR RADIATION EMISSION TEST

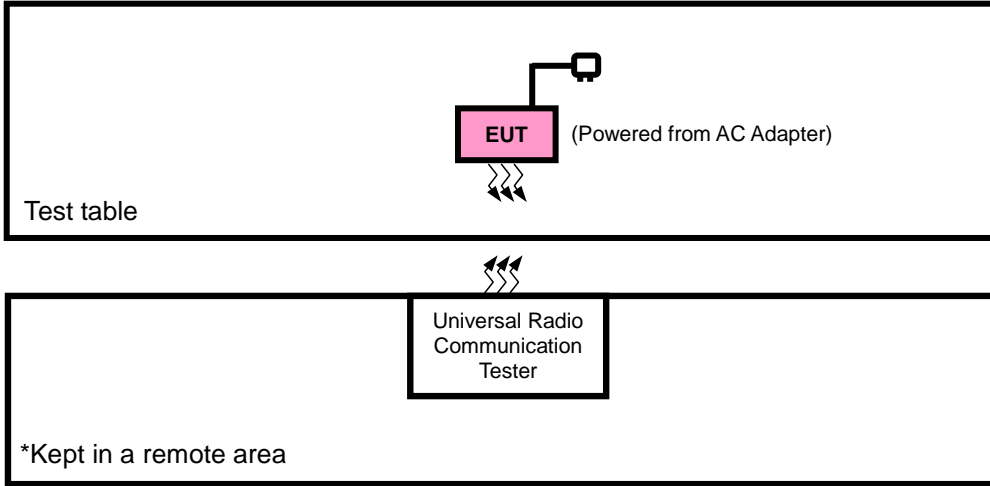

### FOR CONDUCTED & E.I.R.P. TEST

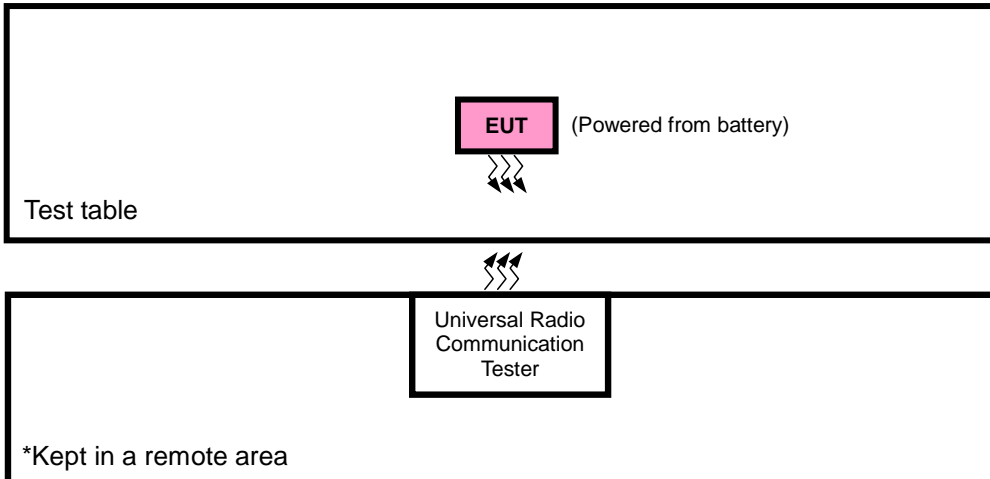



### 2.3 DESCRIPTION OF SUPPORT UNITS

The EUT has been tested as an independent unit together with other necessary accessories or support units. The following support units or accessories were used to form a representative test configuration during the tests.

NO.	PRODUCT	BRAND	MODEL NO.	SERIAL NO.	FCC ID
1	DC source	LONG WEI	PS-6403D	010934269	N/A
2	PC	HP	A6608CN	3CR83825X3	N/A

NO.	SIGNAL CABLE DESCRIPTION OF THE ABOVE SUPPORT UNITS
1	DC Line: Unshielded, Detachable 1.0m
2	AC Line: Unshielded, Detachable 1.5m

**NOTE:**

1. All power cords of the above support units are non shielded (1.8m).

### 2.4 TEST ITEM AND TEST CONFIGURATION

Pre-Scan has been conducted to determine the worst-case mode from all possible combinations between available modulations, data rates, XYZ axis and antenna ports

The worst case in EIRP and radiated emission was found when positioned on X-plane for WCDMA/ LTE. Following channel(s) was (were) selected for the final test as listed below:

EUT CONFIGURE MODE	DESCRIPTION
A	EUT + Adapter + USB Cable with WCDMA or LTE link
B	EUT + Battery with WCDMA or LTE link



WCDMA MODE

EUT CONFIGURE MODE	TEST ITEM	AVAILABLE CHANNEL	TESTED CHANNEL	MODE
B	EIRP	9262 to 9538	9262, 9400, 9538	WCDMA
B	FREQUENCY STABILITY	9262 to 9538	9262, 9538	WCDMA
B	OCCUPIED BANDWIDTH	9262 to 9538	9262, 9400, 9538	WCDMA
B	PEAK TO AVERAGE RATIO	9262 to 9538	9262, 9400, 9538	WCDMA
B	BAND EDGE	9262 to 9538	9262, 9538	WCDMA
B	CONDCUETED EMISSION	9262 to 9538	9262, 9400, 9538	WCDMA
A	RADIATED EMISSION	9262 to 9538	9262, 9400, 9538	WCDMA

LTE BAND 2

EUT CONFIGURE MODE	TEST ITEM	AVAILABLE CHANNEL	TESTED CHANNEL	CHANNEL BANDWIDTH	MODULATION	MODE
B	EIRP	18607 to 19193	18607, 18900, 19193	1.4MHz	QPSK,16QAM	1 RB / 0 RB Offset
		18615 to 19185	18615, 18900, 19185	3MHz	QPSK,16QAM	1 RB / 0 RB Offset
		18625 to 19175	18625, 18900, 19175	5MHz	QPSK,16QAM	1 RB / 0 RB Offset
		18650 to 19150	18650, 18900, 19150	10MHz	QPSK,16QAM	1 RB / 0 RB Offset
		18675 to 19125	18675, 18900, 19125	15MHz	QPSK,16QAM	1 RB / 0 RB Offset
		18700 to 19100	18700, 18900, 19100	20MHz	QPSK,16QAM	1 RB / 0 RB Offset
B	FREQUENCY STABILITY	18607 to 19193	18607, 19193	1.4MHz	QPSK	1 RB / 0 RB Offset
		18615 to 19185	18615, 19185	3MHz	QPSK	1 RB / 0 RB Offset
		18625 to 19175	18625, 19175	5MHz	QPSK	1 RB / 0 RB Offset
		18650 to 19150	18650, 19150	10MHz	QPSK	1 RB / 0 RB Offset
		18675 to 19125	18675, 19125	15MHz	QPSK	1 RB / 0 RB Offset
		18700 to 19100	18700, 19100	20MHz	QPSK	1 RB / 0 RB Offset
B	OCCUPIED BANDWIDTH	18607 to 19193	18607, 18900, 19193	1.4MHz	QPSK,16QAM	6 RB / 0 RB Offset
		18615 to 19185	18615, 18900, 19185	3MHz	QPSK,16QAM	15 RB / 0 RB Offset
		18625 to 19175	18625, 18900, 19175	5MHz	QPSK,16QAM	25 RB / 0 RB Offset
		18650 to 19150	18650, 18900, 19150	10MHz	QPSK	50 RB / 0 RB Offset
		18675 to 19125	18675, 18900, 19125	15MHz	QPSK	75 RB / 0 RB Offset
		18700 to 19100	18700, 18900, 19100	20MHz	QPSK	100 RB / 0 RB Offset
B	PEAK TO AVERAGE RATIO	18607 to 19193	18607, 18900, 19193	1.4MHz	QPSK,16QAM	1 RB / 0 RB Offset
		18615 to 19185	18615, 18900, 19185	3MHz	QPSK,16QAM	1 RB / 0 RB Offset
		18625 to 19175	18625, 18900, 19175	5MHz	QPSK,16QAM	1 RB / 0 RB Offset
		18650 to 19150	18650, 18900, 19150	10MHz	QPSK	1 RB / 0 RB Offset
		18675 to 19125	18675, 18900, 19125	15MHz	QPSK	1 RB / 0 RB Offset
		18700 to 19100	18700, 18900, 19100	20MHz	QPSK	1 RB / 0 RB Offset



B	BAND EDGE	18607 to 19193	18607	1.4MHz	QPSK	1 RB / 0 RB Offset		
			19193	1.4MHz	QPSK	6 RB / 0 RB Offset		
		18615 to 19185	18615	3MHz	QPSK	1 RB / 5 RB Offset		
			19185	3MHz	QPSK	6 RB / 0 RB Offset		
		18625 to 19175	18625	5MHz	QPSK	1 RB / 0 RB Offset		
			19175	5MHz	QPSK	15 RB / 0 RB Offset		
		18650 to 19150	18650	10MHz	QPSK	1 RB / 14 RB Offset		
			19150	10MHz	QPSK	15 RB / 0 RB Offset		
		18675 to 19125	18675	15MHz	QPSK	1 RB / 0 RB Offset		
			19125	15MHz	QPSK	25 RB / 0 RB Offset		
		18700 to 19100	18700	20MHz	QPSK	1 RB / 24 RB Offset		
			19100	20MHz	QPSK	25 RB / 0 RB Offset		
		B	CONDCUDED EMISSION	18607 to 19193	18607, 18900, 19193	1.4MHz	QPSK	1 RB / 0 RB Offset
				18615 to 19185	18615, 18900, 19185	3MHz	QPSK	50 RB / 0 RB Offset
				18625 to 19175	18625, 18900, 19175	5MHz	QPSK	1 RB / 49 RB Offset
				18650 to 19150	18650, 18900, 19150	10MHz	QPSK	50 RB / 0 RB Offset
18675 to 19125	18675, 18900, 19125			15MHz	QPSK	1 RB / 0 RB Offset		
18700 to 19100	18700, 18900, 19100			20MHz	QPSK	1 RB / 0 RB Offset		
A	RADIATED EMISSION	18607 to 19193	18607, 18900, 19193	1.4MHz	QPSK	1 RB / 0 RB Offset		
		18615 to 19185	18900	3MHz	QPSK	1 RB / 0 RB Offset		
		18625 to 19175	18900	5MHz	QPSK	1 RB / 0 RB Offset		
		18650 to 19150	18900	10MHz	QPSK	1 RB / 0 RB Offset		
		18675 to 19125	18900	15MHz	QPSK	1 RB / 0 RB Offset		
		18700 to 19100	18900	20MHz	QPSK	1 RB / 0 RB Offset		



**TEST CONDITION:**

TEST ITEM	ENVIRONMENTAL CONDITIONS	INPUT POWER	TESTED BY
EIRP	25deg. C, 57%RH	3.8Vdc from Battery	Rose Ma
FREQUENCY STABILITY	23deg. C, 61%RH	DC 3.5/3.8V/4.2	Rain Wang
OCCUPIED BANDWIDTH	23deg. C, 61%RH	3.8Vdc from Battery	Rain Wang
PEAK TO AVERAGE RATIO	23deg. C, 61%RH	3.8Vdc from Battery	Rain Wang
BAND EDGE	23deg. C, 61%RH	3.8Vdc from Battery	Rain Wang
CONDCUDED EMISSION	23deg. C, 61%RH	3.8Vdc from Battery	Rain Wang
RADIATED EMISSION	23deg. C, 70%RH	5Vdc from adapter	Rose Ma



## 2.5 EUT OPERATING CONDITIONS

The EUT makes a call to the communication simulator. The communication simulator station system controlled a EUT to export maximum output power under transmission mode and specific channel frequency

## 2.6 GENERAL DESCRIPTION OF APPLIED STANDARDS

The EUT is a RF product. According to the specifications of the manufacturer, it must comply with the requirements of the following standards:

**FCC 47 CFR Part 2**

**FCC 47 CFR Part 24**

**KDB 971168 D01 Power Meas License Digital Systems v03**

**ANSI/TIA/EIA-603-D**

**ANSI/TIA/EIA-603-E**

**ANSI C63.26-2015**

**NOTE:** All test items have been performed and recorded as per the above standards.



### 3 TEST TYPES AND RESULTS

#### 3.1 OUTPUT POWER MEASUREMENT

##### 3.1.1 LIMITS OF OUTPUT POWER MEASUREMENT

Mobile and portable stations are limited to 2 watts EIRP.

##### 3.1.2 TEST PROCEDURES

###### **EIRP MEASUREMENT:**

- a. All measurements were done at low, middle and high operational frequency range. RBW and VBW is 5MHz for WCDMA mode and 10MHz for LTE mode.
- b. Substitution method is used for E.I.R.P measurement. In the semi-anechoic chamber, EUT placed on the 0.8m height of Turn Table, rotated the table around 360 degrees to search the maximum radiation power and receiver antenna shall be rotated vertical and horizontal polarization and moved height from 1m to 4m to find the maximum polar radiated power. The “Read Value” is the spectrum reading the maximum power value.
- c. The substitution horn antenna is substituted for EUT at the same position and signals generator export the CW signal to the substitution antenna via a tx cable. Rotated the Turn Table and moved receiving antenna to find the maximum radiation power. Adjust output power level of S.G to get a Value of spectrum reading equal to “Read Value “ of step b. Record the power level of S.G
- d.  $EIRP = \text{Output power level of S.G} - \text{TX cable loss} + \text{Antenna gain of substitution horn.}$

###### **CONDUCTED POWER MEASUREMENT:**

The EUT was set up for the maximum power with WCDMA link data modulation and link up with simulator. Set the EUT to transmit under low, middle and high channel and record the power level shown on simulator.



### 3.1.3 TEST SETUP

#### EIRP / ERP Measurement:

<Radiated Emission below or equal 1 GHz>

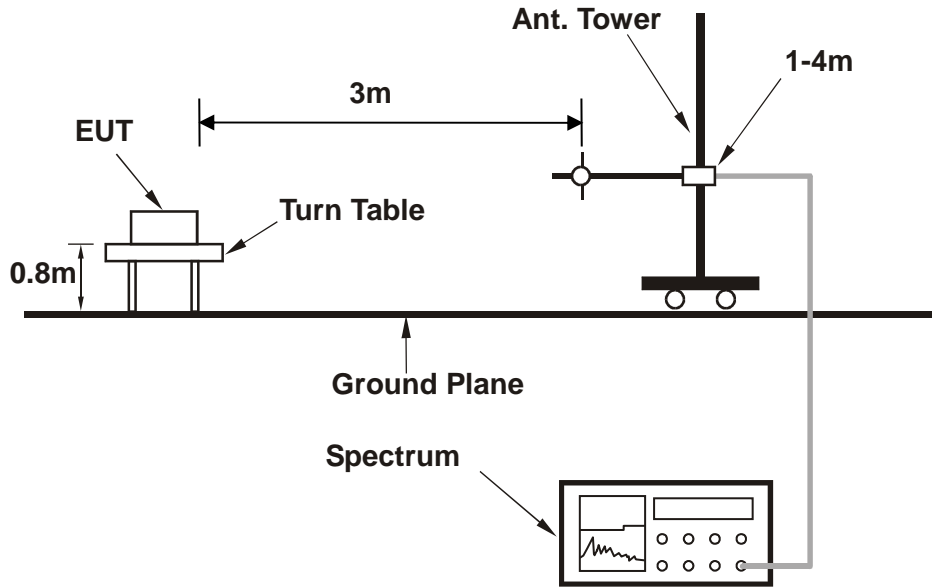

<Radiated Emission above 1 GHz>

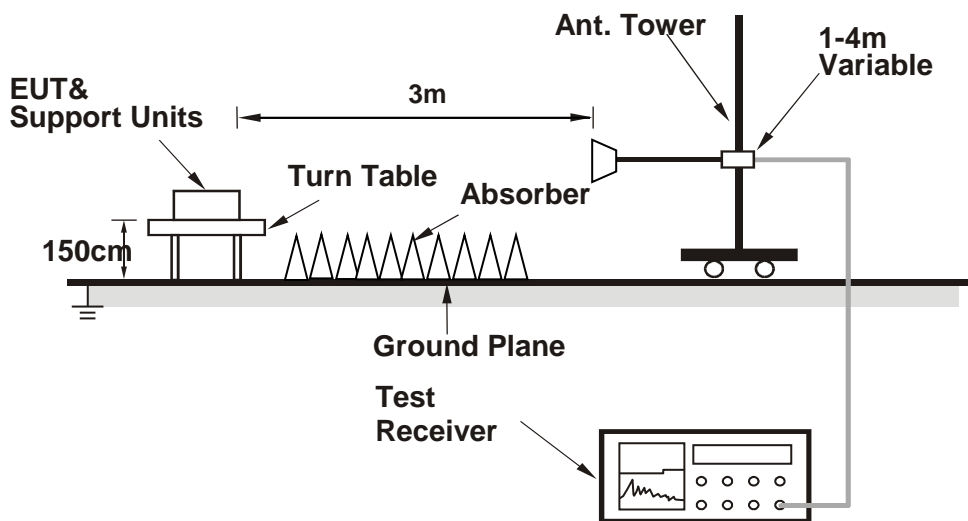

For the actual test configuration, please refer to the attached file (Test Setup Photo).

#### CONDUCTED POWER MEASUREMENT:

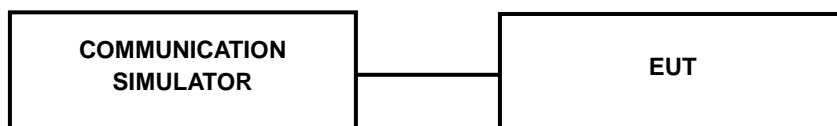





### 3.1.4 TEST RESULTS

#### CONDUCTED OUTPUT POWER (dBm)

Band	WCDMA II		
	9262	9400	9538
Channel	1852.4	1880.0	1907.6
Frequency (MHz)	1852.4	1880.0	1907.6
RMC 12.2K	22.86	22.89	<b>22.95</b>
HSPA			
HSDPA Subtest-1	21.93	21.96	22.02
HSDPA Subtest-2	21.87	21.90	21.96
HSDPA Subtest-3	21.56	21.59	21.65
HSDPA Subtest-4	21.50	21.53	21.59
HSUPA Subtest-1	21.81	21.84	21.90
HSUPA Subtest-2	19.99	20.02	20.08
HSUPA Subtest-3	20.86	20.89	20.95
HSUPA Subtest-4	19.94	19.97	20.03
HSUPA Subtest-5	21.74	21.77	21.83



LTE Band 2							
BW	Modulation	RB Size	RB Offset	Low CH 18607	Mid CH 18900	High CH 19193	3GPP MPR (dB)
				Frequency 1850.7 MHz	Frequency 1880 MHz	Frequency 1909.3 MHz	
1.4MHz	QPSK	1	0	21.65	21.55	21.73	0
		1	2	21.41	21.31	21.49	0
		1	5	21.54	21.44	21.62	0
		3	0	21.64	21.54	21.72	0
		3	1	21.40	21.30	21.48	0
		3	3	21.53	21.43	21.61	0
		6	0	20.57	20.47	20.65	1
	16QAM	1	0	20.51	20.41	20.59	1
		1	2	20.03	19.93	20.11	1
		1	5	19.95	19.85	20.03	1
		3	0	19.55	19.45	19.63	1
		3	1	19.48	19.38	19.56	1
		3	3	19.44	19.34	19.52	1
		6	0	19.40	19.30	19.48	2
BW	Modulation	RB Size	RB Offset	Low CH 18615	Mid CH 18900	High CH 19185	3GPP MPR (dB)
				Frequency 1851.5 MHz	Frequency 1880 MHz	Frequency 1908.5 MHz	
3 MHz	QPSK	1	0	21.68	21.58	21.76	0
		1	7	21.44	21.34	21.52	0
		1	14	21.57	21.47	21.65	0
		8	0	20.67	20.57	20.75	1
		8	3	20.44	20.34	20.52	1
		8	7	20.48	20.38	20.56	1
		15	0	20.60	20.50	20.68	1
	16QAM	1	0	20.54	20.44	20.62	1
		1	7	20.06	19.96	20.14	1
		1	14	19.98	19.88	20.06	1
		8	0	19.58	19.48	19.66	2
		8	3	19.51	19.41	19.59	2
		8	7	19.47	19.37	19.55	2
		15	0	19.43	19.33	19.51	2



LTE Band 2							
BW	Modulation	RB Size	RB Offset	Low CH 18625	Mid CH 18900	High CH 19175	3GPP MPR (dB)
				Frequency 1852.5 MHz	Frequency 1880 MHz	Frequency 1907.5 MHz	
5 MHz	QPSK	1	0	21.71	21.61	21.79	0
		1	12	21.47	21.37	21.55	0
		1	24	21.60	21.50	21.68	0
		12	0	20.70	20.60	20.78	1
		12	6	20.47	20.37	20.55	1
		12	13	20.51	20.41	20.59	1
		25	0	20.63	20.53	20.71	1
	16QAM	1	0	20.57	20.47	20.65	1
		1	12	20.09	19.99	20.17	1
		1	24	20.01	19.91	20.09	1
		12	0	19.61	19.51	19.69	2
		12	6	19.54	19.44	19.62	2
		12	13	19.50	19.40	19.58	2
		25	0	19.46	19.36	19.54	2
BW	Modulation	RB Size	RB Offset	Low CH 18650	Mid CH 18900	High CH 19150	3GPP MPR (dB)
				Frequency 1855 MHz	Frequency 1880 MHz	Frequency 1905 MHz	
10 MHz	QPSK	1	0	21.73	21.63	21.81	0
		1	24	21.49	21.39	21.57	0
		1	49	21.62	21.52	21.70	0
		25	0	20.72	20.62	20.80	1
		25	12	20.49	20.39	20.57	1
		25	25	20.53	20.43	20.61	1
		50	0	20.65	20.55	20.73	1
	16QAM	1	0	20.59	20.49	20.67	1
		1	24	20.11	20.01	20.19	1
		1	49	20.03	19.93	20.11	1



LTE Band 2							
BW	Modulation	RB Size	RB Offset	Low CH 18675	Mid CH 18900	High CH 19125	3GPP MPR (dB)
				Frequency 1857.5 MHz	Frequency 1880 MHz	Frequency 1902.5 MHz	
15 MHz	QPSK	1	0	21.76	21.66	21.84	0
		1	37	21.52	21.42	21.60	0
		1	74	21.65	21.55	21.73	0
		36	0	20.75	20.65	20.83	1
		36	19	20.52	20.42	20.60	1
		36	39	20.56	20.46	20.64	1
	75	0	20.68	20.58	20.76	1	
	16QAM	1	0	20.62	20.52	20.70	1
		1	37	20.14	20.04	20.22	1
1		74	20.06	19.96	20.14	1	
BW	Modulation	RB Size	RB Offset	Low CH 18700	Mid CH 18900	High CH 19100	3GPP MPR (dB)
				Frequency 1860 MHz	Frequency 1880 MHz	Frequency 1900 MHz	
20MHz	QPSK	1	0	21.81	21.71	<b>21.89</b>	0
		1	50	21.57	21.47	21.65	0
		1	99	21.70	21.60	21.78	0
		50	0	20.80	20.70	20.88	1
		50	25	20.57	20.47	20.65	1
		50	50	20.61	20.51	20.69	1
	100	0	20.73	20.63	20.81	1	
	16QAM	1	0	20.67	20.57	20.75	1
		1	50	20.19	20.09	20.27	1
1		99	20.11	20.01	20.19	1	



**EIRP POWER (dBm)**

**WCDMA**

Channel	Frequency (MHz)	SPA LVL (dBm)	Correction Factor(dB)	EIRP(dBm)	EIRP(mW)	Polarization (H/V)
9262	1852.4	-21.62	43.83	22.21	166.34	H
9400	1880.0	-21.69	43.57	21.88	154.17	H
9538	1907.6	-21.76	44.57	22.81	<b>190.99</b>	H
9262	1852.4	-30.23	46.39	16.16	41.30	V
9400	1880.0	-31.39	47.10	15.71	37.22	V
9538	1907.6	-30.45	45.98	15.53	35.69	V

**REMARKS:** 1. EIRP Output Power (dBm) = SPA LVL (dBm) + Correction Factor (dB).

2. Correction factor (dB) = Free Space Loss + Antenna Factor + Cable Loss

**LTE BAND 2**

**CHANNEL BANDWIDTH: 1.4MHz QPSK**

Channel	Frequency (MHz)	SPA LVL (dBm)	Correction Factor(dB)	EIRP(dBm)	EIRP(mW)	Polarization (H/V)	LIMIT (W)
18607	1850.7	-19.99	43.83	23.84	242.33	H	2
18900	1880.0	-20.04	43.57	23.53	225.42	H	2
19193	1909.3	-20.17	44.32	24.15	<b>259.96</b>	H	2
18607	1850.7	-28.91	46.41	17.50	56.25	V	2
18900	1880.0	-28.94	47.07	18.13	65.01	V	2
19193	1909.3	-29.06	45.88	16.82	48.13	V	2

**CHANNEL BANDWIDTH: 1.4MHz 16QAM**

Channel	Frequency (MHz)	SPA LVL (dBm)	Correction Factor(dB)	EIRP(dBm)	EIRP(mW)	Polarization (H/V)	LIMIT (W)
18607	1850.7	-20.86	43.83	22.97	198.34	H	2
18900	1880.0	-20.97	43.57	22.60	181.97	H	2
19193	1909.3	-21.13	44.32	23.19	208.40	H	2
18607	1850.7	-29.78	46.41	16.63	46.04	V	2
18900	1880.0	-29.87	47.07	17.20	52.48	V	2
19193	1909.3	-30.02	45.88	15.86	38.58	V	2



CHANNEL BANDWIDTH: 3MHz QPSK

Channel	Frequency (MHz)	SPA LVL (dBm)	Correction Factor(dB)	EIRP(dBm)	EIRP(mW)	Polarization (H/V)	LIMIT (W)
18615	1851.5	-19.97	43.82	23.85	242.77	H	2
18900	1880.0	-20.10	43.57	23.47	222.33	H	2
19185	1908.5	-20.12	44.38	24.26	<b>266.44</b>	H	2
18615	1851.5	-28.89	46.45	17.56	57.03	V	2
18900	1880.0	-29.00	47.07	18.07	64.12	V	2
19185	1908.5	-29.01	45.88	16.87	48.64	V	2

CHANNEL BANDWIDTH: 3MHz 16QAM

Channel	Frequency (MHz)	SPA LVL (dBm)	Correction Factor(dB)	EIRP(dBm)	EIRP(mW)	Polarization (H/V)	LIMIT (W)
18615	1851.5	-21.04	43.82	22.78	189.76	H	2
18900	1880.0	-20.99	43.57	22.58	181.13	H	2
19185	1908.5	-21.11	44.38	23.27	212.13	H	2
18615	1851.5	-29.96	46.45	16.49	44.58	V	2
18900	1880.0	-29.89	47.07	17.18	52.24	V	2
19185	1908.5	-30.00	45.88	15.88	38.73	V	2

CHANNEL BANDWIDTH: 5MHz QPSK

Channel	Frequency (MHz)	SPA LVL (dBm)	Correction Factor(dB)	EIRP(dBm)	EIRP(mW)	Polarization (H/V)	LIMIT (W)
18625	1852.5	-20.03	43.83	23.80	239.77	H	2
18900	1880.0	-20.05	43.57	23.52	224.91	H	2
19175	1907.5	-20.07	44.19	24.12	<b>258.11</b>	H	2
18625	1852.5	-28.95	46.46	17.51	56.40	V	2
18900	1880.0	-28.95	47.07	18.12	64.86	V	2
19175	1907.5	-28.96	45.89	16.93	49.33	V	2



CHANNEL BANDWIDTH: 5MHz 16QAM

Channel	Frequency (MHz)	SPA LVL (dBm)	Correction Factor(dB)	EIRP(dBm)	EIRP(mW)	Polarization (H/V)	LIMIT (W)
18625	1852.5	-20.86	43.83	22.97	198.06	H	2
18900	1880.0	-21.07	43.57	22.50	177.83	H	2
19175	1907.5	-21.17	44.19	23.02	200.35	H	2
18625	1852.5	-29.78	46.46	16.68	46.59	V	2
18900	1880.0	-29.97	47.07	17.10	51.29	V	2
19175	1907.5	-30.06	45.89	15.83	38.29	V	2

CHANNEL BANDWIDTH: 10MHz QPSK

Channel	Frequency (MHz)	SPA LVL (dBm)	Correction Factor(dB)	EIRP(dBm)	EIRP(mW)	Polarization (H/V)	LIMIT (W)
18650	1855.0	-19.84	43.86	24.02	252.41	H	2
18900	1880.0	-19.99	43.57	23.58	228.03	H	2
19150	1905.0	-19.94	43.99	24.05	<b>254.33</b>	H	2
18650	1855.0	-28.76	46.28	17.52	56.47	V	2
18900	1880.0	-28.89	47.07	18.18	65.77	V	2
19150	1905.0	-28.83	45.92	17.09	51.19	V	2

CHANNEL BANDWIDTH: 10MHz 16QAM

Channel	Frequency (MHz)	SPA LVL (dBm)	Correction Factor(dB)	EIRP(dBm)	EIRP(mW)	Polarization (H/V)	LIMIT (W)
18650	1855.0	-20.99	43.86	22.87	193.69	H	2
18900	1880.0	-21.09	43.57	22.48	177.01	H	2
19150	1905.0	-21.10	43.99	22.89	194.72	H	2
18650	1855.0	-29.91	46.28	16.37	43.33	V	2
18900	1880.0	-29.99	47.07	17.08	51.05	V	2
19150	1905.0	-29.99	45.92	15.93	39.19	V	2



**CHANNEL BANDWIDTH: 15MHz QPSK**

Channel	Frequency (MHz)	SPA LVL (dBm)	Correction Factor(dB)	EIRP(dBm)	EIRP(mW)	Polarization (H/V)	LIMIT (W)
18675	1857.5	-19.85	43.99	23.88	<b>244.34</b>	H	2
18900	1880.0	-20.06	43.57	23.35	216.27	H	2
19125	1902.5	-20.01	43.66	23.74	236.59	H	2
18675	1857.5	-28.77	45.93	17.33	54.08	V	2
18900	1880.0	-28.96	47.07	18.05	63.83	V	2
19125	1902.5	-28.90	46.20	16.88	48.75	V	2

**CHANNEL BANDWIDTH: 15MHz 16QAM**

Channel	Frequency (MHz)	SPA LVL (dBm)	Correction Factor(dB)	EIRP(dBm)	EIRP(mW)	Polarization (H/V)	LIMIT (W)
18675	1857.5	-20.71	43.99	22.35	171.79	H	2
18900	1880.0	-20.93	43.57	22.14	163.68	H	2
19125	1902.5	-20.86	43.66	22.33	171.00	H	2
18675	1857.5	-29.63	45.93	16.15	41.21	V	2
18900	1880.0	-29.83	47.07	16.78	47.64	V	2
19125	1902.5	-29.75	46.20	15.65	36.73	V	2

**CHANNEL BANDWIDTH: 20MHz QPSK**

Channel	Frequency (MHz)	SPA LVL (dBm)	Correction Factor(dB)	EIRP(dBm)	EIRP(mW)	Polarization (H/V)	LIMIT (W)
18700	1860.0	-20.43	43.50	23.07	<b>202.72</b>	H	2
18900	1880.0	-20.51	43.57	23.06	202.30	H	2
19100	1900.0	-20.59	43.62	23.03	200.72	H	2
18700	1860.0	-29.35	45.57	16.22	41.88	V	2
18900	1880.0	-29.41	47.07	17.66	58.34	V	2
19100	1900.0	-29.48	46.26	16.78	47.65	V	2





**CHANNEL BANDWIDTH: 20MHz 16QAM**

Channel	Frequency (MHz)	SPA LVL (dBm)	Correction Factor(dB)	EIRP(dBm)	EIRP(mW)	Polarization (H/V)	LIMIT (W)
18700	1860.0	-21.36	43.50	22.14	163.64	H	2
18900	1880.0	-21.58	43.57	21.99	158.12	H	2
19100	1900.0	-21.42	43.62	22.20	165.81	H	2
18700	1860.0	-30.28	45.57	15.29	33.81	V	2
18900	1880.0	-30.48	47.07	16.59	45.60	V	2
19100	1900.0	-30.31	46.26	15.95	39.36	V	2

**REMARKS:** 1. EIRP Output Power (dBm) = SPA LVL (dBm) + Correction Factor (dB).

2. Correction factor (dB) = Free Space Loss + Antenna Factor + Cable Loss



### 3.2 FREQUENCY STABILITY MEASUREMENT

#### 3.2.1 LIMITS OF FREQUENCY STABILITY MEASUREMENT

The frequency stability shall be sufficient to ensure that the fundamental emission stays within the authorized frequency block.

#### 3.2.2 TEST PROCEDURE

- a. Device is placed at the oven room. The oven room could control the temperatures and humidity. Power warm up is at least 15 min and power applied should perform before recording frequency error.
- b. EUT is connected the external power supply to control the DC input power. The test voltage range is from minimum to maximum working voltage. Each step shall be record the frequency error rate.
- c. The temperature range step is 10 degrees in this test items. All temperature levels shall be hold the  $\pm 0.5^{\circ}\text{C}$  during the measurement testing. The each temperature step shall be at least 0.5 hours, consider the EUT could be test under the stability condition.

**NOTE:** The frequency error was recorded frequency error from the communication simulator.

#### 3.2.3 TEST SETUP

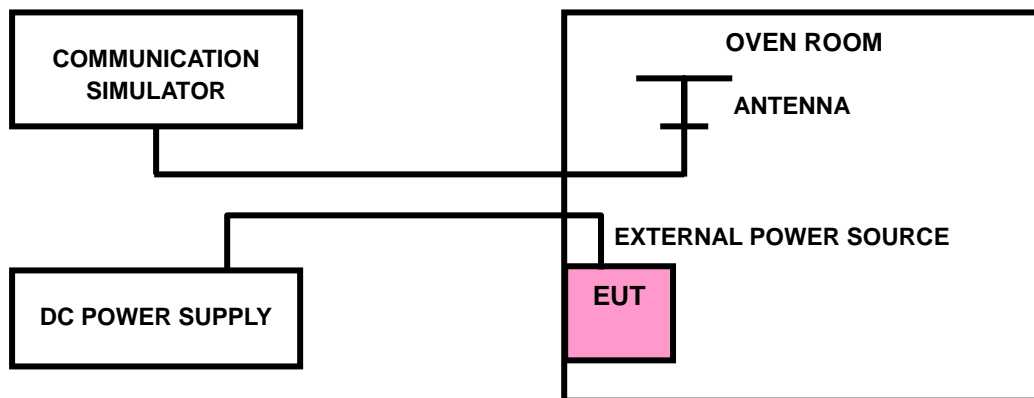



### 3.2.4 TEST RESULTS

#### WCDMA BAND II

##### FREQUENCY ERROR VS. VOLTAGE

VOLTAGE (Volts)	FREQUENCY ERROR (ppm)		LIMIT (ppm)
	Low Channel	High Channel	
3.8	0.0010	0.0010	2.5
3.5	-0.0011	-0.0007	2.5
4.2	0.0010	0.0013	2.5

**NOTE:** The applicant defined the normal working voltage of the battery is from 3.5Vdc to 4.2dc.

##### FREQUENCY ERROR vs. TEMPERATURE.

TEMP. (°C)	FREQUENCY ERROR (ppm)		LIMIT (ppm)
	Low Channel	High Channel	
-30	-0.0056	-0.0049	2.5
-20	-0.0055	-0.0048	2.5
-10	-0.0053	-0.0044	2.5
0	-0.0049	-0.0038	2.5
10	-0.0042	-0.0038	2.5
20	-0.0035	-0.0027	2.5
30	-0.0029	-0.0024	2.5
40	-0.0026	-0.0022	2.5
50	0.0000	0.0002	2.5



**LTE BAND 2**

**FREQUENCY ERROR VS. VOLTAGE**

VOLTAGE (Volts)	1.4MHz		LIMIT (ppm)
	FREQUENCY ERROR (ppm)		
	Low Channel	High Channel	
3.8	0.0008	0.0009	2.5
3.5	-0.0010	-0.0010	2.5
4.2	0.0007	0.0009	2.5

**NOTE:** The applicant defined the normal working voltage of the battery is from 3.5Vdc to 4.2dc.

**FREQUENCY ERROR vs. TEMPERATURE.**

TEMP. (°C)	1.4MHz		LIMIT (ppm)
	FREQUENCY ERROR (ppm)		
	Low Channel	High Channel	
-30	-0.0051	-0.0052	2.5
-20	-0.0046	-0.0048	2.5
-10	-0.0041	-0.0042	2.5
0	-0.0037	-0.0036	2.5
10	-0.0028	-0.0025	2.5
20	-0.0022	-0.0023	2.5
30	-0.0016	-0.0016	2.5
40	-0.0009	-0.0006	2.5
50	-0.0003	-0.0005	2.5



**FREQUENCY ERROR VS. VOLTAGE**

VOLTAGE (Volts)	3MHz		LIMIT (ppm)
	FREQUENCY ERROR (ppm)		
	Low Channel	High Channel	
3.8	0.0009	0.0010	2.5
3.5	-0.0011	-0.0011	2.5
4.2	0.0010	0.0010	2.5

**NOTE:** The applicant defined the normal working voltage of the battery is from 3.5Vdc to 4.2dc.

**FREQUENCY ERROR vs. TEMPERATURE.**

TEMP. (°C)	3MHz		LIMIT (ppm)
	FREQUENCY ERROR (ppm)		
	Low Channel	High Channel	
-30	-0.0054	-0.0055	2.5
-20	-0.0049	-0.0050	2.5
-10	-0.0043	-0.0036	2.5
0	-0.0036	-0.0031	2.5
10	-0.0033	-0.0029	2.5
20	-0.0018	-0.0024	2.5
30	-0.0013	-0.0014	2.5
40	-0.0007	-0.0007	2.5
50	-0.0006	-0.0004	2.5



**FREQUENCY ERROR VS. VOLTAGE**

VOLTAGE (Volts)	5MHz		LIMIT (ppm)
	FREQUENCY ERROR (ppm)		
	Low Channel	High Channel	
3.8	0.0010	0.0012	2.5
3.5	-0.0012	-0.0013	2.5
4.2	0.0010	0.0010	2.5

**NOTE:** The applicant defined the normal working voltage of the battery is from 3.5Vdc to 4.2dc.

**FREQUENCY ERROR vs. TEMPERATURE.**

TEMP. (°C)	5MHz		LIMIT (ppm)
	FREQUENCY ERROR (ppm)		
	Low Channel	High Channel	
-30	-0.0052	-0.0053	2.5
-20	-0.0048	-0.0047	2.5
-10	-0.0044	-0.0039	2.5
0	-0.0038	-0.0032	2.5
10	-0.0033	-0.0026	2.5
20	-0.0027	-0.0018	2.5
30	-0.0023	-0.0011	2.5
40	-0.0013	-0.0007	2.5
50	0.0003	0.0002	2.5



**FREQUENCY ERROR VS. VOLTAGE**

VOLTAGE (Volts)	10MHz		LIMIT (ppm)
	FREQUENCY ERROR (ppm)		
	Low Channel	High Channel	
3.8	0.0012	0.0009	2.5
3.5	-0.0014	-0.0011	2.5
4.2	0.0011	0.0009	2.5

**NOTE:** The applicant defined the normal working voltage of the battery is from 3.5Vdc to 4.2dc.

**FREQUENCY ERROR vs. TEMPERATURE.**

TEMP. (°C)	10MHz		LIMIT (ppm)
	FREQUENCY ERROR (ppm)		
	Low Channel	High Channel	
-30	-0.0062	-0.0054	2.5
-20	-0.0052	-0.0047	2.5
-10	-0.0043	-0.0043	2.5
0	-0.0038	-0.0036	2.5
10	-0.0031	-0.0025	2.5
20	-0.0020	-0.0020	2.5
30	-0.0014	-0.0013	2.5
40	-0.0006	-0.0010	2.5
50	0.0003	0.0001	2.5



**FREQUENCY ERROR VS. VOLTAGE**

VOLTAGE (Volts)	15MHz		LIMIT (ppm)
	FREQUENCY ERROR (ppm)		
	Low Channel	High Channel	
3.8	0.0011	0.0011	2.5
3.5	-0.0011	-0.0012	2.5
4.2	0.0009	0.0010	2.5

**NOTE:** The applicant defined the normal working voltage of the battery is from 3.5Vdc to 4.2dc.

**FREQUENCY ERROR vs. TEMPERATURE.**

TEMP. (°C)	15MHz		LIMIT (ppm)
	FREQUENCY ERROR (ppm)		
	Low Channel	High Channel	
-30	-0.0044	-0.0046	2.5
-20	-0.0039	-0.0031	2.5
-10	-0.0035	-0.0030	2.5
0	-0.0026	-0.0028	2.5
10	-0.0020	-0.0020	2.5
20	-0.0016	-0.0014	2.5
30	-0.0012	-0.0005	2.5
40	-0.0006	-0.0004	2.5
50	0.0004	0.0002	2.5





**FREQUENCY ERROR VS. VOLTAGE**

VOLTAGE (Volts)	20MHz		LIMIT (ppm)
	FREQUENCY ERROR (ppm)		
	Low Channel	High Channel	
3.8	0.0012	0.0012	2.5
3.5	-0.0012	-0.0012	2.5
4.2	0.0010	0.0012	2.5

**NOTE:** The applicant defined the normal working voltage of the battery is from 3.5Vdc to 4.2dc.

**FREQUENCY ERROR vs. TEMPERATURE.**

TEMP. (°C)	20MHz		LIMIT (ppm)
	FREQUENCY ERROR (ppm)		
	Low Channel	High Channel	
-30	-0.0048	-0.0047	2.5
-20	-0.0043	-0.0036	2.5
-10	-0.0039	-0.0035	2.5
0	-0.0031	-0.0027	2.5
10	-0.0023	-0.0022	2.5
20	-0.0017	-0.0015	2.5
30	-0.0007	-0.0007	2.5
40	-0.0002	-0.0003	2.5
50	0.0003	0.0003	2.5



### 3.3 OCCUPIED BANDWIDTH MEASUREMENT

#### 3.3.1 TEST PROCEDURES

The EUT makes a call to the communication simulator. All measurements were done at low, middle and high operational frequency range. The communication simulator station system controlled a EUT to export maximum output power under transmission mode and specific channel frequency. Use OBW measurement function of Spectrum analyzer to measure 99 % occupied bandwidth.

#### 3.3.2 TEST SETUP

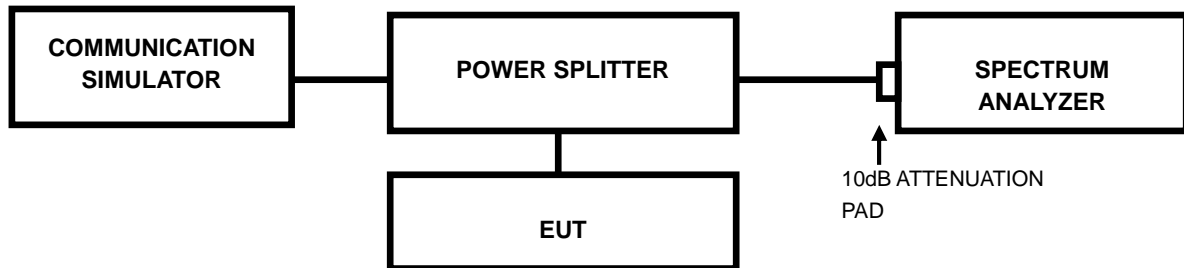



### 3.3.3 TEST RESULTS

CHANNEL	Frequency (MHz)	99% OCCUPIED Bandwidth (MHz)	CHANNEL	Frequency (MHz)	26dB Bandwidth (MHz)
		WCDMA			WCDMA
9262	1852.4	4.14	9262	1852.4	4.74
9400	1880.0	4.14	9400	1880.0	4.73
9538	1907.6	4.14	9538	1907.6	4.76

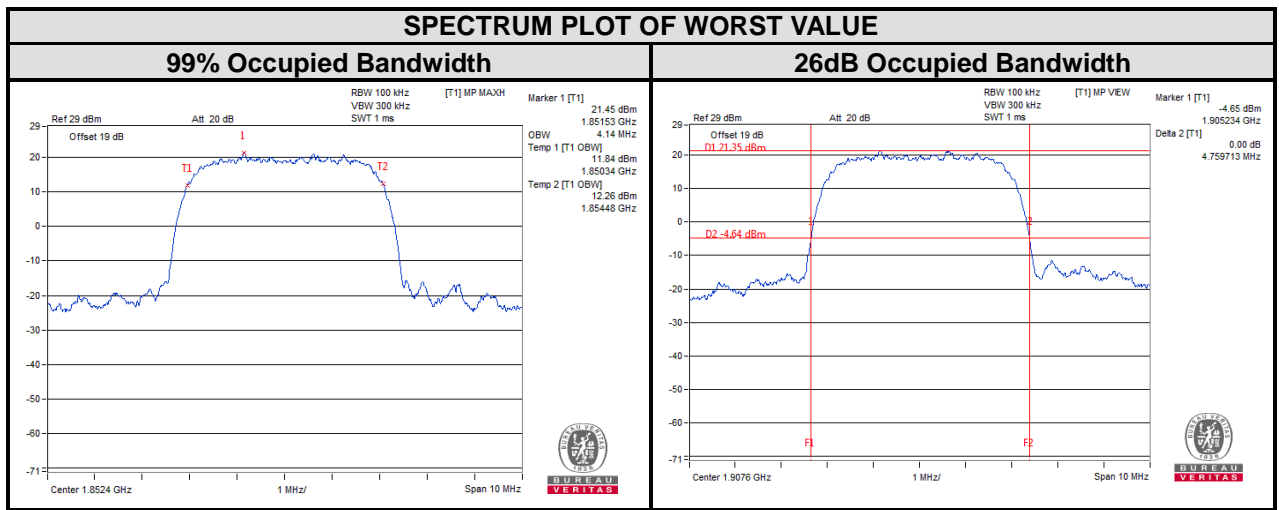



LTE band 2							
Channel Bandwidth : 1.4MHz							
Channel	Frequency (MHz)	99% Occupied bandwidth (MHz)		Channel	Frequency (MHz)	26dB bandwidth (MHz)	
		QPSK	16QAM			QPSK	16QAM
18607	1850.7	1.09	1.08	18607	1850.7	1.26	1.27
18900	1880	1.09	1.08	18900	1880	1.27	1.28
19193	1909.3	1.09	1.08	19193	1909.3	1.27	1.27

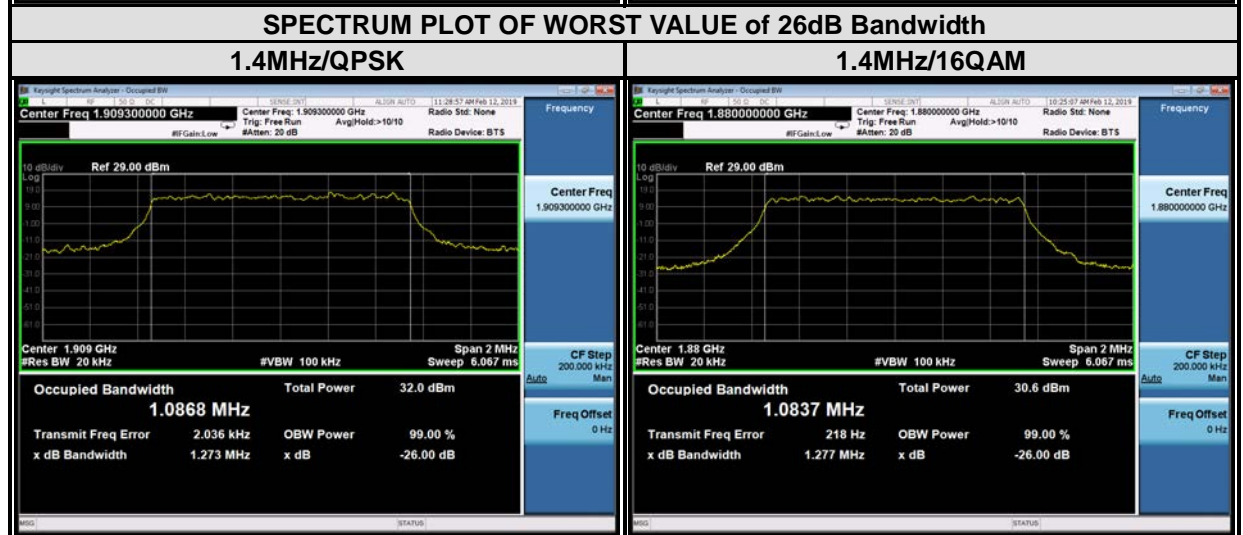
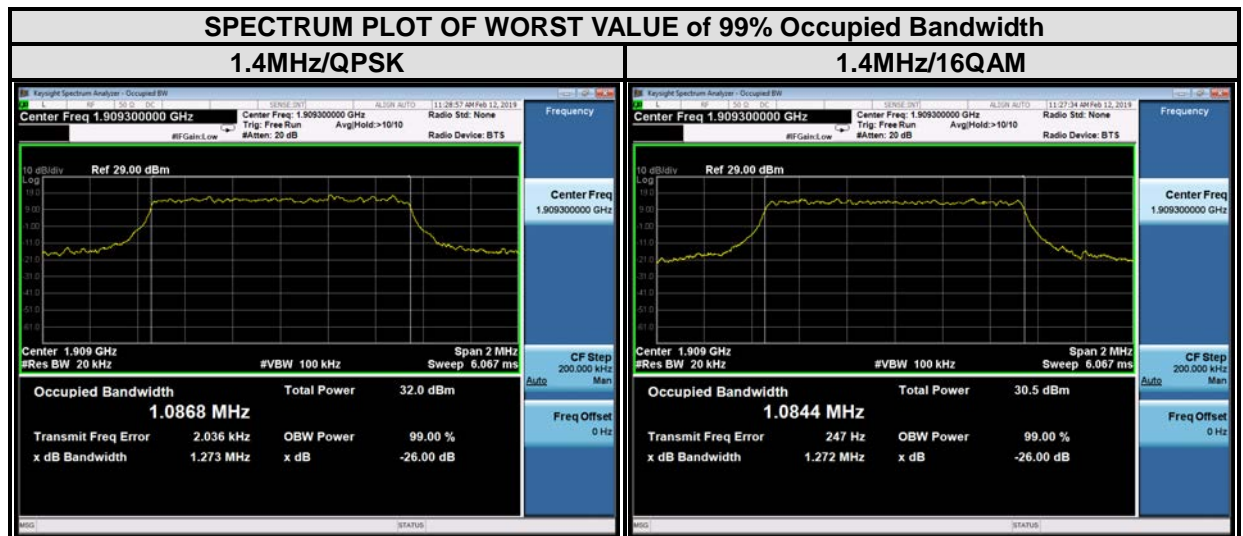



LTE band 2							
Channel Bandwidth : 3MHz							
Channel	Frequency (MHz)	99% Occupied bandwidth (MHz)		Channel	Frequency (MHz)	26dB bandwidth (MHz)	
		QPSK	16QAM			QPSK	16QAM
18615	1851.5	2.68	2.68	18615	1851.5	2.97	2.92
18900	1880	2.68	2.68	18900	1880	2.95	2.92
19185	1908.5	2.69	2.68	19185	1908.5	2.97	2.97

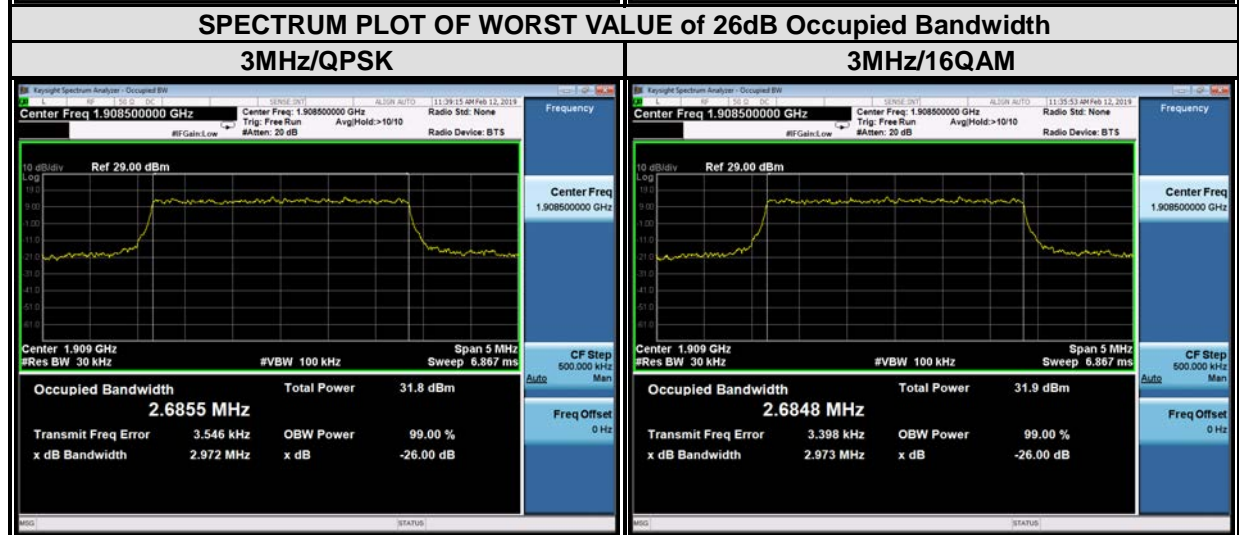
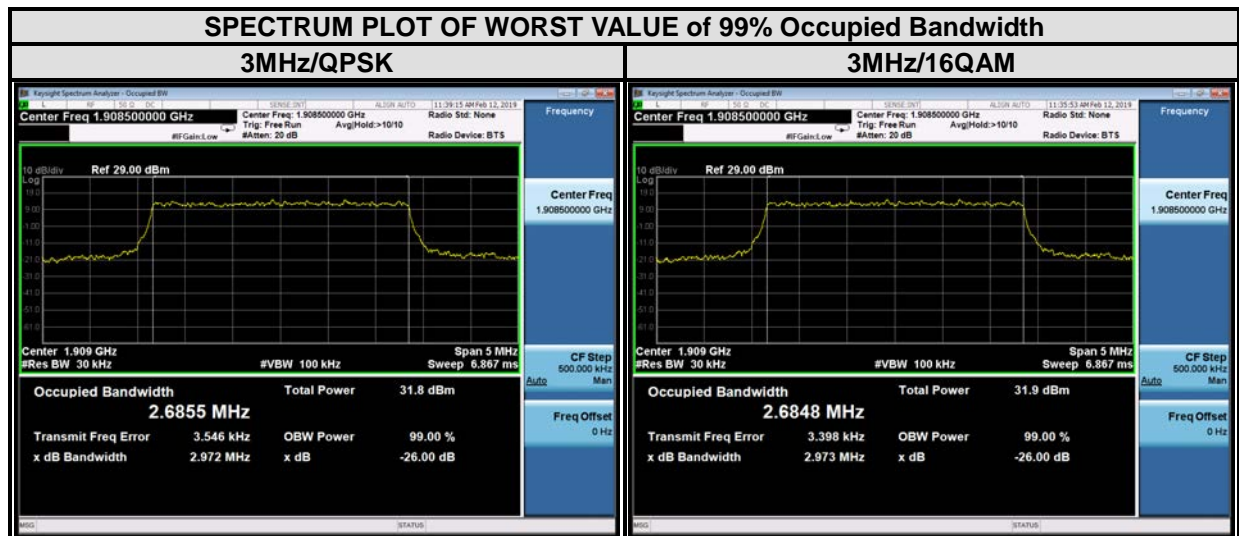



**BUREAU  
VERITAS**

Test Report No.: RF190123W002-3

LTE band 2							
Channel Bandwidth : 5 MHz							
Channel	Frequency (MHz)	99% Occupied bandwidth (MHz)		Channel	Frequency (MHz)	26dB bandwidth (MHz)	
		QPSK	16QAM			QPSK	16QAM
18625	1852.5	4.47	4.46	18625	1852.5	4.91	4.90
18900	1880	4.48	4.46	18900	1880	4.90	4.88
19175	1907.5	4.48	4.47	19175	1907.5	4.94	4.92

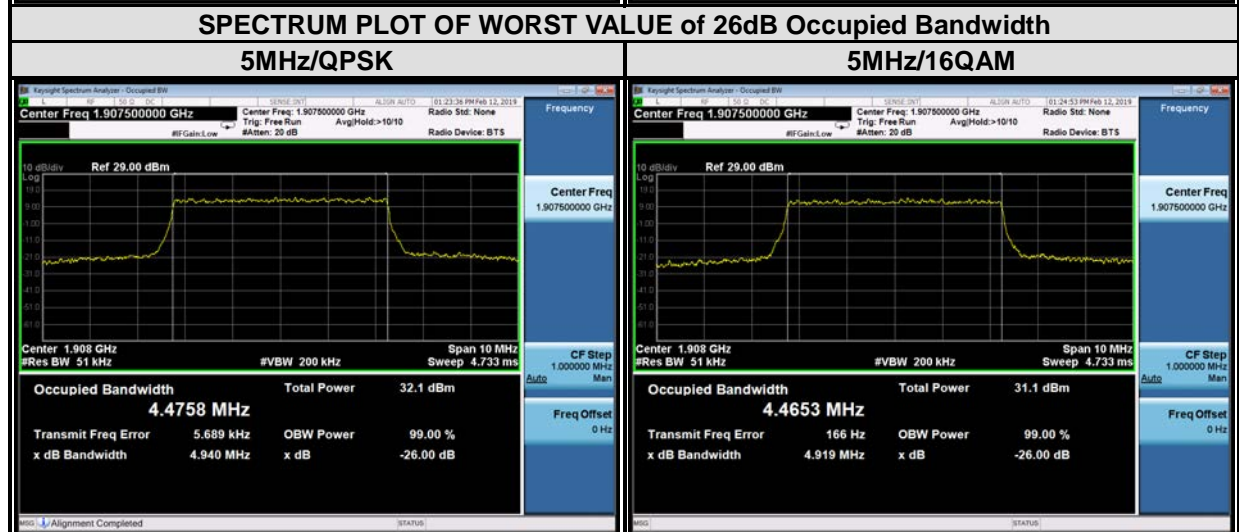
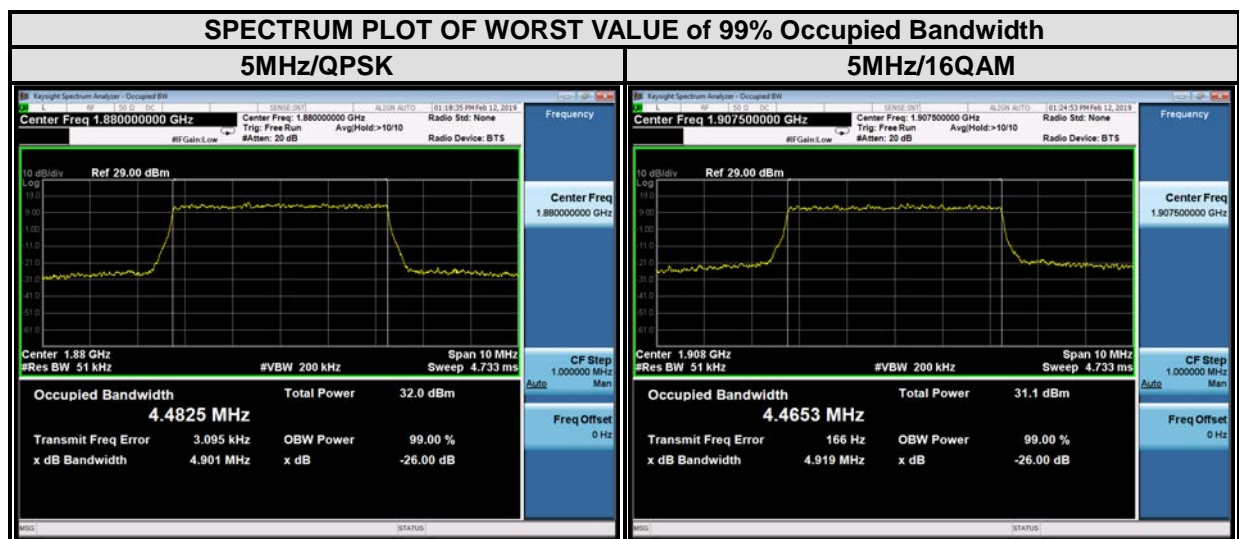



LTE band 2					
Channel Bandwidth : 10 MHz					
Channel	Frequency (MHz)	99% Occupied bandwidth (MHz)	Channel	Frequency (MHz)	26dB bandwidth (MHz)
		QPSK			QPSK
18650	1855	8.92	18650	1855	9.68
18900	1880	8.92	18900	1880	9.68
19150	1905	8.93	19150	1905	9.75

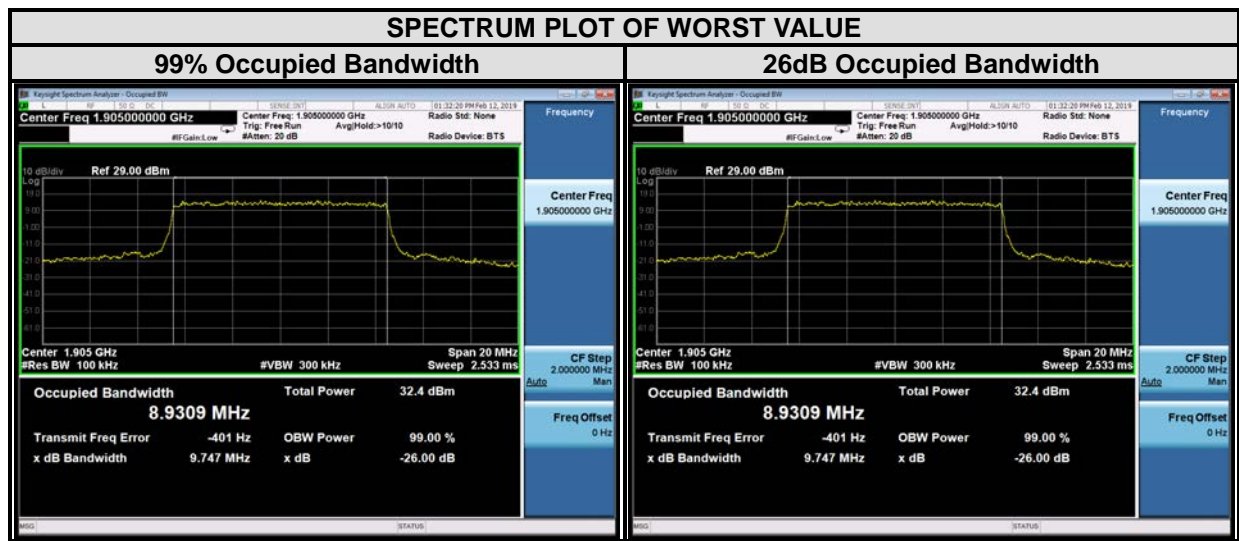



LTE band 2					
Channel Bandwidth : 15MHz					
Channel	Frequency (MHz)	99% Occupied bandwidth (MHz)	Channel	Frequency (MHz)	26dB bandwidth (MHz)
		QPSK			QPSK
18675	1857.5	13.36	18675	1857.5	14.43
18900	1880	13.36	18900	1880	14.39
19125	1902.5	13.39	19125	1902.5	14.63

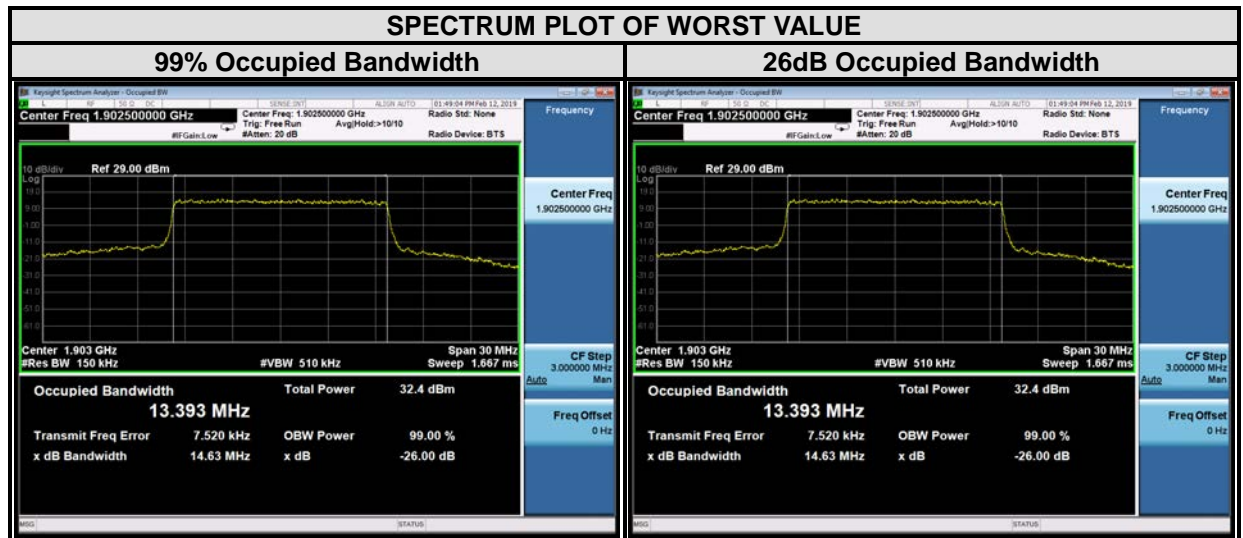





LTE band 2					
Channel Bandwidth : 20MHz					
Channel	Frequency (MHz)	99% Occupied bandwidth (MHz)	Channel	Frequency (MHz)	26dB bandwidth (MHz)
		QPSK			QPSK
18700	1860	17.87	18700	1860	19.19
18900	1880	17.87	18900	1880	19.12
19100	1900	17.91	19100	1900	19.35

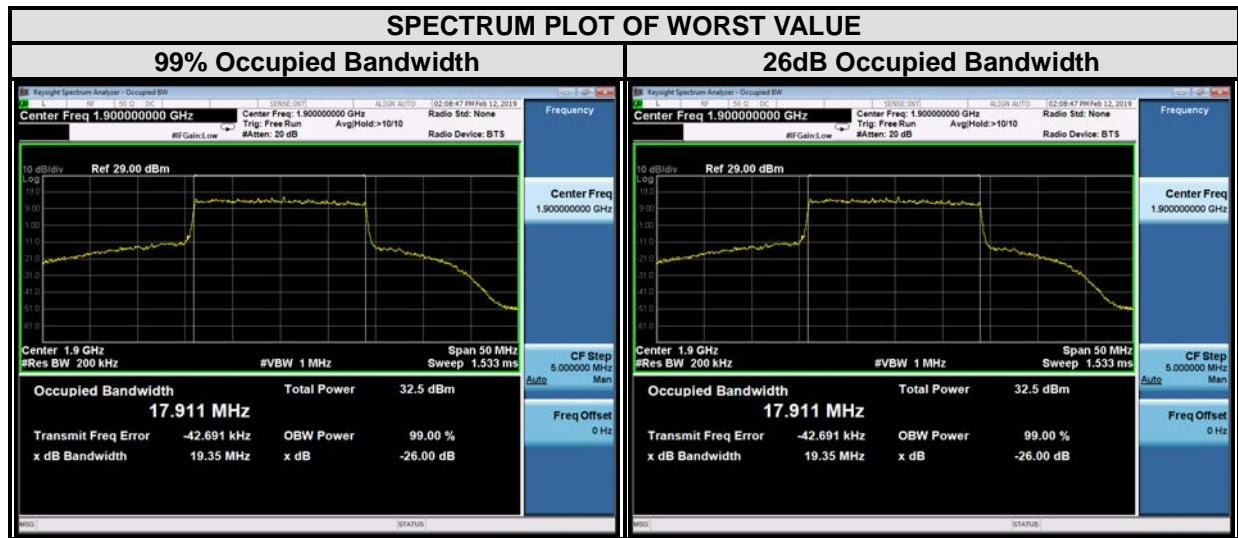



### 3.4 BAND EDGE MEASUREMENT

#### 3.4.1 LIMITS OF BAND EDGE MEASUREMENT

Power of any emission outside of the authorized operating frequency ranges must be attenuated below the transmitting power (P) by a factor of at least  $43 + 10 \log(P)$  dB. In the 1 MHz bands immediately outside and adjacent to the frequency block a resolution bandwidth of at least one percent of the emission bandwidth of the fundamental emission of the transmitter may be employed.

#### 3.4.2 TEST SETUP

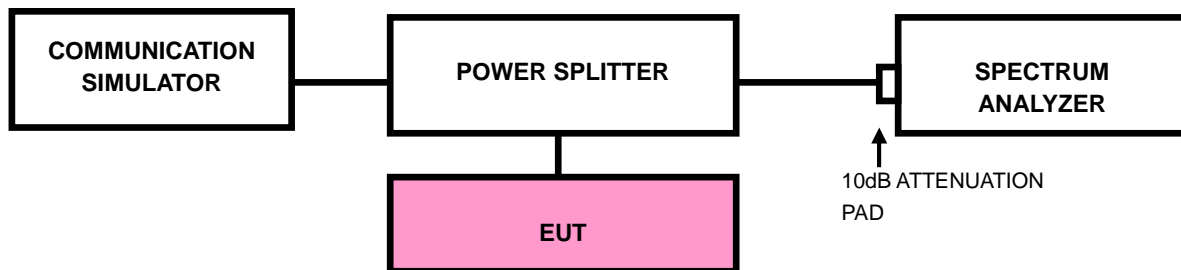

#### 3.4.3 TEST PROCEDURES

- All measurements were done at low and high operational frequency range.
- The center frequency of spectrum is the band edge frequency and span is 10MHz. RBW of the spectrum is 100kHz and VBW of the spectrum is 300kHz (WCDMA).
- The center frequency of spectrum is the band edge frequency and span is 1~5 MHz. RBW of the spectrum is 20kHz and VBW of the spectrum is 100 kHz. (LTE bandwidth 1.4MHz)
- The center frequency of spectrum is the band edge frequency and span is 1~5 MHz. RBW of the spectrum is 30kHz and VBW of the spectrum is 100kHz. (LTE bandwidth 3MHz)
- The center frequency of spectrum is the band edge frequency and span is 1~5 MHz. RBW of the spectrum is 50kHz and VBW of the spectrum is 200kHz. (LTE bandwidth 5MHz)
- The center frequency of spectrum is the band edge frequency and span is 1~5 MHz. RBW of the spectrum is 100kHz and VBW of the spectrum is



300kHz. (LTE bandwidth 10MHz)

- g. The center frequency of spectrum is the band edge frequency and span is 1~5 MHz. RBW of the spectrum is 200kHz and VBW of the spectrum is 1MHz. (LTE bandwidth 15MHz)
- h. The center frequency of spectrum is the band edge frequency and span is 1~5 MHz. RBW of the spectrum is 200kHz and VBW of the spectrum is 1MHz. (LTE bandwidth 20MHz)
- i. Record the max trace plot into the test report.



BUREAU  
VERITAS

Test Report No.: RF190123W002-3

### 3.4.4. TEST RESULTS

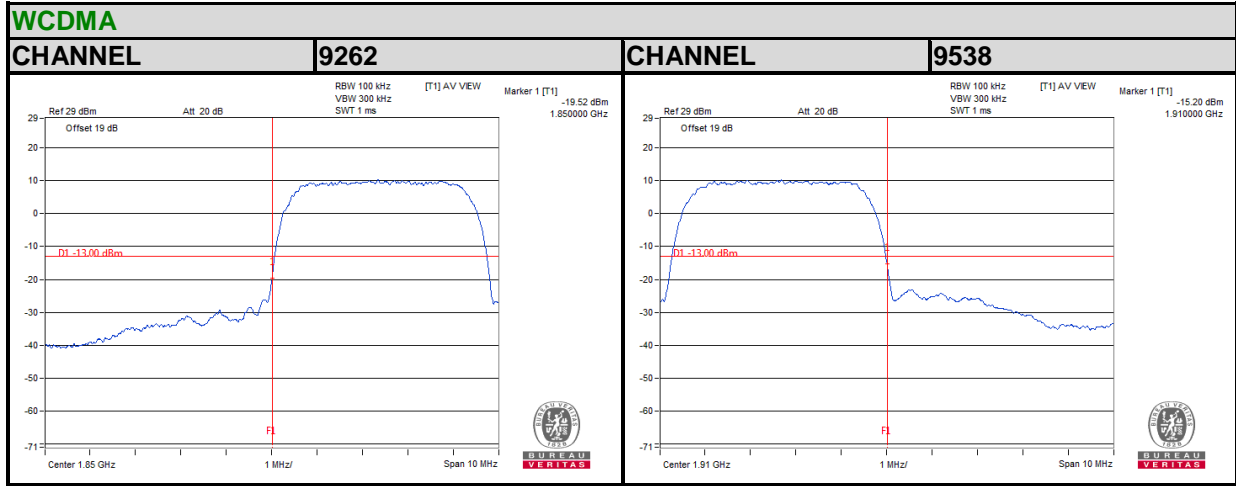



BUREAU VERITAS

Test Report No.: RF190123W002-3

LTE BAND 2

Channel Bandwidth: 1.4MHz QPSK

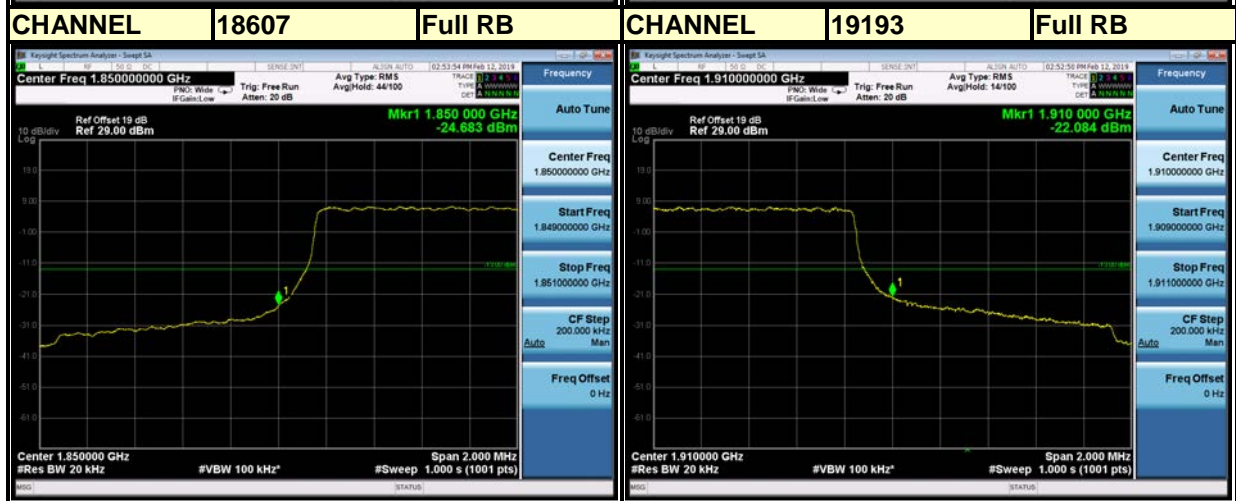



BUREAU VERITAS

Test Report No.: RF190123W002-3

LTE BAND 2

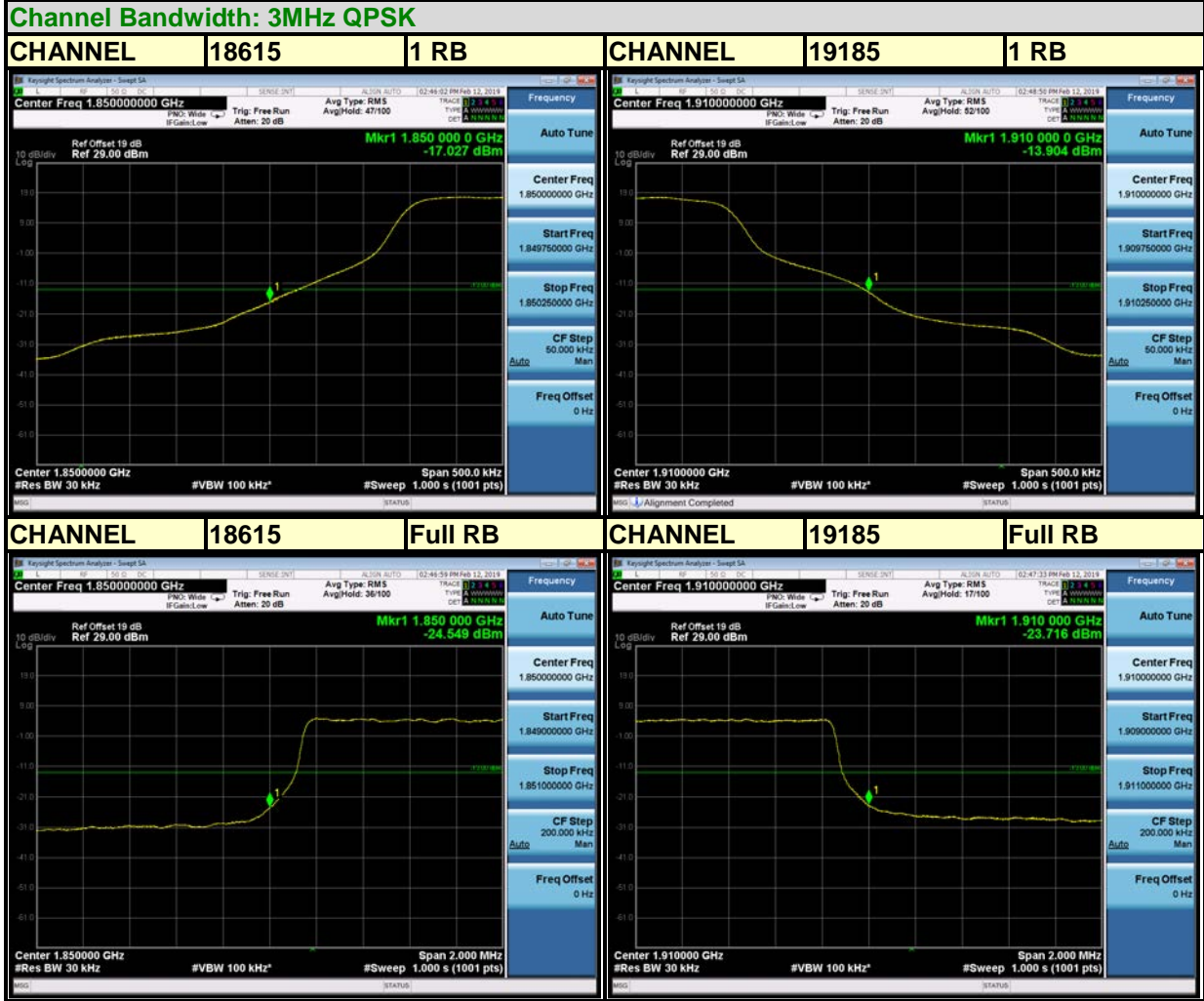



BUREAU VERITAS

Test Report No.: RF190123W002-3

LTE BAND 2

Channel Bandwidth: 5MHz QPSK

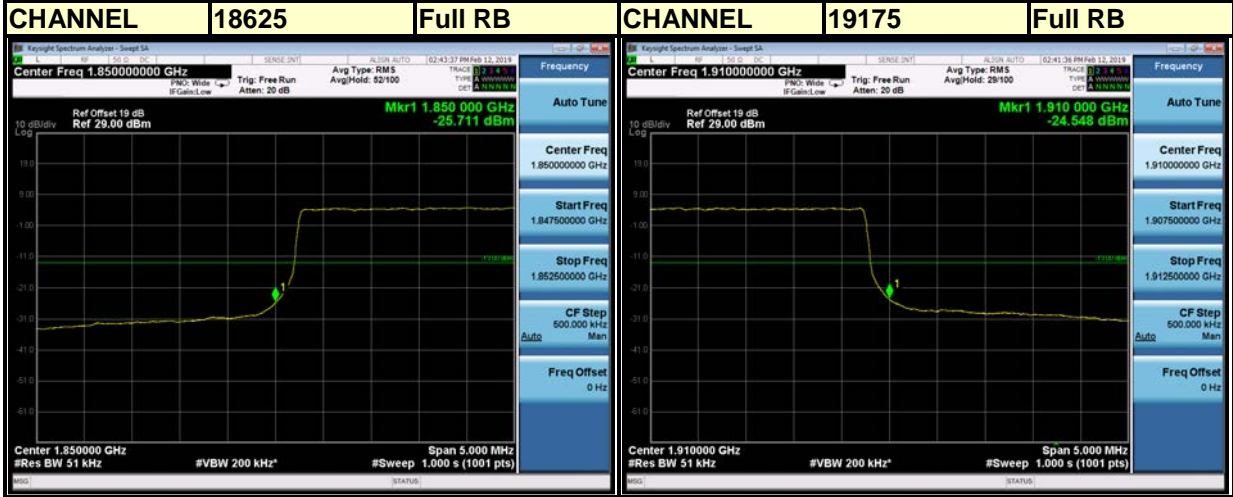
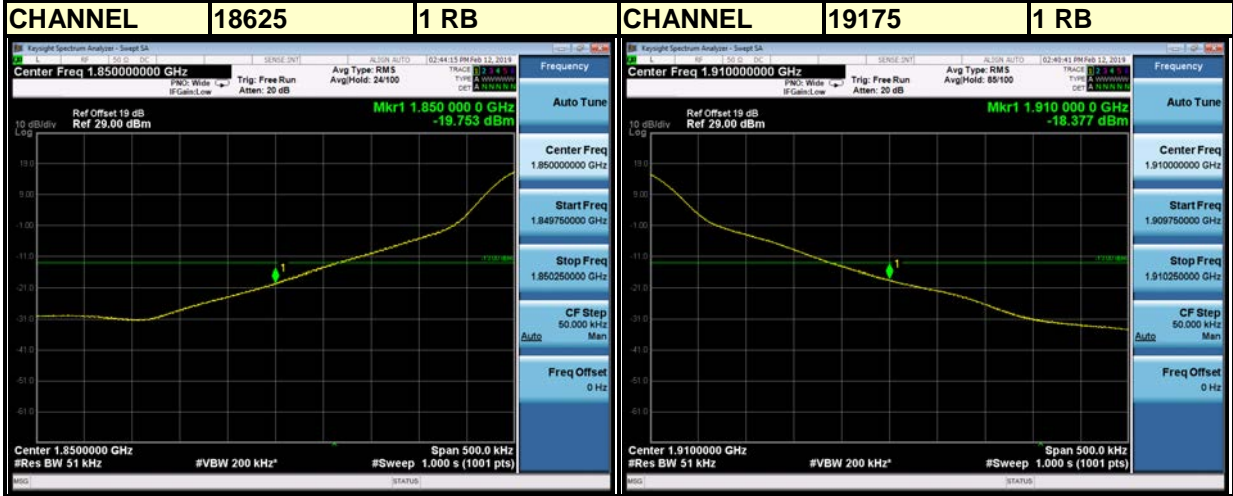



**LTE BAND 2**

**Channel Bandwidth: 10MHz QPSK**

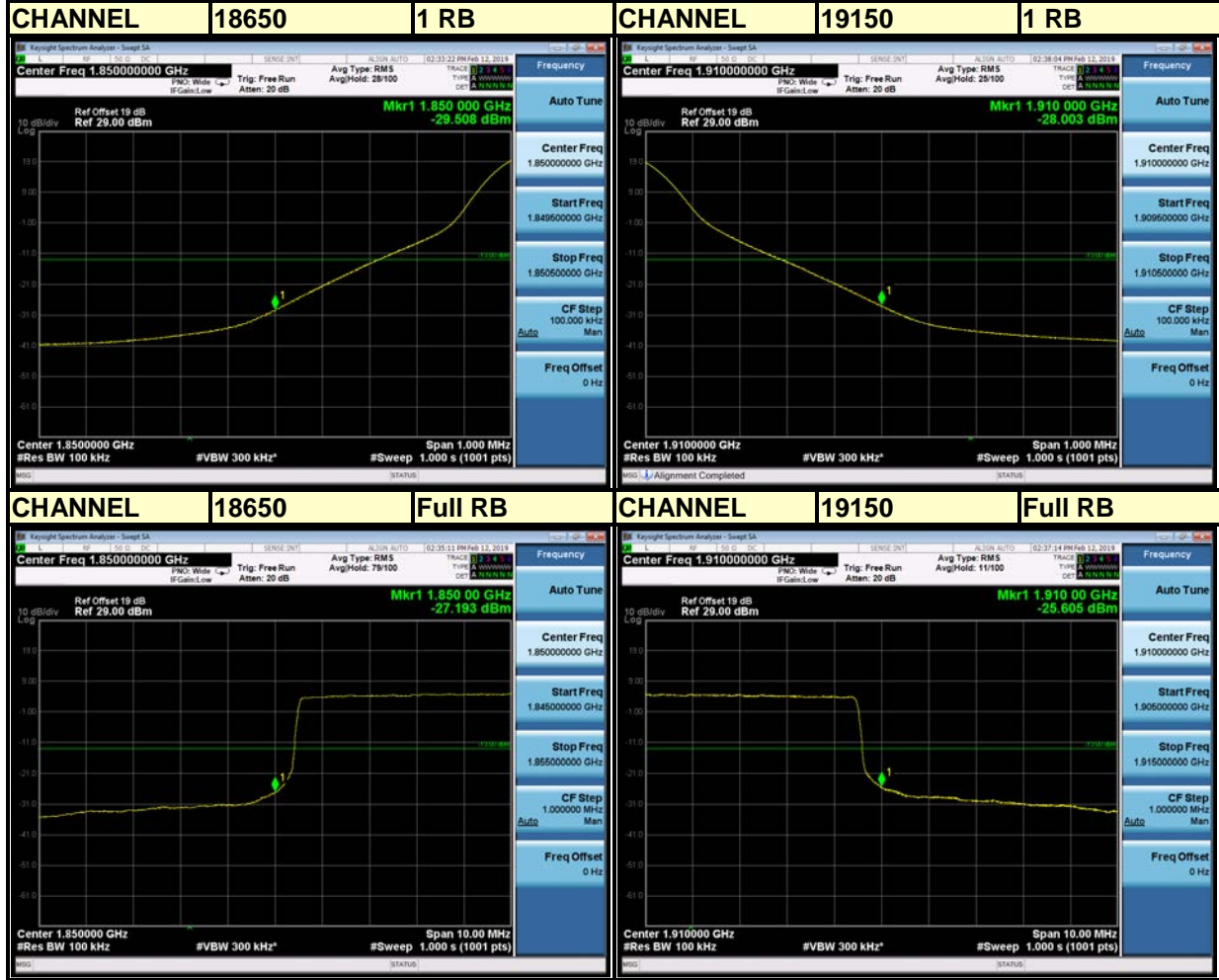





BUREAU VERITAS

Test Report No.: RF190123W002-3

LTE BAND 2

Channel Bandwidth: 15MHz QPSK

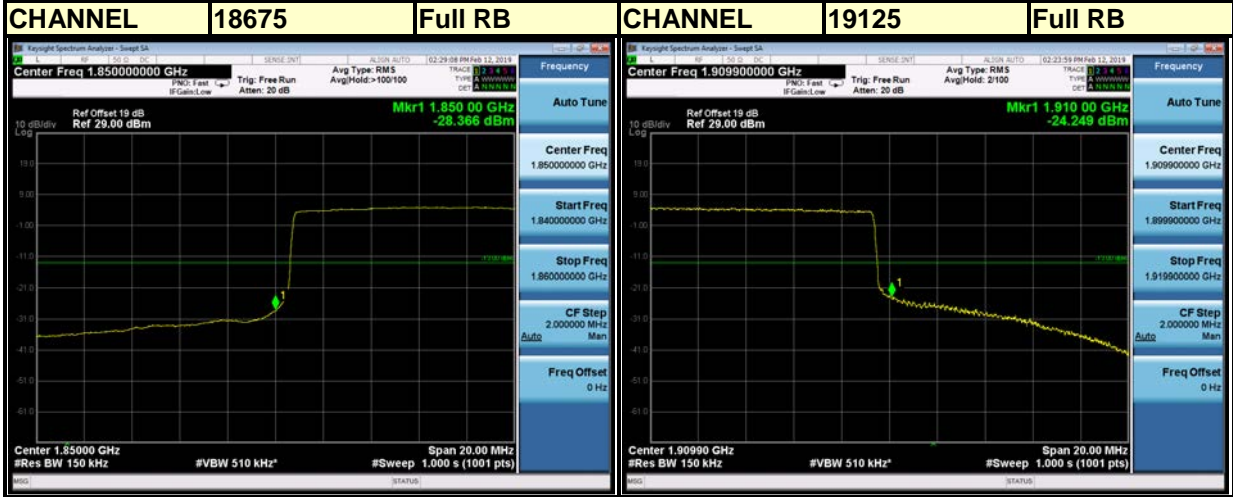
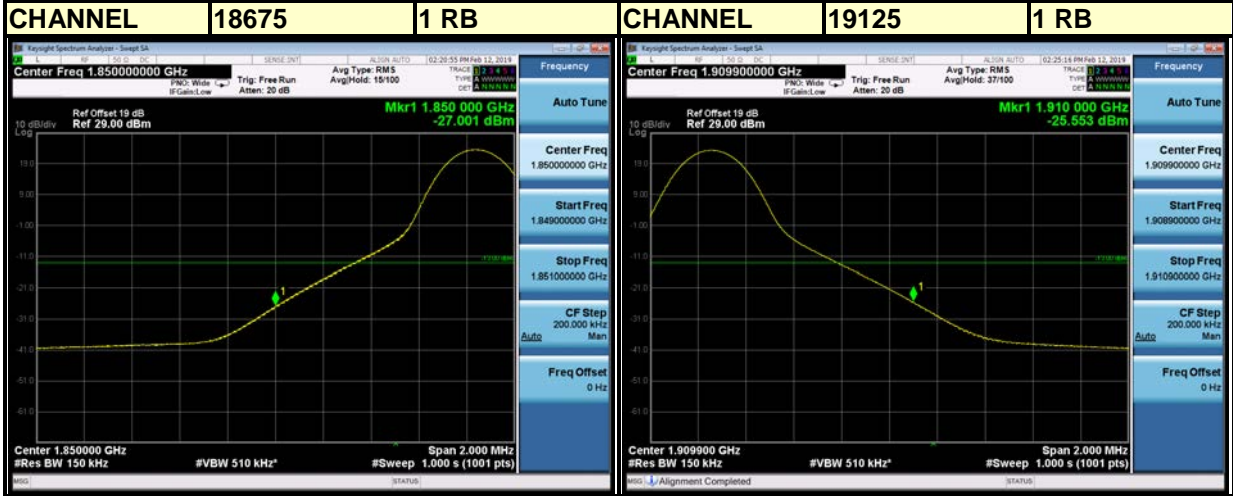



**LTE BAND 2**

**Channel Bandwidth: 20MHz QPSK**





### 3.5 CONDUCTED SPURIOUS EMISSIONS

#### 3.5.1 LIMITS OF CONDUCTED SPURIOUS EMISSIONS MEASUREMENT

The power of any emission outside of the authorized operating frequency ranges must be attenuated below the transmitting power (P) by a factor of at least  $43 + 10 \log(P)$  dB. The emission limit equal to  $-13\text{dBm}$ .

#### 3.5.2 TEST PROCEDURE

- a. The EUT makes a phone call to the communication simulator. All measurements were done at low, middle and high operational frequency range.
- b. Measuring frequency range is from 9 kHz to 19.1GHz. 10dB attenuation pad is connected with spectrum. RBW=1MHz and VBW=3MHz is used for conducted emission measurement.

#### 3.5.3 TEST SETUP

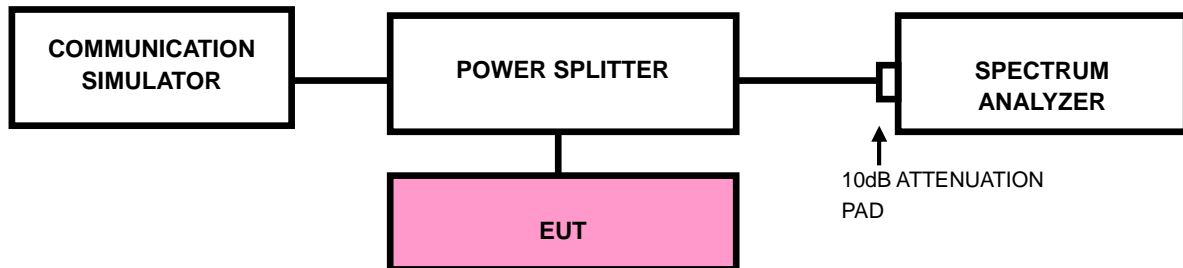



### 3.5.4 TEST RESULTS





**LTE BAND 2**

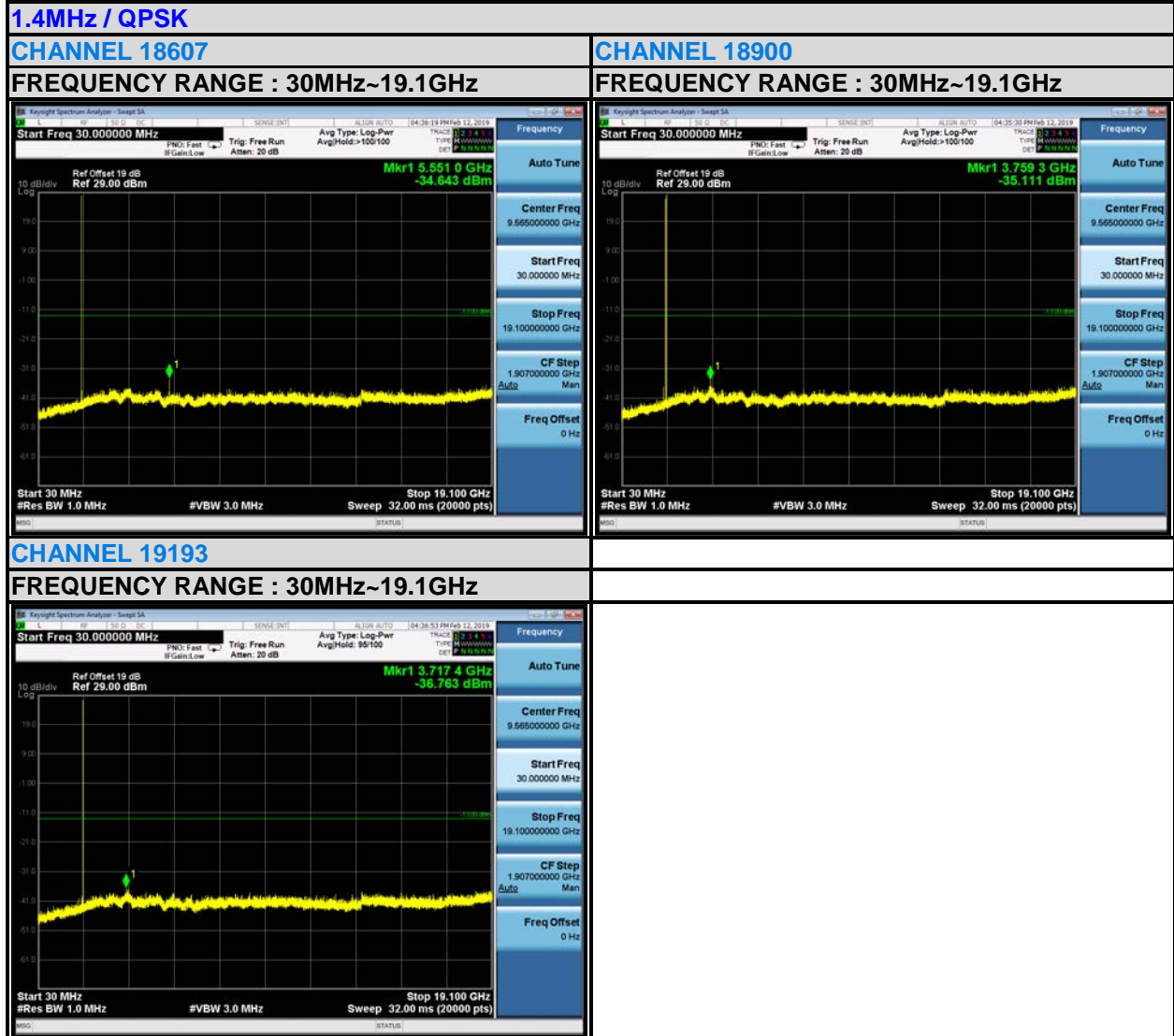



BUREAU VERITAS

Test Report No.: RF190123W002-3





BUREAU VERITAS

Test Report No.: RF190123W002-3





BUREAU VERITAS

Test Report No.: RF190123W002-3

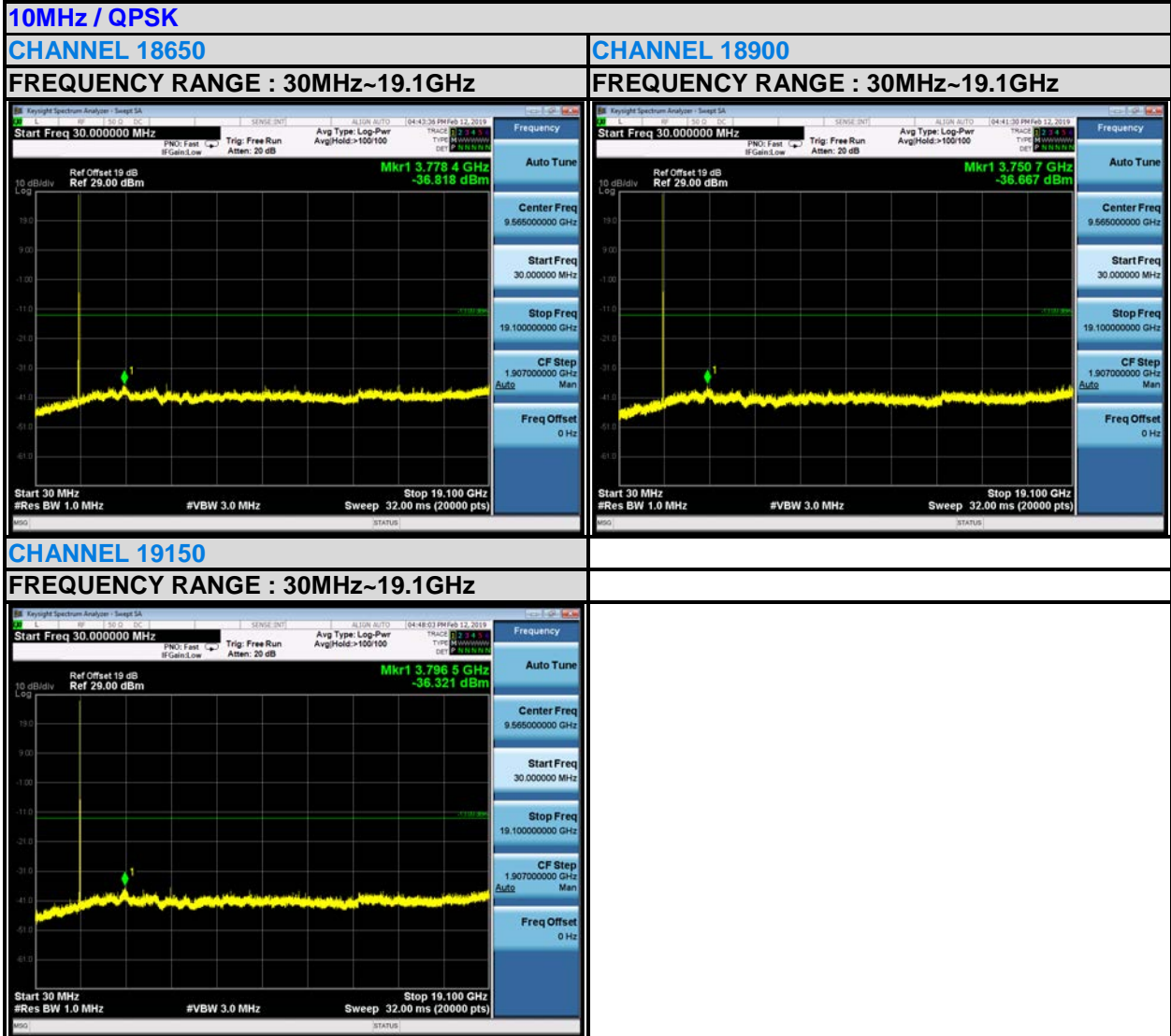





BUREAU VERITAS

Test Report No.: RF190123W002-3

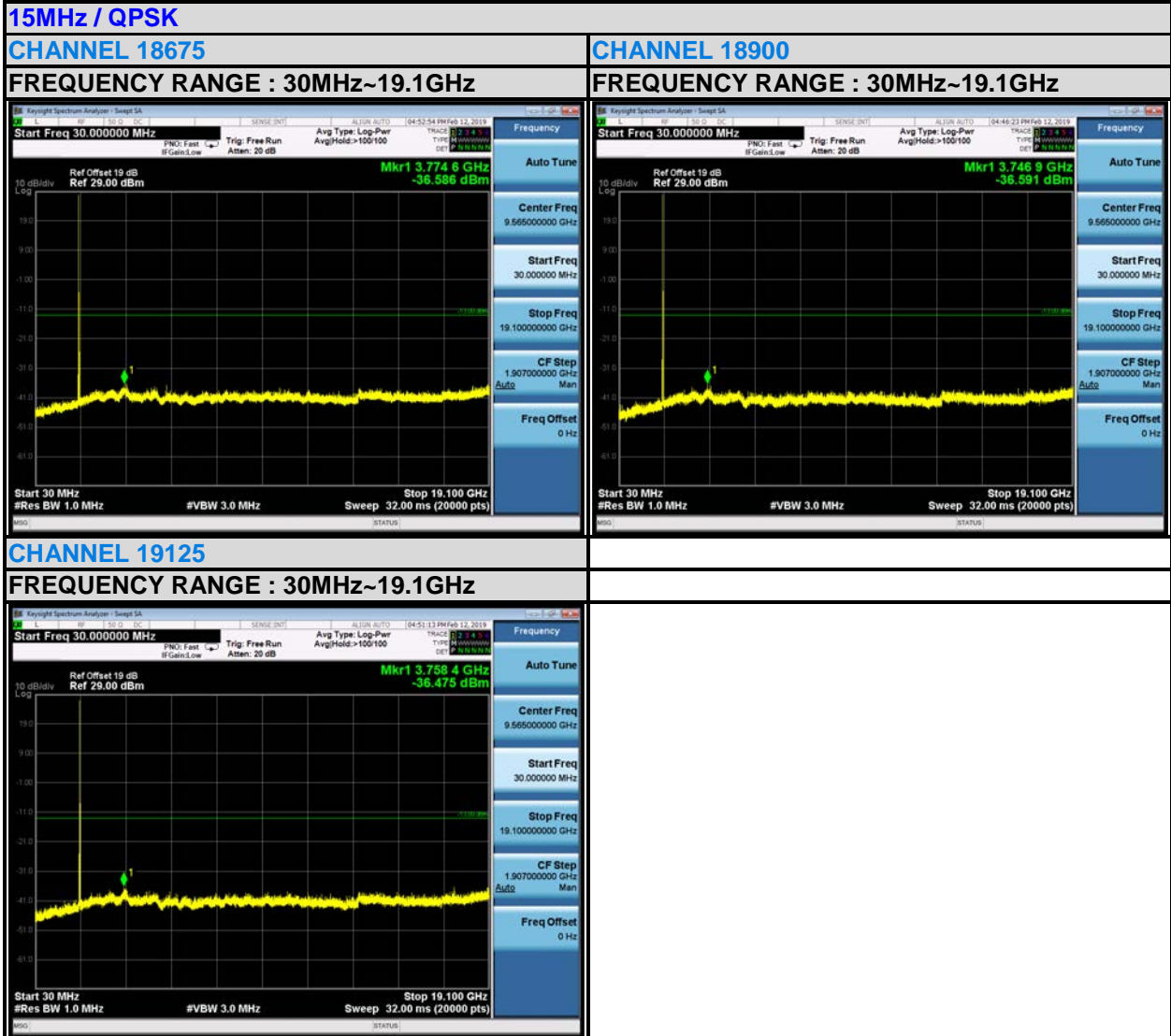



BUREAU VERITAS

Test Report No.: RF190123W002-3

20MHz / QPSK

CHANNEL 18700

FREQUENCY RANGE : 30MHz~19.1GHz

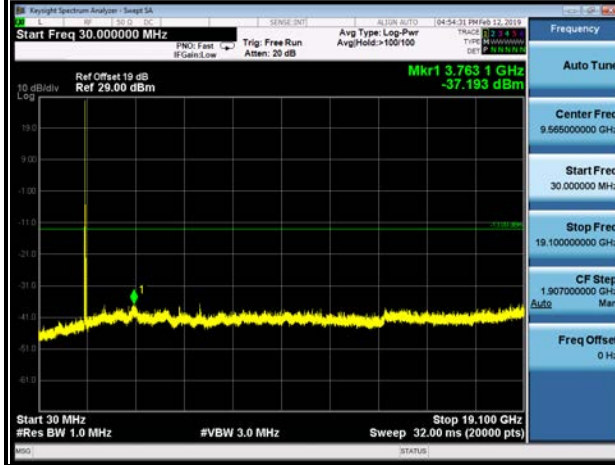

CHANNEL 18900

FREQUENCY RANGE : 30MHz~19.1GHz

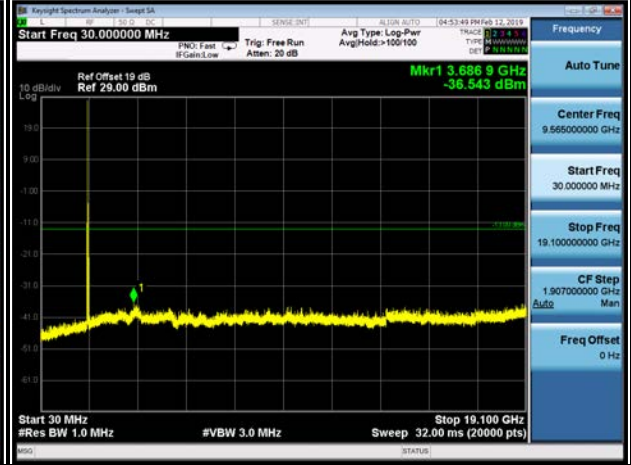

CHANNEL 19100

FREQUENCY RANGE : 30MHz~19.1GHz

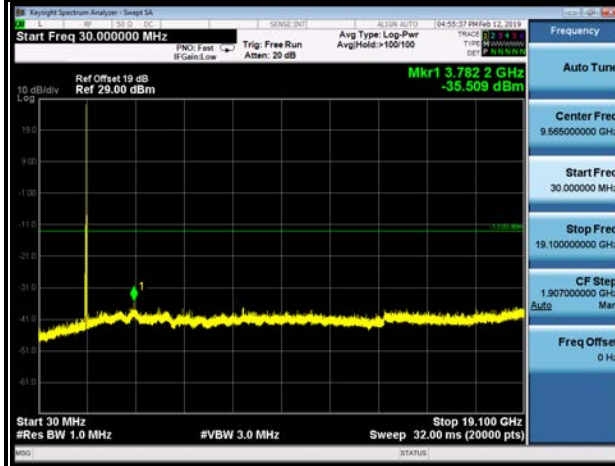



### 3.6 RADIATED EMISSION MEASUREMENT

#### 3.6.1 LIMITS OF RADIATED EMISSION MEASUREMENT

The power of any emission outside of the authorized operating frequency ranges must be attenuated below the transmitting power (P) by a factor of at least  $43 + 10 \log(P)$  dB. The emission limit equal to  $-13\text{dBm}$ .

#### 3.6.2 TEST PROCEDURES

- a. Substitution method is used for E.I.R.P measurement. In the semi-anechoic chamber, EUT placed on the 0.8m height of Turn Table, rotated the table around 360 degrees to search the maximum radiation power and receiver antenna shall be rotated vertical and horizontal polarization and moved height from 1m to 4m to find the maximum polar radiated power. The “Read Value” is the spectrum reading the maximum power value.
- b. The substitution horn antenna is substituted for EUT at the same position and signals generator export the CW signal to the substitution antenna via a TX cable. Rotated the Turn Table and moved receiving antenna to find the maximum radiation power. Adjust output power level of S.G to get a Value of spectrum reading equal to “Read Value “ of step a. Record the power level of S.G
- c.  $\text{EIRP} = \text{Output power level of S.G} - \text{TX cable loss} + \text{Antenna gain of substitution horn}$ .

**NOTE:** The resolution bandwidth and video bandwidth of test receiver/spectrum analyzer is 1MHz/3MHz.

#### 3.6.3 DEVIATION FROM TEST STANDARD

No deviation



### 3.6.4 TEST SETUP

#### <Below 30MHz>

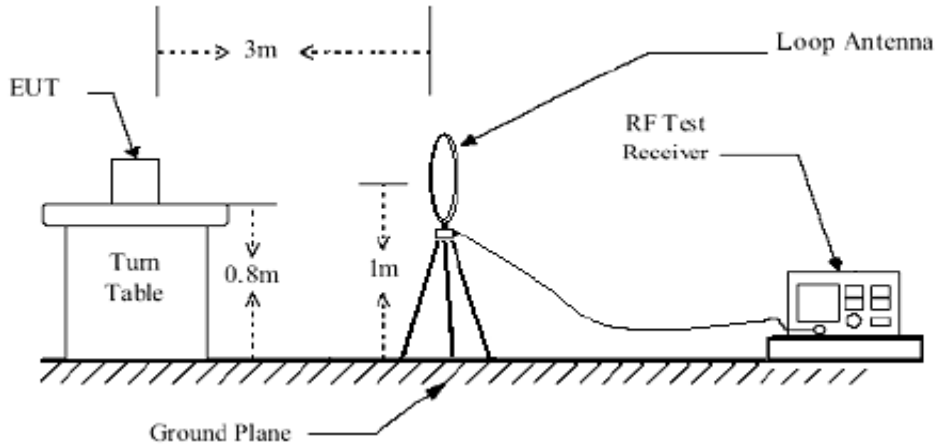

#### < Frequency Range 30MHz~1GHz >

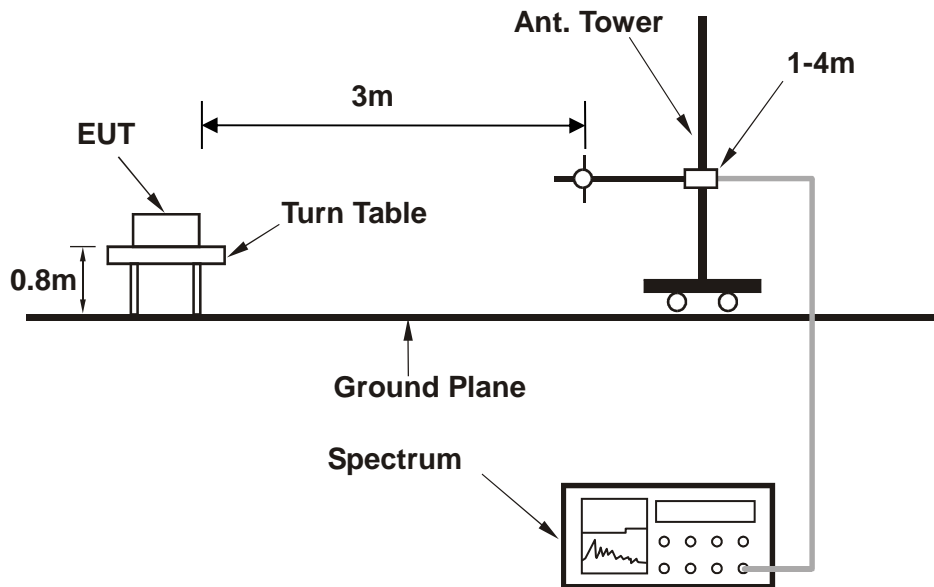



< Frequency Range above 1GHz >

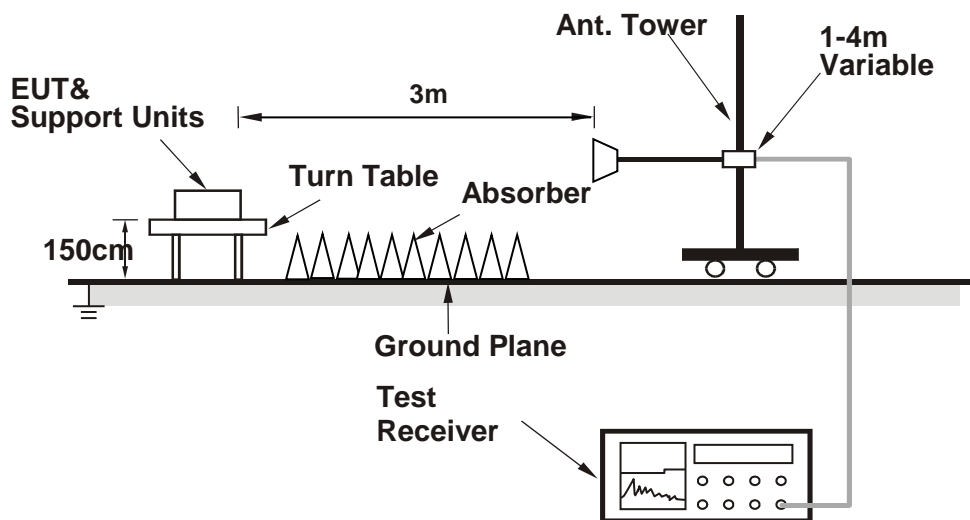

For the actual test configuration, please refer to the attached file (Test Setup Photo).



### 3.6.5 TEST RESULTS

#### BELOW 1GHz WORST-CASE DATA

**9 KHz – 30 MHz data:** the amplitude of spurious emissions attenuated more than 20 dB below the permissible value is not required in the report.

**30 MHz – 1GHz data:**

**LTE Band 2:**

<b>MODE</b>	TX channel 18900	<b>FREQUENCY RANGE</b>	Below 1000MHz
<b>ENVIRONMENTAL CONDITIONS</b>	23deg. C, 70%RH	<b>INPUT POWER</b>	DC 5V from adapter
<b>TESTED BY</b>	Rose Ma		
<b>ANTENNA POLARITY &amp; TEST DISTANCE: HORIZONTAL AT 3 M</b>			

	Freq	Level	Read Level	Limit Line	Over Limit	Factor	Remark	Pol/Phase	
	MHz	dBm/m	dBm	dBm/m	dB	dB/m			
1	PP	35.260	-26.20	-38.65	-13.00	-13.20	12.45	Peak	Horizontal
2		69.120	-42.96	-31.05	-13.00	-29.96	-11.91	Peak	Horizontal
3		169.240	-54.73	-36.59	-13.00	-41.73	-18.14	Peak	Horizontal
4		195.450	-59.50	-42.15	-13.00	-46.50	-17.35	Peak	Horizontal
5		254.180	-62.76	-46.69	-13.00	-49.76	-16.07	Peak	Horizontal
6		366.950	-65.35	-53.78	-13.00	-52.35	-11.57	Peak	Horizontal

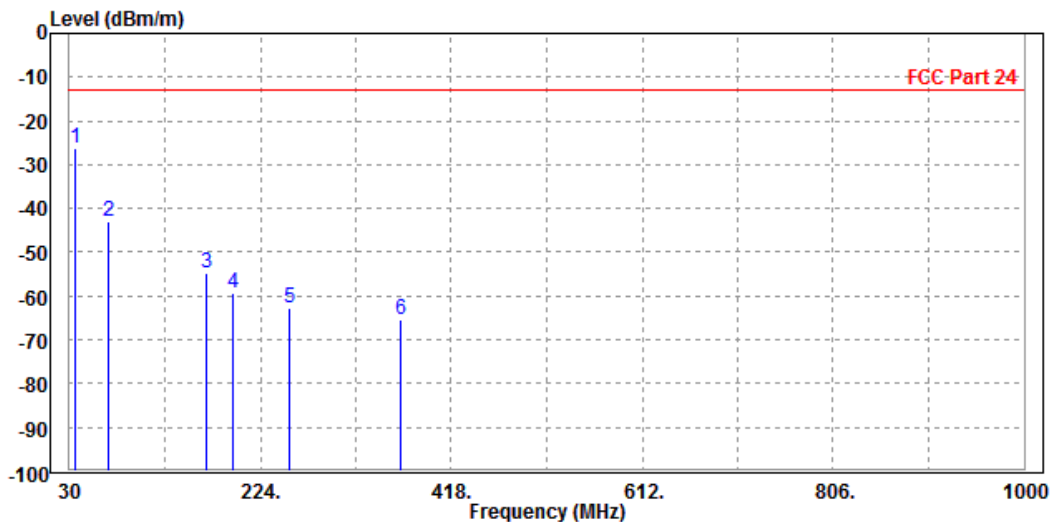



<b>MODE</b>	TX channel 18900	<b>FREQUENCY RANGE</b>	Below 1000MHz
<b>ENVIRONMENTAL CONDITIONS</b>	23deg. C, 70%RH	<b>INPUT POWER</b>	DC 5V from adapter
<b>TESTED BY</b>	Rose Ma		
<b>ANTENNA POLARITY &amp; TEST DISTANCE: VERTICAL AT 3 M</b>			

	Freq	Level	Read Level	Limit Line	Over Limit	Factor	Remark	Pol/Phase	
	MHz	dBm/m	dBm	dBm/m	dB	dB/m			
1	PP	40.120	-37.16	-35.84	-13.00	-24.16	-1.32	Peak	Vertical
2		79.860	-53.84	-43.52	-13.00	-40.84	-10.32	Peak	Vertical
3		154.850	-58.39	-42.75	-13.00	-45.39	-15.64	Peak	Vertical
4		255.880	-55.05	-43.56	-13.00	-42.05	-11.49	Peak	Vertical
5		325.650	-48.79	-37.59	-13.00	-35.79	-11.20	Peak	Vertical
6		402.650	-50.73	-39.89	-13.00	-37.73	-10.84	Peak	Vertical

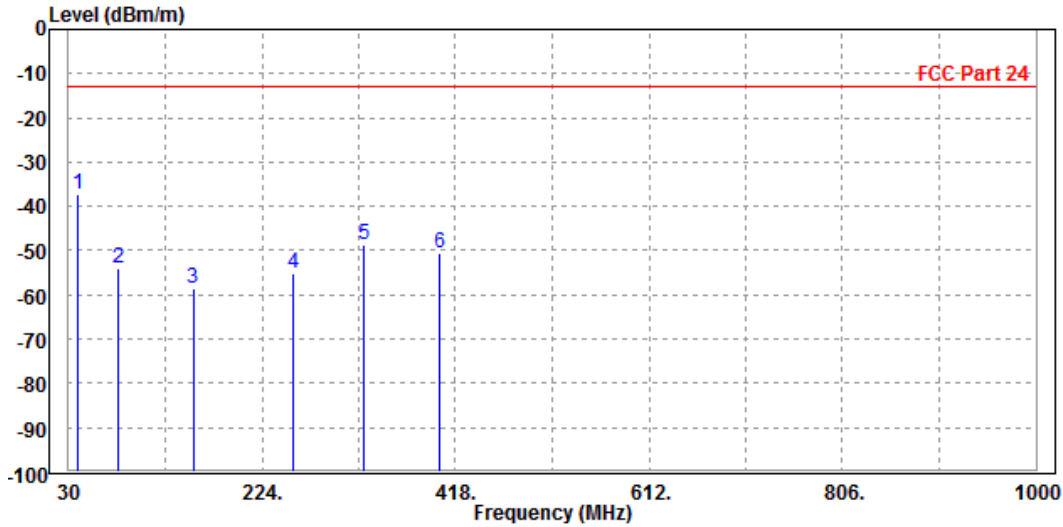



**ABOVE 1GHz DATA**

**Note:** For higher frequency, the emission is too low to be detected.

**WCDMA Band II**

**CH 9262**

<b>MODE</b>	TX channel 9262	<b>FREQUENCY RANGE</b>	Above 1000MHz
<b>ENVIRONMENTAL CONDITIONS</b>	23deg. C, 70%RH	<b>INPUT POWER</b>	DC 5V from adapter
<b>TESTED BY</b>	Rose Ma		
<b>ANTENNA POLARITY &amp; TEST DISTANCE: HORIZONTAL AT 3 M</b>			

	Freq	Level	Read Level	Limit Line	Over Limit	Factor	Remark	Pol/Phase
	MHz	dBm/m	dBm	dBm/m	dB	dB/m		
1	PP 3698.000	-41.02	-44.13	-13.00	-28.02	3.11	Peak	Horizontal
2	5557.200	-47.41	-56.44	-13.00	-34.41	9.03	Peak	Horizontal

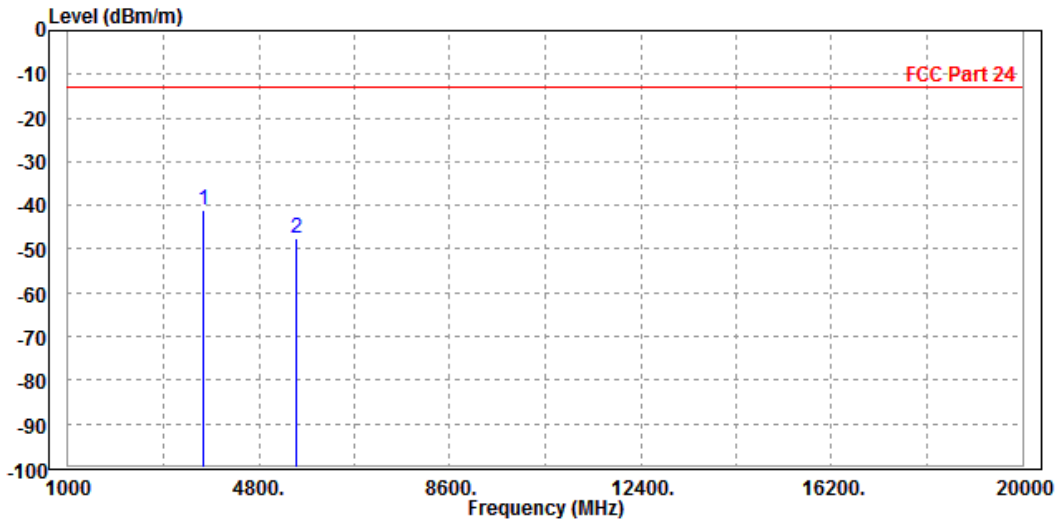





MODE	TX channel 9262	FREQUENCY RANGE	Above 1000MHz
ENVIRONMENTAL CONDITIONS	23deg. C, 70%RH	INPUT POWER	DC 5V from adapter
TESTED BY	Rose Ma		
<b>ANTENNA POLARITY &amp; TEST DISTANCE: VERTICAL AT 3 M</b>			

	Freq	Level	Read Level	Limit Line	Over Limit	Factor	Remark	Pol/Phase
	MHz	dBm/m	dBm	dBm/m	dB	dB/m		
1	PP 3698.000	-42.60	-46.17	-13.00	-29.60	3.57	Peak	Vertical
2	5557.200	-50.65	-58.74	-13.00	-37.65	8.09	Peak	Vertical

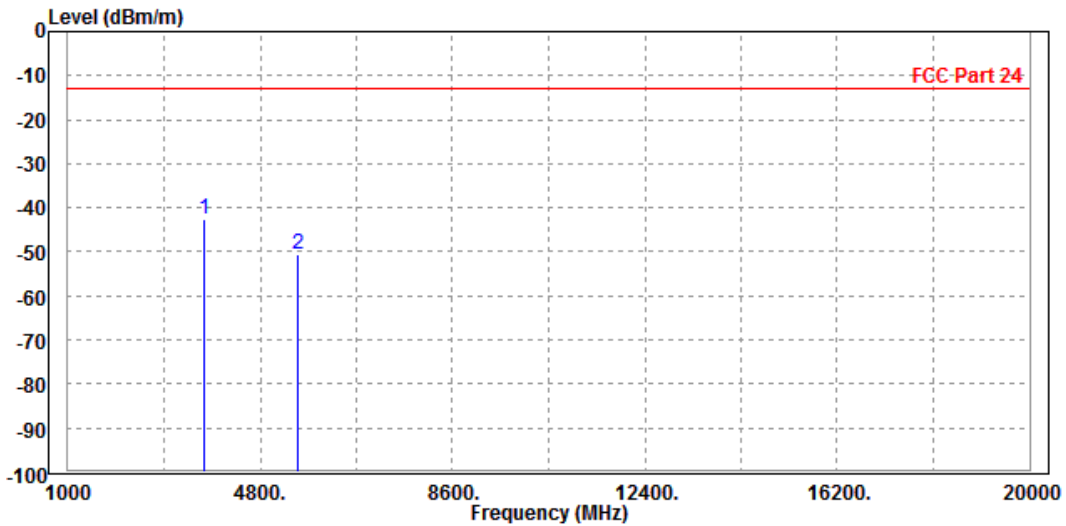



CH 9400

MODE	TX channel 9400	FREQUENCY RANGE	Above 1000MHz
ENVIRONMENTAL CONDITIONS	23deg. C, 70%RH	INPUT POWER	DC 5V from adapter
TESTED BY	Rose Ma		
ANTENNA POLARITY & TEST DISTANCE: HORIZONTAL AT 3 M			

	Freq	Level	Read Level	Limit Line	Over Limit	Factor	Remark	Pol/Phase
	MHz	dBm/m	dBm	dBm/m	dB	dB/m		
1	PP 3755.000	-41.09	-44.48	-13.00	-28.09	3.39	Peak	Horizontal
2	5640.000	-47.22	-56.34	-13.00	-34.22	9.12	Peak	Horizontal

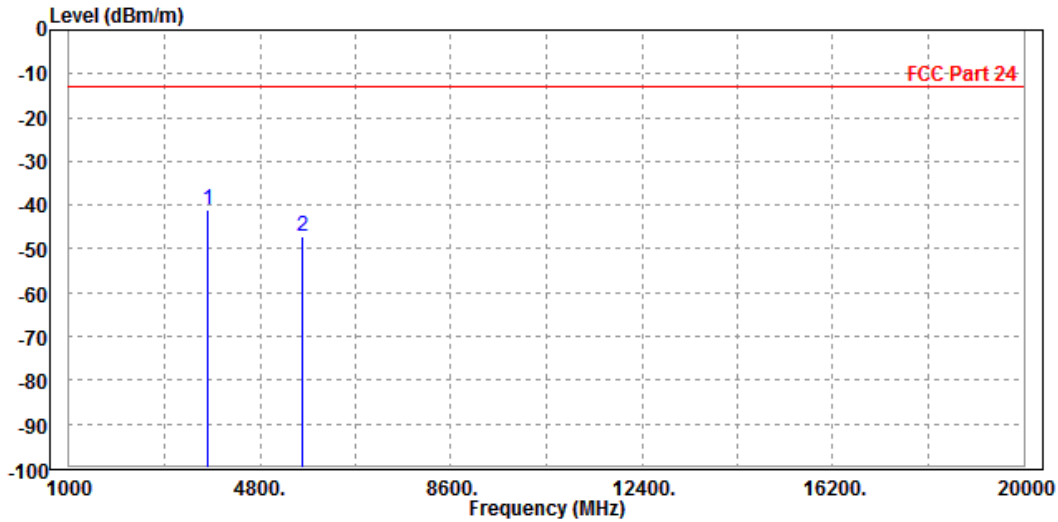



MODE	TX channel 9400	FREQUENCY RANGE	Above 1000MHz
ENVIRONMENTAL CONDITIONS	23deg. C, 70%RH	INPUT POWER	DC 5V from adapter
TESTED BY	Rose Ma		
<b>ANTENNA POLARITY &amp; TEST DISTANCE: VERTICAL AT 3 M</b>			

	Freq	Level	Read Level	Limit Line	Over Limit	Factor	Remark	Pol/Phase
	MHz	dBm/m	dBm	dBm/m	dB	dB/m		
1	PP 3755.000	-38.17	-42.02	-13.00	-25.17	3.85	Peak	Vertical
2	5640.000	-45.21	-53.47	-13.00	-32.21	8.26	Peak	Vertical

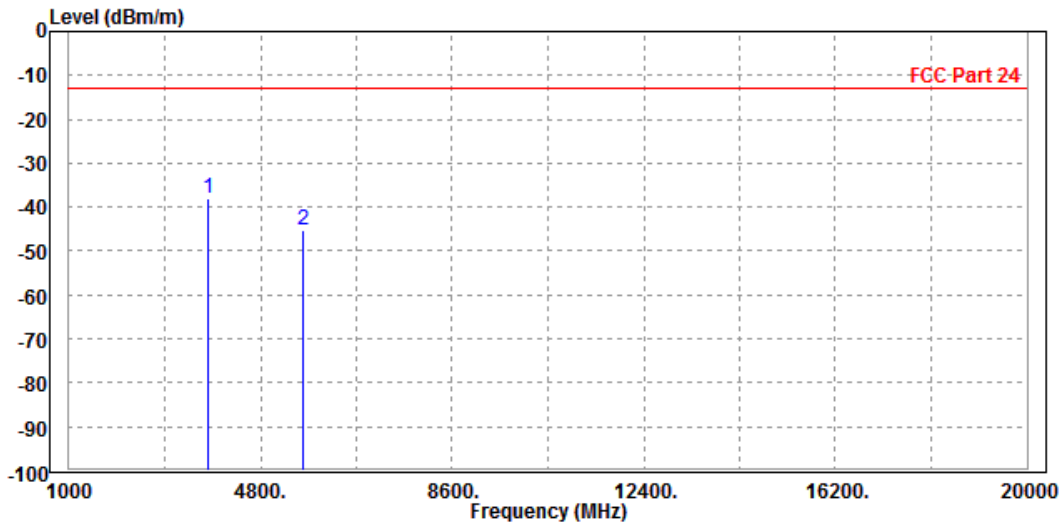



CH 9538

MODE	TX channel 9538	FREQUENCY RANGE	Above 1000MHz
ENVIRONMENTAL CONDITIONS	23deg. C, 70%RH	INPUT POWER	DC 5V from adapter
TESTED BY	Rose Ma		
<b>ANTENNA POLARITY &amp; TEST DISTANCE: HORIZONTAL AT 3 M</b>			

	Freq	Level	Read Level	Limit Line	Over Limit	Factor	Remark	Pol/Phase
	MHz	dBm/m	dBm	dBm/m	dB	dB/m		
1	PP 3812.000	-37.57	-41.23	-13.00	-24.57	3.66	Peak	Horizontal
2	5722.800	-46.43	-55.65	-13.00	-33.43	9.22	Peak	Horizontal

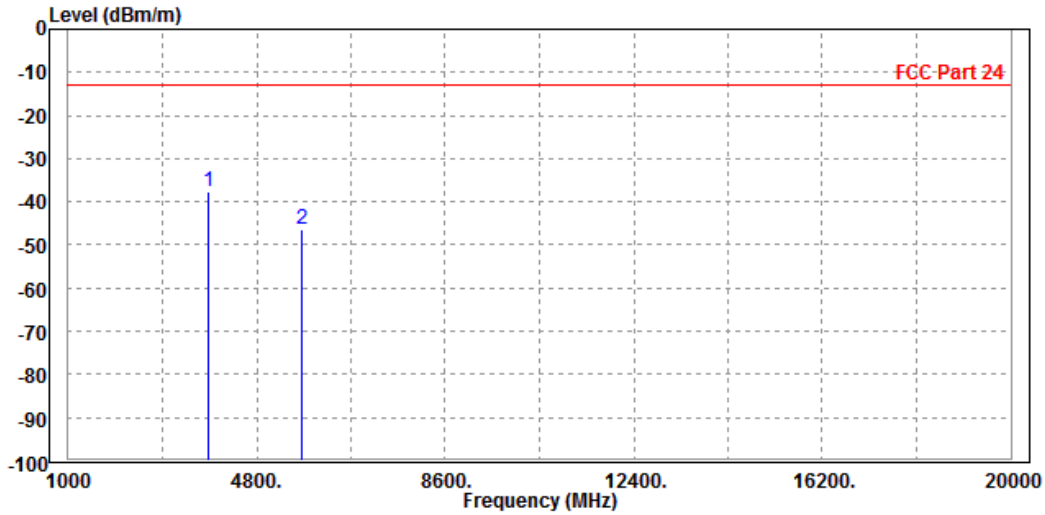



MODE	TX channel 9538	FREQUENCY RANGE	Above 1000MHz
ENVIRONMENTAL CONDITIONS	23deg. C, 70%RH	INPUT POWER	DC 5V from adapter
TESTED BY	Rose Ma		
<b>ANTENNA POLARITY &amp; TEST DISTANCE: VERTICAL AT 3 M</b>			

	Freq	Level	Read Level	Limit Line	Over Limit	Factor	Remark	Pol/Phase
	MHz	dBm/m	dBm	dBm/m	dB	dB/m		
1 PP	3812.000	-40.39	-44.53	-13.00	-27.39	4.14	Peak	Vertical
2	5722.800	-47.75	-56.17	-13.00	-34.75	8.42	Peak	Vertical

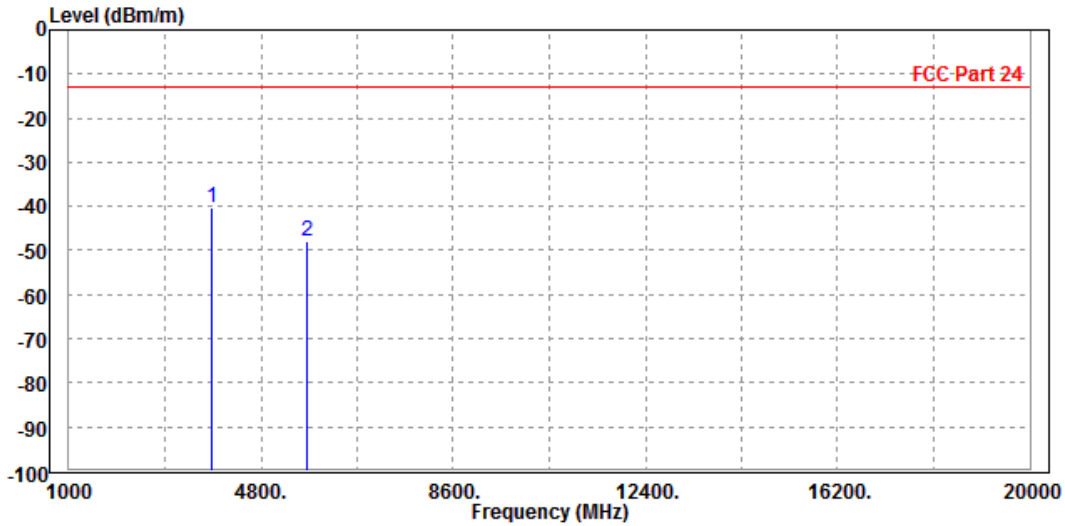



**BUREAU VERITAS** Test Report No.: RF190123W002-3

LTE Band 2

CHANNEL BANDWIDTH: 1.4MHz / QPSK

CH 18607

<b>MODE</b>	TX channel 18607	<b>FREQUENCY RANGE</b>	Above 1000MHz
<b>ENVIRONMENTAL CONDITIONS</b>	23deg. C, 70%RH	<b>INPUT POWER</b>	DC 5V from adapter
<b>TESTED BY</b>	Rose Ma		
<b>ANTENNA POLARITY &amp; TEST DISTANCE: HORIZONTAL AT 3 M</b>			

	Freq	Level	Read Level	Limit Line	Over Limit	Factor	Remark	Pol/Phase
	MHz	dBm/m	dBm	dBm/m	dB	dB/m		
1	3698.000	-56.16	-59.27	-13.00	-43.16	3.11	Peak	Horizontal
2 PP	5552.100	-53.46	-62.48	-13.00	-40.46	9.02	Peak	Horizontal

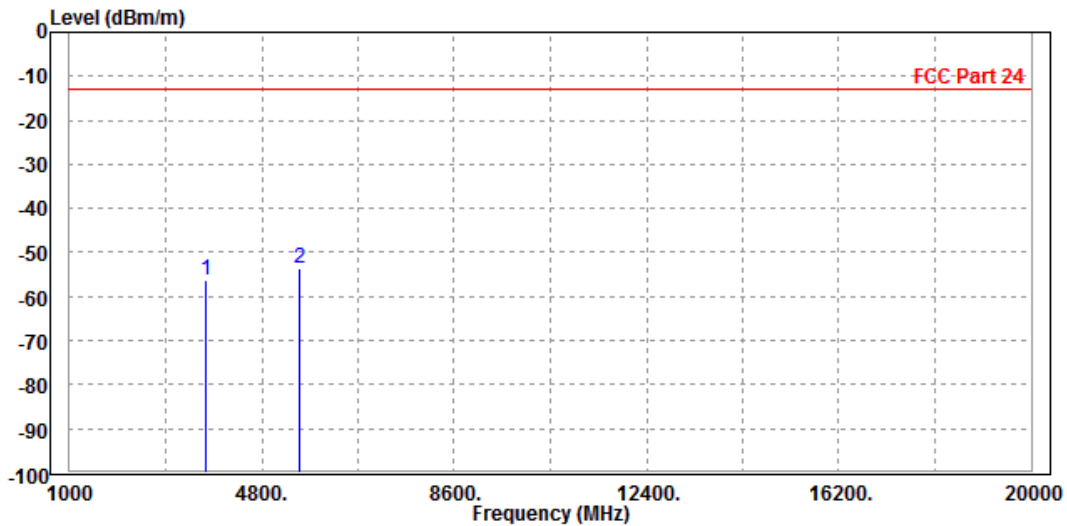



MODE	TX channel 18607	FREQUENCY RANGE	Above 1000MHz
ENVIRONMENTAL CONDITIONS	23deg. C, 70%RH	INPUT POWER	DC 5V from adapter
TESTED BY	Rose Ma		
ANTENNA POLARITY & TEST DISTANCE: VERTICAL AT 3 M			

	Freq	Level	Read Level	Limit Line	Over Limit	Factor	Remark	Pol/Phase
	MHz	dBm/m	dBm	dBm/m	dB	dB/m		
1	PP 3698.000	-50.58	-54.15	-13.00	-37.58	3.57	Peak	Vertical
2	5552.100	-52.28	-60.36	-13.00	-39.28	8.08	Peak	Vertical

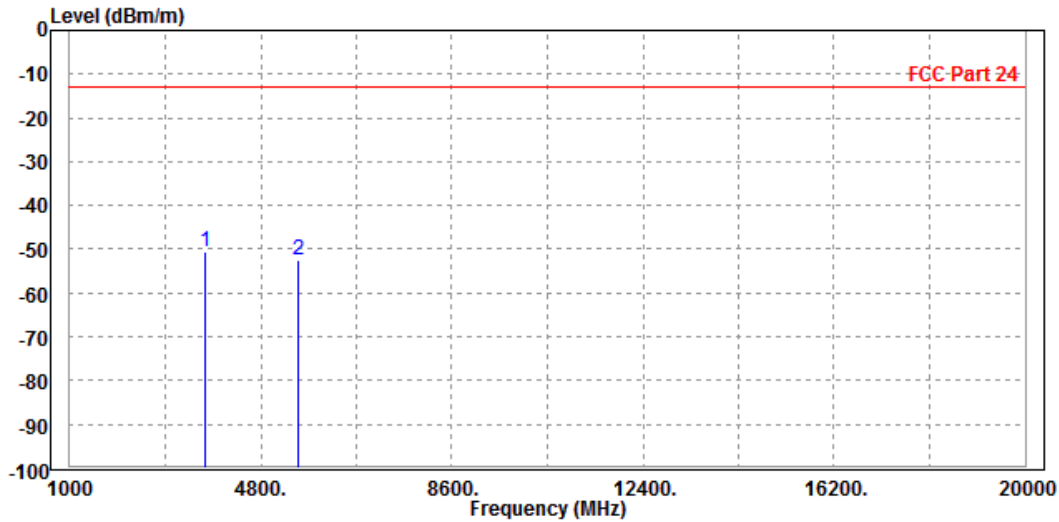



CH 18900

MODE	TX channel 18900	FREQUENCY RANGE	Above 1000MHz
ENVIRONMENTAL CONDITIONS	23deg. C, 70%RH	INPUT POWER	DC 5V from adapter
TESTED BY	Rose Ma		
<b>ANTENNA POLARITY &amp; TEST DISTANCE: HORIZONTAL AT 3 M</b>			

	Freq	Level	Read Level	Limit Line	Over Limit	Factor	Remark	Pol/Phase
	MHz	dBm/m	dBm	dBm/m	dB	dB/m		
1	PP 3755.000	-36.65	-40.04	-13.00	-23.65	3.39	Peak	Horizontal
2	5640.000	-41.13	-50.25	-13.00	-28.13	9.12	Peak	Horizontal

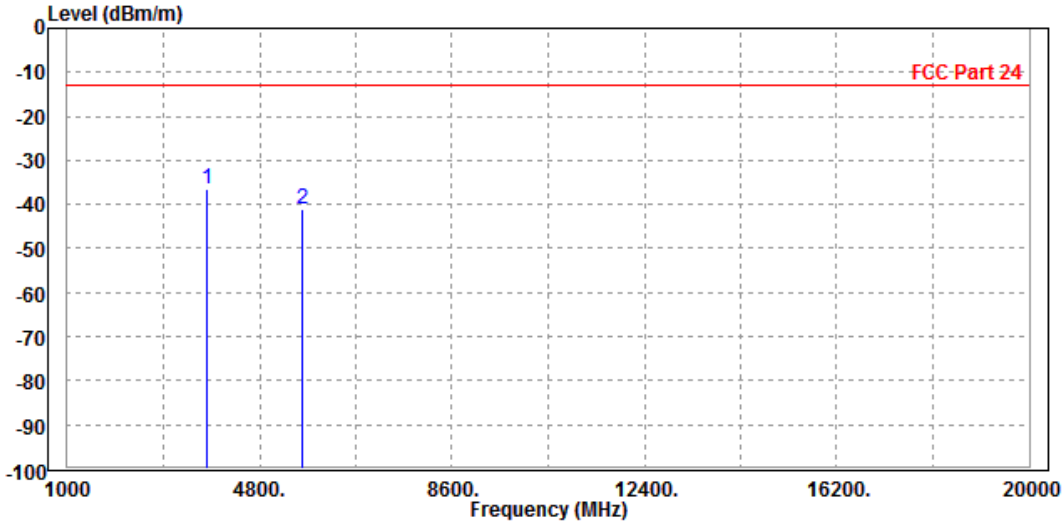





MODE	TX channel 18900	FREQUENCY RANGE	Above 1000MHz
ENVIRONMENTAL CONDITIONS	23deg. C, 70%RH	INPUT POWER	DC 5V from adapter
TESTED BY	Rose Ma		
<b>ANTENNA POLARITY &amp; TEST DISTANCE: VERTICAL AT 3 M</b>			

	Freq	Level	Read Level	Limit Line	Over Limit	Factor	Remark	Pol/Phase
	MHz	dBm/m	dBm	dBm/m	dB	dB/m		
1	PP 3755.000	-33.07	-36.92	-13.00	-20.07	3.85	Peak	Vertical
2	5640.000	-37.07	-45.33	-13.00	-24.07	8.26	Peak	Vertical

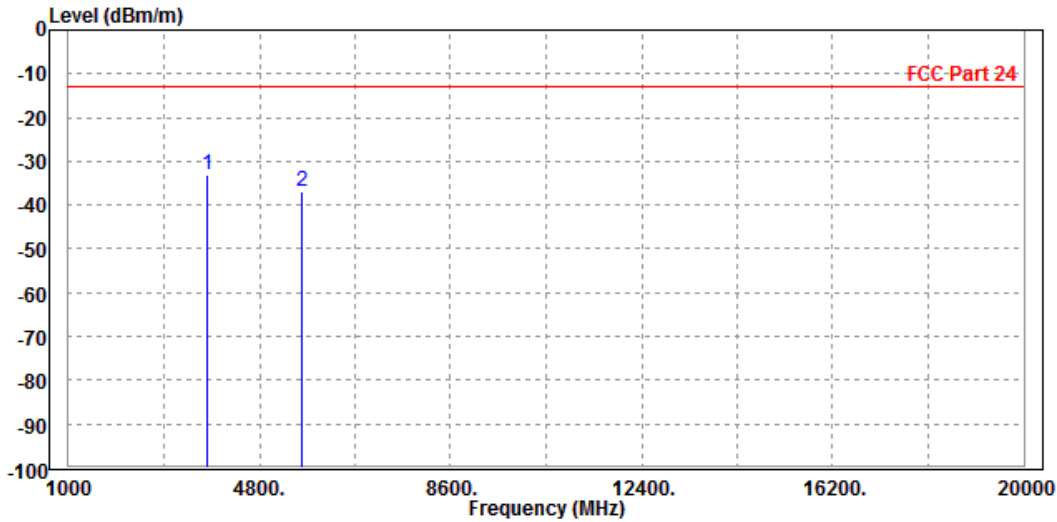



CH 19193

MODE	TX channel 19193	FREQUENCY RANGE	Above 1000MHz
ENVIRONMENTAL CONDITIONS	23deg. C, 70%RH	INPUT POWER	DC 5V from adapter
TESTED BY	Rose Ma		
<b>ANTENNA POLARITY &amp; TEST DISTANCE: HORIZONTAL AT 3 M</b>			

	Freq	Level	Read Level	Limit Line	Over Limit	Factor	Remark	Pol/Phase
	MHz	dBm/m	dBm	dBm/m	dB	dB/m		
1	3812.000	-55.90	-59.56	-13.00	-42.90	3.66	Peak	Horizontal
2	PP 5727.900	-53.80	-63.02	-13.00	-40.80	9.22	Peak	Horizontal

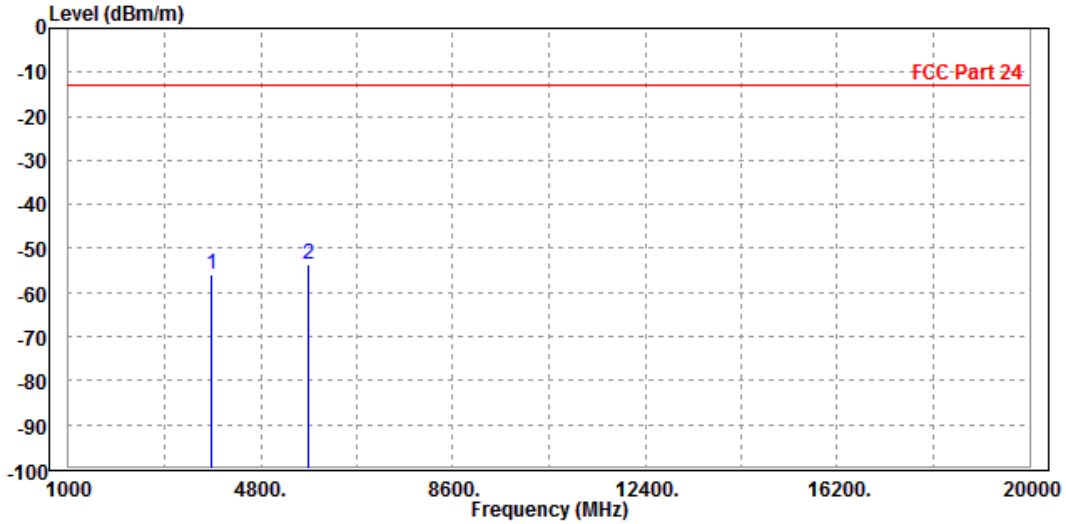



MODE	TX channel 19193	FREQUENCY RANGE	Above 1000MHz
ENVIRONMENTAL CONDITIONS	23deg. C, 70%RH	INPUT POWER	DC 5V from adapter
TESTED BY	Rose Ma		
<b>ANTENNA POLARITY &amp; TEST DISTANCE: VERTICAL AT 3 M</b>			

	Freq	Level	Read Level	Limit Line	Over Limit	Factor	Remark	Pol/Phase
	MHz	dBm/m	dBm	dBm/m	dB	dB/m		
1	3812.000	-52.74	-56.88	-13.00	-39.74	4.14	Peak	Vertical
2 PP	5727.900	-51.87	-60.31	-13.00	-38.87	8.44	Peak	Vertical

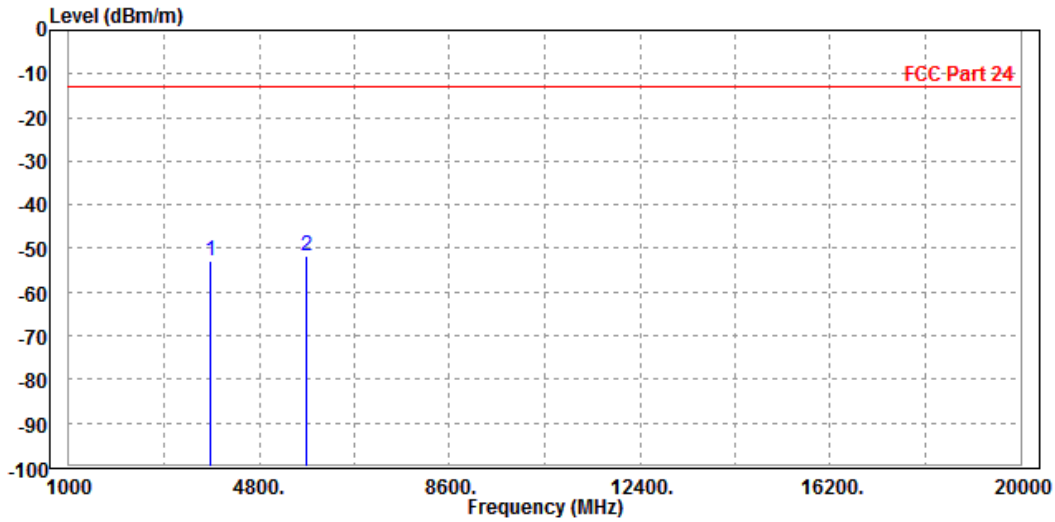



CHANNEL BANDWIDTH: 3MHz / QPSK

MODE	TX channel 18900	FREQUENCY RANGE	Above 1000MHz
ENVIRONMENTAL CONDITIONS	23deg. C, 70%RH	INPUT POWER	DC 5V from adapter
TESTED BY	Rose Ma		
ANTENNA POLARITY & TEST DISTANCE: HORIZONTAL AT 3 M			

	Freq	Level	Read Level	Limit Line	Over Limit	Factor	Remark	Pol/Phase
	MHz	dBm/m	dBm	dBm/m	dB	dB/m		
1	PP 3755.000	-36.11	-39.50	-13.00	-23.11	3.39	Peak	Horizontal
2	5640.000	-45.61	-54.73	-13.00	-32.61	9.12	Peak	Horizontal

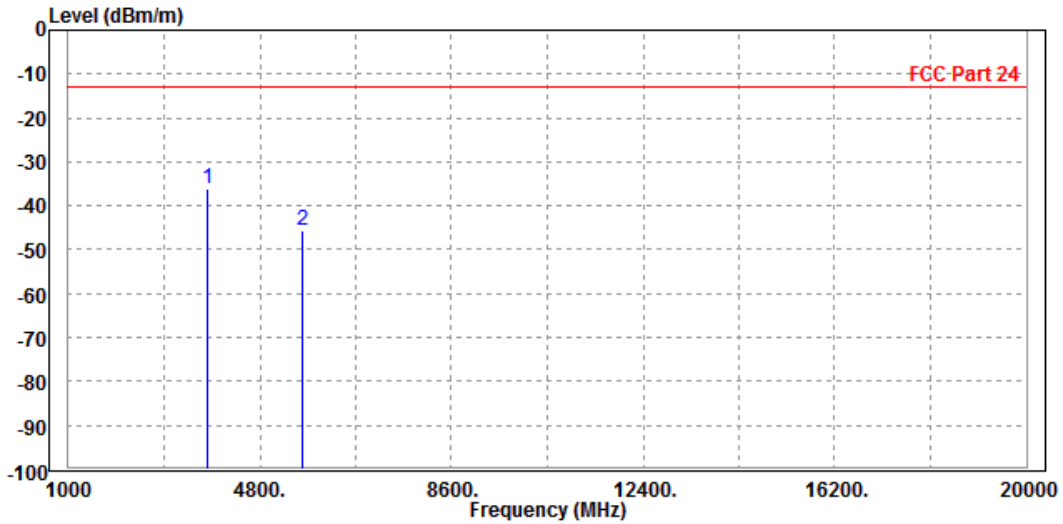



MODE	TX channel 18900	FREQUENCY RANGE	Above 1000MHz
ENVIRONMENTAL CONDITIONS	23deg. C, 70%RH	INPUT POWER	DC 5V from adapter
TESTED BY	Rose Ma		
<b>ANTENNA POLARITY &amp; TEST DISTANCE: VERTICAL AT 3 M</b>			

	Freq	Level	Read Level	Limit Line	Over Limit	Factor	Remark	Pol/Phase
	MHz	dBm/m	dBm	dBm/m	dB	dB/m		
1	PP 3755.000	-35.98	-39.83	-13.00	-22.98	3.85	Peak	Vertical
2	5640.000	-37.63	-45.89	-13.00	-24.63	8.26	Peak	Vertical

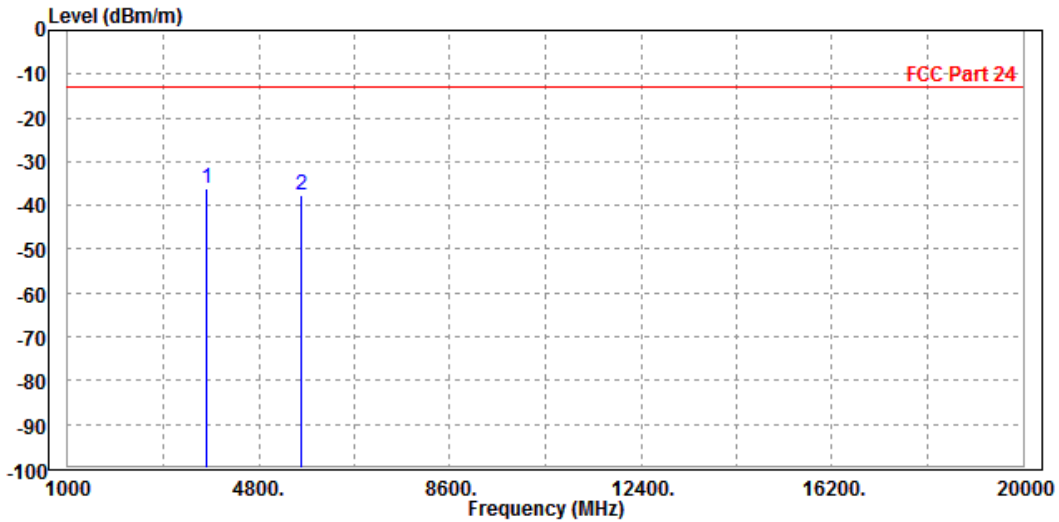



CHANNEL BANDWIDTH: 5MHz / QPSK

MODE	TX channel 18900	FREQUENCY RANGE	Above 1000MHz
ENVIRONMENTAL CONDITIONS	23deg. C, 70%RH	INPUT POWER	DC 5V from adapter
TESTED BY	Rose Ma		
<b>ANTENNA POLARITY &amp; TEST DISTANCE: HORIZONTAL AT 3 M</b>			

	Freq	Level	Read Level	Limit Line	Over Limit	Factor	Remark	Pol/Phase
	MHz	dBm/m	dBm	dBm/m	dB	dB/m		
1	3755.000	-48.64	-52.03	-13.00	-35.64	3.39	Peak	Horizontal
2 PP	5640.000	-47.36	-56.48	-13.00	-34.36	9.12	Peak	Horizontal

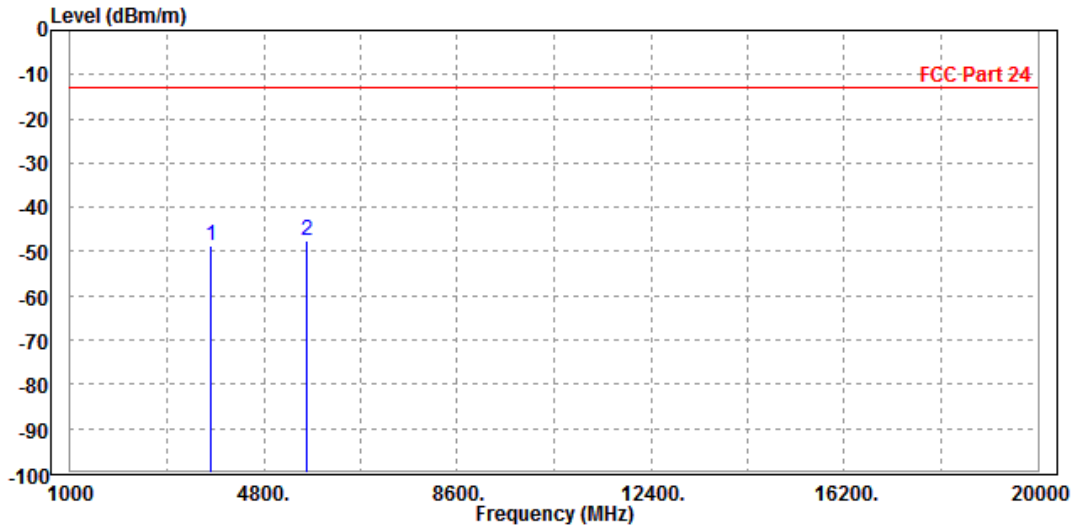



MODE	TX channel 18900	FREQUENCY RANGE	Above 1000MHz
ENVIRONMENTAL CONDITIONS	23deg. C, 70%RH	INPUT POWER	DC 5V from adapter
TESTED BY	Rose Ma		
ANTENNA POLARITY & TEST DISTANCE: VERTICAL AT 3 M			

	Freq	Level	Read Level	Limit Line	Over Limit	Factor	Remark	Pol/Phase
	MHz	dBm/m	dBm	dBm/m	dB	dB/m		
1	3755.000	-47.85	-51.70	-13.00	-34.85	3.85	Peak	Vertical
2 PP	5640.000	-46.94	-55.20	-13.00	-33.94	8.26	Peak	Vertical

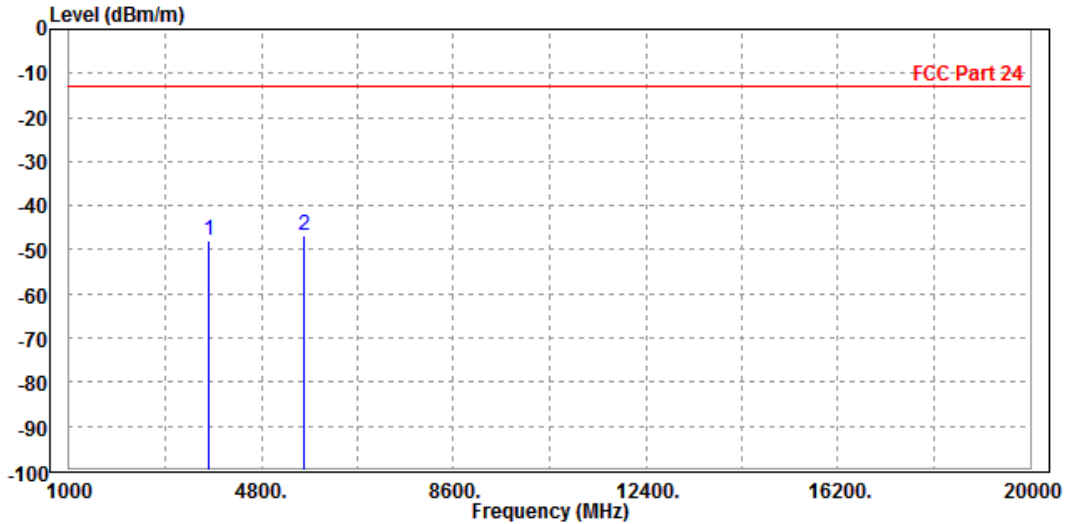



CHANNEL BANDWIDTH: 10MHz / QPSK

MODE	TX channel 18900	FREQUENCY RANGE	Above 1000MHz
ENVIRONMENTAL CONDITIONS	23deg. C, 70%RH	INPUT POWER	DC 5V from adapter
TESTED BY	Rose Ma		
ANTENNA POLARITY & TEST DISTANCE: HORIZONTAL AT 3 M			

	Freq	Level	Read Level	Limit Line	Over Limit	Factor	Remark	Pol/Phase
	MHz	dBm/m	dBm	dBm/m	dB	dB/m		
1	PP 3755.000	-44.89	-48.28	-13.00	-31.89	3.39	Peak	Horizontal
2	5640.000	-45.97	-55.09	-13.00	-32.97	9.12	Peak	Horizontal

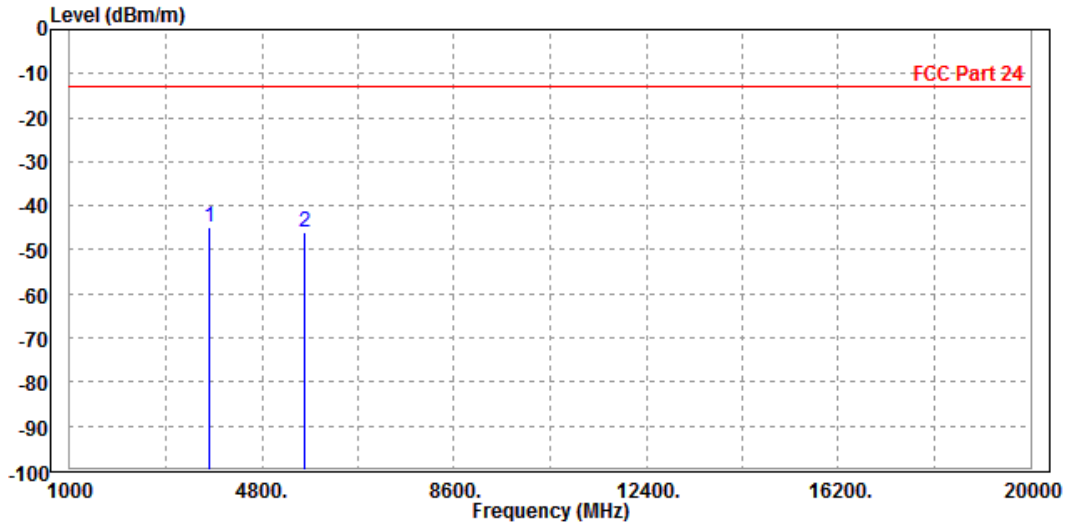





MODE	TX channel 18900	FREQUENCY RANGE	Above 1000MHz
ENVIRONMENTAL CONDITIONS	23deg. C, 70%RH	INPUT POWER	DC 5V from adapter
TESTED BY	Rose Ma		
ANTENNA POLARITY & TEST DISTANCE: VERTICAL AT 3 M			

	Read	Limit	Over			
Freq	Level	Level	Line	Limit	Factor	Remark
MHz	dBm/m	dBm	dBm/m	dB	dB/m	
1 PP 3755.000	-40.29	-44.14	-13.00	-27.29	3.85	Peak Vertical
2 5640.000	-44.64	-52.90	-13.00	-31.64	8.26	Peak Vertical

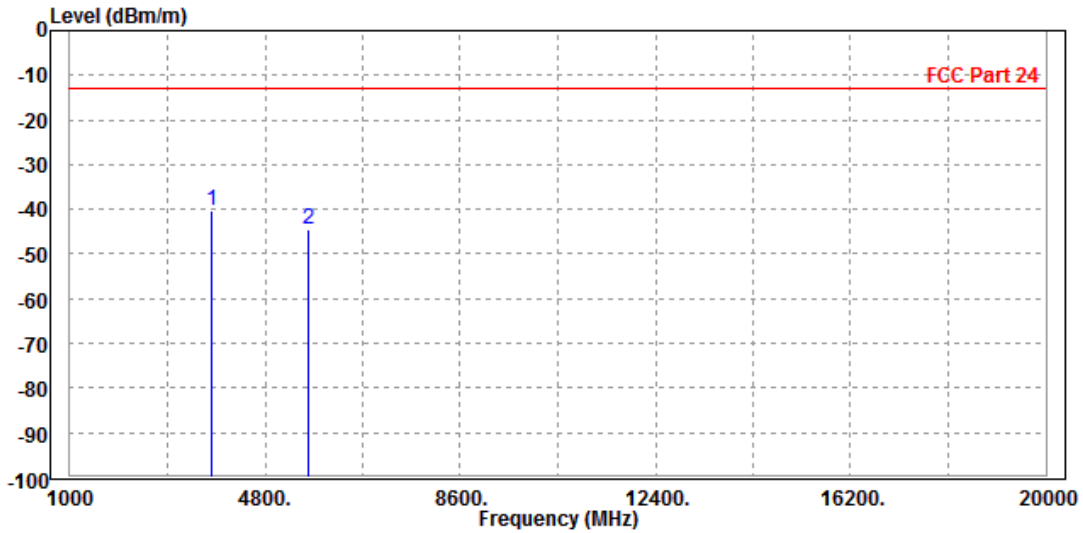



CHANNEL BANDWIDTH: 15MHz / QPSK

MODE	TX channel 18900	FREQUENCY RANGE	Above 1000MHz
ENVIRONMENTAL CONDITIONS	23deg. C, 70%RH	INPUT POWER	DC 5V from adapter
TESTED BY	Rose Ma		
<b>ANTENNA POLARITY &amp; TEST DISTANCE: HORIZONTAL AT 3 M</b>			

	Freq	Level	Read Level	Limit Line	Over Limit	Factor	Remark	Pol/Phase
	MHz	dBm/m	dBm	dBm/m	dB	dB/m		
1	3755.000	-55.94	-59.33	-13.00	-42.94	3.39	Peak	Horizontal
2 PP	5640.000	-50.90	-60.02	-13.00	-37.90	9.12	Peak	Horizontal

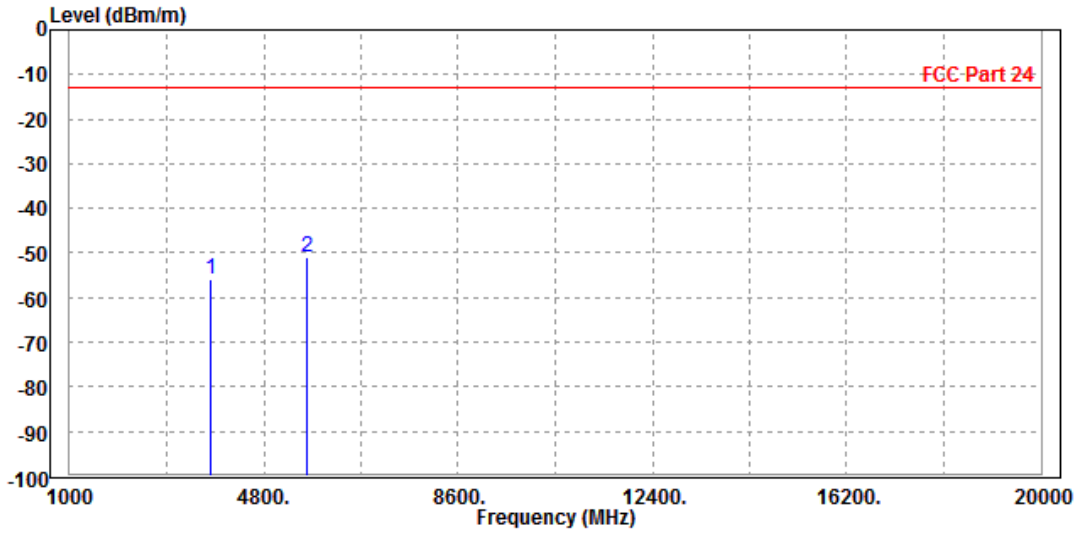



MODE	TX channel 18900	FREQUENCY RANGE	Above 1000MHz
ENVIRONMENTAL CONDITIONS	23deg. C, 70%RH	INPUT POWER	DC 5V from adapter
TESTED BY	Rose Ma		
<b>ANTENNA POLARITY &amp; TEST DISTANCE: VERTICAL AT 3 M</b>			

	Freq	Level	Read Level	Limit Line	Over Limit	Factor	Remark	Pol/Phase
	MHz	dBm/m	dBm	dBm/m	dB	dB/m		
1	3755.000	-53.52	-57.37	-13.00	-40.52	3.85	Peak	Vertical
2 PP	5640.000	-50.16	-58.42	-13.00	-37.16	8.26	Peak	Vertical

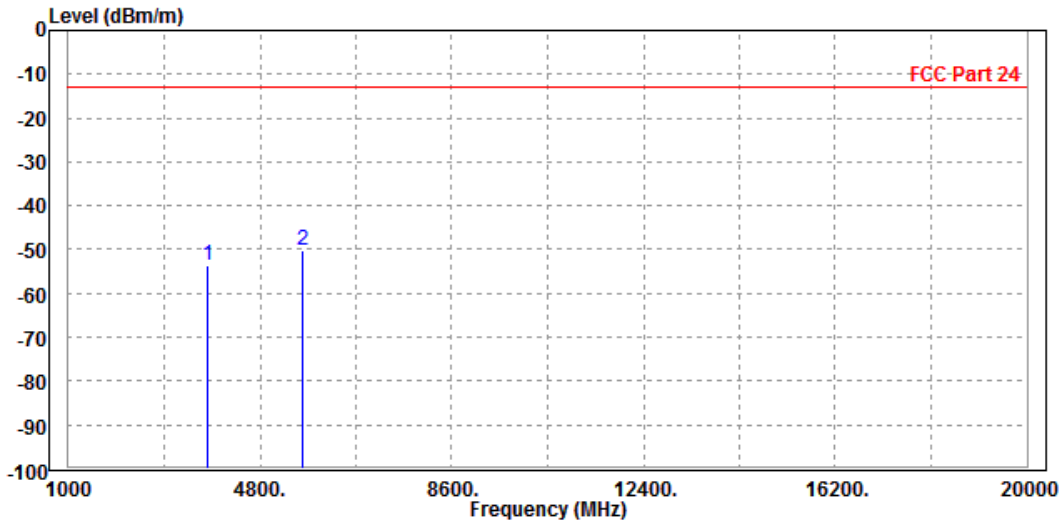



CHANNEL BANDWIDTH: 20MHz / QPSK

MODE	TX channel 18900	FREQUENCY RANGE	Above 1000MHz
ENVIRONMENTAL CONDITIONS	23deg. C, 70%RH	INPUT POWER	DC 5V from adapter
TESTED BY	Rose Ma		
ANTENNA POLARITY & TEST DISTANCE: HORIZONTAL AT 3 M			

	Freq	Level	Read Level	Limit Line	Over Limit	Factor	Remark	Pol/Phase
	MHz	dBm/m	dBm	dBm/m	dB	dB/m		
1	3755.000	-55.26	-58.65	-13.00	-42.26	3.39	Peak	Horizontal
2 PP	5640.000	-52.11	-61.23	-13.00	-39.11	9.12	Peak	Horizontal

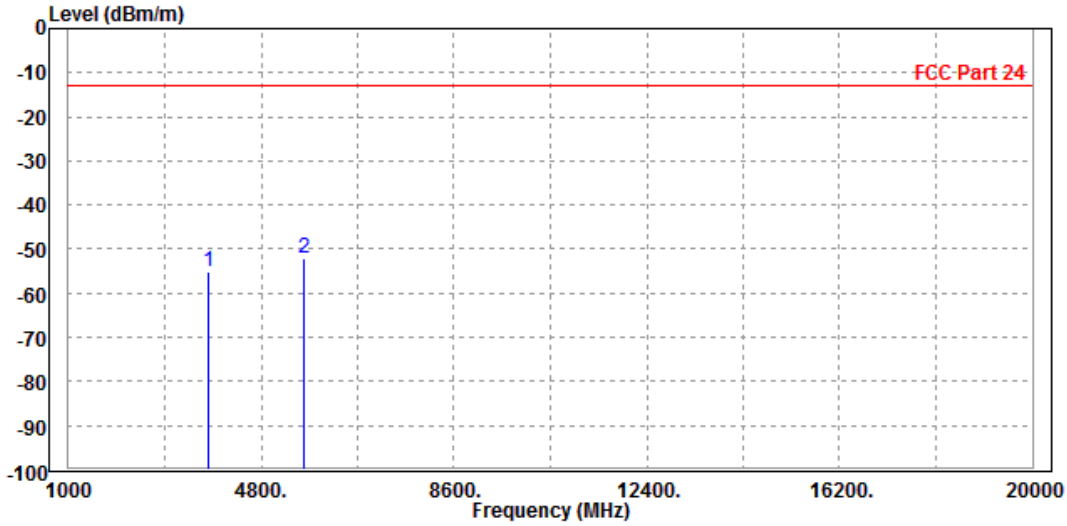



<b>MODE</b>	TX channel 18900	<b>FREQUENCY RANGE</b>	Above 1000MHz
<b>ENVIRONMENTAL CONDITIONS</b>	23deg. C, 70%RH	<b>INPUT POWER</b>	DC 5V from adapter
<b>TESTED BY</b>	Rose Ma		
<b>ANTENNA POLARITY &amp; TEST DISTANCE: VERTICAL AT 3 M</b>			

	Freq	Level	Read Level	Limit Line	Over Limit	Factor	Remark	Pol/Phase
	MHz	dBm/m	dBm	dBm/m	dB	dB/m		
1	3755.000	-54.29	-58.14	-13.00	-41.29	3.85	Peak	Vertical
2 PP	5640.000	-51.65	-59.91	-13.00	-38.65	8.26	Peak	Vertical

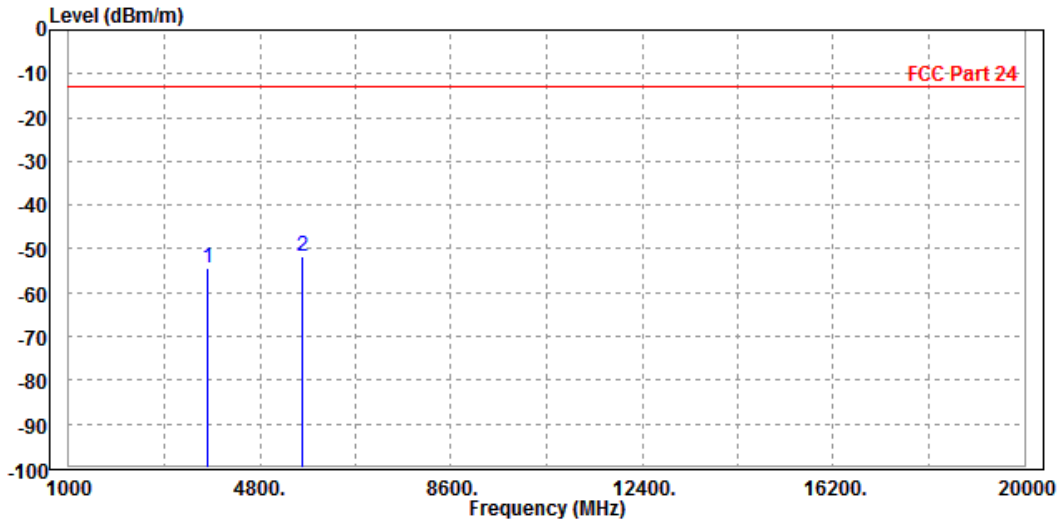



### 3.7 PEAK TO AVERAGE RATIO

#### 3.7.1 LIMITS OF peak to average ratio MEASUREMENT

In measuring transmissions in this band using an average power technique, the peak to-average ratio (PAR) of the transmission may not exceed 13 dB

#### 3.7.2 TEST SETUP

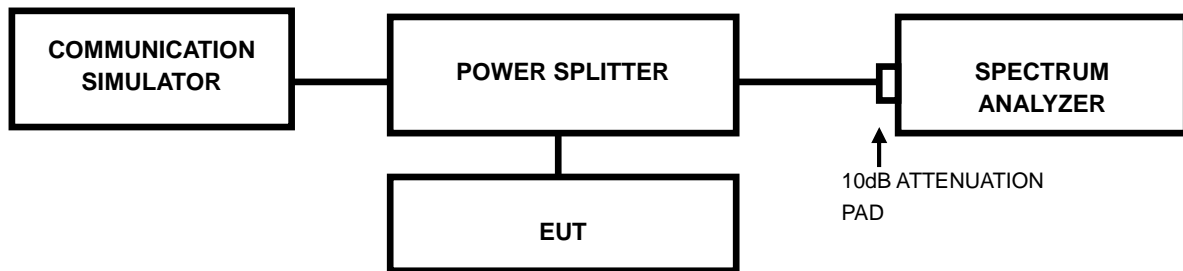

#### 3.7.3 TEST PROCEDURES

1. Set resolution/measurement bandwidth  $\geq$  signal's occupied bandwidth;
2. Set the number of counts to a value that stabilizes the measured CCDF curve;
3. Record the maximum PAPR level associated with a probability of 0.1%.



### 3.7.4 TEST RESULTS

#### WCDMA

CHANNEL	FREQUENCY (MHz)	PEAK TO AVERAGE RATIO (dB)
9262	1852.4	2.68

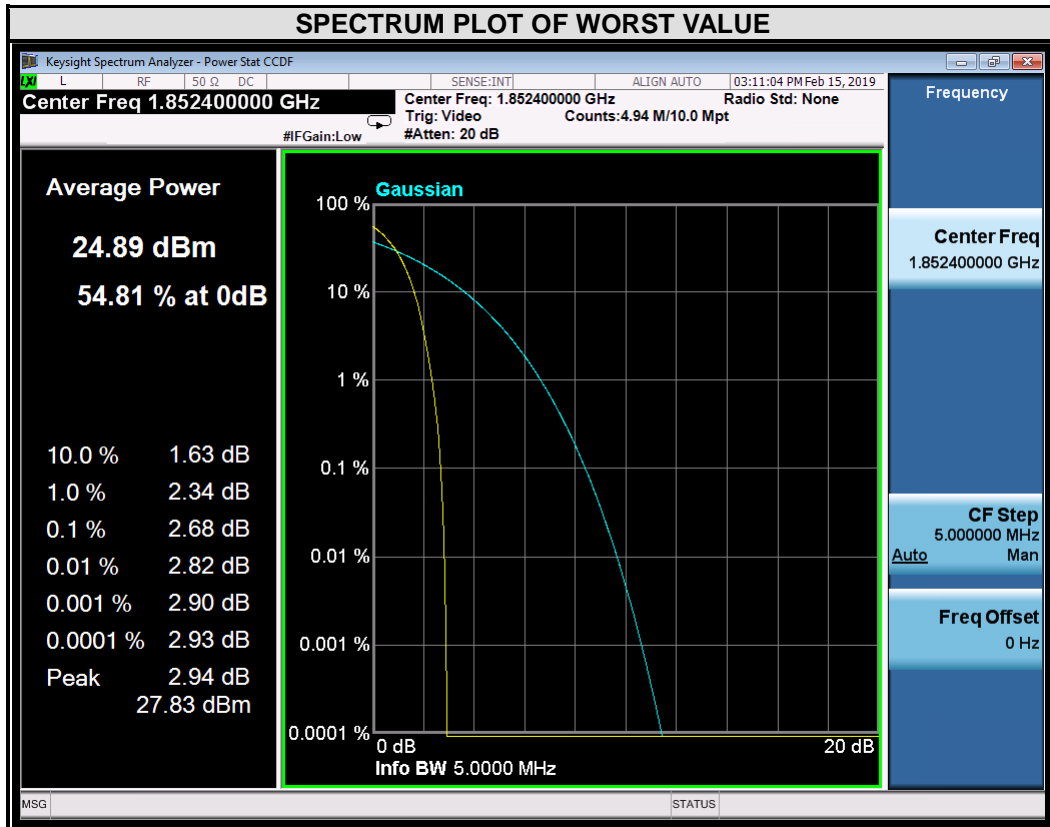



CHANNEL	FREQUENCY (MHz)	PEAK TO AVERAGE RATIO (dB)
9400	1880.0	2.96

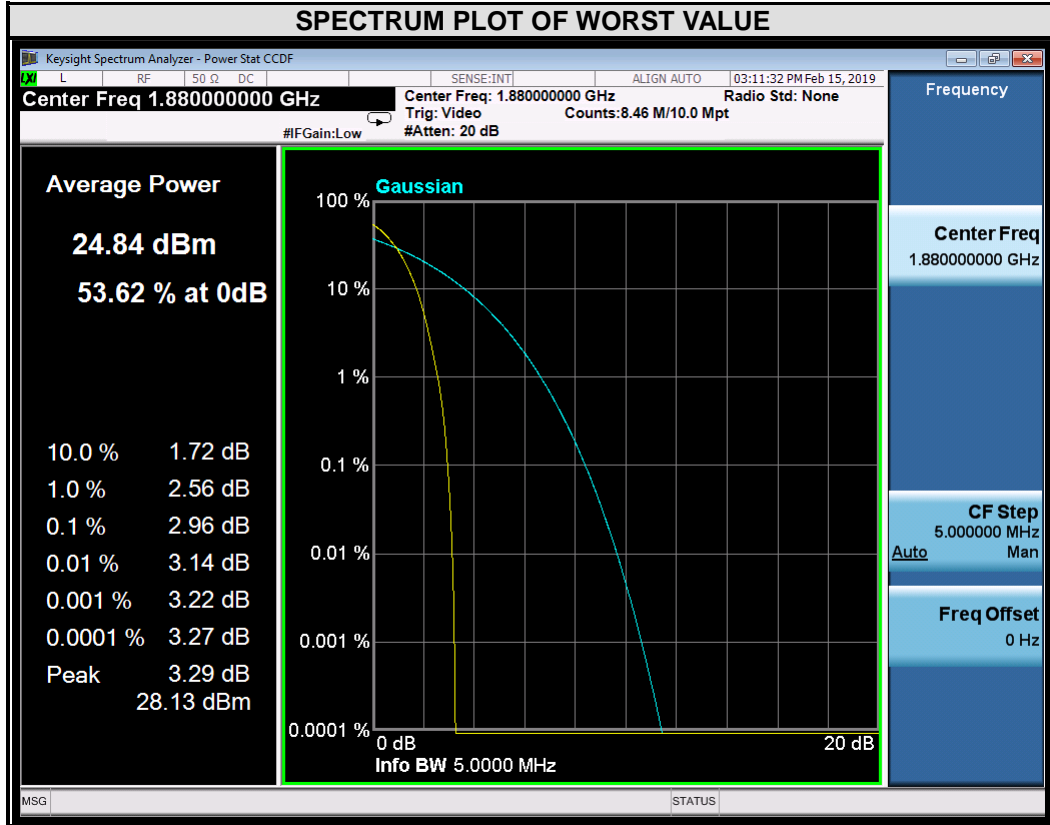





CHANNEL	FREQUENCY (MHz)	PEAK TO AVERAGE RATIO (dB)
9538	1907.6	2.43

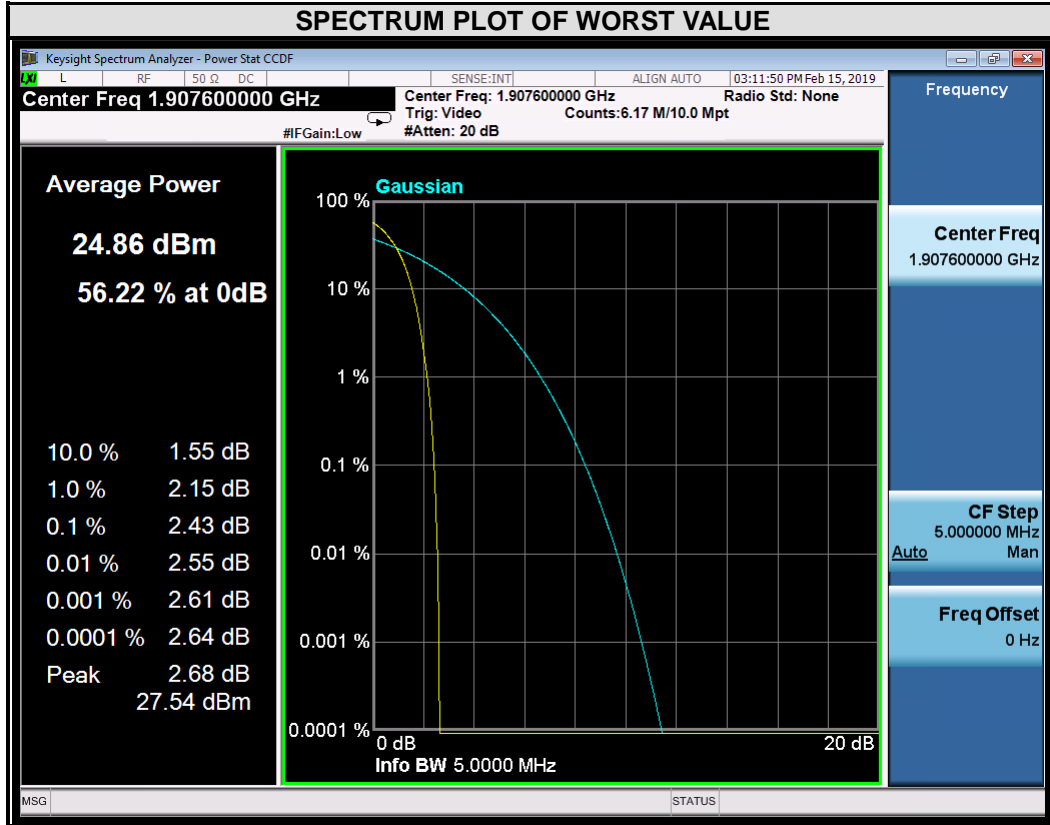



**LTE BAND 2**

CHANNEL BANDWIDTH: 1.4MHz				CHANNEL BANDWIDTH: 3MHz			
CHANNEL	FREQUENCY (MHz)	PEAK TO AVERAGE RATIO (dB)		CHANNEL	FREQUENCY (MHz)	PEAK TO AVERAGE RATIO (dB)	
		QPSK	16QAM			QPSK	16QAM
18607	1850.7	4.10	5.15	18615	1851.5	4.32	5.14
18900	1880	4.49	5.34	18900	1880	4.66	5.47
19193	1909.3	3.71	4.74	19185	1908.5	4.03	4.85

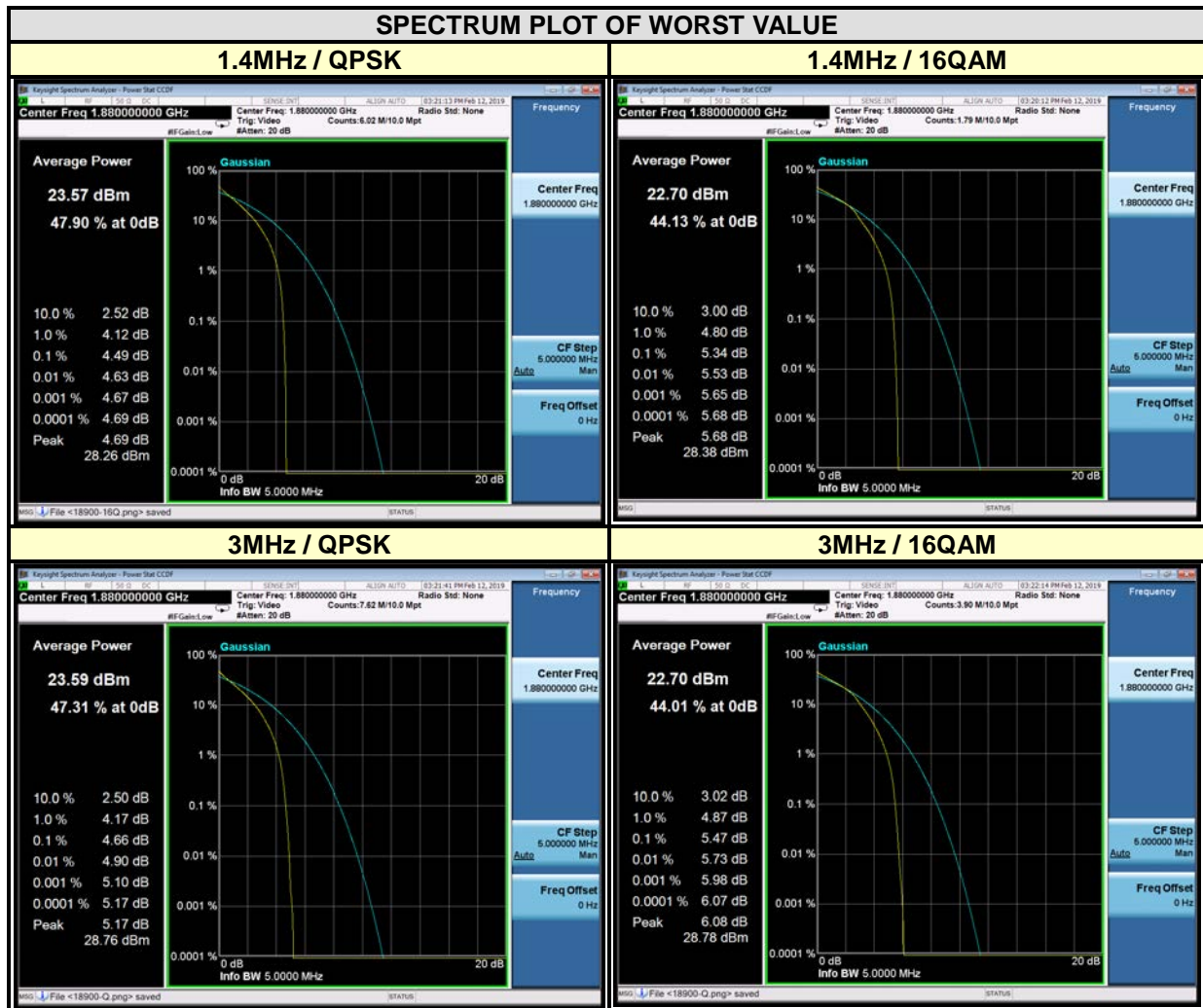



**BUREAU  
VERITAS**

Test Report No.: RF190123W002-3

CHANNEL BANDWIDTH: 5MHz				CHANNEL BANDWIDTH: 10MHz		
CHANNEL	FREQUENCY (MHz)	PEAK TO AVERAGE RATIO (dB)		CHANNEL	FREQUENCY (MHz)	PEAK TO AVERAGE RATIO (dB)
		QPSK	16QAM			QPSK
18625	1852.5	4.56	5.37	18650	1855	4.03
18900	1880	4.82	5.72	18900	1880	4.60
19175	1907.5	4.40	5.27	19150	1905	3.81

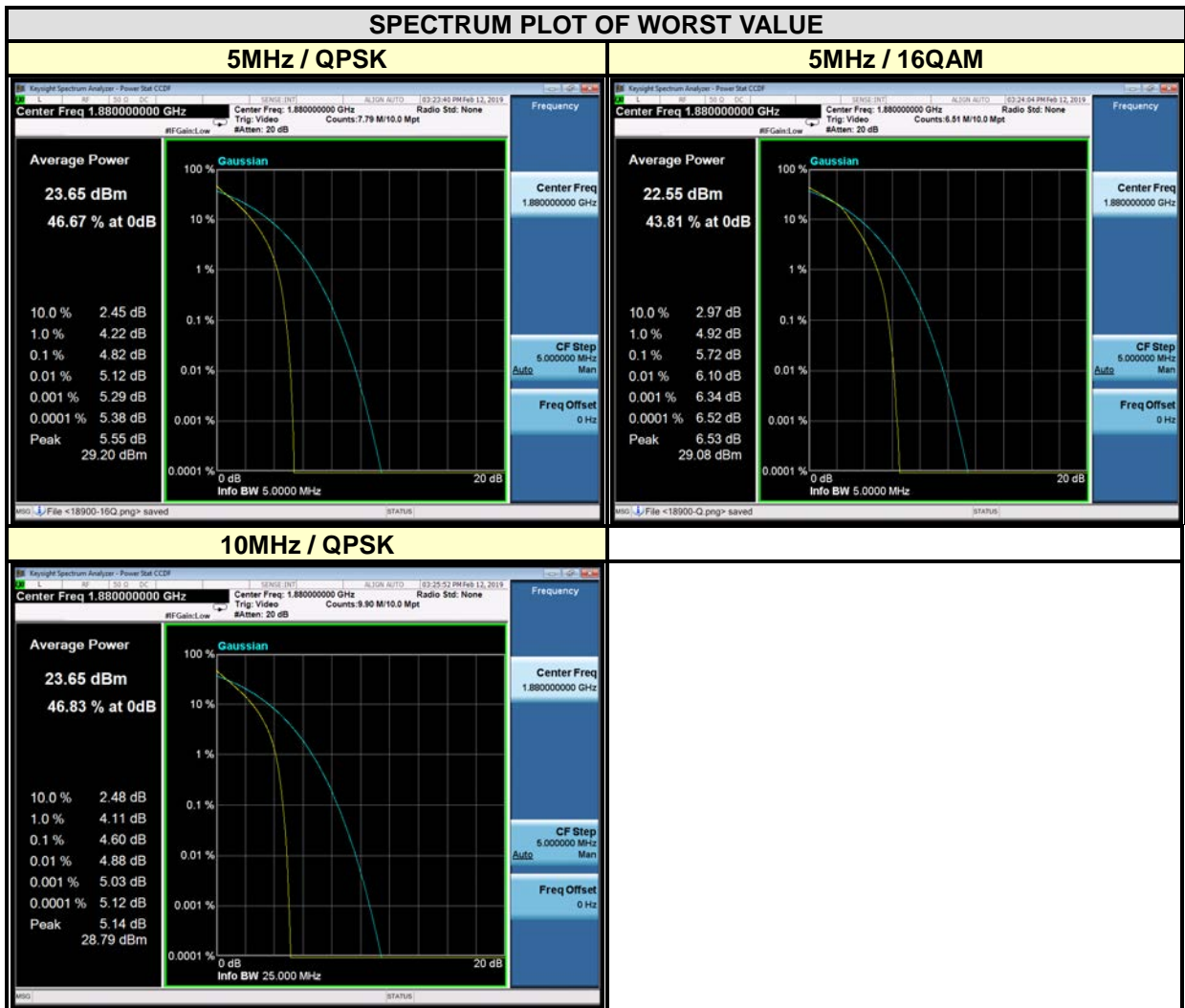



CHANNEL BANDWIDTH: 15MHz			CHANNEL BANDWIDTH: 20MHz		
CHANNEL	FREQUENCY (MHz)	PEAK TO AVERAGE RATIO (dB)	CHANNEL	FREQUENCY (MHz)	PEAK TO AVERAGE RATIO (dB)
		QPSK			QPSK
18675	1857.5	4.32	18700	1860	4.53
18900	1880	4.66	18900	1880	4.73
19125	1902.5	4.01	19100	1900	4.34

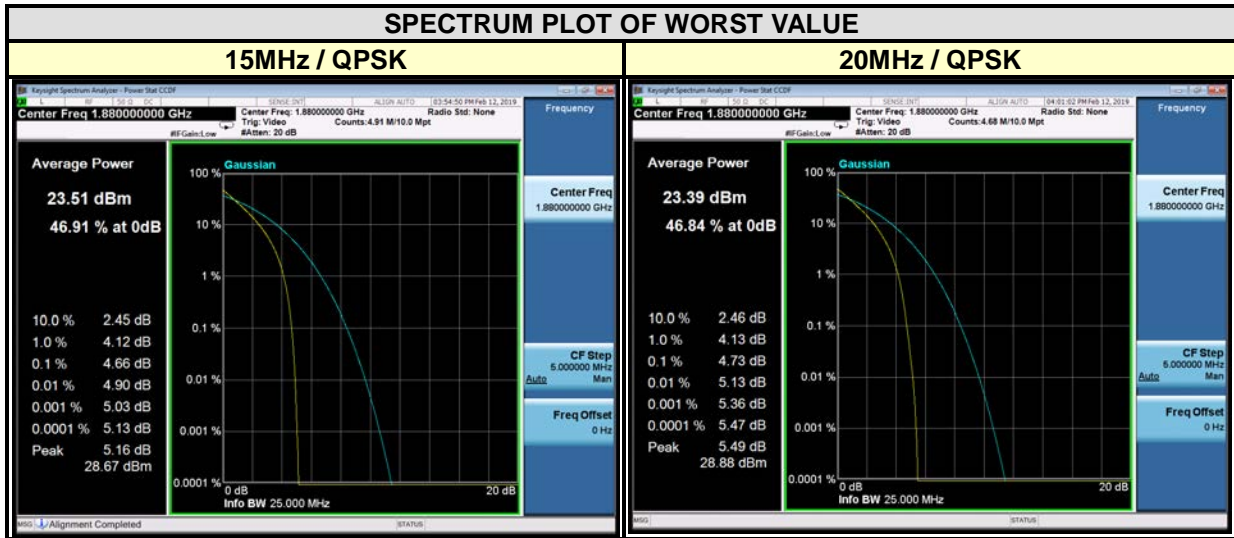



**BUREAU VERITAS** Test Report No.: RF190123W002-3

## 4 INFORMATION ON THE TESTING LABORATORIES

We, BV 7LAYERS COMMUNICATIONS TECHNOLOGY (SHENZHEN) CO. LTD., were founded in 2015 to provide our best service in EMC, Radio, Telecom and Safety consultation. Our laboratories are accredited and approved according to ISO/IEC 17025.

If you have any comments, please feel free to contact us at the following:

**Shenzhen EMC/RF Lab:**

Tel: +86-755-88696566

Fax: +86-755-88696577

**Email:** [customerservice.dg@cn.bureauveritas.com](mailto:customerservice.dg@cn.bureauveritas.com)

**Web Site:** [www.adt.com.tw](http://www.adt.com.tw)

The address and road map of all our labs can be found in our web site also.



**BUREAU** Test Report No.: RF190123W002-3  
**VERITAS**

## 5 APPENDIX A – MODIFICATIONS RECORDERS FOR ENGINEERING CHANGES TO THE EUT BY THE LAB

No any modifications are made to the EUT by the lab during the test.

---END---